

SILVA NEXUS

GPS DGPS



OPERATING MANUAL

ENGLISH

CONTENTS:

1 INTRODUCTION	3-5
2 PART SPECIFICATION	6
3 INSTALLATION	6-9
3.1 INSTALLATION ALTERNATIVES	6-7
3.2 INSTRUMENT MOUNTING	8
3.3 CABLE CONNECTIONS	9
4 FIRST START	10-12
4.1 GPS STATUS and OPERATION	12
5 HOW TO USE THE 4 BUTTONS	13-16
5.1 LEFT BUTTON	13
5.2 LIGHT CONTROL	13
5.3 DOWN (or MINUS) BUTTON	13
5.4 UP (or PLUS) BUTTON	13
5.5 KEY BUTTON	13
5.6 ACCESS TO SETTINGS	14
5.7 CLEAR (or ERASE) a WP or value	14
5.8 MAN OVER BOARD	14
5.9 ESCAPE (or ABORT) from edit mode	14
5.10 "BACK STEP"	14
5.11 GENERAL WAYPOINT SEARCH	14-16
6 NAVIGATION	16-31
6.1 POS	17
6.1.1 POSITION and ALTITUDE	17
6.1.2 DATE and TIME	17
6.1.3 BATTERY VOLTAGE	18
6.1.4 SATELLITE STATUS and SIGNAL to NOISE	18
6.2 WP	18
6.2.1 MARK WP	19
6.2.2 EDIT WP	19-20
6.2.3 COPY WP	20
6.2.4 MOVE WP	21
6.2.5 DELETE	21
6.2.6 ED B/R	21
6.3 NAV	22

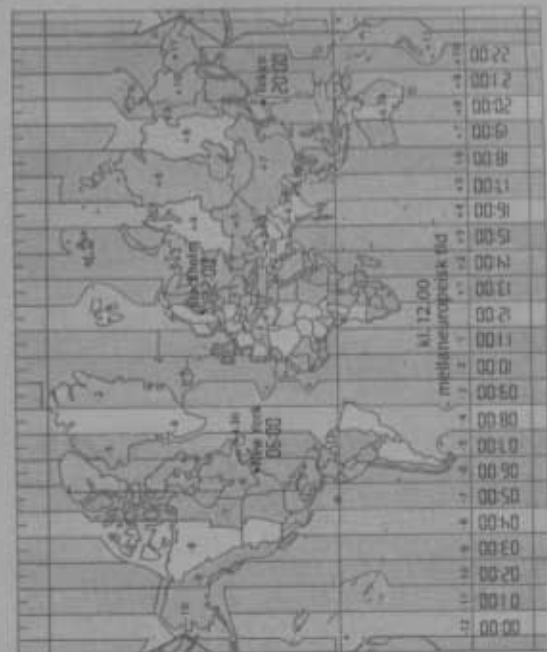

6.3.1 COMBI VIEW and X-TRACK ERROR	22-23
6.3.2 ETA and TTG	23
6.3.3 BOAT SPEED and COMPASS HEADING	23
6.3.4 DRIFT	24
6.3.5 WCV and CTS	24
6.3.6 GOTO WP	24-25
6.4 ROUTE	26
6.4.1 SAIL PLAN	26-29
6.4.2 ROUTE CALL	29
6.4.3 REVERSE CALL	30
6.4.4 DELETE	30
6.4.5 ROUTE STORE	30-31

7 SETTINGS

7.1 UNITS	31-39
7.2 ALARMS	31
7.3 GPS	32
7.4 DGPS	33-34
7.5 NMEA	34
7.6 OPTIONS	34-35
7.7 CONFIGURATION	35-36
7.7.1 CHOICE OF POSITION SOURCE	37
7.7.2 STANDARD NEXUS NAVIGATION SETUP	38
7.7.3 NEXUS "REMOTE REPEATER" SETUP	38
7.7.4 NMEA REPEATER SETUP	38
7.7.5 NMEA NAVIGATOR SETUP	38-39

8 NMEA DATA

39-41

9 SPECIAL NMEA AND NEXUS APPLICATIONS

9.1 TOGETHER WITH NEXUS CHARTPLOTTER	42-45
9.2 SPECIAL USE TO GET EXTRA WP's	43-44
9.3 EXTRA FEATURES WITH SILVA NEXUS NETWORK	44-45

10 FAULT FINDING

46

11 OPTIONS

47

12 TECHNICAL DATA

47

13 MAINTENANCE

48

14 WARRANTY

48

15 ABBREVIATIONS

49

1. INTRODUCTION

THANK YOU FOR CHOOSING THE SILVA NEXUS GPS NAVIGATOR.

The GPS system is operated by the DOD (Department Of Defence) USA and the systems accuracy and maintenance is totally within their responsibility. Remember that a GPS navigator is a "tool" or a navaid to common navigation methods, and should therefore be used as a complement to maps and compass, and not as a replacement.



Please read about the GPS system in the SILVA GPS Antenna manual.

THE NEXUS GPS NAVIGATOR SYSTEM.

The NEXUS GPS NAVIGATOR offers TRUE multiple navigation operation. When operating, ONLY ONE WP database is in use for the whole NEXUS system. Therefore, you may store or delete waypoints, create or call up a route on any NEXUS GPS or Multi Control instruments.

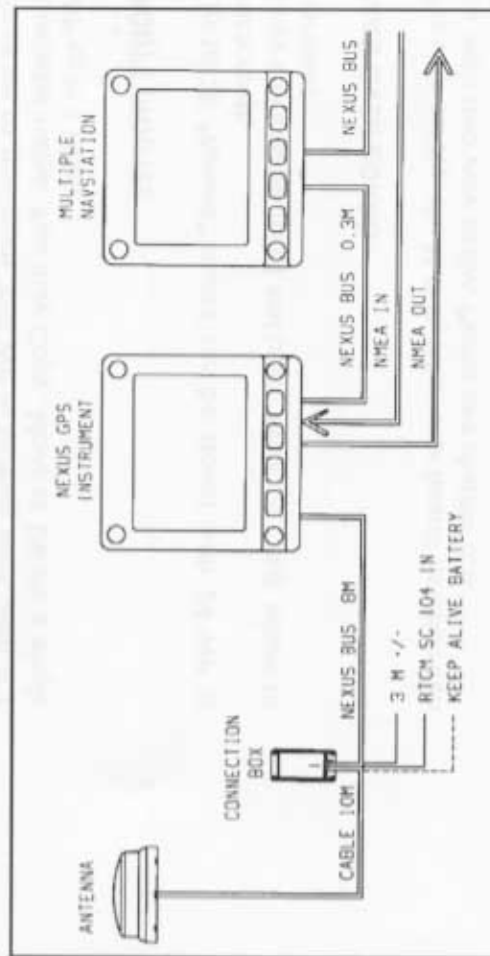

By adding this GPS navigator into the NEXUS series of instruments, you will benefit from the high integration level that makes navigation simple, precise and reliable.

BASIC FEATURES

POSITION (POS)

Position is given in latitude and longitude to 3 decimal places with selectable setup for minutes and seconds or minutes and 1000ths of minute. Altitude in METRES or FEET can also be displayed.

NAVIGATION (NAV)

Course and Speed Over Ground (COG/SOG) in knots, km/h or miles/h.

Select either magnetic or true, for both course over ground and bearing to waypoints. This will be clearly "flagged" with the reversed text MAGNETIC on the LCD to prevent confusion and uncertainty. Distance to WP is selectable in nautical miles, kilometres or miles. Actual X-track error is displayed to 3 decimal places which is perfect for high precision Differential GPS navigation.

WAYPOINT (WP)

Store up to maximum 399 WP in lat/long each with a 7 character name. You may Copy, Move or Delete a single WP or in a block.

ROUTE (ROUTE)

Up to 25 "named" routes can be stored with 24 WP in each route. They can also be called and used "reversed" (e.g. return to harbour).

MAN OVER BOARD

For your safety, the M.O.B. (Man over board) function can be activated very easily. Please see chapter 5.8.

TIME

Month, day and time is displayed (local time can be set). When navigating towards a waypoint, both ETA (estimated time of arrival) and TTG (estimated time in hours and minutes to go) is displayed.

EXTRA NEXUS FEATURES

- For sailracing (with a complete NEXUS System), the built in race timer clock become extra valuable. The exact GPS time is used to "trigger" the NEXUS instruments start timer up to 18h and down to the last second (hh:mm:ss) before the actual start.
- Display compass and water speed (from NEXUS Network) with selectable dampening. The GPS navigator will then calculate the boats drift (direction and speed).
- With the PC-interface and software, you may transmit/receive waypoints; log selected data to a file; monitor NEXUS information in real time, using a PC.

FUTURE FEATURES

The navigator is ready for use with a future remote control. It is also prepared for future POP-UP menus, such as "black box" DGPS beacon receivers.

GOOD LUCK AND HAPPY SAILING !

2. PART SPECIFICATION

All necessary fittings and mounting for most installations are enclosed. Check each part prior to installation.

NEXUS GPS NAVIGATOR instrument

- 1 # Operating manual
- 1 # Warranty card
- 1 # Quick guide
- 1 # GPS instrument
- 4 # Mounting screws for instrument
- 1 # Template for instrument
- 1 # Instrument cover
- 4 # Rubber screw caps
- 1 # Connection cover
- 2 # 4-pole, jack plug
- 1 # Data cable 8 m
- 1 # Data cable 0,3 m
- 2 # Power cables, red and black, 3 m
- 5 # Cable protectors (0,25 mm)
- 5 # Cable protectors (0,75 mm)
- 2 # Cable straps

GPS Antenna part specification: See *SILVA GPS Antenna manual*.

3. INSTALLATION

3.1 INSTALLATION ALTERNATIVES

A. COMPLETE STANDALONE OR INTEGRATED NEXUS GPS NAVIGATOR INSTALLATION

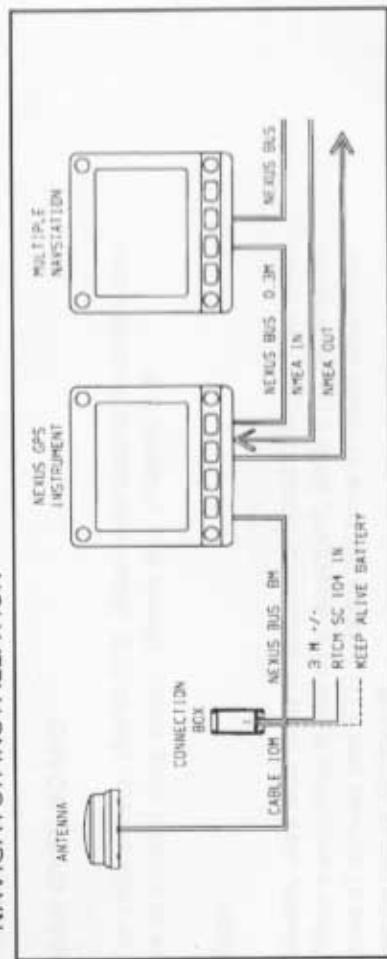

B. TOGETHER WITH SILVA HANDHELD GPS COMPASS AS A GPS ANTENNA

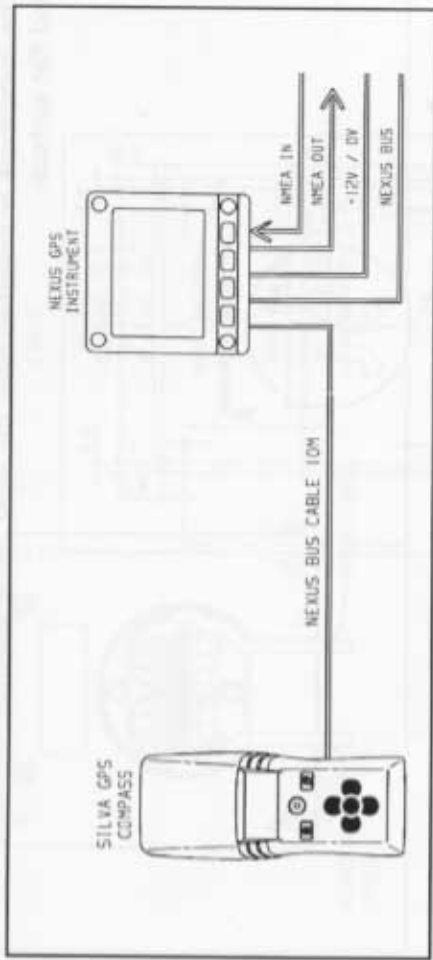

C. AS REPEATER OR NAVSTATION, WITH ANY NMEA NAVIGATION SYSTEM OR GPS ANTENNA

D. AS A REPEATER OR NAVSTATION WITHIN THE NEXUS NETWORK

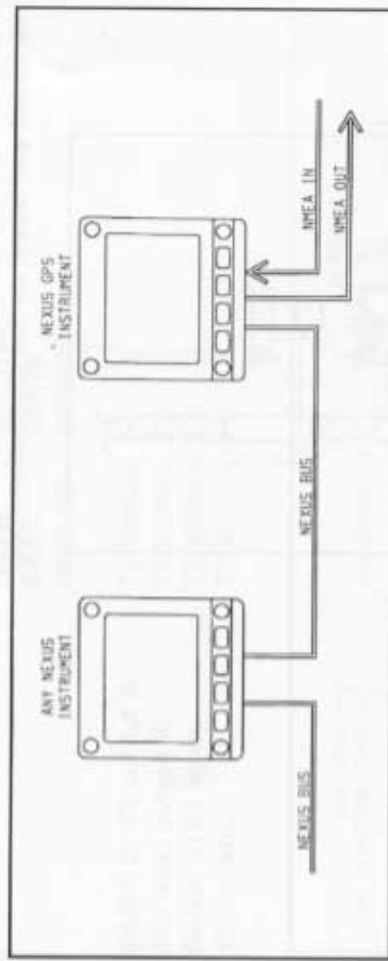

3.2 INSTRUMENT MOUNTING

The instrument is mounted from the front, on a smooth and flat surface.

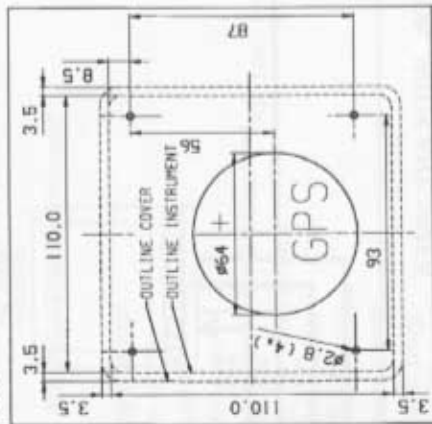

1. Use the template and attach it to the desired location. Drill the holes as indicated.
2. Put silicon grease on each contact! Connect to the instrument and screw on the connection cover.

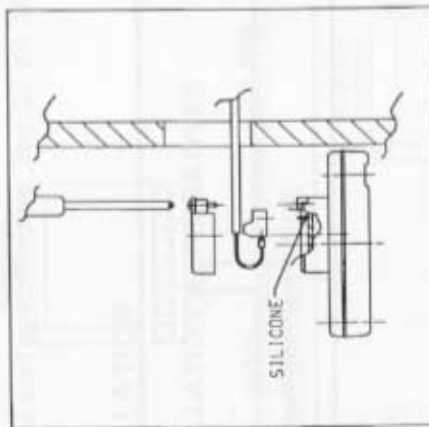

Use the 4 instrument screws supplied, to mount the instrument on the bulkhead. Cover the screws with the rubber screw caps. Use the cable ties for strapping up the cables.

GPS Antenna mounting: See manual for the antenna.

3.3 CABLE CONNECTIONS

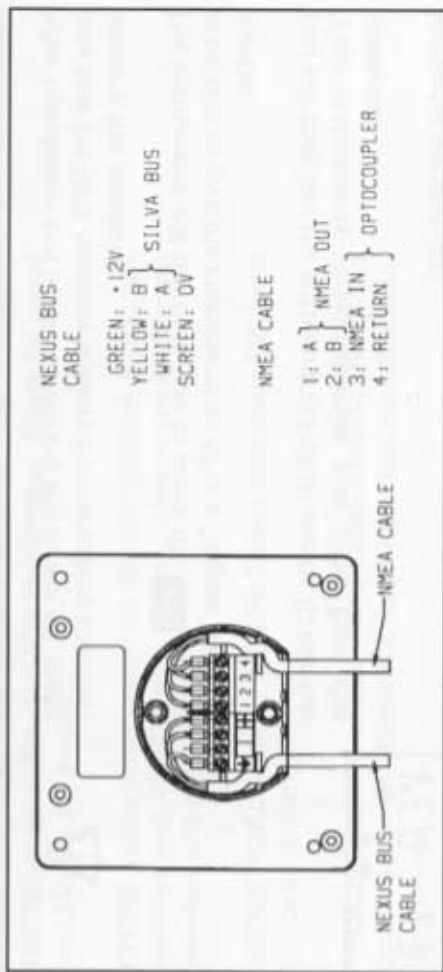

The 3 m red and black power cables connect to the boats 12 V supply, **ALWAYS USE WITH 3A FUSE.**

Cable wiring on the instruments backside.

NEXUS databus and power. +12v GREEN (RS 485)
 DATA YELLOW
 DATA WHITE
 GROUND SCREEN

NMEA 0183 output A. TERMINAL 1
 (RS 422) output B. TERMINAL 2
 NMEA 0183 input. TERMINAL 3
 (Opto)return TERMINAL 4

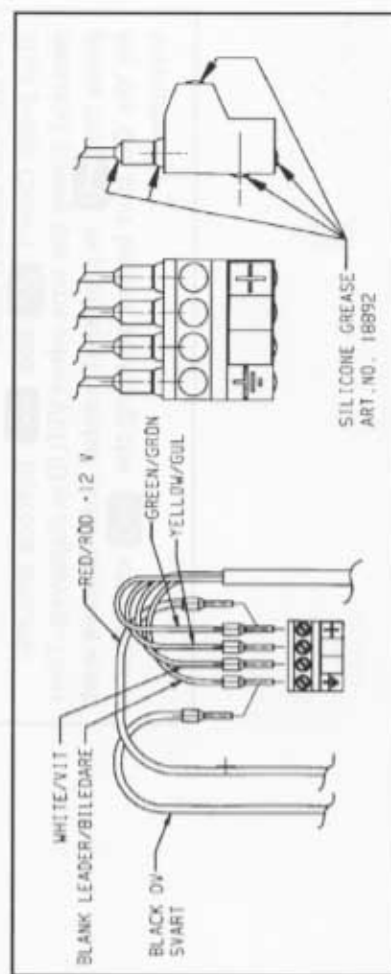

4. FIRST START

After installation and before switching the power on, make sure that the GPS Antenna is away from anything that may obscure the satellites.

The instrument will then ask you to press the **↔0** button to be able to give the instrument an ID or a "logical" NEXUS number.

You will then see the software VERSION and its ID number (Your instruments version number may differ from this example).

Navigator version (2s)

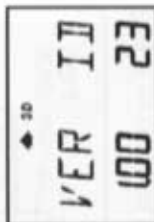

↔ 30
VER ID
100 23

GPS Antenna version (2s), only displayed when connected to SILVA's GPS receivers.

(GPS COM when the GPS COMPASS is used.)



↔ 30
GPS--COM
20

**** Only when a remote controller is used ****

If the instruments are accessed in random order, you may reset the ID numbers for all NEXUS instruments and then start again by pressing **↔0** in preferred number (remote access) order.

Just press Clear (**Δ+**) and **↔V** buttons simultaneously) during the time when VER ID is displayed. Then press the **↔0** in preferred number order (always wait for the OK text before pressing the **↔0** on the next instrument).

DEFAULT SETTINGS FROM FACTORY

UNITS are set to Nautical Mile for distance, Knots for speed and Metres for altitude.

CHART presentation is set to present position in degrees minutes and 1/1000 of a minute. Alternative is degrees minutes and seconds.

GEODETICAL datum is WGS84. Select from over 100 local geodetic datums.

TRUE bearing and course over ground. **MAGNETIC** course can be set as an alternative. Local magnetic variation must then be set.

CONFIGURATION is set for this instrument and the SILVA GPS Antenna. For repeaters or other combinations, please see settings in chapter 7.7.

4.1 GPS STATUS and OPERATION

The ACQUISITION flag will be lit during satellite search before navigation can start. When the GPS is tracking satellites, the status symbols 2D or 3D will be displayed at the top of the LCD, as online information. If a DGPS receiver is connected and working correctly, the symbol text DGPS will also be displayed.

When 3 satellites have been found and tracked, the 2D symbol is displayed; 3D when more than 3 satellites are tracked.

AQU = Acquisition of data from satellites.

2D = 2 dimensional position (with locked altitude) for marine navigation.

3D = 3 dimensional position for all land navigation.

DGPS = differential GPS is active.

The initial GPS receiver start is called a **COLD START** and will be performed if the GPS has been moved a large distance, or if used for the first time. It will take about 10 minutes and is indicated with a flashing ACQUISITION flag.

Warmstart takes from 35 seconds up to 2 minutes depending on the age of the ephemeris almanac and your position (within 4 hours).

By presetting time and position you will get the "first" FIX position within a few minutes. This is done by first entering local TIME ZONE, YEAR, DATE, TIME and INITIAL POSITION (within 100 km), please see chapter 7.3.

ACQUISITION

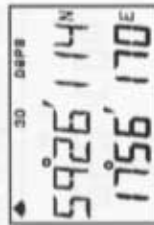
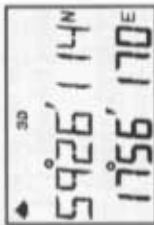
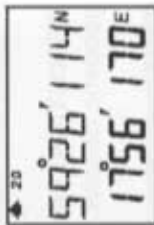

5. HOW TO USE THE 4 BUTTONS

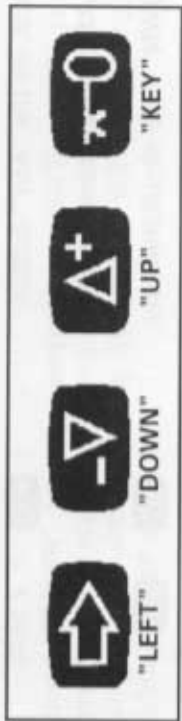

5.1 LEFT BUTTON

Is used for selecting main function. Each press on this key will change to a new main function (from left to right). The selected main function will be indicated with the LCD arrow.

When editing any value, this key will also move cursor key to edit numbers or text characters with the same functions as above.

5.2 LIGHT CONTROL

Is accessed with a long press (>2 secs) on the "LEFT" button. Three light levels, LOW, MID, MAX plus light OFF can be selected.

5.3 DOWN (or MINUS) BUTTON

Is used to "pull down" next function from the selected main menu. When in edit mode, this button is used to decrease a digit value or a text character.

5.4 UP (or PLUS) BUTTON

Is used to "pull up" previous function from the selected main menu. When in edit mode, this key is as the DOWN button.

5.5 KEY BUTTON

This is the ENTER KEY that will "unlock" a value, text or function to be set or altered, then "lock" when ready.

It is also used as a TOGGLE "KEY" when a secondary function is available, e.g. to toggle between the Combi function and X-track error.

5.6 ACCESS TO SETTINGS

Press minimum 2 secs. on the "KEY" button.



> 2 secs

5.7 CLEAR (or ERASE) a WP or value.

Press "UP" and "DOWN" keys simultaneously.



5.8 MAN OVER BOARD

To engage Man Over Board, press the two outer keys.

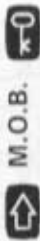

M.O.B.

5.9 ESCAPE (or ABORT) from edit mode.

Press the Cursor key ("LEFT") for minimum 2 seconds.

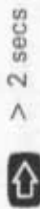

> 2 secs

5.10 "BACK STEP"

Press the "LEFT" and "DOWN" simultaneously to "back step" to previous function or for moving the cursor to the left.



5.11 GENERAL WAYPOINT SEARCH

The SEARCH METHOD is the same for all searches. You will use it when searching for "NAMED" waypoints to edit, when activating a WP to navigate towards, or calling up a "NAMED" route. The same method is also used when selecting a "NAMED" geodetic datum.

1. Search for a waypoint number by scrolling "UP" or "DOWN" (increase or decrease the waypoint numbers). As an example, function EDIT WP is chosen.

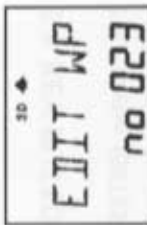

To find e.g. WP "BUOY", select EDIT WP and press "KEY" (No:023 shows the next free waypoint)

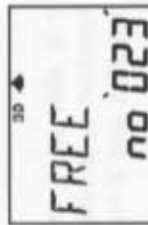

The display shows FREE no:023. Digits flashing, press "DOWN" to scroll backwards to find the waypoints that you have stored earlier under WP function.

The display shows ex. "BUOY" no:022. This is the last stored waypoint.

Scroll "DOWN" for other waypoints to EDIT or "UP" to create a new waypoint from a FREE number. Press "KEY" and proceed with the editing. See chapter 6.2.2. regarding editing of WP's.

2. Search in "ALPHABETICAL" order by scrolling "UP" or "DOWN".

This example is demonstrating alphabetical scrolling in the GOTO WP function.

Select GOTO WP and press "KEY"



The display shows ex. "NAME" no:023 as last edited waypoint (digits flashing).

Press the "LEFT" (cursor) button once and the "NAME" starts to flash. Use "UP" or "DOWN" button to scroll through all waypoints in "ALPHABETICAL" order.

3. Single character search, starting with the left hand character.

Press the "LEFT" (cursor) button once more and the first "character" in the "NAME" will flash.

By pressing the "UP" button you will display the next character in alphabetic order and the FIRST waypoint that is found in the memory with that character is shown.

By pressing the "DOWN" button, you will display the previous character in alphabetical order and the LAST waypoint that is found in the memory with that character is shown.

4. Finding a WP by entering the WP number.

If we use the same example as before, there are two ways of moving the cursor to the three digit position (no:nnn).

- A. Repeated press on the "LEFT" button until the left hand (first) digit is flashing.
- B. Press both "LEFT" and "DOWN" buttons to back-step the cursor.

When the desired digit is flashing, enter the number with the "UP" or "DOWN" button and then move the cursor to the next digit. Press "KEY" lock.



6. NAVIGATION FUNCTIONS

The definition of navigation is to know where you are, where to go, and how to get there.

You may simply utilise POSITION data to navigate or fully utilise the waypoint features, after the following steps.

Prepare for **WAYPOINT NAVIGATION**.

1. **LOCATE** on your chart, the LAT and LON position of your waypoint's.
2. **STORE** the WP's in the WP bank.
3. **SELECT** one of the WP's stored in the GOTO WP function. Prepare for **SAIL PLAN NAVIGATION**.
4. **ADD ON** additional WP's in the SAIL PLAN queue. The first WP in that queue is already selected in the GOTO WP function (point 3 above).
5. **SAVE** the complete SAIL PLAN as a ROUTE for later use.

A SAIL PLAN is a list of pointers (up to 24) to your programmed waypoints in the navigator memory. The navigator will then navigate towards the waypoints, in a sequence, one by one. You may also store the complete SAIL PLAN as a ROUTE (up to 25 routes).

When a ROUTE is called up, it will be added to the SAIL PLAN.

6.1 POS

Access levels and summary of the POS functions.

- "FIRST SHOWN" POSITION and ALTITUDE, ch. 6.1.1.
- "Press DOWN" DATE and TIME (local or UTC), ch.6.1.2.
- "Press DOWN" BATTERY VOLTAGE (inside the instrument), ch. 6.1.3.
- "Press DOWN" SATELLITE STATUS and SIGNAL to NOISE, ch. 6.1.4.

Tip 1, Use the "UP" button to get access to the last function.

6.1.1 POSITION and ALTITUDE

Latitude (top) and longitude (bottom) in selected geodetical datum.

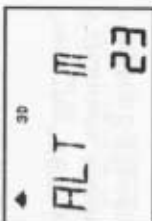
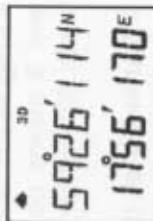

Press "KEY" to display the **ALTITUDE** above sea level.

6.1.2 DATE and TIME

Press "KEY" to set Local time zone. Add or subtract one or more hours to UTC (GMT) (GPS) time to make local time. Find out your time zone with help of the time zone map on page 2.

Note! The unit will not accept 1/2 hour time differences.

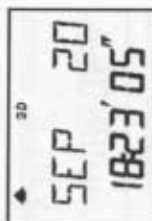

Plus indication, " + " will flash, use "UP" to change to minus sign, " - ". Use plus indication when situated east of Greenwich and minus sign, west of Greenwich.

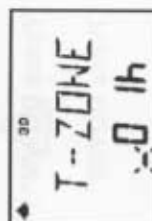

Move cursor with "LEFT" button to set hour difference. Increase/decrease flashing value by pressing "UP" or "DOWN".

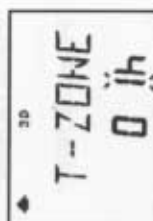

Lock the required value by pressing "KEY".

6.1.3 BATTERY VOLTAGE

The battery voltage is measured inside the instrument and will differ from the NEXUS Multi Control instrument, where the battery voltage is measured in the Server.



6.1.4 SATELLITE STATUS and SIGNAL to NOISE.

HDOP (Horizontal Dilution Of Precision) has normally a low value. If higher than or equal to 10, the 2D or 3D will start to flash as a warning of bad satellite geometry.

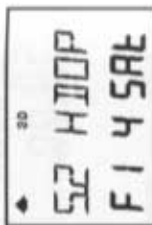

F1 (figure of merit) shows the position quality, 1 is the best and 9 means no navigation. The "F" is changed to "d" when differential RTCM 104 corrections are used.

4 SAT indicates the number of satellites used - min 3 and max 5. The GPS will internally track up to 9 satellites.

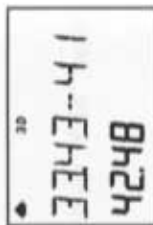

Press the "KEY" to display **S/N** (Signal To Noise, dB) for all 5 channels. Minimum 35 dB per channel. Channel 1,2 and 3 on top followed by channel 4 and 5 below.

6.2 WP

Access levels and summary of the WP functions

"FIRST SHOWN" MARK WP (Marks a waypoint from present position), chapter 6.2.1.

"Press DOWN" EDIT WP (EDIT a WP in Lat/Lon), chapter 6.2.2.

"Press DOWN" COPY WP (Copy one or a block of WP's to another memory part), chapter 6.2.3.

"Press DOWN" MOVE WP (As with COPY but clears the "from" memory when done), chapter 6.2.4.

"Press DOWN" DELETE (DELETES one or a block of WP's), chapter 6.2.5.

"Press DOWN" ED B/R (EDIT a WP in Bearing and range), chapter 6.2.6.

Note! All waypoints are stored and identified with an unique number and with any 7 alphanumeric "NAME".



6.2.1 MARK WP

Use MARK WP when passing a position to store for later use. The position will be stored directly when the "KEY" is pressed.

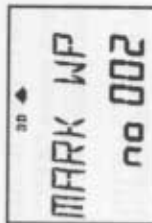

The first free waypoint is shown in the example as no 002.

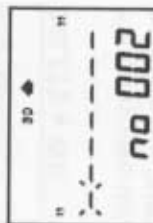

Press "KEY" and you are invited to optionally give the waypoint a name. Enter the character with "UP" or "DOWN" buttons and move to the next character with the "LEFT" button (cursor). Press "KEY" when ready.

Next free WP to MARK will now be ready.

6.2.2 EDIT WP

EDIT WP (In latitude/longitude)

Use EDIT WP when creating a new WP or when editing an old WP.

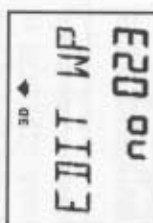

Press "KEY" and the text FREE is displayed with the WP number flashing. Accept this free WP by pressing the "KEY".

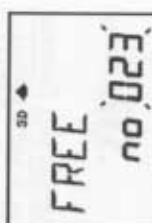

Note! When editing an "old" WP you may search for it by scrolling through the numbers with "UP" or "DOWN" button. You may also use the GENERAL WAYPOINT SEARCH, see ch. 5.11.

Give your WP a name (optional) and follow the same routine as described in chapter 6.2.1, then press "KEY".



Now, the position is shown in latitude and longitude. Enter the correct latitude with "UP"/"DOWN" and "LEFT" (cursor) and press "KEY". Enter correct longitude in the same way and press "KEY".

Note! Make sure you set the correct hemisphere for lat (N/S) and long (E/W).

DELETE a WP.

You may also delete a WP and make it a FREE position by pressing the "UP" and "DOWN" buttons simultaneously

WARNING !!

If you have created a ROUTE and then later change or delete a WP that is within that ROUTE, the ROUTE will be affected.

Our recommendation is to decide early how to organize the waypoints. You may use the first 100 WP for "temporary" waypoints and the rest as more "permanent" WP's for use in ROUTES. Always check that the GPS datum and the chart datum match.

6.2.3 COPY WP

Copy one or a block of WP's to another position without erasing the original block of waypoints.

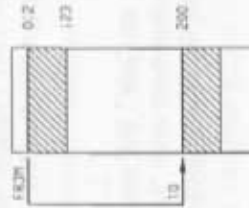

Press "KEY"

Press "KEY" (first digit flashing).

Select the FIRST WP (12) in the "block" and press "KEY".
Select the LAST WP (200) in the "block" and press "KEY".

Select the TO WP number for the WP block 012-123. Set this WP for example "address" to 200 and press "KEY".

DONE !
20

6.2.4 MOVE WP

MOVE WP

Is the same as COPY with the difference that it will first copy the selected WP's to the new block position before the original waypoints will be erased.

6.2.5 DELETE

Deletes a single or a block of WP's by use of the same procedure as in COPY and MOVE.

Warning ! There is no way back if DELETE is fully executed. But if you accidentally press the "KEY", you may ESCAPE without DELETING with a long press on the "LEFT" button.

6.2.6 ED B/R

ED B/R (EDIT a WP in Bearing and range from present position).

Note! BEARING and RANGE is ALWAYS in TRUE NORTH from PRESENT POSITION.

Press "KEY" and FREE is displayed, accept or select another free WP number and press "KEY".
Enter the WP's "NAME" (as described in chapter 6.2.1) and press "KEY".

"WP NAME" (example shows distance 12.24 NM and bearing 205 from 12.34 205 present position)

30
5926' 14"
1756' 170E



30
COPY WP

30
FROM WP
.001

30
FROM WP
012-123

30
TO WP
.001

30
MOVE WP

30
DELETE



30
ED B/R
no 004



30
NAME
no 004

30
NAME
1234 205

6.3 NAV

Access levels and summary of the NAV functions.

- "FIRST SHOWN" COMBI VIEW and X-TRACK ERROR, chapter 6.3.1.
- "Press DOWN" ETA and TTG (Arrival time or time to go to WP), chapter 6.3.2.
- "Press DOWN" BOAT SPEED and COMPASS HEADING, chapter 6.3.3.
- "Press DOWN" DRIFT (Tidal and boat drift), chapter 6.3.4.
- "Press DOWN" WCV (VMG to WP) and CTS (Course To Steer including Drift), chapter 6.3.5.
- "Press DOWN" GOTO WP (The fastest WP selection when going towards one WP), chapter 6.3.6.

6.3.1 COMBI VIEW and X-TRACK ERROR

The most used function in NAV is the COMBI VIEW where you will see;

SPEED and COURSE OVER GROUND, DISTANCE and BEARING TO WAYPOINT (When a WP is active)

Press the "KEY" button to display the **X-TRACK error** together with distance and bearing to the actual WP (Press "KEY" to toggle between XTE and NAV). XTE is displayed in selected unit (Km, miles or Nautical Miles).

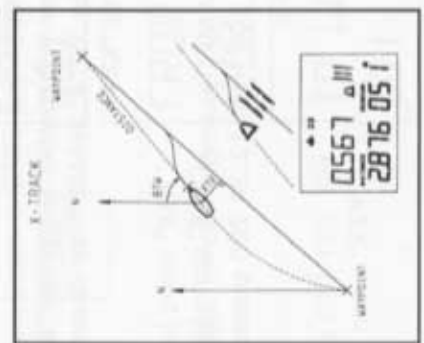
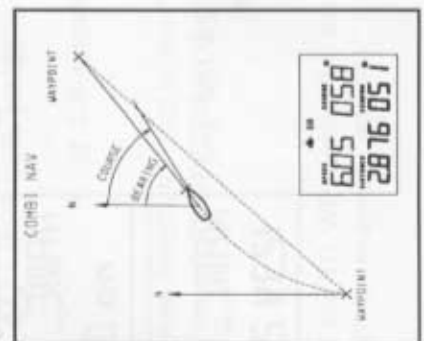

The X-track error is the distance of 90° from your track. The symbol  indicates that the error is to the left, or right, of your track.

Note! To make COG (Course Over Ground) stable, use higher damping at low speeds and lower damping at high speeds. Try to keep damping as low as possible. How to set damping, see chapter 7.4.

6.3.2 ETA and TTG

Estimated Time of Arrival

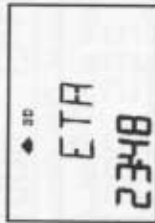

Note! ETA is calculated on the assumption that both speed and direction will be constant during travel towards the waypoint.

Press "KEY"

TTG or Time To Go in hours and minutes to the WP with the same criteria as ETA.

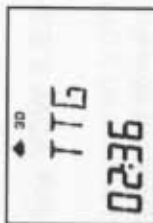

6.3.3 BOAT SPEED and COMPASS HEADING

Boat speed (water speed) and compass heading is taken from the NEXUS Network.

Press "KEY" to change the damping.

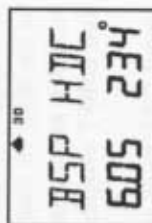

Note! The damping setup is local (this instrument only) and will affect the LCD readout and NMEA output.

d1 = 0,5s d2 = 1s d3 = 2s
 d4 = 5s d5 = 10s d6 = 20s
 d7 = 40s d8 = 1 min 20s d9 = 2 min 40s

6.3.4 DRIFT

When both Compass heading and log data are available, the boats drift including tide (speed and direction) can be calculated. In the example, the boat is drifting on a bearing 234° with the speed 0,8 knots.

Press "KEY" to set the damping of SET/DRIFT and CTS (please see below).

Note! This dampening setting will affect all instruments and is not local, as with boat speed and compass.

The damping will correspond to the following:

d0 = 5s d1 = 10s d2 = 20s
d3 = 40s d4 = 1 min 20s d5 = 2 min 40s
d6 = 5 min d7 = 10 min d8 = 20 min
d9 = 40 min.

6.3.5 WCV and CTS

WCV (Waypoint Closing Velocity) is the speed made good towards the waypoint. CTS (Course To Steer) is the course (selectable TRUE or MAGNETIC) that the boat must keep to be able to reach that waypoint in a straight line. CTS includes compensation for the boats drift.
See DRIFT chapter 6.3.4.

Note! CTS does not include the calculation for changes in tidal direction.

6.3.6 GOTO WP

The GOTO WP function is the fastest way of selecting a WP to go to and it is normally accessed by pressing the "UP" button once when in the Combi Nav function.

Press the "KEY" to select your WP to GOTO, in this example, "BOUY NE" was the last edited WP.

DRIFT
08 234



WCV CTS
505 234



GOTO WP

BOUY_NE
no 134

Last edited WP is displayed. Digits "flashing", (you may select another WP).

Press the "KEY" to accept this WP and the navigation will start.

WP 000 is defined as the "present position" and is used as the FROM waypoint and WP 134 "BOUY NE" is the TARGET waypoint.

Press the "DOWN" button to return to the Combi Nav display where you find both Distance and Bearing to "BOUY NE".

How to use GOTO WP in combination with the SAIL PLAN

The GOTO WP function is actually a direct jump to the SAIL PLAN's first LEG (the "active" WP), then replacing that WP with a new "GOTO WP" waypoint.

Example; You have set up a SAIL PLAN with 12 WP's and on the first LEG you are navigating towards is WP134 "BOUY NE", then by some reason you decide to go to WP104 "BOUY NW" instead.

To make this easy, start from the Combi Nav display and press "UP" to the GOTO WP function, press the "KEY" and select WP104 "BOUY NW", then press "KEY" again (navigation starts).

Press "DOWN" to return to the Combi Nav display where you will see your new Distance and Bearing to "BOUY NW".

Note! The "old" FROM WP will be replaced with "present position" to begin a new X-track error calculation. When the Arrival alarm criteria appears, next WP in the SAIL PLAN is activated as normal.

GOTO WP
000-134

305 235
1234 239



6.4 ROUTE

Access levels and summary of the ROUTE functions

- "FIRST SHOWN" SAIL PLAN (Create, or edit the sail plan), chapter 6.4.1.
- "Press DOWN" ROUTE CALL (Call a route for use), chapter 6.4.2.
- "Press DOWN" REVERSE CALL (Call a route for use in the opposite direction), chapter 6.4.3.
- "Press DOWN" DELETE (Delete a route), chapter 6.4.4.
- "Press DOWN" ROUTE STORE (Store the complete sail plan as a route), chapter 6.4.5.

6.4.1 SAIL PLAN

The SAIL PLAN is the "tool" where you can create, delete or insert one or more WP's to form a number of LEG's. The complete SAIL PLAN can then be stored and named in function ROUTE STORE. Up to 24 WP's can be used in each sail plan (Each ROUTE can then consist of maximum 24 WP's).

How to make the first LEG:

Press "KEY" in SAIL PLAN

WP 000 is defined as present "START" position. NXT (Next) indicates that the next WP is ready to be selected to form the first LEG.

Note! You may choose any other waypoint as the "START" WP.

Press the "DOWN" button.

To select another FROM WP, press the "KEY" and select your start WP. The primary effect is that the X-track error will be calculated by use of the new FROM WP and the TARGET WP, see drawing.

Normally, WP 000 (current position/present position) is accepted as the "START" WP.

30
SAIL
PLAN

30
000--NXT
LEG 01



30
FROM WP
no 000

Example:

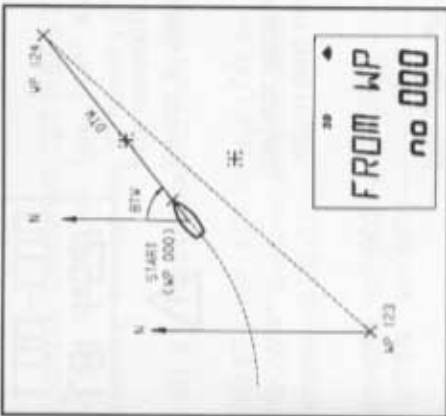

30
FROM WP
no 000

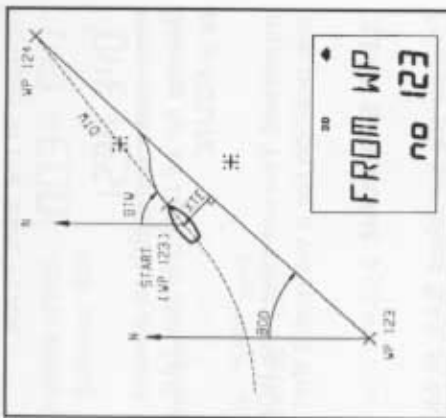

30
FROM WP
no 123

Press the "UP" button (LEG 01) and press "KEY".

The last edited WP is displayed flashing. Use the GENERAL WAYPOINT SEARCH, chapter 5.11 for finding the first WP to go to and press "KEY".

As an Example we choose "BOUY SW" and then press "KEY".

Note! Before distance and bearing to the target WP is displayed, the LEG number is shown.

The distance to "BOUY SW" is 32.34 NM and the bearing is 234° in this first LEG.

Press the "UP" button for NEXT LEG;

WP 103 will be the FROM WP for the NEXT LEG (LEG 2).

Press "KEY", get next WP and press "KEY".

30
"BOUY_SW"
no 134

30
"BOUY_SW"
no 103

30
000--103
32.34 234

30
103--NXT
LEG 02

30
FISH_HW
no 007

Repeat until a maximum of 24 WP's (LEG's) have been included in the SAIL PLAN.

Also, make it a habit to always VERIFY the Distance and Bearing for all LEG's in the SAIL PLAN, especially if stored as a ROUTE.

Important! You will affect the ROUTE if you change the lat/long position for a waypoint that is used within that route.

CLEAR SAIL PLAN.

To clear the complete SAIL PLAN, press CLEAR, "UP" and "DOWN" buttons simultaneously when the text SAIL PLAN is displayed. The display will then show CLEAR PLAN for a short moment.

INSERT A LEG INTO THE SAIL PLAN.

EXAMPLE. Insert a new leg (WP 127) between the present WP 103 and WP 107. This will move WP 107 one LEG "down" in the SAIL PLAN queue list. Use the "UP" and "DOWN" buttons for scrolling through the different LEG's in the SAIL PLAN.

LEG 02 is first displayed, then distance and bearing:

BEFORE, WP 103 ---LEG 2 ---WP 107

INSERT of a new LEG by pressing both "UP" and "KEY" buttons simultaneously at the preferred "LEG INSERT" location.

The text INSERT appears followed by the normal "search" window where you select WP 127.

AFTER THE INSERT, WP 103 ---LEG 2 ---WP 127
---LEG 3 ---WP 107

30
003--007
1254 187



30
103--107
1253 187

30
INSERT

DELETE A LEG.

Example; Delete WP 127 in LEG 2 without any other effect in the SAIL PLAN. Use "UP" and "DOWN" buttons for scrolling through the different LEG's.

LEG 2 is first displayed, then distance and bearing;

DELETE WP 127 in this LEG by pressing both "UP" and "DOWN" buttons simultaneously at the preferred "LEG" location (LEG 02).

BEFORE, WP 003 ---LEG 2 ---WP 127 ---WP 024
AFTER, WP 003 ---LEG 2 ---WP 024

6.4.2 ROUTE CALL

At least one ROUTE must have been stored to be able to use this function.

This function will ADD a selected ROUTE to the SAIL PLAN in the same way as it was created. It is therefore possible to ADD ON (or "link") a new ROUTE into the SAIL PLAN as long as the number of WP's are less than 25.

Tip! It is practical to ADD ON a new ROUTE when only 2 or 3 WP's are remaining in the SAIL PLAN, thus creating a long "seamless" ROUTE.

WARNING !!

If you have created a ROUTE and then later change or delete a WP within that ROUTE, it will be affected.

Press "KEY"

"012 flashing", select your ROUTE and press "KEY".

The ROUTE is now ADDED to the SAIL PLAN and you will see the LEG number briefly, then Distance and Bearing between "FROM" and "TO" will be displayed.

Note! If you are ADDING the ROUTE to another ROUTE, you will get into the SAIL PLAN's actual LEG number for this ROUTE's first WP.

30
003--127
1234 340

30
ROUTE
CALL



30
"BIGTURN"
no 012



6.4.3 REVERSE CALL

At least one ROUTE must have been stored to be able to use this function.

The selected ROUTE will be copied to the SAIL PLAN in reverse order. It is ADDED to the SAIL PLAN as in the ROUTE CALL.

Press "KEY", "012 flashing"

Select your ROUTE and press "KEY" (it will now be your REVERSE ROUTE).

See also ROUTE CALL regarding ADDING ROUTE's.

6.4.4 DELETE

Delete a selected ROUTE in memory.

Press "KEY"

Select the ROUTE which shall be deleted and press "KEY"

Warning! There is no way back if DELETE is executed.

6.4.5 ROUTE STORE

Store the SAIL PLAN as a ROUTE (in chapter 6.4.1).

Press "KEY", "001 flashing"

30
REVERSE
CALL

30
BIGTURN
no 012

30
DELETE

30
BIGTURN
no 012

30
ROUTE
Store

30
FREE
no 001

The first free ROUTE is no 001, press "KEY" and give the route a name by using the "UP DOWN and LEFT" buttons.

30
"ICELAND"
no 001

30
12 WPTS
Store

Press "KEY" and the number of stored WP's are displayed.

7. SETTINGS

Enter the SETTINGS by pressing the "KEY" button minimum 2 secs.

There are seven groups of SETTINGS.

UNITS, ALARMS, GPS, DGPS, NMEA, OPTIONS, CONFIG and RETURN

Press the "KEY" in any of the main SETTINGS to enter the submenu.

Then select from the submenu and press "KEY."

Press "LEFT" to return to a "higher" level.

7.1 UNITS

DST NM Select NM, KM or MILES.

SPD KTS Select KTS, KMH or MPH.

ALT M Select M or FT.

SECONDS OFF Select ON when using charts with degrees, minutes and seconds
(OFF = minutes and 1/1000 of a minute).

KTS (knots) = M, nautical miles (= 1,852 metres).

KHM (km/h) = Km, kilometres (= 1000 metres).

MPH (miles/h) = Miles (= 1,609 metres).

RETURN Return from UNIT setup

EX.

30
JUST NM
Unit

7.2 ALARMS

Arrival circle alarm, within the set radius.
Ex. shows circle with 0.20 Nautical miles radius.

Note! The Circle Alarm **MUST** be in Nautical Mile. 

Arrival line **ON/OFF**. (see drawing).

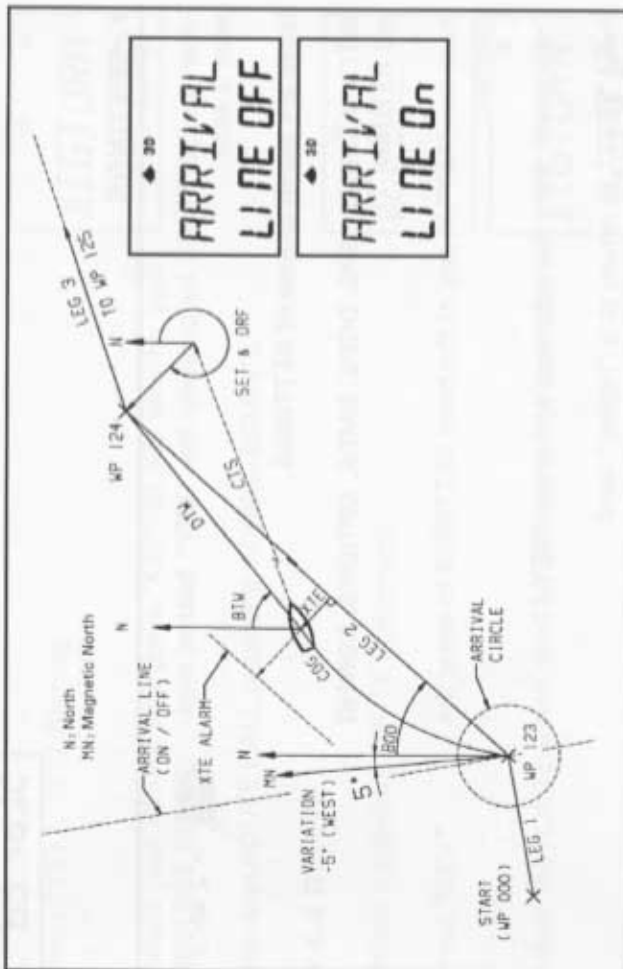

CIRCLE
0200'

7.3 GPS

DAMPING, affects only COG and SOG, level from d0-d9.

The damping will correspond to the following:

d0 = 0s d1 = 1.8s d2 = 4s d3 = 10s d4 = 20s
d5 = 40s d6 = 1'20s d7 = 2'40s d8 = 5' d9 = 10'

** **NAV 1/1**. Select 1/2, 1/3, 1/4 or 1/5 seconds GPS update rate. For marine use, always 1/1.

* **Select ON/OFF**, On = Allow 2D or 3D from start. (OFF = only 3D positions are valid at start).

* **Select geodetic datum**, see appendix. (Lat/long correction can only be made from WGS-84).

GEODAT. This is **ONLY** displayed when used remotely with the no:000 GPS COMPASS. We recommend you to select the "NAMED" geodetical datum directly on the GPS COMPASS.

* **Manual latitude correction from WGS84** in Nautical 0'205Miles, *Note!* Only in 1/1000ths of a minute.

* **Manual longitude correction from WGS84** in Nautical 0'023Miles, *Note!* Only in 1/1000ths of a minute.

* **Altitude correction in selected unit (metres or 025feet)** from WGS-84 to selected geodetic datum.

NAV 1/1

2D--NAV
On

WGS--84
GEO-DAT

LAT--COR
0'205

LONG--COR
0'023

ALT--COR
025

CIRCLE
0200'

NEXT WP
Auto On

XTE-LIM
2500'

START

Auto change to next WP in the sail plan. Can be important when used with autopilots.

X-track error limit.
Ex. shows alarm value entered, 2.5 NM.
Note! The XTE Alarm **MUST** be in Nautical Mile. 

Set **actual start time** (within 18 hrs) to be used to trig the NEXUS Multi's start timer.

RETURN from ALARM setup.

** Setup baudrate for the SILVA GPS Antenna when a input differential receiver is connected to the antenna. See also NMEA information.

* GPS selftest with version no: (version no: and OK is displayed).

T-ZONE, YEAR, DATE, TIME,

Note! It is not possible to set TIME when the GPS is on navigation since the correct time is already given by the satellites.

Set initial estimated position (within 100 km), speeds up the time to first FIX.

RETURN from GPS setup

* *Note ! These GPS settings can not be entered with a NMEA GPS.*

** *Note ! Only when the SILVA GPS Antenna is present.*

7.4 DGPS

This is a special POP UP feature for future differential receivers.

7.5 NMEA

Receive NMEA 0183 waypoints ON/OFF.

Send out internal WP's once via the NMEA port. Select an individual WP or a group of WP's.

RTCM
INPUT

SELF--
TEST

SET TIME

INITPOS



DGPS

REC WPT
OFF

SEND WP
001- 123

Select up to 8 outputs.

Each one of the 8 channels can also be set to --, meaning, no output.

See further information in NMEA 0183 DATA

RETURN from NMEA setup.

7.6 OPTIONS

Magnetic bearing is displayed for BTW, HDC, COG, CTS and SET. The MAGNETIC flag is then displayed.

MAGNETIC VARIATION.

Max 99.9 degrees. (EAST = +, WEST = -).

Note! This setting will directly by affect the compass if it is present.

Push button beep ON/OFF.

WP-BANK

Select for use with Multi instruments,(000, 100, 200, 300.....)

Example, if you select WP bank 200 then all waypoints accessed from a Multi instrument will be in this bank (200-299). This means that when you edit waypoint no: 22 in a Multi, you are actually changing waypoint no: 222.

This is a special function for transfer (import) of WP's FROM a NEXUS MASTER (a navigating Server or GPSNav instrument) TO a NEXUS repeater instrument.

Important! IMPORT can only be done from a NEXUS repeater instrument.

You must also select WP-BANK since IMPORT will transfer in blocks of 100 WP's. You can IMPORT from the NEXUS Server or from another NEXUS GPS instrument.

APB
Out 1

MAG--BRG
OFF

MAG-VAR
02.5 0

KEYBEEP
On

WP--BANK
000

IMPORT

Example 1.

Move all 99 WP's from the Server to this instrument's WP-BANK 300. The Servers WP's from 1 to 99 will then be stored in memory position 301 to 399.

Do as follows,

1. Set to NEXUS REPEATER in the CONFIG
2. Switch POWER OFF then ON to activate this mode change.
3. Set the WP-BANK to 300.
4. Select IMPORT and press the "KEY".
5. Set to MASTER in the CONFIG mode and switch POWER OFF and ON again.
6. You are now able to use the Servers waypoints 1-99 as WP's 300-399.

Example 2.

Move WP 100 to 200 from NEXUS GPS nav-instrument "A" to NEXUS GPS nav-instrument "B" (into the same memory position).

Do as follows,

1. Set to MASTER in the CONFIG for NEXUS GPS "A".
2. Set to NEXUS REPEATER in the CONFIG mode for NEXUS GPS "B".
3. Switch POWER OFF then ON to activate this mode change.
4. Set the WP-BANK to 300 (in "A" or "B")
5. Select IMPORT in "B" and press the "KEY".

Reserved for future POP UP use, set to OFF.

RETURN from OPTION setup.

30
CHART
PAGE OFF

7.7 CONFIG

MASTER, NEXUS-REPEATER or NMEA-REPEATER.

30
NEXUS-
REPEATER

NEXUS POS or NMEA POS.

30
NMEA
POS

NMEA input or RTCM input.

30
NMEA
INPUT

RETURN from CONFIG setup.

30
RETURN

Important! Always switch POWER OFF then ON to activate a mode change.

MASTER

Primary navigation is performed in the MASTER instrument. Only one MASTER instrument is allowed.

NEXUS REPEATER

The MASTER instrument can be remotely controlled from this instrument. There is no difference in functions between a MASTER and a REPEATER.

NMEA REPEATER

Navigation is processed by an external NMEA navigator and then repeated here. The NMEA navigator is connected to THIS instrument, you must therefore also select NMEA POS as the position source (see chapter 7.7.1). You can NOT use the GOTO WP or ROUTES, as long as this instrument acts as a pure NMEA repeater. The NMEA data is also converted and is sent out on the NEXUS Network.

7.7.1 CHOICE OF POSITION SOURCE

This GPS navigator instrument can as an option, use NMEA position data from a Loran, Decca or GPS receiver or from an active GPS Antenna.

If NMEA POS is selected, you must connect the NMEA source to this instruments NMEA 0183 input port, on the back of the instrument, see chapter 3.3.

Note! A SILVA GPS Antenna or GPS COMPASS will automatically take over and transmit position data when connected. The NMEA POS setup is therefore only important when a NMEA position source is to be used.



CONFIG: NEXUS-POS = Standard setup with NEXUS GPS
CONFIG: NMEA-POS = Optional setup

7.7.2 STANDARD NEXUS NAVIGATION SETUP

CONFIGuration is: MASTER and NEXUS POS.

This is the default CONFIGuration for the sole GPS Nav instrument connected to the SILVA GPS Antenna.

7.7.3 NEXUS "REMOTE REPEATER" SETUP

New CONFIG: NEXUS REPEATER and NEXUS POS.

All additional GPS Nav instruments (for multiple Nav-stations) must be set as NEXUS REPEATERS. There can be only ONE MASTER in the system.

7.7.4 NMEA REPEATER SETUP

New CONFIG: NMEA REPEATER and NMEA POS.

When used as a Nav REPEATER. This setup will enable NMEA NAV data from the external navigator, then convert and REPEAT it on to the NEXUS Network.

7.7.5 NMEA NAVIGATOR SETUP

New CONFIG: MASTER and NMEA POS
See also NMEA DATA.

When used as a navigator, it will take the NMEA position data from a sole NMEA GPS Antenna or a navigator, then use the internal waypoints and sail plans as if it was a sole NEXUS GPS NAVIGATOR.

8. NMEA DATA

SILVA NMEA 0183 Input/Output

This document gives a description of the NMEA 0183 sentences sent and received by the GPS navigator instrument.

HDC (Heading Compass) and BSP (Boat speed) is also sent out on NMEA when available from the NEXUS Network.

When used as a NMEA repeater, all data will be retransmitted on to the NEXUS Network.

Note! In the CONFIG SETUP there is a choice between NMEA-0183 and RTCM Input. If RTCM is selected the NMEA Input port is used for RTCM (DGPS) corrections only. The NMEA 0183 output will only operate normal as long as the RTCM Input is set to 4800 baud (bits/sec).



Output

The output from the GPS instrument is divided into 8 different "time-slots". The required NMEA sentence can be selected (or de-activated) individually for each slot. The complete period for all slots is two seconds, so the time between each slot is ¼ sec.

Data that is not available will be sent with null fields. Checksum is added on all sentences. Talker ID (address character 1 and 2) is always II (Integrated Instrumentation).

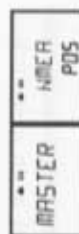
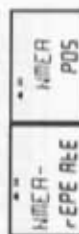
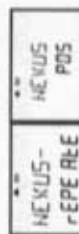
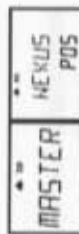

The following sentences can be selected (in the SETUP in the sending instrument):

No:	Sentence:	Contents:
0	—	No sentence sent
1	APB	Autopilot "B"
2	BOD	Bearing, origin to destination
3	BWC	Bearing & Distance to Waypoint
4	GLL	Geographic position
5	GGA	Global Positioning System Fix Data
6	HDT	Heading Coarse (True)
7	RMB	Minimum Navigation data
8	RMC	Minimum Specific GPS/TRANSIT data
9	VDR	Set & Drift
10	VHW	Water speed and heading
11	VTG	Track made good and ground speed
12	WCV	Waypoint Closure Velocity
13	WPL	Waypoint Location
14	XTE	Cross-Track-Error
15	ZDA	Time & Date

Examples of each sentence listed above:

```

$IIAPB,A,0.002,L,N,,,148,T,004,148,T,151,T*1D
$IIBOD,148,T,145,M,004,000*24
$IIBWC,090502,5912.888,N,01812.577,E,148,T,145,M,15.661,N,004*1E
$IIGLL,5926.144,N,01756.232,E,090502,A*3C
$IIGGA,090502,5926.144,N,01756.232,E,1,4,1.49,17,M,,,,*27
$IIHDT,027,T*39
$IIRMB,A,0.002,L,000,004,5912.888,N,01812.577,E,15.660,148,0.53,*58
$IIRMC,090503,A,5926.144,N,01756.232,E,0.64,173,150295,003,E*5F
$IIVDR,226,T,224,M,1.21,N,2.24,K*58
$IIVHW,028,T,025,M,0.00,N,0.00,K*58
$IIVTG,253,T,250,M,0.94,N,1.74,K*55
$IIWCV,0.00,N,004*0A
$IIWPL,5912.888,N,01812.577,E,004*60
$IIXTE,A,A,0.058,L,N*44
$IIZDA,090753,15,02,1995,-01,*79

```

Note! The WPL (WayPoint Location) sentence, only contains the position of the destination WayPoint. All other WayPoints will be sent out when the SEND-WP function is activated in the SETUP.

WayPoint IDs are equal to the true (none banked) WP number in the NEXUS Network (with digits). There is no WayPoint Base Number as in the Server-Unit.

Input

The NMEA input in the GPS navigator/instrument is exclusively used for POSITION and NAVIGATION data (including WayPoints).

The received data is divided into three categories:

- 1) Basic POSITION related data: POSITION, SOG/COG, TIME/DATE and a limited satellite status if the sender is a GPS.

This information is received and sent out on to the NEXUS Network, but ONLY IF the NMEA-POS is selected in the CONFIGURATION SETUP.

- 2) NAVIGATION data: BTW, DTW, BOD, XTE plus Set and Drift

This information is received ONLY IF the NMEA-REPEATER is selected in the CONFIGURATION SETUP.

The GPS instrument will automatically calculate related data that is used in the NEXUS Network, such as: Set and Drift, WCV, TTG and CTS (Coarse To Steer).

- 3) WAYPOINTS: WayPoints are received from WPL sentences if the REC-WPT is ON in the NMEA SETUP.

If the receiving GPS instrument isn't the active navigator (MASTER) the WayPoint will automatically be sent to the active navigator through the NEXUS Network.

See further in the Multi Control manual for using NMEA with the Nexus Server.

9. SPECIAL NMEA AND NEXUS APPLICATIONS

In some applications, you might need an EXTRA NMEA input port. This is possible by using the NEXUS Server (with one Multi Control instrument) together with one NEXUS GPS nav-instrument. This CONFIGuration will convert NMEA position to NEXUS Network and the NEXUS GPS instrument will do the Navigation.

Example:

A boat is equipped with a NMEA GPS Antenna (or a NMEA 0183 navigator) and a NEXUS Chartplotter (see also page 43,44 Tip! for the Chartplotter).

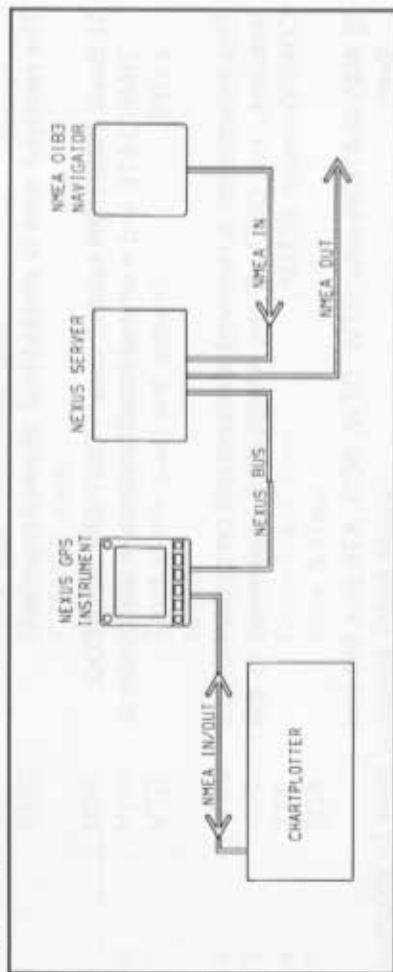

The active NMEA GPS Antenna is connected direct to the NEXUS Server's NMEA input port and the Chartplotter is connected to the NMEA input port and output port on the NEXUS GPS NAVIGATOR instrument.

CONFIGuration in the NEXUS GPS instrument is: **MASTER and NEXUS POS.**

Note! The Server must be version 1.4 or higher.

The Server will then have one NMEA output port free for use with an Autopilot, radar, MAXI Repeater or any other NMEA application. On the NEXUS Network, additional transducers can be used for wind speed, wind angle, depth, log and compass heading.



NMEA INPUT

The NEXUS GPS NAVIGATOR input port (normally used as the NMEA 0183 input) can also be set to receive the RTCM 104 messages for the SILVA GPS COMPASS. It is preferable to use **4800 baud** on the RTCM data to utilize the NMEA0183 standard output data specified at this baud-rate.

Alternative RTCM, Then select baud rate, see below.

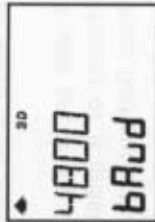
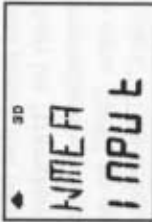

Select baud rate if RTCM is selected and then RETURN.

Note! If possible, always use 4800 baud for RTCM data, it will NOT then affect the baud rate for the NMEA output (4800 is the standard).



9.1 TOGETHER WITH NEXUS CHARTPLOTTER

The link between paper charts and electronic navigation instruments. It is used as the navigation tool that will make both WP navigation and position identification extremely simple, fast and reliable.

When the Chartplotter is used with this navigator instrument and the SILVA GPS Antenna, it is preferable to connect the Chartplotter direct to the instrument. Connect battery POWER, NMEA IN and NMEA OUT without further cabling.

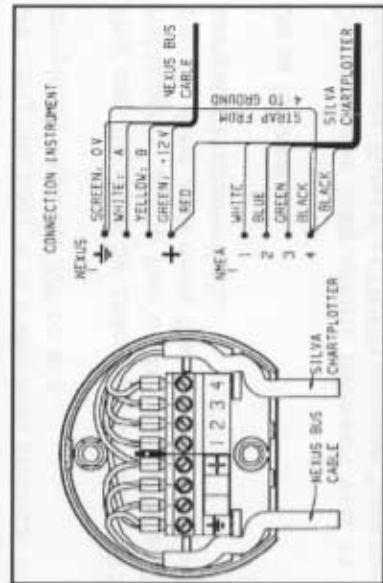

See connection diagram.

Navigation tips!

Select WP 001 in the GOTO WP function on the GPS navigator and then select WP 01 in the WAYPOINT mode on the Chartplotter.

Now move the "puck" to the position you want to go to and press the top left button. That position coordinate will then be "transferred" as WP 01. The NEXUS NAVIGATOR immediately starts navigating towards that WP, whenever a new "WP" to goto is preferred, move the puck to it and "click". This unique feature makes WP navigation very easy as there is no need for storing and recalling waypoints.

If you prefer to use the Chartplotter as the tool for fast storing of a great number of waypoints (over 100), you must first enter the Chartplotters setup and select WP block number according to this:

- 0183 for WP's 00 and up to 099
- 0183-1 for WP's 100 and up to 199.
- 0183-2 for WP's 200 and up to 299

When this setup is correct, the WP's will be received and stored in the corresponding NEXUS NAVIGATOR's memory.

9.2 SPECIAL USE TO GET EXTRA WP's.

When two or more navigator instruments are connected to the NEXUS Network and if more than one "skipper" or family are using the boat, it is sometimes practical to utilize two completely separate WP bank's.

This can be done by changing the CONFIG in the two instruments, giving two users 399 WP's each. This can also be done with more than two instruments (up to 32 navigator instruments!!).

Do as follows:

Dedicate the instruments between you as "personal" navigators. Enter the CONFIG setup on "your partners" navigator and set it to NEXUS REPEATER

Then enter the CONFIG setup on "your" instrument and set it to MASTER. Turn the power OFF and then ON again to activate this change. The waypoints are now used from the new MASTER instead. Both (or all) instruments can now use the "new" waypoint bank.

9.2 EXTRA FEATURES WITH SILVA NEXUS NETWORK

Integrate the navigator with the NEXUS Multi Control and Server by adding compass and speed transducers. You will then get compass heading, boat speed, drift and tidal data (its speed and direction).

PC-INTERFACE CABLE

The interface, (RS 232 to RS 485) is built-in in the 25-pole DSUB connector which connects to the PC (use 25-9 pole adapter if necessary).

Connect the interface cable (art.no. 20913 or 21122) between PC and GPS. Select the function REMOTE, then run the interface software (see instructions).

Contact your SILVA dealer for more information.

10. FAULT FINDING

Check:

- Sufficient battery voltage.
- Cables for damage.
- Faulty contact in connectors.
- Connector corrosion caused by poor protection.
- Short circuit on the NEXUS Network.

The following error messages can appear on the display:
Some errors are made by improper connections or when calling for unconnected functions (missing transducers).

- 01 = Stack error.
- 02 = SILVA BUS missing, Check databus colours and connections.
- 03 = Watchdog Timeout, Check the connections.
- 04 = EEPROM: Read-error.
- 05 = EEPROM: Write-error.
- 06 = RAM-MEMORY Read-error
- 07 = UART Queue-Pointer-error
- 08 = Break Point Reset
- 09 = EEPROM-Initialization
- 10 = Range-error caused by incorrect format, e.g. 17°70 minutes East.
- 11 = Remote command that can not be performed (calibration-error)
- 12 = No response, or missing navigator unit
- 13 = WayPoint Not DEFINED
- 14 = Operation that can not be done with external NMEA navigator.
- 15 = Operation that can not be done in AUTO-Pilot Mode
- 16 = (not used)
- 17 = (not used)
- 18 = (not used)
- 19 = (not used)
- 20 = GPS -> CPU: Communication Error.
- 21 = GPS ACQUISITION - failure (time out during indoor use).
- 22 = CPU -> GPS : Communication error!
- 23 = DGPS (RTCM) overrun
- 24 = Bad-Fix (1-Fix timeout)
- 25 = (not used)
- 26 = (not used)
- 27 = Extended Object Server Error (set the GPS to Master)
- 28 = Route command error (bank, full..)

11. OPTIONS

The following items can be supplied as optional equipment:

- SILVA GPS Antenna: Art.No. 21000
- SILVA GPS COMPASS (handheld GPS) Art.No. 20700
- SILVA NEXUS CHARTPLOTTER Art.No. 20882
- SILVA NEXUS Multi Control Repeater Art.No. 20445-4
- SILVA NEXUS GPS NAVIGATOR as repeater Art.No. 21032

It is also possible to connect NEXUS Analog Repeaters, contact your local SILVA dealer for further information:

PC interface, 2 m cable including a 3 1/2" disc with software for WP editor and databus manager. Art.No. 20913 or 21122

12. TECHNICAL DATA

- Dimensions: 110 x 110 x 25 mm
- Data cable: 8 m. Battery cable 3 m.
- Battery voltage: Min. 6.0 V, max. 16.5 V.
- Power consumption: Without light 0,1 W, With light 0,8 W.
- Temperature range: Operation -20C to +70C.
Storage -30C to +80C.
- Weight: Instrument: 280 g

13. MAINTENANCE

- Clean the instrument with mild soap solution only!
- Do not use high-pressure washing equipment!
- It is advisable to remove the instrument during long cold periods.
- Put silicon grease on each contact.
- Check terminals and use wire protection.

14. WARRANTY

SILVA SWEDEN AB gives a two year warranty against manufacturing faults or faulty components. The supplied warranty card together with a purchasing receipt must be shown if a warranty claim is made. The warranty does not apply to damage caused by careless handling or faulty installation. The warranty does not apply to secondary damage caused by faults in instruments or transducers. The right to change the specification is reserved by the manufacturer.

SILVA SWEDEN AB reserves the right to change product specifications without notice.

15. ABBREVIATIONS

2D	2-dimensional navigation
3D	3-dimensional navigation
ALT	Altitude
AQU	Acquisition
BOD	Bearing origin destination (the FROM WP)
BRG	Bearing
BTW	Bearing To Waypoint
COG	Course Over Ground
COR	Correction of LAT/LON from WGS84
CTS	Course To Steer
DGPS	Differential GPS
DoD	Department of Defence
DTW	Distance To Waypoint
EDIT	Programme/ enter or alter a value or a name
ETA	Estimated Time of Arrival
F	Figure of merit
GPS	Global Positioning System
HDOP	Horizontal Dilution of Precision
INIT POS	Initialisation of a known position in cold start
MAG VAR	Magnetic Variation
MOB	Man Over Board
NAV	Navigate
NMEA	National Marine Electronic Ass.
POS	Position
RTCM	Differential Correction Standard
SAT	Satellites used in navigation.
TTG	Time to go to next WP.
VMG	Velocity Made Good
WCV	Waypoint Closure Velocity
WP	Waypoint
XTE	X-Track Error

Free Manuals Download Website

<http://myh66.com>

<http://usermanuals.us>

<http://www.somanuals.com>

<http://www.4manuals.cc>

<http://www.manual-lib.com>

<http://www.404manual.com>

<http://www.luxmanual.com>

<http://aubethermostatmanual.com>

Golf course search by state

<http://golfingnear.com>

Email search by domain

<http://emailbydomain.com>

Auto manuals search

<http://auto.somanuals.com>

TV manuals search

<http://tv.somanuals.com>