

Multi Control

- Instrument -



Installation and Operation Manual
English



MULTI CONTROL

Navigation terms

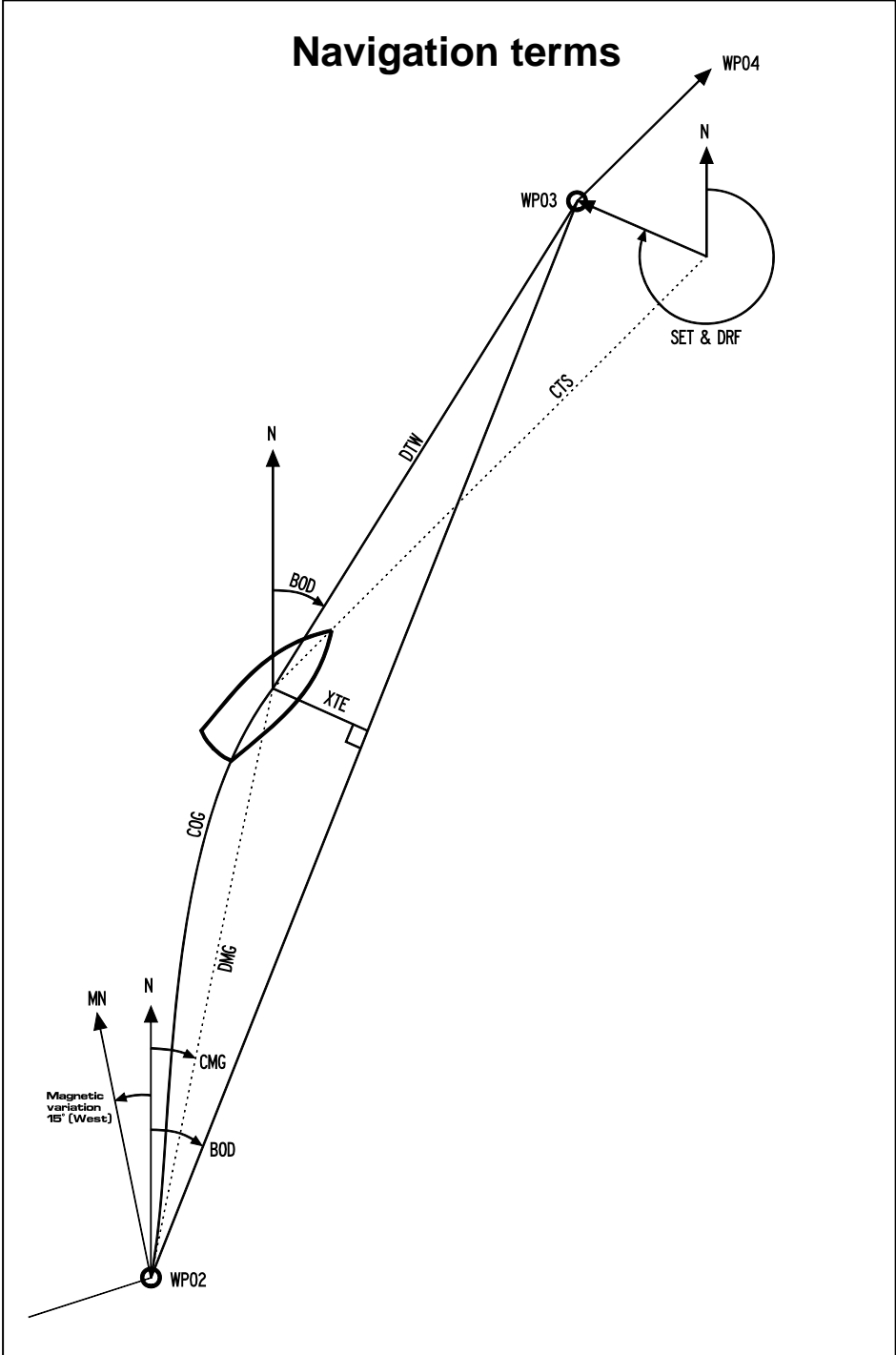



This manual is written for NX2 Multi Control version 3.1 – 5.0
Edition: March 2007

1	Part specification	8
2	Installation	12
2.1	Installing the instrument	13
2.1.1	Installing instrument to the Server	14
3	First start	15
3.1	Initialising the instrument	15
3.2	Re-initialising the instrument	15
4	Operation	16
4.1	About this manual	16
4.2	How to use the push-buttons	17
4.2.1	PAGE	17
4.2.2	MINUS	17
4.2.3	PLUS	17
4.2.4	SET	18
4.2.5	Clear / cancel / reset	18
4.2.6	Calibration	18
4.2.7	Lighting	18
5	Function overview	19
6	SPEED functions	20
6.1	SPEED main-function	20
6.2	SPEED sub-functions	20
6.2.1	TRIP LOG (TRP)	20
6.2.2	TOTAL LOG (LOG)	20
6.2.3	MAXIMUM SPEED (MAX)	20
6.2.4	START TIMER (STA)	20
6.2.5	TIMER	20
6.2.6	AVERAGE SPEED (AVS)	20
6.2.7	DISTANCE (DST)	20
6.2.8	DEPTH (unit/DPT)	21
7	PLUS functions	22
7.1	DEPTH main-function	22
7.2	PLUS sub-functions	22
7.2.1	LIGHT CONTROL	22
7.2.2	BATTERY (BAT)	23
7.2.3	SHALLOW ALARM (SHA)	23
7.2.4	DEPTH ALARM (DEA)	23
7.2.5	ANCHOR ALARM	23
7.2.6	HEADING (HDT/HDM)	23
7.2.7	TEMPERATURE (TMP)	23
7.2.8	UNIVERSAL TIME (UTC)	23
7.2.9	BOAT SPEED (BSP/unit)	23
7.3	Remote Control (REM)	24
7.4	Set and turn on shallow (SHA) and depth alarm (DEA)	25
7.5	Set and turn on anchor alarm (ANC)	25
7.6	Clear an alarm value	25

7.7	Silencing an alarm	25
7.8	Turning off / on an alarm.....	25
8	NAVIGATION functions.....	26
8.1	NAVIGATION main-function	26
8.2	NAVIGATION sub-functions	26
8.2.1	STEER REFERENCE (Pilot OFF)	26
8.2.2	STEER VALUE (STR)	26
8.2.3	(SOG) and (COG).....	26
8.2.4	(BTW) and (DTW).....	26
8.2.5	LATITUDE and LONGITUDE (POS)	26
8.2.6	SET and DRIFT	27
8.2.7	(CMG) and (DMG)	27
8.2.8	WAYPOINT CLOSURE VELOCITY (WCV).....	27
8.2.9	CROSS TRACK ERROR (XTE)	27
8.3	Steer reference (Pilot).....	28
8.3.1	Overview of steer reference (Pilot).....	29
8.3.2	Steer reference (MEM)	29
8.3.3	Steer reference (BTW)	30
8.3.4	Steer reference (CTS)	31
8.3.5	Steer reference (AWA)	31
9	Wind functions	33
9.1	WIND Main-function.....	33
9.2	WIND Sub-functions	33
9.2.1	STEER REFERENCE (Pilot OFF)	33
9.2.2	STEER VALUE (STR)	33
9.2.3	APPARENT WIND SPEED (AWS)	34
9.2.4	TRUE WIND SPEED TWS	34
9.2.5	VELOCITY MADE GOOD (VMG)	34
9.2.6	TACTICAL FUNCTION (TAC)	34
9.2.7	GEOGRAPHIC WIND DIRECTION	35
9.3	Tactical function.....	36
10	Man over board (MOB) function.....	37
11	Customise your display	38
11.1	Move and lock a sub-function	38
11.2	Copy and lock a sub-function.....	38
11.3	Select power on function.....	39
11.4	Cancel a moved or locked sub-function	39
11.5	Temporary locking of alternating functions	39
12	Calibration.....	40
12.1	Calibration of speed C10	40
12.1.1	C10 Return (RET)	40
12.1.2	C11 (Unit KTS).....	40
12.1.3	C12 (1.25 CAL)	40
12.1.4	C13 DAMPING (SEA).....	41
12.2	C20, calibration of depth.....	41
12.2.1	C20 (RET)	41
12.2.2	C21 (Unit m).....	41

12.2.3	C22 (- 00.0 ADJ).....	41
12.2.4	C23 (Unit°C)	41
12.2.5	C24 (0°C TMP)	41
12.2.6	C25 (Unit hPA).....	41
12.3	C30, calibration of navigation.....	42
12.3.1	C30 (RET).....	42
12.3.2	C31 (PAGE ATO)	42
12.3.3	C32 (00° OCA).....	42
12.3.4	C33 (00.0 VAR)	42
12.3.5	C34 (Auto DEV).....	42
12.3.6	C35 (Auto CHK).....	42
12.3.7	C36 (Auto CLR)	42
12.3.8	C37 (000°ADJ).....	42
12.3.9	C38 (OFF SEC).....	42
12.3.10	C39 (Pilot SEA).....	42
12.3.11	C40 (OFF MAG)	43
12.3.12	C41 DAMPING (SEA).....	43
12.4	Compass calibration.....	43
12.4.1	Automatic compass deviation compensation (Auto DEV).....	43
12.4.2	Automatic compass deviation check (Auto CHK).....	44
12.4.3	Cancel earlier performed compass deviation (Auto CLR)	44
12.4.4	Compass misalignment correction (Adj)	44
12.5	C50, calibration of wind.....	45
12.5.1	C50 (RET).....	45
12.5.2	C51 (PAGE ATO)	45
12.5.3	C52 (OFF TWA).....	45
12.5.4	C53 (Unit m/s).....	45
12.5.5	C54 (1.70 CAL).....	45
12.5.6	C55 (000° ADJ).....	45
12.5.7	C56-C63 Wind calibration values.....	45
12.5.8	C64 (WIA).....	46
12.5.9	C65 DAMPING (SEA).....	46
12.5.10	C67 WIND SPEED ALARM (WSA).....	47
12.6	C70, calibration of Network and NMEA.....	47
12.6.1	C70 (RET).....	47
12.6.2	C71 (OFF KEY)	47
12.6.3	C72 (d0 SEA).....	47
12.6.4	C73 (OFF BSP)	47
12.6.5	C74 (OFF DEP)	47
12.6.6	C75 (OFF CMP).....	48
12.6.7	C76 (OFF WND).....	48
12.6.8	C77 to C92.....	48
12.6.9	C93 (d4 NME).....	48
12.6.10	C94 (OFF COG)	48
12.6.11	C95 (OFF SOG).....	48
12.6.12	C96 (REF BSP)	48
12.7	NMEA.....	49
12.7.1	Transmit NMEA sentences OUT from Server.....	49

12.7.2	Change NMEA sentences OUT from Server	50
12.7.3	Receive NMEA sentences IN to Server	51
12.8	Special NMEA sentences	53
12.8.1	Baudrate control,	53
13	Maintenance and fault finding	54
13.1	Maintenance	54
13.2	Fault finding	54
13.2.1	General.....	54
13.2.2	Fault - action.....	55
13.2.3	Error messages	55
14	Specifications	56
14.1	Technical specifications	56
14.2	Nexus Network introduction and user policy	56
14.3	Optional Accessories	57
14.4	Abbreviations	59
15	Warranty	62

1 Part specification

Items delivered with the instrument

1	NX2 Multi Control instrument	4
1	Instrument cover	5
5	Cable protectors, 0,25 mm (0.1 inch)	6
5	Cable protectors, 0,75 mm (0.3 inch)	6
4	Instrument mounting screws	7
4	Rubber caps for screws	7
1	Connection back cover	7
1	4-pole jack plug	7
1	Silicon paste tube	7
2	Plastic cable strap	7
1	Adhesive drill template for instrument	8
1	Nexus Network cable, 8 m (26 ft)	9
1	Quick guide laminated	10
1	Inter-connection cable, 0,3 m (1 ft)	
1	Installation and Operating manual	11
1	Warranty card	12
1	National distributor list	13

Registering this product

Once you have checked that you have all the listed parts, please take time to fill in the warranty document and return it to your national distributor.

By returning the warranty card, it will assist your distributor to give you prompt and expert attention. Keep your proof of purchase. Also, your details are added to our customer database so that you automatically receive new product catalogues when they are released.

Warranty conditions see chapter 15.



1



2

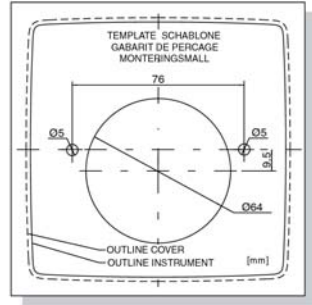

3



4

File id:

WARRANTY CARD
TO BE RETURNED TO YOUR NATIONAL DISTRIBUTOR

OWNER:
Name: _____
Street: _____
City/Zip Code: _____
Country: _____

Product name: _____ Serial number: _____

A	C	1	2	3	4	5	6	7	8	9	0
<input type="checkbox"/>	<input type="checkbox"/>	<input type="checkbox"/>	<input type="checkbox"/>	<input type="checkbox"/>	<input type="checkbox"/>	<input type="checkbox"/>	<input type="checkbox"/>	<input type="checkbox"/>	<input type="checkbox"/>	<input type="checkbox"/>	<input type="checkbox"/>
<input type="checkbox"/>	<input type="checkbox"/>	<input type="checkbox"/>	<input type="checkbox"/>	<input type="checkbox"/>	<input type="checkbox"/>	<input type="checkbox"/>	<input type="checkbox"/>	<input type="checkbox"/>	<input type="checkbox"/>	<input type="checkbox"/>	<input type="checkbox"/>

Date of purchase: _____ Date installed: _____

Dealers stamp: _____

☐ here if you do not wish to receive news about future products

5

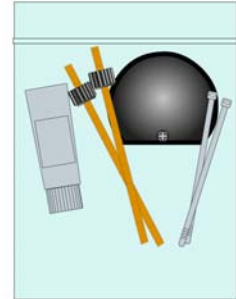

6

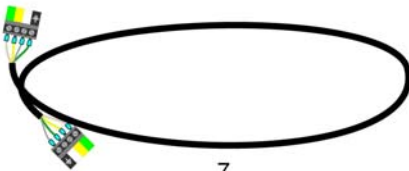

7



8

Welcome aboard the Nexus Network!

Thank you for choosing NX2 and welcome to the world of the Nexus Network.

Through this manual we would like to help you install, operate and understand your new Nexus Network.

The Server is the "heart" of your Nexus Network, to which transducers for speed, depth, heading, wind and navigation (GPS, Loran or Decca) are connected.

From the Server the single Nexus Network cable transmits power and data to the instruments, which repeat the information sent from the Server, or other NX2 transducers.

The Nexus Network is designed with the industry standard RS 485 databus, which allows you to connect up to 32 NX2 instrument units on the single Nexus Network cable, thereby allowing you the flexibility to easily develop your system. The Nexus Network is capable of carrying data 10 times faster than NMEA 0183.

The connection system, with a single 5 mm (1/5") cable and 4-pole jack plugs with cable protectors, makes the installation easy. No need to drill big holes and the cable can be cut to exact lengths. The connections at the Server are colour coded and marked with a number for easy reference.

NX2 Multi Control is a multi function instrument that displays a main and a sub-function together. You can easily "customise" your favourite combination of functions, by using the unique method to move, copy and lock a sub-function.

The instruments large display gives you very good viewing possibilities from any angle, even in bright sunlight. The display and the five push-buttons have red back lighting which you can set to three different lighting levels.

A large selection of optional analogue repeaters and accessories are available. The analogue steer pilot instrument particularly offers unique functions. When used together with the steer reference function (AWA), you can actually steer after the wind and "expand" the tacking or down wind angle.

These NX2 instruments carry a two year warranty, which gives you as our customer, confidence to trust NX2 and our commitment to quality.

To get the most out of your new NX2 product, please read through this manual carefully before you start your installation.

Again, thank you for choosing NX2. If you see us at a show, stop by and say hello.

Good luck and happy boating!

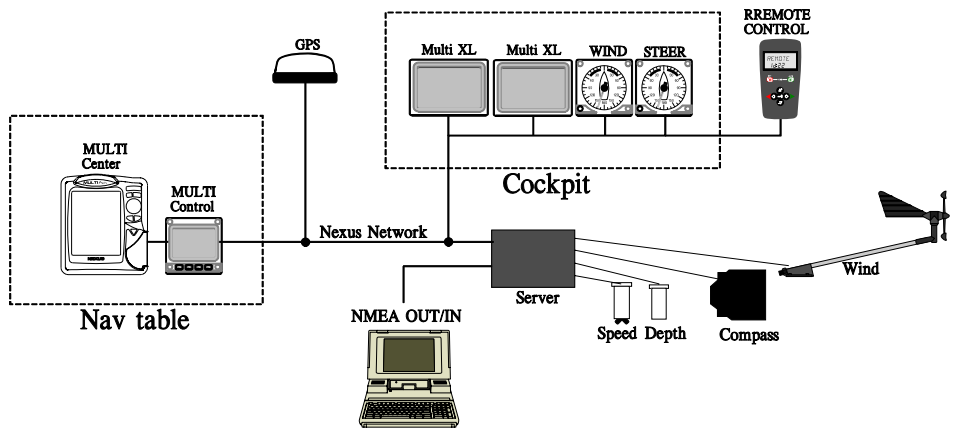

2 Installation

- **The installation includes 6 major steps:**

1. Read the installation and operation manual.
2. Plan where to install the transducers and instruments.
3. Run the cables.
4. Install the transducers and instruments.
5. Take a break and admire your installation.
6. Learn the functions and calibrate your system.

Before you begin drilling ... think about how you can make the installation as neat and simple as your boat will allow. Plan where to position the transducers, Server and instruments. Think about leaving space for additional instruments in the future.

- **A few "do nots" you should consider:**

- Do not cut the cables too short. Allow extra cable length at the Server so it can be disconnected for inspection without having to disconnect all attached cables.
- Do not place sealant behind the display. The instrument gasket eliminates the need for sealant.
- Do not run cables in the bilge, where water can appear.
- Do not run cables close to fluorescent light sources, engine or radio transmitting equipment to avoid electrical disturbances.
- Do not rush, take your time. A neat installation is easy to do.



- **The following material is needed:**

Wire cutters and strippers.

Small and large Philips and small flat head screw driver.

Hole saw for the instrument clearance hole 63 mm (2½").

5 mm (¼") drill for the mounting holes.

Plastic cable ties

If you are doubtful about the installation, obtain the services of an experienced technician.

2.1 Installing the instrument

- Place the adhesive drill template on the desired location for the instrument. Drill the 2 holes using a 5 mm ($1/4$ ") drill for the two pin bolts. Use a 63 mm ($2\frac{1}{2}$ ") hole saw to machine the clearance hole for the instrument connection socket. Remove the template.

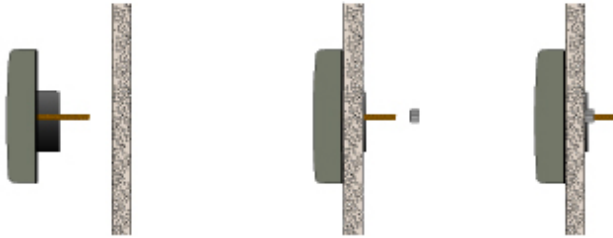
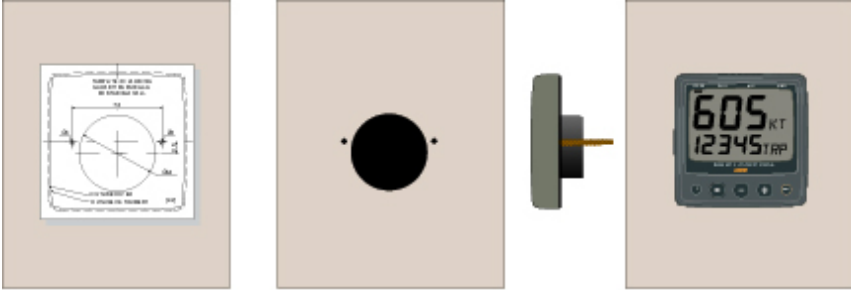

- Screw the two pin bolts to the instrument
- Put the instrument in place
- Screw the two nuts from the back

Note! The two nuts must just be tighten by hand

- Run the Nexus Network cable from the Server to the instrument.
- If you want to cut the Nexus Network cable to length, disconnect 4-pole jack plug and cut the cable. Peel off about 35 mm (1,4") of the cable insulation. Remove about 6 mm ($1/4$ ") from the 3 isolated wires (the 4th wire is an earth / screen). Attach the 4 cable protectors to the wires using a pair of flat pliers.
- Connect the 4 cable protectors to the 4-pole jack plug as shown. Apply silicon paste on all locations as shown.

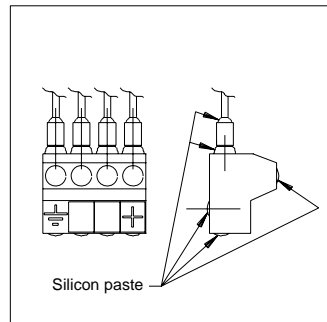

Note: Must be done to avoid corrosion.

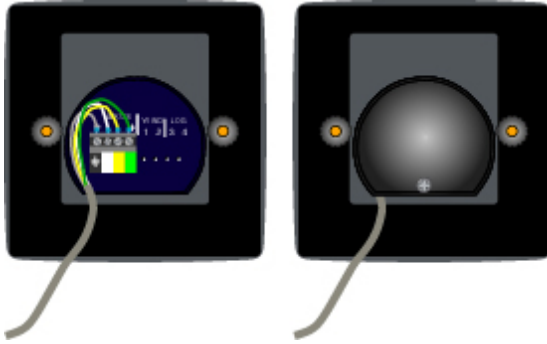

- Apply silicon paste to the instrument connection pins at the back of the instrument. Press the jack plug onto the instrument pins. Press the cable in to the cable leads.
- Mount the connection back cover with the screw.

2.1.1 Installing instrument to the Server

All NX2 instruments are connected directly to the Nexus Network in a daisy chain. They all use the same colour coded 4-pole jack plugs.

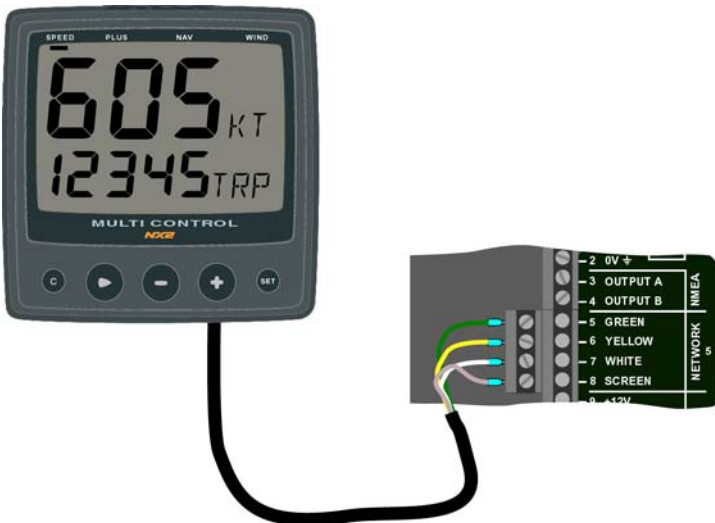

3 First start

3.1 Initialising the instrument

At power on, the instrument will perform a self test. The display will first show all segments, then the software version number and the Nexus Network ID number.

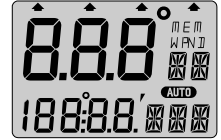

At first power on after installation, you will be asked to press **SET** (PrESkey). This will give the instrument a logical ID number on the Nexus Network.



To initialise the instrument, press **SET** on all installed digital instruments, one at the time.

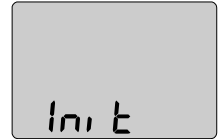

Note: Always wait for the text "Init OK" to be displayed, before you press SET on the next instrument!



The Server automatically gives the first unit ID number 16, then 17 and so on. The order in which you press **SET** is the same order as the instruments will be given a logical ID number on the Nexus Network.



The example shows that the instrument version number is 2.0 and the given logical ID number is 16.

3.2 Re-initialising the instrument

If two instruments by mistake have the same ID number, this can cause disturbance and block the information on the Nexus data bus.



To re-initialise the instrument, press **CLEAR** during the power up sequence when version and ID numbers are displayed.

The display self test is then re-started on all instruments and you will be asked to press KEY on each instrument as explained above.



Note! If you do not succeed to re-initialise, we suggest you disconnect all but one instrument with the same ID number, then repeat the above procedure.

4 Operation

4.1 About this manual

- In this manual each time a push-button is referred to, the push-button name will appear in **bold** and CAPITAL letters example **PAGE**.
- Unless otherwise stated the push-button presses are momentary.
- Each time a function is mentioned in the text, it will be in brackets and in the same format, where possible, as displayed, ex. (LAt).
- By the word navigator, we mean a GPS, Loran or Decca instrument.
- Which instrument is navigating? By the term navigating, we mean the active instrument in which the waypoint memory is used for navigation to calculate the navigation data, ie BTW, DTW etc. There can only be one instrument on the Nexus Network which is keeping the waypoints in memory, but the waypoints can be reached from all instruments.
- This manual has been written to be:
Compatible with NX2 Server from software version 3.0.
Compatible with NX2 Multi Control instrument from software version 3.0
The products can be updated to the latest version for a fee.
Please contact your NX2 dealer for further information.

4.2 How to use the push-buttons



4.2.1 PAGE

A press on **PAGE** moves the top LCD arrow to the next page. It scrolls in a circular pattern, one step to the right for every press, in the order SPEED, DEPTH, NAVIGATE, WIND and then back to SPEED page again. A press on **PAGE** and **MINUS** together, back steps **PAGE** to the preceding page.

The **PAGE** button is **also** used to move the cursor when in edit mode.

A press on **PAGE** moves the cursor in a circular pattern, one step to the right for every press.

A press on **PAGE** and **MINUS** together, back steps cursor to the preceding step.

4.2.2 MINUS

A press on **MINUS** moves to the next sub-function.

In edit mode it decreases to the previous digit.

4.2.3 PLUS

A press on **PLUS** moves to the previous sub-function.



In edit mode it increases to the next digit.

4.2.4 SET

A press on **SET** unlocks a digit to access edit mode. When unlocked, the digits are "active" (flashes) and can be edited by pressing **MINUS**, **PLUS** and **PAGE** as required. When finished editing, lock the digit by another press on **SET**.



4.2.5 Clear / cancel / reset

A press on **CLEAR**, clear digits, cancel alarms or resets the counters.



4.2.6 Calibration

To access calibration mode, press and hold **SET** more than 2 seconds.



To return to main-function mode, press **SET** when the text return (RET) is shown.

4.2.7 Lighting

The instrument uses red back lighting for the display and the 4 push-buttons. The lighting can be set at 4 different levels.



To quick access the light control, press and hold **PAGE** for more than 2 seconds. The flashing text (Lit OFF) will be displayed and the display will be lit momentarily.

To select between the 4 light levels, Press **PLUS**: LOW, MED, MAX and OFF. To lock the selected level press **SET**.

The selected light level will be copied to all NX2 instruments connected to the system. When the lighting is on, it is not possible to reduce or turn off the lighting on an individual instrument.

5 Function overview

The functions in the Multi Control instrument are divided into 4 pages:

SPEED, DEPTH, NAVIGATE and WIND.

The selected page is indicated by the LCD arrow at top of the display.

Each page has 2 types of functions that can be displayed together:

1. Main-function, displayed at the top of the display in 30 high digits.
2. Sub-function, displayed at the bottom part of the display in 17 mm high digits.

You can easily customise your favourite combination of functions, (See chapter 11).

The instrument can display metric and imperial units.
For unit selection, (see chapter 12).

For function overview and transducers needed to display each function, see the inside of the back cover.

In addition, the enclosed laminated quick guide will help you to get an overview when using the instrument onboard.

6 SPEED functions

6.1 SPEED main-function

Boat speed through the water.

Unit available in knots (KT), km/h (Kh) or miles/h (Mh) (See 12.1.2, C11). If a navigator is connected, speed over ground (SOG) can be displayed. (See 12.6.11,C95).

6.05 KT

6.2 SPEED sub-functions

6.2.1 TRIP LOG (TRP)

0-199,99 NM, only displayed in NM. Distance covered from power on.

12345 TRP

To reset TRIP LOG press **CLEAR**.

6.2.2 TOTAL LOG (LOG)

0-19999 NM, only displayed in NM. Can not be reset.

12345 LOG

6.2.3 MAXIMUM SPEED (MAX)

Maximum speed since power on, or from reset of timer. To reset, press **CLEAR**.

0.00 MAX

6.2.4 START TIMER (STA)

Count down timer from 59 to 1 minutes.

To start the timer from minus 10 minutes (-10'STA) press **SET**.

The figure 1 in 10 is flashing. If you want to start count down from 10 minutes, press **SET**.

If you want to start the timer from any other time (59 to 1 minute) for example minus 5 minutes (-5'STA), press **PAGE**, **MINUS** and **PLUS** as required to set 5 minutes and start the timer with **SET**.

When started, displays the count down time in minutes and seconds.

During the last 10 seconds the alarm will sound once every second.

- 10'STA

6.2.5 TIMER

Elapsed time in hr/min/sec from power on, or from end of start timer count down. To reset, press **CLEAR**.

12:04'52

6.2.6 AVERAGE SPEED (AVS)

Average speed from power on, or from reset of timer. To reset press **CLEAR**.

4.56 AVS

6.2.7 DISTANCE (DST)

Covered distance from power on, or from reset of timer. To reset, press **CLEAR**.

12345 DST

6.2.8 DEPTH (unit/DPT)

Depth from the water surface or the keel depending on calibration setting (See 12.2.3, C22).

Unit available in meters (m), feet (FT) or fathoms (FA). (See 12.2.2,C21).

The text alternates between the selected (unit) and (DPT).



7 PLUS functions

General information

Alarm on = minute sign (´) displayed above the last depth digit in the sub-function.

Alarm off = no minute sign (´) displayed.

The alarms will be triggered, if the actual depth becomes less (shallow alarm), or more (depth alarm), than the set depth value.

The alarm is audible (signal) and visual (main and sub-function flashes).

When a triggered alarm has been silenced, it will only be triggered again if the selected depth value differs by +/-2m (6 ft)

If a different page than DEPTH is shown when the alarm is triggered, the set alarm function will automatically be shown flashing, until you silence or turn off the alarm. The instrument will then automatically return to the previous page.

Loss of signal. If there are no depth echoes for 3 seconds, the display indicates 3 dotted lines (---) until a new echo is received.

7.1 DEPTH main-function

Depth from the water surface or the keel depending on calibration setting (See 12.2.3, C22).

Unit available in meters (m), feet (FT) or fathoms (FA). (See 12.2.2, C21).



7.2 PLUS sub-functions

7.2.1 LIGHT CONTROL

The instrument uses red back lighting for the display and the 5 push-buttons. The lighting can be set at 4 different levels.

To change light level, press **SET**, The flashing text (Lit OFF) will be displayed and the display will be lit momentarily.

To select between the 4 light levels, Press **PLUS**: LOW, MID, MAX and OFF. To lock the selected level press **SET**.

The selected light level will be copied to all NX2 instruments connected to the system. When the lighting is on, it is not possible to reduce or turn off the lighting on an individual instrument.

7.2.2 BATTERY (BAT)

Battery voltage at the Server.



7.2.3 SHALLOW ALARM (SHA)

Depth at which point audible and visual alarms will be triggered, if the actual depth becomes less than the set value. (See 7.4).

7.2.4 DEPTH ALARM (DEA)

Depth at which point audible and visual alarms will be triggered, if the actual depth becomes more than the set value. (See 7.4).



7.2.5 ANCHOR ALARM

To set an anchor alarm, set the shallow (SHA) alarm to actual depth minus 1,5 m / 5 FT then set a value for the depth (DEA) alarm to actual value plus 1.5 m / 5 FT.



The logic is that when you are at anchor, the alarm will warn you if the boat is drifting towards deeper or shallower water.

7.2.6 HEADING (HDT/HDM)

Compass heading, heading true (HDT) or heading magnetic (HDM). (See 12.3.11 C40).



7.2.7 TEMPERATURE (TMP)

Water temperature. Units available in Celsius (C) or Fahrenheit (F). (See 12.2.4, C23 and C24)

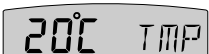

7.2.8 UNIVERSAL TIME (UTC)

Time in hr/min/sec. This function will only be displayed if a GPS receiver is connected to the system. The (UTC) is indicated by a (U) after the time.



To set your local time (L) zone from (UTC), press **SET** and the first digit flashes.

If you want to add to (UTC), select underlining character (_).

If you want to reduce from (UTC), select minus sign (-) by pressing **PLUS**.

To set the time zone value press **PAGE**, **MINUS** and **PLUS** as required.

To store the zone value press **SET**.

Example: In United Kingdom the local time zone setting should be (_ 00h ZON) during winter time, and plus one hour (_ 01h ZON) in the summer time.

7.2.9 BOAT SPEED (BSP/unit)

Boat speed through the water. Select the unit from knots (KT), km/h (Kh) or miles/h (Mh). (See 12.1.2, C11). The text alternates between (BSP) and the selected (unit).



7.3 Remote Control (REM)

The NX2 Multi Control can be used to remote control other digital NX2 instruments.



All digital NX2 instruments has their unique ID number on the Nexus Network. At power up the ID numbers are displayed for a short time.



The instrument to the right has ID number 16 (version number is 2.0)

Note the ID numbers for the instrument you want to remote control.

Press **SET** and the selected ID number is flashing.



Select the ID number for the instrument you want to control with **PLUS** and **MINUS** as required. Press **SET** to start remote control. Four push button symbols are displayed to tell you are in remote mode. The display of the instrument you selected will flash once and then the **PAGE** symbol of that instrument will continue to flash to tell it is remote controlled.



Now you can use the four push buttons:



To exit the remote control page, press **CLEAR**:



7.4 Set and turn on shallow (SHA) and depth alarm (DEA)

Select shallow (SHA) or depth (DEA) alarm, press **SET**.

The first digit in the previous value flashes.

If you want to reset the previous value to zero (0), Press **CLEAR**.

To select desired depth press **MINUS**, **PLUS** and **PAGE** as required.

Press **SET** to lock the selected value.

By this last press on **SET**, you have turned on the selected alarm function, which is indicated by the minute sign (´) above the last depth digit in the sub-function.

7.5 Set and turn on anchor alarm (ANC)

Select anchor alarm (ANC), press **SET**.

The first digit flashes.

The instrument will suggest a value for the shallow (SHA) alarm (actual depth minus 1,5 m / 5 FT).

To store the value press **SET**, or select your own depth as in 7.3.

The minute sign (´) is shown above the last depth digit in the sub-function.

The instrument will suggest a value for the depth (DEA) alarm (actual depth plus 1,5 m / 5 FT).

To store the value press **SET**, or select your own depth as in 7.3.

The minute sign (´) is shown above the last depth digit in the sub-function.

7.6 Clear an alarm value

Select the alarm function to be cleared, press **SET**.

The first digit flashes.

To clear the alarm, press **CLEAR**. All digits are set to zero (0).

Press **SET** to lock the function.

7.7 Silencing an alarm

To silence a triggered alarm that sounds and flashes, press **ANY** button.

The sound is silenced and the flashing stops.

The alarm is only triggered again if the selected depth value is exceeded (shallower or deeper) by 2 m (6 feet).

7.8 Turning off / on an alarm

Select the alarm function to be turned off / on.

To turn the alarm off / on, press **CLEAR**.

The minute sign (´) disappears / appears.

8 NAVIGATION functions

8.1 NAVIGATION main-function

Heading 000° to 359°.

Heading true (HT) or heading magnetic (HM) can be displayed if the compass transducer is connected. (See 12.3.11 C40)

If a navigator is connected, course over ground (CG) can be selected instead of compass heading. (See 12.6.10, C94).



Note! This page can either be on or off. As a factory setting this page is automatically on if a Compass transducer or GPS is connected. In the set up, you can select this page to be on, off or automatic on. See chapter: 12.3.2

8.2 NAVIGATION sub-functions

8.2.1 STEER REFERENCE (Pilot OFF)

Displays the selected steer reference function. This function also controls what is shown on the optional analogue steer pilot instrument (Art No 22115-02). Steer reference can be selected from 5 alternatives. (See 8.3)



8.2.2 STEER VALUE (STR)

Displays steer value for the selected steer reference function(See 8.3 and 9.3).



8.2.3 (SOG) and (COG)

Speed over ground (SOG) and course over ground (COG).

Alternating function. To stop alternating, press **SET**. To restart alternating, press **SET** again.



8.2.4 (BTW) and (DTW)

Bearing to waypoint (BTW) and distance to waypoint (DTW):For function explanation, see drawing inside cover page.

To display this function, you must navigate towards a waypoint.

Alternating function. To stop alternating, press **SET**. To restart alternating, press **SET** again.

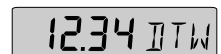
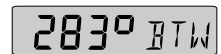

8.2.5 LATITUDE and LONGITUDE (POS)

Displays position in selected format. Select format from degrees/minutes and 100:th of a minute (indicated by decimal (.) and minute (') signs) or from format degrees/minutes/seconds (indicated by minute (') sign only). (See 12.3.9, C38).

Alternating function.

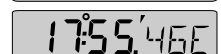
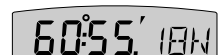

To stop alternating, press **SET**. To restart alternating, press **SET** again.

8.2.6 SET and DRIFT

Direction of current (SET) and speed of current (DRF).
Alternating function. To stop alternating, press **SET**.
To restart alternating, press **SET** again.

240° SET

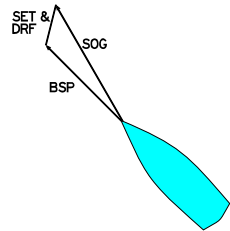

8.2.7 (CMG) and (DMG)

Course made good (CMG) and distance made good (DMG)
The function is based on the principle of dead reckoning.
The function keeps track of the boat's way through the water and displays course and distance in a straight line from the start position.

279° CMG

Locate and mark your position and reset CMG/DMG. Get underway.
To find your new position, plot the course and distance on your sea chart.

The function starts at power on.
To reset (CMG/DMG), press **CLEAR**.
When the **MOB** button is pressed it temporarily resets the CMG/DMG function.
Alternating function. To stop alternating, press **SET**.
To restart alternating, press **SET** again.

8.2.8 WAYPOINT CLOSURE VELOCITY (WCV)

Displays the speed over ground towards the waypoint in (KTS), (Km) or (Mh), (see 12.1.2, C11).
The text alternates between (WCV) and the selected (unit).

4.02 WCV

8.2.9 CROSS TRACK ERROR (XTE)

Distance in nautical miles (NM) to desired track.
To display this function, you must navigate towards a waypoint.
Your boat is the "triangle" symbol and the desired track line is represented by the "3 vertical lines". The "triangle" symbol will tell you on which side of the desired track you are. You should aim to

0.05 Δ|||

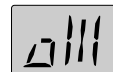

steer your boat so that the display readout is 0.00 NM, which means you are on the desired track.

8.3 Steer reference (Pilot)

The sub-function (Pilot) is intended to be used together with the optional analogue instrument steer pilot (Art. No. 20550-2) to assist the helmsman to keep the desired heading.

The powerful combination of the Multi Control instrument together with the analogue steer pilot actually offers you 6 functions.

Compass steering: (MEM)

1. Compass steering, using the 1 memory.
2. Headers and lifters, using the 2 memories and trim button. (See 9.3)

Wind steering: (AWA)

3. Close hauled indicator, ex. 35°
4. Down wind indicator, ex. 175°

Waypoint steering:

5. Bearing To waypoint (BTW)
6. Course To Steer (CTS), including set and drift

When a steer reference has been selected the analogue steer pilot instrument is immediately activated. It starts to indicate the difference between desired and actual heading or angle. The logic is to keep the steer pilot instrument needle straight up pointing at zero (0) to stay on the set heading.

From analogue steer pilot instrument version 2.0, (MEM) and (BTW) is functioning with COG (if navigator connected) even if a compass is not installed. The analogue read out will start at speed above 4KTS and stop below 2 KTS.

If you do not have the analogue steer pilot instrument, you can still use the function, if you display the selected steer reference heading (STR) in the sub-function and compare it with the actual compass heading in the main-function.

A NX2 autopilot can not be activated from the steer reference function. But when the NX2 autopilot has been activated in compass or wind mode it is possible to alter the autopilots heading from the (MEM) and (AWA) functions.

The last used steer reference function will be stored in memory and automatically activated at power on. (Available Server version 2.6)

8.3.1 Overview of steer reference (Pilot)

Steer reference function	Reference type	Text on display
(MEM)=Compass heading stored in 1 or 2 memories (TAC)	Manual	M E M
(BTW)=Bearing to waypoint	Automatic	W P
(CTS)=Course to steer to waypoint, corrected for drift and current	Automatic	M E M W P
(AWA)=Apparent wind angle	Manual	W I N D
(OFF)=Steer pilot off		

When any steer reference function is activated, the text on the display will be copied and shown on all Multi Control instruments in your Nexus Network.

8.3.2 Steer reference (MEM)

This function requires the NX2 or NMEA compass transducer. The function is semi automatic, i.e. when activated, present compass heading is copied to memory. You can later change the value manually.



Select sub-function (Pilot), press **SET**.

The text (OFF) or the last selected steer reference function flashes.

To select steer reference (MEM), press **PLUS**.

To activate the function, press **SET**. MEM is shown on the display.

The sub-function (STR) automatically displays the stored (MEM) value.

The text (MEM) and (STR) is alternating.

If you want to change the steer reference value, press **SET**.

The first digit flashes.

To set the new value press **MINUS**, **PLUS** and **PAGE** as required.

To store the value, press **SET**.

Note: Steer reference heading value (MEM) can also be selected directly from the optional trim button, without first selecting (MEM)

in (Pilot OFF) function. (Available from Server software version 1.9.)

8.3.3 Steer reference (BTW)

This function requires the NX2 or NMEA compass transducer and a NX2 GPS or NMEA navigator.

When selected, the function displays (BTW) and the analogue steer pilot instrument displays the difference between the compass heading and the bearing to waypoint (BTW).

The function can only be displayed if the connected navigator is navigating towards a waypoint.

Since the displayed value is controlled by the navigator, the value can not be altered.



Pilot BTW

Select sub-function (Pilot), press **SET**.

The text (OFF) or the last selected steer reference function flashes.

To select steer reference (BTW), press **PLUS**.

To activate the function, press **SET**. WP is shown on the display.

The sub-function (STR) automatically displays the stored (BTW) value.

8.3.4 Steer reference (CTS)

This function requires log transducer, NX2 or NMEA compass transducer, NX2 GPS or NMEA navigator.

When selected the function displays (CTS) and the analogue steer pilot instrument displays the difference between the compass heading and the bearing to waypoint (CTS) including set and drift.

The function can only be displayed if the connected navigator is navigating towards a waypoint.

Since the displayed value it is controlled by the navigator, the value can not be altered.

The function is compensated for set and drift, by using the parameters compass heading, boat speed through the water, course and speed over ground (COG/SOG) and bearing to waypoint (BTW).

Select sub-function (Pilot), press **SET**.

The text (OFF) or the last selected steer reference function flashes.

To select steer reference (CTS), press **PLUS**.

To store the function, press **SET**. MEM WP is lit on the display.

The sub-function (STR) automatically displays the stored (CTS) value.

The text (CTS) and (STR) is alternating.

The function is invaluable when you want to sail the shortest distance to a waypoint.

8.3.5 Steer reference (AWA)

This function requires the NX2 or NMEA wind transducer.

The function is semi automatic, i.e. when activated, present wind angle is copied to memory. You can also change the value manually.

The function displays the deviation from a set wind angle value and can be used as a "close hauled" tack indicator, or show an enlarged "picture" of the running angle.

Select sub-function (Pilot), press **SET**.

The text (OFF) or the last selected steer reference function flashes.

To select steer reference (AWA), press **PLUS**.

To store the function, press **SET**. WIND is shown on the display.

The sub-function (STR) automatically displays the stored (AWA) value.

The text (AWA) and (STR) is alternating.

If you want to change the steer reference value, press **SET**.

The first digit flashes.

The underlining sign () = starboard side. The minus sign (-) = port side.

To select value, press **MINUS**, **PLUS** and **PAGE** as required.

To store the value, press **SET**.

When the steer reference function (AWA) is used together with the analogue steer pilot instrument, you can display an enlarged "picture" of the tacking or run angle. Put simply, you "expand" the wind angle.

Use the analogue steer pilot as a "close hauled" instrument.

Example: You have selected 35° starboard side (35° | - STR) as your tacking angle.

When the needle on the analogue steer pilot instrument points straight up to zero (0), you steer at the selected 35° wind angle.

You can of course also use the (AWA) function when running down wind, to keep a selected value for the run angle and/or to warn for a gibe.

Example: You have selected 160° port side (160° -| STR) as your running angle. When the needle on the analogue steer pilot instrument points to 15° port side you are at 145°. When the needle is at zero (0) you are at 160°. When the needle points 15° starboard you are at 175°.

At night, when you can not see the wind shifts, the use of the (AWA) function together with the analogue steer pilot is a very helpful.

This is a dynamite function that allows you to "expand" the wind angles!!!

When a NX2 Autopilot is activated in wind mode, the (AWA) function on the Multi Control instrument can be used to perform an automatic tack.

The minus sign (-) in front of the wind angle value = port side.

The underlining sign () in front of the wind angle value = starboard side.

Simply change the value of the digit in front of the wind angle, and the NX2 Autopilot will gibe to the opposite tack.

9 Wind functions

9.1 WIND Main-function

Apparent wind angle (AWA), true wind angle (TWA) 000° - 359°, apparent wind speed (AWS) or true wind speed (TWS):



Note! This page can either be on or off. As a factory setting this page is automatically on if a Compass transducer or GPS is connected. In the set up, you can select this page to be on, off or automatic on. See chapter: 12.5.2

The main-function WIND, allows you to display wind angle or wind speed, true or apparent. The wind angle is indicated by a symbol to the right of the wind angle value:

-| = Wind from port side.

| - = Wind from starboard side.

The type of wind true or apparent, is indicated by a letter:

A = Apparent wind .

T = True wind.

The selection of apparent (AWA) or true (TWA) wind angle in the main function also controls what is displayed on the optional analogue wind instrument (art. no 20550-1).

When the instrument is delivered, the factory setting for the main function is apparent wind angle (AWA). (See 12.5.3, C51 and C63).

9.2 WIND Sub-functions

9.2.1 STEER REFERENCE (Pilot OFF)

Displays the selected steer reference function. This function also controls what is shown on the optional analogue steer pilot instrument (Art No 22115-02). Steer reference can be selected from 5 alternatives. (See 8.3)



9.2.2 STEER VALUE (STR)

Displays steer value for the selected steer reference function(See 8.3).



9.2.3 APPARENT WIND SPEED (AWS)

Units displayed in m/s (m/s), knots (KTS) or Beaufort (BF), (see 12.5.4, C53). The function alternates between (AWS) and the selected (units).



9.2.2 TRUE WIND ANGLE (TWA)

This function requires a log transducer. The complimenting function to what is displayed in the main function is displayed.



If the main function is set to display apparent wind angle (AWA), the true wind angle (TWA) will be displayed here.

If the main-function is set to display true wind angle (TWA), the apparent wind angle (AWA) will be displayed here.

If the main-function is set to display apparent wind speed (AWS), apparent wind angle (AWA) will be displayed here.

If the main-function is set to display true wind speed (TWS), true wind angle (TWA) will be displayed here.

9.2.4 TRUE WIND SPEED TWS

This function requires a log transducer. Displayed in m/s (m/s), knots (KTS) or Beaufort (BF). (See 12.5.4, C53). The text alternates between (TWS) and the selected (unit)



9.2.5 VELOCITY MADE GOOD (VMG)

Displays speed into the wind or speed running with the wind in (KTS), (Km) or (Mh), (see 12.1.2, C11). See drawing.

The text alternates between (VMG) and the selected (unit).

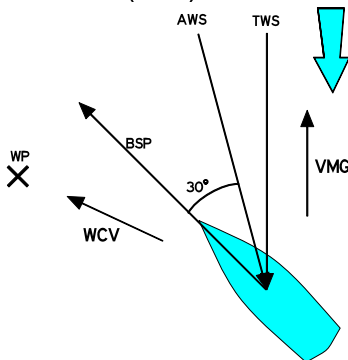

9.2.6 TACTICAL FUNCTION (TAC)

Displays heading memory, one for starboard and one for port tack. (For function explanation, see 9.3).



9.2.7 GEOGRAPHIC WIND DIRECTION

This function requires a compass transducer. Displays the direction in 000° to 359° and the each cardinal point abbreviation as shown:

226° SW

000.0° = N
 022.5° = NNE
 045.0° = NE
 067.5° = ENE
 090.0° = E
 112.5° = ESE
 135.0° = SE
 157.5° = SSE
 180.0° = S
 202.5° = SSW
 225.0° = SW
 247.5° = WSW
 270.0° = W
 292.5° = WNW
 315.0° = NW
 337.5° = NNW

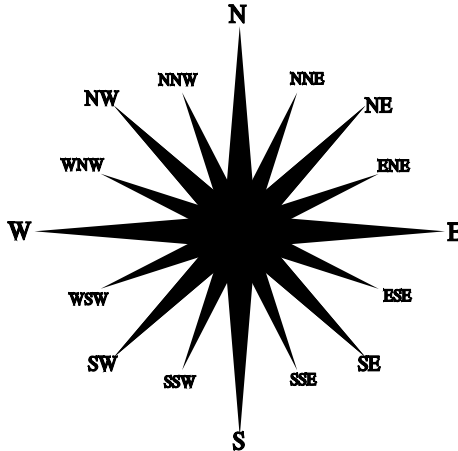

If magnetic heading is selected, geographic wind direction will also be magnetic direction. (See 12.3.4, C33)

9.3 Tactical function

This function requires a compass transducer and displays course memory. One for starboard and one for port tack.

To fully use the tactical function it is recommended to install the optional trim button (Art. No. 19763) and analogue steer pilot instrument (Art. No 22115-02). The trim button is usually installed close to the steering position. Many prefer to install one trim button on each side of the boat, that is one for each tack. (For installation of trim button, see Server manual). Your apparent tack angle is assumed to be constant, in that your magnetic heading will be changed compared to the wind, that is you will be changing your heading due to the wind shifts.

The tactical function will give you a fast and exact information about any wind shift compared to the magnetic heading.

EXAMPLE NEXUS "TAC" FUNCTION

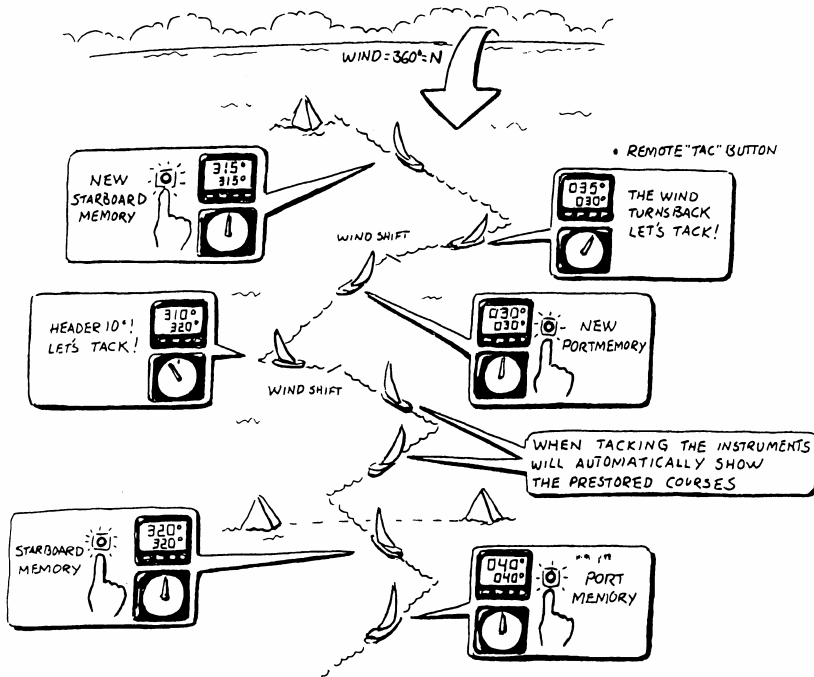

Select sub-function (TAC).

When you have maximum "lift", press **SET** (or the trim button) to store the value. When the wind "heads" more than 5-10* it is time to tack.

Follow the same procedure on the new leg. The reference value for the selected tack, will be changed every time you press **SET**

(or the trim button). When you tack, the reference value of the last leg will automatically be displayed.

If the optional analogue steer pilot instrument connected, select sub-function pilot (MEM), as steer reference (See 8.3.2).

The deviation from selected course will be displayed on the analogue steer pilot instrument.

If you do not have the optional trim button or analogue steer pilot connected, we suggest you move the sub-function (TAC) to the NAVIGATE page. Now you can display both the heading and the tactical reference (TAC) at the same time.

Remember to turn off the off course alarm. To turn off the off course alarm, set C32 to (00), (See 12.3.3, C32).

10 Man over board (MOB) function

This function will guide you back to the position where the man over board (MOB) button was pressed.



This function requires either a navigator (a NX2 GPS or NMEA navigator can be used) or a speed and compass transducer as well as a man over board (MOB) button. (See Server Manual).

If only a compass and a speed transducer is connected, dead reckoning (MOB) will be displayed on both the Multi Control and the SPEED Log instruments. Dead reckoning (MOB) is also a very useful information, since a person in the water will drift almost as fast as the boat.

If a navigator, a compass and a log transducer is connected, dead reckoning (MOB) will be performed and displayed in the SPEED Log instrument. At the same time the Multi Control instrument will display (MOB) relative position stored in memory when the (MOB) button was activated. A position in latitude and longitude is more important for the sea rescue service.

The (MOB) position is automatically stored in waypoint number 99, and over writes any earlier stored position.

To activate the MOB function, press the (MOB) button.

A fixed alarm signal will sound briefly to alert the crew. The text (MOB) flashes.

Off course error will be displayed in the main-function.

└- = steer to starboard. -┘ = steer to port.

Distance to the MOB position will be displayed in the sub-function. All you have to do is to keep calm and steer the boat in the indicated direction and distance to pick up your wet crew member. To reset the (MOB) function, press **CLEAR**.

The earlier calculated course (CMG) and the distance made good (DMG) is not affected by the (MOB) function.

If a NX2 GPS and the analogue steer pilot instrument is connected the analogue instrument will indicate (MOB) course difference with priority to GPS position over dead reckoning position.

Note: It is wise to practice this manoeuvre with the crew. Everyone in the crew should be aware of the (MOB) routine. When you practice, it can be thoughtful to use a fender instead of a crew member!!!

11 Customise your display

All sub-functions are organised in a list under the main-function. The first location in the sub-function list is an empty display. You can have your favourite sub-function moved in the same sub-function list, or copied and locked to any other page.

11.1 Move and lock a sub-function

Example: In SPEED page, move and lock the sub-function depth (DPT) to the top of the sub-function list.

Select the SPEED page and find the sub-function depth (DPT). Press **PAGE** and **SET** together.

All digits flash.

To move and lock the sub-function press **SET**.

Each time the SPEED page is selected, the sub-function (DPT) will be displayed at the top of the sub-function list.

11.2 Copy and lock a sub-function

Example: Copy and lock the sub-function true wind speed (TWS) from WIND page to SPEED page.

Select WIND page and find the sub-function (TWS).

Press **PAGE** and **SET** together.

All digits flash.

To move and copy to SPEED page, press **PAGE**.

To lock the function, press **SET**.

Each time the SPEED page is selected,

the sub-function (TWS) will be displayed.

The copied sub-function remains in its original location. It is only copied to a second location, where it takes the place of the empty sub-function in the list.

Note: The sub-function damping (SEA) should not be moved, to avoid misunderstanding.

11.3 Select power on function

The last selected combination of page and sub-functions according to your selection in 11.1 is the first page the instrument will display at power up.

11.4 Cancel a moved or locked sub-function

Example: To cancel the previous moved sub-function true wind speed (TWS) from SPEED page.

Select the new combination, SPEED page and sub-function (TWS).

Press **PAGE** and **SET** together.

All digits flash.

To cancel the moved sub-function, press **CLEAR**.

The sub-function is cancelled and the main-function still flashes.

To return the to the original display, press **SET**.

11.5 Temporary locking of alternating functions

Some functions will alternate automatically between two functions.

Example bearing to waypoint (BTW) and distance to waypoint (DTW).

To stop alternating, press **SET**.

To continue alternating, press **SET** again.

12 Calibration

To get the most out of your Nexus Network, it is important to carefully calibrate the Network. The calibration values are stored in a non volatile memory.

To access calibration mode, press and hold **SET** more than 2 seconds.

To select a calibration code, press **MINUS**, **PLUS** and **PAGE** as required.

To return to normal mode, press **SET** when the text return (RET) is displayed.

The different calibration routines are divided into five groups:

- C10 - calibration of SPEED
- C20 - calibration of DEPTH
- C30 - calibration of NAVIGATE
- C50 - calibration of WIND
- C70 - calibration of Network and NMEA settings

To change a calibration value, press **SET**.

To select calibration value, press **MINUS**, **PLUS** and **PAGE** as required.

To lock the selected value, press **SET**

12.1 Calibration of speed C10

12.1.1 C10 Return (RET)

To return to normal mode, press **SET**.

12.1.2 C11 (Unit KTS)

Unit for speed. Knots (KTS), km/h (K/h) or miles/h (m/h).

12.1.3 C12 (1.25 CAL)

Calibration value for speed and distance (1.00 - 1.99).

Drive the boat a measured distance at normal speed.

Compare the distance with the trip counter.

Calculate the value with the following formula:

True distance from the sea chart :	T
Log trip counter distance:	L
The current calibration value:	C
New calibration value.	N

$$\frac{T}{L} \times C = N$$

If you suspect a current in the water, drive the boat in both directions and divide trip counter distance by 2.

12.1.4 C13 DAMPING (SEA)

Damping of indicated boat speed through the water. Controls the response time of speed changes.

To change damping, press **SET**.

To select damping level, press **PLUS** and select from:

d0 (Min) to **d9** (max).

To store the value, press **SET**.

Default value is (**d0**), for use in calm sea. But if the sea is rough, you may want to "stabilise" the readout on the display, then select (**d1**) to (**d9**).

Note! Damping is set separately for each instrument.

**12.2 C20, calibration of depth****12.2.1 C20 (RET)**

To return to normal mode, press **SET**.

12.2.2 C21 (Unit m)

Unit for depth. Metre (m), feet (Ft) or fathoms (FA).

12.2.3 C22 (- 00.0 ADJ)

Calibration of the depth transducer position.

This option is used to select whether the displayed water depth is measured from the water level or the keel.

To measure from the keel, use the minus (-) sign.

Example: (- 01.2 ADJ). The distance from the transducer to the keel is 1.2 m

To measure from the water surface, use the underlining character (_) sign.

Example: (_ 00.4 ADJ). The distance from the transducer to the water surface is 0.4 m.

The selected value will be subtracted or added from the measured depth.

12.2.4 C23 (Unit°C)

Unit for temperature. Celsius (C) or Fahrenheit (F).

12.2.5 C24 (0°C TMP)

Value for compensation of the temperature.

To add, use underlining character (_) ahead of the digit (_1 TMP).

To subtract, use minus character (-) ahead of the digit (-1 TMP).

12.2.6 C25 (Unit hPA)

Future function. Unit for air pressure. Hecto Pascal (hPa) or Inch HG (INH).

12.3 C30, calibration of navigation

12.3.1 C30 (RET)

To return to the normal mode, press **SET**.

12.3.2 C31 (PAGE ATO)

This setting allows you to display the Navigate page or not.

PAGE ATO Page automatically on if Compass transducer or GPS is connected

PAGE ON Page is always on

PAGE OFF Page is always off

12.3.3 C32 (00° OCA)

Off Course Alarm. Can be set between 00° and 99° (00°) = Alarm is turned off.

12.3.4 C33 (00.0 VAR)

Magnetic variation. Maximum +/- 99.9°.

Easterly variation = underlining (_) sign.

Westerly variation = minus (-) sign.

The local magnetic variation is usually printed in the sea chart.

12.3.5 C34 (Auto DEV)

Automatic compass deviation, (see 12.4.1).

12.3.6 C35 (Auto CHK)

Check of automatic compass deviation, (see 12.4.2).

12.3.7 C36 (Auto CLR)

Clear automatic compass deviation memory, (see 12.4.3).

12.3.8 C37 (000° ADJ)

Compass transducer misalignment correction, (see 12.4.4).

12.3.9 C38 (OFF SEC)

Format of position in latitude and longitude.

(OFF) = Position in degrees, minutes and 100:th of a minute.

Indicated by the sign (.) after the minute.

(ON) = Position in degrees, minutes and seconds.

No sign (.) after the minute.

12.3.10 C39 (Pilot SEA)

Damping for the optional analogue steer pilot instrument.

LOW = 1.3 sec, MID = 2.8 sec. and MAX = 11 sec.

(Available for analogue steer pilot instruments, from version 1.3).

12.3.11 C40 (OFF MAG)

(Available from Multi version 2.0)

(ON) = All headings and bearings will be magnetic.

(OFF) = All headings and bearings will be true.

Note a: In the (Goto WP) function, the bearing for every leg will always be displayed as true bearing.

Note b: The setting is only affects the independent Multi Control instrument in which is set.

12.3.12 C41 DAMPING (SEA)

Damping of compass heading.

Controls the response time of heading changes.

To change damping, press **SET**.

To select damping level, press **PLUS** and select from:

d0 (Min) to **d9** (max).

To store the value, press **SET**.

Default value is (**d0**), for use in calm sea. But if the sea is rough, you may want to "stabilise" the readout on the display, then select (**d1**) to (**d9**).

Note! Damping is set separately for each instrument.



12.4 Compass calibration

12.4.1 Automatic compass deviation compensation (Auto DEV)

(Auto DEV) is performed by driving the boat in a circle up to 1¼ turn, so that the magnetic deviation can be measured, and by that compensated.

Select calibration code C33 (Auto DEV).

Drive the boat in a circle for 1 ¼ turn in calm water. When you start the circle manoeuvre, press **SET**.

The un-deviated compass course will be shown in the display as you turn. Complete the circle up to 1 ¼ turn.

When the manoeuvre is ready, press **SET** to store the deviation value.

If the deviation is corrected (Auto DEV) will be displayed.

If the deviation is not corrected, an error message will be displayed.

To verify the automatic compass deviation, perform an automatic compass check (Auto CHK), (see 12.4.2).

Note: You will get the best result in calm water with a smooth turn on the steering wheel independently of how the circle is performed. When activated, you can stop the automatic compass deviation at any time with a press on **CLEAR**.

12.4.2 Automatic compass deviation check (Auto CHK)

(Auto CHK) is done by driving the boat in a circle up to 1 ¼ turn, after (Auto DEV) is performed. The result will be compared with (Auto DEV). If the deviation is less than 1,5*, the average value from the comparison between (Auto DEV) and (Auto CHK) will be stored.

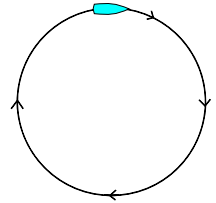

If the check is OK, (Auto CHK) will be displayed.
If not an error message will be displayed.

Select automatic compass check (Auto CHK), press **SET** and repeat the same circle manoeuvre as described in the (Auto DEV) routine.

Note: As soon as you place any kind of ferrous items close to the compass, the (Auto DEV) / (Auto CHK) routines should be repeated. So if you have packed your boat for the vacation, think about where you place ferrous items in relation to the compass transducer.

12.4.3 Cancel earlier performed compass deviation (Auto CLR)

To cancel earlier (Auto DEV), press **SET**.

12.4.4 Compass misalignment correction (Adj)

Compass transducer misalignment correction or the so called "A-fault".

Can be set between 000° and 359°. Allows 180° reversed mounting if needed. Never mount the transducer in a 90° position relative to the boats fore-aft line.

To check the transducer position, sail/drive your boat in a straight line towards two visible objects in a line. If the actual heading taken from the sea chart is 330° and the compass displays 335°, then set calibration code C36 value to $360° - 5° = 355°$.

12.5 C50, calibration of wind

12.5.1 C50 (RET)

To return to the normal mode, press **SET**.

12.5.2 C51 (PAGE ATO)

This setting allows you to display the Navigate page or not.

PAGE ATO	Page automatically on if Compass transducer or GPS is connected
PAGE ON	Page is always on
PAGE OFF	Page is always off



12.5.3 C52 (OFF TWA)

Select true (TWA) or the apparent wind angle (AWA) as main-function under WIND. The optional analogue wind instrument will display the same selection. All Multi Control instruments which have the calibration code C63 set to (WIA) will display what is selected in C51.

C51 (OFF) = Apparent wind angle displayed.

C51 (ON) = True wind angle displayed.

12.5.4 C53 (Unit m/s)

Unit for wind speed. Metre/second (m/s), knots (KTS) or Beaufort (BF).

12.5.5 C54 (1.70 CAL)

Use 1.50 for a single fin transducer (with two propeller blades)

Use 1.70 for a twin fin transducer (with three propeller blades)

12.5.6 C55 (000° ADJ)

Mast top unit misalignment adjust value or the so called "A-fault", makes it possible to choose any horizontal angle.

Example: If the wind angle is +4° when you sail/drive the boat straight into the wind. Set the calibration channel C54 to 356°.

12.5.7 C56-C63 Wind calibration values

In channels C55 to C62 you set the calibration values for the mast top unit. Each mast top unit is individually calibrated for best accuracy.

See the separate wind calibration certificate supplied with each mast top unit. Each of the inter-cardinal directions are calibrated:

C55 (000° 000)

C56 (045° 045)

C57 (090° 090)

C58 (135° 135)

Set the calibration values according

C59 (180° 180) to the calibration certificate.
 C60 (225° 225)
 C61 (270° 270)
 C62 (315° 315)

12.5.8 C64 (WIA)

Select from 5 functions. (WIA) is the factory setting.
 Select the function to be displayed as main-function under WIND.
 The optional analogue wind instrument will display the same selection.
 Select from 5 functions. (WIA) is the factory setting.

If the selected main-function is an angle, the sub-function will show the complimenting angle, e.g. if (AWA) is selected as main-function, (TWA) will be shown as sub-function and vice versa.

If the selected main-function is a wind speed, the sub-function will show the corresponding angle, e.g. if (AWS) is selected, (AWA) will be shown as the sub-function and vice versa for (TWS) and (TWA).

(WIA): True (TWA) or apparent wind angle (AWA).
 Depending on what is set in C51, (ON = True, OFF = Apparent).

(AWA): Will display apparent wind angle (AWA) in this instrument independent of what is set in C51.

(TWA): Will display true wind angle (TWA) in this instrument independent of what is set in C51.

(AWS): Will display apparent wind speed (AWS) in this instrument independent of what is set in C51.

The letters (AW) will be displayed to the right of the wind speed.

(TWS): Will display true wind speed (TWS) in this instrument independent of what is set in C51.

The letters (TW) will be displayed to the right of the wind speed value.

12.5.9 C65 DAMPING (SEA)

Damping of True wind Direction. Controls the response time of wind changes. To change damping, press **SET**. To select damping level, press **PLUS** and select from: **d0** (min) to **d9** (max). To store the selected value, press **SET**.

Factory value is (d0), for use in calm sea. But if the sea is rough, you may want to "stabilise" the readout on the display, then select **d0** to **d9**.

Note! Damping is set separately for each instrument.



12.5.10 C67 WIND SPEED ALARM (WSA)

To set a wind speed alarm level. The buzzer will sound when the true wind speed is higher than the set level. To switch of the alarm, set C67 to 00. To silence an alarm, press any key.

The alarm level is set from 1 to 50 m/s.

To set the alarm level, press **SET**. To select level, press **PAGE**, **PLUS** or **MINUS** as required. To store the selected value, press **SET**.

Note! The Alarm level is always set in m/s regardless of unit used for displaying!

If the set alarm level is reached and the alarm is silenced, the wind speed must drop below 50% of the set alarm level to be activated again.

12.6 C70, calibration of Network and NMEA

When calibration code C70 is selected, the LCD arrows for all functions will be displayed

12.6.1 C70 (RET)

To return to the normal mode, press **SET**.

12.6.2 C71 (OFF KEY)

(On) = Sound when push buttons are pressed. (OFF) = no sound.

12.6.3 C72 (d0 SEA)

Damping of speed and course over ground (SOG/COG), affecting the complete Nexus Network and NMEA output.

d0 = no damping. d1 = 2 sec, d2 = 5 sec, d3 = 10 sec, d4 = 20 sec, d5 = 40 sec, d6 = 1.20 min, d7 = 2.40 min, d8 = 5 min and d9 = 10 min.

12.6.4 C73 (OFF BSP)

(OFF) = NX2 log transducer. (On) = NMEA log transducer.

If you want to use a NMEA transducer (connected to the NMEA input, you have to set C73 to On. The Server will then transmit this information on the Nexus Network to all connected instruments.

After you have changed this setting, you have to restart the system

12.6.5 C74 (OFF DEP)

(OFF) = NX2 depth transducer. (On) = NMEA depth transducer.

If you want to use a NMEA transducer (connected to the NMEA input, you have to set C74 to On. The Server will then transmit this information on the Nexus Network to all connected instruments.

After you have changed this setting, you have to restart the system

12.6.6 C75 (OFF CMP)

(OFF) = NX2 compass transducer. (On) = NMEA compass transducer.

If you want to use a NMEA transducer (connected to the NMEA input, you have to set C75 to On. The Server will then transmit this information on the Nexus Network to all connected instruments.

After you have changed this setting, you have to restart the system

12.6.7 C76 (OFF WND)

(OFF) = NX2 wind transducer. (On) = NMEA wind transducer.

If you want to use a NMEA transducer (connected to the NMEA input, you have to set C76 to On. The Server will then transmit this information on the Nexus Network to all connected instruments.

After you have changed this setting, you have to restart the system

12.6.8 C77 to C92

Contains 16 NMEA slots. (See 12.7.2)

12.6.9 C93 (d4 NME)

Damping for NMEA OUT from Server.

Only compass heading (HT/HM) and boat speed through water (BSP) can be damped with this code.

d0 = 0.5 sec, d2 = 1 sec, d3 = 2.5 sec, d4 = 5 sec, d5 = 10 sec,
d6 = 20 sec, d7 = .40 sec, d8 = 80 sec and d9 = 160 sec.

12.6.10 C94 (OFF COG)

Select type of heading transducer, compass or navigator (COG), to be displayed as main-function under NAVIGATE.

When COG is available (NX2 or NMEA), and no compass transducer is connected, you can set C94 to (ON), COG will also be used to compute TWD (true wind direction)

12.6.11 C95 (OFF SOG)

Select speed transducer to be displayed as **main-function** under SPEED.

(OFF) = Boat speed through the water from log transducer.

(ON) = Speed Over Ground (SOG) from navigator. This will not affect wind calculation, see 12.6.12

12.6.12 C96 (REF BSP)

Select speed transducer (REF BSP) or Speed Over Ground (REF SOG) to be used for computing true wind speed and angle, VMG, True Wind Direction and trip log, total log and distance.

(REF BSP) = Boat speed through the water from log transducer.

(REF SOG) = Speed Over Ground (SOG) from navigator.

12.7 NMEA

12.7.1 Transmit NMEA sentences OUT from Server

Calibration code C77 to C92 contains 16 NMEA slots

The Server supports 29 different NMEA sentences.

This means you can select up to 16 of the 29 available NMEA sentences.

The Nexus Network uses the NMEA 0183 sentences, version 1.5 and 2.0. The number in brackets, example (C79), is the calibration code for the factory slot number given to the NMEA sentence.

0	(—)	No out signal
1	(APB)	Autopilot B
2	(BOD)	Bearing original destination
3	(BWC)	Bearing and distance to waypoint
4	(BWR)	Bearing and distance, dead reckoning
5	(C77) (DBT)	Depth measured from the transducer position
6	(DPT)	Depth
7	(C78) (GLL)	Geographic position
8	(GSA)	DOP and active satellites
9	(C79) (GSV)	Satellites in view
10	(C80) (HDM)	Compass heading, magnetic.
11	(C81,89) (HDT)	True heading
12	(MTW)	Water temperature
13	(C82) (MWD)	Wind direction and speed
14	(MWV)	Apparent wind speed and angle
15	(RMB)	Minimum navigation data
16	(RMC)	Minimum specific GPS- and TRANSIT-data
17	(RSA)	Rudder Sensor Angle
18	(C83) (RTE)	Route Not implemented
19	(C84) (VDR)	Set and drift
20	(VHW)	Speed and course through the water
21	(C85) (VLW)	Distance travelled through the water
22	(C86) (VPW)	Speed relative to the wind
23	(C87) (VTG)	Course Over Ground and Ground Speed.
24	(C88) (VWT)	True wind speed and direction
25	(C90) (WCV)	Waypoint closure velocity
26	(WPL)	Waypoint location Not implemented
27	(C91) (XTE)	Cross track error
28	(C92) (ZDA)	Time and date
29	(ZTG) & (UTC)	Time to destination or waypoint
30	(VWR)	Apparent wind speed and angle

Example of NMEA sentences:

```

$IIAPA,A,A,00.007,L,N,V,V,145.03,M,004
$IIAPB,A,A,00.007,L,N,V,V,147.53,T,004,147.52,T,,T*29
$IIBOD,147.53,T,145.03,M,004,000
$IIBWC,101515,5912.890,N,01812.580,E,147.52,T,145.02,M,15.649,N,004
$IIBWC,,,,,147.52,T,145.02,M,15.647,N,004
$IIBWR,101516,5912.890,N,01812.580,E,147.52,T,145.02,M,15.647,N,004
$IIDBT,293.52,f,089.47,M,048.36,F
$IIDPT,089.47,0.40
$IIGLL,5926.110,N,01756.171,E,101517,A
$IIHDM,026,M
$IIHDT,029,T
$IIMTW,19,C
$IIMWD,161.77,T,159.27,M,07.01,N,03.61,M
$IIMWV,133,R,07.03,N,A
$IIRMA,A,5926.110,N,01756.171,E,,,0.23,189.47,,,,*00
$IIRMB,A,00.007,L,000,004,5912.890,N,01812.580,E,15.647,147.52,,V*01
$IIRMC,101340,A,5926.115,N,01756.172,E,0.04,063.42,,,*06
$IIVDR,063.42,T,060.92,M,0.04,N
$IIVHW,029,T,026,M,00.00,N,00.00,K
$IIVLW,49626.59,N,,
$IIVPW,0.00,N,,
$IIVTG,063.42,T,060.93,M,0.04,N,,
$IIVWR,133,R,07.03,N,03.62,M,,
$IIVWT,133,R,07.01,N,03.61,M,,
$IIWCV,0.00,N,004
$IIWPL,5503.000,N,01013.450,E,027
$IIXTE,A,A,00.003,L,N
$IIZDA,101341,,,,
$IIZTG,101341,,004
    
```

12.7.2 Change NMEA sentences OUT from Server

Before you change any of the factory set NMEA sentences, check what NMEA sentences can be received by your NMEA navigator.

Select the slot number for the sentence to be changed, then press **KEY**.

To select the sentence, press **DOWN** or **UP** until found.

To lock the selected sentence, press **KEY**.

One of the advantages with the Nexus Network is the very fast transmission speed of data compared to the relatively slow NMEA standard (about 10 times faster). Therefore we recommend that you use Nexus instruments and transducers for better accuracy.

It takes two seconds to transmit all 16 NMEA sentences.

To double the transmission speed, select a NMEA sentence 2 times with 7 slots apart, that is the slots should be as far away from each other as possible.

In a similar way, you can select the a sentence 4 times to make it 4 times faster.

Example: If you want to transmit the Nexus compass heading via NMEA, for example an autopilot, select (HDM) for every odd slot number, C79, C81, C83 ... C93, that is 8 times which makes the speed 4 times / second. This leaves the

other 8 slots with even numbers, C78, C80, C82 ... C92 free to use for other NMEA sentences.

For connection of NMEA instruments OUT from Server, (see Server manual).

12.7.3 Receive NMEA sentences IN to Server

There are 6 different main types of NMEA sentences:

1) Position related data: Position, SOG/COG, time, and a limited amount of satellite status if a GPS is connected. The information is read if no other Nexus GPS is connected. If a Nexus GPS is connected, it will take over the navigation.

2) Navigation data: (BTW), (DTW), (BOD), (XTE), (SET) and (DRIFT).

The Server will automatically send data to the Nexus Network. E.g.: (DRIFT), (WCV), (TTG) and (CTS).

3) Speed data: is read only if (C73 BSP) is set to (ON). See 12.6.4

4) Depth data: is read only if (C74 DEP) is set to (ON). See 12.6.5

5) Compass data: is read only if (C75 CMP) is set to (ON) See 12.6.6. Heading is either (HDT) (priority) or (HDM). Magnetic variation (from Nexus Network) is added to (HDM) but not to (HDT).

6) Wind data: angle and wind speed is read from (MWV) data, only if (C76 WND) is set to (ON) See 12.6.7. True wind angle and wind speed is calculated by Nexus, when the boat speed (the speed of the water) is known.

The following NMEA sentences can be received IN to Server:

APA	Autopilot sentence "A"
APB	Autopilot sentence "B"
BOD	Bearing original destination
BWC	Bearing and distance to waypoint
BWR	Bearing and distance to waypoint (old)
DBT	Depth measured from the transducer position
DPT	Depth
GGA	Global positions fix data (GPS)
GLL	Geographic position, Latitude/Longitude
GSA	DOP and active satellites
GSV	Satellites in view
HDM	Heading, magnetic
HDT	Heading, true
MTW	Water temperature
RMB	Minimum navigation information
RMC	Minimum specific GPS/transit data
WCV	Waypoint closure velocity
VDR	Set & drift
VHW	Water speed and heading
MWV	Wind speed and direction
VTG	Course Over Ground and Ground Speed
XTE	Cross-track-error, measured
ZDA	Time & date

TBS	Target boat speed
CAD	Custom angular data
CFD	Custom fix data
RSA	Rudder Sensor Angle

For connection of NMEA instrument IN to Server, (see Server Manual).

All data (POSITION, BTW, SOG/COG, etc.) is received from one type of NMEA sentence. If data is placed in different locations, the data will be selected from the sentence with the highest priority.

Example I: Position is read in priority order: GGA, GLL and. RMC.

Example II: BTW/DTW is priority first with: RMB, BWC and BWR.

The transmission ID (the first two letters after "\$") is ignored by the Server. Present position is read, after that possible latitude and longitude correction is added (C39 and C40) before the position is sent over the Nexus Network to all instruments

12.8 Special NMEA sentences

The Server can read 2 special NMEA sentences which can be send from a PC. One contains TBS (target boat speed), the other CAD (customised angle data) and CFD (customised fixpoint data). These 3 data are retransmitted on the Nexus Network and can be displayed as a sub-function on the Multi Control instrument.

To get the sub-function TBS, select main function SPEED and the "empty" sub-function. Then press PAGE and SET together followed by CLEAR.

To get the sub-function CAD, select main function NAVIGATE and the "empty" sub-function. Then press PAGE and SET together followed by CLEAR.

To get the sub-function CFD, select main function WIND and the "empty" sub-function. Then press PAGE and SET together followed by CLEAR.

Example of special NMEA-sentence:

\$PSILTBS,X.X,N<CR><LF>

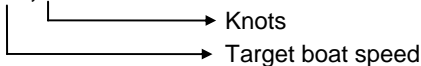

\$PSILCD1,X.X,X.X,<CR><LF>

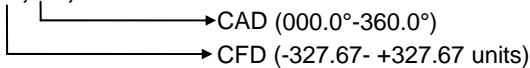

12.8.1 Baudrate control,

It is possible to change the baudrate from 4800bps to 19200bps.

To do that, a PC is required. Note 19200 is not to be considered as NMEA since the standard states 4800. See 12.8.1

a. The Requesting unit is allowed to transmit the message:

"\$PSILBPS,19200,R,<CR><LF>"

once every 2s at nominal 4800 bps with normal NMEA start bit and stop bit settings.

This message may be received on any of the two Server ports.

b. The receiving unit (NX2 Server) will Confirm message:

"\$PSILBPS,19200,C,<CR><LF>"

and send it back on output ports to the requesting unit.

c. When the requesting unit receives the same message but with the flag set to "C" (Confirmed), both server ports (A and B) are set to 19200bps and transmission may start at the new baudrate. The sending unit may now stop sending the proprietary request message since it has entered the higher baudrate. There is no way back unless there is a power loss.

From power up, baudrate is always set to 4800 and the above procedure must be repeated.

The receiving unit (Nexus Server) will always check for the proprietary message when in normal baudrate, not when in high baudrate.

13 Maintenance and fault finding

13.1 Maintenance

- To clean the instrument, use only mild soap solution and rinse with water.
- Do not use detergents or high pressure washing equipment.
- At least once a year, check all your connections and apply additional silicon paste at each connection point.
- Always use the instrument cover for protection, when not in use.
- Storing transducers and instruments when not in use for longer periods: It is advisable to remove the instruments and transducers, and store them inside the boat or at home in room temperature, if possible.



13.2 Fault finding

Before you contact your NX2 dealer, and to assist your dealer to give you a better service, please check the following points and make a list of:

- All connected instrument and transducers , including their software version numbers.
- Server software version number.
- Nexus Network data bus ID numbers for each instrument (displayed at power up).

13.2.1 General

In most cases, the reason for faults in electronic equipment is the installation or poor connections. Therefore, always first check that:

- Installation and connection is made per instructions for instrument and transducers, (see Server manual).
- Screw terminals are carefully tightened.
- No corrosion on any connection points.
- No loose ends in the wires causing short cuts to adjacent wires.
- Cables for damage, that no cables are squeezed or worn.
- Battery voltage is sufficient, should be at least 10V DC.
- The fuse is not blown and the circuit-breaker has not opened.
- The fuse is of the right type.
- Two instruments do not have the same ID number, (see 3.2).

13.2.2 Fault - action

1. Speed and distance functions: No reading (---)

- C95 (COG) should be OFF, if no navigator is connected.

For more information, see manual for NX2 Server.

Irregular values: Check the speed damping (SEA), (see 12.1.4).

2. Compass: No reading (---)

- C75 should be OFF, if no NMEA compass is connected.
- Make sure the (Auto DEV) routine is done correctly, (see 12.4.1)
- Make sure the transducer is not mounted upside down.
- The transducer cable should face down.
- Make sure transducer is aligned correctly, (see 12.4.4).

For more information, see manual for NX2 Server.

Irregular values: Check the compass damping (SEA), (see 12.3.12).

Make sure there are no ferrous items close to the transducer.

3. Wind: No reading (---)

- C76 should be OFF, if no NMEA wind is connected.

For more information, see manual for NX2 Server.

13.2.3 Error messages

The following error messages can appear on the display:

ERROR 2	Nexus Network is missing, check colour coded connections
ERROR 3	No data received within a given time.
ERROR 10	Range error caused by bad format e.g. 17° 70' East.
ERROR 11	Remote command that can not be performed.
ERROR 12	No response from, or missing navigator.
ERROR 13	Waypoint not defined.
ERROR 15	Functions not allowed in autopilot mode.
ERROR 16	Automatic deviation not possible due to NMEA compass selected.
ERROR 17	Automatic deviation check failed. Turn not completed, error larger than 1,5°.
ERROR 19	The boat probably hit a wave during turn. Error larger than 1,5°.

If other error messages than the above appears on the Multi Control instrument, contact your NX2 dealer.

14 Specifications

14.1 Technical specifications

Dimensions:	Multi Control instrument: 113 x 113 x23 mm (4.3x4.3 inch). Server: 110 x 165 x 30 mm. (4.3x6.5x1.2 inch)
Instrument cable:	8 m (26 ft).
Power supply:	12V DC (10-16V). The instruments are polarity protected
Power consumption at 12V:	Multi Control instrument: 0,08W with maximum lighting 0,8W. Server: 0,2W.
Temperature range:	Storage: -30°to +80°C (-22°to +176°F) Operation: -10° to +70°C(14°to +158°F)
Weight:	Multi Control instrument: 260 gram (9.17 oz). Server: 220 gram. (7.76 oz).
Enclosure:	Multi Control Instrument: Water proof Server: Splash proof

CE approval

The products conforms to the EMC requirements for immunity and emission according to EN 50 08-1.

14.2 Nexus Network introduction and user policy

Introduction:

The Nexus data bus is a multi talker multi receiver data bus specially designed for marine navigation applications. It utilises the RS485 standard with up to 32 senders and/or receivers to form a Local Area Network. Data is transmitted synchronously with 1 start-bit, 8-data-bits, 1 parity-bit, two stop-bits in 9600 baud.

User policy:

The Nexus data bus is open for new users and applications without a licence or a licence fee. The data bus is, however, the property of the manufacturer, which means the specification must be followed in order to protect the manufacturer's commitments to the Nexus data bus performance and safety.

For most PC-applications, the full duplex interface (Art. No. 21248), will be a very useful tool for monitoring real time data, to edit and store waypoints to PC-file or to Server and/or to the NX2 GPS. The interface is supplied with a cable for connection from PC to the Server or NX2 instruments and/or the NX2 GPS. A 9-pole D-sub connector is connected to the RS232 port on the PC.

14.3 Optional Accessories

Below find a selection of optional accessories available. Please contact your local NX2 dealer for more information.

NX2 Completes

22118-3	Multi Control instrument and Server, 8m cable
22118-2	Multi Control and Server with Speed Log and depth transducer, 8m cable
22118-1	Speed log with log transducer, 8m cable
22118-4	Wind Data, with transducer, 25m cable, mast bracket
22118-5	Compass Data, with transducer 35°, 8 m cable
22118-6	GPS Navigator, with GPS Antenna, 8+10m cable

NX2/Nexus Transducers

22120-1	Server compl with 3m power cables
20707	Log/Temp transducer, 8 m cable (for Nexus and Star)
19915-8	Depth transducer, 8m cable (for NX2 only)
21731	Compass transducer 35°, 8m cable
20860	Compass transducer 45°, 8m cable
20721	Wind transducer, 25m cable, mast bracket
20721-1	CF-wind transducer, Carbon Fibre, 1260mm long, 380g, no mast cable incl.
20594	Nexus mast cable 25m
21721	MTC (Mast Twist Compensation) box, 8m cable, for Wind Data instr.
69980	MRC (Mast Rotation Sensor Compensation) box
21970	GPS Antenna, with NMEA 0183 output
21735	Bracket for GPS Antenna and 35° Compass transducer for bulkhead mount

NX2 Digital Instruments (all supplied with 0.2m cable)

22117-1	Speed log instrument
22117-3	Multi Control instrument
22117-4	Wind Data instrument
22117-5	Compass Data instrument
22117-6	GPS Navigator instrument
22117-7	Autopilot instrument

NX2 Analog Instruments (all supplied with 0.2m cable)

22115-01	NX2 Analog Wind Angle
22115-02	NX2 Analog Steer Pilot
22115-03	NX2 Analog Speed Trim
22115-05	NX2 Analog Speed 0-16kts
22115-06	NX2 Analog Speed 0-50kts
22115-07	NX2 Analog Depth 0-200m
22115-08	NX2 Analog Depth 0-600ft
22115-09	NX2 Analog Rudder angle
22115-10	NX2 Analog Compass
22115-11	NX2 Analog GPS Speed 0-16kts
22115-12	NX2 Analog GPS Speed 0-50kts
22115-13	NX2 Analog GPS Course

Nexus Remote Control Instrument

21210	Remote Control Instrument (RCI), with Autopilot control, 5m cable, bracket
21218-1	Bracket Remote Control instrument
20966	Connector 4-pole, NEW model (Allows cable - cable connection)

Nexus Multi XL
21680-1 Multi XL instrument, 4m cable (RCI or Multi Center needed to control Multi XL)
21684-1 Multi XL Set, Multi XL instrument and Remote Control instrument
69995 Mast bracket XL, in aluminium for Multi XL and Nexus / Star 110x110mm instr.

NX2 GPS
22118-6 GPS Navigator, with GPS Antenna, 8+10m cable
22117-6 GPS Navigator instrument
21970 GPS Antenna, with NMEA 0183 output
20992-2 Bracket GPS Antenna, plastic with female thread 1" x 14 tpi
21735 Bracket for GPS Antenna and 35° Compass transducer for bulkhead mount

Nexus Autopilot components
22117-7 Autopilot instrument
21210 Remote Control instrument, with Autopilot control, 5m cable, bracket
22115-09 NX2 Analog Rudder angle

21035-2 Servo Unit A-1510, 8m cable
20860 Compass transducer 45°, 8m cable
21731 Compass transducer 35°, 8m cable
21036 Rudder Angle Transmitter RFU-25, 15m cable, ball joint linkage 230mm x 2
69981 Linear Rudder Angle Transmitter

21134 Pumpset PF-0.3 12V
21134-24 Pumpset PF-0.3 24V
21341 Pumpset PF-0.3S 12V, with solenoid
21341-24 Pumpset PF-0.3S 24V, with solenoid
21136 Linear Drive AN-23, stroke 229mm, peak thrust 680kg
69991-12 Integrated Linear Drive HP-40, stroke 254mm, peak thrust 500kg

14.4 Abbreviations

Abbreviation. Description

A	Angle
ADJ	ADJust
ANC	ANChor
ANC	ANChor alarm
Arrival	Arrival
ARC	Arrival Circle
AVS	Average Speed
AWA	Apparent Wind Angle
AWS	Apparent Wind Speed
BAT	BATtery
BF	BeauFort
BOD	Bearing Original Destination
BSP	Boat Speed
BTW	Bearing To Waypoint
C	Celsius
CE	Communaute Européenne
C10	Calibrate 10
CAL	Calibrate
CG	Course over Ground
CHK	CHeCK
CLR	CLear
CMG	Course Made Good
CMP	CoMPass
COG	Course Over Ground
CTS	Course To Steer
CU	Central Unit
d	differential
D/R	Dead Reckoning
DEFAULT	Factory setting
DEV	DEViation
DMG	Distance Made Good
DEA	DEpth Alarm
DPT	DePTH
DRF	DRiFt, Speed of current
DST	DiSTance
DTW	Distance To Waypoint
E	East
EDIT	EDIT
EMC	Electro Magnetic Compatibility
EN	European Norm
F	Fahrenheit
F1-F9	Figure of merit
FA	Fathoms
FT	FeeT

GLL

Geographic Latitude Longitude

GoTo	Go To
GPS	Global Positioning Network
HDM	HeaDing Magnetic
HDT	HeaDing True
HM	Heading Magnetic
HT	Heading True
id	Identity
Init	Initiation
Insert	Insert
Km	Kilometre per hour
KT	KnoTs
KTS	KnoTS
L	Local
LAT	LATitude
LCD	Liquid Crystal Display
LGD	Local Geodetic Datum
LOG	LOG
LON	LONgitude
LOW	LOW
MAX	MAX
m/s	metres per second
MEM	MEMory
Mh	Miles per hour
MID	MID
MN	Magnetic North
MOB	Man Over Board
m	metre
N	North
NAV	NAVigate
NM	Nautical Mile
NMEA	National Marine Electronic Association
NXT	NeXT
OCA	Off Course Alarm
RET	RETurn
Roll	Roll
S	South
S/A	Selective Availability
SAT	SATellite
SEA	SEA
SEC	SECOnds
SET	SET, Direction of current
SHA	SHallow Alarm
SOG	Speed Over Ground
STA	STArt

STR	STeeR
SW	South West
TAC	TACtical
TMP	TeMPerature
TRP	TRiP
TTG	Time To Go
TWA	True Wind Angle
TWS	True Wind Speed
UTC	Universal Time Co-ordinate
VAR	VARiation
VMG	Velocity Made Good
W	West
WCV	Waypoint Closure Velocity
WP	Waypoint
XTE	Cross Track Error
-	Minus
—	Plus
	Wind from port side
	Wind from starboard side
	The boat is left of the desired track
	The boat is right of the desired track

15 Warranty

WARRANTY

GENERAL

All our products are designed and built to comply to the highest class industry standards. If the products are correctly installed, maintained and operated, as described in the installation and operation manual, they will provide long and reliable service. Our international Network of distributors can provide you with the information and assistance you may require virtually anywhere in the world.

Please read through and fill in this warranty card and send it to your national distributor for product registration.

LIMITED WARRANTY

The warranty covers repair of defective parts due to faulty Manufacturing and includes labour when repaired in the country of purchase. The warranty period is stated in the product manual, and commences from the date of purchase. The above warranty is the Manufacturer's only warranty and no other terms, expressed or implied, will apply. The Manufacturer specifically excludes the implied warranty of merchantability and fitness for a particular purpose.

CONDITIONS

- The supplied warranty card and receipt with proof of purchase date, must be shown to validate any warranty claim. Claims are to be made in accordance with the claims procedure outlined below.
- The warranty is non-transferrable and extends only to the original purchaser.
- The warranty does not apply to Products from which serial numbers have been removed, faulty installation or incorrect fusing, to conditions resulting from improper use, external causes, including service or modifications not performed by the Manufacturer or by its national distributors, or operation outside the environmental parameters specified for the Product.
- The Manufacturer will not compensate for consequential damage caused directly or indirectly by the malfunction of its equipment. The Manufacturer is not liable for any personal damage caused as a consequence of using its equipment.
- The Manufacturer, its national distributors or dealers are not liable for charges arising from sea trials, installation surveys or visits to the boat to attend to the equipment, whether under warranty or not. The right is reserved to charge for such services at an appropriate rate.
- The Manufacturer reserves the right to replace any products returned for repair, within the warranty period, with the nearest equivalent, if repair within a reasonable time period should not be possible.
- The terms and conditions of the warranty as described do not affect your statutory rights.

CLAIMS PROCEDURE

Equipment should be returned to the national distributor, or one of its appointed dealers, in the country where it was originally purchased. Valid claims will then be serviced and returned to the sender free of charge.

Alternatively, if the equipment is being used away from the country of purchase, it may be returned to the national distributor, or one of its appointed dealers, in the country where it is being used. In this case valid claims will cover parts only. Labour and return postage will be invoiced to the sender at an appropriate rate.

DISCLAIMER

Common sense must be used at all times when navigating and the Manufacturer's navigation equipment should only be considered as aids to navigation.

The Manufacturers policy of continuous improvement may result in changes to product specification without prior notice.

File id:

WARRANTY CARD

TO BE RETURNED TO YOUR NATIONAL DISTRIBUTOR

OWNER:

Name: _____

Street : _____

City/Zip Code : _____

Country: _____

Product name:

Serial number:

	A	B	C	1	2	3	4	5	6	7
_____	<input type="checkbox"/>	<input type="checkbox"/>	<input type="checkbox"/>	<input type="checkbox"/>	<input type="checkbox"/>	<input type="checkbox"/>	<input type="checkbox"/>	<input type="checkbox"/>	<input type="checkbox"/>	<input type="checkbox"/>
_____	<input type="checkbox"/>	<input type="checkbox"/>	<input type="checkbox"/>	<input type="checkbox"/>	<input type="checkbox"/>	<input type="checkbox"/>	<input type="checkbox"/>	<input type="checkbox"/>	<input type="checkbox"/>	<input type="checkbox"/>
_____	<input type="checkbox"/>	<input type="checkbox"/>	<input type="checkbox"/>	<input type="checkbox"/>	<input type="checkbox"/>	<input type="checkbox"/>	<input type="checkbox"/>	<input type="checkbox"/>	<input type="checkbox"/>	<input type="checkbox"/>
_____	<input type="checkbox"/>	<input type="checkbox"/>	<input type="checkbox"/>	<input type="checkbox"/>	<input type="checkbox"/>	<input type="checkbox"/>	<input type="checkbox"/>	<input type="checkbox"/>	<input type="checkbox"/>	<input type="checkbox"/>
_____	<input type="checkbox"/>	<input type="checkbox"/>	<input type="checkbox"/>	<input type="checkbox"/>	<input type="checkbox"/>	<input type="checkbox"/>	<input type="checkbox"/>	<input type="checkbox"/>	<input type="checkbox"/>	<input type="checkbox"/>
_____	<input type="checkbox"/>	<input type="checkbox"/>	<input type="checkbox"/>	<input type="checkbox"/>	<input type="checkbox"/>	<input type="checkbox"/>	<input type="checkbox"/>	<input type="checkbox"/>	<input type="checkbox"/>	<input type="checkbox"/>

Date of purchase: _____ Date installed _____

Dealers stamp:

Tick here if you do not wish to receive news about future products

"QUICK GUIDE" • "SNABBGUIDE" • "KURZANLEITUNG" • "MODE D'EMPLOIS EXPRESS"

SPEED

6.05 KT

L	12345	TRP
L	12345	LOG
L	730	MAK
L	0.10	STA
L	1204	S2
L	456	RV5
L	12345	IST
L	23	TPT

PLUS

23 m

Li t OFF

S	133	BAT
D	30	SHR
D	300	TERR
C	270	HGT
L+S	20	TMP
GPS	0735	SQU
S	605	BSP
SW	OFF	TRM
		REM

NAV

270 HT

REAR

Pilot	OFF
280	STR
560	SOG
2830	BTH
5855	IBN
2480	SET
2790	CMG
402	WCY
005	KTE
1342	TTG

WIND

30 TA

Pilot	OFF
280	STR
102	RAWS
37	TWR
77	TWS
440	MGS
2260	SW

L=Log

D=Depth

C=Compass

N=Navigator

W=Wind

S=Server

↑ (+) ↓ (-) ↓

MULTI CONTROL

Copyright ©:
Nexus Marine AB
Kuskvägen 4, 191 62 Sollentuna, Sweden
Tel: +46 -(0) 8 – 506 939 00. Fax: +46 -(0) 8 -506 939 01
www.nexusmarine.se

22133-1 Edition 1

Free Manuals Download Website

<http://myh66.com>

<http://usermanuals.us>

<http://www.somanuals.com>

<http://www.4manuals.cc>

<http://www.manual-lib.com>

<http://www.404manual.com>

<http://www.luxmanual.com>

<http://aubethermostatmanual.com>

Golf course search by state

<http://golfingnear.com>

Email search by domain

<http://emailbydomain.com>

Auto manuals search

<http://auto.somanuals.com>

TV manuals search

<http://tv.somanuals.com>