

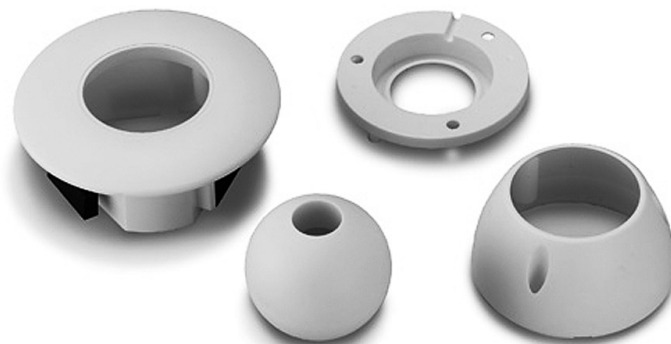

NILES®



INSTALLATION GUIDE



FOR USE WITH COLOR CCTV CAMERA
D O M E C A M E R A K I T

CAM-DFMK

CONGRATULATIONS!

Thank you for choosing the **CAM-DFMK Dome Camera Kit** from Niles. With proper installation and operation, you should enjoy years of trouble-free use.

Niles manufactures the industry's most complete line of custom installation components and accessories for audio/video systems. To see the complete Niles product assortment, visit us on the Internet at: **www.nilesaudio.com**.

TABLE OF CONTENTS

Introduction	2
Features	2
Installation Considerations	3
Limited Warranty	8
Warranty Registration Card	9

INTRODUCTION

NILES' CAM-DFMK Dome Camera Kit is designed to enhance the installation options of the CAM-PB Color CCTV camera (sold separately). Available in white or black, this unit enables flush-mount or surface-mount options for discrete, attractive CCTV camera installation. Please see the CAM-PB color CCTV Camera pre-wire and installation instructions for detailed specifications for the CAM-PB.

The dome assembly can be installed flush-mount or surface-mount depending on the application. Installers desiring stealthy, low-profile mounting should use the flush-mount option, while retro-fit applications take advantage of the surface-mount option. Hardware is included for both installation methods.

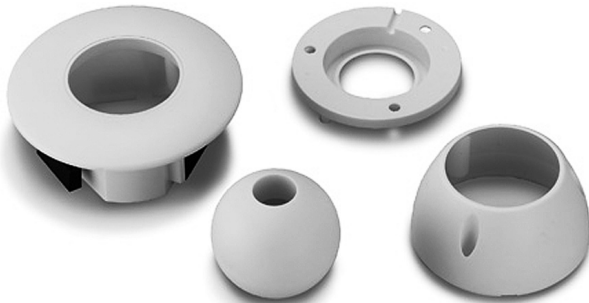

FEATURES

- Low-Profile/Small Size
- Flush-Mount/Surface-Mount
- Easy Assembly/Installation

SURFACE MOUNT

The surface-mount hardware included with the Dome Camera Kit allows easy installation in almost any situation—including retro-fit applications. Provisions must be made for physical wire connections, but the camera assembly itself is simply screwed in place.

TO INSTALL CAMERA USING SURFACE-MOUNT KIT:

Figure 1

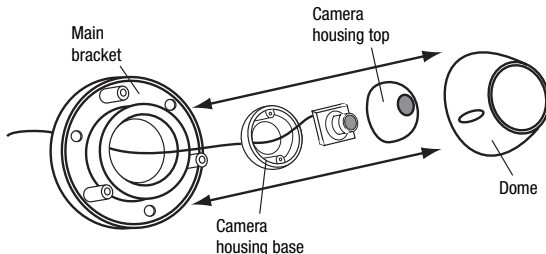

1. Drill 3/4" diameter hole in mounting surface to accommodate wiring.
2. Mount main bracket to desired location using three 1/2" screws.

Figure 2

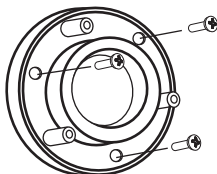

Use 1/2" Screws

3. Place camera inside of camera housing base. Make sure wires extend through base.
4. Place camera housing top on camera housing base and secure with two 1/4" screws.

Figure 3

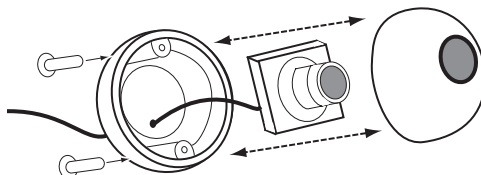

Use 1/4" Screws

5. Feed camera leads through hole in mounting surface. Connect wires (see WIRING.)
6. Place assembled camera housing into main bracket.
7. Place dome over camera housing and attach to main bracket with 3 large screws.
Do not tighten completely.

Figure 4

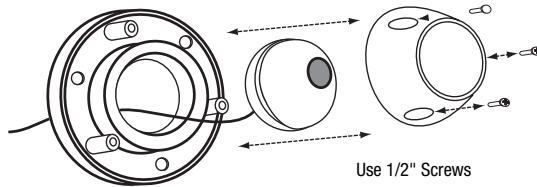

8. Make provisions to view the camera image and point the camera at the desired location.
Note: Make sure image is level!
9. With camera properly aimed, tighten screws.

Figure 5

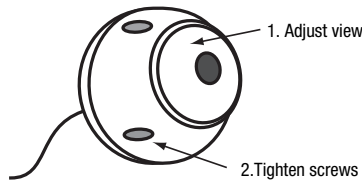

WIRING

NOTE: THE CAM-PB REQUIRES RG6 OR RG59 COAXIAL CABLE FOR VIDEO, AND TWO-CONDUCTOR, 18 AWG WIRE FOR POWER. USE THE CAMERA'S INCLUDED POWER SUPPLY FOR PROPER OPERATION. NO CABLES OR WIRES ARE SHIPPED WITH THE CAMERA KIT.

Figure 6

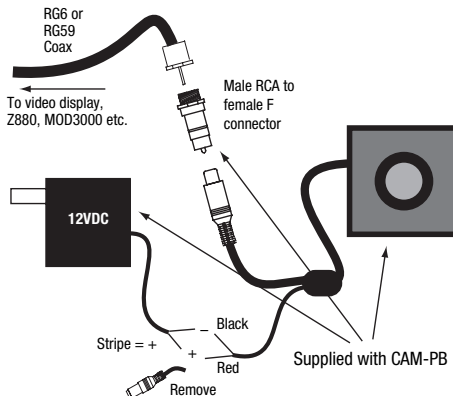

FLUSH-MOUNT

The flush-mount kit is used to achieve low-profile installations where stealth and concealment are priorities. A hole must be cut in the desired mounting surface.

Figure 7

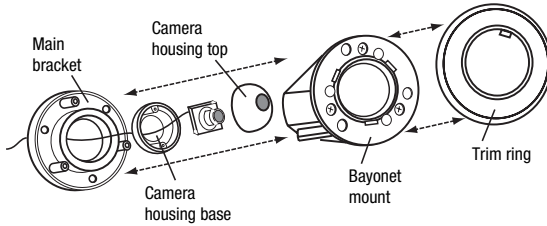

TO INSTALL CAMERA USING FLUSH-MOUNT KIT:

1. Cut a 3 1/4" diameter hole in mounting surface.

Figure 8

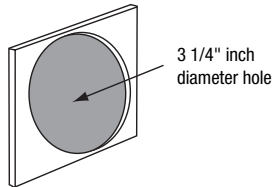

2. Place camera inside of camera housing base. Make sure wires extend through base.
3. Place camera housing top on camera housing base and secure with two 1/4" screws.

Figure 9

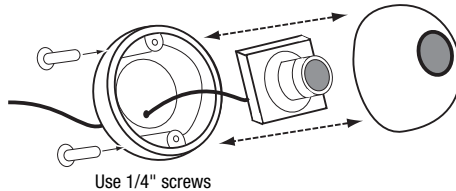

4. Connect wires.
5. Place assembled camera housing into main bracket. Place bayonet mount over camera housing and attach to main bracket with three 1/2" screws. Do not tighten completely.

Figure 10

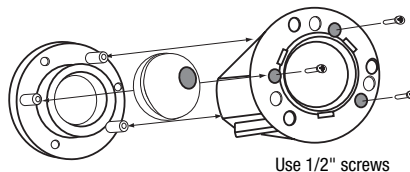

6. Place entire assembly into hole.

Figure 11

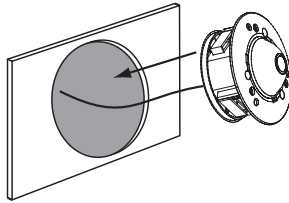

7. Turn dog screws clockwise until dogs are snug. Over-tightening dogs can keep trim ring from snapping in place. If trim ring does not snap into place, loosen screws slightly.

Figure 12

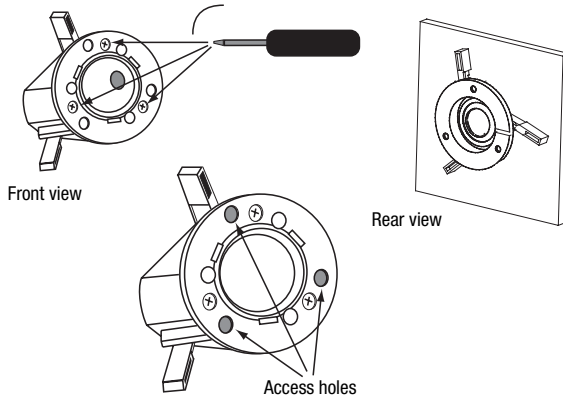

NOTE: ACCESS HOLES ARE PROVIDED TO LOOSEN DOGS IN CASE THEY BECOME STUCK.

8. Make provisions to view the camera image and point the camera at the desired location.

IMPORTANT: MAKE SURE THAT THE IMAGE IS LEVEL!

9. With camera properly aimed, tighten screws.

10. Align trim ring with slots in bayonet mount. Snap in place.

11. To remove trim ring, insert small, flat screwdriver tip into one of three slots on outer edge and pry off.

Figure 13

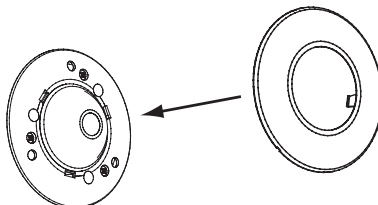

LIMITED WARRANTY

Niles Audio Corporation ("NILES") warrants its passive products (those not requiring AC or battery power) to the original purchaser to be free of manufacturing defects in material and workmanship for a period of ten years from date of purchase.

Niles Audio Corporation ("NILES") warrants its passive loudspeaker products (those not requiring AC or battery power) to the original purchaser to be free of manufacturing defects in material and workmanship for a period of five years from date of purchase.

Niles Audio Corporation ("NILES") warrants its outdoor loudspeaker products to the original purchaser to be free of manufacturing defects in material and workmanship for a period of two years from date of purchase.

Niles Audio Corporation ("NILES") warrants its active products (those requiring AC or battery power) to the original purchaser to be free of manufacturing defects in material and workmanship for a period of two years from date of purchase.

This Warranty is subject to the following additional conditions and limitations. The Warranty is void and inapplicable if NILES deems that the product has been used or handled other than in accordance with the instructions provided by the manufacturer, including but not limited to damage caused by accident, mishandling, improper installation, abuse, negligence, or normal wear and tear, or any defect caused by repair to the product by anyone other than NILES or an authorized NILES dealer.

To obtain warranty service, take the unit to the nearest authorized NILES dealer, who will test the product and if necessary, forward it to NILES for service. If there are no authorized NILES dealers in your area, you must write to NILES and include your name, model and serial number of your unit, along with a brief description of the problem. A factory Return Authorization Number will be sent to you. DO NOT RETURN ANY UNIT WITHOUT FIRST RECEIVING WRITTEN AUTHORIZATION AND SHIPPING INSTRUCTIONS FROM NILES.

If the above conditions are met, the purchaser's sole remedy shall be to return the product to NILES, in which case NILES will repair or replace, at its sole option, the defective product without charge for parts or labor. NILES will return a unit repaired or replaced under warranty by shipping same by its usual shipping method from the factory (only) at its expense within the United States of America. THERE ARE NO OTHER WARRANTIES, INCLUDING WITHOUT LIMITATION, EITHER EXPRESS OR IMPLIED WARRANTIES OF MERCHANTABILITY OR FITNESS FOR A PARTICULAR PURPOSE, WITH RESPECT TO THE PRODUCT.

REPAIR OR REPLACEMENT AS PROVIDED UNDER THIS WARRANTY IS THE EXCLUSIVE REMEDY OF THE CONSUMER/PURCHASER. NILES SHALL NOT BE RESPONSIBLE FOR ANY INCIDENTAL OR CONSEQUENTIAL DAMAGES EXCEPT TO THE EXTENT PROVIDED (OR PROHIBITED) BY APPLICABLE LAW.

Some states do not allow the exclusion or limitation of incidental or consequential damages, so the above limitation may not apply to you. This warranty gives you specific legal rights, and you may also have other rights which vary from state to state.

For the name of your nearest authorized NILES dealer, contact:
NILES AUDIO CORPORATION, P.O. BOX 160818, Miami, Florida 33116.

Please fill in your product information and retain for your records.

Model _____ Serial No. _____ Purchase Date _____

WARRANTY REGISTRATION CARD

Model Purchased _____

Serial Number _____

Date Purchased (month/day/year) _____

Dealer Name and Location _____

Dr. Miss Mr. Mrs. Ms.

Name _____

Address _____

City _____ State _____ Zip _____

Telephone () _____

Please take a moment to fill out our warranty registration card. The information helps us to get to know you better and develop the products you want

Age:

- Under 25
- 25-34
- 35-44
- 45-54
- 55 & over

Income:

- Under \$24,999
- \$25,000-\$34,999
- \$35,000-\$44,999
- \$45,000-\$59,999
- \$60,000-\$74,999
- \$75,000-\$99,999
- Over \$99,999

Occupation:

- Arts/Entertainment
- Business Owner
- Engineer
- Finance/Accounting
- General Office
- Management
- Professional
- Sales/Marketing
- Student
- Tradesperson

Musical tastes:

(Please check all that apply)

- Alternative
- Classical
- Country
- Jazz
- New Age
- Popular
- R&B
- Rock
- Other _____

How did you hear about Niles?

- Architect/Developer
- Custom Installer
- Direct Mail
- Friend/Family
- In-Store Display
- Interior Designer
- Magazine Ad
- Mail-Order Catalog
- Newspaper Ad
- Product Brochure
- Product Review

What magazines do you read?

1. _____
2. _____
3. _____

Who will install the product?

- Custom Installer
- Electrician
- Friend
- Myself

Which factor(s) influenced the purchase of your Niles product? (Please check all that apply)

- Ease of Use
- Price/Value
- Product Features
- Quality/Durability
- Reputation
- Style/Appearance
- Warranty

Do you . . . ?

Own a House. If yes, how many square feet? _____

- Own a Town House/Condominium/Co-op
- Rent an Apartment
- Rent a House

Are you interested in receiving literature on other Niles products?
 Yes No

Are there products/capabilities that you would like to see introduced?



BLENDING HIGH FIDELITY AND ARCHITECTURE®

Niles Audio Corporation
12331 S.W. 130 Street Miami, Florida 33186
Designed and Engineered in the USA
Made in China

©2005 Niles Audio Corporation. All rights reserved. Niles, the Niles logos and
Blending High Fidelity and Architecture are registered trademarks of Niles Audio Corporation.
All other trademarks are the property of their respective owners. 12/05 DS00470ACN 9900802 A

Download from [Www.Somanuals.com](http://www.Somanuals.com). All Manuals Search And Download.

Free Manuals Download Website

<http://myh66.com>

<http://usermanuals.us>

<http://www.somanuals.com>

<http://www.4manuals.cc>

<http://www.manual-lib.com>

<http://www.404manual.com>

<http://www.luxmanual.com>

<http://aubethermostatmanual.com>

Golf course search by state

<http://golfingnear.com>

Email search by domain

<http://emailbydomain.com>

Auto manuals search

<http://auto.somanuals.com>

TV manuals search

<http://tv.somanuals.com>