

STAGE FRONT

HOME THEATER SOLUTIONS®

INSTALLATION GUIDE



Pro15SW

PROFESSIONAL QUALITY, CABINET,
HIGH-POWER HOME THEATER SUBWOOFER

ENGINEERED BY



CONGRATULATIONS!

Thank you for choosing your new Niles **StageFront Home Theater Solutions™ Pro15SW 15-inch High-Power Home Theater Powered Subwoofer**. With proper installation and operation, you should enjoy years of trouble-free use.

Niles manufactures the industry's most complete line of custom installation components and accessories for audio/video systems. To see the complete Niles product assortment, visit us on the Internet at: www.nilesaudio.com

TABLE OF CONTENTS

Introduction	1
Important Safety Instructions	2
Features and Benefits	3
Installation Considerations	5
Controls and Connectors	7
Finishing the Installation	15
Specifications	18
FCC Instructions to the User	19
Warranty Registration Card	21

INTRODUCTION

The Niles StageFront Pro15SW 15-inch High-Power Home Theater Powered Subwoofer is expressly designed for superior sonic quality in home theater and multi-channel music bass reinforcement applications. It employs advanced technology components that extract powerful bass in recorded music or the thunderous deep sound effects in a movie. The Pro15SW is the perfect choice wherever enhanced bass sound is the most important consideration.



Pro15SW

Stock Number

FG01138

IMPORTANT SAFETY INSTRUCTIONS



The lightning flash with arrowhead symbol, within an equilateral triangle, is intended to alert the user to the presence of uninsulated dangerous voltage within the product's enclosure that may be of sufficient magnitude to constitute a risk of electric shock to persons.



The exclamation point within an equivalent triangle is intended to alert the user to the presence of important operating and maintenance (servicing) instructions in the literature accompanying the appliance.

WARNING: To reduce the risk of fire or electric shock, do not expose this apparatus to rain or moisture

1. Read these instructions.
2. Keep these instructions
3. Heed all warnings.
4. Follow all instructions.
5. Do not use this apparatus near water.
6. Clean only with a dry cloth.
7. Do not block any ventilation openings. Install in according with the manufacturer's instructions.
8. Do not install near any heat sources such as radiators, heat registers, stoves, or other apparatus (including amplifiers) that produce heat.
9. Do not defeat the safety purpose of the polarized or grounding-type plug. A polarized plug has two blades with one wider than the other. A grounding type plug has two blades and a third grounding prong. The wide blade or the third prong are provided for your safety. If the provided plug does not fit into your outlet, consult an electrician for replacement of the obsolete outlet.
10. Protect the power cord from being walked on or pinched particularly at plug, convenience receptacles, and the point where they exit from the apparatus.
11. Only use attachments/accessories specified by the manufacturer.
12. Use only with a cart, stand, tripod, bracket, or table specified by the manufacturer, or sold with the apparatus. When a cart is used, use caution when moving the cart/apparatus combination to avoid injury from tip-over.
13. Unplug this apparatus during lightning storms or when unused for long periods of time.
14. Refer all servicing to qualified service personnel. Servicing is required when the apparatus has been damaged in any way, such as power-supply cord or plug is damaged, liquid has been spilled or objects have fallen into the apparatus, the apparatus has been exposed to rain or moisture, does not operate normally, or has been dropped.
15. Do not expose this equipment to dripping or splashing and ensure that no objects filled with liquids, such as vases, are placed on the equipment.
16. To completely disconnect this equipment from the AC mains, disconnect the power supply cord plug from the AC receptacle.
17. The main plug of the power supply cord shall remain readily operable.



FEATURES AND BENEFITS

15-INCH INTERLACED CARBON-FIBER WOOFER WITH CAST ALUMINUM FRAME AND BUTYL-RUBBER SURROUND

The Pro15SW's long-throw front-firing 15" woofer creates deep authoritative bass at sustained output levels.

1,000 WATT ADVANCED DIGITAL AMPLIFIER

Niles uses the latest digital technology so bass response will be extremely fast and absolutely accurate, no matter what audio material is being reproduced. The efficient design means little heat is generated.

SOPHISTICATED MOTOR ASSEMBLY WITH HIGH BL MAGNET, EXTENDED POLE PIECE AND MACHINED TOP PLATE

The Pro15SW's woofer features a sophisticated motor assembly that combines a high BL magnet and extended pole piece for deep bass response and clean bass tones. Moreover, the machined top plate provides extra rigidity to the entire assembly for consistent performance over prolonged use.

SEPARATE BASS LEVEL CONTROLS AND TRIGGER INPUT FOR MOVIES OR MUSIC

Separate bass level controls for music and movies triggered via a 12-volt input enable customized settings for automated DVD-Audio or Dolby® surround sound effects.

GOLD PLATED STEREO RCA LINE-LEVEL AND LOUDSPEAKER-LEVEL INPUTS

The Pro15SW features stereo RCA line-level inputs as well as a non-filtered RCA LFE (Low Frequency Effects) line-level input for a direct connection from a 5.1 or 7.1 home theater sound processor. The Pro15SW also has gold-plated loudspeaker-level five-way binding-post inputs for the best quality connection possible.

FRONT MOUNTED ADJUSTABLE LEVEL, LOW-PASS, HIGH-PASS AND PHASE CONTROLS

Adjustment after installation has never been easier. Easily accessible front controls for level, low-pass filter, high-pass filter and a fully adjustable phase control (0-to-180 degree) ensure optimal system integration, no matter where the Pro15SW is placed in the room.

(CONTINUED ON NEXT PAGE)

MUSIC SENSE AND 12 VOLT TRIGGER CIRCUITRY FOR AUTOMATIC POWER ON/OFF

When enabled, the Pro15SW will turn on when an audio signal is present and remains on any of the audio inputs. The 12-volt System trigger input functions in the same fashion. Power will turn off when no signal is present after a delay of approximately 15 minutes for Music Sense or for the 12-volt trigger.

CASCADE LINE-LEVEL OUTPUTS ALLOW EASY CONNECTION OF ADDITIONAL WOOFERS

For larger rooms, multiple Pro15SW's can be easily added to a home theater system using the line-level audio outputs to feed additional Pro15SW audio inputs. These outputs may also be used to return signals to processors or receivers.

CROSS BRACED, FRONT-PORTED CABINET WITH REMOVABLE GRILLE

The Pro15SW is housed in an attractive cross-braced polished black cabinet that provides the ultimate in rigidity and sound clarity. The charcoal sculpted aluminum grille is easily removable to enable simple installation.

GOLD PLATED STEREO LOUDSPEAKER-LEVEL OUTPUTS

The Pro15SW features gold-plated loudspeaker-level five-way binding-post outputs for the best quality connection possible. These have a fixed high-pass filter of 100Hz at 6dB per octave.

ADJUSTABLE ISOLATING FEET

The Pro15SW is equipped with four adjustable spike feet (pre-installed with large slip-on rubber covers) that couple the woofer cabinet to a hard floor for better performance. For carpet placement, the rubber covers can be removed to use the spikes.

DOLBY® DIGITAL READY

The Pro15SW is specifically designed for outstanding Home Theater sound. This model exceeds the specifications set forth by Dolby Laboratories for the accurate reproduction of Dolby Digital-Encoded Sources.

INSTALLATION CONSIDERATIONS

RCA CABLE

For line-level connections, use high-quality RCA cables that feature low impedance, double shielding and gold-plated connectors (see **CONTROLS AND CONNECTORS** on page 7). Consult your local Niles dealer for their recommendations.

LOUDSPEAKER WIRE

Use 2-conductor loudspeaker wire for loudspeaker-level connections to the Pro15SW and satellite loudspeakers (see **CONTROLS AND CONNECTORS** on page 7). For these applications, we recommend using 16-gauge wire. For wiring runs longer than 80 feet, we recommend 14-gauge wire. The Pro15SW's gold-plated, five-way, loudspeaker-level binding posts will accommodate up to 12-gauge wire directly. Larger sizes can be accommodated via pin connectors.

RUNNING WIRES IN WALLS OR CEILINGS

When running wire inside walls or ceilings, use special jacketed cable (CL-2 or CL-3) to protect the wire and to meet local electrical and fire codes. In some areas, conduit is also required. For a trouble-free installation, low-voltage wire such as loudspeaker wire must be run in accordance with the National Electrical Code and any applicable provisions of the local building code. If you are unsure of the correct installation techniques, wire jacket, or type of conduit to use, consult a professional audio/video installer, building contractor, or the local building and inspection department.

PRO15SW PLACEMENT

The StageFront Pro15SW Powered Subwoofer is expressly designed for use in home theater and multi-channel bass reinforcement applications. For home theater front, center or rear-channel applications, we recommend using StageFront Pro or In-Wall models. Models ending in "LCR" are intended primarily for front channel left/center/right placement or wherever a monopole design is required. Models that end in "FX" are designed for special effect placement. StageFront Home Theater Solutions™ Loudspeakers are the perfect choice wherever quality of sound is the most important consideration.

THE BOUNDARY EFFECT

Placing a Pro15SW in a corner can powerfully affect the way a listener perceives bass response. Known as the boundary effect, a placement close to a corner-wall boundary will emphasize certain bass frequencies, while canceling others. This effect can make the Pro15SW sound excessively boomy and inaccurate to some listeners, while to others it just seems like more bass sound. Some listeners may prefer to place the subwoofer (or subwoofers) near the same location as the main left/right channel loudspeakers.

(CONTINUED ON NEXT PAGE)

INSTALLATION CONSIDERATIONS (CONTINUED)

Because all rooms are unique and people have different expectations with regard to audio quality, some experimentation may be necessary with regard to placement and control settings.

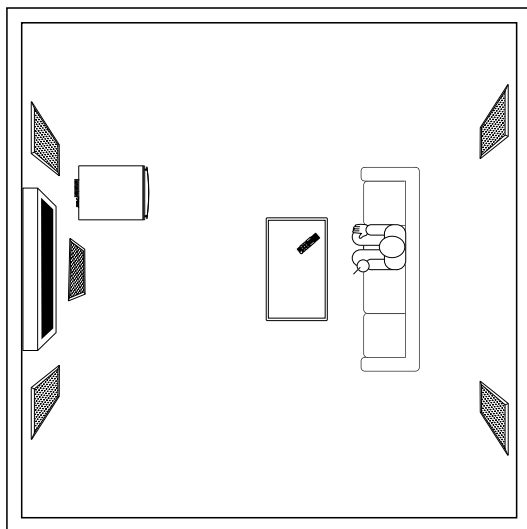

Figure 1. A standard placement with the subwoofer right of center.

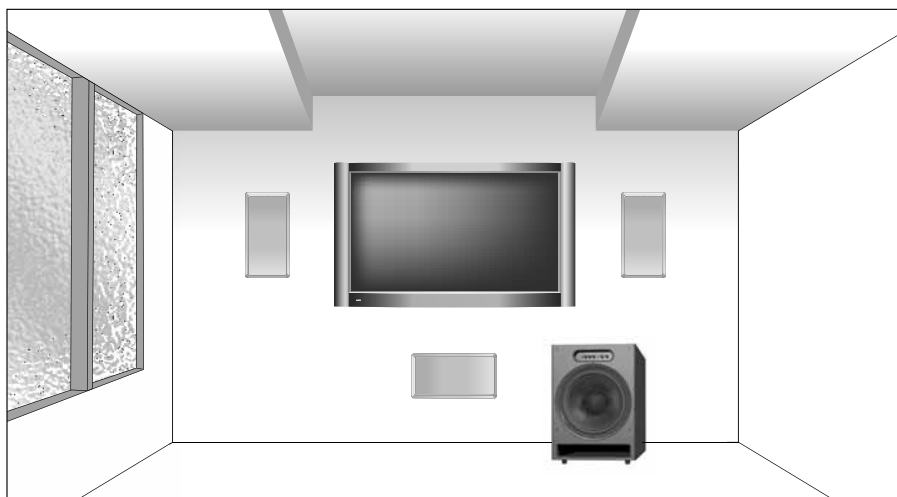

Figure 2. Placed in the front right of a home theater room.

CONTROLS AND CONNECTORS

OPERATION CONTROLS

The Pro15SW's operation controls are located on the unit's front panel, as shown in **Figure 3**. They function as follows:

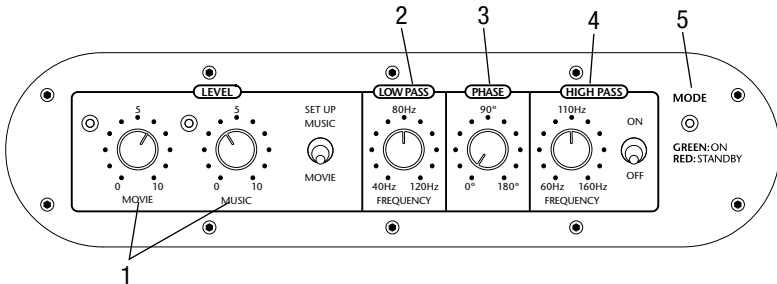

Figure 3. The Pro15SW's front panel contains the subwoofer's operation controls.

- 1. MUSIC/MOVIE LEVEL and SETUP Controls:** While listening to music, move **SETUP** switch to **MUSIC** and adjust the **MUSIC LEVEL** control to set the desired bass level. Similarly, while listening to a movie, move **SETUP** to **MOVIE** and adjust the **MOVIE LEVEL** control to set the desired bass level. Each level control includes an accompanying LED indicator to identify which one is currently active as triggered by your home theater sound processor or receiver (see **Figure 3** on page 7). Also see **SETTING UP THE PRO15SW** on page 15.
- 2. LOW PASS Frequency Control:** Use this control to set the subwoofer's low-pass crossover frequency from 40 to 120 Hz. For more details, see **SETTING UP PRO15SW** on page 15.
- 3. PHASE Control:** Use this control to set the subwoofer's phase response from 0 to 180°. See **SETTING UP THE PRO15SW** on page 15.
- 4. HIGH PASS Frequency adjustment with ON/OFF switch:** Use the **HIGH PASS** control to set the high-pass crossover frequency from 60 to 160 Hz (according to your loudspeaker manufacturer's recommendation) to drive a satellite loudspeaker system amplifier from the line-level **AUDIO OUT** jacks (also see **Figure 3** on page 7.) To activate the filtered signals, set the **ON/OFF** switch to **ON**.
- 5. The MODE indicator (on the far right) shows which power mode is active, as set by the (Auto) POWER switch (see Figure 3 on page 7): Green is ON; Red is STANDBY.**

(CONTINUED ON NEXT PAGE)

CONTROLS AND CONNECTORS (CONTINUED)

SIGNAL CONNECTORS AND POWER CONTROLS

The Pro15SW's signal connectors and power controls are located on the unit's rear panel, as shown in **Figure 4**. They function as follows:

NOTE: SEE APPLICATIONS STARTING ON PAGE 10 FOR DETAILED WIRING CONNECTIONS FOR YOUR APPLICATION.

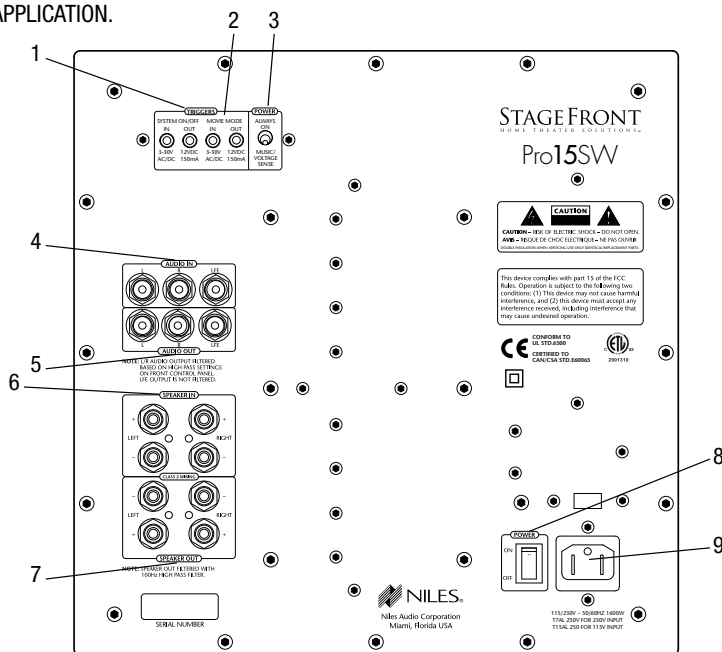

Figure 4. The Pro15SW's rear panel contains the subwoofer's signal connectors and power controls.

- 1. POWER TRIGGER:** For external power triggering, use a mini (3.5 mm) plug to connect the IN jack to a power on/off trigger signal from a home theater sound processor or receiver. Power on is 3 to 30 Vdc (or Vac). Tip is positive. Power off is 0 Vdc (or Vac). Use the OUT jack to pass the POWER TRIGGER signal to another Pro15SW. Voltage will be present on the output jack whenever the amplifier is active. This is indicated by the green LED on the front panel.

NOTE: FOR A HOME THEATER RECEIVER NOT EQUIPPED WITH A POWER TRIGGER OUTPUT, CONSIDER USING A NILES 12-VOLT POWER SUPPLY AS A TRIGGER SIGNAL THAT IS ACTIVATED VIA A SWITCHED AC OUTLET ON THE RECEIVER. SEE **FIGURE 9** ON PAGE 14 FOR CONNECTION DETAILS.

- 2. MOVIE MODE TRIGGER:** For external movie/music mode triggering, use a mini (3.5 mm) plug to connect the IN jack to a movie trigger signal from a home theater surround processor or receiver. The 3 to 30 Vdc (or Vac) signal will set the Pro15SW to movie mode, while a 0 Vdc (or Vac) signal will keep it in the music mode. Again, tip is positive. Use the OUT jack to pass the movie trigger signal to another Pro15SW.

NOTE: ON THE FRONT PANEL IF SETUP (SEE **FIGURE 3** ON PAGE **7**) SWITCH IS SET TO MUSIC, A 3 TO 30 VDC (OR VAC) TRIGGER SIGNAL WILL CHANGE OPERATION OVER TO THE MOVIE MODE. IF THE SETUP SWITCH IS ALREADY SET TO MOVIE, A TRIGGER SIGNAL HAS NO EFFECT, SINCE THE MODE IS ALREADY SET TO MOVIE.

NOTE: FOR A HOME THEATER RECEIVER NOT EQUIPPED WITH A MOVIE/MUSIC TRIGGER OUTPUT, CONSIDER ADDING A NILES HOME THEATER AUTOMATION SYSTEM OR A NILES MAIN SYSTEM UNIT. SEE **FIGURE 9** ON PAGE **14** FOR CONNECTION DETAILS.

- 3. (Auto) POWER Switch: Use the ALWAYS ON mode to leave the Pro15SW always on. Use the MUSIC/VOLTAGE SENSE mode to automatically power on the Pro15SW when an audio signal or trigger voltage is present. When either signal is absent for 15 minutes, the Pro15SW will enter the standby mode.*

NOTE: THE ALWAYS ON AND MUSIC/VOLTAGE SENSE SETTINGS ARE ONLY ACTIVE AFTER (MASTER) POWER IS SET TO ON (SEE #8 BELOW).

- 4. AUDIO IN jacks: Use these gold-plated line-level RCA input jacks to connect line-level stereo and LFE audio signals from a home theater Processor or receiver. The LFE (Low Frequency Effects) input is unfiltered.*
- 5. AUDIO OUT jacks: Use these gold-plated line-level RCA output jacks to connect line-level stereo and LFE audio signals to drive another Pro15SW. The LFE output is unfiltered, but the L/R output signals are routed through the variable (60 to 160 Hz) HIGH-PASS filter, and the response will be contoured according to filter settings (see **Figure 4** on page **8**).*
- 6. Loudspeaker IN Binding Posts: As an alternative to the AUDIO IN jacks, use the loudspeaker-level, gold-plated, five-way binding posts to connect loudspeaker-level, stereo audio signals from a home theater, receiver or whole-home audio system. For additional connection details, see **FINISHING THE INSTALLATION** on page **15**.*

NOTE: DO NOT USE THESE CONNECTIONS WHEN USING THE LINE-LEVEL INPUTS.

- 7. Loudspeaker OUT Binding Posts: As an alternative to the AUDIO OUT jacks, use the loudspeaker-level, gold-plated, five-way binding posts to connect loudspeaker-level, stereo audio signals to drive your front L/R satellite loudspeakers. These signals are routed through a fixed, 100 Hz (6 dB per octave) high-pass filter and the response will be contoured accordingly.*

NOTE: THERE WILL ONLY BE A SIGNAL ON THESE CONNECTIONS IF THE LOUDSPEAKER IN BINDING POSTS WERE USED.

- 8. (Master) POWER Switch: Use this control to power on/off the PRO15SW.*
- 9. Detachable IEC Power Cord and Built-In Fuse. If needed, replace the fuse with same type, as follows:*

- *For 115/120 Vac @ 60 Hz, use a T7AL 250V - 230V fast-blow fuse.*

- *For 230/240 Vac @ 50 Hz, use a T15AL 250V - 115V fuse.* (CONTINUED ON NEXT PAGE)

CONTROLS AND CONNECTORS (CONTINUED)

APPLICATIONS

The StageFront Pro15SW 15-inch High-Power Home Theater Powered Subwoofer is very flexible and can be configured for use in various applications with associated external audio components, as shown in **Figures 5** through **9**. For other Pro15SW applications, consult your local Niles dealer for help in configuring your home theater system

PRO15SW IN A TYPICAL THEATER INSTALLATION

Set switch to **ON** and adjust **FREQUENCY** to match low frequency cutoff of your satellite loudspeakers.

Alternate configuration:

Set switch to **OFF** to send full range audio to L/R **AUDIO OUT** jacks.

Position **SET UP** switch to the mode you wish to adjust **MUSIC OR MOVIE** and adjust level controls per instructions.

Adjust **PHASE** to integrate subwoofer sound with system.

Set **LOW PASS** to closely match **HIGH PASS FREQUENCY** control.

NOTE: Control does not function when using **LFE** input.

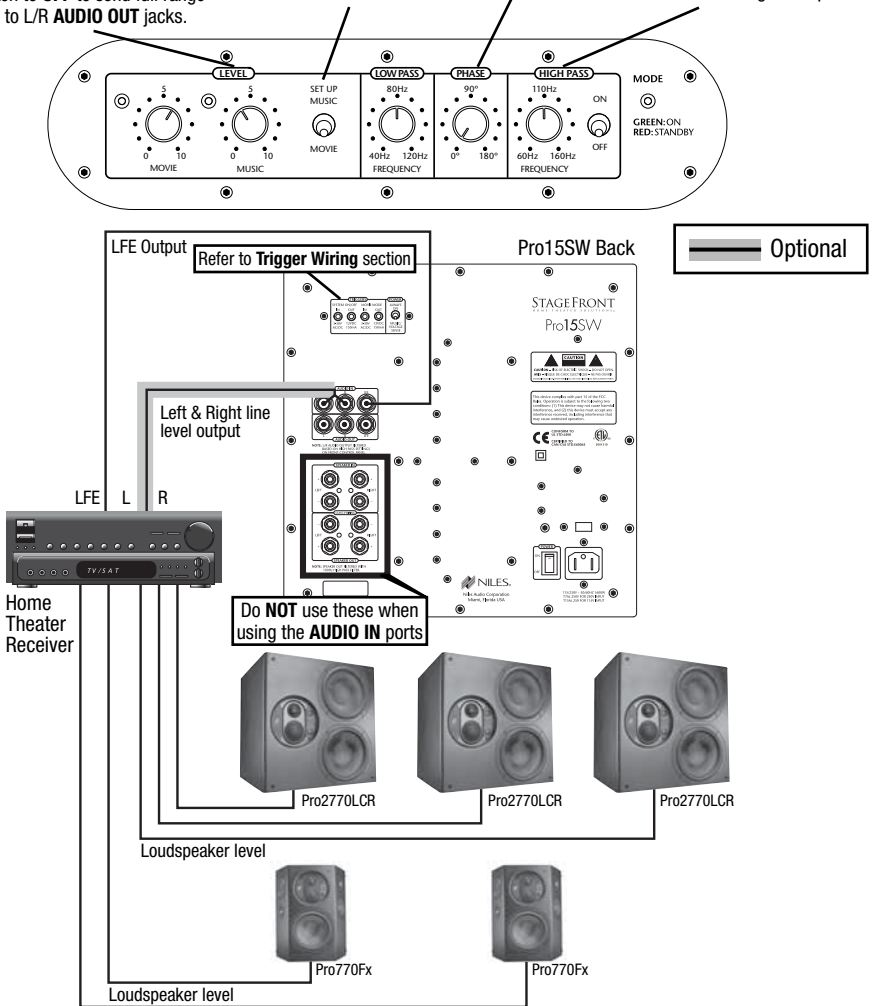

Figure 5. Line level connections

PRO15SW AND LOUSPEAKER-LEVEL CONNECTION TO SATELLITE LOUSPEAKERS

Set switch to **ON** and adjust **FREQUENCY** to match low frequency cutoff of your satellite loudspeakers.

Alternate configuration:

Set switch to **OFF** to send full range audio to L/R **AUDIO OUT** jacks.

Position **SET UP** switch to the mode you wish to adjust **MUSIC OR MOVIE** and adjust level controls per instructions.

Adjust **PHASE** to integrate subwoofer sound with system.

Set **LOW PASS** to closely match **HIGH PASS** **FREQUENCY** control.
NOTE: Control does not function when using **LFE** input.

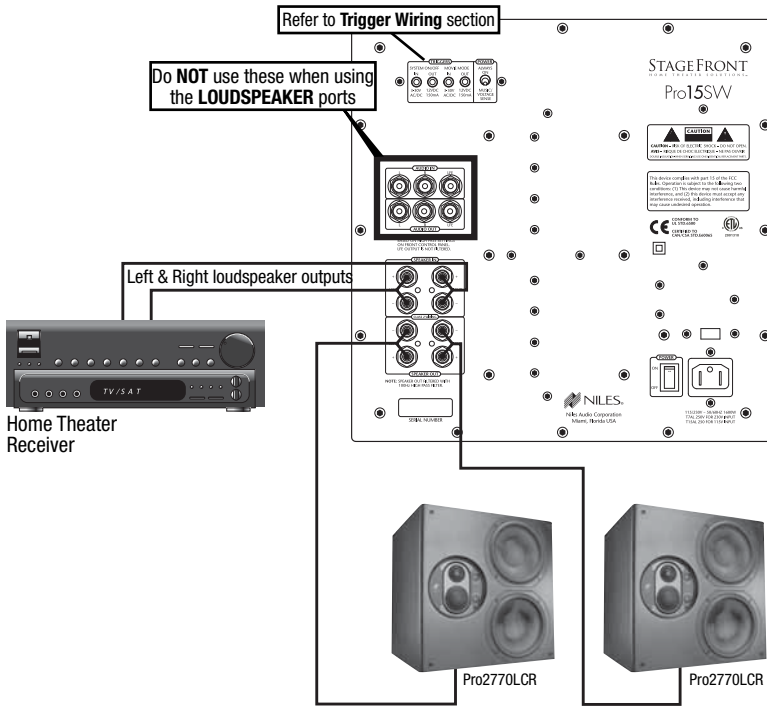
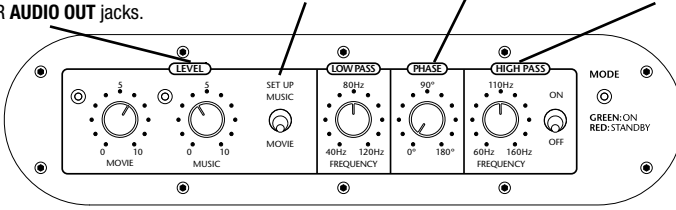

Figure 6. Connecting satellite loudspeakers

TWO PRO15SWS AND SATELLITE LOUDSPEAKER SYSTEM

Set switch to **ON** and adjust **FREQUENCY** to match low frequency cutoff of your satellite loudspeakers.

Alternate configuration:

Set switch to **OFF** to send full range audio to L/R **AUDIO OUT** jacks.

Position **SET UP** switch to the mode you wish to adjust **MUSIC OR MOVIE** and adjust level controls per instructions.

Adjust **PHASE** to integrate subwoofer sound with system.

Set **LOW PASS** to closely match **HIGH PASS FREQUENCY** control.

NOTE: Control does not function when using **LFE** input.

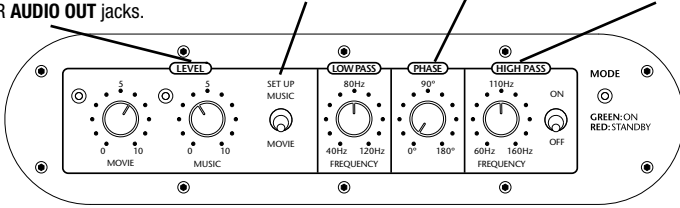

NOTE: ADJUST SETTING ON BOTH PRO15SW SUBS TO BE THE SAME

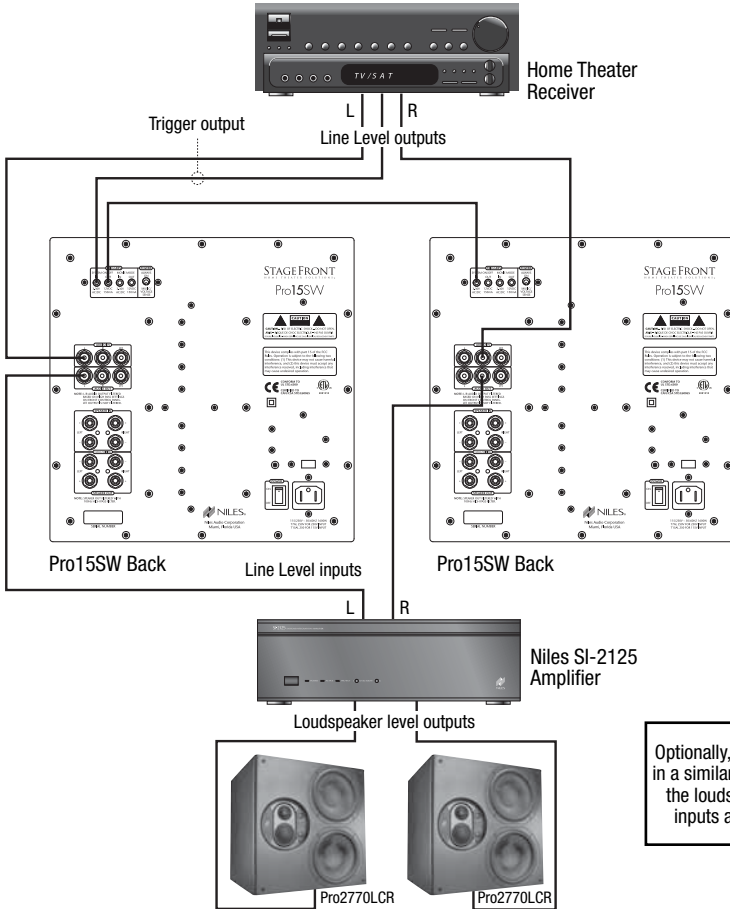

Figure 7. Stereo/dual subwoofer application

PRO15SW AND LOUDSPEAKER LEVEL CONNECTION TO SATELLITE LOUDSPEAKERS

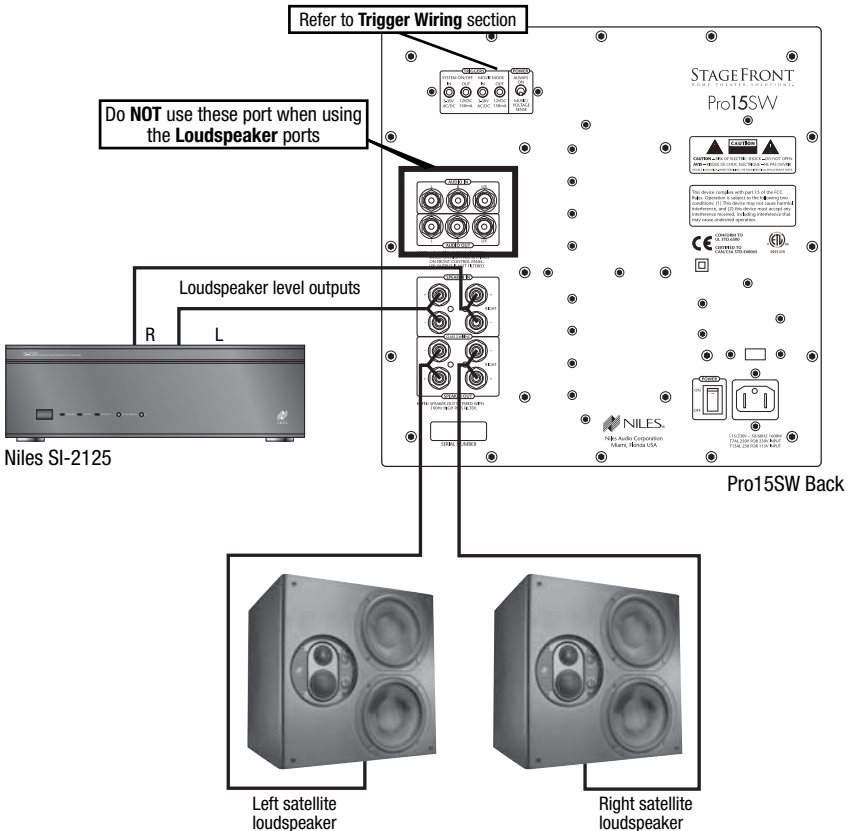
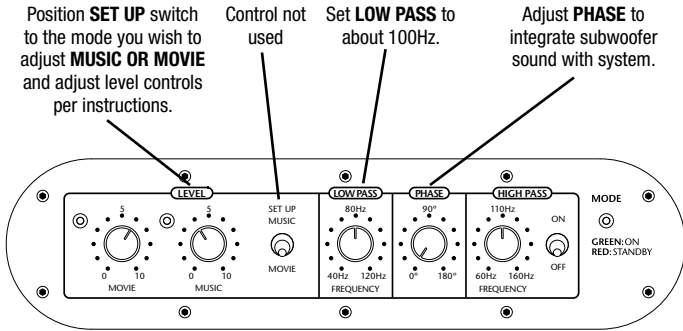

Figure 8. Loudspeaker level connections

PRO15SW AND SATELLITE LOUDSPEAKER SYSTEM WITH EXTERNAL POWER AND MODE TRIGGERS

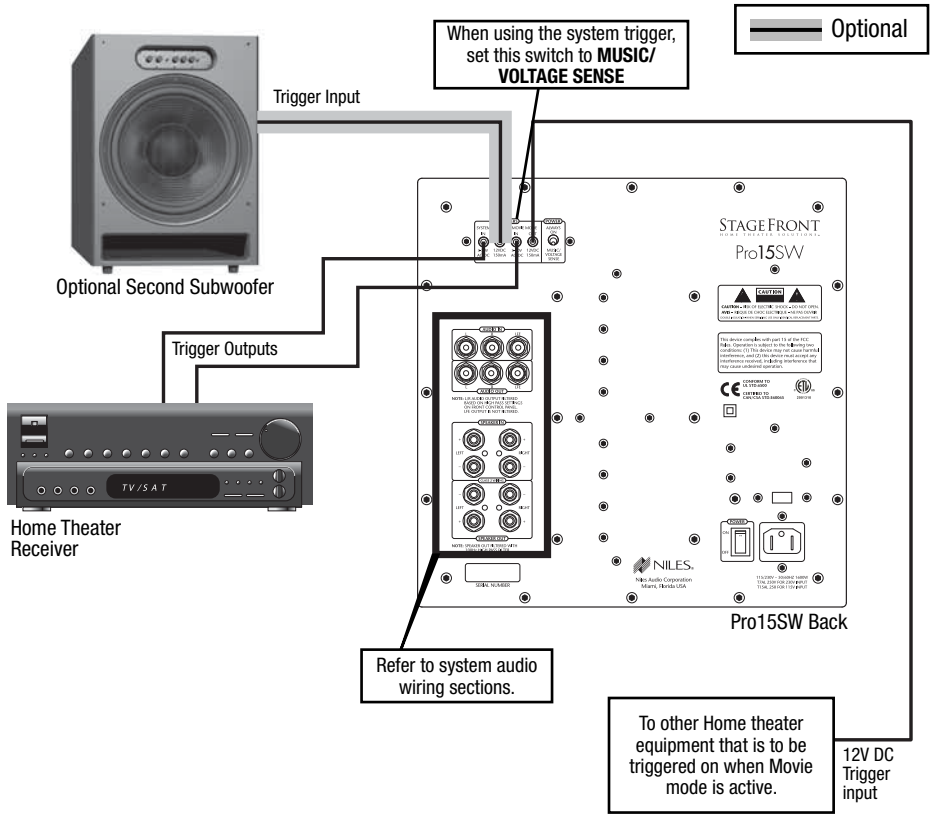

Figure 9. Trigger connections

FINISHING THE INSTALLATION

ADJUSTING THE FEET

The Pro15SW is equipped with four adjustable spike feet that include large slip-on rubber covers. At the final placement site adjust the feet/spikes as follows:

- *On hard floors (e.g., wood, tile, etc.), check the Pro15SW's stability and if needed, adjust the rubber feet one at a time until the cabinet is level.*
- *On carpeted floors, tilt the Pro15SW up and remove each rubber cover. Check the Pro15SW's stability and if needed, adjust the spikes one at a time until the cabinet is level.*

CONNECTING THE PRO15SW

Connect the Pro15SW according to your application (see **APPLICATIONS** on page 10). Use high-quality RCA cables for all line-level connections (see **CONTROLS AND CONNECTORS** on page 7). For applications with loudspeaker-level connections, perform the following steps:

1. *At each Pro15SW loudspeaker-level connection, separate the loudspeaker wire so that at least 2 inches of each conductor are free. Strip away 1/4 inch of insulation from each loudspeaker wire. Using correct polarity, connect the appropriate conductor to each five-way binding post.*

NOTE: OBSERVE CORRECT POLARITY: POSITIVE (+) GOES TO THE RED POST AND NEGATIVE (-) GOES TO THE BLACK POST. IF YOU ARE UNSURE OF WIRE POLARITY, SEE THE SECTION, **CHECKING PHASE ON THE SATELLITE LOUSPEAKERS**, ON PAGE 16.

2. *Connect the other end of the loudspeaker wires to the home theater receiver (or amplifier) and satellite loudspeakers in the same way.*
3. *Turn on the home theater receiver and calibrate all loudspeakers in the system according to the receiver (or surround processor) manufacturer's instructions.*

SETTING UP THE PRO15SW

After making all the connections and calibrating the loudspeakers, set up the Pro15SW by performing the following steps (see **CONTROLS AND CONNECTORS** on page 7 for information on control operation):

1. *On the rear panel, set the (Master) POWER switch to ON. Depending on your application set the (Auto) POWER switch to ALWAYS ON or MUSIC/VOLTAGE SENSE.*
2. *On the front panel, set the following controls (and switches) to their initial positions:*

(CONTINUED ON NEXT PAGE)

- **HIGH PASS FREQUENCY** control (if applicable) = **160 Hz** (or value recommended by satellite loudspeaker manufacturer)
 - **HIGH PASS ON/OFF** switch = **ON**
 - **LEVEL SETUP** switch = **MUSIC**
 - **MUSIC LEVEL** control = **5**
 - **MOVIE LEVEL** control = **5**
 - **LOW PASS FREQUENCY** control = **120 Hz**
 - **PHASE** control = **0°**
3. *While playing a favorite music track, adjust your system's volume control to a comfortable level and listen to the bass level at your favorite listening position (e.g., couch). Next, move the LEVEL SETUP switch to MOVIE and play a favorite movie chapter. Listen to the bass level, and, if desired, adjust the MOVIE LEVEL control to change the movie bass level to taste.*
 4. *Move the LEVEL SETUP switch back to MUSIC and play the music track again. If desired, adjust the MUSIC LEVEL control to taste.*
 5. *Continue listening to your favorite music and movie sources using the appropriate setting for LEVEL SETUP. If you want a more solid-sounding bass (with less overtones), try moving the LOW PASS FREQUENCY control toward the lower frequencies. Experiment with different frequency settings until you find one that sounds best. If needed, readjust the MOVIE LEVEL and MUSIC LEVEL controls (see steps 3 and 4 above).*
 6. *Continue listening to your favorite music and movie sources using the appropriate setting for LEVEL SETUP. Try experimenting with the PHASE control until you find its optimum setting. Depending on the Pro15SW's placement, the bass should sound more pronounced when the phase has been optimized.*

CHECKING PHASE ON THE SATELLITE LOUDSPEAKERS

Loudspeaker wire has two conductors. On applications with satellite loudspeakers, one conductor is attached to a component's negative (-) terminal, while the other is attached to a component's positive (+) terminal. Usually, the wire is marked for your convenience, but the marking can be done in the following different ways:

- *Stripe on one wire*
- *Ribbed area you can feel on one conductor*
- *Different colors of metal wire on each conductor*
- *Fabric strand or string wound into one of the conductors*

Of course, there are some wires that appear completely identical. So be careful, or you might make a connection mistake. If you do, one satellite loudspeaker will be playing “out-of-phase” with the other loudspeaker. A pair of out-of-phase loudspeakers works against each other, and the sound of the two playing together will be lacking in bass and sound “phasey.” If you suspect the sound is not right, and you cannot see any markings on the wire, try this simple test:

- 1. Stand halfway between the satellite loudspeakers.**
- 2. Play some music with the amplifier or receiver set to Mono.**
- 3. Listen to the richness of the bass and the loudness of the sound.**
- 4. Turn off the amplifier and reverse the connections on one (Left or Right) of the Pro15SW Loudspeaker OUT binding post pairs.**
- 5. Repeat the listening test with the same volume control setting. When the sound has a richer bass and is slightly louder, the satellite loudspeakers are working together or “in-phase.”**

INSTALLING AND REMOVING THE GRILLE

- *To install the grille, start with one corner and gently press the grille frame around the Pro15SW's edge, pushing it in at each of the four recessed holes. When properly installed, the grille will be approximately 1 inch away from the cabinet.*
- *To remove the grille, start with one corner and gently pull the grille frame away from the Pro15SW's edge at each of the four recessed holes. Store the grille in a safe place for future use.*

CLEANING

Use a dampened soft cloth or paper towel to clean the cabinet and grille.

SPECIFICATIONS

Driver Complement

15-inch Interlaced Carbon-Fiber Woofer with Cast Aluminum Frame and Butyl-Rubber Surround

Amplifier Power

1,000 Watts (rms) at less than 1% distortion

Frequency Response

25 to 125 Hz, +/- 3 dB

Power Requirements

120 Vac, 60Hz or 220-240 Vac, 50-60Hz

Overall Dimensions

17-1/2" W x 25" H x 24-3/4" D*

*Includes grille Depth is 23-3/8" without grille

Weight

108 lbs

Certification

Meets FCC Part 15 and ICES-003, Class B for USA and Canada

CSA Listed and tested under UL/EN60065 standard

CE compliant for the EU

C-Tick compliant for Australia and New Zealand

FCC INSTRUCTIONS TO THE USER

This equipment has been tested and found to comply with the limits for a class B digital device, pursuant to part 15 of the FCC Rules. These limits are designed to provide reasonable protection against harmful interference in a residential installation. This equipment generates, uses and can radiate radio frequency energy and if not installed and used in accordance with the instructions, may cause harmful interference to radio communications. However, there is no guarantee that interference will not occur in a particular installation.

If this equipment does cause harmful interference to radio or television reception, which can be determined by turning the equipment off and on, the user is encouraged to try to correct the interference by one or more of the following measures:

- ***Reorient or relocate the receiving antenna.***
- ***Increase the separation between the equipment and receiver.***
- ***Connect the equipment into an outlet on a circuit different from that to which the receiver is connected.***
- ***Consult the dealer or an experienced radio/TV technician for help.***

This equipment has been verified to comply with the limits for a class B computing device, pursuant to FCC Rules. In order to maintain compliance with FCC regulations, shielded cables must be used with this equipment. Operation with non-approved equipment or unshielded cables is likely to result in interference to radio and TV reception. The user is cautioned that changes and modifications made to the equipment without the approval of manufacturer could void the user's authority to operate this equipment.

WARRANTY REGISTRATION CARD

Model Purchased _____

Serial Number _____

Date Purchased (month/day/year) _____

Dealer Name and Location _____

Dr. Miss Mr. Mrs. Ms.

Name _____

Address _____

City _____ State _____ Zip _____

Telephone () _____ email _____

Please take a moment to fill out our warranty registration card. The information helps us to get to know you better and develop the products you want

Age:

- Under 25
- 25-34
- 35-44
- 45-54
- 55 & over

Income:

- Under \$44,999
- \$45,000-\$59,999
- \$60,000-\$74,999
- \$75,000-\$99,999
- \$99,999-\$150,000
- \$150,000-\$99,999
- \$99,999-\$200,000
- Over \$200,000

Occupation:

- Arts/Entertainment
- Business Owner
- Engineer
- Finance/Accounting
- General Office
- Management
- Professional
- Sales/Marketing
- Student
- Tradesperson

Musical tastes:

(Please check all that apply)

- Alternative
- Classical
- Country
- Jazz
- New Age
- Popular
- R&B
- Rock
- Other _____

How did you hear about Niles?

- Architect/Developer
- Custom Installer
- Direct Mail
- Friend/Family
- In-Store Display
- Interior Designer
- Magazine Ad
- Mail-Order Catalog
- Newspaper Ad
- Product Brochure
- Product Review
- Retail Salesperson
- Internet
- Other

What magazines do you read?

1. _____
2. _____
3. _____

Who will install the product?

- Custom Installer
- Electrician
- Friend
- Myself

Which factor(s) influenced the purchase of your Niles product? (Please check all that apply)

- Ease of Use
- Price/Value
- Product Features
- Quality/Durability
- Reputation
- Style/Appearance
- Warranty

Do you . . . ?

Own a House. If yes, how many square feet? _____

- Own a Town House/Condominium/Co-op
- Rent an Apartment
- Rent a House

Are you interested in receiving literature on other Niles products?

- Yes No

Are there products/capabilities that you would like to see introduced?

E N G I N E E R E D B Y



NILES®

1969 Kellogg Avenue, Carlsbad, CA 92008 1-800-BUY-HIFI – www.nilesaudio.com

©2011 The AVC Group, LLC. All rights reserved. Niles and the Niles logo are registered trademarks of The AVC Group, LLC. Stagefront Home Theater Solutions is a trademark of The AVC Group, LLC. All other trademarks are the property of their respective owners. DS00544A



Free Manuals Download Website

<http://myh66.com>

<http://usermanuals.us>

<http://www.somanuals.com>

<http://www.4manuals.cc>

<http://www.manual-lib.com>

<http://www.404manual.com>

<http://www.luxmanual.com>

<http://aubethermostatmanual.com>

Golf course search by state

<http://golfingnear.com>

Email search by domain

<http://emailbydomain.com>

Auto manuals search

<http://auto.somanuals.com>

TV manuals search

<http://tv.somanuals.com>