



HOME THEATER AUTOMATION AND CONTROL SYSTEM

CONGRATULATIONS!

Thank you for purchasing the **ic2 Home Theater Automation and Control System** from Niles. With proper installation and operation, you should enjoy years of trouble-free use.

Niles manufactures the industry's most complete line of custom installation components and accessories for audio/video systems. To see the complete Niles product assortment, visit us on the Internet at: www.nilesaudio.com

TABLE OF CONTENTS

Introduction	1
Features and Benefits	2
Contents	4
Parts Guide	4
System Design Considerations	8
Installation Considerations	14
Installation	18
Troubleshooting	23
Accessories	25
Specifications	27
Warranty	28
Warranty Registration Card	29



INTRODUCTION

The Niles iC2 Home Theater Automation and Control System addresses an essential need of today's consumers—the ability to easily control and manage the assortment of entertainment sources found in the home theater environment.

Home entertainment systems should be fun, not frustrating, and Niles has always recognized the need for simple-to-use, cost-effective solutions. We also recognize that features and technologies change over time, and more so than ever, these changing technologies require advanced automation, as well as an easy-to-use remote control.

The iC2 System consists of two main components: the iC2 Remote and the Home Theater Main System Unit (HT-MSU). The iC2 Remote incorporates large buttons and a logical layout of function keys that reflect today's popular and menu-driven sources so anyone in the family can operate complex systems. And, unlike traditional remote controls, the iC2 Remote does not require users to point the remote at the products to be controlled.

The HT-MSU, or the “brains” of the iC2 System, stores the complete system profile (i.e., television, surround receiver, cable boxes, satellite receiver, DVD, etc.). In addition, the HT-MSU can automate functions like lighting control, TV lifts, draperies, projection screens, and more.

The Niles iC2 System gives end users one-touch control of their home theater system and reflects the high quality fit and finish that meets the standards of today's consumers.

Niles is one of the industry's most respected manufacturers of custom installation audio/video components and accessories. To see the complete line of Niles products, visit us on the Internet at: **www.nilesaudio.com**.

FEATURES AND BENEFITS

SIMPLE CONTROL OF COMPLEX SYSTEMS

The iC2 Home Theater Automation and Control System simplifies entertainment by allowing one-touch control of home theater components. Ordinary home theater system controllers require users to turn on (and off) multiple components, resulting in a confusing situation of hunting down the fugitive component that is “off,” when it really should be “on.”

The iC2 System eliminates the confusion—a single touch of any of the eight installer-labeled “activity” keys will initiate an intelligent sequence of commands, so whether you’re playing a DVD or watching a program recorded on your DVR, the iC2 System provides quick and easy access to your entertainment.

A COMPLETE SYSTEM

The iC2 System consists of an ergonomically designed Radio Frequency (RF) tabletop-styled remote control and an “intelligent” Home Theater Main System Unit (HT-MSU). Powerful combinations of hardware and software functions within the Main System Unit manage and automate control of every aspect of a home theater.

BIG BUTTON REMOTE WITH CONVENIENT FEATURES

The iC2 Remote is refreshingly practical with large, customizable source keys and backlighting that can be used in low-light environments and without looking at the buttons. Its rechargeable battery has a long “off-charger” life, and users don’t have to change batteries. The iC2 Remote is a big button remote that can be programmed to control today’s most popular entertainment sources. Large channel up and down keys offer quick channel surfing and a system off key provides one-touch turn off of the entire home theater system.

INTELLIGENT MAIN SYSTEM UNIT

The HT-MSU has both video and 12 Volt sync inputs to manage the power “state” of all your home theater system components. With eight power sensing (synchronization) ports, eight IR (infrared) ports, and eight RS232 (serial) ports and an expansion port, the HT-MSU can control up to 29 devices. The HT-MSU also includes “dry contact closure” relays and 12V trigger outputs that can be used to control things like projector lifts, screens, drapes or lighting; and an “Ethernet” port is included for system expansion, communication to Niles multizone receivers, and future upgrades.



INSTALLATION FLEXIBILITY

With a low profile design, easy-to-access connections, and mounting wings with rack-mount spacing, the HT-MSU can be wall-mounted behind theater components or attached to the back of metal professional racks. The HT-MSU incorporates an infrared pass-through port allowing control over sources that use original remotes, even if the system is hidden from view.

RELIABLE ZIGBEE® RF COMMUNICATION

The iC2 System uses a very reliable 2.4 GHz radio frequency that works extremely well even in RF “noisy” environments. The iC2 System’s 10-channel and 16-network ID capability allows multiple iC2 Systems to be used near each other, as well as in multiple-dwelling units like condos and townhouses.

QUICK AND EASY SET-UP WITH WIZARD-BASED NILES QUICKCONFIG™ PC CONFIGURATION SOFTWARE

An iC2 System configuration can be programmed, saved, and edited using the Niles QuickConfig PC Configuration Software and Niles IR-CS Infrared Capture Station. The QuickConfig software is wizard based and guides the installer/programmer through basic and advanced system designs.

ASSIGNABLE RELAYS AND 12V OUTPUTS

Three dry contact closures and three 12V DC trigger outputs can be independently programmed to give installers greater control of mechanical devices or voltage-triggered power strips and dispersion controlled home theater loudspeakers.

INTELLIGENT INTEGRATION WITH MULTIZONE SYSTEMS

The Home Theater Main System Unit includes control ports that allow the iC2 System to “share” sources with whole-house distributed audio systems. The power state of these “shared” sources can be completely managed so that sources are always powered-on when they need to be and powered-off when both whole-house and home theater systems are turned off.

PROGRAM MEMORY PROTECTION

The entire system profile is stored in non-volatile memory within the HT-MSU. This safeguards against accidental loss of the configuration programming for the entire life of the product under normal use.

CONTENTS

Check that your iC2 Home Theater Automation and Control System contains the following:

- Home Theater Main System Unit (HT-MSU)
- HT-MSU Power Supply
- RF Antenna
- Antenna Wall Bracket
- 10' (3 meters) Antenna Extension Cable
- End User Guide
- iC2 Remote + Battery
- iC2 Remote Charging Power Supply
- Master Key Label Sheet
- 10 iC2 Remote Master Key Caps
- System Configuration Worksheet
- Ferrite Bead

PARTS GUIDE

THE IC2 REMOTE

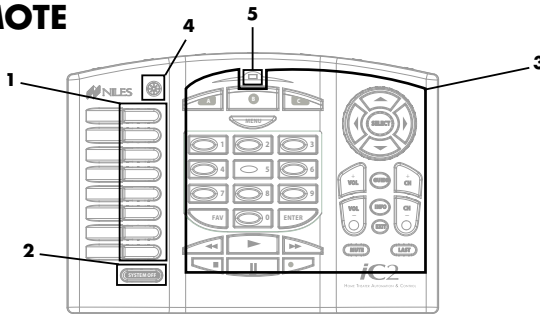

Figure 1. iC2 Remote Front View

1) Master Keys - The eight Master Keys on the left side of the remote can be custom labeled and will initiate the iC2's automation functions when programmed via Niles QuickConfig. Pressing a Master Key will prompt the HT-MSU to check the On/Off status of all of the components in the system and issue the necessary commands so users can enjoy the selected source.

2) System Off Button - When pressed, the Remote will instruct the HT-MSU to check the On/Off status of all the components in the system and issue the necessary commands to power down the system.

3) Function Keys - These 36 Function Keys include the numeric, transport menu navigation mute, volume and channel keys, and can be programmed to control the labeled Master Keys' source functions. The Function Keys can be programmed differently for each Master Key and provide different functionality or sequences.

4) Backlight Button - This button is used to turn on the backlight for use in low light conditions. The backlight will turn off after a short duration (about 10 seconds) and can be programmed for activation.

5) Charging Indicator - The LED is blue when the charging power supply is plugged in and the battery is charging normally. The LED is red if there is a problem with charging the battery.

Figure 2. iC2 Remote Bottom View

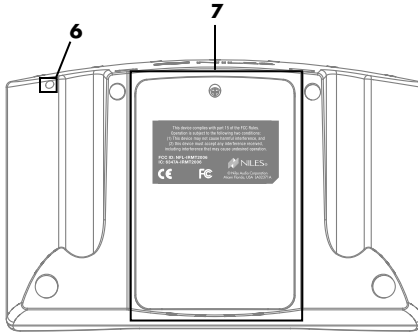

6) Reset Button - This button is used to reset the remote. Should the remote lock up and/or not communicate with the HT-MSU, use a paper clip to access the reset button.

7) Battery Door - The battery compartment is accessed via the battery door, which is secured with a Phillips head screw.

Figure 3. iC2 Remote Rear View

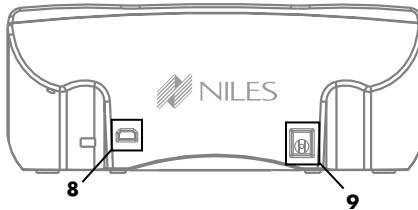

8) USB Connection - The USB connection is a diagnostic connection used by the Niles Audio Corporation Service Center only.

9) Power Connection - This is the connection where the charging power supply connects to the Remote. When the power supply is plugged into the wall outlet, the remote's Master Keys will blink three times to indicate a proper connection. The Charging Indicator LED will be blue while the battery is charging.

THE HOME THEATER MAIN SYSTEM UNIT (HT-MSU)

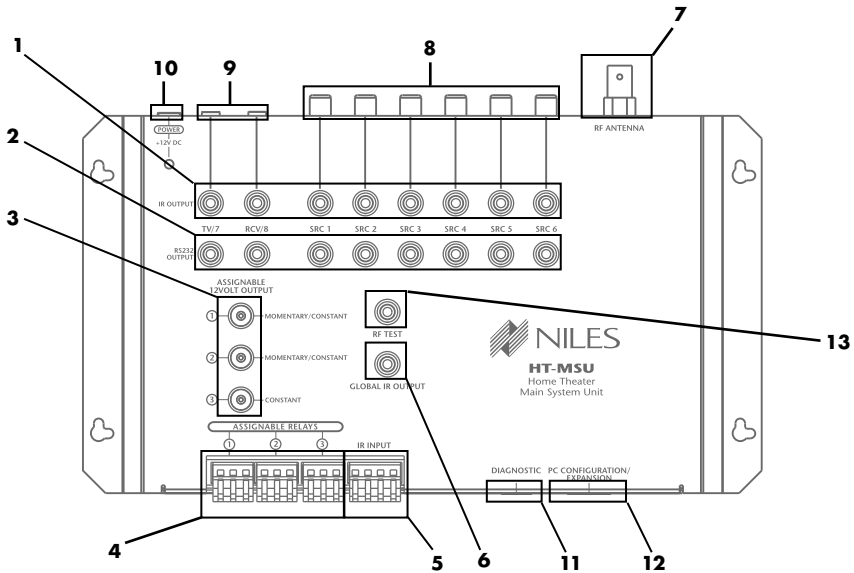

Figure 4. HT-MSU Top View

- 1) IR Outputs** - SRC1 – SRC6, TV/7, RCV/8 are eight dedicated 3.5mm jack source flasher outputs that output IR data specifically for that source.
- 2) RS232 Outputs** - SRC1 – SRC6, TV/7 and RCV/8 are eight dedicated 3.5mm jack source serial outputs that output RS232 data specifically for that source.
- 3) Assignable 12V Outputs** - Three 3.5mm jacks, output 12V DC 150mA when activated:
 - a. 12V outputs 1 & 2 are independent of each other and are programmable to output 12V momentarily or constantly when activated.*
 - b. 12V output 3 is assignable and outputs 12V constantly when active.*
- 4) Assignable Relays** - There are three, 3-position removable quick connect plugs labeled 1, 2 and 3 for connecting either NO (normally open) or NC (normally closed) contact closure devices to the HT-MSU.

(CONTINUED ON NEXT PAGE)

5) IR Input - A 4-position removable quick connect plug for connecting an IR sensor to the HT-MSU. This connection allows IR control of the HT-MSU and/or IR pass-through for connected sources.

6) Global IR Output - A 3.5mm jack provides all IR codes that the HT-MSU generates and all IR codes that come in through the IR Input connection and can be configured via Niles QuickConfig for Normal or High output. Normal output is designed for a Niles MF1 IR MicroFlasher®; high output is designed for a Niles IRB1 High-Output IR Flasher.

7) RF Antenna Socket - The BNC connector accommodates the supplied antenna. The antenna must be installed perpendicular to the ground for best results. A 10 foot (3 meter) antenna extension cable and mounting bracket are included if remote installation of the antenna is necessary.

8) Status 12V or Video - Six video and voltage-sensing RCA sync inputs for sources 1 through 6 detect when a source is on/off for reliable system activation.

9) Status 12V - Two voltage-sensing 3.5mm jacks for sources TV/7 and RCV/8 detect when those sources are on/off for reliable system activation.

10) Power 12V DC - A barrel connection for the provided 12V DC power supply.

11) Diagnostic - A USB A connection for Niles Service Center.

12) PC Connection/Expansion - A RJ45 connection used to plug in a laptop computer for system configuration programming or expanding the system design out to future Niles multizone receivers. Niles QuickConfig is used for system configuration.

13) RF Test - A 3.5mm jack used to connect the optional Niles IR/RF tester for testing RF reception.

SYSTEM DESIGN CONSIDERATIONS

The Niles iC2 System is a highly flexible tool that allows system designers to create home theater systems that will delight customers. Simplicity in operation is at the core of the iC2 System's design. Features like HDMI video switching surround receivers and televisions, high-definition DSS satellite receivers, and DVD managing media servers can make home theater systems extremely difficult to operate. The following section explains just some of the system design features of the Niles iC2 System.

To fully understand the system configurations, it's important to understand the basic control sections of the HT-MSU.

IR OUTPUT PORTS

IR (Infrared) codes are stored in the HT-MSU during configuration programming. The labels of the IR Outputs identify what source number these ports are designed to operate. SRC1 means source 1. The outputs are labeled SRC1 through SRC6, TV/7 and RCV/8. If the TV is to be controlled via IR codes, then the IR Output TV/7 port should be used. However, if the TV will be controlled via RS232, then the TV/7 IR output can be used to control an alternate IR source. These IR outputs are dedicated and routed, meaning IR codes stored for source number 3 (i.e. a DVD player) can only be emitted from the IR output port labeled SRC3. RCV/8 can be used either for the receiver in the home theater or a source number 8.

RS232 OUTPUT PORTS

RS232 is a serial device control protocol that allows sources to be controlled via a transmit-receive cable (See the Installation section for wiring information). RS232 codes are stored in the HT-MSU as string codes during configuration programming. The labels of the RS232 outputs identify what source number they are designed to operate. SRC1 means source 1. The outputs are labeled SRC1 through SRC6, TV/7 and RCV/8. If the TV is to be controlled via RS232 codes, then the RS232 TV/7 port should be used. However, if the TV will be controlled via IR, then the RS232 TV/7 port can be used to control an alternate RS232 source. These RS232 outputs are dedicated and routed, meaning RS232 codes stored for source number 3 (i.e. a DVD player) can only be emitted from the RS232 output port labeled SRC3. RCV/8 can be used either for the receiver in the home theater or a source number 8.



SOURCE POWER STATUS CONNECTIONS

To properly automate home theater sources, the HT-MSU needs to “know” when the source is powered On or Off. There are three ways that sources are powered on:

- 1. Toggle Power:** *A source via its remote control has one button for turning that source On and Off. When trying to automate such a device, you must provide the HT-MSU the “Power Status” as feedback using the Status connection on the HT-MSU’s top edge (detailed below).*
- 2. Separate On and Off Power:** *A source via its remote control has one button to turn the source On and a different button to turn the source Off. When trying to automate such an IR device, you should provide the HT-MSU the “Power Status” as feedback so the iC2 System will act faster using the Status connection on the HT-MSU. If a source is to be controlled via RS232 and it has separate On and Off codes, you do not need to provide the HT-MSU feedback.*
- 3. Latching Power:** *Latching power is an industry term that means the source has no power command/s on its remote control. A latching power source may have a “hard” power button on the front panel. To determine if a source is latching power, push its “hard” power button in, take its power cord and plug it into a live AC power outlet. If it turns on when plugged into the outlet and turns off when unplugged from the outlet, it is a latching power source. Latching power sources do not need a Power Status connection, but you will want to do one of two things:*
 - a. Plug it into the switched outlet of the receiver, or*
 - b. Use a Niles AC-3 Voltage Triggered Power Strip connected to one of the assignable 12V outputs on the HT-MSU. Use the QuickConfig Software to program the assigned 12V output to turn on when that source is selected. (See QuickConfig manual for more details on programming 12V outputs.)*

*Along the top edge of the HT-MSU are the source-specific status connections labeled SRC1 through SRC6. These RCA jacks are designed to sense either 12 Volts or video so the HT-MSU “knows” when the source is On or Off. You must use these connections if the source you are trying to automate is IR controlled and uses toggle power (see **1. Toggle Power** above).*

If the source has a video out jack, connect the video output to the corresponding SRC Status RCA jack on the HT-MSU. If the source has no video output jack, you may use one of the Niles external-sensing devices that provides 12V output (i.e., the CS12V Current Sensor or the LS-1 Light Sensor) connected to the RCA Status jack.

ASSIGNABLE 12 VOLT OUTPUTS

These three ports are completely assignable and can be used to trigger out-board automation devices such as:

- *12V Triggered AC Power strips like the Niles AC-3*
- *12V Triggered subwoofers like the Niles SW300, SW12, SW10, and Pro15SW*
- *12V Triggered Dipole/Bipole rear effects speakers like the StageFront IW650FX*
- *Motorized drapery systems and projection screens*

12V Output #1 has a default setting to output 12V DC whenever the home theater receiver is turned on by the HT-MSU Master Key activity setting.

12V Output #2 has a default setting to output 12V DC whenever the HT-MSU Master Key activity setting turns on the TV.

12V Output #3 has no default and is completely assignable.

The three assignable 12V outputs can be configured (programmed) using the Niles QuickConfig Software.

ASSIGNABLE RELAYS

There are three independently assignable dry contact closures/relays. These connections can be used to trigger lights, curtains, screen lifts, and other devices. Use the Normally Open or Normally Closed side of the contact closure to complete the circuit to control the device.



SYSTEM CONFIGURATION 1

SINGLE TV WITH A COMBINATION OF IR AND RS232 CONTROLLABLE SOURCES

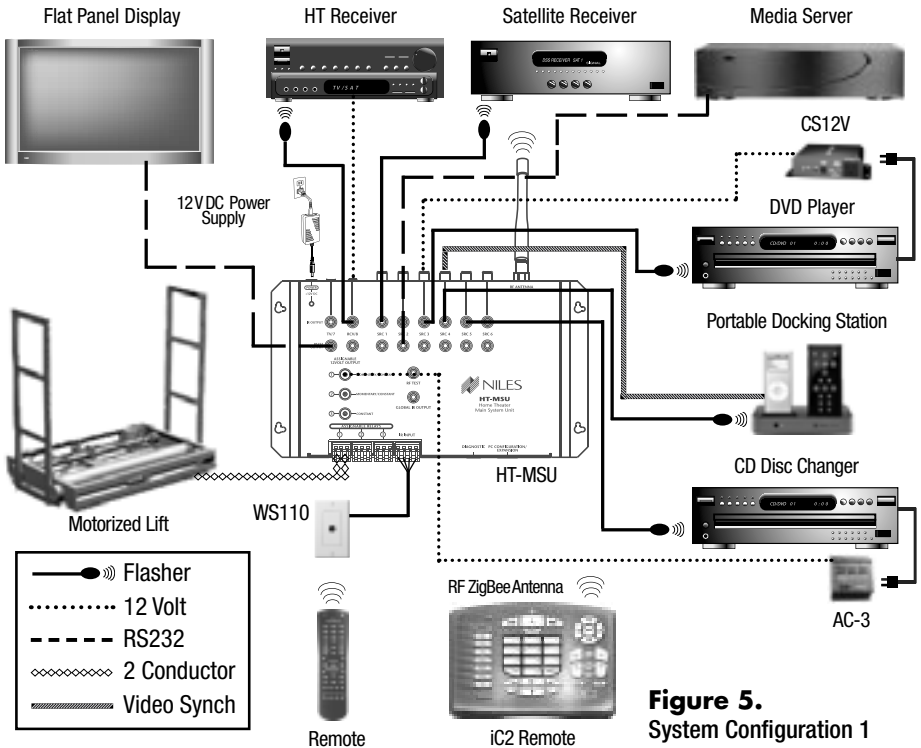

In System Configuration #1 (**Figure 5**), the flat panel TV is controlled via the RS232 connection TV/7 on the HT-MSU. A motorized lift to raise and lower the TV is being activated using the programmable assignable Relay #1. The surround receiver is being controlled via IR flasher connected to the RCV/8 connection on the HT-MSU. The surround receiver's power status is being monitored by a Niles 12V DC power supply plugged into the receiver's switched AC outlet and then plugged into RCV/8 Status 12V connection on the HT-MSU. In addition to the TV and receiver, there are five sources. The DSS Satellite receiver is being controlled via IR from the IR SRC1 port. There is no status connection to the HT-MSU because it has separate On/Off codes. The Media Server is being controlled via the RS232 SRC2 port. The DVD player is being controlled via the IR SRC3 port, and a CS12V Current Sensor connected to the SRC3 Status RCA jack is providing the status. IR connected to the IR SRC4 is controlling the portable Music Player in its dock, and video is providing the status connected to the SRC4 Status RCA jack. IR connected to the IR SRC5 port is controlling a latching power CD player and, using the 12V Output # 1, triggering a Niles AC-3 to power it On and Off. A Niles IR sensor is connected to the IR sensor input so the customers can still use the original remote to control the media server.

SYSTEM CONFIGURATION 2

DUAL TV MODE AND INTEGRATION WITH AN IR CONTROLLED MULTIZONE RECEIVER

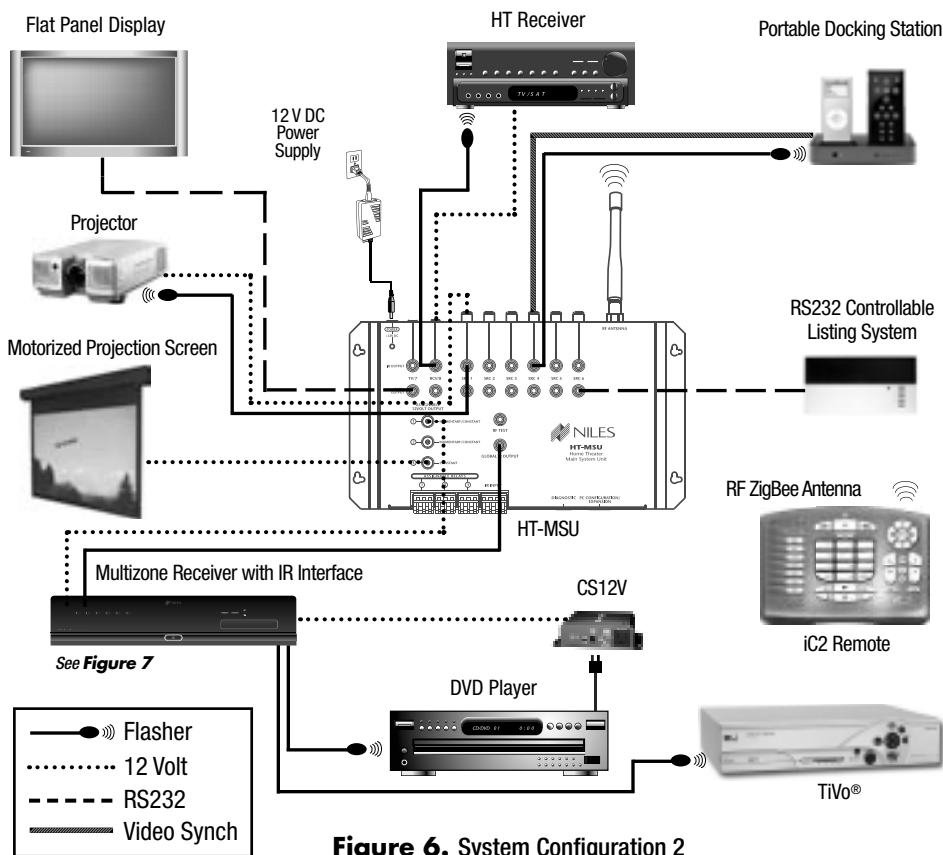

Figure 6. System Configuration 2

System Configuration #2 (**Figure 6**) demonstrates the Dual TV Mode feature of the iC2 System. The flat panel TV is controlled via RS232 on the HT-MSU RS232 TV/7 port. This is considered the default TV. The customer also has a projector and screen used only when the theater room is dark. The projector is configured (programmed) with Niles QuickConfig Software to be TV2 and is wired for IR control to the HT-MSU IR SRC1 port. The Status of TV2 is connected to the HT-MSU IR SRC1 RCA connection using the 12V output of the projector (usually used to trigger the screen). The projection screen is being triggered by the HT-MSU 12V Output #3. When the first Master Key on the iC2 Remote is pressed from an all off mode, the default TV (the flat panel TV, TV1) is turned on. Master Key 8 is labeled SWAP TV. When the SWAP TV Master Key is pressed, TV1 (flat panel) is turned off and TV2 (the projector) is turned on, and the screen is lowered for viewing. The Dual TV Feature is not limited to IR controllable TVs. Either TV can be RS232 controllable.

NOTE: IN DUAL TV MODE, ONLY ONE TV IS ON AT A TIME. BOTH TVS CANNOT BE ON AT THE SAME TIME.



System Configuration #2 also shows an RS232 controllable lighting system connected to the HT-MSU RS232 SRC6 port. In this configuration, there are 2 sources (a DVD and a DSS satellite receiver) being “shared” with the house-wide multizone distributed audio receiver. The HT-MSU sends IR codes for both of the shared sources out of the Global IR Output port into the multizone’s IR IN port. The HT-MSU’s 12V Output #1 is connected to the multizone’s HT SYNC port, which ensures that the “shared” sources are turned On and Off correctly. The multizone “knows” that the home theater system is On or Off via this 12V connection.

SYSTEM CONFIGURATION 3

TV ARRAY MODE AND INTEGRATION WITH A RFG

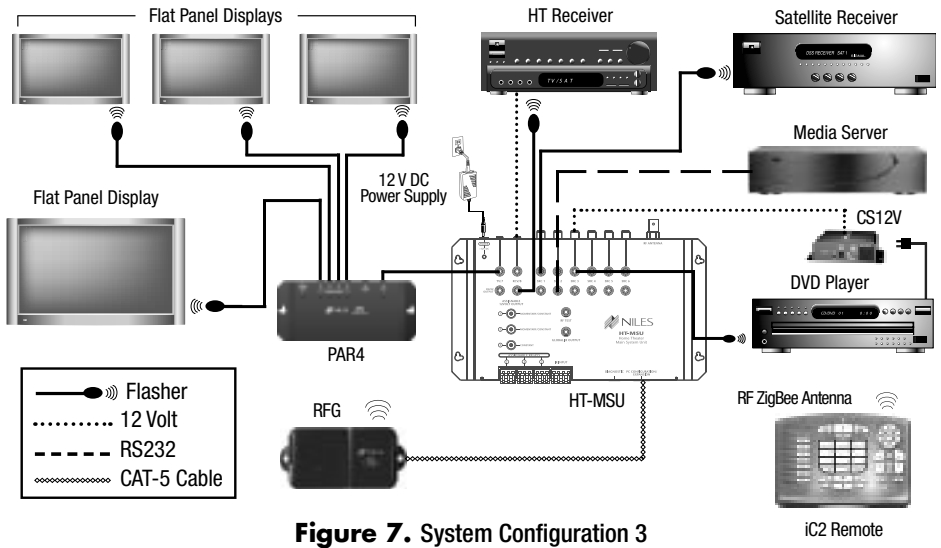

Figure 7. System Configuration 3

System Configuration #3 (**Figure 7**), shows two more system design features of the iC2 System. The iC2 System has a design feature called TV Array. Here, a Niles PAR4 Simplified IR Router is used with the HT-MSU to control an array of identical televisions.

NOTE: IN ORDER TO USE THE TV ARRAY FEATURE, ALL OF THE TVS NEED TO BE IDENTICAL OR RESPOND TO THE SAME IR CODES. ADDITIONALLY, THE TVS MUST HAVE SEPARATE ON AND OFF POWER COMMANDS AND DIRECT ACCESS INPUT COMMANDS.

A Niles 3.5mm to 3.5mm cable connects the PAR4 to the HT-MSU's IR TV/7 port. On the Niles PAR4, Niles MicroFlashers are connected to the numbered outputs 1 through 4. The main TV should be connected to the PAR4 #1 output. When the end user presses any Master Key from an All Off situation, the Main TV (PAR4 #1) turns on. Master Key 8 is labeled TV Array. Press the TV Array Master Key (Master Key 8), then press one of the number keys 1, 2, 3 or 4. This allows the end user to control that TV in the array of TVs. Two Niles PAR4s can be used for a maximum of 8 TVs in the TV array.

The final design feature in System Configuration #3 uses a Niles Radio Frequency Gateway (RFG) to extend the antenna away from the HT-MSU. The Niles iC2 HT-MSU comes with an RF antenna that can be connected directly to the HT-MSU antenna socket. Reception range is approximately 75 feet (22.86 meters). We recommend using the 10 foot antenna extension cable to position the RF antenna away from the home theater sources. Use the extension cable and the antenna bracket to get the antenna up and away from all of the products that can cause interference with RF reception. Keep in mind that the reception range may not be enough if all of the home theater gear is located in another room further away than 75 feet (22.86 meters). A Niles RFG is an optional device that can be used to move the RF radio antenna up to 330 feet (100 meters) away from the HT-MSU. The RFG is connected to the HT-MSU via CAT-5 cable. (Please refer to the Installation Section for the importance of terminating CAT-5 cable with the T568A standard). Niles QuickConfig Software will ask if a Niles RFG is being used to aid in set-up.

INSTALLATION CONSIDERATIONS

PLACEMENT OF THE HT-MSU

Niles recommends placing the HT-MSU conveniently close to the equipment it is controlling. Generally, the unit should be placed in a concealed location because its indicator and connections are only used during installation. Placement possibilities include:

- 1) *Wall-mount (affixed to the back of the equipment cabinet or a nearby wall) (Figure 8)*
- 2) *Rack-mount (attached to the back of a professional 19-inch standard equipment rack that uses traditional 1, 2 or 3 "u" hole spacing (e.g. Middle Atlantic))*
- 3) *Table-top (on the floor or shelf behind the equipment)*

ANTENNA CONSIDERATIONS

Communication between the iC2 Remote and the HT-MSU is an RF-based with a frequency of 2.4 GHz. Effective range of the iC2 Remote to HT-MSU communication is 75 feet (22.86 meters) open air. The RF antenna can be attached directly to the HT-MSU with the provision that the antenna is vertical for best reception.

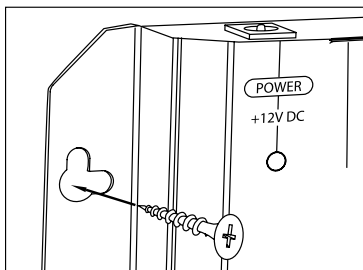

Figure 8. Wall-mount placement
Use sheetrock screws

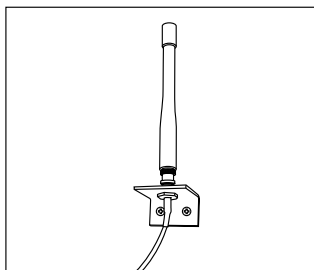

Figure 9. Vertical alignment of antenna is necessary for optimal reception

The HT-MSU is supplied with a 10 foot antenna extension cable to allow the antenna to be placed away from the HT-MSU. An antenna wall-bracket is also supplied so the antenna can be attached high on the wall behind the equipment.

NOTE: HOME THEATER EQUIPMENT, DIGITAL SOURCES AND RACKS ARE MADE OUT OF METAL AND CAN CAUSE INTERFERENCE OR "SHADOWS" IN RF RECEPTION. NILES HIGHLY RECOMMENDS YOU PLACE THE ANTENNA AS HIGH AS POSSIBLE AND AWAY FROM THE MAIN SOURCE GEAR AND EQUIPMENT RACK.

The Niles Radio Frequency Gateway (RFG) is available as an option and can be used instead of the supplied antenna. The RFG allows the "radio antenna" to be placed up to 330 feet (100 meters) away from the HT-MSU. It can also be used if the HT-MSU (and home theater gear the HT-MSU is controlling) is further than the effective range of communications (75 feet/22.86 meters open air).

WIRING CONSIDERATIONS

The HT-MSU requires several different types of wires runs:

- 1) Antenna Cable:** *The supplied extension cable is 10 foot long and is a RG59 CL rated cable so it can be run through the wall. Extending the cable or using longer cable is not recommended as this will drastically affect the RF reception.*
- 2) Flasher Cable:** *Niles infrared flashers (not supplied with the iC2 System) include a 10 foot cable. Flasher wires can be extended up to 200 foot (61 meters) using 2-conductor 22 gauge ("zip-cord"). Shielding is not necessary for a flasher.*
- 3) RS232 Cable:** *The HT-MSU can control home theater sources using one-way RS232 control cable. Niles does not supply RS232 cables. Home theater sources that are RS232 control capable will usually supply or recommend the wire and the pin-out that will control their devices. Traditionally, RS232 one-way communication can be sent over three wires (transmit, receive and ground), but not for very long distances. (Niles recommends placing the HT-MSU in close proximity to the sources it is controlling.)*
- 4) Status Wiring:** *The Niles HT-MSU has status (power synchronization) ports for eight home theater sources. The status connections for sources 1 through 6 (labeled SRC1 – SRC6) are RCA jacks that can sense video or a 12V DC voltage signal. The TV/7 and RCV/8 (receiver) status connections are 3.5mm jacks that sense voltage signals. When using video for status, a standard RCA cable can be used from that source. Alternatively, when using 12V for status, a standard 22 gauge, 2-conductor cable ("zip-cord") can be used. Niles Accessory Cables (FG00724 or FG00933) can also be used (SEE THE ACCESSORIES SECTION FOR MORE INFORMATION).*

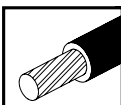

TECH TIP

WIRE SIZE IS EXPRESSED BY ITS AWG (AMERICAN WIRE GAUGE) NUMBER — THE LOWER THE NUMBER, THE LARGER THE WIRE, FOR EXAMPLE, 20 AWG IS PHYSICALLY LARGER THAN 22 AWG.

5) **12V Output and Relay Wiring:** The HT-MSU has three 12V and three “Dry Contact Closure” Relay Outputs that can activate mechanical devices such as motorized drapery and projection screen systems, as well as a number of other automation devices. For each device these outputs will control, standard 22 gauge 2-conductor cable (“zip-cord”) can be used. Niles Accessory Cables (FG00724 or FG00933) can also be used (SEE THE ACCESSORIES SECTION FOR MORE INFORMATION).

6) **IR Sensor Wire:** The HT-MSU has an infrared (IR) sensor input for connection to any type of Niles IR sensor. Niles IR sensors utilize 4-conductor wiring and have been designed for use with CAT-5 cable (4-pair twisted) (**Figure 10**).

7) **Expansion Cable:** The HT-MSU has an Expansion connection that can be used to extend the built-in RF radio away from the HT-MSU and/or for connection to and “sharing” sources with future Niles multizone receivers (SEE SYSTEM CONFIGURATION #3 IN THE SYSTEM DESIGN CONSIDERATIONS SECTION). This cable must be CAT-5 terminated with RJ45 connectors (T568A TERMINATION PROTOCOL IS SHOWN IN THE INSTALLATION SECTION 7).

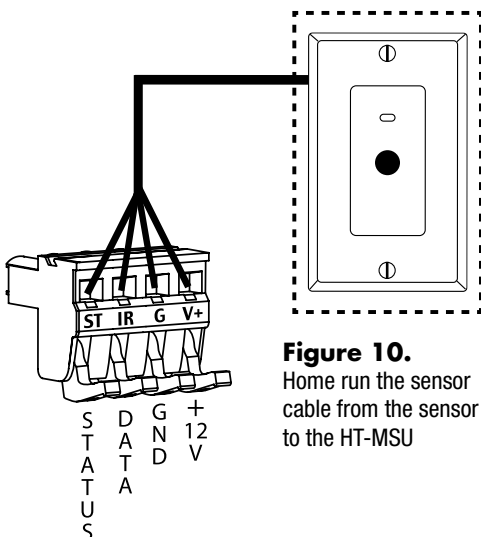

Figure 10. Home run the sensor cable from the sensor to the HT-MSU

PROGRAMMING PREPARATIONS AND WORKSHEET

The HT-MSU has a PC Configuration/Expansion port on the bottom edge that is used for configuring (programming) the system. The use of this port for configuration will be based on one of the following scenarios:

- 1) If the HT-MSU is being used by itself, the PC Configuration/Expansion port will be empty and used to program the system (**Figure 11**).
- 2) If your iC2 System design involves a Radio Frequency Gateway (RFG), CAT-5 cable will already be plugged into the PC Configuration/Expansion port and that cable would be plugged into the “Keypad” connection port of the RFG. Connect a CAT-5 cable to the “System” connection port of the RFG. Programming the iC2 System and the RFG is now accomplished “through” the RFG (**Figure 12**).

3) If your system design involves a RFG and sharing sources with a future Niles multizone receiver (see System Configuration #3 in the System Design Considerations section), the programming connection must be made on a future Niles multizone receivers' Communication and Control connection ports. Configuration of the entire system can be accomplished with one connection and the Niles QuickConfig Configuration wizard-based software "through" future Niles multizone receivers.

A Worksheet is provided with the iC2 System and should be used to organize all of the information an installer will need to configure the iC2 System. The iC2 System worksheet is also available on the Niles website: www.nilesaudio.com

Figure 11. PC connection for programming

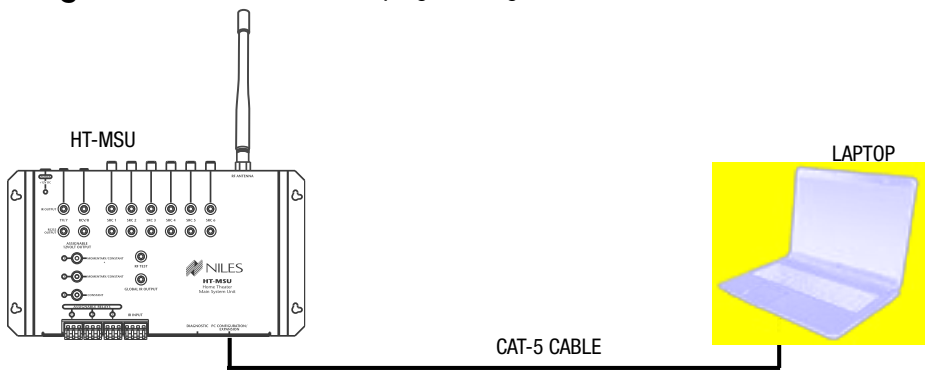
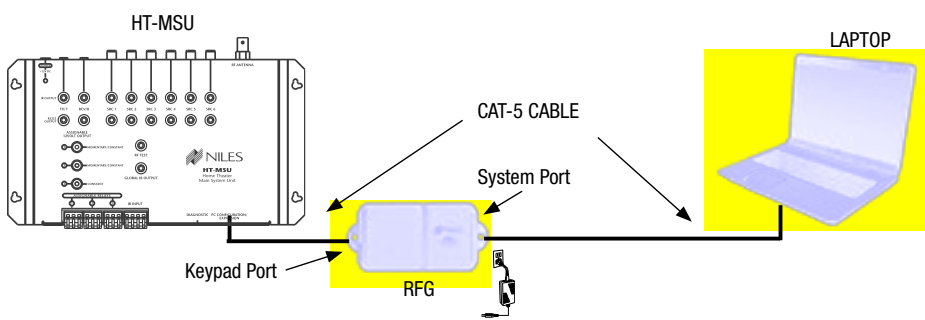

Figure 12. PC connection for programming when using optional RFG.



INSTALLATION

Before you begin, make sure that all of the cables and wires, as well as the power supply cable will reach the proposed location of the HT-MSU. Mark the cables with labels that describe where the cable originates (rather than which terminal on the HT-MSU it connects to).

STEPS:

1) IC2 REMOTE BATTERY

The iC2 Remote rechargeable battery needs to be connected and charged. The installer needs to remove the battery cover with a Phillips screwdriver. The plug on the battery is keyed and only allows it to be plugged in one way. Plug in the battery and position it in the compartment next to the positioning foam.

2) LABEL THE MASTER KEYS ON THE IC2 REMOTE

The Master Keys on the iC2 Remote can be labeled using the supplied label sheet and plastic key caps. The iC2 worksheets should be filled out prior to labeling the Master Keys. Based on the worksheet, peel off the appropriate label from the sheet and place it on the corresponding Master Key. The plastic key caps are molded with one end rounded and the other flat. Orient the key cap correctly over the Master Key; push the key cap down on the Master Key until it sits flush with the molded portion of the iC2 Remote.

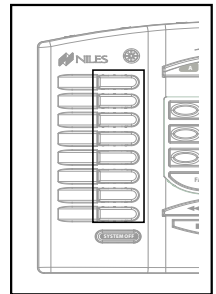

Figure 13.

iC2 Remote's 8 custom label Master Keys

3) CONNECT THE CHARGING POWER SUPPLY

The rechargeable battery for the iC2 Remote may still have a charge, but we recommend plugging the iC2 Remote to the charging power supply. The iC2 System comes with two identical power DC power supplies. Choose one of them and plug the outlet-plug end into an unswitched AC outlet. Pass the power cable through the supplied ferrite bead, wrap the cable around the bead twice, leaving the power plug as you clip the bead closed.

Figure 14. Ferrite bead on iC2 Remote power supply cable

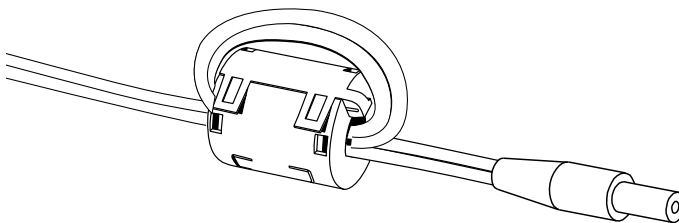

Plug the barrel end into the back of the iC2 Remote. When the power supply has been properly plugged in, the backlighting for the buttons will flash twice and the charging LED will turn blue to indicate that the battery is charging. When the battery has a full charge, the LED will not light. If the charging LED lights red, there is a fault with the battery. If this happens, unplug the power supply, wait two minutes, and re-plug in the power supply. If the LED is still red, contact Niles Service Center.

4) CONNECT POWER TO THE HT-MSU. CHECK LED, DISCONNECT POWER

Plug the supplied 12V DC power supply into an unswitched AC outlet. Plug the connector into the socket marked "Power" on the HT-MSU. If the Power LED does not light, test the unswitched AC outlet with another appliance. If the outlet tests OK, you have a defective power supply, which must be replaced for you to continue. Once you have completed the power supply test, unplug the power supply and continue hooking up the rest of the wires and cables.

5) CONNECT ALL FLASHERS

Route the connecting wire to the HT-MSU. Connect the 3.5mm mono plug into the corresponding SRC jack labeled "IR Output" from the installation worksheet. If you need to extend the wire, use a 2-conductor 16 gauge or larger (SEE "TECH TIP ON PAGE 15).

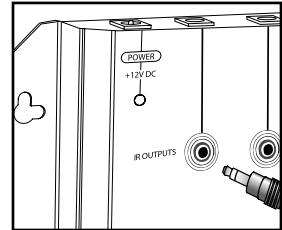

Figure 15.

Flasher connection on HT-MSU

6) CONNECT ALL RS232

The RS232 Output jacks use 3.5mm STEREO plug with standard TRS (Tip, Ring and Sleeve) configuration of Transmit, Receive, and Ground. This may require the installer to custom make the connection to the corresponding source. Most RS232 controllable sources use one of the following as its RS232 input connector:

- a) A Male DB9 connector
- b) A Female DB9 connector
- c) A 3.5mm stereo input jack

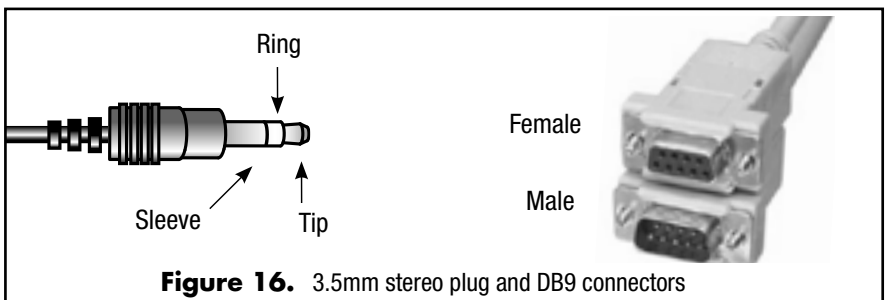

Figure 16. 3.5mm stereo plug and DB9 connectors

Most sources that are RS232 controllable provide a protocol document (usually from their Tech Support Department) that will have all of the necessary information, including pin-out, to custom build the RS232 control cable (Figure 16).

7) CONNECT ALL STATUS

There are two types of status (power synchronization) ports on the HT-MSU: the TV/7 and RCV/8 status connections are 3.5mm mono ports; and SRC1 through SRC6 status connections are RCA jack ports. The TV/7 and RCV/8 status connections are voltage-sensing ports "looking for" 12V DC Volt input. The most common technique for "synching" the home theater receiver is to use a Niles 12V (FG01035) power supply plugged into the receiver's switched outlet, and plugging the 3.5mm jack into the RCV/8 Status connection port. The most common way to "synch" the TV (which usually doesn't have a switched AC outlet on the back) is to use one of the Niles synching accessories like the CS12V Current Sensor or LS-1 Light Sensor. Both of these synching accessories have 12V outputs that can be connected to the HT-MSU using a 3.5mm mono jack plugged into the TV/7 status port.

The SRC1 through SRC6 RCA connections are RCA jack ports that are "looking" for either voltage or a video signal from the source. If a DVD is to be hooked up as SRC2 (use the worksheets to help with source connection layouts), an RCA video cable would be used to connect the DVD's composite video output to the SRC2 RCA Status connection port. If the DVD has only one composite video output, and that is being used to show video on the TV, an RCA Y-adaptor can be used to split the video output (of the DVD) for both the TV signal and Status connection to the HT-MSU.

IMPORTANT NOTE: RCA SOURCE STATUS INPUTS ARE DESIGNED WITH HIGH-INPUT IMPEDANCES IN ORDER TO PRESERVE THE QUALITY OF THE VIDEO SIGNAL WHEN USING A RCA Y-ADAPTOR.

If the source to be "synched" doesn't have a video output, one of the Niles Synching Accessories can be used instead of video. Most Niles Synching Accessories use a 3.5mm jack as the output. This 3.5mm jack must be changed to mate with the RCA connector on the HT-MSU; use a Radio Shack 274-897 OR 274-330 mini-plug to male RCA adapter.

8) CONNECT 12V

The 12V trigger output jacks use 3.5mm mono plug with standard "Tip and Collar" configuration. The tip is 12V DC 150mA when activated and the collar is ground. Niles has two accessory cables for use with these 12V output jacks (FG00724 or FG00933). Simply plug one of these cables with a 3.5mm mono plug into one of the three assignable jacks. Plug the other end of the cable into the device that will be triggered or activated.

The Niles QuickConfig Software is used to assign (program) the functionality of these jacks. The configuration software allows the 12V output to be programmed as follows:

- a) Output #1 can be configured to output 12V constantly or momentarily. A momentary output would be used to activate a device that requires a pulse of 12V instead of a constant 12V. The pulse can be programmed for 1, 3 or 5 seconds, then off when activated. The constant mode will output 12V continuously when activated, and no 12V when deactivated.
- b) Output #2 can be programmed just like Output #1, but completely independent of output #1.
- c) Output #3 configured for constant output only when activated, but is also completely independent of outputs 1 and 2.

Please refer to the Niles QuickConfig Configuration manual for more information about the 12V output programmability.

9) CONNECT RELAYS

The “Dry Contact Closure” relays use 2-conductor wire to pair either the NO “Normally Open” or NC “Normally Closed” side of the removable connector plug with the “Common”. NO or NC is determined by which device you are triggering. Strip 1/4 inch of the insulation from the end of each wire, and tightly twist the end of each wire until no frayed ends remain. Use a small flathead screwdriver or your fingernail to raise the locking tabs, exposing the holes on the removable connector. Insert each wire into the appropriate hole on the removable connector plug (**Figure 17**) and snap the locking tab down. To help you, the connector plug is keyed. Insert the smooth side of the connector plug into the smooth side of the socket.

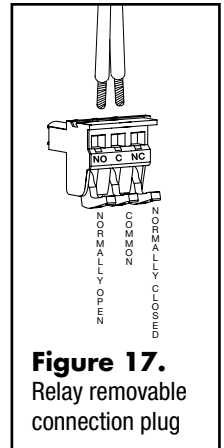

10) CONNECT THE SENSOR CABLE TO IR INPUT

Strip 1/4 inch of the insulation from the end of each wire. Tightly twist the end of each wire until no frayed ends remain. Use a small flathead screwdriver or your fingernail to raise the locking tabs, exposing the holes on the removable connector. Insert each wire into the appropriate hole on the removable connector plug (**Figure 18**) and snap the locking tab down. To help you, the connector plug is keyed. Insert the smooth side of the connector plug into the smooth side of the socket.

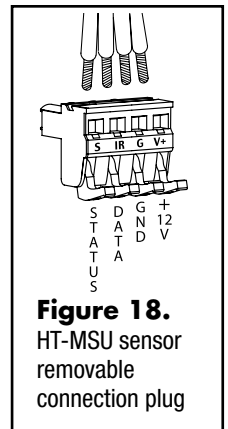

INSTALLATION

11) CONNECT ANTENNA

To attach the RF antenna to the HT-MSU, push the antenna down on the antenna socket of the HT-MSU and twist to the right (you will feel a click or stop when the antenna is completely on).

12) EXTEND AND MOUNT THE ANTENNA

Niles supplies a 10 foot extension cable and antenna bracket for mounting the antenna away from the home theater sources. Make sure the antenna extension cable will reach the antenna mount without snagging or twisting with the other cables needed for the HT-MSU. If you're mounting the HT-MSU to the back of the metal professional equipment rack that slides-out (for easy access to the wires), make sure that, when the rack is fully extended, the antenna extension cable will reach without being stretched or pinched when the rack is slid back into place. To attach the antenna extension cable to the HT-MSU, push the connector down on the antenna socket of the HT-MSU and twist to the right (you will feel a click or stop when the connector is completely on).

Use a pencil to mark the location of the antenna bracket. **(Figure 19)** Then, use two dry-wall screws to attach the antenna bracket to the mounting surface. Unscrew the nut from the antenna end of the antenna extension cable; put the antenna connector end through the hole in the bracket. Attach the nut back on the antenna connector end of the cable to tighten the cable to the bracket. Attach the RF antenna to the connector/wall bracket combo; twist to the right **(Figure 20)**. You will feel a click or stop when the antenna is completely on.

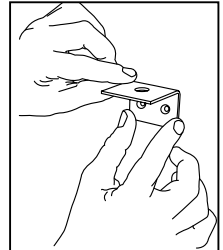

Figure 19.

Vertical alignment of antenna is necessary for optimal reception

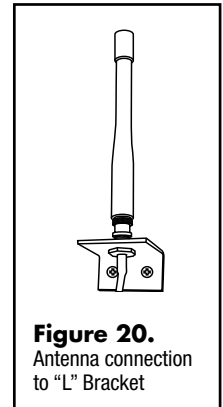

Figure 20.

Antenna connection to "L" Bracket

13) CONNECT EXPANSION CAT-5 CABLE

If connecting the HT-MSU to a Niles Radio Frequency Gateway instead of attaching the supplied antenna (SEE THE SYSTEM DESIGN CONSIDERATION SECTION, CONFIGURATION #3), use CAT-5 cable terminated with RJ45 connection plugs. The CAT-5 cable must be terminated using the T568A standard wiring **(Figure 21)**.

14) RE-CONNECT POWER TO THE HT-MSU

You are now ready to program the Niles iC2 System.

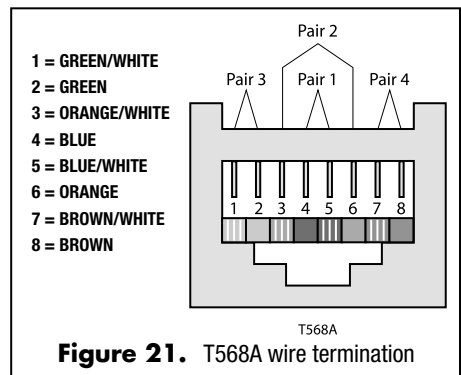

Figure 21. T568A wire termination

TROUBLESHOOTING

The iC2 System is a configurable system (i.e., the product arrives “empty” and must be programmed by the installer). Troubleshooting generally occurs after the iC2 is programmed; however, the iC2 System can be divided into two main areas, and some troubleshooting can occur prior to programming:

- 1) *Hardware Issues*
- 2) *Programming (refer to the Niles QuickConfig Configuration Software Manual for more information on programming troubleshooting)*

HARDWARE ISSUES

There are three basic issues that can prevent proper operation of the iC2 system. These issues are presented in the order of probability and are as follows:

PROBLEM:

1. Bad Connections or Wiring

If the connections or wiring are wrong, loose, shorted or open, the system will not operate properly. The symptoms could include: Power LED flickers or is off, IR/RF Test LED is continuously flickering or on without any iC2 remote use, intermittent operation or no operation.

SOLUTIONS:

- *Test your power supply connections*
- *Test your Flasher connections*
- *Test your Sensor connection*
- *Test your cable for shorts and opens*

2. RF or Electromagnetic Interference

Digital sources, poorly shielded sources, cordless telephones, cell phones, high-definition television sets, light dimming controls and other sources of electromagnetic fields can induce radio frequency noise and interference into your home theater automation system. The symptoms could include: Flashback LEDs on IR/RF Tester continuously flickering or on without any iC2 remote use, poor range, intermittent operation or no operation.

The Niles IR/RF Tester (stock number FG00727) is a troubleshooting tool to aid in diagnosing hardware issues with the iC2 System (Figure 22). It is not required for operation and, therefore, is sold separately. The IR/RF Tester has two LEDs (one red, one green) and can be plugged into IR Output ports to diagnose whether or not the HT-MSU is issuing IR codes out of individual ports.

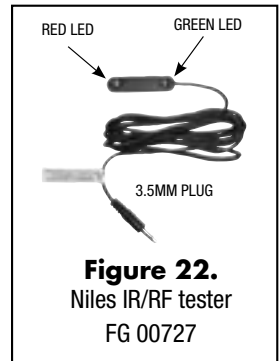

Figure 22.
Niles IR/RF tester
FG 00727

[This can also be accomplished using Niles MicroFlashers that provide visible feedback (see the Accessories section for more information).] The IR/RF Tester can also be plugged into the RF Test port to verify that the HT-MSU is receiving and sending RF information from the iC2 Remote. Plug the IR/RF Tester 3.5mm jack into the RF Test port. Place the LED housing with the two LEDs where it can be seen. The green LED on the IR/RF Tester should flicker when a button is pressed on the iC2 Remote. The red LED should flicker when the HT-MSU sends information back to the iC2 Remote. If either the LED on the IR/RF Tester stays lit, there may be RF interference. Disconnect the antenna from the HT-MSU to see if the LEDs go out.

3. Source Powering On or Off Incorrectly

To automate sources correctly, the HT-MSU requires status feedback from sources that have a single-toggle power command. The HT-MSU either “sees” or doesn’t “see” control signals at the Status ports. If the HT-MSU sees improper or intermittent status feedback (i.e., the HT-MSU may “think” that the source is off when it may really be powered on), the operation of the iC2 System is compromised.

The symptoms could include: sources staying on when the System Off button is pressed; a source turns on for a Master Key and off when that Master Key is pressed again; and sources not turning on at all. The most important tool for troubleshooting this issue is knowledge. Knowing the functionality of the sources being used with the iC2 System is paramount. For example, we know that most DVD players require choosing composite/component video output, even digital HDMI or DVI output. When set for component or digital video output, the composite video output is sometimes disabled. If a DVD player is set for digital video output and it disables the composite video output, you cannot use the composite video output for status connection to the HT-MSU. Because there will never be a signal at the composite output, the HT-MSU will think that the DVD is always off and issue the power command. This will cause the DVD player to be turned on the first time a Master Key is pressed and turned off the second time the same Master Key is pressed.

Status feedback is tested when configuring the iC2 System using the Niles QuickConfig Software. After the transfer screen in the software, there is a Functionality Test Screen that allows the software to test the configuration stored in the HT-MSU while providing feedback on the screen of the programming laptop. The feedback provided is real-time status feedback for Status Ports SRC1 through SRC6 as well as the TV/7 and RCV/8 ports. The Functionality Test Screen also allows for feedback on the Assignable 12V Output and relay ports.

ACCESSORIES

FLASHERS

MF1 IR MICROFLASHER

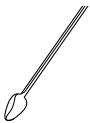

FG01019
10' cable with a 3.5mm plug.
Includes elastomer-style blocking cover for curved surfaces

MF1VF IR MICROFLASHER



FG01020
10' cable with a 3.5mm plug

IRB1 HIGH-OUTPUT IR FLASHER®

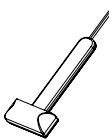

FG01023
IR Flasher can be mounted inside of cabinets or on top of equipment rack. Can control entire stack of A/V components

SENSORS

TS110 TABLE TOP IR SENSOR

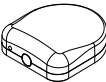

FG01413
Tabletop infrared sensor used for IR pass-through on HT-MSU

WS110R WALL-MOUNT IR SENSOR

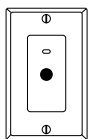

FG01414 - White
FG01415 - Bone
FG01416 - Almond
FG01417 - Black
Wall-Mount infrared sensor used for IR pass-through on HT-MSU

MS110 FLUSH MOUNT IR SENSOR



FG01409
Flush-mount infrared sensor used for IR pass-through on HT-MSU

MS210 MINIATURE SURFACE-MOUNT IR SENSOR

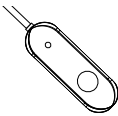

FG01410 - Silver
FG01411 - White
FG01412 - Black
Flush-mount infrared sensor used for IR pass-through on HT-MSU

TRIGGERING ACCESSORIES

AC-3 VOLTAGE-TRIGGERED AC POWER STRIP

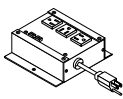

FG00242
AC power strip with two-voltage triggered AC outlets and one unswitched AC outlet

3.5 MM TO 3.5MM CABLE



FG00933
10ft. cable with 3.5mm mono mini-plug that can be used as a trigger accessory or a direct flasher connection

3.5MM TO FLYING LEADS

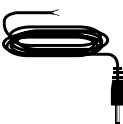

FG00724
10ft. cable with 3.5mm mono mini-plug to 3.5mm mono mini-plug and two flying leads

ACCESSORIES (CONTINUED)

CS12V CURRENT SENSING 12 VOLT TRIGGER



FG01173

Activates voltage controlled devices by turning on another component. Current-sensing makes it compatible with any 110V electrical device

LS-1 LIGHT SENSOR



FG00728

Senses the brightness of a component's front-panel display and outputs a 12V DC sync signal when the display is brightest

APC-2 CURRENT-SENSING OUTLET SWITCHER

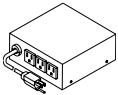

FG00254

Accessory 12Volt DC power adaptor. Provides enough current to trigger up to six automated switchers; also used for status on receivers with switched outlets

1.25A 12VDC UNIVERSAL POWER SUPPLY



FG01035

Current outlet provides 12V DC sync connection via an accessory cable to the HT-MSU

IR/RF TESTER



FG00727

Dual LED design visually confirms the receipt of a valid RF command at the MSU

EXPANSION ACCESSORIES

PAR4 SIMPLIFIED INFRARED ROUTER

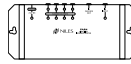

FG01172

Routes IR commands to four components. Compatible with all brands of A/V equipment and remote controls. Used for iC2 TV Array feature

RADIO FREQUENCY GATEWAY (RFG & RFG EX)



FG01407 NORTH AMERICA FG01408 INTERNATIONAL

An optional device that can be used instead of the supplied antenna; allows the Zigbee radio antenna to be placed up to 100 meters (330 feet/100 meters) away from the HT-MSU

SPECIFICATIONS

HT-MSU

Power Requirements: 12VDC 1.25A Regulated In-line Power Supply (included)

Unit Dimensions: 10.52"L x 5.85"W x 1.01H (26.72 cm x 14.86 cm x 2.57 cm)

RF Section: 2.4-GHz frequency ZigBee wireless mesh technology

Signal Range: 75 to 100 feet open air (22.86 to 30.48 meters)

Wiring Requirements: RG59 CL Antenna Cable (included), CAT-5 cable, 3 conductor 22-gauge cable, and 2 conductor 22-gauge cable

Trigger Output Voltage: Three assignable outputs at 12VDC 150mA

Contact Closures: Three assignable Normally Open/Normally Closed contact closures rated to handle 12V @ 5 Amps each

IR Ports: 8 Routed IR Flasher Ports and 1 Routable Global IR Output Port

RS232 Ports: 8 Routed RS232 Output Ports

IR & RS232 Code Memory: 4000 commands depending on brand type and model of source

Sequence capability: 450 thirty-two step sequences

Sequence Delays: .1 to 20.0 seconds per step

Component Synchs: 8 Power Status Synch ports rated to sense 12V 150mA input signals or video voltage

IR Bandwidth: Compatible with virtually all brands of remotes using carrier frequencies between 26 and 105KHz

IC2 REMOTE

Power Requirements: 12VDC 1.25A Regulated In-line Power Supply (Included)

Battery: Rechargeable L-ION 3.75 volts 3500 amp/hours

Full Charging Cycles to 80% battery effectiveness: 550

Unit Dimensions: 7.45"L x 5.22"W x 2.96"H (18.92 cm x 13.26 cm x 7.51 cm)

RF Section: 2.4-GHz frequency ZigBee wireless mesh technology

Signal Range: 75 to 100 ft open air (22.86 to 30.48 meters)

GENERAL

iC2 System Shipping Weight: Approximately 7 lbs. (3.18 kg)

Warranty: Two-year limited

Agency Certifications: Tested to UL/EN60065 for US, Canadian and EU markets.

This device complies with part 15 of the FCC Rules. Operation is subject to the following two conditions: (1) This device may not cause harmful interference, and (2) this device must accept any interference received, including interference that may cause undesired operation. FCC and CE approved.

LIMITED WARRANTY

NILES AUDIO CORPORATION ("NILES") WARRANTS ITS ACTIVE PRODUCTS (THOSE REQUIRING AC OR BATTERY POWER) TO THE ORIGINAL PURCHASER TO BE FREE OF MANUFACTURING DEFECTS IN MATERIAL AND WORKMANSHIP FOR A PERIOD OF TWO YEARS FROM DATE OF PURCHASE.

THIS WARRANTY IS SUBJECT TO THE FOLLOWING ADDITIONAL CONDITIONS AND LIMITATIONS. THE WARRANTY IS VOID AND INAPPLICABLE IF NILES DEEMS THAT THE PRODUCT HAS BEEN USED OR HANDLED OTHER THAN IN ACCORDANCE WITH THE INSTRUCTIONS PROVIDED BY THE MANUFACTURER, INCLUDING BUT NOT LIMITED TO DAMAGE CAUSED BY ACCIDENT, MISHANDLING, IMPROPER INSTALLATION, ABUSE, NEGLIGENCE, OR NORMAL WEAR AND TEAR, OR ANY DEFECT CAUSED BY REPAIR TO THE PRODUCT BY ANYONE OTHER THAN NILES OR AN AUTHORIZED NILES DEALER.

TO OBTAIN WARRANTY SERVICE, TAKE THE UNIT TO THE NEAREST AUTHORIZED NILES DEALER, WHO WILL TEST THE PRODUCT AND IF NECESSARY, FORWARD IT TO NILES FOR SERVICE. IF THERE ARE NO AUTHORIZED NILES DEALERS IN YOUR AREA, YOU MUST WRITE TO NILES AND INCLUDE YOUR NAME, MODEL AND SERIAL NUMBER OF YOUR UNIT, ALONG WITH A BRIEF DESCRIPTION OF THE PROBLEM. A FACTORY RETURN AUTHORIZATION NUMBER WILL BE SENT TO YOU. DO NOT RETURN ANY UNIT WITHOUT FIRST RECEIVING WRITTEN AUTHORIZATION AND SHIPPING INSTRUCTIONS FROM NILES.

IF THE ABOVE CONDITIONS ARE MET, THE PURCHASER'S SOLE REMEDY SHALL BE TO RETURN THE PRODUCT TO NILES, IN WHICH CASE NILES WILL REPAIR OR REPLACE, AT ITS SOLE OPTION, THE DEFECTIVE PRODUCT WITHOUT CHARGE FOR PARTS OR LABOR. NILES WILL RETURN A UNIT REPAIRED OR REPLACED UNDER WARRANTY BY SHIPPING SAME BY ITS USUAL SHIPPING METHOD FROM THE FACTORY (ONLY) AT ITS EXPENSE WITHIN THE UNITED STATES OF AMERICA. THERE ARE NO OTHER WARRANTIES, INCLUDING WITHOUT LIMITATION, EITHER EXPRESS OR IMPLIED WARRANTIES OF MERCHANTABILITY OR FITNESS FOR A PARTICULAR PURPOSE, WITH RESPECT TO THE PRODUCT.

REPAIR OR REPLACEMENT AS PROVIDED UNDER THIS WARRANTY IS THE EXCLUSIVE REMEDY OF THE CONSUMER/PURCHASER. NILES SHALL NOT BE RESPONSIBLE FOR ANY INCIDENTAL OR CONSEQUENTIAL DAMAGES EXCEPT TO THE EXTENT PROVIDED (OR PROHIBITED) BY APPLICABLE LAW.

SOME STATES DO NOT ALLOW THE EXCLUSION OR LIMITATION OF INCIDENTAL OR CONSEQUENTIAL DAMAGES, SO THE ABOVE LIMITATION MAY NOT APPLY TO YOU. THIS WARRANTY GIVES YOU SPECIFIC LEGAL RIGHTS, AND YOU MAY ALSO HAVE OTHER RIGHTS WHICH VARY FROM STATE TO STATE.

FOR THE NAME OF YOUR NEAREST AUTHORIZED NILES DEALER CONTACT:
NILES AUDIO CORPORATION, P.O. BOX 160818, MIAMI, FLORIDA 33116-0818
OR VISIT US AT WWW.NILESAUDIO.COM

Please fill in your product information and retain for your records.

Model _____ Serial No. _____ Purchase Date _____

WARRANTY REGISTRATION CARD

Model Purchased _____

Serial Number _____

Date Purchased (month/day/year) _____

Dealer Name and Location _____

Dr. Miss Mr. Mrs. Ms.

Name _____

Address _____

City _____ State _____ Zip _____

Telephone () _____

Please take a moment to fill out our warranty registration card. The information helps us to get to know you better and develop the products you want

Age:

- Under 25
- 25-34
- 35-44
- 45-54
- 55 & over

Income:

- Under \$24,999
- \$25,000-\$34,999
- \$35,000-\$44,999
- \$45,000-\$59,999
- \$60,000-\$74,999
- \$75,000-\$99,999
- Over \$99,999

Occupation:

- Arts/Entertainment
- Business Owner
- Engineer
- Finance/Accounting
- General Office
- Management
- Professional
- Sales/Marketing
- Student
- Tradesperson

Musical tastes:

- (Please check all that apply)*
- Alternative
 - Classical
 - Country
 - Jazz
 - New Age
 - Popular
 - R&B
 - Rock
 - Other _____

How did you hear about Niles?

- Architect/Developer
- Custom Installer
- Direct Mail
- Friend/Family
- In-Store Display
- Interior Designer
- Magazine Ad
- Mail-Order Catalog
- Newspaper Ad
- Product Brochure
- Product Review
- Retail Salesperson

What magazines do you read?

1. _____
2. _____
3. _____

Who will install the product?

- Custom Installer
- Electrician
- Friend
- Myself

Which factor(s) influenced the purchase of your Niles product? (Please check all that apply)

- Ease of Use
- Price/Value
- Product Features
- Quality/Durability
- Reputation
- Style/Appearance
- Warranty

Do you . . . ?

- Own a House. If yes, how many square feet? _____

- Own a Town House/Condominium/Co-op
- Rent an Apartment
- Rent a House

- Are you interested in receiving literature on other Niles products?**
- Yes No

- Are there products/capabilities that you would like to see introduced?**
- _____
- _____
- _____



BLENDING HIGH FIDELITY AND ARCHITECTURE®

Niles Audio Corporation
12331 S.W. 130 Street Miami, Florida 33186
1-305-238-4373

1-800-BUY-HIFI - www.nilesaudio.com

©2007 Niles Audio Corporation. All rights reserved. Niles, the Niles logos and Blending High Fidelity and Architecture are registered trademarks of Niles Audio Corporation. All other trademarks are the property of their respective owners. DS00588A

Free Manuals Download Website

<http://myh66.com>

<http://usermanuals.us>

<http://www.somanuals.com>

<http://www.4manuals.cc>

<http://www.manual-lib.com>

<http://www.404manual.com>

<http://www.luxmanual.com>

<http://aubethermostatmanual.com>

Golf course search by state

<http://golfingnear.com>

Email search by domain

<http://emailbydomain.com>

Auto manuals search

<http://auto.somanuals.com>

TV manuals search

<http://tv.somanuals.com>