

## **Nokia X2-00 User Guide**

Issue 1

<b>Contents</b>	
<b>Safety</b>	<b>4</b>
<b>General information</b>	<b>5</b>
About your device	5
Network services	5
Shared memory	6
Access codes	6
Software updates	6
Support	7
<b>Get started</b>	<b>8</b>
Keys and parts	8
Insert the battery	9
Insert the SIM card	9
Insert a memory card	9
Switch on or off	10
Charge the battery	10
Display	11
Home screen	11
Keypad lock	12
GSM antenna	12
Flashlight	13
Accessories	13
<b>Calls</b>	<b>14</b>
Make and answer a call	14
Loudspeaker	14
Dialling shortcuts	14
<b>Write text</b>	<b>15</b>
Text input modes	15
Traditional text input	15
Predictive text input	15
<b>Navigate the menus</b>	<b>16</b>
<b>Messaging</b>	<b>16</b>
Text and multimedia messages	16
Nokia Messaging Mail	18
Nokia Messaging IM	18
Flash messages	19
Nokia Xpress audio messages	19
Voice messages	19
Message settings	19
<b>Contacts</b>	<b>20</b>
<b>Log</b>	<b>20</b>
<b>Music</b>	<b>21</b>
Media player	21
FM radio	22
<b>Camera and video</b>	<b>22</b>
<b>Photos</b>	<b>23</b>
<b>Settings</b>	<b>24</b>
Profiles	24
Tones	24
Display	24
Date and time	24
Shortcuts	25
Synchronisation and backup	25
Connectivity	25
Call and phone	27
Accessories	27
Configuration	27
Restore factory settings	28
<b>Applications</b>	<b>28</b>
Alarm clock	28
Gallery	28
Extras	29
Voice recorder	29
<b>Web or Internet</b>	<b>30</b>
Connect to a web service	30
<b>Visit Ovi</b>	<b>30</b>
<b>SIM services</b>	<b>30</b>
<b>Green tips</b>	<b>31</b>
Save energy	31
Recycle	31

**Product and safety information 31**

**Index 37**

### Safety

Read these simple guidelines. Not following them may be dangerous or illegal. Read the complete user guide for further information.

#### SWITCH ON SAFELY



Do not switch the device on when wireless phone use is prohibited or when it may cause interference or danger.

#### ROAD SAFETY COMES FIRST



Obey all local laws. Always keep your hands free to operate the vehicle while driving. Your first consideration while driving should be road safety.

#### INTERFERENCE



All wireless devices may be susceptible to interference, which could affect performance.

#### SWITCH OFF IN RESTRICTED AREAS



Follow any restrictions. Switch the device off in aircraft, near medical equipment, fuel, chemicals, or blasting areas.

#### QUALIFIED SERVICE



Only qualified personnel may install or repair this product.

#### ACCESSORIES AND BATTERIES



Use only approved accessories and batteries. Do not connect incompatible products.

#### WATER-RESISTANCE



Your device is not water-resistant. Keep it dry.

## General information

### About your device

The wireless device described in this guide is approved for use on the EGSM 850, 900, 1800, 1900 MHz networks. Contact your service provider for more information about networks.

Your device may have preinstalled bookmarks and links for third-party internet sites and may allow you to access third-party sites. These are not affiliated with Nokia, and Nokia does not endorse or assume liability for them. If you access such sites, take precautions for security or content.

### Warning:

To use any features in this device, other than the alarm clock, the device must be switched on. Do not switch the device on when wireless device use may cause interference or danger.

When using this device, obey all laws and respect local customs, privacy and legitimate rights of others, including copyrights. Copyright protection may prevent some images, music, and other content from being copied, modified, or transferred.

Make back-up copies or keep a written record of all important information stored in your device.

When connecting to any other device, read its user guide for detailed safety instructions. Do not connect incompatible products.

The images in this guide may differ from your device display.

Refer to the user guide for other important information about your device.

### Network services

To use the device you must have service from a wireless service provider. Some features are not available on all networks; other features may require that you make specific arrangements with your service provider to use them. Network services involve transmission of data. Check with your service provider for details about fees in your home network and when roaming on other networks. Your service provider can explain what charges will apply. Some networks may have limitations that affect how you can use some features of this device requiring network support such as support for specific technologies like WAP 2.0 protocols (HTTP and SSL) that run on TCP/IP protocols and language-dependent characters.

Your service provider may have requested that certain features be disabled or not activated in your device. If so, these features will not appear on your device menu. Your device may also have customized items such as menu names, menu order, and icons.

### Shared memory

The following features in this device may share memory: multimedia messaging (MMS), e-mail application, instant messaging. Use of one or more of these features may reduce the memory available for the remaining features. If your device displays a message that the memory is full, delete some of the information stored in the shared memory.

### Access codes

The security code helps to protect your device against unauthorised use. The preset code is 12345. You can create and change the code, and set the device to request the code. Keep the code secret and in a safe place separate from your device. If you forget the code and your device is locked, your device will require service. Additional charges may apply, and all the personal data in your device may be deleted. For more information, contact a Nokia Care point or your device dealer.

The PIN code supplied with the SIM card protects the card against unauthorised use. The PIN2 code supplied with some SIM cards is required to access certain services. If you enter the PIN or PIN2 code incorrectly three times in succession, you are asked for the PUK or PUK2 code. If you do not have them, contact your service provider.

The module PIN is required to access the information in the security module of your SIM card. The signing PIN may be required for the digital signature. The barring password is required when using the call barring service.

To set how your device uses the access codes and security settings, select **Menu > Settings > Security**.

### Software updates

#### About device software and application updates

With device software updates and application updates, you can get new features and enhanced functions for your device. Updating the software may also improve your device performance.

It is recommended that you back up your personal data before updating your device software.

#### Warning:

If you install a software update, you cannot use the device, even to make emergency calls, until the installation is completed and the device is restarted. Be sure to back up data before accepting installation of an update.

Downloading software updates may involve the transmission of large amounts of data (network service).

Make sure that the device battery has enough power, or connect the charger before starting the update.

After you update your device software or applications, the instructions in the user guide may no longer be up to date.

### Update device software using your PC

You can use the Nokia Software Updater PC application to update your device software. To update your device software, you need a compatible PC, a high-speed internet connection, and a compatible USB data cable to connect your device to the PC.

To get more information and to download the Nokia Software Updater application, go to [www.nokia.com/softwareupdate](http://www.nokia.com/softwareupdate).

### Update software over the air

Your service provider may send device software updates over the air directly to your device (network service). This option may not be available, depending on your device.

Downloading software updates may involve the transmission of large amounts of data (network service).

Make sure that the device battery has enough power, or connect the charger before starting the update.

#### Warning:

If you install a software update, you cannot use the device, even to make emergency calls, until the installation is completed and the device is restarted. Be sure to back up data before accepting installation of an update.

### Request a software update

- 1 Select **Menu > Settings and Phone > Phone updates**.
- 2 To display the current software version and check whether an update is needed, select **Current sw details**.
- 3 Select **Downl. phone sw**, and follow the instructions.
- 4 If the installation was cancelled after the download, to start the installation, select **Install sw update**.

The software update may take several minutes. If there are problems with the installation, contact your service provider.

### Support

When you want to learn more about how to use your product or you are unsure how your device should function, go to [www.nokia.com/support](http://www.nokia.com/support), or using a mobile device, [www.nokia.mobi/support](http://www.nokia.mobi/support).

If this does not resolve your issue, do one of the following:

- Restart the device: switch off the device, and remove the battery. After about a minute, replace the battery, and switch on the device.

Download from [Www.Somanuals.com](http://Www.Somanuals.com). All Manuals Search And Download.

## 8 Get started

- Restore the original factory settings.
- Update your device software.

If your issue remains unsolved, contact Nokia for repair options. Go to [www.nokia.com/repair](http://www.nokia.com/repair). Before sending your device for repair, always back up the data in your device.

### Get started

#### Keys and parts

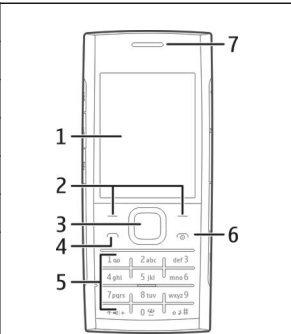
1	Display	
2	Selection keys	
3	Navi™ key (scroll key)	
4	Call key	
5	Keypad	
6	End/Power key	
7	Earpiece	

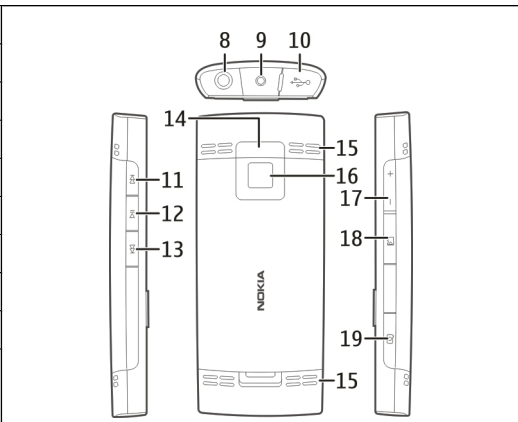
8	Headset connector	
9	Charger connector	
10	USB port	
11-13	Music keys	
14	Camera flash	
15	Loudspeaker	
16	Lens	
17	Volume keys	
18	Memory card slot	
19	Capture key	



## Insert the battery

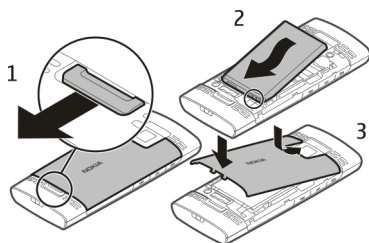

- 1 Remove the back cover.
- 2 Line up the battery contacts, and insert the battery.
- 3 Replace the back cover.

## Insert the SIM card

The SIM card and its contacts can be easily damaged by scratches or bending, so be careful when handling, inserting, or removing the card.

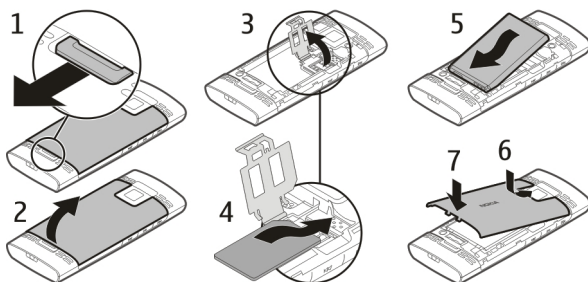

- 1 Remove the back cover and battery.
- 2 Open the SIM card holder.
- 3 Insert the SIM card into the holder, with the contact surface facing down.
- 4 Close the card holder.
- 5 Replace the battery and back cover.

## Insert a memory card



## 10 Get started

Use only compatible MicroSD cards approved by Nokia for use with this device. Nokia uses approved industry standards for memory cards, but some brands may not be fully compatible with this device. Incompatible cards may damage the card and the device and corrupt data stored on the card.

Your device supports microSD cards with a capacity of up to 16 GB. The size of a single file must not exceed 2 GB.

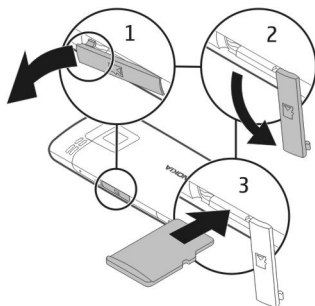

- 1 Open the memory card slot cover.
- 2 Pull the cover aside.
- 3 Insert the memory card into the slot, with the contact surface facing down.
- 4 Close the cover of the memory card slot.

### Switch on or off

Press and hold the power key.

### Charge the battery

Your battery has been partially charged at the factory. If the device indicates a low charge, do the following:



- 1 Connect the charger to a wall outlet.
- 2 Connect the charger to the device.
- 3 When the device indicates a full charge, disconnect the charger from the device, then from the wall outlet.

You do not need to charge the battery for a specific length of time, and you can use the device while it is charging. If the battery is completely discharged, it may take several minutes before the charging indicator appears on the display or before any calls can be made.

## Display

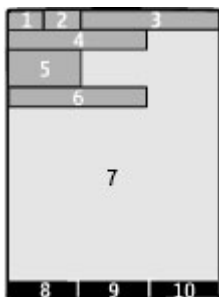

- 1 Signal strength of the cellular network
- 2 Battery charge status
- 3 Indicators
- 4 Name of the network or the operator logo
- 5 Clock
- 6 Date (if home screen mode is deactivated)
- 7 Display
- 8 Function of the left selection key
- 9 Function of the scroll key
- 10 Function of the right selection key

You can change the function of the left and right selection key. [See "Shortcuts", p. 25.](#)

## Home screen

In the home screen, you can create shortcuts to your favourite applications.

Select **Menu** > **Settings and Display** > **Home screen**.

### Activate the home screen

Select **Home screen mode** > **On**.

### Organise and personalise the home screen

Select **Personalise view**.

## 12 Get started

### Select the key used to activate the home screen

Select Home screen key.

### Navigate in the home screen

Scroll up or down to navigate the list, and select **Select**, **View**, or **Edit**. The arrows indicate that further information is available.

### Stop navigating

Select Exit.

## Keypad lock

To prevent accidental keypresses, select **Menu**, and press \* within 3.5 seconds to lock the keypad.

To unlock the keypad, select **Unlock**, and press \* within 1.5 seconds. If the security keyguard is activated, enter the security code when requested.

To set the keypad to lock automatically after a defined length of time when the device is not being used, select **Menu** > **Settings** > **Phone** > **Automatic keyguard** > **On**.

To answer a call when the keypad is locked, press the call key. When you end or reject a call, the keypad locks automatically.

When the device or keypad is locked, calls may be possible to the official emergency number programmed into your device.

## GSM antenna



Your device may have internal and external antennas. Avoid touching the antenna area unnecessarily while the antenna is transmitting or receiving. Contact with antennas affects the communication quality and may cause a higher power level during operation and may reduce the battery life.

The figure shows the GSM antenna area marked in grey.

## Flashlight

The camera flash can be used as a flashlight. To switch the flashlight on or off, in the home screen, press and hold \*.

Do not shine the flashlight in anyone's eyes.

## Accessories

### Connect a USB cable

Open the cover of the USB connector, and connect the USB cable to the device.

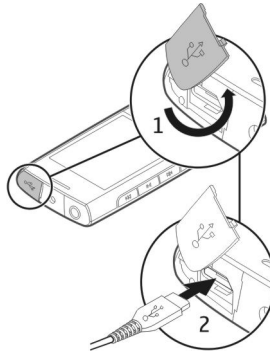

### Connect a headset

#### Warning:

When you use the headset, your ability to hear outside sounds may be affected. Do not use the headset where it can endanger your safety.

When connecting any external device or any headset, other than those approved by Nokia for use with this device, to the Nokia AV Connector, pay special attention to volume levels.

Do not connect products that create an output signal as this may cause damage to the device. Do not connect any voltage source to the Nokia AV Connector.



### Attach a strap

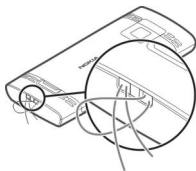

## Calls

### Make and answer a call

#### Make a call

Enter the phone number, including the country and area code if necessary, and press the call key.

#### Answer an incoming call

Press the call key.

#### Reject a call

Press the end key.

#### Adjust the volume

During a phone call, use the volume keys.

### Loudspeaker

If available, you may select **Loudsp.** or **Handset** to use the loudspeaker or the earpiece of the phone during a call.

#### Warning:

Continuous exposure to high volume may damage your hearing. Listen to music at a moderate level, and do not hold the device near your ear when the loudspeaker is in use.

### Dialling shortcuts

#### Assign a phone number to a number key

Select **Menu** > **Contacts** > **More** > **Speed dials**, scroll to a desired number (2-9), and select **Assign**. Enter the desired phone number, or select **Search** and a saved contact.



#### Activate speed dialling

Select **Menu** > **Settings** > **Call** > **Speed dialling** > **On**.

**Make a call using speed dialling**

In the home screen, press and hold the desired number key.

**Write text****Text input modes**

To enter text, for example, when writing messages, you can use traditional  or predictive  text input.

AbC abC and ABC indicate the character cases. 123 indicates number mode.

**Switch between text input modes**

Select and hold **Options**. Not all languages are supported by predictive text input.

**Switch between character cases**

Press #.

**Switch between letter and number modes**

Press and hold #.

**Set the writing language**

Select **Options** > **More** > **Writing language**.

**Traditional text input****Write a word**

Press a number key, 2-9, repeatedly until the desired character is displayed. The available characters depend on the selected writing language. If the next letter you want to enter is located on the same key as the present one, wait until the cursor is displayed, and enter the letter.

**Insert common punctuation marks**

Press 1 repeatedly.

**Insert special characters**

Press \*, and select a character from the list.

**Insert a space**

Press 0.

**Predictive text input**

Predictive text input is based on a built-in dictionary to which you can also add new words.

### Write a word

Press the number keys, 2-9. Press each key only once for one letter.

### Confirm a word

Scroll right, or press **0** to add a space.

### Select the correct word

If the proposed word is not correct, press **\*** repeatedly, and select the desired word from the list.

### Add a word to the dictionary

If the **?** character is displayed after the word, the word you intended to write is not in the dictionary. To add the word to the dictionary, select **Spell**. Enter the word using traditional text input, and select **Save**.

### Write a compound word

Write the first part of the word, and scroll right to confirm it. Write the next part of the word, and confirm again.

## Navigate the menus

The device functions are grouped into menus. Not all menu functions or option items are described here.

In the home screen, select **Menu** and the desired menu and submenu.

### Exit the current menu level

Select **Exit** or **Back**.

### Return to the home screen

Press the end key.

### Change the menu view

Select **Menu > Options > Main menu view**.

## Messaging

You can send and receive text, multimedia, audio, and flash messages. You can also handle your mail. The messaging services can only be used if your network or service provider supports them.

### Text and multimedia messages

You can create a message and optionally attach, for example, a picture. Your phone automatically changes a text message to a multimedia message when a file is attached.



## Text messages

Your device supports text messages beyond the limit for a single message. Longer messages are sent as two or more messages. Your service provider may charge accordingly. Characters with accents, other marks, or some language options take more space, and limit the number of characters that can be sent in a single message.

The total number of characters left and the number of messages needed for sending are displayed.

To send messages, the correct message centre number must be stored in your device. Normally, this number is set by default through your SIM card.

To set the number manually, do the following:

- 1 Select **Menu** > **Messaging** > **More** > **Msg. settings** > **Text messages** > **Message centre**.
- 2 Enter the name and number supplied by your service provider.

## Multimedia messages

A multimedia message can contain text, pictures, and sound or video clips.

Only devices that have compatible features can receive and display multimedia messages. The appearance of a message may vary depending on the receiving device.

The wireless network may limit the size of MMS messages. If the inserted picture exceeds this limit, the device may make it smaller so that it can be sent by MMS.

**Important:** Exercise caution when opening messages. Messages may contain malicious software or otherwise be harmful to your device or PC.

For availability and subscription to the multimedia messaging service (MMS), contact your service provider.

## Create a message

- 1 Select **Menu** > **Messaging** > **Create message**.
- 2 Write your message.  
To insert a special character or a smiley, select **Options** > **Insert symbol**.  
To attach an object to the message, select **Options** > **Insert object**. The message type changes automatically to multimedia message.
- 3 To add recipients, select **Send to** and a recipient.  
To enter a phone number or mail address manually, select **Number or mail**. Enter a phone number, or select **E-mail**, and enter a mail address.
- 4 Select **Send**.

Multimedia messages are indicated with an icon at the top of the display.

## 18 Messaging

---

Service providers may charge differently depending on the message type. For details, contact your service provider.

### **Nokia Messaging Mail**

Access your mail accounts from different providers with your device to read, write, and send mail.

#### **Set up a mail account**

Select **Menu** > **Messaging** > **Mail**.

If you do not already have a mail account, you can create a Nokia account, which includes the Ovi Mail service.

- 1 Select **Get Ovi Mail**.
- 2 Follow the instructions.

#### **Read and send mail**

Select **Menu** > **Messaging** > **Mail**.

#### **Read mail**

Select a mail and **Open**.

Mails with attachments, for example, images, are marked with a paperclip icon. Some attachments may not be compatible with your device, and cannot be displayed on your device.

#### **View attachments**

Select an attachment and **View**.

#### **Write a mail**

Select **Options** > **Compose New**.

#### **Attach a file to the mail**

Select **Options** > **Attach file**.

#### **Send the mail**

Select **Send**.

#### **Close the Mail application**

Select **Sign Out**.

### **Nokia Messaging IM**

With instant messaging (IM) you can chat with other online users using your device. You can use an existing account for an IM community that is supported by your device. If you are not registered to an IM service, you can create an account for a supported IM

service, using your computer or your device. The menus may vary, depending on the IM service.

To connect to the service, select **Menu > Messaging > More > Chat** and follow the instructions.

### Flash messages

Flash messages are text messages that are instantly displayed upon reception.

Select **Menu > Messaging**.

- 1 Select **More > Other messages > Flash message**.
- 2 Write your message.
- 3 Select **Send to** and a contact.

### Nokia Xpress audio messages

Create and send audio messages using MMS in a convenient way.

Select **Menu > Messaging**.

- 1 Select **More > Other messages > Audio message**. The voice recorder opens.
- 2 Select the icons to control the recording.
  - — Record your message.
  - ⏸ — Pause the recording,
  - — Stop the recording.
- 3 Select **Send to** and a contact.

### Voice messages

The voice mailbox is a network service to which you may need to subscribe. For more information, contact your service provider.

#### Call your voice mailbox

Press and hold **1**.

#### Edit your voice mailbox number

Select **Menu > Messaging > More > Voice messages and Voice mailbox no..**

### Message settings

Select **Menu > Messaging and More > Msg. settings**.

Select from the following:

**General settings** — Set the font size for messages, and activate graphical smileys and delivery reports.

**Text messages** — Set up message centres for text messages and SMS mail.

**Multimedia msgs.** — Allow delivery reports and the reception of multimedia messages and advertisements, and set up other preferences related to multimedia messages.

**Service messages** — Activate service messages, and set up preferences related to service messages.

### Contacts

Select **Menu** > **Contacts**.

You can save names and phone numbers in the device memory or on the SIM card. In the device memory, you can save contacts with numbers and text items. Names and numbers saved on the SIM card are indicated with .

#### Add a contact

Select **Add new**.

#### Add details to a contact

Ensure that the memory in use is either **Phone** or **Phone and SIM**. Select **Names**, scroll to the name, and select **Details** > **Options** > **Add detail**.

#### Search for a contact

Select **Names**, and scroll through the list of contacts or enter the first letters of the name.

#### Copy a contact to another memory

Select **Names**, scroll to the contact, and select **Options** > **More** > **Copy contact**. On the SIM card, you can save only one phone number for each name.

#### Select where to save contacts, how contacts are displayed, and the memory consumption of contacts

Select **More** > **Settings**.

#### Send a business card

In the contacts list, scroll to a contact, and select **Options** > **More** > **Business card**. You can send and receive business cards from devices that support the vCard standard.

### Log

To view information about your calls, messages, and data and synchronisation events, select **Menu** > **Log** and the appropriate option.

**Note:** The actual invoice for calls and services from your service provider may vary, depending on network features, rounding off for billing, taxes, and so forth.

## Music

### Media player

Your device includes a media player for listening to songs or other MP3 or AAC sound files.

#### Warning:

Continuous exposure to high volume may damage your hearing. Listen to music at a moderate level, and do not hold the device near your ear when the loudspeaker is in use.

Select **Menu > Music > My music > Go to Media pl..**

Operate the media player with the media player keys or with the virtual keys on the display.

#### Start or pause playing

Press .

#### Skip to the beginning of the current song

Press .

#### Skip to the previous song

Press  twice.

#### Skip to the next song

Press .

#### Rewind or fast-forward the current song

Press and hold  or .

#### Adjust the volume

Use the volume keys.

#### Mute or unmute the media player

Press #.

#### Leave the media player playing in the background

Press the end key.

#### Close the media player

Press and hold the end key.

### FM radio

Your device supports Nokia XpressRadio, allowing you to listen to radio stations with built-in antenna.

#### Warning:

Continuous exposure to high volume may damage your hearing. Listen to music at a moderate level, and do not hold the device near your ear when the loudspeaker is in use.

Select **Menu** > **Music** > **Radio**.

#### Automatically search for available stations

Select **Options** > **Search all stations**. For best results, search when outdoors or near a window.

#### Automatically switch to a frequency with better reception

Check that RDS is activated. Select **Options** > **Settings** > **RDS**.

Select **Auto-frequency**.

#### Search for a neighbouring station

Press and hold the scroll key to the left or right.

#### Save a station

Tune to the desired station, and select **Options** > **Save station**.

#### Switch between saved stations

Scroll up or down to switch between stations, or press the corresponding number key of the memory location of a desired station.

#### Adjust the volume

Use the volume keys.

#### Listen using the headset or the loudspeaker

Select **Options** > **More** > **Play via**.

#### Leave the radio playing in the background

Press the end key.

#### Close the radio

Press and hold the end key.

## Camera and video

Your device supports an image capture resolution of 2592x1944 pixels.

## Camera mode

### Open the camera

In the home screen, press and hold the capture key.

### Zoom in or out

Scroll up or down.

### Capture an image

Press the capture key.

### Set the preview mode and time

Select **Options** > **Settings** > **Photo preview time**.

To activate the self-timer, select **Options** and the desired option.

## Video mode

### Open the video camera

Press and hold the capture key, and scroll right.

### Start recording a video clip

Press the capture key.

### Switch between camera and video mode

In camera or video mode, scroll left or right.

## Photos

View images and play video clips with the Photos application.

Select **Menu** > **Photos**.

Select from the following:

**My photos** — View images in a thumbnail grid. You can sort images by date, name, or size.

**Timeline** — View images in the order they were captured.

**My albums** — Sort images into albums. You can create, rename and remove albums. If you remove an album, the images inside the album are not deleted from the memory.

You may not be able to view, use, or edit photos until they have been processed.

### Rotate an image

Select **Options** > **Landscape mode** or **Portrait mode**.

### View a slide show

A slide show uses the images of the currently selected folder or album.

- 1 Select **My photos**, **Timeline**, or **My albums**.
- 2 Select **Options** > **Slide show**.
- 3 Select **Start slide show**.

### Edit images

You can, for example, rotate, flip, crop, and adjust the brightness, contrast, and colours of images.

- 1 Select an image in **My photos**, **Timeline**, or **My albums**.
- 2 Select **Options** > **Edit photo**.
- 3 Select an editing option, and use the scroll key to modify the settings or values.

## Settings

### Profiles

Waiting for a call, but can't let your device ring? There are various settings groups called profiles, which you can customise with ringing tones for different events and environments.

Select **Menu** > **Settings** > **Profiles**.

Select the desired profile and from the following:

**Activate** — Activate the profile.

**Personalise** — Modify the profile settings.

**Timed** — Set the profile to be active until a certain time. When the time set for the profile expires, the previous profile that was not timed becomes active.

### Tones

You can change the tone settings of the selected active profile.

Select **Menu** > **Settings** > **Tones**. You can find the same settings in the **Profiles** menu.

### Display

Select **Menu** > **Settings** > **Display**.

You can view or adjust the wallpaper, font size, or other features related to the device display.

### Date and time

Select **Menu** > **Settings** > **Date and time**.



**Set the date and time**

Select **Date & time settings**.

**Set the date and time format**

Select **Date & time format**.

**Update the time automatically according to the current time zone**

Select **Auto-update of time (network service)**.

**Shortcuts**

With personal shortcuts, you can get quick access to frequently used phone functions.

Select **Menu > Settings > My shortcuts**.

**Assign phone functions to the selection keys**

Select **Right selection key** or **Left selection key** and a function from the list.

**Select shortcut functions for the scroll key**

Select **Navigation key**. Scroll to the desired direction, and select **Change** or **Assign** and a function from the list.

**Synchronisation and backup**

Select **Menu > Settings > Sync & backup**.

Select from the following:

**Sync with Ovi** — Synchronise your personal data with Ovi. Before you start synchronising, you need to set up your Nokia account. Select **Connect**, and you are guided through the process of synchronising data. The availability of this option may vary.

**Sync w. server** — Synchronise or copy selected data between your device and a network server (network service).

**Phone switch** — Synchronise or copy selected data, such as your contacts, calendar entries, notes, or messages, between your device and another device.

**Create backup** — Back up selected data.

**Restore backup** — Restore data from a backup. To view the details of a backup file, select **Options > Details**.

**Connectivity**

Your phone has several features that allow you to connect to other devices to transmit and receive data.

### Bluetooth wireless technology

Bluetooth technology allows you to connect your device, using radio waves, to a compatible Bluetooth device within 10 metres (32 feet).

This device is compliant with Bluetooth Specification 2.1 + EDR supporting the following profiles: generic access, network access, control, hands-free, headset, object push, file transfer, dial-up networking, SIM access, and serial port. To ensure interoperability between other devices supporting Bluetooth technology, use Nokia approved accessories for this model. Check with the manufacturers of other devices to determine their compatibility with this device.

Features using Bluetooth technology increase the demand on battery power and reduce the battery life.

When the wireless device is in the remote SIM mode, you can only use a compatible connected accessory, such as a car kit, to make or receive calls.

Your wireless device will not make any calls, except to the emergency numbers programmed into your device, while in this mode.

To make calls, you must first leave the remote SIM mode. If the device has been locked, enter the lock code to unlock it first.

### Open a Bluetooth connection

- 1 Select **Menu** > **Settings** > **Connectivity** > **Bluetooth**.
- 2 Select **My phone's name**, and enter a name for your device.
- 3 To activate Bluetooth connectivity, select **Bluetooth** > **On**.  indicates that Bluetooth connectivity is active.
- 4 To connect your device to an audio accessory, select **Conn. to audio acc.** and the accessory.
- 5 To pair your device with any Bluetooth device in range, select **Paired devices** > **Add new device**.
- 6 Scroll to a found device, and select **Add**.
- 7 Enter a passcode (up to 16 characters) on your device, and allow the connection on the other Bluetooth device.

Operating the device in hidden mode is a safer way to avoid malicious software. Do not accept Bluetooth connectivity from sources you do not trust. Alternatively, switch off the Bluetooth function. This does not affect other functions of the device.

### Connect your PC to the internet

You can use Bluetooth technology to connect your compatible PC to the internet. Your device must be able to connect to the internet (network service), and your PC must support Bluetooth technology. After connecting to the network access point (NAP) service of the device and pairing with your PC, your device automatically opens a packet data connection to the internet.

## Packet data

General packet radio service (GPRS) is a network service that allows mobile phones to send and receive data over an internet protocol (IP) based network.

To define how to use the service, select **Menu > Settings > Connectivity > Packet data > Packet data conn.** and from the following:

**When needed** — Establish a packet data connection when needed by an application. The connection is closed when the application is closed.

**Always online** — Automatically connect to a packet data network when you switch the device on.

You can use your device as a modem by connecting it to a compatible PC using Bluetooth technology. For details, see the Nokia PC Suite documentation.

## Call and phone

Select **Menu > Settings > Call.**

### Divert incoming calls

Select **Call divert** (network service). For details, contact your service provider.

### Automatically redial ten times after an unsuccessful attempt

Select **Automatic redial > On.**

### Get a notification of incoming calls while you are in a call

Select **Call waiting > Activate** (network service).

### Display or hide your number to the person you are calling

Select **Send my caller ID** (network service).

Select **Menu > Settings > Phone.**

### Set the display language

Select **Language settings > Phone language.**

## Accessories

This menu is only available if the device is or has been connected to a compatible accessory.

Select **Menu > Settings > Accessories.** Select an accessory and an option, depending on the accessory.

## Configuration

You can configure your device with settings that are required for certain services. Your service provider may also send you these settings.

Select **Menu** > **Settings** and **Configuration**.

Select from the following:

**Default config. sett.** — View the service providers saved in the device, and set a default service provider.

**Act. def. in all apps.** — Activate the default configuration settings for supported applications.

**Preferred access pt.** — View the saved access points.

**Personal settings** — Add new personal accounts for various services, and activate or delete them. To add a new personal account, select **Add** or **Options** > **Add new**. Select the service type, and enter the required information. To activate a personal account, scroll to the account, and select **Options** > **Activate**.

### Restore factory settings

To restore the phone back to factory settings, select **Menu** > **Settings** > **Rest. fact. sett.** and from the following:

**Settings only** — Reset all preference settings without deleting any personal data.

**All** — Reset all preference settings and delete all personal data, such as contacts, messages, media files, and activation keys.

## Applications

### Alarm clock

You can set an alarm to sound at a desired time.

#### Set the alarm

- 1 Select **Menu** > **Applications** > **Alarm clock**.
- 2 Enter the alarm time.
- 3 To repeat an alarm on selected days of the week, select **Repeat:** > **On** and the days.
- 4 Select the alarm tone. If you select the radio as the alarm tone, connect the headset to the device.
- 5 Set the length of the snooze time-out period, and select **Save**.

#### Stop the alarm

Select **Stop**. If you let the alarm sound for a minute or select **Snooze**, the alarm stops for the length of the snooze time-out period, then resumes.

### Gallery

In Gallery, you can manage images, video clips, and music files.

#### View the Gallery contents

Select **Menu** > **Applications** > **Gallery**.

**Upload an image or video clip to a web-based service when viewing the file**

Select **Send** > **Upload to web** and the desired upload service.

**Extras**

Your device may include some games and Java™ applications specially designed for your device.

Select **Menu** > **Applications** > **Extras**.

**Open a game or application**

Select **Games**, **Collection**, or **Memory card**, and a game or an application.

**View the amount of memory available for game and application installations**

Select **Options** > **Memory status**.

**Download a game or application**

Select **Options** > **Downloads** > **Game downloads** or **App. downloads**.

Your device supports J2ME™ Java applications. Ensure that the application is compatible with your device before downloading it.

**Important:** Only install and use applications and other software from trusted sources, such as applications that are Symbian Signed or have passed the Java Verified™ testing.

The downloaded applications may be saved in Gallery instead of Applications.

**Voice recorder**

Select **Menu** > **Applications** > **Voice recorder**.

**Start recording**

Select the record icon.

**Start recording during a call**

Select **Options** > **More** > **Record**. When recording a call, hold the phone in the normal position near to your ear. The recording is saved in the Recordings folder in Gallery.

**Listen to the latest recording**

Select **Options** > **Play last recorded**.

**Send the last recording in a multimedia message**

Select **Options** > **Send last recorded**.

### Web or Internet

You can access various internet services with your phone browser. The appearance of the web pages may vary due to screen size. You may not be able to see all the details on the web pages.

Depending on your phone, the web browsing function may be displayed as Web or Internet in the menu, hereafter referred to as Web.

**Important:** Use only services that you trust and that offer adequate security and protection against harmful software.

For the availability of these services, pricing, and instructions, contact your service provider.

You may receive the configuration settings required for browsing as a configuration message from your service provider.

### Connect to a web service

Select **Menu > Internet > Home**. Or, in the home screen, press and hold **0**.

After you make a connection to the service, you can start browsing its pages. The function of the device keys may vary in different services. Follow the instructions on the display. For more information, contact your service provider.

### Visit Ovi

 Ovi contains services provided by Nokia. With Ovi, you can create a mail account, share your images and video clips with friends and family, plan trips and view locations on a map, download games, applications, video clips, and tones to your device, and purchase music. The available services may vary by region, and not all languages are supported.

To access Ovi services, go to [www.ovi.com](http://www.ovi.com), and register your own Nokia account.

For more information on how to use the services, see the support pages of each service.

### SIM services

Your SIM card may provide additional services. You can access this menu only if it is supported by your SIM card. The name and contents of the menu depend on the available services.

## Green tips



### Save energy

You do not need to charge your battery so often if you do the following (if available for your device):

- Close applications and data connections, for example, your Bluetooth connection, when not in use.
- Decrease the brightness of the screen.
- Set your device to enter power saver mode after the minimum period of inactivity, if available in your device.
- Deactivate unnecessary sounds, such as key tones.

### Recycle

All materials of this device can be recovered as materials and energy. For information on how to recycle your old Nokia products, go to [www.nokia.com/werecycle](http://www.nokia.com/werecycle), or using a mobile device, [www.nokia.mobi/werecycle](http://www.nokia.mobi/werecycle).

Recycle packaging and user guides at your local recycling scheme.



The crossed-out wheeled-bin symbol on your product, battery, literature, or packaging reminds you that all electrical and electronic products, batteries, and accumulators must be taken to separate collection at the end of their working life. This requirement applies in the European Union. Do not dispose of these products as unsorted municipal waste. For more information on the environmental attributes of your device, see [www.nokia.com/ecodeclaration](http://www.nokia.com/ecodeclaration).

## Product and safety information

### Accessories

#### Warning:

Use only batteries, chargers, and accessories approved by Nokia for use with this particular model. The use of any other types may invalidate any approval or warranty, and may be dangerous. In particular, use of unapproved chargers or batteries may present a risk of fire, explosion, leakage, or other hazard.

For availability of approved accessories, please check with your dealer. When you disconnect the power cord of any accessory, grasp and pull the plug, not the cord.

Download from [Www.Somanuals.com](http://Www.Somanuals.com). All Manuals Search And Download.

### Battery

#### Battery and charger information

Your device is powered by a rechargeable battery. The battery intended for use with this device is BL-4C. Nokia may make additional battery models available for this device. This device is intended for use when supplied with power from the following chargers: AC-3. The exact charger model number may vary depending on the type of plug. The plug variant is identified by one of the following: E, EB, X, AR, U, A, C, K, or UB.

The battery can be charged and discharged hundreds of times, but it will eventually wear out. When the talk and standby times are noticeably shorter than normal, replace the battery. Use only Nokia approved batteries, and recharge your battery only with Nokia approved chargers designated for this device.

If a battery is being used for the first time or if the battery has not been used for a prolonged period, it may be necessary to connect the charger, then disconnect and reconnect it to begin charging the battery. If the battery is completely discharged, it may take several minutes before the charging indicator appears on the display or before any calls can be made.

**Safe removal.** Always switch the device off and disconnect the charger before removing the battery.

**Proper charging.** Unplug the charger from the electrical plug and the device when not in use. Do not leave a fully charged battery connected to a charger, since overcharging may shorten its lifetime. If left unused, a fully charged battery will lose its charge over time.

**Avoid extreme temperatures.** Always try to keep the battery between 15°C and 25°C (59°F and 77°F). Extreme temperatures reduce the capacity and lifetime of the battery. A device with a hot or cold battery may not work temporarily. Battery performance is particularly limited in temperatures well below freezing.

**Do not short-circuit.** Accidental short-circuiting can occur when a metallic object such as a coin, clip, or pen causes direct connection of the positive (+) and negative (-) terminals of the battery. (These look like metal strips on the battery.) This might happen, for example, when you carry a spare battery in your pocket or purse. Short-circuiting the terminals may damage the battery or the connecting object.

**Disposal.** Do not dispose of batteries in a fire as they may explode. Dispose of batteries according to local regulations. Please recycle when possible. Do not dispose as household waste.

**Leak.** Do not dismantle, cut, open, crush, bend, puncture, or shred cells or batteries. In the event of a battery leak, prevent battery liquid contact with skin or eyes. If this happens, flush the affected areas immediately with water, or seek medical help.

**Damage.** Do not modify, remanufacture, attempt to insert foreign objects into the battery, or immerse or expose it to water or other liquids. Batteries may explode if damaged.

**Correct use.** Use the battery only for its intended purpose. Improper battery use may result in a fire, explosion, or other hazard. If the device or battery is dropped, especially on a hard surface, and you believe the battery has been damaged, take it to a service centre for inspection before continuing to use it. Never use any charger or battery that is damaged. Keep your battery out of the reach of small children.

#### Nokia battery authentication guidelines

Always use original Nokia batteries for your safety. To check that you are getting an original Nokia battery, purchase it from a Nokia authorised service centre or dealer, and inspect the hologram label using the following steps:



**Authenticate hologram**

- 1 When you look at the hologram on the label, you should see the Nokia connecting hands symbol from one angle and the Nokia Original Enhancements logo when looking from another angle.



- 2 When you angle the hologram left, right, down and up, you should see 1, 2, 3 and 4 dots on each side respectively.



Successful completion of the steps is not a total assurance of the authenticity of the battery. If you cannot confirm authenticity or if you have any reason to believe that your Nokia battery with the hologram on the label is not an authentic Nokia battery, you should refrain from using it, and take it to the nearest Nokia authorised service centre or dealer for assistance.

To find out more about original Nokia batteries, see [www.nokia.com/battery](http://www.nokia.com/battery).

**Taking care of your device**

Your device is a product of superior design and craftsmanship and should be treated with care. The following suggestions will help you protect your warranty coverage.

- Do not use or store the device in dusty, dirty areas. Its moving parts and electronic components can be damaged.
- Do not store the device in high or cold temperature. High temperatures can shorten the life of electronic devices, damage batteries, and warp or melt certain plastics. When the device warms to its normal temperature from a cold temperature, moisture can form inside the device and damage electronic circuit boards.
- Do not attempt to open the device other than as instructed in this guide.
- Do not drop, knock, or shake the device. Rough handling can break internal circuit boards and fine mechanics.
- Do not use harsh chemicals, cleaning solvents, or strong detergents to clean the device. Only use a soft, clean, dry cloth to clean the surface of the device.
- Do not paint the device. Paint can clog the moving parts and prevent proper operation.
- Use only the supplied or an approved replacement antenna. Unauthorised antennas, modifications, or attachments could damage the device and may violate regulations governing radio devices.
- Use chargers indoors.
- Backup all data you want to keep, such as contacts and calendar notes.
- To reset the device from time to time for optimum performance, power off the device and remove the battery.

These suggestions apply equally to your device, battery, charger, or any accessory.

### Recycle

Always return your used electronic products, batteries, and packaging materials to dedicated collection points. This way you help prevent uncontrolled waste disposal and promote the recycling of materials. Check product environmental information and how to recycle your Nokia products at [www.nokia.com/werecycle](http://www.nokia.com/werecycle), or [nokia.mobi/werecycle](http://nokia.mobi/werecycle).

### Additional safety information

**Note:** The surface of this device does not contain nickel in the platings. The surface of this device contains stainless steel.

### Small children

Your device and its accessories are not toys. They may contain small parts. Keep them out of the reach of small children.

### Operating environment

This device meets RF exposure guidelines in the normal use position at the ear or at least 1.5 centimetres (5/8 inch) away from the body. Any carry case, belt clip, or holder for body-worn operation should not contain metal and should position the device the above-stated distance from your body.

To send data files or messages requires a quality connection to the network. Data files or messages may be delayed until such a connection is available. Follow the separation distance instructions until the transmission is completed.

Parts of the device are magnetic. Metallic materials may be attracted to the device. Do not place credit cards or other magnetic storage media near the device, because information stored on them may be erased.

### Medical devices

Operation of radio transmitting equipment, including wireless phones, may interfere with the function of inadequately protected medical devices. Consult a physician or the manufacturer of the medical device to determine whether they are adequately shielded from external RF energy. Switch off your device when regulations posted instruct you to do so. Hospitals or health care facilities may use equipment sensitive to external RF energy.

### Implanted medical devices

Manufacturers of medical devices recommend a minimum separation of 15.3 centimetres (6 inches) between a wireless device and an implanted medical device, such as a pacemaker or implanted cardioverter defibrillator, to avoid potential interference with the medical device. Persons who have such devices should:

- Always keep the wireless device more than 15.3 centimetres (6 inches) from the medical device.
- Not carry the wireless device in a breast pocket.
- Hold the wireless device to the ear opposite the medical device.
- Turn the wireless device off if there is any reason to suspect that interference is taking place.
- Follow the manufacturer directions for the implanted medical device.

If you have any questions about using your wireless device with an implanted medical device, consult your health care provider.

### Hearing aids

Some digital wireless devices may interfere with some hearing aids.

### Vehicles

RF signals may affect improperly installed or inadequately shielded electronic systems in motor vehicles such as electronic fuel injection systems, electronic antilock braking, electronic speed control systems, and air bag systems. For more information, check with the manufacturer of your vehicle or its equipment.

Only qualified personnel should service the device or install the device in a vehicle. Faulty installation or service may be dangerous and may invalidate any warranty that may apply to the device. Check regularly that all wireless device equipment in your vehicle is mounted and operating properly. Do not store or carry flammable liquids, gases, or explosive materials in the same compartment as the device, its parts, or accessories. Remember that air bags inflate with great force. Do not place your device or accessories in the air bag deployment area.

Switch off your device before boarding an aircraft. The use of wireless teledevices in an aircraft may be dangerous to the operation of the aircraft and may be illegal.

### Potentially explosive environments

Switch off your device in any area with a potentially explosive atmosphere. Obey all posted instructions. Sparks in such areas could cause an explosion or fire resulting in bodily injury or death. Switch off the device at refuelling points such as near gas pumps at service stations. Observe restrictions in fuel depots, storage, and distribution areas; chemical plants; or where blasting operations are in progress. Areas with a potentially explosive atmosphere are often, but not always, clearly marked. They include areas where you would be advised to turn off your vehicle engine, below deck on boats, chemical transfer or storage facilities and where the air contains chemicals or particles such as grain, dust, or metal powders. You should check with the manufacturers of vehicles using liquefied petroleum gas (such as propane or butane) to determine if this device can be safely used in their vicinity.

### Emergency calls

**Important:** This device operates using radio signals, wireless networks, landline networks, and user-programmed functions. If your device supports voice calls over the internet (internet calls), activate both the internet calls and the cellular phone. The device may attempt to make emergency calls over both the cellular networks and through your internet call provider if both are activated. Connections in all conditions cannot be guaranteed. You should never rely solely on any wireless device for essential communications like medical emergencies.

To make an emergency call:

- 1 If the device is not on, switch it on. Check for adequate signal strength. Depending on your device, you may also need to complete the following:
  - Insert a SIM card if your device uses one.
  - Remove certain call restrictions you have activated in your device.
  - Change your profile from Offline or Flight profile to an active profile.
- 2 Press the end key as many times as needed to clear the display and ready the device for calls.
- 3 Enter the official emergency number for your present location. Emergency numbers vary by location.
- 4 Press the call key.

When making an emergency call, give all the necessary information as accurately as possible. Your wireless device may be the only means of communication at the scene of an accident. Do not end the call until given permission to do so.

### Certification information (SAR)

**This mobile device meets guidelines for exposure to radio waves.**

Your mobile device is a radio transmitter and receiver. It is designed not to exceed the limits for exposure to radio waves recommended by international guidelines. These guidelines were developed by the independent scientific organisation ICNIRP and include safety margins designed to assure the protection of all persons, regardless of age and health.

The exposure guidelines for mobile devices employ a unit of measurement known as the Specific Absorption Rate or SAR. The SAR limit stated in the ICNIRP guidelines is 2.0 watts/kilogram (W/kg) averaged over 10 grams of tissue. Tests for SAR are conducted using standard operating positions with the device transmitting at its highest certified power level in all tested frequency bands. The actual SAR level of an operating device can be below the maximum value because the device is designed to use only the power required to reach the network. That amount changes depending on a number of factors such as how close you are to a network base station.

The highest SAR value under the ICNIRP guidelines for use of the device at the ear is 0.82 W/kg.

Use of device accessories may result in different SAR values. SAR values may vary depending on national reporting and testing requirements and the network band. Additional SAR information may be provided under product information at [www.nokia.com](http://www.nokia.com).

## DECLARATION OF CONFORMITY

# CE 0434

Hereby, NOKIA CORPORATION declares that this RM-618 product is in compliance with the essential requirements and other relevant provisions of Directive 1999/5/EC. A copy of the Declaration of Conformity can be found at [http://www.nokia.com/phones/declaration\\_of\\_conformity/](http://www.nokia.com/phones/declaration_of_conformity/).

© 2009 Nokia. All rights reserved.

Nokia, Nokia Connecting People, and Navi are trademarks or registered trademarks of Nokia Corporation. Nokia tune is a sound mark of Nokia Corporation. Other product and company names mentioned herein may be trademarks or tradenames of their respective owners.

Reproduction, transfer, distribution, or storage of part or all of the contents in this document in any form without the prior written permission of Nokia is prohibited. Nokia operates a policy of continuous development. Nokia reserves the right to make changes and improvements to any of the products described in this document without prior notice.



Includes RSA BSAFE cryptographic or security protocol software from RSA Security.



Java is a trademark of Sun Microsystems, Inc.

This product is licensed under the MPEG-4 Visual Patent Portfolio License (i) for personal and noncommercial use in connection with information which has been encoded in compliance with the MPEG-4 Visual Standard by a consumer engaged in a personal and noncommercial activity and (ii) for use in connection with MPEG-4 video provided by a licensed video provider. No license is granted or shall be implied for any other use. Additional information, including that related to promotional, internal, and commercial uses, may be obtained from MPEG LA, LLC. See <http://www.mpegla.com>.

TO THE MAXIMUM EXTENT PERMITTED BY APPLICABLE LAW, UNDER NO CIRCUMSTANCES SHALL NOKIA OR ANY OF ITS LICENSORS BE RESPONSIBLE FOR ANY LOSS OF DATA OR INCOME OR ANY SPECIAL, INCIDENTAL, CONSEQUENTIAL OR INDIRECT DAMAGES HOWSOEVER CAUSED.

THE CONTENTS OF THIS DOCUMENT ARE PROVIDED "AS IS". EXCEPT AS REQUIRED BY APPLICABLE LAW, NO WARRANTIES OF

ANY KIND, EITHER EXPRESS OR IMPLIED, INCLUDING, BUT NOT LIMITED TO, THE IMPLIED WARRANTIES OF MERCHANTABILITY AND FITNESS FOR A PARTICULAR PURPOSE, ARE MADE IN RELATION TO THE ACCURACY, RELIABILITY OR CONTENTS OF THIS DOCUMENT. NOKIA RESERVES THE RIGHT TO REVISE THIS DOCUMENT OR WITHDRAW IT AT ANY TIME WITHOUT PRIOR NOTICE.

The availability of particular products and applications and services for these products may vary by region. Please check with your Nokia dealer for details and availability of language options. This device may contain commodities, technology or software subject to export laws and regulations from the US and other countries. Diversion contrary to law is prohibited. The third-party applications provided with your device may have been created and may be owned by persons or entities not affiliated with or related to Nokia. Nokia does not own the copyrights or intellectual property rights to the third-party applications. As such, Nokia does not take any responsibility for end-user support, functionality of the applications, or the information in the applications or these materials. Nokia does not provide any warranty for the third-party applications. BY USING THE APPLICATIONS YOU ACKNOWLEDGE THAT THE APPLICATIONS ARE PROVIDED AS IS WITHOUT WARRANTY OF ANY KIND, EXPRESS OR IMPLIED, TO THE MAXIMUM EXTENT PERMITTED BY APPLICABLE LAW. YOU FURTHER ACKNOWLEDGE THAT NEITHER NOKIA NOR ITS AFFILIATES MAKE ANY REPRESENTATIONS OR WARRANTIES, EXPRESS OR IMPLIED, INCLUDING BUT NOT LIMITED TO WARRANTIES OF TITLE, MERCHANTABILITY OR FITNESS FOR A PARTICULAR PURPOSE, OR THAT THE APPLICATIONS WILL NOT INFRINGE ANY THIRD-PARTY PATENTS, COPYRIGHTS, TRADEMARKS, OR OTHER RIGHTS.

/Issue 1 EN

**Index****A**

access codes	6
accessories	27
accounts	18
alarm clock	28
attachments	18
audio messages	19

**B**

backing up data	25
battery	9
— charging	10
battery charge level indicator	11
browser	30

**C**

calls	14
camera	22
configuration	27

**D**

date and time	24
display	24

**E**

e-mail	18
extras	29

**F**

factory settings, restoring	28
flash messages	19
flashlight	13

**G**

Gallery	28
games	29

**H**

headset	13
home screen	11

**I**

IM (instant messaging)	18
image mode	22
images	23
internet	30

**K**

keyguard	12
keypad lock	12
keys and parts	8

**L**

log	20
-----	----

**M**

mail	18
mail setup	18
media player	21
memory card	9
menus	16
message centre number	17
message settings	19
messages	17
microSD card	9

**N**

Nokia support information	7
---------------------------	---

**O**

Ovi	30
-----	----

**P**

passwords	6
phone settings	27
PIN code	6
powering device on/off	10
predictive text input	15
profiles	24

**R**

radio	22
restoring settings	28

**S**

security code	6
settings	24
— display	24
shortcuts	25
signal strength indicator	11
SIM card	9
software updates	6, 7
speed dialling	14
status indicators	11
strap	14
support	7
switching device on/off	10
synchronisation	25

**T**

text input	15
text messages	17
tones	24
turning device on/off	10

**U**

updates	7
— applications	6
— device software	6, 7
USB cable connection	13

**V**

video clips	23
video mode	22
voice messages	19
voice recorder	29

**W**

web	30
write text	15

## Free Manuals Download Website

<http://myh66.com>

<http://usermanuals.us>

<http://www.somanuals.com>

<http://www.4manuals.cc>

<http://www.manual-lib.com>

<http://www.404manual.com>

<http://www.luxmanual.com>

<http://aubethermostatmanual.com>

Golf course search by state

<http://golfingnear.com>

Email search by domain

<http://emailbydomain.com>

Auto manuals search

<http://auto.somanuals.com>

TV manuals search

<http://tv.somanuals.com>