

# **Nokia X5-00 User Guide**

Issue 1.3

### Contents

#### Safety

**5**

Nokia X5-00 customised for China Mobile	6
About your device	6
Magnets and magnetic fields	8
Synchronisation settings and data deletion	8
Network services	8

#### Get started

**9**

Insert SIM card and battery	9
Keys and parts	12
Keys and parts (back and sides)	13
Switch the device on	14
Charge the battery	15
Memory card	17
Headset	19
Strap	20
Shortcuts	21
Display indicators	21
Network settings	23
Support	23

#### Find help

**25**

Instructions inside - In-device help	25
--------------------------------------	----

Nokia support and contact information	25
Additional applications	26
Settings	26
Access codes	26
Prolong battery life	27
Free memory	28

#### Your device

**30**

Transfer content	30
Lock the keypad	31
Find items	31
Mobile Search	32
Offline profile	32

#### Personalise your device

**33**

Set tones for profiles	33
Modify the standby mode	34
Modify the main menu	34

#### Music folder

**36**

Music player	36
Music key	38
Radio applications	39

#### Camera

**42**

About the camera	42
Activate the camera	42
Image capture	42
Video recording	46

---

Camera settings	48	<b>Write text</b>	<b>71</b>
<b>Positioning (GPS)</b>	<b>51</b>	Input method indicators	71
About GPS	51	Default input method	71
Assisted GPS (A-GPS)	51	Switch input methods	71
Hold your device correctly	52	Pinyin input method	72
<b>Licenses</b>	<b>54</b>	Stroke input method	74
Use licences	54	Insert special characters and punctuation marks in Chinese input mode	77
<b>Web browser</b>	<b>56</b>	Traditional text input	77
Browse the web	56	Predictive text input	78
Web feeds and blogs	57	Tips on text input	78
Empty the cache	58	<b>Messaging</b>	<b>80</b>
End the connection	58	Messaging main view	80
Connection security	59	Write and send messages	81
<b>My favorites</b>	<b>60</b>	E-mail	82
<b>Monternet</b>	<b>61</b>	<b>Make calls</b>	<b>84</b>
<b>China Mobile services</b>	<b>62</b>	Voice calls	84
<b>Service shortcut</b>	<b>63</b>	Make a video call	84
<b>Connections</b>	<b>64</b>	Video call in the standby mode	85
Bluetooth connectivity	64	<b>Phonebook manager</b>	<b>87</b>
<b>Remote configuration</b>	<b>69</b>	<b>Green tips</b>	<b>88</b>
		Save energy	88
		Recycle	88
		Save paper	89
		Learn more	89

---

**e100 90**

**Product and safety  
information 90**

**Index 118**

## Safety

Read these simple guidelines. Not following them may be dangerous or illegal. Read the complete user guide for further information.

### SWITCH ON SAFELY



Do not switch the device on when wireless phone use is prohibited or when it may cause interference or danger.

### ROAD SAFETY COMES FIRST



Obey all local laws. Always keep your hands free to operate the vehicle while driving. Your first consideration while driving should be road safety.

### INTERFERENCE



All wireless devices may be susceptible to interference, which could affect performance.

### SWITCH OFF IN RESTRICTED AREAS



Follow any restrictions. Switch the device off in aircraft, near medical equipment, fuel, chemicals, or blasting areas.

### QUALIFIED SERVICE



Only qualified personnel may install or repair this product.

### ACCESSORIES AND BATTERIES



Use only approved accessories and batteries. Do not connect incompatible products.

### WATER-RESISTANCE



Your device is not water-resistant. Keep it dry.

### Nokia X5-00 customised for China Mobile

The instructions in this user guide only apply to Nokia X5-00 customised for China Mobile.

The post-sales service point and service content are similar for both customised and other non-customised devices. With regards to the menus and features provided with the device customised for China Mobile, see Monternet or contact China Mobile customer service hotline for more information, post-sales service, and technical support.

Nokia does not provide any warranty on technical support for the services rendered by any network service provider, content provider, or service provider.

For information on the content and pricing of the services provided by China Mobile, contact China Mobile customer service hotline.

### About your device

The wireless device described in this guide is approved for use on the GSM 900, 1800, 1900 networks (hereafter referred to as 2G networks), and TD-SCDMA /TD-HSDPA networks (hereafter referred to as 3G networks). Contact your service provider for more information about networks.

Your device supports several connectivity methods and like computers may be exposed to viruses and other harmful content. Exercise caution with messages, connectivity requests, browsing, and downloads. Only install and use services and software from trustworthy sources that offer adequate security and protection, such as applications that are Symbian Signed or have passed the Java Verified™ testing. Consider installing antivirus and other security software on your device and any connected computer.

Your device may have preinstalled bookmarks and links for third-party internet sites and may allow you to access third-party sites. These are not affiliated with Nokia, and Nokia does not endorse or assume liability for them. If you access such sites, take precautions for security or content.

**Warning:**

To use any features in this device, other than the alarm clock, the device must be switched on. Do not switch the device on when wireless device use may cause interference or danger.

When using this device, obey all laws and respect local customs, privacy and legitimate rights of others, including copyrights. Copyright protection may prevent some images, music, and other content from being copied, modified, or transferred.

Make back-up copies or keep a written record of all important information stored in your device.

When connecting to any other device, read its user guide for detailed safety instructions. Do not connect incompatible products.

The images in this guide may differ from your device display.

Refer to the user guide for other important information about your device.

### **Magnets and magnetic fields**

Keep your device away from magnets or magnetic fields.

### **Synchronisation settings and data deletion**

Pay attention to synchronisation settings. Data deletion as part of normal synchronisation process is determined by the settings selected.

### **Network services**

To use the device you must have service from a wireless service provider. Some features are not available on all networks; other features may require that you make specific arrangements with your service provider to use them. Network services involve transmission of data. Check with your service provider for details about fees in your home network and when roaming on other networks. Your service provider can explain what charges will apply. Some networks may have limitations that affect how you can use some features of this device requiring network support such as support for specific technologies like WAP 2.0 protocols (HTTP and SSL) that run on TCP/IP protocols and language-dependent characters.

Your service provider may have requested that certain features be disabled or not activated in your device. If so, these features will not appear on your device menu. Your device may also have customized items such as menu names, menu order, and icons.



## Get started

### Insert SIM card and battery

Always switch the device off and disconnect the charger before removing the battery.

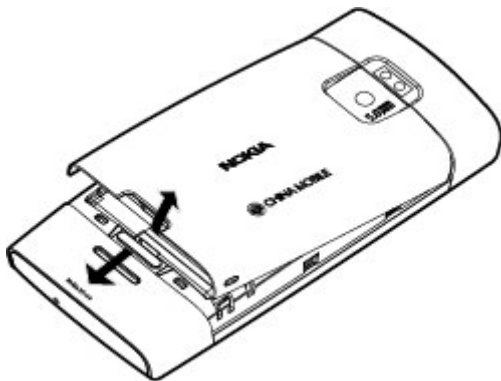

- 1 With the back of the device facing you, press the release button, and lift up the back cover.
- 2 Insert the SIM card into the card slot. Make sure the contact area of the card is facing down.

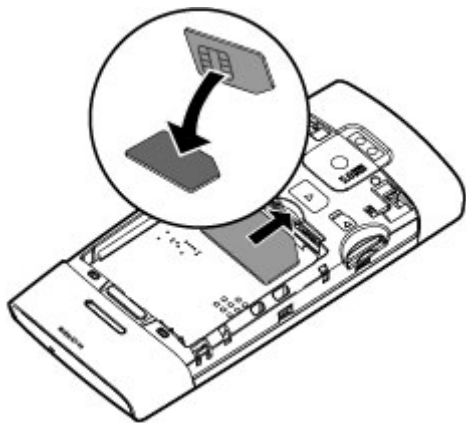

- 3 Insert the battery.

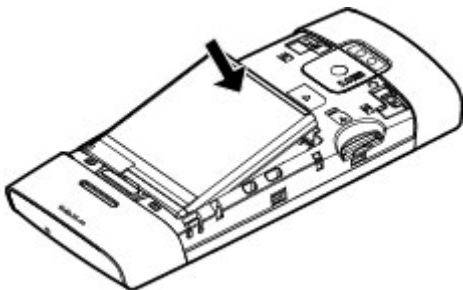

- 4 To replace the back cover, direct the top locking catches toward their slots, and press down until the cover locks into place.

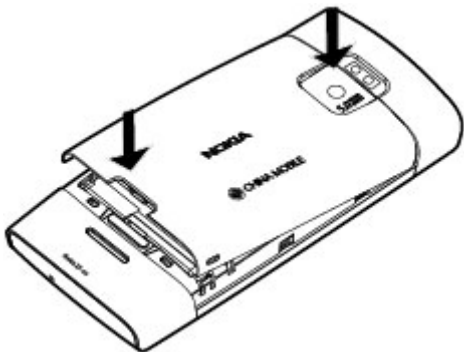

## 12 Get started

**Important:** To prevent damage to the SIM card, always remove the battery before you insert or remove the card.

### Keys and parts

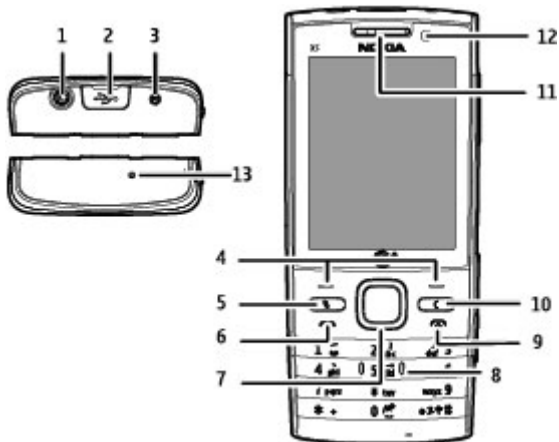

- 1 Nokia AV Connector (3.5 mm)
- 2 Micro USB connector
- 3 Charger connector
- 4 Selection keys
- 5 Menu key 
- 6 Call key

- 7 Navi™ key (scroll key)
- 8 Keypad
- 9 End/Power key
- 10 Clear key C
- 11 Earpiece
- 12 Secondary camera
- 13 Microphone

### Keys and parts (back and sides)

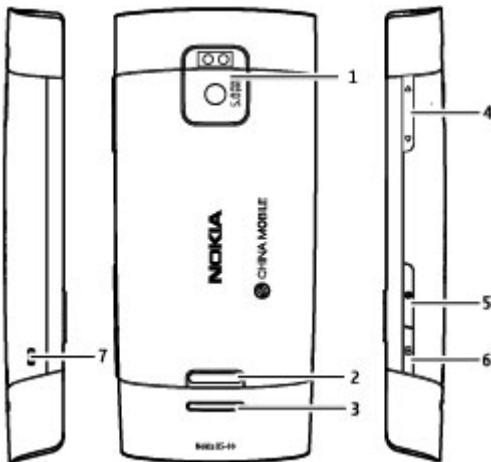

## 14 Get started

---

- 1 Main camera
- 2 Cover release button
- 3 Speaker
- 4 Volume keys
- 5 Music key
- 6 Capture key
- 7 Wrist strap eyelet

### Switch the device on

- 1 Press and hold the power key.



- 
- 2 If prompted, enter the PIN code or lock code. The factory setting for the lock code is 12345.

Your device may have internal and external antennas. Avoid touching the antenna area unnecessarily while the antenna is transmitting or receiving. Contact with antennas affects the communication quality and may cause a higher power level during operation and may reduce the battery life.

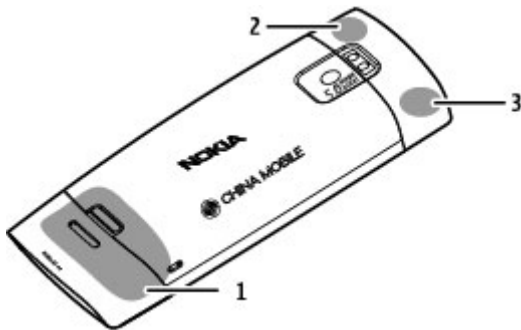

- 1 Cellular antenna
- 2 GPS receiver
- 3 Antenna for Bluetooth technology

### Charge the battery

**Note:** Use the adapter cable with the USB connector only for charging. It is not a data cable.

## 16 Get started

---

Your battery has been partially charged at the factory. If the device indicates a low charge, do the following:

- 1 Connect the charger to a wall outlet.
- 2 Connect the lead from the adapter cable to the USB connector of the charger.



- 3 Connect the lead from the adapter cable to the charger connector of your device.
- 4 When the device indicates a full charge, disconnect the charger from the device, then from the wall outlet.

You do not need to charge the battery for a specific length of time, and you can use the device while it is charging. If the battery is completely discharged, it may take several minutes before the charging indicator appears on the display or before any calls can be made.



## Memory card



Use only compatible microSD cards approved by Nokia for use with this device. Nokia uses approved industry standards for memory cards, but some brands may not be fully compatible with this device. Incompatible cards may damage the card and the device and corrupt data stored on the card.

### Insert a memory card

The memory card may be supplied with the device, and may already be inserted.

- 1 Open the cover.
- 2 Place the card in the slot with the contact area facing down.

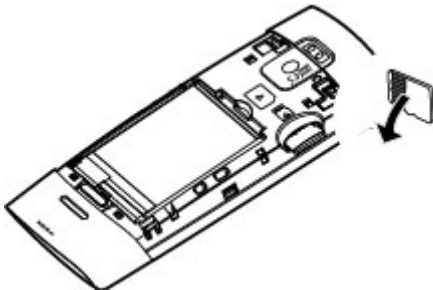

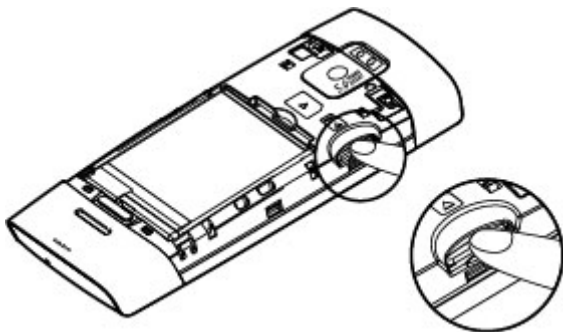

- 3 Push the card gently to lock it into place. Close the cover.

### Remove a memory card

**Important:** Do not remove the memory card during an operation when the card is being accessed. Doing so may damage the memory card and the device, and corrupt data stored on the card.

- 1 Press the power key briefly, and select **Remove memory card** > **Yes**.
- 2 Open the back cover.
- 3 Press the memory card gently to release it.



- 4 Pull the card out, and select **OK**.
- 5 Replace the back cover.

### Headset

You can connect a compatible headset or compatible headphones to your device. You may need to select the cable mode.



### **Warning:**

When you use the headset, your ability to hear outside sounds may be affected. Do not use the headset where it can endanger your safety.

To make handsfree phone calls, use a headset with a compatible remote control unit, or use the microphone on the device.

Do not connect products that create an output signal as this may cause damage to the device. Do not connect any voltage source to the Nokia AV Connector.

When connecting any external device or any headset, other than those approved by Nokia for use with this device, to the Nokia AV Connector, pay special attention to volume levels.

### **Strap**

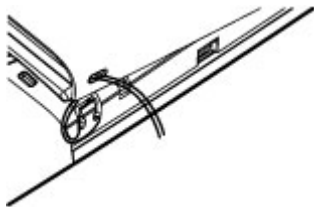

Remove the back cover, thread the strap as illustrated, tighten it, and replace the back cover.

## Shortcuts

To switch between open applications, press and hold .

Leaving applications running in the background increases the demand on battery power and reduces the battery life.

To start a web connection (network service), in the standby mode, press and hold **0**.

In many applications, to view the most common option items () , press the scroll key.





To change the profile, press the power key, and select a profile.

To switch between the **General** and **Silent** profiles, in the standby mode, press and hold **#**.

To call your voice mailbox (network service), in the standby mode, press and hold **1**.

To open the last dialled numbers list, in the standby mode, press the call key.

## Display indicators

-  The device is being used in a GSM network (network service).
-  The device is being used in a 3G network (network service).
-  You have one or more unread messages in the Inbox folder in Messaging.
-  You have received new e-mail in the remote mailbox.
-  There are messages waiting to be sent in the Outbox folder.



You have missed calls.



The ringing type is set to silent.



A timed profile is active.



The device keypad is locked.



A clock alarm is active.





All calls to the device are diverted to another number (network service).





A compatible headset is connected to the device.





A GPRS packet data connection is active (network service).  indicates the connection is on hold and  that a connection is available.





A packet data connection is active in a part of the network that supports EGPRS (network service).  indicates the connection is on hold and  that a connection is available. The icons indicate that EGPRS is available in the network, but your device is not necessarily using EGPRS in the data transfer.



A 3G packet data connection is active (network service).  indicates the connection is on hold and  that a connection is available.



High-speed downlink packet access (HSDPA) is supported and active (network service).  indicates the connection is on hold and  that a connection is available.



The device is in the coverage of an HSDPA network (network service).



Bluetooth connectivity is activated.



Data is being transmitted using Bluetooth connectivity. When the indicator is blinking, your device is trying to connect with another device.



A USB connection is active.

 Synchronisation is in progress.

## Network settings

Your device can automatically switch between GSM and 3G networks. The GSM network is indicated with **G** in the standby mode. The 3G network is indicated with **T**.

Select  > **Settings and Phone** > **Network** and from the following:

**Network mode** — Select which network to use. If you select **Dual mode**, the device uses the GSM or 3G network automatically, according to the network parameters and the roaming agreements between the wireless service providers. For details and roaming costs, contact your network service provider. This option is shown only if supported by the wireless service provider.

A roaming agreement is an agreement between two or more service providers to enable the users of one service provider to use the services of other service providers.

**Operator selection** — Select **Automatic** to set the device to search for and select one of the available networks, or **Manual** to manually select the network from a list. The selected network must have a roaming agreement with your home cellular network.

**Cell info display** — Set the device to indicate when it is used in a cellular network based on microcellular network (MCN) technology, and to activate cell info reception.

## Support

When you want to learn more about how to use your product or you are unsure how your device should function, see the support pages at [www.nokia.com/support](http://www.nokia.com/support) or your local Nokia website, [www.nokia.mobi/support](http://www.nokia.mobi/support) (with a mobile device), the Help application in the device, or the user guide.

If this does not resolve your issue, do one of the following:

- Restart the device: switch off the device, and remove the battery. After about a minute, replace the battery, and switch on the device.
- Restore the original factory settings as explained in the user guide. Your documents and files will be deleted in the reset, so back up your data first.

If your issue remains unsolved, contact Nokia for repair options. See [www.nokia.com.cn/repair](http://www.nokia.com.cn/repair). Before sending your device for repair, always back up the data in your device.



## Find help

### Instructions inside - In-device help

Your device contains instructions to help you use it.

When an application is open, to access the help text for the current view, select **Options > Help**.



To open help from the main menu, select **Tools > Utilities > Help**, and the relevant application.



You can find links to related topics at the end of the help text.

To make the instructions easier to read, you can change the size of the text.

If you click on an underlined word, a short explanation is displayed.

Help uses the following indicators:

-  shows a link to a related help topic.
-  shows a link to the application being discussed.

When you are reading the instructions, to switch between help and the application that is open in the background, press and hold , or select the application link ().

### Nokia support and contact information

For the latest guides, additional information, downloads, and services related to your Nokia product, see [www.nokia.com/support](http://www.nokia.com/support) or your local Nokia website. You may also download free configuration settings such as MMS, GPRS, e-mail, and other services for your device model at [www.nokia.com.cn/settings](http://www.nokia.com.cn/settings).

If you need to contact customer service, check the list of local Nokia Care contact centres at [www.nokia.com.cn/contactus](http://www.nokia.com.cn/contactus).

For maintenance services, check your nearest Nokia Care point at [www.nokia.com.cn/repair](http://www.nokia.com.cn/repair).

### Additional applications

There are various applications provided by Nokia and different third-party software developers that help you do more with your device. These applications are explained in the guides that are available on the product support pages of the Nokia website.

### Settings

Your device normally has MMS, GPRS, streaming, and mobile internet settings automatically configured in the device, based upon your network service provider information. You may have settings from your service providers already installed in your device, or you may receive or request the settings from the network service providers as a special message.

You can change the general settings in your device, such as language, standby mode, display, and keypad lock settings.

### Access codes

If you forget any of the access codes, contact your service provider.

Personal identification number (PIN) code — This code protects your SIM card against unauthorised use. The PIN code (4 - 8 digits) is usually supplied with the SIM card. After three consecutive incorrect PIN code entries, the code is blocked, and you need the PUK code to unblock it.

**UPIN code** — This code may be supplied with the USIM card. The USIM card is an enhanced version of the SIM card and is supported by 3G mobile phones.

**PIN2 code** — This code (4 - 8 digits) is supplied with some SIM cards, and is required to access some functions in your device.

**Lock code (also known as security code)** — The lock code helps you to protect your device against unauthorised use. The preset code is 12345. You can create and change the code, and set the device to request the code. Keep the new code secret and in a safe place separate from your device. If you forget the code and your device is locked, your device will require service. Additional charges may apply, and all the personal data in your device may be deleted. For more information, contact a Nokia Care point or your device dealer.

**Personal Unblocking Key (PUK) code and PUK2 code** — These codes (8 digits) are required to change a blocked PIN code or PIN2 code, respectively. If the codes are not supplied with the SIM card, contact the network service provider whose SIM card is in your device.

**UPUK code** — This code (8 digits) is required to change a blocked UPIN code. If the code is not supplied with the USIM card, contact the network service provider whose USIM card is in your device.

### **Prolong battery life**

Many features in your device increase the demand on battery power and reduce the battery life time. To save battery power, note the following:

- Features that use Bluetooth technology, or allowing such features to run in the background while using other features, increase the demand on battery power. Turn Bluetooth technology off when you do not need it.
- If you have set **Packet data connection** to **When available** in connection settings, and there is no packet data coverage (GPRS), the device periodically tries to establish a packet data connection. To prolong the operating time of your device, select **Packet data connection** > **When needed**.

- If the signal strength of the cellular network varies much in your area, your device must scan for the available network repeatedly. This increases the demand on battery power.

If the network mode is set to dual mode in the network settings, the device searches for the 3G network. To only use the GSM network, select  > **Settings and Phone** > **Network** > **Network mode** > **GSM**.

- The backlight of the display increases the demand on battery power. In the display settings, you can change the time-out after which the backlight is switched off, and adjust the brightness of the display.
- Leaving applications running in the background increases the demand on battery power. To close the applications that you are not using, press and hold , scroll to an application in the list, and press **C**.
- To activate or deactivate power save mode, press the power key, and select **Activate power saving** or **Deactivate power saving**. You may not be able to modify the settings of certain applications when power save mode is activated.

### Free memory

To view how much space is available for different data types, select  > **Tools** > **File mgr.**.

Many features of the device use memory to store data. The device notifies you if the memory in different memory locations is low.

To free memory, transfer data to a compatible memory card (if available) or to a compatible computer.

To remove data you no longer need, use File manager or open the respective application. You can remove the following:

- Messages in the folders in Messaging and retrieved e-mail messages in the mailbox
- Saved web pages
- Contact information
- Calendar notes
- Applications shown in Application manager that you do not need
- Installation files (.sis or .sisx) of applications you have installed. Transfer the installation files to a compatible computer.
- Images and video clips in Gallery. Back up the files to a compatible computer.

### Your device

#### Transfer content

You can use the Switch application to copy content such as phone numbers, addresses, calendar items, and images from your previous Nokia device to your Nokia X5-00.

The type of content that can be transferred depends on the model of the device from which you want to transfer content. If that device supports synchronisation, you can also synchronise data between the devices. Your Nokia X5-00 notifies you if the other device is not compatible.

If the other device cannot be switched on without a SIM card, you can insert your SIM card in it. When your Nokia X5-00 is switched on without a SIM card, the Offline profile is automatically activated, and transfer can be done.

#### Transfer content for the first time

- 1 Select  > **Tools** > **Switch**.
- 2 Select the connection type you want to use to transfer the data. Both devices must support the selected connection type.
- 3 If you select Bluetooth connectivity as the connection type, connect the two devices. To have your device search for devices with Bluetooth connectivity, select **Continue**. Select the device from which you want to transfer content. You are asked to enter a code on your Nokia X5-00. Enter a code (1-16 digits), and select **OK**. Enter the same code on the other device, and select **OK**. The devices are now paired.

Some earlier Nokia devices may not have the Switch application. In this case, the Switch application is sent to the other device as a message. To install the Switch application on the other device, open the message, and follow the instructions on the display.

- 4 On your Nokia X5-00, select the content you want to transfer from the other device.

When the transfer has started, you can cancel it and continue later.

Content is transferred from the memory of the other device to the corresponding location in your Nokia X5-00. The transfer time depends on the amount of data to be transferred.

### Lock the keypad

To lock the keys, press the left selection key, then \*.

To unlock the keys, press the left selection key, then \*.

You can set the keypad to lock automatically after a time-out.

To illuminate the keypad in low light conditions, briefly press the power key.

### Find items

When a search field is available in the application, you can use the search field to search for a name, file, or application.

- 1 To search for an item, enter text in the search field. The device will immediately start to search and filter the entries matching to the text you input. The more texts you input, the more accurate the search result will be. When entering text, use the input methods included in your device. The current input method indicator will be shown in the search field near the magnifier icon.
- 2 After finding your needed item, press the scroll key to open it.

### Mobile Search

Select  > **Apps.** > **Search.**

Use Search to access internet search engines and to find and connect to local services, websites, images, and mobile content. You can also search content in your device, such as calendar entries, e-mail, and other messages.

### Offline profile

To activate the offline profile, press the power key briefly, and select **Offline.**

The offline profile lets you use the device without connecting to the wireless network. When you activate the offline profile, the connection to the wireless network is turned off, as indicated by  in the signal strength indicator area. All wireless RF signals to and from the device are prevented. If you try to send messages, they are placed in the outbox to be sent later.

When the offline profile is active, you can use your device without a SIM card.

**Important:** In the Offline profile you cannot make or receive any calls, or use other features that require cellular network coverage. To make calls, you must first activate the phone function by changing profiles. If the device has been locked, enter the lock code.

To leave the offline profile, press the power key briefly, and select another profile. The device re-enables wireless transmissions (providing there is sufficient signal strength).



## Personalise your device

You can personalise your device by changing the standby mode, main menu, tones, themes, or font size. Most of the personalisation options, such as changing the font size, can be accessed through the device settings.

### Set tones for profiles

You can use profiles to set and customise the ringing tones, message alert tones, and other tones for different events, environments, or caller groups.

Select  > **Tools** > **Profiles**.

To change the profile, select a profile and **Options** > **Activate**, or in the standby mode, press the power key briefly, and select a profile.

**Tip:** To switch between the General and Silent profiles in the standby mode, press and hold #.

To modify a profile, scroll to the profile, and select **Options** > **Personalise**.

If you want to set a profile to be active until a certain time, select **Options** > **Timed**. When the set time expires, the profile changes back to the previously active one. When a profile is timed,  is displayed in the standby mode. The Offline profile cannot be timed.

To create a new profile, select **Options** > **Create new**.

### Modify the standby mode

To change the look of the standby mode, select  > **Settings and General** > **Personalisation** > **Standby mode**.

In the active standby mode, application shortcuts, and events from applications such as Calendar, E-mail, and Music player are displayed.

To change the selection key shortcuts or the default shortcut icons in the active standby mode, select  > **Settings and General** > **Personalisation** > **Standby mode** > **Shortcuts**.

To change the clock displayed in the standby mode, select  > **Apps.** > **Clock and Options** > **Settings** > **Clock type**.

You can also change the standby mode background image or the power saver in the device settings.

**Tip:** To check whether there are applications running in the background, press and hold the menu key. To close the applications you are not using, scroll to an application in the list, and press **C**. Leaving applications running in the background increases the demand on battery power.

### Modify the main menu

To change the main menu view, in the main menu, select  > **Settings and General** > **Personalisation** > **Themes** > **Menu view**. You can change the main menu to be shown as **Grid**, **List**, **Horseshoe**, or **V-shaped**.

To rearrange the main menu, in the main menu, select **Options > Move, Move to folder, or New folder**. You can move applications used less frequently into folders and place applications that you use more often into the main menu.

### Music folder

#### Music player

Music player supports files formats such as AAC, AAC+, eAAC+, MP3, and WMA. Music player does not necessarily support all features of a file format or all the variations of file formats.

You can also use Music player to listen to podcast episodes. Podcasting is the method for delivering audio or video content over the internet using either RSS or Atom technologies for playback on mobile devices and PCs.

You can transfer music from other compatible devices to your device. [See "Transfer music to your device", p. 37.](#)

#### Play a song

Select  > **Music** > **Music player**.

To add all available songs to the music library, select **Options** > **Refresh library**.

To play a song, select the desired category, and the song.

To pause playback, press the scroll key; to resume, press the scroll key again. To stop playback, scroll down.

To fast-forward or rewind, press and hold the scroll key to the right or left.

To skip to the next item, scroll right. To return to the beginning of the item, scroll left. To skip to the previous item, scroll left again within 2 seconds after a song has started.

To modify the tone of the music playback, select **Options** > **Equaliser**.

To modify the balance and stereo image, or to enhance the bass, select **Options > Settings**.

To return to the active standby mode and leave the player playing in the background, press the end key briefly.

**Warning:**

Continuous exposure to high volume may damage your hearing. Listen to music at a moderate level, and do not hold the device near your ear when the loudspeaker is in use.

**Transfer music to your device**

You can transfer music from a compatible PC or other compatible devices using a compatible USB data cable or Bluetooth connectivity.

PC requirements for music transfer:

- Microsoft Windows XP operating system (or later)
- A compatible version of the Windows Media Player application. You can get more detailed information about Windows Media Player compatibility from your device's product pages on the Nokia website.
- Nokia Ovi Suite 2.2 or later

Windows Media Player 10 may cause playback delays to WMDRM technology protected files after they have been transferred to your device. See Microsoft support website for a hotfix to Windows Media Player 10 or get a newer compatible version of Windows Media Player.

### Transfer music from PC

---

You can use the following methods to transfer music:

- To view your device on a PC as a mass memory device where you can transfer any data files, make the connection with a compatible USB data cable or Bluetooth connectivity. If you are using a USB cable, select **Mass storage** as the connection mode. A compatible memory card must be inserted in the device.
- To synchronise music with Windows Media Player, connect a compatible USB data cable and select **Media transfer** as the connection mode. A compatible memory card must be inserted in the device.

To change the default USB connection mode, select  > **Tools** > **Connect.** > **USB** and **USB connection mode.**

### Transfer with Windows Media Player

---

Music synchronisation functions may vary between different versions of the Windows Media Player application. For more information, see the corresponding Windows Media Player guides and help.

### Music key

With the music key, you can quickly access the music on your device.

#### Access your music library from the standby mode

Press the music key.

#### Access the Now playing view from the standby mode

While playing music in the background, press the music key.

## Return to the previous view from the music library or Now playing view

Press the music key.

### Radio applications

#### FM radio

The FM radio depends on an antenna other than the wireless device antenna. A compatible headset or accessory needs to be attached to the device for the FM radio to function properly.

Select  > **Music** > **Radio** > **FM radio**.

The quality of the radio broadcast depends on the coverage of the radio station in that particular area.



#### Listen to the radio

Select  > **Music** > **Radio** > **FM radio**.

The quality of the radio broadcast depends on the coverage of the radio station in that particular area.

You can make a call or answer an incoming call while listening to the radio. The radio is muted when there is an active call.

To start a station search, select  or .

If you have saved radio stations in your device, to go to the next or previous saved station, select  or .

Select **Options** and from the following:

**Activate loudspeaker** — Listen to the radio using the loudspeaker.

**Manual tuning** — Change the frequency manually.

**Station directory** — View available stations based on location (network service).

**Save station** — Save the station to which you are currently tuned to your station list.

**Stations** — Open the list of your saved stations.

**Play in background** — Return to the standby mode while listening to the FM radio in the background.

### Saved stations

---

Select  > Music > Radio > FM radio.

To open the list of your saved stations, select **Options** > **Stations**.

To listen to a saved station, select **Options** > **Station** > **Listen**.

To change station details, select **Options** > **Station** > **Edit**.

### FM radio settings

---

Select  > Music > Radio > FM radio.

To automatically search for alternative frequencies if the reception is weak, select **Options** > **Settings** > **Alternative frequencies** > **Auto scan on**.

To select the region where you currently are, select **Options** > **Settings** > **Current region**. This setting is displayed only if there is no network coverage when you start the application.



## Nokia Internet Radio

With the Nokia Internet Radio application (network service), you can listen to available radio stations on the internet. To listen to radio stations, you must have a packet data access point defined in your device. Listening to the stations may involve the transmission of large amounts of data through your service provider's network. Check with your service provider for terms and data service fees before using other connections. For example, a flat rate data plan can allow large data transfers for a set monthly fee.

### Listen to internet radio stations

---

Select  > Music > Radio > Internet radio.

To listen to a radio station on the internet, do the following:

- 1 Select a station from your favourites or the station directory, or search for stations by name from the Nokia Internet Radio service.  
To add a station manually, select **Options** > **Add station manually**. You can also browse for station links with the Web browser application. Compatible links are automatically opened in the Internet Radio application.
- 2 Select **Listen**.  
The Now playing view opens, displaying information about the currently playing station and song.

To pause the playback, press the scroll key; to resume, press the scroll key again.

To view station information, select **Options** > **Station information** (not available if you have saved the station manually).

If you are listening to a station saved in your favourites, scroll left or right to listen to the previous or next saved station.

### Camera

#### About the camera

Your device supports an image capture resolution of up to 2592 x 1944 pixels (5Mpix). The image resolution in this guide may appear different.

The images and video clips are saved in Gallery.

The produced images are in the JPEG format. Video clips are recorded in the MPEG-4 file format with the .mp4 file extension, or in the 3GPP file format with the .3gp file extension (sharing quality).

To free memory for new images and video clips, transfer files to a compatible PC using a compatible USB data cable, for example, and remove the files from your device. The device informs you when the memory is full. You can then free up memory in the current storage or change the memory in use.

#### Activate the camera

To activate the main camera, press and hold the capture key. To activate the main camera when it is already open in the background, press and hold the capture key.

To close the camera, select **Exit**.

#### Image capture

##### Still image camera indicators

The still image camera viewfinder displays the following:



- 1 Capture mode indicator
- 2 Active toolbar (not displayed during image capture). [See "Active toolbar", p. 43.](#)
- 3 Battery charge level indicator
- 4 Image resolution indicator
- 5 Image counter (the estimated number of images you can capture using the current image quality setting and memory)
- 6 The device memory (📱) and memory card (💾) indicators, which show where images are saved

### Active toolbar

The active toolbar provides you with shortcuts to different items and settings before and after capturing an image or recording a video clip. To select an item from the toolbar, scroll to the item, and press the scroll key. You can also define when the active toolbar is displayed.

The settings on the active toolbar return to the default settings after you close the camera.

To view the active toolbar before and after capturing an image or recording a video clip, select **Options > Show icons**. To view the active toolbar only when you need it, select **Options > Hide icons**. To activate the active toolbar when it is hidden, press the scroll key. The toolbar is visible for 5 seconds.

From the active toolbar, select from the following:



Switch between video and image modes.

Select a scene.

Turn the video light on or off (video mode only).

Select the flash mode (images only).

Activate the self-timer (images only).

Activate sequence mode (images only).

Select a colour effect.

Show or hide the viewfinder grid (images only).

Adjust the white balance.

Adjust the exposure compensation (images only).

Adjust the sharpness (images only).

Adjust the contrast (images only).

Adjust the light sensitivity (images only).

The icons change to reflect the current setting.

Saving the captured image may take longer if you modify the zoom, lighting, or colour settings.

### Capture images

When capturing an image, note the following:

- Use both hands to keep the camera still.

- The quality of a digitally zoomed image is lower than that of a nonzoomed image.
- The camera goes into the battery saving mode if there are no keypresses for a moment. To continue capturing images, press the capture key.

To capture an image, do the following:

- 1 If the camera is in the video mode, select the image mode from the active toolbar.



- 2 To capture an image, press the capture key. Do not move the device before the image is saved and the final image appears on the screen.

To zoom in or out when capturing an image, use the zoom key in your device.

### Flash

Keep a safe distance when using the flash. Do not use the flash on people or animals at close range. Do not cover the flash while taking a picture.

The camera of your device has a dual LED flash for low light conditions.

Select the desired flash mode from the active toolbar: **Automatic** (⚡), **Red-eye** (👁), **On** (⚡), and **Off** (🚫).

### Video recording

#### Video capture indicators

The video viewfinder displays the following:



- 1 Capture mode indicator
- 2 Video stabilisation indicator
- 3 Audio mute indicator
- 4 Active toolbar (not displayed during recording)
- 5 Battery charge level indicator
- 6 Video quality indicator. To change this setting, select **Options > Settings > Video quality**.
- 7 Video clip file type
- 8 Available recording time. When you are recording, the current video length indicator also shows the elapsed and remaining time.
- 9 The location to which the video clip is saved.

### Record videos

- 1 If the camera is in the image mode, select the video mode from the active toolbar.
- 2 To start recording, press the capture key. The red record icon (●) is displayed and a tone sounds.
- 3 To pause recording at any time, press **Pause**. Select **Continue** to resume. If you pause recording and do not press any key within one minute, the recording stops.  
To zoom in or out of the subject, use the zoom key in your device.

- 4 To stop recording, press the capture key. The maximum length of a video clip is approximately 30 seconds with sharing quality and 90 minutes with other quality settings.

To activate the front camera, select **Options** > **Use secondary camera**. To start recording a video, press the scroll key. To zoom in or out, scroll up or down.

### Camera settings

There are two kinds of settings for the camera: setup settings and main settings. The setup settings return to the default settings after you close the camera, but the main settings remain the same until you change them again. To adjust the setup settings, use the options in the active toolbar. [See "Colour and lighting settings", p. 49.](#) To change the main settings, in the image or video mode, select **Options** > **Settings**.

### Still image camera settings

To change the main settings, in the image mode, select **Options** > **Settings** and from the following:

**Image quality** — Set the resolution. The better the image quality, the more memory the image consumes.

**Show captured image** — Select whether to view the captured image after it is taken or to continue image capturing immediately.

**Default image name** — Define the default name for the captured images.

**Extended digital zoom** — **On (continuous)** allows the zoom increments to be smooth and continuous between digital and extended digital zoom, **On (paused)**



allows the zoom increments to pause at the digital and extended digital step point, and **Off** allows a limited amount of zoom while retaining the image resolution. Use the extended zoom only when getting closer to the subject is more important than the final image quality. The overall quality of a digitally zoomed image is always lower than that of an unzoomed image.

**Capture tone** — Set the tone that sounds when you capture an image.

**Memory in use** — Select where to store your images.

**Restore camera settings** — Restore the camera settings to default values.

### Colour and lighting settings

In the active toolbar, select from the following:

**Flash mode**  (image only) — Select the desired flash mode.

**Colour tone**  — Select a colour effect.

**Switch video light on** or **Switch video light off**  — Switch the video light on or off (video mode only).

**White balance**  — Select the current lighting condition. This allows the camera to reproduce colours more accurately.

**Exposure compensation**  (image only) — If you are shooting a dark subject against a very light background, such as snow, adjust the exposure to +1 or +2 to compensate for the background brightness. For light subjects against a dark background, use -1 or -2.

**Sharpness**  (image only) — Adjust the sharpness of the image.

**Contrast**  (image only) — Adjust the difference between the lightest and darkest parts of the image.

**Light sensitivity**  (image only) — Increase the light sensitivity in low light conditions to avoid too dark images.

The screen display changes to match the settings you make.

The available settings vary depending on the selected camera.

The setup settings are shooting-mode specific. Switching between the modes does not reset the defined settings.

The setup settings return to the default settings when you close the camera.

If you select a new scene, the colour and lighting settings are replaced by the selected scene. You can change the setup settings after selecting a scene if needed.

### Video settings

To change the main settings, in the video mode, select **Options** > **Settings** and from the following:

**Video quality** — Set the quality of the video clip. Select **Sharing quality**, if you want to send the video clip using a multimedia message. The clip is recorded with QCIF resolution, in 3GPP format, and the size is limited to 300 kB (approximately 30 seconds). You may not be able to send video clips saved in the MPEG-4 format in a multimedia message.

**Video stabilisation** — Reduce the effects of the camera shaking when recording a video.

**Audio recording** — Select whether to record sound.

**Show captured video** — Select to view the first frame of the recorded video clip after the recording stops. To view the entire video clip, select **Play** from the active toolbar (main camera) or **Options** > **Play** (secondary camera).

**Default video name** — Enter the default name for captured video clips.

**Memory in use** — Select where you want to store your video clips.

**Restore camera settings** — Restore the camera settings to default values.

## Positioning (GPS)

You can use GPS data to find out your location or measure distances. This requires a GPS connection.

### About GPS

The Global Positioning System (GPS) is operated by the government of the United States, which is solely responsible for its accuracy and maintenance. The accuracy of location data can be affected by adjustments to GPS satellites made by the United States government and is subject to change with the United States Department of Defense civil GPS policy and the Federal Radionavigation Plan. Accuracy can also be affected by poor satellite geometry. Availability and quality of GPS signals may be affected by your location, buildings, natural obstacles, and weather conditions. GPS signals may not be available inside buildings or underground and may be impaired by materials such as concrete and metal.

GPS should not be used for precise location measurement, and you should never rely solely on location data from the GPS receiver and cellular radio networks for positioning or navigation.

The trip meter has limited accuracy, and rounding errors may occur. Accuracy can also be affected by availability and quality of GPS signals.

Different positioning methods can be enabled or disabled in positioning settings.

### Assisted GPS (A-GPS)

Your device also supports assisted GPS (A-GPS).

A-GPS requires network support.

Assisted GPS (A-GPS) is used to retrieve assistance data over a packet data connection, which assists in calculating your current location when your device is receiving signals from satellites.

When you activate A-GPS, your device receives useful satellite information from an assistance data server over the cellular network. With the help of assisted data, your device can obtain the GPS position faster.

Your device is preconfigured to use the Nokia A-GPS service, if no service provider-specific A-GPS settings are available. The assistance data is retrieved from the Nokia A-GPS service server only when needed.

A-GPS is an internet service. When using A-GPS, it may incur data charges. For information about costs in your home network, contact your service provider.

To disable the A-GPS service, select  > **Apps.** > **GPS data and Options** > **Positioning settings** > **Positioning methods** > **Assisted GPS** > **Options** > **Disable**.

You must have an internet access point defined in the device to retrieve assistance data from the Nokia A-GPS service over a packet data connection. The access point for A-GPS can be defined in positioning settings. Only a packet data internet access point can be used. Your device asks you to select the internet access point when GPS is used for the first time.

### **Hold your device correctly**

The GPS receiver is located on the back of the device. When using the receiver, make sure that you do not cover the antenna with your hand.

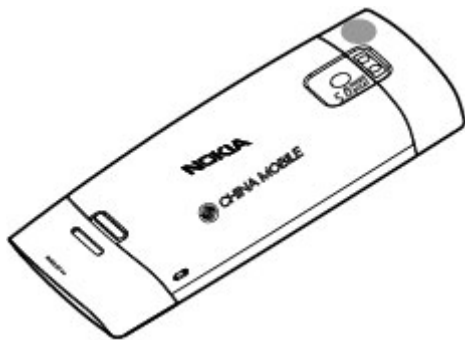

Establishing a GPS connection may take from a couple of seconds to tens of minutes. Establishing a GPS connection in the car, in bad weather conditions, or in a challenging geographical environment may take longer.

The GPS receiver draws its power from the device battery. Using the GPS receiver may drain the battery faster.

### Licenses

Select  > Apps. > Media > Licenses.

#### Digital rights management

Content owners may use different types of digital rights management (DRM) technologies to protect their intellectual property, including copyrights. This device uses various types of DRM software to access DRM-protected content. With this device you can access content protected with OMA DRM 1.0. If certain DRM software fails to protect the content, content owners may ask that such DRM software's ability to access new DRM-protected content be revoked. Revocation may also prevent renewal of such DRM-protected content already in your device. Revocation of such DRM software does not affect the use of content protected with other types of DRM or the use of non-DRM-protected content.

#### Use licences

Digital rights management (DRM) protected content comes with an associated activation key that defines your rights to use the content.

If your device has OMA DRM-protected content, to back up both the licence and the content, use the backup feature of Nokia Ovi Suite.

Other transfer methods may not transfer the licence which need to be restored with the content for you to be able to continue the use of OMA DRM-protected content after the device memory is formatted. You may also need to restore the licence in case the files on your device get corrupted.

Some activation keys may be connected to a specific SIM card, and the protected content can be accessed only if the SIM card is inserted in the device.

Some media files, such as images, music, or video clips, are protected by digital usage rights. The licences for such files may allow or restrict their usage. For example, with some licences you may listen to a song only a limited number of times. During one playback session you may rewind, fast-forward, or pause the song, but once you stop it, you have used one of the instances allowed.

To view your licences by type, select **Valid licences**, **Invalid licences**, or **Not in use**.

To view the key details, scroll to a licence, and select **Options > Licence details**.

The following details are displayed for each media file:

**Status** — Shows if the licence is valid, invalid, or expired.

**Content sending** — **Allowed** indicates that you can send the file to another device.

To activate a key, in the licences main view, select **Invalid licences > Options > Get new licence**. Establish a network connection at the prompt, and you are directed to a website where you can purchase rights to the media.

To remove file rights, go to the desired file, and select **Options > Delete**. If there are several rights related to the same media file, all the rights are deleted.

The group key view displays all of the files related to a group right. If you have downloaded multiple media files with the same rights, they are all displayed in this view. You can open the group view from either the valid keys or invalid keys tabs. To access these files, open the group rights folder.

### Web browser

The XHTML browser in this device supports the Unicode encoding format.

If the web page is unreadable or not supported and garbage code is found while browsing, you can try to press , and select **Web > Options > Settings > Page > Default encoding**, and select a corresponding encoding.

To browse the web, you need to have an internet access point configured in your device.

### Browse the web

With the Browser application you can browse web pages.

Select  > **Web**.

**Shortcut:** To start the browser, press and hold **0** in the home screen.

### Go to a web page

In the bookmarks view, select a bookmark, or start entering a web address (the  field opens automatically), and select **Go to**.

Some web pages may contain material, such as video clips, that requires a large amount of memory to view. If your device runs out of memory while loading such a web page, insert a memory card. Otherwise, the video clips are not displayed.

### Disable graphics to save memory and speed up downloading

Select **Options > Settings > Page > Load content > Text only**.



**Refresh the content of the web page**

Select **Options** > **Web page options** > **Reload**.

**View snapshots of web pages you have visited**

Select **Back**. A list of pages you have visited during the current browsing session opens. This option is available if **History list** is activated in the browser settings.

**Block or allow the automatic opening of multiple windows**

Select **Options** > **Web page options** > **Block pop-ups** or **Allow pop-ups**.

**View the shortcut keys**

Select **Options** > **Keypad shortcuts**. To edit the shortcut keys, select **Edit**.

**Zoom in and out on a web page**

To zoom in, press \*. To zoom out, press #.

**Tip:** To send the browser to the background without exiting the application or closing the connection, press the end key once.

**Web feeds and blogs**

With web feeds, you can easily follow news headlines and your favourite blogs.

Select  > **Web**.

Web feeds are XML files on web pages. They are used to share, for example, the latest news headlines or blogs. It is common to find web feeds on web, blog, and wiki pages.

The browser application automatically detects if a web page contains web feeds.

### **Subscribe to a web feed when a feed is available on the page**

Select **Options** > **Subscribe to web feeds**.

### **Update a web feed**

In the Web feeds view, select a feed and **Options** > **Web feed options** > **Refresh**.

### **Set automatic update for all web feeds**

In the Web feeds view, select **Options** > **Edit** > **Edit**. This option is not available if one or more feeds are marked.

### **Empty the cache**

Emptying the cache memory helps you keep your data secure. The information or services you have accessed are stored in the cache memory of the device. If you have accessed or tried to access confidential information requiring passwords, empty the cache after each browsing session.

Select **Options** > **Clear privacy data** > **Cache**.

### **End the connection**

#### **End the connection and close the Browser application**

Select **Options** > **Exit**.

#### **Delete cookies**

Select **Options** > **Clear privacy data** > **Cookies**. Cookies contain information collected about your visits to web pages.

## Connection security

With a secure connection and security certificates, you can safely browse the internet.

If the security indicator () is displayed during a connection, the data transmission between the device and the internet gateway or server is encrypted.

The security icon does not indicate that the data transmission between the gateway and the content server (where the data is stored) is secure. The service provider secures the data transmission between the gateway and the content server.

Security certificates may be required for some services, such as banking services. You are notified if the identity of the server is not authentic or if you do not have the correct security certificate in your device. For more information, contact your service provider.

**Important:** Even if the use of certificates makes the risks involved in remote connections and software installation considerably smaller, they must be used correctly in order to benefit from increased security. The existence of a certificate does not offer any protection by itself; the certificate manager must contain correct, authentic, or trusted certificates for increased security to be available. Certificates have a restricted lifetime. If "Expired certificate" or "Certificate not valid yet" is shown, even if the certificate should be valid, check that the current date and time in your device are correct.

Before changing any certificate settings, you must make sure that you really trust the owner of the certificate and that the certificate really belongs to the listed owner.

## My favorites

You can manage images, video clips, and music files, or enter **Magic Box**.

Select  > My Favorites.

## Monternet

Monternet allows you to establish a connection to operator's WAP gateway and access Monternet online contents with your device browser, using general packet radio service (GPRS).

For information on the pricing of GPRS and Monternet, contact your service provider.

To access Monternet, select  > **Monternet**.

### China Mobile services

China Mobile services provide you high-quality customer support and enriched online contents, such as music, games, weather forecast, and other services.

The services may use general packet radio service (GPRS). For information on the pricing of GPRS and China Mobile services, contact your network service provider.

To access China Mobile services, select  > **ChinaMobileIn**.

To contact customer support, select  > **ChinaMobileIn** > **Customer Services**.

The online contents and services may vary depending on your device and your network service provider.

## Service shortcut

To quickly access your most frequently used services, in the standby mode, select **Service**.

### **Add a service to the shortcut list**

Select **Edit > Options > Add > Application**, or **Bookmark**, the desired items, and **OK**.

### **Delete a service from the shortcut list**

Select **Edit**, the items to delete and **Options > Delete from list**.

### Connections

At Nokia, we understand how important it is that your mobile phone or device operates reliably and that your personal content is saved safely.

Any information from an unknown or unreliable source, via Bluetooth connectivity, multimedia message, or cable, may harm your PC, mobile phone, or device. You may protect your mobile phone or device from damage and keep it secured by following simple measures:

- Always keep Bluetooth connectivity closed unless you want your phone or device to be visible to others.
- Always be alert when receiving information from an unknown or untrustworthy source.
- Do not download or install any applications that may include software harmful to your phone or device.
- Always download and install applications or content from trusted or well-known sources, such as Nokia Software Market, where good protection is provided against viruses and other harmful software.

Your device offers several options to connect to the internet or to another compatible device or PC.

#### Bluetooth connectivity

##### About Bluetooth

Bluetooth technology in your device enables wireless connections between electronic devices within a range of 10 metres (33 feet). A Bluetooth connection can be used to send images, videos, text, business cards, calendar notes, or to connect wirelessly to devices that use Bluetooth technology.



Since devices using Bluetooth technology communicate using radio waves, your device and the other devices do not need to be in direct line-of-sight. The two devices only need to be within a maximum of 10 metres of each other, although the connection can be subject to interference from obstructions such as walls or other electronic devices.

Several Bluetooth connections can be active at a time. For example, if your device is connected to a headset, you can also transfer files to another compatible device at the same time.

This device is compliant with Bluetooth Specification 2.0 + EDR supporting the following profiles: Advanced Audio Distribution, Audio/Video Remote Control, Basic Imaging, Dial-up Networking, File Transfer, Generic Audio/Video Distribution, Generic Access, Generic Object Exchange, Handsfree, (Human Interface Device) Headset, Object Push, Phone Book Access, Serial Port, and Synch. To ensure interoperability between other devices supporting Bluetooth technology, use Nokia approved accessories for this model. Check with the manufacturers of other devices to determine their compatibility with this device.

Features using Bluetooth technology increase the demand on battery power and reduce the battery life.

### **Bluetooth settings**

Select  > Tools > Bluetooth.

When you open the application for the first time, you are asked to define a name for your device. You can change the name later.

To make a wireless Bluetooth connection to another compatible device, first activate Bluetooth, and then establish the connection.

Select from the following:

**Bluetooth** — Activate Bluetooth.

**My phone's visibility** — To allow your device to be visible to other Bluetooth devices, select **Shown to all**. To set a length of time after which the visibility is set from shown to hidden, select **Define period**. To hide your device from other devices, select **Hidden**.

**My phone's name** — Edit the name of your device. The name is shown to other Bluetooth devices.

### Security tips

Select  > **Tools** > **Bluetooth**.

When you are not using Bluetooth connectivity, to control who can find your device and connect to it, select **Bluetooth** > **Off** or **My phone's visibility** > **Hidden**.

Operating the device in hidden mode is a safer way to avoid malicious software. Do not accept Bluetooth connectivity from sources you do not trust. Alternatively, switch off the Bluetooth function. This does not affect other functions of the device.

Do not pair with or accept connection requests from an unknown device. This protects your device from harmful content.

### Send data using Bluetooth connectivity

Several Bluetooth connections can be active at a time. For example, if you are connected to a compatible headset, you can also transfer files to another compatible device at the same time.

- 1 Open the application where the item you want to send is stored.
- 2 Select the item and **Options** > **Send** > **Via Bluetooth**.  
To interrupt the search, select **Stop**.

- 3 Select the device with which you want to connect.
- 4 If the other device requires pairing before data can be transmitted, a tone sounds, and you are asked to enter a passcode.  
When the connection is established, **Sending data** is displayed.

## Pair devices

To pair with compatible devices and view your paired devices, in the main view of Bluetooth connectivity, scroll right.

Before pairing, create your own passcode (1 to 16 digits), and agree with the owner of the other device to use the same code. Devices that do not have a user interface have a factory-set passcode. The passcode is used only once.

- 1 To pair with a device, select **Options** > **New paired device**. Devices that are within range are displayed.
- 2 Select the device, and enter the passcode. The same passcode must be entered on the other device as well.
- 3 Some audio enhancements connect automatically to your device after pairing. Otherwise, scroll to the enhancement, and select **Options** > **Connect to audio device**.

Paired devices are indicated by  in the device search.

To set a device as authorised or unauthorised, scroll to the device, and select from the following options:

**Set as authorised** — Connections between your device and the authorised device can be made without your knowledge. No separate acceptance or authorisation is needed. Use this status for your own devices, such as your compatible headset or

PC or devices that belong to someone you trust.  indicates authorised devices in the paired devices view.

**Set as unauthorised** — Connection requests from this device must be accepted separately every time.

To cancel a pairing, scroll to the device, and select **Options > Delete**.

If you want to cancel all pairings, select **Options > Delete all**.

## Remote configuration

Select  > **Tools** > **Utilities** > **Device mgr..**

With Device manager, you can manage settings, data, and software on your device remotely.

You can connect to a server, and receive configuration settings for your device. You may receive server profiles and different configuration settings from your service providers or company information management department. Configuration settings may include connection and other settings used by different applications in your device. The available options may vary.

The remote configuration connection is usually started by the server when the device settings need to be updated.

To create a new server profile, select **Options** > **Server profiles** > **Options** > **New server profile**.

You may receive these settings from your service provider in a configuration message. If not, define the following:

**Server name** — Enter a name for the configuration server.

**Server ID** — Enter the unique ID to identify the configuration server.

**Server password** — Enter a password to identify your device to the server.

**Access point** — Select the access point to use for the connection, or create a new access point. You can also choose to be asked for the access point every time you start a connection. This setting is available only if you have selected **Internet** as the bearer type.

**Host address** — Enter the web address of the configuration server.

**Port** — Enter the port number of the server.

**User name and Password** — Enter your user ID and password for the configuration server.

**Allow configuration** — Select **Yes** to allow the server to initiate a configuration session.

**Network authentication** — Select whether to use HTTP authentication.

**Network user name and Network password** — Enter your user ID and password for HTTP authentication. This setting is available only if you have selected **Network authentication** to be used.

To connect to the server and receive configuration settings for your device, select **Options > Start configuration**.

To view the configuration log of the selected profile, select **Options > View log**.

**Warning:**

If you install a software update, you cannot use the device, until the installation is completed and the device is restarted. Be sure to back up data before accepting installation of an update.

## Write text

The input methods provided in the device may vary according to different sales markets.

### Input method indicators

The input method indicator is shown in the navigating field or on the upper right corner of the inputting frame. Please note that not all input methods are available under all circumstances. Press \* to view other available input methods.

### Default input method

Please notice that aiming for different requirements for various characters' input positions, the device has preset the relevant default input methods and usable input methods. For the input positions where the default input method is Pinyin, you could change into other input method as default when necessary.

Select  > **Settings and General** > **Personalisation** > **Language** > **Default input**. This selection is only visible when you select a Chinese language in the writing language setting.

### Switch input methods

Press \* to select desired input method from the selection list (the currently the active input method is not listed).

Press # repeatedly to switch among different character modes.

### Pinyin input method

Pinyin symbols are mapped to number keys. You can press the corresponding number key once regardless of the intended symbol's position on the key. The device will make logical combinations and display all feasible matches to those Pinyin symbols you just pressed.

### Use Pinyin input method

- 1 Input Pinyin symbols and tones: Press number key once for each Pinyin symbol you want to input (use "v" for "ü"); When you start to input, Chinese input window will be shown on the screen: It shows all the Pinyin letter combinations matching to the keys you pressed; and the candidate Chinese characters corresponding to the highlighted Pinyin. The Pinyin letters displayed on the screen are changing frequently during your inputting process. Ignore these changes before you finish inputting the last Pinyin letter.

After inputting all Pinyin letters, you can also press \* to input tones. Press \* once to input the first tone, twice to input the second tone, and so on. Press \* five times to input the neutral tone.

**Tip:** Press the right selection key to close the Chinese input window.

- 2 Select desired Pinyin: When several Pinyin letters are listed on the screen, you could scroll in the relevant direction to highlight your desired Pinyin. Press the scroll key to choose the highlighted Pinyin. Thus the selected Pinyin can be displayed in the Pinyin window, and the other Pinyin will disappear, and the candidate list corresponding to this Pinyin can be activated (numbering will be shown on each candidate, and the first candidate is highlighted).
- 3 View candidate list to find out desired Chinese character: when the candidate Chinese characters exceed one line display, there will be up and down arrows showing at the right end of the candidate list. If you could not find a desired character in the current list, you could scroll up or down to view the previous line or the next line.



- 4 Input Chinese character: You can press the scroll key or number key to input a candidate.
  - Press scroll key to input: Scroll to left or right to highlight the desired candidate, and then press to input this Chinese character.
  - Press number key to input: Directly press the number key matching to the numbering of the candidate character.

While your input candidate is inserted in the text input window, the Chinese input window will be closed and the predictive list will be shown at the same time.

- 5 Input predictive character: If the current line of predictive character list does not show your desired character, you could scroll down to view the next line of predictive character list. Find your desired character, if it locates in the first highlighted position in the list, you could directly press the scroll key to input it; otherwise, you could first scroll right to activate the predictive character list (the characters in the list will have numbering, meanwhile, the second character in the list will be highlighted), then you could either press the number key matching to the predictive character numbering to input it, or scroll in the relevant direction to find and highlight your desired predictive character and then press the scroll key to input it.

When you do not need the predictive list or you could not find your desired Chinese character in the predictive list, while the predictive list is not activated, you could directly input the Pinyin for next Chinese character. While the predictive list is already activated, you have to press the right selection key to close the predictive list first and then continue to input the Pinyin for the next Chinese character.

#### **Pinyin input example: To input characters for "Pinyin"**

- 1 Enter into the text editing window for writing a text message or any other possible position for inputting Chinese character, and switch to Pinyin input mode.

## 74 Write text

---

- 2 Input the Pinyin letter pin for "pin": press **7, 4, 6** in sequence, and finally input \* once for the 1st tone.
- 3 Scroll right to highlight pin- and then press the scroll key to activate the candidate list.
- 4 The character for "pin" will be shown in the candidate list. If this character locates in the first highlighted position of the candidate list, you could directly press the scroll key to input it, otherwise, you should first scroll right to highlight this character and then press the scroll key to input it.
- 5 After you input the character for "pin", the predictive list will be shown, and the character for "yin" is shown in the predictive list. You could use the same method described in item 4 to input this character.

### Stroke input method

The strokes are classified according to the following table.



**Tip:** Press the right selection key to close the Chinese input window.

- 2 Input Chinese character: The first character in the candidate list is highlighted, press the scroll key to input this character. If your desired character does not locate in the first position of the candidate list, you should scroll right to activate the candidate list (the candidates in the list will have numbering on it, and the second character will be highlighted), then you could either press the number key matching to the character numbering to input it, or scroll in the relevant direction to find and highlight your desired character and then press the scroll key to input it.

While your input candidate is inserted in the text input window, the Chinese input window will be closed and the predictive list will be shown at the same time. When the candidate list exceeds one line, there will be up and down arrows showing at the right end of the candidate list, you could scroll up or down to view the previous or next line of the candidate list, while the candidate list is not activated, so you could still revise your input strokes during viewing.

- 3 Input predictive character: If the current line of the predictive list does not show your desired character, scroll down to view the next line of the predictive list. Find your desired character, if it locates in the 1st highlighted position of the predictive list, you could directly press the scroll key to input it, otherwise, you have to scroll right to activate the predictive list (the characters in the list will have numbering, and the second character will be highlighted), then you could either press the number key matching to the predictive character numbering to input it, or scroll to your desired predictive character and then press the scroll key to input it.

When you do not need the predictive list or you could not find your desired Chinese character in the predictive list, while the predictive list is not activated, you could directly input the strokes for next Chinese character. While the predictive list is already activated, you have to press the right selection key to close the predictive list first and then continue to input the strokes for next Chinese character.

**Stroke input example: To input characters for "birthday"**

- 1 Enter into the text editing window for writing text message or any other possible position for inputting Chinese character, and switch to stroke input mode.
- 2 Input the strokes for "birth": Press **3, 1, 1** in sequence.
- 3 The character for "birth" will be shown in the candidate list. If this character locates in the first highlighted position of the list, you could directly press the scroll key to input it, otherwise, you have to first scroll right to find and highlight this character and then press the scroll key to input it.
- 4 After inputting the character for "birth", the predictive list will be shown. The character "day" is shown in the predictive list, and you could use the same method described in item 3 to input it.

**Insert special characters and punctuation marks in Chinese input mode**

- 1 First close the Chinese input window, and then press and hold **\*** to open a list of special characters and punctuation marks.
- 2 Scroll in the relevant direction (up, down, left or right) to reach and highlight your needed special character or punctuation mark, and press the scroll key to enter it.

**Traditional text input**

Press a number key (**1–9**) repeatedly until the desired character appears. There are more characters available for a number key than are printed on the key.

If the next letter is located on the same key as the present one, wait until the cursor appears (or scroll right to end the time-out period), and enter the letter.

To insert a space, press **0**. To move the cursor to the next line, press **0** three times.

### Predictive text input

With predictive input, you can enter any letter with a single keypress. Predictive text input is based on a built-in dictionary to which you can add new words.

- 1 To turn predictive text input on or off in the general settings, select  > **Settings** and **General** > **Personalisation** > **Language** > **Predictive text**.
- 2 To write the desired word, press the keys **2–9**. Press each key only once for one letter. For example, to write "Nokia" when the English dictionary is selected, press **6** for N, **6** for o, **5** for k, **4** for i, and **2** for a.

The word suggestion changes after each keypress.

- 3 When you finish writing the word correctly, scroll right to confirm it, or press **0** to add a space.

If the word is not correct, press **\*** repeatedly to view the matching words the dictionary has found one by one.

If the **?** character is shown after the word, the word is not in the dictionary. To add a word to the dictionary, select **Spell**, enter the word using traditional text input, and select **OK**. The word is added to the dictionary. When the dictionary is full, a new word replaces the oldest added word.

- 4 Start writing the next word.

### Tips on text input

To insert a number in the letter mode, press and hold the desired number key.

To switch between the different character modes, press **#**.

To delete a character, press **C**. To delete more than one character, press and hold **C**.

The most common punctuation marks are available under **1**. To scroll them through one by one, if you use traditional text input, press **1** repeatedly. If you use predictive text input, press **1**, and then **\*** repeatedly.

To open a list of special characters, press and hold **\***.

**Tip:** To select several special characters from the special characters list, press **5** after each highlighted character.

### Messaging

Only devices that have compatible features can receive and display multimedia messages. The appearance of a message may vary depending on the receiving device.

**Important:** Exercise caution when opening messages. Messages may contain malicious software or otherwise be harmful to your device or PC.

### Messaging main view

Select  > **Messaging** (network service).

To create a new message, select **New message**.

**Tip:** To avoid rewriting messages that you send often, use texts in the Templates folder in My folders. You can also create and save your own templates.

Messaging contains the following folders:

**Inbox** — Received messages, except e-mail and cell broadcast messages, are stored here.

**My folders** — Organise your messages into folders.

**New mailbox** — Connect to your remote mailbox to retrieve your new e-mail messages, or view your previously retrieved e-mail messages offline.

**Drafts** — Draft messages that have not been sent are stored here.

**Sent** — The last messages that have been sent, excluding messages sent using Bluetooth connectivity, are stored here. You can change the number of messages to save in this folder.



**Outbox** — Messages waiting to be sent are temporarily stored in the Outbox folder, for example, when your device is outside network coverage.

**Reports** — You can request the network to send you a delivery report of the text messages and multimedia messages you have sent (network service).

### Write and send messages

Select  > **Messaging**.

Before you can create a multimedia or e-mail message, you must have the correct connection settings in place.

The wireless network may limit the size of MMS messages. If the inserted picture exceeds this limit, the device may make it smaller so that it can be sent by MMS.

- 1 Select **New message** > **Message** to send a text or multimedia message (MMS), **Audio message** to send a message that includes one sound clip, or **E-mail** to send an e-mail message.
- 2 In the To field, press the scroll key to select recipients or groups from the contacts list, or enter the recipient's phone number or e-mail address. To add a semicolon (;) that separates the recipients, press and hold \*.
- 3 In the Subject field, enter the subject of the e-mail. To change the fields that are visible, select **Options** > **Message header fields**.
- 4 In the message field, write the message.
- 5 To add a media object to a multimedia message, select **Options** > **Insert content**, the object type or source, and the desired object. To add a business card, slide, note, or some other file to the message, select **Options** > **Insert content** > **Insert other**.
- 6 To capture an image or record a video or sound clip for a multimedia message, select **Options** > **Insert content** > **Insert image** > **New**, **Insert video clip** > **New**, or **Insert sound clip** > **New**.

7 To send the message, select **Options** > **Send**, or press the call key.

**Note:** The message sent icon or text on your device screen does not indicate that the message is received at the intended destination.

Your device supports text messages beyond the limit for a single message. Longer messages are sent as two or more messages. Your service provider may charge accordingly. Characters with accents, other marks, or some language options take more space, and limit the number of characters that can be sent in a single message.

You may not be able to send video clips that are saved in the MP4 file format or that exceed the size limit of the wireless network in a multimedia message.

### E-mail

Information about e-mail set-up in this product

Your device supports easy, network-assisted e-mail set-up. Use the E-mail wizard to set up personal or corporate e-mail accounts.

During the e-mail activation process, your e-mail address, user name, and password, along with technical information, such as your device ID, may be sent to Nokia. Nokia will not process or store any personal, identifiable information after the activation, without your consent. For more information, see the Nokia Privacy Policy at [www.nokia.com](http://www.nokia.com).

### Mail for Exchange

With Mail for Exchange, you can receive your work e-mail to your device. You can read and reply to your e-mails, view and edit compatible attachments, view calendar information, receive and reply to meeting requests, schedule meetings, and view, add, and edit contact information.

Use of the Mail for Exchange is limited to over-the-air synchronisation of PIM information between the Nokia device and the authorised Microsoft Exchange server.

Mail for Exchange can be set up only if your company has Microsoft Exchange Server. In addition, your company's IT administrator must have activated Mail for Exchange for your account.

Before starting to set up Mail for Exchange, ensure that you have the following:

- A corporate e-mail ID
- Your office network user name
- Your office network password
- Your network domain name (contact your company's IT department)
- Your Mail for Exchange server name (contact your company's IT department)

Depending on your company's Mail for Exchange server configuration, you may need to enter other information in addition to those listed. If you do not know the correct information, contact your company's IT department.

With Mail for Exchange, the use of the lock code may be mandatory. The default lock code of your device is 12345, but your company's IT administrator may have set a different one for you to use.

To set up Mail for Exchange, use the Settings wizard. Select  > **Tools** > **Utilities** > **Sett. wizard**.

### Make calls

For call durations or amount of data transmission, please contact your network operator. The data provided by your device is for reference only.

### Voice calls

- 1 In the standby mode, enter the phone number, including the area code. To remove a number, press **C**.  
For international calls, press \* twice for the + character (which replaces the international access code), and enter the country code, area code (omit the leading zero if necessary), and phone number.
- 2 To make the call, press the call key.
- 3 To end the call (or to cancel the call attempt), press the end key.  
Pressing the end key always ends a call, even if another application is active.

To make a call from Contacts, select  > **Apps.** > **Contacts.**

Scroll to the desired name, or enter the first letters of the name to the search field.

To call the contact, press the call key. If you have saved several numbers for a contact, select the desired number from the list, and press the call key.

### Make a video call



When you make a video call (network service), you can see a real-time, two-way video between you and the recipient of the call. The live video image, or video image recorded by the camera in your device is shown to the video call recipient.

To be able to make a video call, you must be in the coverage of the TD-SCDMA network. For availability and subscription to video call services, contact your network service provider.

A video call can only be made between two parties. The video call can be made to a compatible mobile device or an ISDN client. Video calls cannot be made while another voice, video, or data call is active.

## Icons

---

 You have denied video sending from your device. To send a still image instead, select  > **Settings and Phone** > **Call** > **Image in video call**.

Even if you denied video sending during a video call, the call is still charged as a video call. Check the pricing with your service provider.

- 1 To start a video call, enter the phone number in the standby mode, or select **Contacts** and a contact.
- 2 Select **Options** > **Call** > **Video call**.
- 3 To end the video call, press the end key.

## Video call in the standby mode

In the standby mode, select **Video Call**.

## Add a contact to video call contacts

Select **Add** and the desired contacts.

## Make a video call

Scroll to the desired contact, and select **Call**.

## Add or change the image of a contact

Scroll to the desired contact, and select **Options** > **Add image** or **Change image**.

**Delete a video call contact**

Scroll to the desired contact, and select **Options** > **Delete from this app**.

## Phonebook manager

Phonebook manager is a service provided by China Mobile. You can back up or restore your phonebook entries online. For the availability of this service, pricing, and detailed instructions, contact your service provider.

Phonebook manager uses general packet radio service (GPRS). For information on the pricing of GPRS, contact your service provider.

To subscribe to or unsubscribe from the phonebook manager service, or to back up, restore, and search phonebook entries online, select  > **ChinaMobileIn** > **Phonebook Manager** > **Options** > **Enter**.

## Green tips



Here are tips on how you can contribute to protecting the environment.

### Save energy

When you have fully charged the battery and disconnected the charger from the device, unplug the charger from the wall outlet.

You do not need to charge your battery so often if you do the following:

- Close and disable applications, services, and connections when not in use.
- Decrease the brightness of the screen.
- Set the device to enter the power saver mode after the minimum period of inactivity, if available in your device.
- Disable unnecessary sounds, such as keypad and ringing tones.

### Recycle

Most of the materials in a Nokia phone are recyclable. Check how to recycle your Nokia products at [www.nokia.com.cn/werecycle](http://www.nokia.com.cn/werecycle), or with a mobile device, [www.nokia.mobi/werecycle](http://www.nokia.mobi/werecycle).

Recycle packaging and user guides at your local recycling scheme.



### **Save paper**

This user guide helps you get started with your device. For more detailed instructions, open the in-device help (in most applications, select **Options > Help**). For further support, see [www.nokia.com/support](http://www.nokia.com/support).

### **Learn more**

For more information on the environmental attributes of your device, see [www.nokia.com/ecodeclaration](http://www.nokia.com/ecodeclaration).

## e100

e100 is a one-stop self-service provided by China Mobile, including the following service channels:

- **Online service centre:** You can subscribe to China Mobile services, check your account balance or user credit, make online payments, and access online services. For more information, go to [www.chinamobile.com](http://www.chinamobile.com).
- **10086 hotline:** You can call 10086 to get information on services, promotions, your account balance, service subscriptions, and Monternet.
- **Message service centre:** You can send a text message containing **10086** to the service number 10086 to get information on promotions, account balance, and service subscriptions.
- **WAP service centre:** To subscribe or get information on services, go to the Monternet homepage, and select **WAP service centre**.
- **Self-service machine:** You can pay your phone bill, print call logs, subscribe to services, or get information on the services.

## Product and safety information

### Accessories

#### Nokia original accessories

### Warning:

Use only batteries, chargers, and accessories approved by Nokia for use with this particular model. The use of any other types may invalidate any approval or warranty, and may be dangerous. In particular, use of unapproved chargers or batteries may present a risk of fire, explosion, leakage, or other hazard.

For availability of approved accessories, check with your dealer.



An extensive range of accessories is available for your device. For more details, see [www.nokia.com.cn](http://www.nokia.com.cn).

All accessories for Nokia devices are supplied in an elegant sales package. An accessory bought without a separate package is not an original Nokia accessory.

**How to buy Nokia original accessories:**

- 1 Go to an authorised retailer for Nokia original accessories.

For information on the nearest authorised retailer for Nokia accessories, check with a Nokia original accessory distributor.

\* When you are buying an accessory, always ask the dealer to issue a separate invoice listing the price and model number, which is helpful in safeguarding your own rights.

- 2 Visit a Nokia online shop at [www.shop.nokia.com.cn](http://www.shop.nokia.com.cn).

**Practical rules about accessories**

- Keep all accessories out of the reach of small children.
- When you disconnect the power cord of any accessory, grasp and pull the plug, not the cord.
- Check regularly that accessories installed in a vehicle are mounted and are operating properly.
- Installation of any complex car accessories must be made by qualified personnel only.

**Why use original accessories?**

As key components of your handset, batteries and chargers play a critical role in making sure the handset is operating properly and safely. As shown by our long-term customer surveys and after-sales services, handsets fail in many cases by using unapproved accessories, especially unapproved batteries and chargers.

**Dangers of using unapproved batteries and chargers**

- Short lifetime, with charging and discharging times noticeably less than those of original batteries.

- Consequent much shorter lifetime of the handset, unstable power supply that prevents the handset circuit from functioning properly, which causes lasting damages.
- Poor performance and reliability of the handset, undermined voice quality and frequent breakdown.
- Potential burning or explosion that endangers consumer's safety.

### **Benefits of using Nokia original accessories**

- Adequate safety.
- High quality after-sales maintenance and services that are available to original accessories only.
- Nokia warranty does not apply to handset failures attributable to the use of non-original Nokia accessories.

**False:** Handset battery is a simple product that combines a group of linked cells within a single package.

**True:** A number of high-tech designs and high quality raw materials are necessary for a handset battery to provide stable and lasting performance. A battery manufactured in a slipshod way differs from an original product on process, design, and raw material considerably, hence dramatic difference in performance and safety.

**False:** All accessories with the Nokia trademark are original ones.

**True:** Nokia original accessories are supplied in an elegant sales package (complying with national package regulations), and each battery carries a hologram label. It is recommended that consumers are aware of counterfeit Nokia accessories on the market. In particular, some dealers might remove the original battery from the supplied handset, which violates our distribution policies and infringes on consumer's rights.

**False:** Despite low quality, counterfeit battery is much cheaper and is worthwhile even if it requires frequent replacement.

**True:** Unapproved batteries and chargers are not only of short lifetime and poor performance, but will noticeably undermine the handset's performance and reduce its lifetime. It is also deprived of comprehensive after-sales maintenance and repair. Most important, unapproved batteries and chargers pose safety threats to consumers. Losses in these regards far exceed the savings on price. In fact, with inferior raw materials and irregular designs, some counterfeit batteries cost less than 1/10 of original products.

### **Battery**

Type: BL-5F

Talk time:

Up to 460 minutes (TD-SCDMA)

Up to 280 minutes (GSM)

Standby time:

Up to 190 hours (TD-SCDMA)

Up to 165 hours (GSM)

**Important:** Battery talk and stand-by times are estimates and only possible under optimal network conditions. Actual battery talk and standby times depend on SIM cards, features used, battery age and condition, temperatures to which battery is exposed, network conditions, and many other factors, and may be significantly shorter than those specified above. Ringing tones, hands free call handling, use in digital mode, and other features will also consume the battery, and the amount of time a device is used for calls will affect its stand-by time. Likewise, the amount of time that the device is turned on and in the standby mode will affect its talk time.

## **Battery**

### **Battery and charger information**

Your device is powered by a rechargeable battery. The battery intended for use with this device is BL-5F. Nokia may make additional battery models available for this device. This device is intended for use when supplied with power from the following chargers: AC-8. The exact charger model number may vary depending on the type of plug. The plug variant is identified by one of the following: E, EB, X, AR, U, A, C, K, or UB. For example, the model numbers for the charger can be, among others, AC-8C, AC-8U, AC-8X, etc. The charger model offered to China mainland is AC-8C.

The battery can be charged and discharged hundreds of times, but it will eventually wear out. When the talk and standby times are noticeably shorter than normal, replace the battery. Use only Nokia approved batteries, and recharge your battery only with Nokia approved chargers designated for this device.

If a battery is being used for the first time or if the battery has not been used for a prolonged period, it may be necessary to connect the charger, then disconnect and reconnect it to begin charging the battery. If the battery is completely discharged, it may take several minutes before the charging indicator appears on the display or before any calls can be made.

Safe removal. Always switch the device off and disconnect the charger before removing the battery.

Proper charging. Unplug the charger from the electrical plug and the device when not in use. Do not leave a fully charged battery connected to a charger, since overcharging may shorten its lifetime. If left unused, a fully charged battery will lose its charge over time.

Avoid extreme temperatures. Always try to keep the battery between 15°C and 25°C (59°F and 77°F). Extreme temperatures reduce the capacity and lifetime of the battery. A device with a hot or cold battery may not work temporarily. Battery performance is particularly limited in temperatures well below freezing.

Do not short-circuit. Accidental short-circuiting can occur when a metallic object such as a coin, clip, or pen causes direct connection of the positive (+) and negative (-) terminals of the battery. (These look like metal strips on the battery.) This might happen, for example, when you carry a spare battery in your pocket or purse. Short-circuiting the terminals may damage the battery or the connecting object.

Disposal. Do not dispose of batteries in a fire as they may explode. Dispose of batteries according to local regulations. Please recycle when possible. Do not dispose as household waste.

Leak. Do not dismantle, cut, open, crush, bend, puncture, or shred cells or batteries. In the event of a battery leak, prevent battery liquid contact with skin or eyes. If this happens, flush the affected areas immediately with water, or seek medical help.

Damage. Do not modify, remanufacture, attempt to insert foreign objects into the battery, or immerse or expose it to water or other liquids. Batteries may explode if damaged.

Correct use. Use the battery only for its intended purpose. Improper battery use may result in a fire, explosion, or other hazard. If the device or battery is dropped, especially on a hard surface, and you believe the battery has been damaged, take it to a service centre for inspection before continuing to use it. Never use any charger or battery that is damaged. Keep your battery out of the reach of small children.

### **Nokia battery authentication guidelines**

Always use original Nokia batteries for your safety. To check that you are getting an original Nokia battery, purchase it from a Nokia authorised service centre or dealer, and inspect the hologram label using the following steps:

### Authenticate hologram

- 1 When you look at the hologram on the label, you should see the Nokia connecting hands symbol from one angle and the Nokia Original Enhancements logo when looking from another angle.



- 2 When you angle the hologram left, right, down and up, you should see 1, 2, 3 and 4 dots on each side respectively.



Successful completion of the steps is not a total assurance of the authenticity of the battery. If you cannot confirm authenticity or if you have any reason to believe that your Nokia battery with the hologram on the label is not an authentic Nokia battery, you should refrain from using it, and take it to the nearest Nokia authorised service centre or dealer for assistance.

To find out more about original Nokia batteries, see [www.nokia.com/batterycheck](http://www.nokia.com/batterycheck).

### Taking care of your device

Your device is a product of superior design and craftsmanship and should be treated with care. The following suggestions will help you protect your warranty coverage.

## 96 Product and safety information

- Do not use or store the device in dusty, dirty areas. Its moving parts and electronic components can be damaged.
- Do not store the device in high or cold temperature. High temperatures can shorten the life of electronic devices, damage batteries, and warp or melt certain plastics. When the device warms to its normal temperature from a cold temperature, moisture can form inside the device and damage electronic circuit boards.
- Do not attempt to open the device other than as instructed in this guide.
- Do not drop, knock, or shake the device. Rough handling can break internal circuit boards and fine mechanics.
- Do not use harsh chemicals, cleaning solvents, or strong detergents to clean the device. Only use a soft, clean, dry cloth to clean the surface of the device.
- Do not paint the device. Paint can clog the moving parts and prevent proper operation.
- Use only the supplied or an approved replacement antenna. Unauthorised antennas, modifications, or attachments could damage the device and may violate regulations governing radio devices.
- Use chargers indoors.
- Backup all data you want to keep, such as contacts and calendar notes.
- To reset the device from time to time for optimum performance, power off the device and remove the battery.

These suggestions apply equally to your device, battery, charger, or any accessory.

### Recycle

Always return your used electronic products, batteries, and packaging materials to dedicated collection points. This way you help prevent uncontrolled waste disposal and promote the recycling of materials. Check product environmental information and how to recycle your Nokia products at [www.nokia.com.cn/werecycle](http://www.nokia.com.cn/werecycle), or [nokia.mobi/werecycle](http://nokia.mobi/werecycle).

### China ROHS Table



Toxic or hazardous Substances and Elements	Part name		
	Phone	Battery	Accessories
Lead (Pb)	X	X	X
Mercury (Hg)	0	0	0



Cadmium (Cd)	0	0	0
Hexavalent Chromium (Cr6+)	0	0	0
Polybrominated biphenyls(PBB)	0	0	0
Polybrominated diphenyl ethers (PBDE)	0	0	0

0: Indicates that this toxic or hazardous substance contained in all of the homogeneous materials for this part is below the limit requirement in SJ/T 11363-2006.

X: Indicates that this toxic or hazardous substance contained in at least one of the homogeneous materials used for this part is above the limit requirement in SJ/T 11363-2006.

Notes: The reason for marking "X" is: there is currently no alternative technologies available.

#### **Additional safety information**

The surface of this device is nickel-free.

#### **Small children**

Your device and its accessories are not toys. They may contain small parts. Keep them out of the reach of small children.

#### **Operating environment**

This device meets RF exposure guidelines in the normal use position at the ear or at least 1.5 centimetres (5/8 inch) away from the body. Any carry case, belt clip, or holder for body-worn operation should not contain metal and should position the device the above-stated distance from your body.

To send data files or messages requires a quality connection to the network. Data files or messages may be delayed until such a connection is available. Follow the separation distance instructions until the transmission is completed.

Parts of the device are magnetic. Metallic materials may be attracted to the device. Do not place credit cards or other magnetic storage media near the device, because information stored on them may be erased.

#### **Medical devices**

Operation of radio transmitting equipment, including wireless phones, may interfere with the function of inadequately protected medical devices. Consult a physician or the manufacturer of the medical device to determine whether they are

adequately shielded from external RF energy. Switch off your device when regulations posted instruct you to do so. Hospitals or health care facilities may use equipment sensitive to external RF energy.

### **Implanted medical devices**

Manufacturers of medical devices recommend a minimum separation of 15.3 centimetres (6 inches) between a wireless device and an implanted medical device, such as a pacemaker or implanted cardioverter defibrillator, to avoid potential interference with the medical device. Persons who have such devices should:

- Always keep the wireless device more than 15.3 centimetres (6 inches) from the medical device.
- Not carry the wireless device in a breast pocket.
- Hold the wireless device to the ear opposite the medical device.
- Turn the wireless device off if there is any reason to suspect that interference is taking place.
- Follow the manufacturer directions for the implanted medical device.

If you have any questions about using your wireless device with an implanted medical device, consult your health care provider.

### **Hearing aids**

Some digital wireless devices may interfere with some hearing aids.

### **Vehicles**

RF signals may affect improperly installed or inadequately shielded electronic systems in motor vehicles such as electronic fuel injection, electronic antilock braking, electronic speed control, and air bag systems. For more information, check with the manufacturer of your vehicle or its equipment.

Only qualified personnel should service the device or install the device in a vehicle. Faulty installation or service may be dangerous and may invalidate your warranty. Check regularly that all wireless device equipment in your vehicle is mounted and operating properly. Do not store or carry flammable liquids, gases, or explosive materials in the same compartment as the device, its parts, or accessories. Remember that air bags inflate with great force. Do not place your device or accessories in the air bag deployment area.

Switch off your device before boarding an aircraft. The use of wireless teledevices in an aircraft may be dangerous to the operation of the aircraft and may be illegal.

### **Potentially explosive environments**

Switch off your device in any area with a potentially explosive atmosphere. Obey all posted instructions. Sparks in such areas could cause an explosion or fire resulting in bodily injury or death. Switch off the device at refuelling points such as near gas pumps at service stations. Observe restrictions in fuel depots, storage, and distribution areas; chemical plants;

or where blasting operations are in progress. Areas with a potentially explosive atmosphere are often, but not always, clearly marked. They include areas where you would be advised to turn off your vehicle engine, below deck on boats, chemical transfer or storage facilities and where the air contains chemicals or particles such as grain, dust, or metal powders. You should check with the manufacturers of vehicles using liquefied petroleum gas (such as propane or butane) to determine if this device can be safely used in their vicinity.

### Emergency calls

**Important:** This device operates using radio signals, wireless networks, landline networks, and user-programmed functions. If your device supports voice calls over the internet (internet calls), activate both the internet calls and the cellular phone. Connections in all conditions cannot be guaranteed. You should never rely solely on any wireless device for essential communications like medical emergencies.

To make an emergency call:

- 1 If the device is not on, switch it on. Check for adequate signal strength. Depending on your device, you may also need to complete the following:
  - Insert a SIM card if your device uses one.
  - Remove certain call restrictions you have activated in your device.
  - Change your profile from Offline or Flight profile to an active profile.
- 2 Press the end key as many times as needed to clear the display and ready the device for calls.
- 3 Enter the official emergency number for your present location. Emergency numbers vary by location.
- 4 Press the call key.

When making an emergency call, give all the necessary information as accurately as possible. Your wireless device may be the only means of communication at the scene of an accident. Do not end the call until given permission to do so.

### Certification information (SAR)

#### **This mobile device meets guidelines for exposure to radio waves.**

Your mobile device is a radio transmitter and receiver. It is designed not to exceed the limits for exposure to radio waves recommended by international guidelines. These guidelines were developed by the independent scientific organisation ICNIRP and include safety margins designed to assure the protection of all persons, regardless of age and health.

The exposure guidelines for mobile devices employ a unit of measurement known as the Specific Absorption Rate or SAR. The SAR limit stated in the ICNIRP guidelines is 2.0 watts/kilogram (W/kg) averaged over 10 grams of tissue. Tests for SAR are conducted using standard operating positions with the device transmitting at its highest certified power level in all tested frequency bands. The actual SAR level of an operating device can be below the maximum value because the device

## 100 Product and safety information

---

is designed to use only the power required to reach the network. That amount changes depending on a number of factors such as how close you are to a network base station.

The highest SAR value under the ICNIRP guidelines for use of the device at the ear is 0.73 W/kg.

Use of device accessories may result in different SAR values. SAR values may vary depending on national reporting and testing requirements and the network band. Additional SAR information may be provided under product information at [www.nokia.com](http://www.nokia.com).

### **MANUFACTURER'S LIMITED WARRANTY**

This Limited Warranty is in addition to, and does not affect your legal (statutory) rights under your applicable national laws relating to the sale of consumer products.

Nokia Corporation ("Nokia") provides this Limited Warranty to person who has purchased the Nokia product(s) included in the sales package ("Product").

Nokia warrants to you that during the warranty period Nokia or a Nokia authorised service company will in a commercially reasonable time remedy defects in materials, design and workmanship free of charge by repairing or, should Nokia in its absolute discretion deem it necessary, replacing the Product in accordance with this Limited Warranty (unless otherwise required by law). This Limited Warranty is only valid and enforceable in the country where you have purchased the Product provided that it is intended for sale in that country.

### **Warranty period**

The warranty period starts at the time of Product's original purchase by the first end-user. The Product may consist of several different parts and different parts may be covered by a different warranty period (hereinafter "Warranty Period"). The different Warranty Periods are:

- a) twelve (12) months for the mobile device and accessories (whether included in the mobile device sales package or sold separately) other than the consumable parts and accessories listed in (b) and (c) below;
- b) six (6) months for the following consumable parts and accessories: batteries, chargers, desk stands, headsets, cables and covers; and
- c) ninety (90) days for the media on which any software is provided, for example, CD-ROM or memory card

As far as your national laws permit, the Warranty Period will not be extended or renewed or otherwise affected due to subsequent resale, repair or replacement of the Product. However, repaired part(s) will be warranted for the remainder of the original Warranty Period or for sixty (60) days from the date of repair, whichever is longer.

### How to get warranty service

If you wish to make a claim under the Limited Warranty, you may call the Nokia call center (where this is available and please note national rates apply to calls) and/or where necessary, return your Product or the affected part (if it is not the entire Product) to a Nokia care centre or Nokia designated service location. Information about Nokia care centres, Nokia designated service locations and Nokia call centres can be found at local Nokia web pages where available.

You must return your Product or the affected part (if it is not the entire Product) to a Nokia care center or Nokia designated service location before the expiry of the Warranty Period.

When making a Limited Warranty claim you have to present: a) the Product (or affected part thereto), b) the legible and unmodified original proof of purchase, which clearly indicates the name and address of the seller, the date and place of purchase, the product type and the IMEI or other serial number.

This Limited Warranty extends only to the original first end-user of the Product and is not assignable or transferable to any subsequent purchaser/end-user.

### What is not covered?

1. This Limited Warranty does not cover user manuals or any third party software, settings, content, data or links, whether included/downloaded in the Product, whether included during installment, assembly, shipping or at any other time in the delivery chain or otherwise and in any way acquired by you. To the extent permitted by applicable law(s), Nokia does not warrant that any Nokia software will meet your requirements, will work in combination with any hardware or software applications provided by a third party, that the operation of the software will be uninterrupted or error free or that any defects in the software are correctable or will be corrected.

2. This Limited Warranty does not cover a) normal wear and tear (including, without limitation, wear and tear of camera lenses, batteries or displays), b) transport costs, c) defects caused by rough handling (including, without limitation, defects caused by sharp items, by bending, compressing or dropping, etc.), d) defects or damage caused by misuse of the Product, including use that is contrary to the instructions provided by Nokia (e.g. as set out in the Product's user guide) and/or e) other acts beyond the reasonable control of Nokia.

3. This Limited Warranty does not cover defects or alleged defects caused by the fact that the Product was used with, or connected to, a product, accessories, software and/or service not manufactured, supplied or authorised by Nokia or was used otherwise than for its intended use. Defects can be caused by viruses from your or from a third party's unauthorised access to services, other accounts, computer systems or networks. This unauthorised access can take place through hacking, password-mining or through a variety of other means.

4. This Limited Warranty does not cover defects caused by the fact that the battery has been short-circuited or by the fact that the seals of the battery enclosure or the cells are broken or show evidence of tampering or by the fact that the battery has been used in equipment other than those for which it has been specified.

## 102 Product and safety information

---

5. This Limited Warranty does not apply if the Product has been opened, modified or repaired by anyone other than an authorised service centre, if it is repaired using unauthorised spare parts or if the Product's serial number, the mobile accessory date code or the IMEI number has been removed, erased, defaced, altered or are illegible in any way and this shall be determined in the sole discretion of Nokia.

6. This Limited Warranty does not apply if the Product has been exposed to moisture, to dampness or to extreme thermal or environmental conditions or to rapid changes in such conditions, to corrosion, to oxidation, to spillage of food or liquid or to influence from chemical products.

### Other important notices

A third party, independent operator provides the SIM card and cellular and/or other network or system on which the Product operates. Therefore, Nokia will not accept responsibility under this warranty for the operation, availability, coverage, services or range of the cellular or other network or system. Before the Product can be repaired or replaced, the operator may need to unlock any SIM-lock or other lock that may have been added to lock the product to a specific network or operator. Accordingly, Nokia does not accept responsibility for any delays in warranty repairs or for the inability of Nokia to complete warranty repairs that are caused by the operator's delay or failure to unlock any SIM-lock or other lock.

Please remember to make backup copies or keep written records of all important content and data stored in your Product, because content and data may be lost during repair or replacement of the Product. Nokia, in a manner consistent with the provisions of the section entitled "Limitation of Nokia's Liability" below, to the extent permitted by applicable law(s), shall not under any circumstances be liable, either expressly or implied, for any damages or losses of any kind whatsoever resulting from loss of, damage to, or corruption of, content or data during repair or replacement of the Product.

All parts of the Product or other equipment that Nokia has replaced shall become the property of Nokia. If the returned Product is found not to be covered by the terms and conditions of the Limited Warranty, Nokia and its authorised service companies reserve the right to charge a handling fee. When repairing or replacing the Product, Nokia may use products or parts that are new, equivalent to new or reconditioned.

Your Product may contain country specific elements, including software. If the Product has been re-exported from its original destination country to another country, the Product may contain country specific elements that are not considered to be a defect under this Limited Warranty.

### Limitation of Nokia's liability

This Limited Warranty is your sole and exclusive remedy against Nokia and Nokia's sole and exclusive liability in respect of defects in your Product. However, this Limited Warranty shall neither exclude nor limit i) any of your legal (statutory) rights under the applicable national laws or ii) any of your rights against the seller of the Product.

This Limited Warranty replaces all other Nokia warranties and liabilities, whether oral, written, (non-mandatory) statutory, contractual, in tort or otherwise, including, without limitation, and where permitted by applicable law, any

implied conditions, warranties or other terms as to satisfactory quality or fitness for purpose. To the extent permitted by applicable law(s) Nokia does not assume any liability for loss of or damage to or corruption of data, for any loss of profit, loss of use of Products or functionality, loss of business, loss of contracts, loss of revenues or loss of anticipated savings, increased costs or expenses or for any indirect loss or damage, consequential loss or damage or special loss or damage. To the extent permitted by applicable law, Nokia's liability shall be limited to the purchase value of the Product. The above limitations shall not apply to death or personal injury resulting from Nokia's proven negligence.

### **Statutory obligations**

This Limited Warranty must be read subject to any statutory provisions that imply warranties or conditions into this Limited Warranty that cannot be excluded, restricted or modified or cannot be excluded, restricted or modified except to a limited extent. If such statutory provisions apply, to the extent to which Nokia is able to do so, its liability under those provisions will be limited, at its option to, in the case of goods: the replacement of the goods or the supply of equivalent goods, the repair of the goods, the payment of the cost of replacing the goods or of acquiring equivalent goods, or the payment of the cost of having the goods repaired; and in the case of services: the supplying of the services again or the payment of the cost of having the services supplied again.

**Note:** Your Product is a sophisticated electronic device. Nokia strongly encourages you to familiarise yourself with the user guide and instructions provided with and for the Product. Please also note that the Product might contain high precision displays, camera lenses and other such parts, which could be scratched or otherwise damaged if not handled very carefully.

All warranty information, product features and specifications are subject to change without notice.

Nokia Corporation

Keilalahdentie 2-4

FIN-02150 Espoo

Finland

### **Terms of use, OVI SERVICE TERMS and privacy policy**

#### **Terms of Use**

Thank you for choosing Nokia. By starting to use your device you begin your exciting journey with us.

#### **First use of your device**

To access the wide range of Nokia's Ovi services a Nokia Account will be automatically created for you when you first use your device. You then only need to add personal user information when accessing the services for the first time, after which you can manage your Nokia Account online.

## 104 Product and safety information

---

To help you to get the most out of your device and services, you will start receiving free personalized text messages from My Nokia with tips, tricks and support. You may unsubscribe from these My Nokia messages at any time by following the information on the welcome message you receive shortly after activating your device, or by clicking the My Nokia icon in your device and selecting Unsubscribe.

Upon first use of your device and after you have updated the Nokia device software an activation text message will be sent to Nokia.

### Software updates

If you update your Nokia device software the information described above in this notice still applies.

To ensure you have the latest Nokia device software and applications, your device checks the availability of software updates from Nokia. If any are available you will be prompted to approve their installation. You may disable automatic checking for updates through settings in your device. You may also install software through available software update channels.

### Other important information

By starting to use the device or when you update the Nokia device software you accept the Ovi Service Terms and Privacy Policy ("Terms") included in the sales box or as otherwise made available to you.

To provide you with the services described above your mobile number, device serial number and mobile subscription identifiers will be sent to Nokia upon first use of the device. Some or all of the above information may also be sent to Nokia in connection with software updates. This information may be used as further specified in the Privacy Policy.

This notice is not applicable and the welcome screen will not appear at first device use, if the service is not available in your country, software version or selected device language.

Normal charges for text messages and transmission of data will apply.

### OVI SERVICE TERMS

#### 1. Acceptance

These Ovi Service Terms together with the Privacy Policy (collectively "Terms") govern your use of the application or website where you accessed these Ovi Service Terms and use of the related services (collectively "Service") and the Terms constitute an agreement between you and Nokia Corporation defining the rights and responsibilities of you and Nokia Corporation including its affiliates and suppliers (collectively "Nokia") with respect to the Service. There may be additional conditions applicable to certain parts of the Service. You are not allowed to use the Service if you do not agree to the Terms.

#### 2. Eligibility



To use the Service, you must be at least thirteen (13) years of age. If you are at least thirteen (13) years of age but a minor where you live, you must review the Terms and have your parent or legal guardian complete the registration on your behalf for you to use the Service. The person completing the registration must be legally competent.

### 3. Registration and Termination

You agree to provide truthful and complete information when registering for the Service and to keep that information updated. Providing misleading information about your identity is forbidden.

When you register, you will create a username and a password. You (and your parent or legal guardian, if you are a minor) are personally responsible for any use of the Service with your username and password. You agree to take due care in protecting your username and password against misuse by others and promptly notify Nokia about any misuse.

You may terminate your registration if you no longer wish to use the Service. After termination, you will no longer have access to the Service. Nokia may terminate your registration or restrict your access to certain parts of the Service if there is an indication that you have breached the Terms or with a prior notice if you have not signed into the Service with your username in the past six (6) months. Except as set forth in Privacy Policy, Nokia shall not be responsible for any removal of the information or content you have submitted ("Material") from the Service when your registration is terminated.

After the Material is removed from the Service by either you or Nokia, some traces of the Material may remain and copies of the Material may still reside within the Service.

### 4. Using the Service

You agree to:

- Use the Service only for your private, non-commercial purposes;
- Comply with applicable laws, the Terms and good manners;
- Not submit unlawful, offensive, abusive, pornographic, harassing, libelous or other inappropriate Material;
- Respect the privacy of others;
- Obtain any consents, permission or licenses that may be required for you to have the legal right to submit any Material; and
- Not distribute or post spam, unreasonably large files, chain letters, pyramid schemes, viruses or any other technologies that may harm the Service, or the interest or property of the Service users.

## 106 Product and safety information

---

Nokia may but has no obligation to:

- Monitor or moderate any of the Material; and
- Remove any Material from the Service and restrict access to any part of the Service at any time in its sole discretion.

### 5. Allegations of Copyright Infringement

You may notify Nokia of copyright infringement on the Service by providing notice (a) by email with “Copyright Notification” in the subject line to [copyright\\_notices@nokia.com](mailto:copyright_notices@nokia.com), (b) by a document titled “Copyright Notification” mailed to Nokia, Attn: Copyright Agent, 102 Corporate Park Drive, White Plains, NY 10604, or (c) via the online form, if available. Your notice must:

- (1) Identify the original copyrighted work you claim is infringed;
- (2) Identify the content on the Service that you claim is infringing the copyrighted work. Please provide enough detail for Nokia to locate the allegedly infringing content on the Service;
- (3) Provide your contact information, including your full name, mailing address, telephone number, and email address, if available;
- (4) Provide a statement that you have a good faith belief that the use of the content in the manner complained of is not authorized by the copyright owner, its agent, or the law;
- (5) Provide this statement: “I swear, under penalty of perjury, that the information in this notification and complaint is accurate and that I am the copyright owner, or am authorized to act on behalf of the copyright owner of an exclusive right that is infringed.”; and
- (6) Provide your signature.

### 6. Licenses

Nokia does not claim ownership in your Material. Your submission of Material to the Service does not transfer ownership rights in the Material to Nokia. However, by submitting Material to the Service you grant Nokia a worldwide nonexclusive, assignable, fully paid, royalty-free, perpetual and irrevocable license to use, copy, publicly perform, display, distribute and modify the Material, and to prepare derivative works thereof, or incorporate the Material into other works as well as sublicense the same.

Users of the Service are granted a non-exclusive, non-transferable, revocable license (revocable at the sole discretion of Nokia at any time) to access and use the Service strictly in accordance with the Terms. Any further intellectual property rights in any information or content in the Service are not granted.

### 7. Fees

Your use of the Service may be or may become subject to charges. Any fees charged by Nokia will be announced separately in connection with the Service.

Use of the Service may involve transmission of data through your service provider's network. Your network service provider may charge for such data transmission.

Nokia assumes no responsibility for the payment of any charges.

### 8. Availability

The Service may not be available in some countries and may be provided only in selected languages. The Service may be network dependent, contact your network service provider for more information.

Nokia reserves the right, in its sole discretion, to change, improve and correct the Service. The Service may not be available during maintenance breaks and other times.

Nokia may also decide to discontinue the Service or any part thereof in its sole discretion. In such case you will be provided a prior notification.

### 9. Dealings with Others

You may interact with other users on or through the Service. You agree that any such interactions do not involve Nokia and are solely between you and the other user(s).

### 10. Personal Data

The Privacy Policy and additional provisions in these Ovi Service Terms govern use of your personal data.

### 11. Limitation of Liability

## 108 Product and safety information

---

The Service is provided on "AS IS" and "AS AVAILABLE" basis. Nokia does not warrant that the Service will be uninterrupted or error or virus-free. No warranty of any kind, either express or implied, including but not limited to warranties of title or non-infringement or implied warranties of merchantability or fitness for a particular purpose, is made in relation to the availability, accuracy, reliability, information or content of the Service. You expressly agree and acknowledge that the use of the Service is at your sole risk and that you may be exposed to content from various sources.

Except for liability for death or personal injury caused by gross negligence or intentional misconduct, Nokia shall not be liable for any direct, indirect, incidental, punitive or consequential damages caused by the use or inability to use the Service.

### 12. Indemnification

You agree to defend, indemnify and hold harmless Nokia from and against any and all third party claims and all liabilities, assessments, losses, costs or damages resulting from or arising out of i) your breach of the Terms, ii) your infringement or violation of any intellectual property, other rights or privacy of a third party, iii) misuse of the Service by a third party where such misuse was made available by your failure to take reasonable measures to protect your username and password against misuse.

### 13. Miscellaneous

#### 13.1 Choice of Law and Arbitration

Except where prohibited by applicable law or provided otherwise herein, the Terms shall be governed by the laws of Finland without regard to its conflict of law provisions.

If you are a US resident the following paragraph shall apply: The Terms shall be governed by the laws of New York without regard to its conflicts of law provisions. Any dispute relating to these Terms or the Service shall be submitted to binding arbitration in Westchester County, New York within eighteen (18) months of the date the facts giving rise to the suit were known, or should have been known, by the complainant, except that Nokia may seek injunctive or other relief if you have violated or threatened to violate any intellectual property rights. All matters relating to arbitration shall be governed by the Federal Arbitration Act (9 U.S.C. §1 et. seq.). Arbitration shall be conducted by a single arbitrator under the then prevailing Wireless Arbitration Rules of the American Arbitration Association ("AAA"). Each party must submit any claim which would constitute a compulsory counterclaim in litigation or such claim shall be barred. No award of exemplary, special, consequential or punitive damages shall be permitted. The losing party, as determined by the arbitrator, shall pay the arbitration fees. The arbitrator's award shall be binding and may be entered as a judgment and enforceable in any court of competent jurisdiction. Arbitration shall be conducted on an individual, not class-wide basis, and no arbitration shall be joined with an arbitration involving any other person or entity.

### 13.2 Validity

The Terms shall neither exclude nor limit any of your mandatory rights in your country of residence. If a provision of the Terms is found to be invalid, the validity of the remaining provisions shall not be affected and the invalid provision shall be replaced with a valid provision that comes closest to the result and purpose of the Terms. If there is any conflict between these Ovi Service Terms and the Privacy Policy, the provisions of these Ovi Service Terms shall prevail. The provisions of the Terms that are intended to survive termination shall remain valid after any termination.

### 13.3 Changes in Terms

Nokia reserves the right to modify the Terms at any time without prior notice. If the Terms are changed in a material, adverse way, Nokia will provide a separate prior notice advising of such change.

You are responsible for regularly reviewing the Terms. Your continued use of the Service shall constitute your consent to any changes and modifications.

### 13.4 Links to Third Party Sites and Content

For your easy accessibility Nokia may include links to sites on the Internet that are owned or operated by third parties and that are not part of the Service. Upon following a link to such a third-party site, you shall review and agree to that site's rules of use before using such site.

You agree that Nokia has no control over the content of third-party sites and cannot assume any responsibility for services provided or material created or published by such sites. A link to a third-party site does not imply that Nokia endorses the site or the products or services referenced in the site.

In addition, users may create links within the Service to content that has not otherwise been submitted to the Service. You agree that Nokia is neither responsible for nor liable for any such links.

## 14. Intellectual Property

The Service and related software are protected under international copyright laws and you are hereby notified that copyrights are claimed by Nokia. Subject to the Terms, Nokia retains all right, title and interest in the Service and in all Nokia's products, software and other properties provided to you or used by you through the Service.

### WE CARE ABOUT YOUR PRIVACY

Nokia is committed to protecting your privacy and to comply with applicable data protection and privacy laws. We hope that this Privacy Policy ("Policy") helps you understand what kind of information we collect in connection with our products and services and how we process such information. Throughout this Policy the term "personal data" means

## 110 Product and safety information

---

information relating to an identified or identifiable individual (i.e. a natural person). “Nokia” refers to Nokia Corporation, including its affiliates (also referred to as “we”, “us”, or “our”).

This Policy applies to personal data collected in connection with products and services offered by Nokia or from other interactions with us where a link or other reference of incorporation to this Policy is made, for example, in connection with our devices and accessories, websites (also including mobile websites), games, music and other types of services offered by Nokia typically in electronic form, as well as other services such as customer care and warranty services or promotions and campaigns.

We may provide additional or amending privacy information in connection with a particular Nokia product or service. Such information prevails over this Policy to the extent of any conflict. Our products or services may contain links to other companies’ websites and other third party services that have privacy policies of their own. We recommend that you read the privacy policies of such services. Nokia is not responsible for the privacy practices or contents of any such services.

**By using this website and/or by submitting personal data to Nokia, you express your agreement to the processing of your personal data in the manner provided in this Policy. If you do not agree with this Policy, please do not use this website or provide Nokia with your personal data.**

### The Data We Collect

We collect your personal data typically when you make a purchase, use or register into our services, enter into a sales promotion or a campaign or otherwise interact with us. We endeavour to collect personal data only with your knowledge or consent. Below are examples of the categories of data collected.

- **Technical Information** For the most part, you may visit our websites or use our products or services without having to tell us who you are. However, certain technical information is normally collected as a standard part of your use of our services. Such information includes, for example, your IP-address, access times, the website you linked from, pages you visit, the links you use, the ad banners and other content you viewed, information about your devices and other such technical information your browser provides us with or as may be otherwise collected in connection with certain products and services. When you use our services or otherwise interact with us over telecommunications networks, certain additional information, such as your mobile telephone number, may be transmitted to us by the telecommunications operator as a standard part of that communication. Please also see the section “Use of Cookies and Web Beacons” below.
- **Information you provide us with** When you register for our services, make a purchase, enter a sales promotion or otherwise interact with us, we may ask you to provide us with information such as your name, email address, street address, as well as user names, passwords and other such credentials that are used to authenticate users and to validate their actions or that may be needed to provide you with the products and services you have requested or to communicate with you.

We may collect demographic information, for example, your age, gender, postal code and language preferences. We may also collect other information you provide, such as your consents, preferences and feedback, information relating to your devices and other such information you provide us with. Please note that certain non-identifiable information collected from you may become personally identifiable when you provide us with your personal data. We may also obtain, in accordance with applicable law, some personal data from list-rental companies and other such publicly available sources. Some of our services may allow you to submit information about other people, for example, if you make an order for a product that you wish us to send directly to another recipient.

- **Your transactions with us** We collect or ask for information relating to your purchase and/or use of our products and/or services and your other interactions with us. Such information may include, for example, details of the queries or requests you have made, the products and services provided (including delivery details), financial details (including payments made, credit card details, billing address, credit checks and other such financial information), details of agreements between you and Nokia, records of contacts and communications, information and details relating to the content you have provided us with and other such transactional information. We may, in accordance with applicable law, record your communication with our customer care or with other such contact points. Certain services may involve the use of your location data. However, use of your location data for such services is subject to your consent.

### The Purposes for which We Process Your Personal Data

Nokia processes your personal data for the purposes described in this Policy and/ or any additional service specific privacy information. Please note that one or more purposes may apply simultaneously.

- **Provision of products and services** We may use your personal data to fulfill your requests, process your order or as otherwise may be necessary to perform or enforce the contract between you and Nokia, to ensure the functionality and security of our products and services, to identify you and to prevent and investigate fraud and other misuses.
- **Development of products and services** We may use your personal data to develop our products and/or services. However, for the most part we only use aggregate and statistical information in the development of our products and services. We may also use your personal data to personalize our offering and to provide you with service more relevant to you, for example, to make recommendations and to display customized content and advertising in our websites. We may combine personal data collected in connection with your use of a particular Nokia product and/ or service with other personal data we may hold about you, except where such personal data was collected for a different purpose. We may create aggregate and statistical information based on your personal data.
- **Communicating with you and marketing** We may use your personal data to communicate with you, for example, to provide information relating to our products and/or services you are using or to contact you for customer satisfaction queries. We may use your personal data for marketing or research purposes, for example, to conduct market research and we may, in accordance with applicable law, contact you to inform you of new products, services or promotions we may offer. Also, some of our products and services may be used to promote products and services

## 112 Product and safety information

---

of other companies. However, Nokia does not disclose your personal data to such companies or any other company for marketing purposes without your prior consent.

### Sharing Your Personal Data

Generally, we do not sell, lease, rent or otherwise disclose your personal data to third parties unless otherwise stated below.

- **Consent** We may share your personal data if we have your consent to do so. Some services may include sharing your personal data with other users of the service, for example services where users publish their own content or Nokia user communities.
- **Nokia companies and authorized third parties** We may share your personal data with other Nokia companies or authorized third parties who process personal data for Nokia for the purposes described in this Policy. Such parties are not permitted to use your personal data for other purposes, and we require them to act consistently with this Policy and to use appropriate security measures to protect your personal data.
- **International transfers** Our products and services may be provided using resources and servers located in various countries around the world. Therefore your personal data may be transferred across international borders outside the country where you use our services, including to countries outside the European Economic Area (EEA) that do not have laws providing specific protection for personal data or that have different legal rules on data protection, for example, the United States of America. In such cases we take steps to ensure that there is a legal basis for such a transfer and that adequate protection for your personal data is provided as required by applicable law, for example, by using standard agreements approved by relevant authorities (where necessary) and by requiring the use of other appropriate technical and organizational information security measures.
- **Mandatory disclosures** We may be obligated by mandatory law to disclose your personal data to certain authorities or other third parties, for example, to law enforcement agencies in the countries where we or third parties acting on our behalf operate. We may also disclose and otherwise process your personal data in accordance with applicable law to defend Nokia's legitimate interests, for example, in civil or criminal legal proceedings.
- **Mergers and Acquisitions** If we decide to sell, buy, merge or otherwise reorganise our businesses in certain countries, this may involve us disclosing personal data to prospective or actual purchasers and their advisers, or receiving personal data from sellers and their advisers.

### Collecting the Data of Minors

Nokia does not seek to collect any information from or engage in any transactions with persons under the age of 13. Our databases may nevertheless contain personal data of children under 13 due to the fact that it is not always possible to determine precisely the age of the user. Insofar as we ask you to provide your age, we block the service from any person who is under 13 years of age. We will also make reasonable efforts to clear our databases of personal data relating to under age users.



Nokia's policy is to request that minors (the legal age of majority and therefore the age of minors is determined by local law where you reside) do not make purchases or engage in other legal acts on our products and services without the consent of a parent or legal guardian, unless otherwise permitted by applicable law.

### **Data Quality**

We take reasonable steps to keep the personal data we possess accurate and upto- date and to delete out of date or otherwise incorrect or unnecessary personal data.

As certain Nokia products and services may allow you to manage your profile, we encourage you to access your personal data from time to time to ensure that it is correct and up-to-date. Please remember that it is your responsibility to provide us with correct details as well as to update the personal data you have provided us with in case of any changes.

### **Security**

While there are always risks associated with providing personal data, whether in person, by phone, via the internet or otherwise, and no technology is completely safe or "tamper" or "hacker" proof, Nokia takes appropriate technical and organizational information security measures to prevent and minimize such risks.

Such measures include, where appropriate, the use of firewalls, secure server facilities, encryption, implementing proper access rights management systems and processes, careful selection of processors and other technically and commercially reasonable measures to provide appropriate protection for your personal data against unauthorized use or disclosure. Where appropriate, we may also take back-up copies and use other such means to prevent accidental damage or destruction to your personal data. If a particular part of a Nokia website supports on-line transactions, we will use an industry standard security measure, such as the one available through "Secure Sockets Layer" ("SSL"), to protect the confidentiality and security of online transactions.

### **Use of Cookies and Web Beacons**

From time to time when you visit a Nokia website, information may be placed on your computer to allow us to recognize your computer. This information is commonly in the form of a textfile known as a "cookie". Cookies are small pieces of data stored on your computer's hard drive, rather than on the website. Typically, they enable collection of certain information about your computer, including your internet protocol (IP) address, your computer's operating system, your browser type and the address of any referring sites. Our use of cookies is intended to provide benefits to you, such as eliminating the need for you to enter your password frequently during a session or the need to re-enter items you place in a shopping cart if you do not finish a transaction in a single visit. Cookies are also used for website traffic analysis and anonymous demographic profiling so that we may improve our services.

Nokia may use so called web beacons (or "pixel tags") in connection with some websites. However, we do not use them to identify individual users personally. Web beacons are typically graphic images that are placed on a website and they

## 114 Product and safety information

---

are used to count visitors to a website and/or to access certain cookies. This information is used to improve our services. Web beacons do not typically collect any other information than what your browser provides us with as a standard part of any internet communication. If you turn off cookies, the web beacon will no longer be able to track your specific activity. The web beacon may, however, continue to collect information of visits from your IP-address, but such information will no longer be unique.

If you do not wish to receive cookies, or want to be notified before they are placed, you may set your web browser to do so, if your browser so permits. Please understand that if cookies are turned off, you may not be able to view certain parts of this site that may enhance your visit. Some of our business partners whose content is linked to or from this site may also use cookies or web beacons. However, we have no access to or control over these cookies.

### Your Rights

In case you wish to know what personal data we hold about you or you wish to replenish, rectify, anonymize or delete any incomplete, incorrect or outdated personal data, or you wish us to cease processing your personal data for the purpose of sending promotional materials or direct marketing or for the performance of market research or on other compelling legal grounds, you may, as appropriate and in accordance with applicable law, exercise such rights by contacting us through the contact points referred to below. In some cases, especially if you wish us to delete or cease the processing of your personal data, this may also mean that we may not be able to continue to provide the services to you. We encourage you to use available profile management tools for the above purposes as such tools often provide you with direct access to your personal data and allow you to effectively manage it.

Please note that Nokia may need to identify you and to ask for additional information in order to be able to fulfill your above request. Please also note that applicable law may contain restrictions and other provisions that relate to your above rights.

### The Controller of Your Personal Data and Contact Details

Nokia Corporation of Keilalahdentie 4, 02150 Espoo, Finland shall be the controller of your personal data.

In addition, the Nokia affiliate providing the product or service may be a controller of your personal data. You may find the identity of the controller and its contact details by reviewing the terms and conditions of such a product or service or by using contact information provided in the applicable Nokia websites. In matters pertaining to Nokia's privacy practices you may also contact us at:

Nokia Corporation

c/o Privacy

Keilalahdentie 4

02150 Espoo

Finland

### **Changes to This Privacy Policy**

Nokia may from time to time change this Privacy Policy or change, modify or withdraw access to this site at any time with or without notice. However, if this Privacy Policy is changed in a material, adverse way, Nokia will post a notice advising of such change at the beginning of this Policy and on this site's home page for 30 days. We recommend that you re-visit this Privacy Policy from time to time to learn of any such changes to this Privacy Policy.

### **How to obtain an English User Guide**

Nokia understands from consumer feedback in PRC that there is only limited usage of the English User Guide.

In consideration of this and to help conserve natural resources, Nokia has selected to not to include the English User Guide in the Sales Package.

To obtain a User Guide in English, please kindly download it from: [www.nokia.com.cn/englishUG](http://www.nokia.com.cn/englishUG).

The feature descriptions in English User Guide may vary by market, thus the device features described in the English User Guide you have obtained may differ from those shown on the display in English user interface.

## DECLARATION OF CONFORMITY

**CE 1588**

Hereby, NOKIA CORPORATION declares that this RM-678 product is in compliance with the essential requirements and other relevant provisions of Directive 1999/5/EC. A copy of the Declaration of Conformity can be found at [http://www.nokia.com/phones/declaration\\_of\\_conformity/](http://www.nokia.com/phones/declaration_of_conformity/).

© 2010 Nokia. All rights reserved.

Nokia, Nokia Connecting People, Nokia Original Enhancements logos, Nseries, N-Gage, Navi, Visual Radio, and Nokia Care are trademarks or registered trademarks of Nokia Corporation. Nokia tune is a sound mark of Nokia Corporation. Other product and company names mentioned herein may be trademarks or tradenames of their respective owners.

Reproduction, transfer, distribution, or storage of part or all of the contents in this document in any form without the prior written permission of Nokia is prohibited. Nokia operates a policy of continuous development. Nokia reserves the right to make changes and improvements to any of the products described in this document without prior notice.

US Patent No 5818437 and other pending patents. T9 text input software Copyright © 1997-2010. Tegic Communications, Inc. All rights reserved.



Java and all Java-based marks are trademarks or registered trademarks of Sun Microsystems, Inc.

This product is licensed under the MPEG-4 Visual Patent Portfolio License (i) for personal and noncommercial use in connection with information which has been encoded in compliance with the MPEG-4 Visual Standard by a consumer engaged in a personal and noncommercial activity and (ii) for use in connection with MPEG-4 video provided by a licensed video provider. No license is granted or shall be implied for any other use. Additional information, including that related to promotional, internal, and commercial uses, may be obtained from MPEG LA, LLC. See <http://www.mpegla.com>.

TO THE MAXIMUM EXTENT PERMITTED BY APPLICABLE LAW, UNDER NO CIRCUMSTANCES SHALL NOKIA OR ANY OF ITS LICENSORS BE RESPONSIBLE FOR ANY LOSS OF DATA OR INCOME OR ANY SPECIAL, INCIDENTAL, CONSEQUENTIAL OR INDIRECT DAMAGES HOWSOEVER CAUSED.

THE CONTENTS OF THIS DOCUMENT ARE PROVIDED "AS IS". EXCEPT AS REQUIRED BY APPLICABLE LAW, NO WARRANTIES OF ANY KIND, EITHER EXPRESS OR IMPLIED, INCLUDING, BUT NOT LIMITED TO, THE IMPLIED WARRANTIES OF MERCHANTABILITY AND FITNESS FOR A PARTICULAR PURPOSE, ARE MADE IN RELATION TO THE ACCURACY, RELIABILITY OR CONTENTS OF THIS DOCUMENT. NOKIA RESERVES THE RIGHT TO REVISE THIS DOCUMENT OR WITHDRAW IT AT ANY TIME WITHOUT PRIOR NOTICE.

For the most current product information, please refer to [www.nokia.com.cn](http://www.nokia.com.cn).

Reverse engineering of software in the device is prohibited to the extent permitted by applicable law. Insofar as this user guide contains any limitations on Nokia's representations, warranties, damages and liabilities, such limitations shall likewise limit any representations, warranties, damages and liabilities of Nokia's licensors.

The availability of particular products and applications and services for these products may vary by region. Please check with your Nokia dealer for details and availability of language options. This device may contain commodities, technology or software subject to export laws and regulations from the US and other countries. Diversion contrary to law is prohibited.

Some operations and features are SIM card and/or network dependent, MMS dependent, or dependent on the compatibility of devices and the content formats supported. Some services are subject to a separate charge.

The third-party applications provided with your device may have been created and may be owned by persons or entities not affiliated with or related to Nokia. Nokia does not own the copyrights or intellectual property rights to the third-party applications. As such, Nokia does not take any responsibility for end-user support, functionality of the applications, or the information in the applications or these materials. Nokia does not provide any warranty for the third-party applications.

BY USING THE APPLICATIONS YOU ACKNOWLEDGE THAT THE APPLICATIONS ARE PROVIDED AS IS WITHOUT WARRANTY OF ANY KIND, EXPRESS OR IMPLIED, TO THE MAXIMUM EXTENT PERMITTED BY APPLICABLE LAW. YOU FURTHER ACKNOWLEDGE THAT NEITHER NOKIA NOR ITS AFFILIATES MAKE ANY REPRESENTATIONS OR WARRANTIES, EXPRESS OR IMPLIED, INCLUDING BUT NOT LIMITED TO WARRANTIES OF TITLE, MERCHANTABILITY OR FITNESS FOR A PARTICULAR PURPOSE, OR THAT THE APPLICATIONS WILL NOT INFRINGE

ANY THIRD-PARTY PATENTS, COPYRIGHTS, TRADEMARKS, OR OTHER RIGHTS.

#### FCC NOTICE

Your device may cause TV or radio interference (for example, when using a telephone in close proximity to receiving equipment). The FCC can require you to stop using your telephone if such interference cannot be eliminated. If you require assistance, contact your local service facility. This device complies with part 15 of the FCC rules. Operation is subject to the following two conditions: (1) This device may not cause harmful interference, and (2) this device must accept any interference received, including interference that may cause undesired operation. Any changes or modifications not expressly approved by Nokia could void the user's authority to operate this equipment.

#### Issue 1.3

## Index

## A

A-GPS (assisted GPS)	51
access codes	26
accessories	90
active standby mode	34
antennas	14
assisted GPS (A-GPS)	51
audio messages	81

## B

battery	
— charging	15
— inserting	9
— saving power	27
blogs	57
Bluetooth connectivity	65
— pairing devices	67
— security	66
— sending data	66
browser	58
— bookmarks	56
— browsing pages	56
— cache memory	58
— security	59

## C

cache memory	58
calls	84
— video calls	85
camera	
— colour	49
— flash	46
— image quality	48
— imaging mode	44
— indicators	42
— lighting	49
— settings	48
— toolbar	43
— video mode	47
— video quality	50
China Mobile	
— customer service	62
— services	62
clock	34
contact information	25
cookies	58
copyright protection	54
customer service	25

## D

device manager	69
----------------	----

## E

e-mail	82
--------	----

---

e100	90	list view of menus	34
<b>F</b>		location information	51
feeds, news	57	lock code	26
FM radio	39	locking keypad	31
<b>G</b>		<b>M</b>	
general information	25	Mail for Exchange	82
GPS (Global Positioning System)	51	main menu	34
grid view of menus	34	media	
<b>H</b>		— music player	36
headset	19	— radio	39
help application	25	memory	
<b>I</b>		— clearing	28
indicators	21	— web cache	58
internet connection	56	memory card	17, 18
See also <i>browser</i>		messages	80
internet radio		MMS (multimedia message service)	81
— listening	41	Monternet	61
<b>K</b>		multimedia messages	81
keyguard	31	music key	38
keypad	31	music player	36
keys and parts	12, 13	— playing	36
<b>L</b>		— transferring music	38
licences	54	My favorites	60
		<b>N</b>	
		navigation tools	51
		network settings	23

---

## 120 Index

---

news feeds	57	remote configuration	69
Nokia contact information	25	ringing tones	33
Nokia original accessories	90	roaming	23
Nokia support information	23		
<b>O</b>		<b>S</b>	
offline mode	32	security	
		— browser	59
		security code	26
		service shortcut	63
		settings	
		— Bluetooth	65
		— camera	48
		— FM radio	40
		— network	23
		SIM card	
		— inserting	9
		SMS (short message service)	81
		songs	36
		special characters, text entry	77, 79
		standby mode	34
		support	25
		support resources	23
		switching device on/off	14
<b>P</b>		<b>T</b>	
phonebook manager	87	text entry	71
photographs		text messages	
<i>See camera</i>		— sending	81
PIN code	26	tones	33
PIN2 code	26		
positioning information	51		
powering device on/off	14		
predictive text entry mode	75, 78		
product support pages	25		
profiles			
— offline restrictions	32		
PUK codes	26		
punctuation, text entry	79		
<b>R</b>			
radio	39		
— listening	39		
— settings	40		
— stations	40		
recording video clips	47		



transferring	30
transferring music	37

**U**

unlocking keypad	31
UPIN code	26
UPUK code	26
useful information	25

**V**

video calls	84, 85
video settings	50
voice calls	
<i>See calls</i>	

**W**

web connection	56
----------------	----

## Free Manuals Download Website

<http://myh66.com>

<http://usermanuals.us>

<http://www.somanuals.com>

<http://www.4manuals.cc>

<http://www.manual-lib.com>

<http://www.404manual.com>

<http://www.luxmanual.com>

<http://aubethermostatmanual.com>

Golf course search by state

<http://golfingnear.com>

Email search by domain

<http://emailbydomain.com>

Auto manuals search

<http://auto.somanuals.com>

TV manuals search

<http://tv.somanuals.com>