

User Guide for Nokia Fitness Monitor LS-2

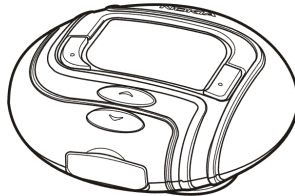

9231525

Issue 1

DECLARATION OF CONFORMITY

We, NOKIA CORPORATION declare under our sole responsibility that the product LS-2 is in conformity with the provisions of the following Council Directive: 1999/5/EC.

A copy of the Declaration of Conformity can be found at
http://www.nokia.com/phones/declaration_of_conformity/.



Copyright © 2004 Nokia. All rights reserved.

Reproduction, transfer, distribution or storage of part or all of the contents in this document in any form without the prior written permission of Nokia is prohibited.

Nokia and Nokia Connecting People are trademarks or registered trademarks of Nokia Corporation. Other product and company names mentioned herein may be trademarks or tradenames of their respective owners.

Nokia operates a policy of ongoing development. Nokia reserves the right to make changes and improvements to any of the products described in this document without prior notice.

Under no circumstances shall Nokia be responsible for any loss of data or income or any special, incidental, consequential or indirect damages howsoever caused.

The contents of this document are provided "as is". Except as required by applicable law, no warranties of any kind, either express or implied, including, but not limited to, the implied warranties of merchantability and fitness for a particular purpose, are made in relation to the accuracy, reliability or contents of this document. Nokia reserves the right to revise this document or withdraw it at any time without prior notice.

The availability of particular products may vary by region. Please check with the Nokia dealer nearest to you.

9231525/Issue 1

Contents

FOR YOUR SAFETY	5
Overview	6
First day of using Nokia Fitness Monitor.....	6
Introduction	7
1. Parts and keys.....	9
2. Getting started	10
Charging Nokia Fitness Monitor	10
Switching Nokia Fitness Monitor on and off	10
Using the menu and inserting data.....	11
Attaching Nokia Fitness Monitor.....	12
List of menu functions.....	13
3. Using Nokia Fitness Monitor.....	15
Selecting an activity.....	15
Adding and removing activities.....	16
Viewing data.....	16
Setting goals.....	17
Personal information.....	18
General settings.....	19
Using stopwatch and timer	20
Stopwatch.....	20
Timer.....	20
Transferring data	21

4. Technical specifications	22
5. Battery information.....	23
Charging and Discharging.....	23
CARE AND MAINTENANCE.....	24

FOR YOUR SAFETY

Read these simple guidelines. Not following them may be dangerous or illegal. Read the complete user guide for further information.



BEFORE EXERCISING

Before beginning a regular exercise program consult your physician or doctor.



QUALIFIED SERVICE

Only qualified personnel may repair this product.



CONNECTING TO OTHER DEVICES

When connecting to any other device, read its user guide for detailed safety instructions. Do not connect incompatible products.



WATER-RESISTANCE

Your device is not water-resistant. Keep it dry.

Overview

Thank you for purchasing Nokia Fitness Monitor!

■ First day of using Nokia Fitness Monitor

1. Charge Nokia Fitness Monitor over night: open the charging connector cover at the bottom of Nokia Fitness Monitor and attach the charger to the monitor and to a wall socket.

Check the model number of any charger before use with this device. This device is intended for use when supplied with power from ACP-12 charger.



Warning: Use only chargers approved by Nokia for use with this particular device. The use of any other types will invalidate any approval or warranty applying to the device, and may be dangerous.

For availability of approved chargers, please check with your dealer. When you disconnect the power cord of any accessory, grasp and pull the plug, not the cord.

2. Switch Nokia Fitness Monitor on by pressing and holding . The monitor asks if you want to define your personal information for more accurate distance and calory consumption calculations. In addition, you should define a language for the device, and the current time and date.





Press **Yes** to define the information (see [Personal information](#) on page 18) or **No** to use the default settings.

3. Attach Nokia Fitness Monitor to your belt or waist band and go about your daily activities. The *Automatic* activity is selected by default.

The monitor automatically gathers information about your calory consumption, the amount of steps you take, and the distance you travel. The monitor recognises whether you are walking, running, or static.



Warning: Exercise may include some risk, especially for those who have been sedentary. Before beginning a regular exercise program consult your physician or doctor.

4. During the day, press  to compare the data about your accumulated activities against your daily goal.
5. In the evening, when you go, for example, running, change the activity type from *Automatic* to *Running*. Press *Activity*, select *Running* and press *Start*.
6. After the run, return to the *Automatic* mode. Press *Stop* and  or  to scroll through the results of the *Running* session. Press *Exit* to store the result.
7. When you go to bed, switch Nokia Fitness Monitor off by pressing and holding .

■ Introduction

Nokia Fitness Monitor LS-2 tracks your activity level throughout the day. Attached to your waistband or belt, Nokia Fitness Monitor estimates the distance you have covered, the time you have spent in an activity, and how many calories you have burned. Set a fitness goal for yourself, or just keep yourself informed



about your daily, weekly, and monthly activities. Nokia Fitness Monitor helps you reach whatever fitness level you desire.

Nokia Fitness Monitor is easy to use, since it has display and menu functions similar to Nokia phones. In addition, you can transfer the stored activity data from Nokia Fitness Monitor to a compatible Nokia phone using an infrared (IR) connection.



Read this user guide carefully before using Nokia Fitness Monitor.

1. Parts and keys

Nokia Fitness Monitor contains the following parts and keys.

1. IR port
2. Power on/off key 
3. Display
4. Selection keys  and 

The function of the selection keys depends on the guiding text shown on the display next to the keys, for example, **Menu** and **Activity** in the standby mode.

5. Scroll keys  and 
6. Charging connector cover

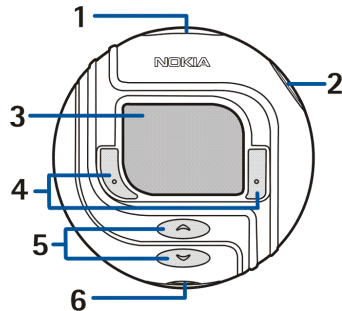

2. Getting started

■ Charging Nokia Fitness Monitor

1. Open the charger connector cover.
2. Connect the lead from the charger to the socket.
3. Connect the charger to a wall socket.

The charging time is approximately 2.5 hours. If Nokia Fitness Monitor is switched on, the charging icon on the display stops moving when the device is fully charged.

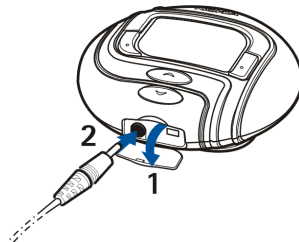



The Nokia Fitness Monitor battery lasts longer if you switch the monitor off during the night, instead of charging the device each day.





Note: Nokia Fitness Monitor has a rechargeable battery that is not designed to be replaced by a consumer. For service of Nokia Fitness Monitor, take it to the nearest authorised service facility.

■ Switching Nokia Fitness Monitor on and off

To switch Nokia Fitness Monitor on, press and hold .

To switch Nokia Fitness Monitor off, press and hold .



If Nokia Fitness monitor crashes and does not respond to any key presses, boot it by pressing  and .

When you switch Nokia Fitness Monitor on for the first time, it asks if you want to define your personal information. See [Personal information](#) on page 18. The personal information enables Nokia Fitness Monitor to calculate the distance you have covered and your calory consumption more accurately. In addition, you should define a language for the device, and the current time and date.



If you do not define the personal information, Nokia Fitness Monitor asks again if you want to do it when you turn the device on for the second and third time.

■ Using the menu and inserting data

Nokia Fitness Monitor functions are grouped into menus.

1. To access the menu, press **Menu**.
2. Scroll through the menu by pressing  or  and select, for example, **GOALS** by pressing **Select**.
3. Select the function of your choice.
4. Press **Back** to return to the previous menu level, and **Exit** to exit the menu. You can always return to the standby mode by pressing and holding **Back**.

To insert data, such as the goals or your personal information:

1. Access the applicable menu.
2. Press  or  to scroll through the numbers until the number you need is displayed.

3. Press **>** to move the cursor to the next number.
If you make a mistake, press **>** until the cursor reaches the maximum length of the data and reverts to the first number.
4. When you have inserted all the data, press **OK** to save the information.

■ Attaching Nokia Fitness Monitor

You can attach Nokia Fitness Monitor to your belt or waist band. Lift the clip (1) from the back of Nokia Fitness Monitor and clamp the belt under the clip. Make sure that Nokia Fitness Monitor sits firmly on your side against your waist or hip. If you attach Nokia Fitness Monitor to a pocket of loosely fitting trousers, it is not able to sense your movements.

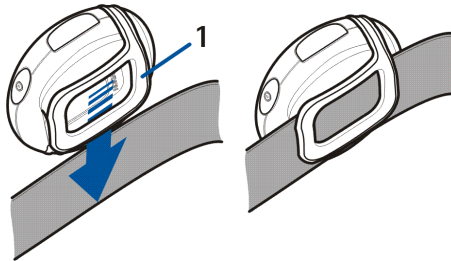

Note: Make sure that Nokia Fitness Monitor is attached so that the IR port is on top. If you attach the monitor upside down, the collected data may be incorrect.

■ List of menu functions

1. RESULTS¹

1. Today
2. This week
3. This month

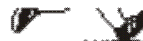

2. GOALS

1. Daily goal
2. One time goal
3. Default goals

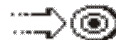

3. PERS INFO

1. Gender
2. Date of birth
3. Height
4. Weight
5. BMI and BMR
6. Walking Step
7. Running Step



4. SETTINGS

1. Time
2. Date





1. The **RESULTS** menu also contains submenus for the last 11 months starting from the month you first used Nokia Fitness Monitor.

- 3. Energy
- 4. Measurement
- 5. Language
- 6. Tone
- 7. Factory settings
- 5. EXTRAS
 - 1. Stopwatch
 - 2. Timer
- 6. DATATRANS



3. Using Nokia Fitness Monitor



In the standby mode, press  to quickly compare your activities against your goals. Press  repeatedly to view a comparison against your daily goal for the current day, for the last seven days and last four weeks, and the current situation against your one-time goal.

■ Selecting an activity

When you switch Nokia Fitness Monitor on, the *Automatic* activity is selected by default.

When *Automatic* is selected, Nokia Fitness Monitor automatically recognises whether you are walking, running, or standing still, and so records your fitness data accordingly. The *Automatic* option allows you to record your daily movements without having to change the activity settings every time you sit down or start walking.

To select an activity other than *Automatic*:

1. Press **Activity**, and select the activity you are going to perform.
2. Press **Start**, attach Nokia Fitness Monitor to your belt or waist band, and start the activity.
3. When you want to end the activity, press **Stop**.
Press  or  to view the statistics for the activity session.
4. Press **Resume** to resume the activity or **Exit** to return to the *Automatic* activity.

■ Adding and removing activities

You can manage the list of activities according to your needs. You can add the activities you need, and remove them later, if necessary. By default, only walking and running are present in the activity list when you switch Nokia Fitness Monitor on for the first time.

The *Automatic* activity is never listed, since it is always available by default.

1. Press **Activity** to access the activity list.
2. Select *Add* or *Remove*.

If you select *Add*, Nokia Fitness Monitor displays a list of activities that are not currently in the activity list. If you select *Remove*, Nokia Fitness Monitor displays a list of activities that are currently in the activity list.

3. Scroll through the list and select the activity you want to add or remove.



Important: When you remove an activity, the stored results for that activity remain in the memory and can be transferred to a compatible phone. However, you cannot view the results in the *RESULTS* menu.

You cannot remove the *Walking* and *Running* activities from the list.

■ Viewing data

You can view your fitness statistics for the current day, current week, current month and for the last 11 months.



The data gathered more than a year ago is automatically erased.

1. Press **Menu**, select *RESULTS* and scroll to the time period you want.

The total calories, steps and distance for the selected time period are displayed.

2. Press **View** and scroll to view the statistics for each activity type separately.



Tip: You can quickly compare your activities against your goals in the standby mode. Press  to see how many steps you have taken during the current day. The progress bar around the step number shows how close you are to achieving your daily goal. Press  again once to see the distance you have moved and twice to see the calories you have burned during the current day.

Continue to press  to see a graphical comparison of your last seven days' and last four weeks' activities against your daily goal. The bars represent your activities for each day (or week), and the horizontal line on the display represents your daily goal (or daily goal multiplied by seven).

Press  once more to see the current situation against your one-time goal.

■ Setting goals

You can set an on-going daily goal, and a one-time goal for a single activity session. You can set your goals to be a certain amount of used energy, or a certain distance, or a number of steps.

When you reach your one-time goal, Nokia Fitness Monitor beeps and displays a notification. When you confirm the notification by pressing **OK**, the monitor turns the one-time goal off. Define a new one-time goal to activate it again.

1. Press **Menu**, and select **GOALS** and *Daily goal* or *One time goal*.

2. Press **Select**, and select the goal type you want.
3. Set the goal, see [Using the menu and inserting data](#) on page 11.

Note that you cannot set the daily goal to 0.

To restore the default goals, press **Menu**, and select **GOALS** and **Default goals**. Press **Yes** to confirm. There is no default one-time goal, and the default daily goal is 10.000 steps.

■ Personal information

You can define personal information with Nokia Fitness Monitor for more precise information. Your personal information enables Nokia Fitness Monitor to calculate your calory consumption more accurately. In addition, you can define your walking and running step lengths for more exact information. A correctly defined step length ensures improved accuracy about the distance you have walked or run. For even more detailed distance information, you can calibrate your step length.

If you do not define your personal information, Nokia Fitness Monitor uses predefined default values.

Press **Menu** and select **PERS INFO**. Access the submenus under **PERS INFO** one by one, press **Change** and define your gender, date of birth, weight, and height. In the **Walking Step** and **Running Step** submenus, press **Change** and select **Enter** and define your step length for walking or running. For more information, see [Using the menu and inserting data](#) on page 11.

You can calibrate your step length for even more accurate measuring. Measure a 100 metre distance, press **Menu** and select *PERS INFO* and *Walking Step* or *Running Step*. Press **Change**, select *Calibrate* and press **Start**. You have approximately seven seconds to attach Nokia Fitness Monitor to your belt, before the device beeps. After the beep, start walking or running. When you have covered the 100 metres, stop and wait for approximately three seconds. The device beeps to show that the calibration is ready. You may also detach the device from your belt and press **Stop** to finish the calibration.

To restore the default step length, press **Menu**, and select *PERS INFO* and *Walking Step* or *Running Step*. Press **Change** and select *Default*.

After you have defined your gender, age, height and weight, Nokia Fitness Monitor automatically calculates your Body Mass Index (BMI) and Basal Metabolism Rate (BMR). The BMR shows how many calories your metabolism burns automatically even if you do not move at all. You can view these values in the *BMI and BMR* submenu under *PERS INFO*. When Nokia Fitness Monitor displays how many calories you have burned during your fitness activities, it only displays the calories that you have burned in addition to your BMR.

Nokia Fitness Monitor is designed for one-person use only. You can only store one set of personal information at a time.

■ General settings

Press **Menu**, and select *SETTINGS*. Access the submenus under *SETTINGS* one by one, and select the current time and date, energy and measurement units, display

language and tones the Nokia Fitness Monitor plays. For more information, see [Using the menu and inserting data](#) on page 11.

To reset the factory settings, press **Menu**, and select *SETTINGS* and *Factory settings*.

■ Using stopwatch and timer

Stopwatch

Using the stopwatch increases the demand on battery power and reduces the battery life.

1. Press **Menu**, select *EXTRAS* and scroll to *Stopwatch*.
2. Press **Start** to start timing.
3. Press **Split** to record a split time and **Stop** to stop timing.

After you have stopped timing, you can press **Resume** to continue timing with the existing split times or **Exit** to delete the existing split times.

Timer

1. Press **Menu**, select *EXTRAS* and scroll to *Timer*.
2. Press **Set** and enter the timer value.

When the timer expires, Nokia Fitness Monitor beeps, flashes and displays a notification.

■ Transferring data

You can transfer data between Nokia Fitness Monitor and a compatible mobile phone.

1. Press **Menu**, and select **DATATRANS**.
2. Press **Activate** to activate the IR port of Nokia Fitness Monitor.
3. Direct the IR ports of Nokia Fitness Monitor and the receiving compatible phone toward each other, and ensure that there are no obstructions between the devices. The maximum allowed distance is up to 0.5 metres and the transmission angle is 45.

Do not point the IR (infrared) beam at anyone's eye or allow it to interfere with other IR devices. This device is a Class 1 laser product.

4. Activate the transfer from the phone. For more information, refer to the user guide of the phone.

All the data stored in Nokia Fitness Monitor is transferred to the phone. When the transfer is ready, Nokia Fitness Monitor displays a success notification.

5. The IR port deactivates automatically after a while, but if you want to deactivate it immediately, press **Deactivate**.

4. Technical specifications

- Weight: 40 g
- Dimensions (diameter, thickness): 57 mm, 22 mm
- Operation time: 32 h
- Charging time: 2.5 h
- Operating temperature: from -15°C to 55°C
- Compatibility: Nokia Series 40 phones with IR connection and Fitness Coach functionality

5. Battery information

■ Charging and Discharging

Your device is powered by a rechargeable battery. The full performance of a new battery is achieved only after two or three complete charge and discharge cycles. The battery can be charged and discharged hundreds of times but it will eventually wear out.



Note: This device has a rechargeable battery that is not designed to be replaced by a consumer. For service of Nokia Fitness Monitor, take it to the nearest authorized service facility.

Recharge your battery only with Nokia approved chargers designated for this device.

Unplug the charger from the electrical plug and the device when not in use. Do not leave the battery connected to a charger. Overcharging may shorten its lifetime. If left unused, a fully charged battery will lose its charge over time. Temperature extremes can affect the ability of your battery to charge.

CARE AND MAINTENANCE

Your device is a product of superior design and craftsmanship and should be treated with care. The suggestions below will help you protect your warranty coverage.

- Keep the device dry. Precipitation, humidity and all types of liquids or moisture can contain minerals that will corrode electronic circuits.
- Do not use or store the device in dusty, dirty areas. Its moving parts and electronic components can be damaged.
- Do not store the device in hot areas. High temperatures can shorten the life of electronic devices, damage batteries, and warp or melt certain plastics.
- Do not store the device in cold areas. When the device returns to its normal temperature, moisture can form inside the device and damage electronic circuit boards.
- Do not attempt to open the device. Non-expert handling may damage it.
- Do not drop, knock, or shake the device. Rough handling can break internal circuit boards and fine mechanics.
- Do not use harsh chemicals, cleaning solvents, or strong detergents to clean the device.
- Do not paint the device. Paint can clog the moving parts and prevent proper operation.

All of the above suggestions apply equally to your device and charger. If any device is not working properly, take it to the nearest authorized service facility for service.

Free Manuals Download Website

<http://myh66.com>

<http://usermanuals.us>

<http://www.somanuals.com>

<http://www.4manuals.cc>

<http://www.manual-lib.com>

<http://www.404manual.com>

<http://www.luxmanual.com>

<http://aubethermostatmanual.com>

Golf course search by state

<http://golfingnear.com>

Email search by domain

<http://emailbydomain.com>

Auto manuals search

<http://auto.somanuals.com>

TV manuals search

<http://tv.somanuals.com>