

Nokia Multimedia Car Kit CK-20W User and Installation Guide

9245861
Issue 1 EN

DECLARATION OF CONFORMITY

Hereby, NOKIA CORPORATION, declares that this HF-20 product is in compliance with the essential requirements and other relevant provisions of Directive 1999/5/EC. The product is in conformity with the limits defined in Directive 2004/104/EC (amending Directive 72/245/EEC), Annex I, paragraph 6.5, 6.6, 6.8 and 6.9. A copy of the Declaration of Conformity can be found at http://www.nokia.com/phones/declaration_of_conformity/.

CE 0434



The crossed-out wheeled bin means that within the European Union the product must be taken to separate collection at the product end-of-life. Do not dispose of these products as unsorted municipal waste.

© 2006 Nokia. All rights reserved.

Reproduction, transfer, distribution or storage of part or all of the contents of this document in any form without the prior written permission of Nokia is prohibited.

Nokia, Nokia Connecting People, Pop-Port, and Navi are trademarks or registered trademarks of Nokia Corporation. Other product and company names mentioned herein may be trademarks or tradenames of their respective owners.

Bluetooth is a registered trademark of Bluetooth SIG, Inc.

Nokia operates a policy of continuous development. Nokia reserves the right to make changes and improvements to any of the products described in this document without prior notice.

Under no circumstances shall Nokia be responsible for any loss of data or income or any special, incidental, consequential or indirect damages howsoever caused.

The contents of this document are provided "as is". Except as required by applicable law, no warranties of any kind, either express or implied, including, but not limited to, the implied warranties of merchantability and fitness for a particular purpose, are made in relation to the accuracy, reliability or contents of this document. Nokia reserves the right to revise this document or withdraw it at any time without prior notice.

The availability of particular products may vary by region. Please check with the Nokia dealer nearest to you.

Export Controls

This device may contain commodities, technology or software subject to export laws and regulations from the US and other countries. Diversion contrary to law is prohibited.

9245861 / Issue 1 EN

Contents

For your safety.....	4	Control your music player.....	15
Quick start.....	5	Dismiss a calendar event alarm.....	16
The input device.....	5	Nokia Navigation Pack LD-2	16
Set up a Bluetooth wireless connection.....	6	Troubleshooting	16
First time setup with a phone.....	6	Connection issues	16
Connect the car kit manually to a paired phone.....	6	Audio issues.....	17
		Other issues	18
1. Introduction	7	4. Installation.....	19
2. Get started.....	8	Safety information.....	19
Parts	8	Connection options.....	20
Input device CU-8.....	9	Cable connection	20
Switch the car kit on or off.....	9	Bluetooth connection	21
Switch on	9	Audio connection.....	21
Switch off.....	9	Install the car kit in a vehicle.....	23
Connect your phone to the car kit	10	Hands-free unit HF-20.....	23
Cable connection	10	Input device.....	24
Bluetooth connection	10	Loudspeaker.....	25
Connect your music player to the car kit.....	12	Microphone.....	25
Cable connection	13	Power cable	26
Bluetooth connection	13	Connectivity cables	27
3. Operation.....	14	Mobile holder.....	28
Adjust the volume	14	Optional enhancements.....	28
Call handling.....	14	Nokia Navigation Pack LD-2.....	29
Make a call.....	14	Antenna coupler and external antenna.....	29
Answer a call.....	14	Check the operation of the car kit	29
End a call.....	14	Care and maintenance	30
Mute or unmute the microphone	15	Additional safety information.....	31
Switch the call between the car kit and phone	15		

For your safety

Read these simple guidelines. Not following them may be dangerous or illegal. Read the complete user guide for further information.

Your device and its enhancements may contain small parts. Keep them out of reach of small children.



SWITCH ON SAFELY

Do not switch the device on when wireless phone use is prohibited or when it may cause interference or danger.



ROAD SAFETY COMES FIRST

Obey all local laws. Always keep your hands free to operate the vehicle while driving. Your first consideration while driving should be road safety.



INTERFERENCE

All wireless devices may be susceptible to interference, which could affect performance.



SWITCH OFF WHEN REFUELING

Do not use the device at a refueling point. Do not use near fuel or chemicals.



SWITCH OFF NEAR BLASTING

Follow any restrictions. Do not use the device where blasting is in progress.



QUALIFIED SERVICE

Only qualified personnel may install or repair this product.



ENHANCEMENTS

Use only approved enhancements. Do not connect incompatible products.



CONNECTING TO OTHER DEVICES

When connecting to any other device, read its user guide for detailed safety instructions. Do not connect incompatible products.

Quick start

This section briefly describes the basic features of the car kit. For details, refer to the respective sections in this user guide.

■ The input device

Microphone mute key (1)

- Press to mute or unmute the microphone during a call.
- Press to make a Bluetooth connection to the paired music player when you are not in a call.
- While listening to music, press to pause or resume play on a music player that supports Bluetooth technology.

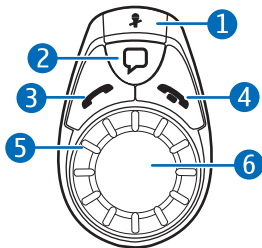

Voice dialing key (2)

- Press and hold for about 1 second to activate voice dialing with a compatible phone.

Call key (3)

- Press to answer a call or to switch between an active call and a call on hold.
- Press twice to redial the last dialed number.

End key (4)

Press to end or reject a call.

Indicator light (5)

Shows the status of the car kit.

Navi™ wheel (6)

- Press and hold for about 1 second to switch the active call between car kit and phone (in a Bluetooth connection).

- Turn to left or right to adjust the volume during a call or while listening to music from your music player.
- Press briefly and turn to right or left to move to the next or previous track in a music player.
- When using the navigation enhancement, turn to right or left to adjust the volume and repeat the last driving instruction.

■ Set up a Bluetooth wireless connection

First time setup with a phone

1. Switch on your phone and car kit (see p. 9).
2. Activate the Bluetooth feature on your phone, and set the phone to search for Bluetooth devices.
3. Select the car kit (Nokia CK-20W) from the list of found devices.
4. Enter the Bluetooth passcode 0000 to pair and connect the car kit with your phone. If necessary, confirm the connection on the phone.

To connect the car kit with a music player, see p. 12.

Connect the car kit manually to a paired phone

If you have paired your phone with the car kit, press and hold the Navi wheel for about 1 second. The car kit beeps when it connects to the phone.

1. Introduction

The Nokia Multimedia Car Kit allows you to conveniently make and answer calls hands-free and use your compatible music player in a car.

You can also use the car kit with the Nokia Navigation Pack LD-2 that guides you to your destination with spoken driving instructions and map displays or maneuver icons shown on the screen of your mobile phone. The navigation pack can be purchased separately.

The car kit can be connected to a compatible phone and music player using a cable or a Bluetooth wireless connection.

Read this guide carefully before having the car kit professionally installed and using it. Also read the user guide for your phone, which provides important safety and maintenance information, and the user guide for your music player.

The setup and operation of the car kit are described in Get started p. 8 and Operation p. 14.

The installation of the car kit is described in Installation p. 19. The car kit should only be installed by a qualified service technician using the approved original Nokia parts supplied in the sales package.

2. Get started



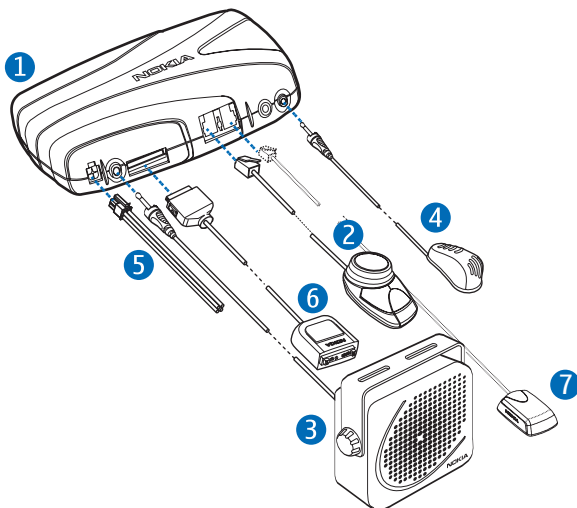

■ Parts

The car kit contains the following parts:



- Hands-free unit HF-20 (1)
- Input device CU-8 (2)
- Loudspeaker SP-3 (3)
- Microphone MP-2 (4)
- Power cable PCU-4 (5)
- Connectivity cables (6); all the cables are not shown in the figure
- GPS receiver (7) is included in the Nokia Navigation Pack LD-2 (sold separately)

Input device CU-8

- Microphone mute key  (1)
- Voice dialing key  (2)
- Call key  (3)
- End key  (4)
- Indicator light (5)
- Navi wheel (6)

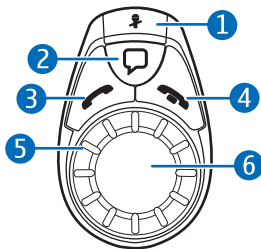

■ Switch the car kit on or off

Switch on

If the ignition sense wire is not connected, press the Navi wheel if you use a Bluetooth connection, or connect the phone to the car kit using the supplied connectivity cable.

If the ignition sense wire is connected, turn on the car ignition, press the Navi wheel (if you use a Bluetooth connection), or connect the phone to the car kit using the supplied connectivity cable.

When the car kit is switched on, the indicator light of the input device is shown.

Switch off

If the ignition sense wire is not connected, disconnect the phone from the car kit. The car kit switches off after 2 minutes. When the car kit switches off, the indicator light of the input device goes off. After you turn off the car ignition, do not leave the phone connected to the car kit to prevent accidental draining of the car battery.

If the ignition sense wire is connected, turn off the car ignition. If you turn off the ignition during a call or while listening to music from the music player of the phone through the car kit, the car kit switches off after you end the call, stop listening to the music player, or disconnect the phone from the car kit (see p. 12).

■ Connect your phone to the car kit

You can connect a compatible mobile phone to the car kit using a cable or a Bluetooth connection, depending on how the car kit was installed. See p. 20 for the available installation options.

Cable connection

To connect a compatible phone to the car kit, place the phone into a compatible mobile holder (sold separately) that is connected to the car kit with a compatible connectivity cable, or plug the connectivity cable directly into the phone. To disconnect the phone from the car kit, remove the phone from the mobile holder, or unplug the connectivity cable from the phone.

If you use a universal mobile holder, you may need to connect the connectivity cable directly into your phone after placing the phone in the holder.

When the phone is connected to the car kit using a compatible connectivity cable that supports charging (such as the CA-76), the car kit also charges the phone battery.

When the car kit is connected to the phone with a cable, you cannot connect the phone to the car kit using Bluetooth technology for hands-free operation.

Bluetooth connection

Bluetooth wireless technology makes it possible to connect compatible devices without using cables. A Bluetooth connection does not require that the two devices be in line of sight, but both devices should be within 10 meters (30 feet) of each other. Connections can be subject to interference from obstructions, such as walls, or other electronic devices.

The car kit is compliant with Bluetooth Specification 1.2 supporting the following profiles: Handsfree Profile 1.5, Advanced Audio Distribution Profile (A2DP) 1.0, and Audio/Video Remote Control Profile (AVRCP) 1.0. Check with the manufacturers of other devices to determine their compatibility with this device.

There may be restrictions on using Bluetooth technology in some locations. Check with your local authorities or service provider.

Set up a connection with your phone

For a Bluetooth connection, you need a compatible mobile phone that supports Bluetooth technology. When the phone is in a Bluetooth connection with the car kit, you can keep your phone, for example, in a bag, while using the car kit. To charge the battery in your compatible Nokia phone while using the car kit, connect the phone through a charging cable to the car kit.

Before you can connect your phone to the car kit using Bluetooth technology, you must associate (pair) the car kit with the phone. Do as follows:

1. Switch on the phone and the car kit (see p. 9).
2. Activate the Bluetooth feature on your phone, and set the phone to search for Bluetooth devices. See the user guide of your phone for instructions.
3. Select the car kit (Nokia CK-20W) from the list of found devices.
4. Enter the Bluetooth passcode 0000 to pair and connect the car kit to your phone. In some phones you may need to confirm the connection after pairing. See the user guide of your phone for details. You only need to pair the car kit with your phone once.

If the pairing is successful, the car kit sounds a high beep and appears in the phone menu where you can view the currently paired Bluetooth devices. The car kit is now paired with and connected to the phone and ready for use. If the pairing fails, the car kit sounds a low beep. Try to pair again by carefully following the pairing instructions.

You can pair the car kit with up to eight phones and music players in total but connect it to only one phone and one music player at a time.

The car kit can connect to a paired phone only if the phone is switched on and has the Bluetooth feature activated.

Connect the car kit manually

When the car kit is switched on and you have not connected a phone to it, you can set the car kit to search for paired phones.

To start the search, press and hold the Navi wheel for about 1 second. During the search, the indicator light of the input device flashes. The car kit first tries to connect to the phone that was used with it most recently. If this fails, the car kit tries to connect to one of the other Bluetooth devices that have been most recently paired with it. The car kit beeps when it connects to the phone.

Connect the car kit automatically

You can set your phone to allow an automatic connection with the car kit when the car kit is switched on. To do this in Nokia phones, change your paired device settings in the Bluetooth menu.

When you switch on the car kit and no phone is connected to it with a cable, within 45 seconds, the car kit tries to make a Bluetooth connection to the last used phone. If this fails, the car kit tries to connect to one of the other Bluetooth devices that have been most recently paired with it.

Disconnect the car kit

To disconnect the car kit from your phone, close the Bluetooth connection with the car kit in the Bluetooth menu of your phone or switch off the car kit.

You do not need to delete the pairing with the car kit to disconnect it.

Clear the list of paired devices

The car kit saves the pairing information about the last eight Bluetooth devices that have been paired with it. To clear this information, switch off the car kit, and press and hold the Navi wheel for 10 seconds. The car kit beeps.

■ Connect your music player to the car kit

You can connect a compatible music player to the car kit using a cable or Bluetooth connection, depending on how the car kit was installed. See p. 20 for the available installation options.

Cable connection

Connect a compatible music player to the car kit using the connectivity cable that has a 3.5-mm audio plug. You can now start to use the music player with the car kit.

If you do not want to connect a music player to the car kit, you can attach the connectivity cable with the supplied clip to the desired location in your car.

Bluetooth connection

You can use the car kit with a compatible music player and phone at the same time through a Bluetooth connection.

For a Bluetooth connection, you need a compatible music player that supports Bluetooth technology.

Before you can connect your music player to the car kit using Bluetooth technology, you must pair the car kit with the player. Do as follows:

1. Switch on the music player and the car kit.
2. Follow the pairing instructions in the user guide for your music player. When the music player asks for a device to pair, select the car kit from the list of found devices. If you are asked for a Bluetooth passcode, enter 0000 on the music player.

If your music player does not have a keypad, the device may use the Bluetooth passcode 0000 by default. If this is not the case, see the user guide of your music player to change the default Bluetooth passcode to 0000.

The car kit is now paired with and connected to the music player and ready for use.

You can pair the car kit with up to eight phones and music players in total but connect it to only one phone and one music player at a time.

Connect the car kit manually

If you have paired the car kit with a compatible music player (or a compatible Nokia phone with a music player feature), press  to make a Bluetooth connection to the paired device when no call is in progress.

3. Operation

■ Adjust the volume

To adjust the car kit volume during a call or while listening to music from your music player, turn the Navi wheel to left or right.

■ Call handling



Make a call

To make a call when the car kit is connected to your phone, use your phone in the normal way. To cancel the call attempt, press .





To redial the last dialed number, press  twice while no call is in progress if your phone supports the use of this feature with the car kit.

To activate voice dialing if your phone supports this function with the car kit, press and hold  for about 1 second while no call is in progress. Proceed as instructed in the user guide of your phone.

Answer a call

To answer a call, press , or use the phone keys. To reject an incoming call, press , or use the phone keys.

If the automatic answer function is set on in your phone, the phone automatically answers the call after one ring.

If you have activated the call waiting feature in your phone, press  or use the phone keys to answer another call during a call. The first call is put on hold. To switch between the calls, press . To end the first call and answer the new one, press  and then .

End a call

To end all the currently active and held calls, press , or use the phone keys.

Mute or unmute the microphone

To mute or unmute the microphone during a call, press . When you mute the microphone, the car kit sounds a low beep. When you unmute the microphone, the car kit sounds a high beep.

Switch the call between the car kit and phone

If you have connected a compatible phone to the car kit using a connectivity cable, remove the phone from the mobile holder or use the phone keys to switch the call from the car kit to the phone. To switch the call back to the car kit, place the phone in the holder.

If you have connected a compatible phone to the car kit using Bluetooth technology, to switch the call between the car kit and phone, press and hold the Navi wheel for about 1 second, or use the respective function in your phone.

■ Control your music player

If you have paired the car kit with a compatible music player (or a compatible Nokia phone with a music player feature), press  to make a Bluetooth connection to the paired device when you are not in a call.

If you have connected the car kit to a music player (or a mobile phone with a music player feature) using a connectivity cable, see the user guide of the music player (or phone) for information on the music playback controls.

When you have connected the car kit to a compatible music player (or a compatible Nokia phone with a music player feature) through a Bluetooth connection, press  to pause or resume music playback. To move to the next or previous track, press the Navi wheel briefly, and within 3 seconds, turn the Navi wheel right or left.

If you hear a driving instruction of the navigation software while using the music player, the player is muted until the instruction ends.

When you use the music player feature of your phone, you may be able to make and answer calls at the same time. See the user guide of your phone for details.

When the ignition sense wire is connected, pause or switch off the music player (or the music player feature of your phone) or disconnect the music player or phone from the car kit after you turn off the car ignition to prevent accidental draining of the car battery.

■ Dismiss a calendar event alarm

When your phone alerts for a calendar event, press  to dismiss the alarm if your phone supports the use of this feature with the car kit. For more information on using the calendar, see the user guide of your phone.

■ Nokia Navigation Pack LD-2

If you use the car kit with this enhancement, you can view map information on the phone display and hear spoken driving instructions from the car kit speaker or car radio system. To adjust the volume or repeat the last driving instruction, turn the Navi wheel.

■ Troubleshooting

Connection issues

I cannot connect the car kit to my phone through a Bluetooth connection.

- Ensure that the car kit is switched on and paired with your phone.
- Check that the Bluetooth feature is activated on your phone.
- Ensure that there is no phone connected to the car kit with a connectivity cable.

The car kit does not establish a Bluetooth connection to my paired phone when I turn on the ignition or switch on the car kit.

- Check that the Bluetooth feature is activated on your phone.
- Ensure that your phone is set to connect to the car kit automatically when the car kit is switched on.

My car radio does not have a stereo or auxiliary input.

Ask the technician who installs the car kit to use an adapter that allows to connect the stereo outputs of the car kit to some other input on the car radio (such as the cd changer connector) for stereo sound.

I cannot pair my compatible music player with the car kit.

Check that the Bluetooth passcode of the music player is 0000. If this is not the case, change the passcode to 0000 as instructed in the user guide of the music player.

Audio issues**The caller cannot hear my voice during a call.**

- Check that the car kit microphone is not muted.
- Ensure that the phone is properly connected to the car kit with a connectivity cable or through a Bluetooth connection.

The audio quality is not good or I cannot hear sound.

- If you are using a cable connection, ensure that the connectivity cable is properly plugged into your phone.
- If the car kit is connected to the car radio, check that the car radio volume is set properly.

Also check that the car kit uses the left channel of the stereo output connector. The mono output of the car kit is designed for use with a loudspeaker and does not work properly when connected to a car radio.

- If the car kit is connected to the supplied loudspeaker, check that the car kit volume is set properly.

The car kit does not play sound in stereo.

- Set the car kit to the stereo mode. See Set the mono or stereo mode p. 22.
- Check that the car radio is set to receive audio through the stereo input.
- Check that you have selected the correct audio source in the car radio.

- Check that the car radio volume is set properly.

The sound quality of the music player is similar to a phone call.

- Check that the mono/stereo mode setting matches the selected installation option. See Select the installation option p. 21 and Set the mono or stereo mode p. 22.
- If you use the music player feature of your phone, check that your phone model is shown on the compatibility list in the support area of the car kit at www.nokia.com.

I cannot hear music played with the music player when the phone or music player is connected to the car kit.

- If you use the music player feature of your phone, check that your phone model is shown on the compatibility list in the support area of the car kit at www.nokia.com.
- Check that the phone or music player is properly connected to the car kit.
- Check that the car kit is properly connected to the stereo input on your car radio. See Select the installation option p. 21, or consult with the technician who installed the car kit.
- Ensure that the car kit is set to the stereo mode. See Set the mono or stereo mode p. 22.

The car radio is not muted when I answer a call or hear a driving instruction from the Nokia Navigation Pack LD-2.

Ask the technician who installed the car kit to ensure that the mute line is properly connected.

Other issues

The car kit does not switch on when I turn on the car ignition.

Ask the technician who installed the car kit to ensure that the ignition sense wire is properly connected.

The phone battery does not charge when the phone is connected to the car kit.

Check that all the cables are properly connected.

4. Installation

■ Safety information

Observe the following safety guidelines when installing the car kit.

- Only a qualified service technician should install or service the car kit using the approved original Nokia parts supplied in the sales package. Faulty installation or service may be dangerous and may invalidate any warranty which may apply to the car kit.

End users should remember that the car kit comprises complex technical equipment that requires professional installation using special tools and expert know-how.

- Instructions given in this guide are general guidelines which apply for the installation of the car kit in an automobile. However, due to the wide variety of car types and models available on the market, this guide cannot consider the individual technical requirements relevant for any particular vehicle. Contact the vehicle manufacturer for detailed information about the vehicle in question.
- The car kit is suitable for use only in vehicles with 12 V negative grounding. Use on other supply voltages or alternative polarity will damage the equipment.
- Remember that modern automotive systems include on-board computers where key vehicle parameters are stored. Improper disconnection of the car battery may cause loss of data, necessitating extensive effort for re-initialization of the system. If you have any concerns, contact your car dealer before any installation work is done.
- Do not wire the car kit equipment to the high-voltage lines of the ignition system.
- When installing the parts of the car kit ensure that none of them interfere with or hinder the steering or braking systems or other controls or systems used in the operation of the vehicle (for example, airbags). Ensure that the car kit and any of its components are not

installed where you might come in contact with it in the event of an accident or collision.

When mounting a mobile holder, ensure that the phone display is clearly visible for the user.

- Your service technician or dealer may be able to provide you with information on alternatives for mounting the equipment suitably in your vehicle without requiring bore holes.
- Do not smoke when working on the car. Ensure that there is no source of fire or flame nearby.
- Take care not to cause damage to electrical cables, fuel or brake lines, or safety equipment during installation work.
- RF signals may affect improperly installed or inadequately shielded electronic systems in motor vehicles such as electronic fuel injection systems, electronic antiskid (antilock) braking systems, electronic speed control systems, and airbag systems. Should you notice a fault or change in the operation of such a system, contact your car dealer.
- Ensure that cables are placed so that they will not be subject to mechanical wear and tear (for example, not laid under car seats or over sharp edges).

■ Connection options

The car kit can be connected to a compatible mobile phone or music player using a cable or Bluetooth wireless technology. Audio connection can be made between the car kit and a compatible car radio system in several ways.

Cable connection

The car kit can be supplied with several connectivity cables that have different plugs. The cables can have, for example, a Pop-Port™ plug or a charging and a 3.5-mm audio plug. Select the cable according to the devices that are used with the car kit. For more information about the cables, see Connectivity cables p. 27.

Bluetooth connection

For a Bluetooth wireless connection, the user needs a compatible mobile phone supporting Bluetooth technology. For more information, see p. 10 and 21.

Audio connection

The audio outputs of the car kit can be connected to the audio inputs of the car radio system in several ways. To set the car kit into the mono or stereo mode depending on the selected installation option, see Set the mono or stereo mode p. 22.

Select the installation option

To enable the use of the car kit with a car radio system, select one of the following installation options depending on the features of the car radio system that you connect to the car kit.

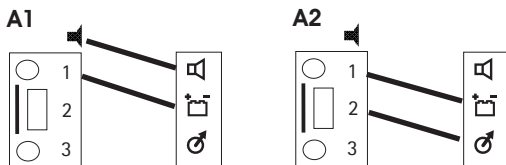

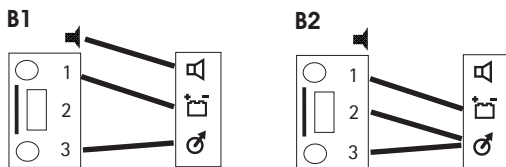

Installation options with mono audio



Installation options with stereo audio

- —Loudspeaker supplied with the car kit
- 1—Car radio mute

- 2—Mono/phone input of the car radio
- 3—Stereo/auxiliary input of the car radio
- —Mono output of the car kit
- —Car kit mute; also see Power cable p. 26
- —Stereo output of the car kit

If you cannot connect the stereo output of the car kit to the stereo/auxiliary input of the car radio (for example, to play music from the car kit in stereo), select the A1 or A2 option, and set the audio mode to mono. If the car radio has a mono/phone input, select the A2 option. Otherwise select the A1 option and use the loudspeaker supplied with the car kit. If the car radio does not have a mute connector, you can leave the mute line unconnected. For more information, see Power cable p. 26.

If you connect the car kit to a stereo/auxiliary input (an aux-in or cd changer connector) of the car radio, select the B1 or B2 option, and set the audio mode to stereo. If the car radio has a mono/phone input, you can select the B2 option to use the car speakers for better audio quality. If the car radio does not have a mute connector, you can leave the mute line unconnected. Do not connect the car radio to the mono output of the car kit. The mono output is designed to be used with a loudspeaker and does not work properly when connected to a car radio.

If you select an installation option that uses the supplied loudspeaker, voice calls, ringing tones, and navigation instructions can be heard even if the car radio is switched off. Instead of using the supplied loudspeaker, you can connect to the car kit one of the car speakers with a relay if the impedance of the speaker is at least 4 ohms. In this case, connect the mute connector to the relay as well. If the impedance is over 8 ohms, the output power is significantly lower than normally.

Set the mono or stereo mode

Set the car kit to the mono mode (default setting) or the stereo mode depending on the selected installation option. To switch between the modes, switch off the car kit if it is on, press the Navi wheel, and within 5 seconds, press and hold  for 10 seconds.

When you switch to the mono mode, the car kit sounds a high beep, and the indicator light flashes slowly for a few seconds.

When you switch to the stereo mode, the car kit sounds a low beep, and the indicator light flashes in the rhythm of the beeps.

■ Install the car kit in a vehicle

This section describes how to install the car kit parts in a vehicle. The parts are explained in Parts p. 8.

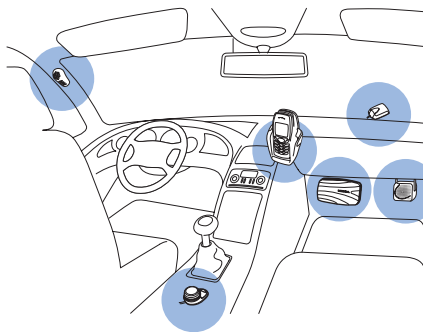





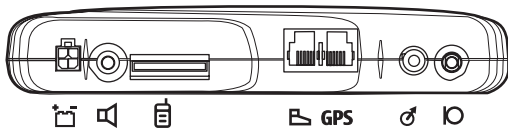

Example of appropriate installation, including the optional GPS receiver at the top of the dashboard

Hands-free unit HF-20

The hands-free unit has the following connectors. The symbols are printed at the bottom of the unit.



-  —Dc power connector for the power cable PCU-4
-  —Mono audio output for the loudspeaker SP-3

- —Connector for a connectivity cable
- —Connector for the input device CU-8
- **GPS**—Connector for the GPS receiver
- —Stereo audio output for a car radio system
- —Connector for the microphone MP-2

When you install the hands-free unit, ensure that the cables for the microphone and loudspeaker reach the places where you intend to mount these parts.

Do not mount the hands-free unit inside a metal housing or on a metal surface because this will impair the Bluetooth connection between the hands-free unit and the Bluetooth device that is connected to the car kit. For an optimal connection, ensure that the distance between the hands-free unit and a metal surface is over 4 mm (0.16 inch).

To mount the hands-free unit, use the hook and loop tape pads supplied with the car kit in the same way as with the input device (see the figures in Input device starting from p. 24). Detach the two pads from each other. Attach the pad with the loops first: peel off the protective sheet from the adhesive side, and attach the pad to the desired location in the car. Ensure that the surface where you attach the pad is dry and free from dirt and dust.

To attach the pad with the hooks, peel off the protective sheet from the adhesive side, and attach the pad to the underside of the hands-free unit.

Press the hands-free unit firmly onto the loop pad, and check that the hands-free unit stays securely in place.

Input device

The input device should be located so that it is within easy reach of the user. When installing the parts of the car kit ensure that none of them interfere with or hinder the steering or braking systems or other controls or systems used in the operation of the vehicle (for example, airbags).

Ensure that the input device cable reaches to the hands-free unit for connection. The best location to mount the input device is horizontally

on the console between the driver's and front passenger's seat so that the input device keys are toward the front of the vehicle.

To mount the input device, use the hook and loop tape pads supplied with the car kit. Detach the two pads from each other (1). Attach the pad with the loops first: peel off the protective sheet from the adhesive side (2), and attach the pad to the desired location in the car. Ensure that the surface where you attach the pad is dry and free from dirt and dust.

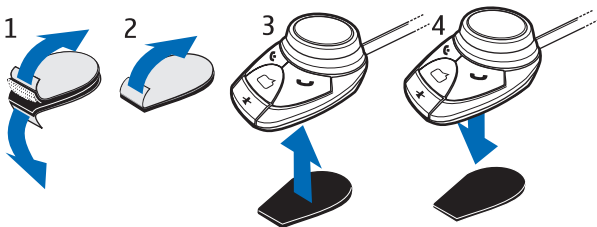

Attach the pad with the hooks: peel off the protective sheet from the adhesive side (2), and attach the pad to the underside of the input device (3).

Press the input device (4) firmly onto the loop pad, and check that the input device stays securely in place.

Loudspeaker

For good acoustic quality, mount the loudspeaker so that it points toward the user. Mount the loudspeaker at least 1 meter (3 feet) away from the microphone to avoid audio feedback.

Connect the loudspeaker to the mono output of the car kit. The car kit can be connected to a compatible car radio system. For details, see Audio connection p. 21.

Microphone

Select the mounting location of the microphone carefully to increase the quality of voice transmission.

Mount the microphone about 30 cm (11.8 inches) from the driver's head, and position it so that it points toward the driver's mouth. Experience has shown that the best mounting locations are near the rear view mirror or the sun visor. Mount the microphone at least 1 meter (3 feet) away from the car kit loudspeaker to avoid audio feedback.

Mount the microphone so that it is not exposed to air streams from the vents. Do not place the microphone cable in the heating, ventilation, or air-conditioning system. Use the supplied double-sided adhesive tape to fix the microphone to reduce the amount of background noise of the car that can interfere with your calls.

Insert the microphone plug into the microphone connector on the hands-free unit, and turn the plug clockwise to lock it firmly. Use of any other microphone than the microphone MP-2 supplied with the car kit may impact the audio quality.

Power cable

The power cable has the following wires and fuses:

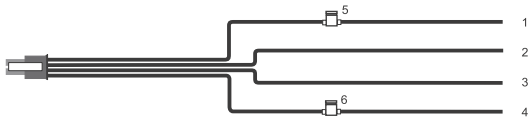

- +12 V, car battery +, red (1)
- Ground, car battery -, black (2)
- Car radio mute, yellow (3)
- Car ignition sense, blue (4)
- 2 A fuse (5)
- 1 A fuse (6)

To connect the power cable, do as follows:

1. Connect the black wire to the vehicle ground.
2. Plug the yellow wire into the mute connector of the car radio.

When a call is answered, the car kit switches the yellow wire to ground, muting the car radio. When the call is ended, the yellow wire is separated from ground, and the car radio is unmuted.

If the car radio does not have a mute connector, this wire can be left unconnected. In this case, the car radio is not muted automatically when you answer a call.

Alternatively, an additional relay can be used to mute the car radio and to connect the car kit directly to the car speakers. The mute signal is used to switch the relay.

3. Connect the blue wire to the ignition sense line of the car using the supplied 1 A fuse.

Some vehicles do not support the ignition sense connection. In this case the blue wire can be left unconnected but the car kit does not switch off automatically when the car ignition is turned off.

When the ignition sense wire is not connected, the car kit automatically switches off after two minutes if it is not connected to the phone to prevent accidental draining of the car battery.

4. Connect the red wire to the positive terminal of the 12 V car battery using the supplied 2 A fuse.
5. Plug the four-pin plug of the power cable into the dc connector of the hands-free unit.

Connectivity cables

The car kit can be supplied with several connectivity cables that have different plugs. The cables can have, for example, a Pop-Port plug or a charging and a 3.5-mm audio plug. Select the cable according to the devices that are used with the car kit.

Select the cable with the Pop-Port plug to connect the car kit to a compatible phone with a Pop-Port connector and to charge the phone battery from the car battery while using the car kit. When you use this cable, the car kit can only be used with a music player through a Bluetooth connection.

Select the cable with the charging and 3.5-mm audio plugs to connect the car kit to a compatible phone through a Bluetooth connection and to a music player that has a compatible 3.5-mm audio connector. You can connect the charging plug to a compatible phone to charge the phone battery from the car battery while using the car kit.

To connect the cable, carefully insert the end indicated with the TOP text to the  connector on the hands-free unit so that the text is upwards. If you use the cable with the Pop-Port plug, insert the plug to the Pop-Port connector of a mobile holder designed for the phone (the phone connects to the car kit when placed in the holder). If you use the cable with the charging and 3.5-mm audio plugs, insert the charging plug to the phone and the audio plug to the music player.

If you use a cable that has several plugs, you can bend away the unused wires to hide them. Ensure that the unused wires do not touch each other to avoid a short-circuit.

Mobile holder

If the phone is connected to the car kit with a cable, you need to mount a mobile holder designed for the phone that is used with the car kit.

When mounting a mobile holder, ensure that the phone display is clearly visible for the user and that the holder does not interfere with or hinder the steering or braking systems or other controls or systems used in the operation of the vehicle (for example, airbags). For mounting instructions, see the documentation that came with the mobile holder.

If you use a universal holder (a holder that can be used with different phone models), you may have to plug the connectivity cable directly into the phone after placing the phone in the holder.

■ Optional enhancements

You can extend the features of the car kit with optional enhancements. Consult your dealer or service technician for suitable enhancements for the car kit. Use only approved and compatible enhancements.

Nokia Navigation Pack LD-2

This enhancement includes a GPS receiver you mount in a car and a navigation software that you install in a mobile phone.

Use a sticky tape at the bottom of the GPS receiver to mount the GPS receiver on a location with a clear view to the sky, for example, the upper side of a dashboard. Mount the GPS receiver so that its upper side points to the sky.

When the GPS receiver is mounted, plug it to the GPS receiver connector on the hands-free unit. See Hands-free unit HF-20 p. 23.

For information on using the navigation software, see the user guide for the Nokia Navigation Pack LD-2.

Antenna coupler and external antenna

An antenna coupler can be used to connect an external antenna to the car kit. The external antenna improves the reception of the mobile phone in a car. For availability, contact your dealer.



Note: In order to comply with RF exposure guidelines, install the external antenna so that a minimum distance of 20 cm can be maintained between the external antenna and all persons, with external antenna gain not exceeding 3 dBi.

■ Check the operation of the car kit

After the car kit has been installed, check that it is working properly. Also ensure that the car kit is mounted properly. See also Troubleshooting p. 16.

Care and maintenance

Your car kit is a product of superior design and craftsmanship and should be treated with care. The suggestions below will help you protect your warranty coverage.

- Keep all enhancements out of the reach of small children.
- Keep the car kit dry. Precipitation, humidity and all types of liquids or moisture can contain minerals that will corrode electronic circuits.
- Do not use or store the car kit in dusty, dirty areas. Its moving parts and electronic components can be damaged.
- Do not attempt to open the car kit. Non-expert handling may damage it.
- Do not use harsh chemicals, cleaning solvents, or strong detergents to clean the car kit parts.
- Do not paint the car kit parts. Paint can clog the moving parts and prevent proper operation.

If the car kit is not working properly, take the defective part to your nearest authorized service facility for service.

Additional safety information

■ Vehicles

RF signals may affect improperly installed or inadequately shielded electronic systems in motor vehicles such as electronic fuel injection systems, electronic antiskid (antilock) braking systems, electronic speed control systems, and air bag systems. For more information, check with the manufacturer or its representative of your vehicle or any equipment that has been added.

Faulty installation or service may be dangerous and may invalidate any warranty that may apply to the device. Check regularly that all wireless device equipment in your vehicle is mounted and operating properly. Do not store or carry flammable liquids, gases, or explosive materials in the same compartment as the device, its parts, or enhancements. For vehicles equipped with an air bag, remember that air bags inflate with great force. Do not place objects, including installed or portable wireless equipment in the area over the air bag or in the air bag deployment area. If in-vehicle wireless equipment is improperly installed and the air bag inflates, serious injury could result.

Free Manuals Download Website

<http://myh66.com>

<http://usermanuals.us>

<http://www.somanuals.com>

<http://www.4manuals.cc>

<http://www.manual-lib.com>

<http://www.404manual.com>

<http://www.luxmanual.com>

<http://aubethermostatmanual.com>

Golf course search by state

<http://golfingnear.com>

Email search by domain

<http://emailbydomain.com>

Auto manuals search

<http://auto.somanuals.com>

TV manuals search

<http://tv.somanuals.com>