

Owner's Manual

MEDIAMASTER 9200 S 9600 S

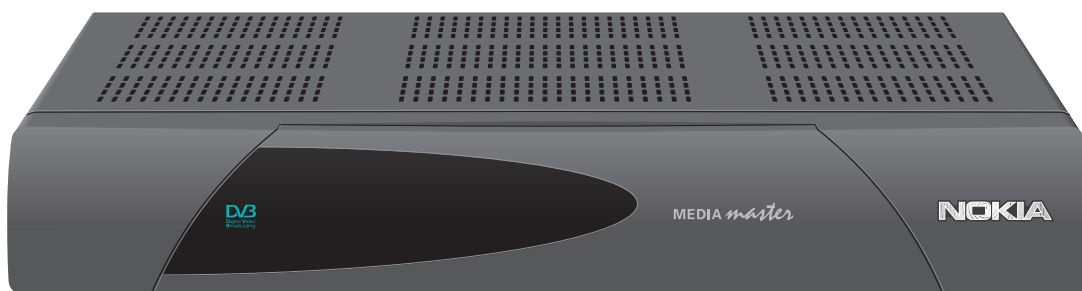

NOKIA
CONNECTING PEOPLE

Important Information

Wiring the plug (UK and Eire only)

The mains lead on this product is already fitted with a non-rewireable (moulded) plug incorporating a fuse, the value of which is indicated on the pin face of the plug. Should the fuse need to be replaced, an ASTA or BSI approved BS 1362 fuse must be used of the same rating, marked thus:

If the fuse cover is detachable always refit the cover after replacing the fuse. NEVER use the plug with the fuse cover omitted.

If the fitted plug is not suitable for your socket outlets it should be cut off, after having first removed the fuse, and an appropriate plug fitted in its place. If this new plug contains a fuse its value should be the same as that removed from the non-rewireable plug.

The severed plug must be destroyed immediately to avoid the possible shock hazard should be inserted into a 13A socket elsewhere.

If you need to replace the mains plug then follow the instruction given below: The wires in the mains lead are coloured in accordance with the following code: BLUE - Neutral (N); BROWN - Live (L).

As these colours may not correspond with the coloured markings identifying the terminals in your plug, proceed as follows:

The wire coloured BLUE must be connected to the terminal marked with the letter N or coloured BLUE or BLACK.

The wire coloured BROWN must be connected to the terminal marked with the letter L or coloured BROWN or RED.

On no account either of these wires to the terminal marked E or coloured GREEN or GREEN and YELLOW.

Before replacing the plug cover, make certain that the cord grip is clamped over the sheath of the lead; not simply over the two wires.

If in doubt, consult a competent electrician.

Mediamaster 9200 S and 9600 S

The sky is the limit with your Mediamaster. It's easy to use, always at your command and adaptable for future advances.

To begin with, you will find it necessary to read these instructions but you will soon find yourself competent without them.

Contents

For your safety	3
Rear panel, Front panel	4
Installation of the Mediamaster	5
Connecting the Mediamaster to different units	5
Preparing the remote control	7
Switching on for the first time	8
Before you continue	8
Remote control	9
About the Smart Card and CA Module	10
Basic Settings	11
The Welcome Menu	11
Antenna configuration	11
Channel Search	12
SMATV or IF frequency channel search	15
Viewing TV	16
Important general information	16
Start/stop watching TV	16
Select Channel	16
Programme Information. The "i" Button	16
TV Guide	17
The Radio button 	17
List of TV channels / Radio channels	18
Video recorder	19
Analogue Receiver	19
Subtitling and Teletext. The TEXT button	19
Settings from the Main Menu	20
The TV Guide and Radio Guide	20
Parental Control	21
Installation Submenus	22
Antenna Configuration and Channel Search	22
Advanced Channel Search	22
Edit TV and Radio Channels	23
Language Settings	23
System Settings	23
Receiver upgrade	24
Automatic Installation	24
Symbols on the Mediamaster display	24
Glossary of terms	25
Problem solvings	26
Technical Specifications	27

For your safety

- **Keep a clear space around the Mediamaster to allow for sufficient ventilation.**
- **Do not cover the Mediamaster or place it on a unit that emits heat.**
- Use a soft cloth and a mild solution of washing-up liquid to clean the casing.
- Nokia is proud to offer a high quality product. To keep this level of quality, service should be carried out only at a Nokia authorised service centre.
- Do not connect or modify cables when the Mediamaster is plugged in.
- Do not remove the cover.
- Do not allow the unit to be exposed to hot, cold or humid conditions.
- Please note that the only way to isolate the Mediamaster completely from the 230 V mains supply is to unplug the mains lead!

We reserve the right to change specifications.
Please be aware that new software can change
the functionality of the Box.

DiSeQTM is a trademark of EUTELSAT

The EMC Directive 89/336/EEC is applied to this product.

Rear panel

Mains lead
230 V AC
+/- 15%,
50 Hz

0/12 VOLT
for an
external LNB
switch

TV SCART
for the audio /
video input of
the TV set

SAT SCART
for an analogue
receiver

LNB *
Satellite dish
input (F-
connector)

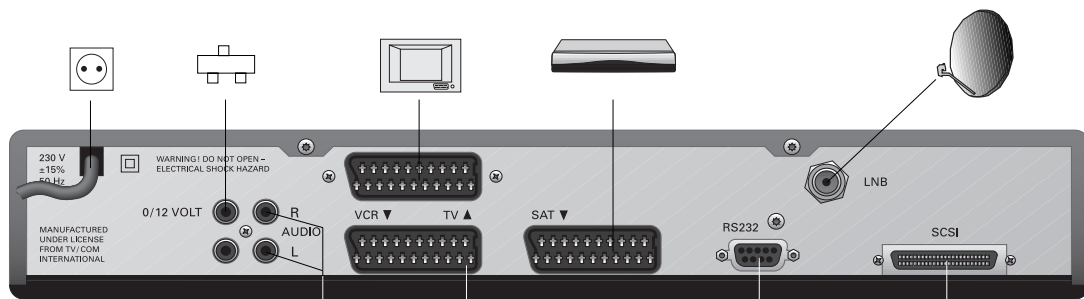

AUDIO L R
Stereo outputs
for connection
to a HiFi system

VCR SCART
for a video
recorder

RS232
for a printer,
PC or a high
speed modem

SCSI
For a CD-ROM
player or other
high-speed data
equipment

** LNB cables also feed the LNB with a supply voltage of 13/18 V (V/H polarisation) and a 0/22 kHz signal for LNB switch*

Front panel

Display

shows programme information.

At start up, it displays software and boot/loader number



Slot
for the CA module
and the Smart Card
(9600 S)

Slot
for the Smart Card
(9200 S)

Power
to turn the
receiver on/
off (standby)

Channel
Select channel
number, up/down

Installation

The box for your Mediamaster should contain the following items:

- the Mediamaster
- a remote control handset with batteries.
- a fully featured SCART cable which can be used to connect your Mediamaster to the TV or video recorder.
- Owner's Manual.

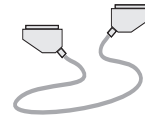

SCART cable

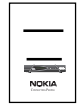

About the SCART sockets

- On the back side the Mediamaster is equipped with 3 **SCART** sockets (see figure). **When you connect external sets to any of these sockets, always use fully featured SCART cables.** There are "slimmed" (=cheap) SCART cables on the market, but it is not sure that e. g. your videorecorder will work OK with some of these cables.
- SCART cables are also necessary to get stereo sound from a stereo TV and video recorder.



SCART socket

Connecting the Mediamaster to the satellite dish

Installing the satellite dish

- Your satellite dish should be installed with a cable for you to connect to the Mediamaster. If you do not have this cable you will need to buy one from a dealer (tell the dealer you need a coaxial cable and F-connectors).
- Connect the cable from the satellite dish to the socket marked "LNB" on the back of the Mediamaster.

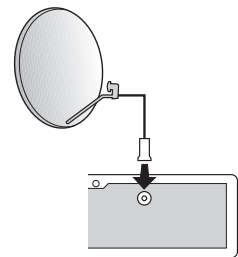

If you need to fit the F-connectors onto the cable

- Prepare each end of the cable as shown in the diagram. You will need to fold back the outer braid (as shown).
- Slide the F-connector onto the cable, then turn it clockwise until it grips the braid.
- Ensure that 3 mm of the core is protruding from the end of the connector.

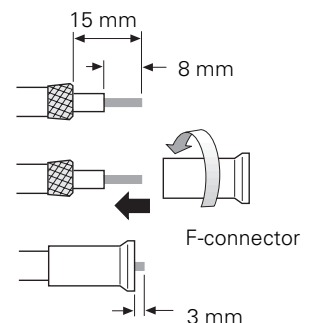

Connecting the Mediamaster to a TV set

- Do not remove the cable from the TV to the TV aerial.
- Connect one end of the SCART cable to the TV SCART socket on the back of the Mediamaster and the other end to the SCART input socket on your TV.

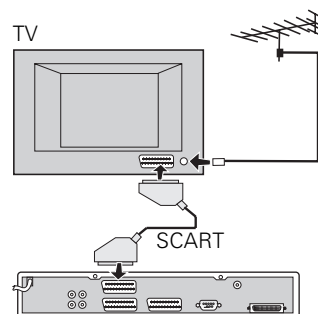

Connecting to a TV and a video recorder

Refer to your video recorder manual for full instructions.

- Connect one SCART cable between the TV and the TV SCART socket on the Mediamaster.
- Connect the other SCART cable between the video recorder and the VCR SCART socket on the Mediamaster.
- Connect the RF cable from the RF output on the video recorder to the TV aerial input on the TV.
- Connect the ordinary TV aerial directly to the RF input socket on the video recorder.

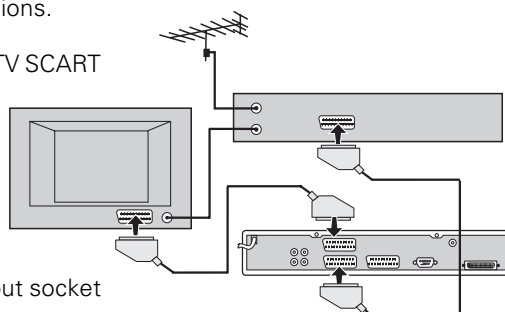

Connecting to a Hi Fi system

- Connect an RCA/Cinch stereo cable from the AUDIO L R sockets on the Mediamaster to the LINE, AUX, SPARE or EXTRA input sockets on your Hi Fi system.

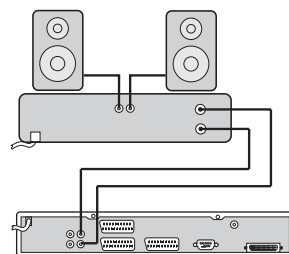

Connecting to an analogue satellite receiver and a video recorder

- Connect one SCART cable between the TV set and the TV SCART socket on the Mediamaster.
- Connect one SCART cable between the TV SCART socket on the analogue satellite receiver and the SAT SCART socket on the Mediamaster.
- Connect one SCART cable between the video recorder and the VCR SCART socket on the Mediamaster.
- Connect the RF cable from the RF output on the video recorder to the TV aerial input on the TV.
- Connect the ordinary TV aerial directly to the RF input socket on the video recorder (TV if no VCR).

In order to switch the signal from the dish between the analogue and digital receivers, you need a Nokia Smart priority switch (at A B in the diagram).

- Connect the coaxial cable between output **A** on the NOKIA Smart priority switch (accessory) to the LNB socket **on the analogue receiver**.
- Connect the coaxial cable between output **B** on the NOKIA Smart priority switch (accessory) to the LNB socket **on the Mediamaster**.

The analogue receiver must be switched OFF when you want to watch channels from the Mediamaster.

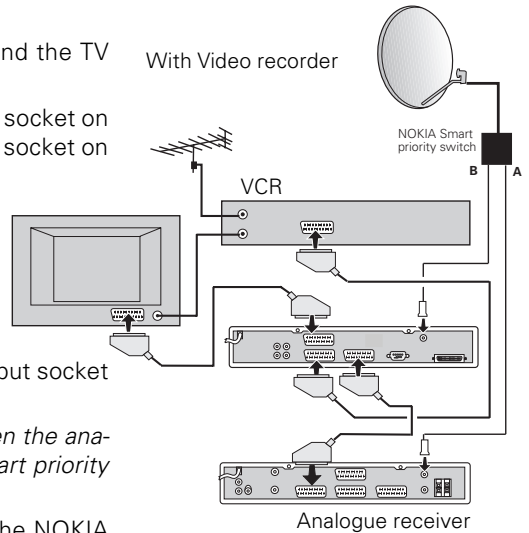

Nokia Smart Priority Switch

Without a VCR, you should connect as shown in the diagram to the right.

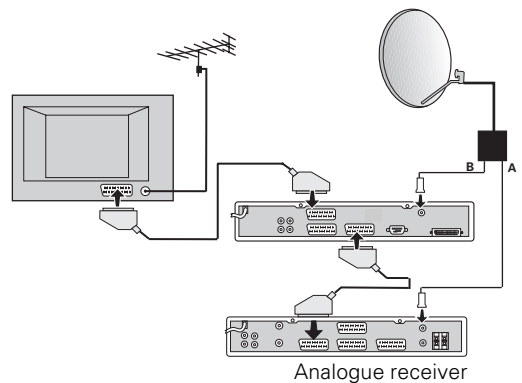

Preparing the remote control

- Remove the cover on the battery compartment at the bottom of the remote control handset.
- Insert the 2 x AAA (1,5 V) batteries, as shown in the diagram, taking care to observe the + and - markings indicated inside.
- Replace the cover.

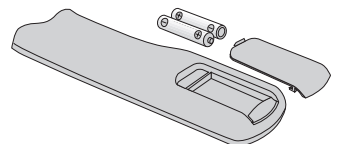

CA module and Smart Card. Model 9600 S only

CA modules and Smart Cards are licenced to Service Providers.

If you want to watch TV programmes from a Service Provider you must use a CA module (Conditional Access) with a Smart Card.

Please note, that the CA module and the Smart Card may give special menus not described in this Manual.

If no CA module is used you can only watch "free to air" TV programmes.

Note: The mains plug must **not** be plugged in before inserting the CA module!

- Insert the CA module fully into the slot behind the lid in the front panel of the Mediamaster so that **the arrow** on the module faces **upwards and inwards**.
- Insert your card fully into the slot on the CA module, so that the microchip (the yellow spot) faces **upwards and inwards**.

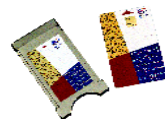

Switching on for the first time

You can now plug in the mains plug of the Mediamaster to the wall socket.

- Switch on your TV set.
- When the Mediamaster is connected to the TV set, you will now see a welcome message on the screen. You may now proceed to page 11 "Basic Settings". However, we recommend that you read the other information on the preceding pages first.

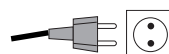

Before you continue...

please read this concerning menus

A menu is a field of text shown on the TV screen. These menus contain different kinds of information and give the possibility to select between alternatives.

In the bottom part of the screen you will normally also have a short explanation of your options.

A menu may contain several lines. Selectable lines are highlighted. Non highlighted lines are not selectable.



Remote control

This section describes how to operate the Mediamaster using the buttons on the remote control. You can also change programmes by pressing buttons on the Mediamaster's front panel.

- ⏻** To turn the Mediamaster on/off (standby).
- 🎵** Press once to switch to audio language/audio track (if available). Press twice to switch to Radio mode.
- TV** To leave a menu and go back to watch a TV programme. To switch from Radio Mode to TV Mode. To toggle between terrestrial TV, VCR, analogue and the digital satellite signal.
- 0 - 9** To select channel number and other numerical commands.
- GUIDE** To obtain a list of present and coming programs for the available channels. This information is only shown if your Service Provider transmits programme information.
- MENU** To display the "Main menu" screen.
- EXIT** To go back one level in the menus. To return to the Main Menu from a Submenu.
- i** To give short and extended information (if transmitted) about the current/next programme.
- LEFT/RIGHT BUTTONS** To move in left/right direction within the menus.
- UP/DOWN BUTTONS** To move in an up/down direction in the menus. To select TV and audio channels.
- DOUBLE ARROWS** To step pages or change channels up or down in the menus. (In blocks of 10).
- OK** To confirm choices, etc. Select TV/Radio channel list.
- + -** To increase or decrease the volume level of the Mediamaster. The Mediamaster's maximum level is controlled by the TV's present volume setting. The volume adjustment also alters the volume level to your video recorder.
- 🔇** To turn the sound on /off (mute).
- TEXT** To select teletext information. Press once to change teletext subtitle. Press twice to enter teletext (if available).

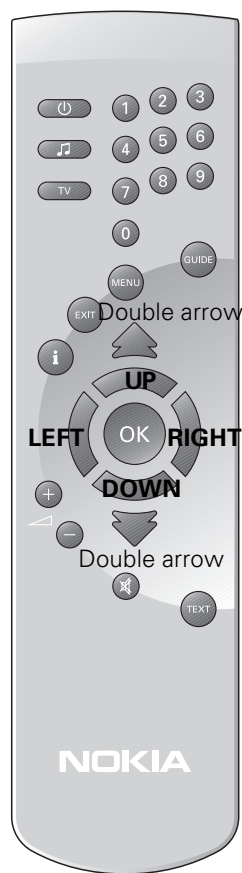

About the Smart Card and CA Module. Model 9600 S only

To be able to receive pay-TV channels you will need a CA Module and a Smart Card from the Service Provider of your choice.

The Service Provider is the distributor of the programmes.

If you are subscribing to services from more than one Service Provider, you might have to change between different Smart Cards, or even between different CA Modules.

Please note, that a smart card is connected to a single Service Provider and due to this, a specific range of channels.

Only "free" channels are available without the CA Module.

After inserting the card, leave it in the slot permanently. Do not remove it again, unless your Service Provider asks you to do so. This is important, because if your Service Provider wants to download new information to the Mediamaster, the card has to be in the slot.



PIN Code

The card is loaded with a 4-numbered code, also called a PIN code (Personal Identification Number). Normally the PIN code is 0000 or 1234.

The code is essential for the future extra services offered by the Service Provider.

Basic Settings

The Welcome Menu

To install the Mediamaster properly you have to adjust a few settings. You will always be guided by the information at the bottom of the menus.

When you have finished the final part of the setup procedure you can start watching TV channels and listen to Radio channels.

By now you should have the "Welcome Menu" on the TV screen. Press the **OK** button to proceed.



Language selection

Select the desired language. This will define the language shown in the menus. It will also select this language as the main language in cases where more than one is transmitted for speech and subtitling in movies.

Press the **OK** button to proceed.



Antenna configuration

In order to configure your equipment (satellite dish and LNB) you will need to use the following menus.

The **LNB** is the receiving unit which is mounted on the satellite dish. For the following setup procedure you have to know the Local Oscillator (LO) frequency valid for your LNB(s).

If you have a single satellite dish equipped with 1 LNB suited for receiving signals from either ASTRA, HOTBIRD or THOR: The line with the alternative "One antenna/LNB for ASTRA" is highlighted. (If not, select it with the UP/DOWN buttons). As this is the most common alternative and you know you are going to watch transmissions from ASTRA, all you have to do is to press the **OK** button.

However, select the HOTBIRD or THOR alternative if you want to receive signals from any of those satellites.

Other satellite alternatives (e.g. Asiasat, Arabsat or Panamasat) may be selectable depending on which country the Mediamaster is intended for.

Pressing **OK** from any of the lines mentioned above will result in the menu to the right coming up on the screen.

The first line will show the name of the satellite.

On line "LNB Frequency", select the alternative that is valid for your LNB.

The LNB alternatives are:

"Universal" (which is the most common), "DiSEqC", "9.750", "10.000", "10.050", "10.750", "11.200", "11.475", "5.150" and also a possibility to enter another alternative with the numbered buttons on the remote control.

Proceed to headline "**Dish adjustment**" on the next page.

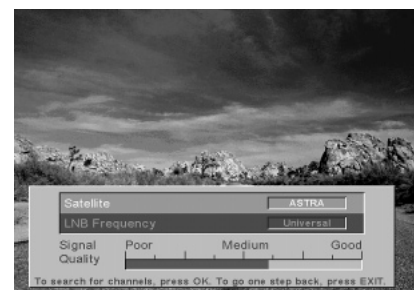
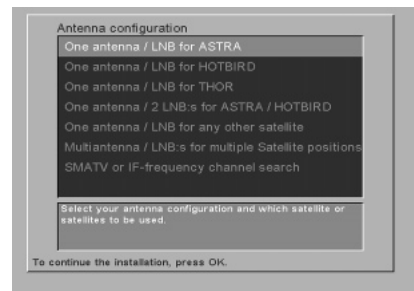

Dish adjustment

ASTRA, HOTBIRD, THOR and SIRIUS all have one (1) preprogrammed channel each. If the dish is already correctly adjusted and your selection on line "LNB frequency" is also correctly set, you should now see a programme (from the satellite you just selected) in the background.

If not, or if the picture/sound is not satisfactory, you will have to adjust the dish to improve the reception quality.

Check the signal strength meter at the lower part of this menu.

Adjust the dish mechanically to get the best possible signal strength.

When you have made the necessary settings for your combination and have picture and sound, you may now proceed to "Channel Search" (= download of channels from the satellite) by pressing the OK button.

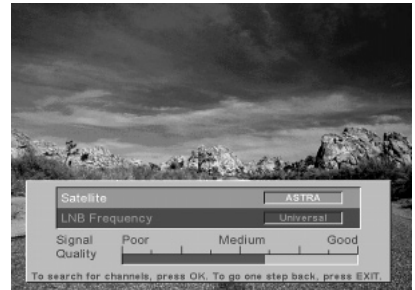

Channel Search

From the Channel Search menu the Mediamaster will automatically search for TV and Radio channels digitally transmitted from the satellite to which your dish is aimed.

The search will be performed in a predetermined way, and all channels found will be listed in two columns on the screen.

TV channels will be listed in one column, Radio channels in the other.

Please note, that the search procedure may take a few minutes.

When the search procedure is finished the indication "Ready. To watch TV, press OK" will appear in the bottom part of the menu.

When you press **OK** a new menu superimposed upon the TV picture appears, where you have the opportunity to adjust the clock*). This is done with the **UP/DOWN** buttons, $\pm 1/2$ an hour at a time.

Press **OK** and you are ready to watch TV. Please proceed to "Viewing TV" in this Manual.

*) This menu will only appear the first time you perform settings from this Menu.

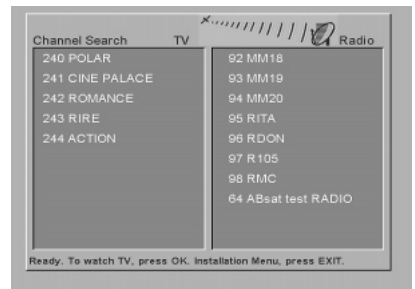

IMPORTANT!

If you have a combination which consists of more than 1 LNB and/or more than one dish, you must connect the LNB:s to an external switch. Once installed and configured, the switch automatically performs the choice of correct LNB to the desired programme channel.

This external switch is better known as a **DiSEqC™ switch** (Level 1 or 2 type). The DiSEqC switch can be located **close to the LNBs**, which then means you only need **one** cable down to the Mediamaster.

The following description will explain how to install the switch.

If you have a single satellite dish equipped with 2 LNBs, or two dishes with one LNB on each, and want to watch channels from ASTRA and HOTBIRD:

In the "Antenna Configuration" menu you should find the alternative "One Antenna / 2 LNB:s for ASTRA / HOTBIRD". If you want to watch channels from these satellites, you will have to make the following arrangements first.

Connection of the DiSEqC switch:

Connect the cable from the LNB intended for watching channels from ASTRA to the connector marked LNB 1 on the switch.

Connect the cable from the LNB intended for watching channels from HOTBIRD to the connector marked LNB 2 on the switch.

Connect the antenna cable to the connector marked Receiver OUT on the switch. Connect the other end of this cable to the antenna input marked LNB on the rear of the Mediamaster.

NOTE! Be aware of which LNB is connected to which input on the switch! ASTRA must be connected to input 1 on the switch, and HOTBIRD to input 2 for 9600 S.

For 9200 S is the choice HOTBIRD (1) / ASTRA (2).

After completing these connections, you can proceed from the "One Antenna / 2 LNB:s for ASTRA / HOTBIRD" line in the menu. Pressing the **OK** button will result in the menu illustrated to the right coming up on the screen.

From the menu, select ASTRA on the first line, and the appropriate LNB for it on the second line.

Do the same for HOTBIRD.

If everything is correctly configured and the dish(es) are pointing towards ASTRA/HOTBIRD, you should have programme information in the background, from ASTRA and HOTBIRD respectively.

If not, you have to adjust the dish(es) or LNB(s) until you receive picture and sound.

Press the **OK** button to start the Channel Search for downloading channels as described on the previous page.

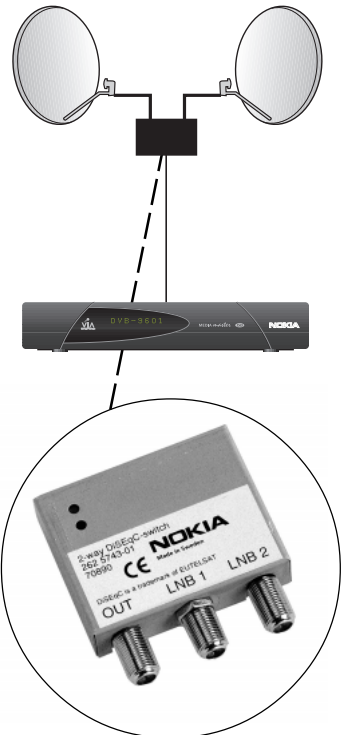

(9600 S)

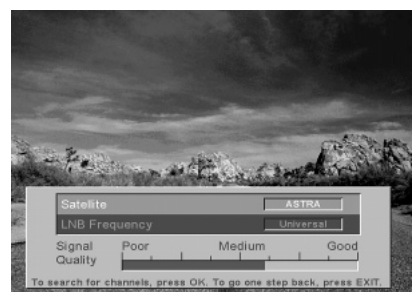
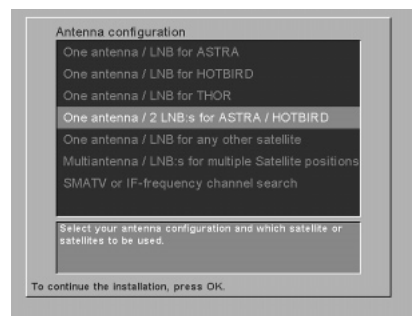

Antenna Configuration Set-Up

If you have another antenna (dish) combination you can configure it with this menu, which appears when you make a selection from the "**Antenna Configuration**" menu, line "**Multiantenna / LNB:s for multiple Satellite positions**".

(You can also recall this menu at a later occasion. From the Main Menu; select "Installation" and then "Antenna Configuration").

Antenna alternative: Select an Antenna alternative from 1 to 8. Please note, that the parameters in the menu are preprogrammed, but you can change any of them to suit your combination.

Name for the satellite: From here you can select a name for the configuration.

LNB frequency: Selection is possible for different kinds of LNBs. Select the frequency for the LNB which is valid for your combination. You may also enter a value with the number buttons on the remote control.

0/12 V antenna switch: Control of an external LNB switch, i. e. switching between two different satellite dishes. Instead of connecting a DiSEqC switch, you can use a 0/12 V switch. Note, that with this solution you will have 2 cables all the way down from the LNB:s to the switch due to the fact that it has to be mounted indoors.

DiSEqC input selection: There are in principle two kinds of external DiSEqC switches on the market at present. One for connection of two LNBs. The other one for connection of up to 4 LNBs.

If you connect a two input switch, also known as a "Tone Burst" type, select *Mini A* for the LNB connected to input A on the switch; select *Mini B* for the LNB connected to input B.

If you have the other switch, defined as "DiSEqC, Level 1 or 2" on the market, select DiSEqC 1, 2, (3 or 4), for each LNB connected to respective inputs on this switch.

When you have finished the settings in this menu, press the "**OK**" button to continue with the "Channel Search Set-Up" described on the next page.

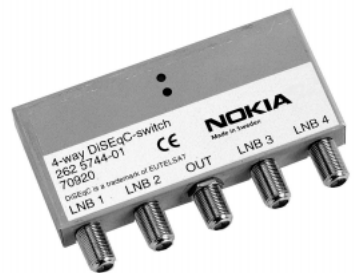
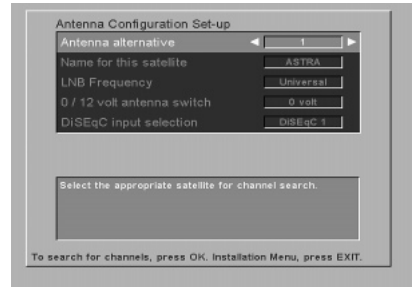

4 way DiSEqC™ switch

Channel Search set-up

The information to enter in this menu is available in various magazines covering satellite TV reception, or from your Service Provider.

You must also use it e. g. if you later want to add channels from a new transponder.

Antenna Configuration: Select the option, 1 - 8, that corresponds to your antenna system.

Transponder Frequency: Enter using the number buttons on the remote control.

Polarization: Select polarization; "Horizontal" or "Vertical".

Symbol Rate: Select "Auto" or enter with the number buttons.

FEC: Enter the appropriate Forward Error Correction (FEC) value.

Network Search: Select "YES" to search from all transponders used by a specific Service Provider.

("YES" is the default setting).

Select "NO" to search only from the transponder that you have entered on line "Transponder Frequency". (Useful if you do not want to search through all transponders for a specific Programme Distributor).

By pressing the **OK** button you can now enter the menu from where the Mediamaster starts to search for channels from the satellite.

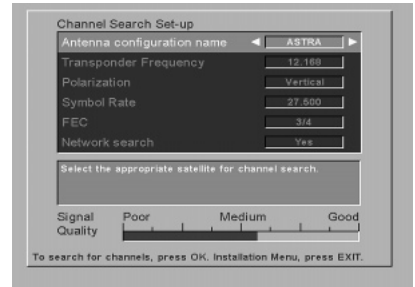

SMATV or IF frequency channel search Model 9200 S only

A SMATV network is commonly found in smaller block of flats. In such a network you will have access to a central antenna system.

If the Mediamaster is connected to a SMATV network, select "SMATV or IF frequency search".

Pressing the **OK** button will give a menu where you can enter different values for "Symbolrate" and "FEC". However, the most common alternatives for "Symbolrate" and "FEC" are already preprogrammed. (You only have to make changes here in exceptional cases).

Just press the **OK** button once again, and the "Channel Search" procedure will start; Refer to "Channel Search" on page 12.

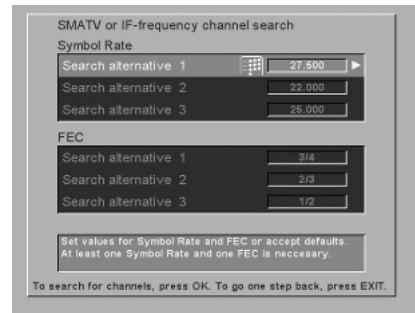
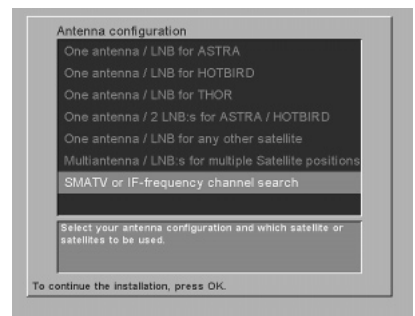

Viewing TV

Important general information

The following will describe the basic functions of your Mediamaster during the watching of TV or listening to Radio channels from the Mediamaster. Sometimes the information may not be displayed as illustrated. Many of the functions described here are dependent on the Service Provider and/or can only be used if they are included in the transmitted programme information.

Please note, that during the Channel Search procedure, the Mediamaster has downloaded **ALL** available channels. This may include channels from various Service Providers, also those to which you normally do not have access, (unless you have a Smart Card from one of those Service Providers).

If you select a programme to which you do not have access, you will get the message "No Smart card" on the screen.

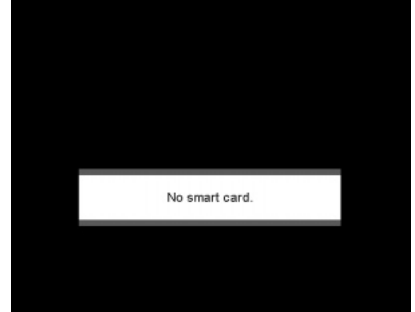

Start/stop watching TV

To start the Mediamaster from stand-by mode, press the **⏻** button, **TV** button or one of the **number** buttons on the remote control.

It is also possible to start by pressing the **⏻** button behind the lid on the front of the Mediamaster.

Put the Mediamaster into stand-by by pressing the **⏻** button.

In stand-by mode the display will show the correct time.

Select Channel

Change channel with the **numbered** buttons or with the **up/down** buttons on the remote control. You can also use the **▼ ▲** buttons on the front panel of the Mediamaster.

Programme Information. The "i" Button

Every time you change channel you will receive information for 4-5 seconds about the current programme. This information includes: Channel number, name, title and time.

Press **"i"** while watching a channel. If your Service Provider transmits programme information you will see:

Correct time;

A small amount of information for the current and next programme. (Alternate between "Now" and "Next" with the **left/right** buttons);

Name and number of the channel;

Finally the start and stop time for the programme.



From here you can also obtain information about other channels. Select with the **up/down** buttons. If you stop on another channel number and press **OK**, you will exit the menu and return to TV mode, but now on the new channel.

If you select "Next" on a programme line and press **OK**, you will set a "Reminder" . This means that, while watching TV, you will be reminded when the "Reminder marked" programme starts.

If you press the "i" button once more, you will get extended information (if transmitted) for the current or next programme.

To exit the menu, press the **TV** or "i" button.

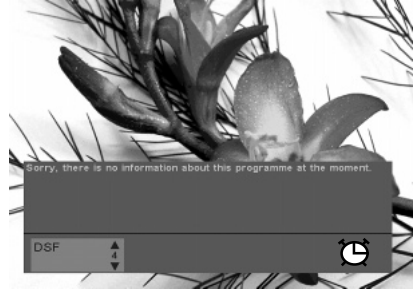

TV Guide

By pressing the **GUIDE** button you obtain access to the **TV Guide** which will give the titles of the present programme on the different channels. By pressing the **Left** or **Right** button you also can obtain information for the next programme.

Use the **Up/Down** buttons to move the cursor to different programme areas.

You can obtain extended information for a programme by pressing the "i" button.

If you select "Next" on a programme line and press **OK**, you will set a "Reminder". This means that, while watching TV, you will be reminded when the "Reminder marked" programme starts.

Please note, that these features will only work if they are included in the transmission from the Service Provider.

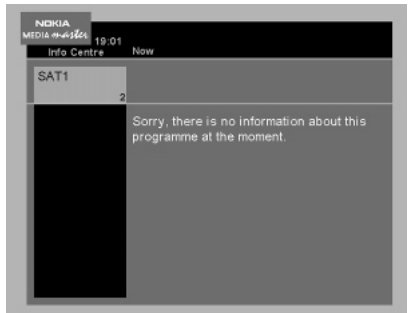

The Radio button

Pressing the  button **once** gives you a menu where you can change the spoken language in the present TV programme. (Only if more than one language is transmitted).

Pressing the button **twice** will lead to the **specific Audio Channel mode**. The display on your Mediamaster and on the TV screen will show the name of the audio channel you are listening to.

While in audio mode, you can press the "i" button to get extended information (if transmitted) about the audio programme.

Return to TV mode by pressing the **TV** button or  again.



Volume level

Increase or decrease the sound level by pressing the “+” and “-” buttons.

A control bar will be displayed on the screen during level adjustment. (The max. level for volume is the current volume setting on the TV set).

Please note, that the volume adjustments also change the volume level to your VCR during recording.

It is possible to turn the sound on and off with the  button. Sound off is indicated with the same symbol on the screen.

If you turn the volume off with this button, it does not affect the volume to the VCR during recording.



List of TV channels

During the viewing of TV you get a programme list onto the screen by pressing the **OK** button.

You can change to another channel by stepping with the **UP/ DOWN** buttons and then press the **OK** button.

To move faster (10 channels at a time) between channels you can also use the **double arrow** buttons.

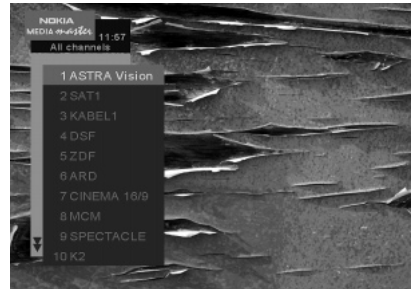

List of Radio channels

During listening to Radio Programmes you get a programme list on the screen by pressing the **OK** button.

You can change to another channel by stepping with the **UP/ DOWN** buttons and then press the **OK** button.

To move faster (10 at the time) between the channels you can also use the **double arrow** buttons.



Video recorder

With a Video Cassette Recorder (VCR) connected you can watch/record video tapes.

If your VCR is connected with a SCART cable and you press the Start button on the VCR, the playback will start and interrupt the TV programme from the Mediamaster.

To watch TV programmes again, press the **TV** button or stop the VCR.

Please note, that during the recording of a programme, **everything** shown on the screen will be registered! For example: If you call up a Menu from the Mediamaster on the screen, the menu will be recorded!

Analogue Receiver

If you have an Analogue Receiver connected and turn it ON, the programmes from that receiver will be shown. With the **TV** button on the Mediamaster's remote control you can toggle between channels from the analogue receiver and terrestrial TV channels. The display on the Mediamaster indicates TV during the watching of terrestrial channels, and SAT during watching of channels from the analogue receiver.

When the analogue receiver is turned OFF, with the TV button on the Mediamaster's remote control you can toggle between channels from the Mediamaster and terrestrial channels.

In this case the display on the Mediamaster indicates "TV" during watching terrestrial channels, and the channel name during watching programmes from the Mediamaster.

Subtitling and Teletext. The TEXT button

Pressing the **TEXT** button **once** while watching TV will put a menu on the screen where it is possible to change a subtitled language. This is only possible if more than one subtitling language is transmitted.

Exit the menu by pressing the **TV** button.

Pressing the **TEXT** button **twice** will give the teletext menu, (if teletext is transmitted). Select pages with the number buttons on the remote control.

You can also quickly step to the different subpage alternatives shown in any page by pressing the **LEFT/RIGHT** buttons. Press **OK** on a selected number, and the page will show up.

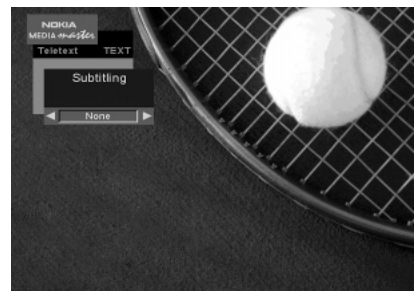

Settings from the Main Menu

How to show the Main Menu

Press the **MENU** button and you will get the Main Menu on the TV screen. Press the **TV** or **EXIT** button to leave the menu.

Submenus from the Main Menu

If you select one of the highlighted titles and press the **OK** button, a **submenu** will be shown on the TV screen.

From a submenu you can adjust settings to your own requirements.



The TV Guide and Radio Guide

These guides will give you an overview of programme information from the TV/Radio channels. Step to different channel numbers with the **UP/DOWN** buttons.

If you stop on a line and press **OK**, you will exit the menu and enter the channel marked on the line.

Select information about the **next** programme with the **RIGHT** button. Press **OK** to set a "Reminder".

Use the **"i"** button to get extended information about a marked programme.

(Please note, that information will only be shown if it is included in the transmission).



TV Channels and Radio channels

TV/Radio Channels will show a list with the names of the different channels.

To move faster within the list, use the **DOUBLE ARROW** buttons. Press **OK** to enter a marked channel.

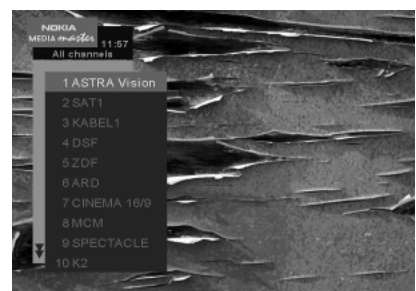

CD

From the CD menu you can control an external CD player connected to the SCSI socket.

To use present and future CD-ROM applications, the player must have the following features:

- SCSI-2 connection
- support one of the following standards: CD-XA / CD-ROM / Video-CD / Photo CD



Parental Control

By pressing **OK** on the line "Parental Control" you will be requested to enter your PIN code. (Personal Identification Code). This code is set to 1234 by the factory. You will now get the menu from where you can lock some functions in the Mediamaster.

Lock Receiver: If you select "Yes" you will have to enter your PIN code to get access to channels from the Mediamaster.

Lock Installation Menu: Select "Yes" if you want to lock access to the Installation Menu.

Lock Channel: First, to go to the channel you want to lock, then enter this "Parental Control" menu and select "Yes" from this line.

Everytime someone tries to enter locked functions, the message "Please enter your PIN code" will appear on the TV screen.

Change PIN code: If you change the PIN code from the standard 1234, DO NOT FORGET IT! Without the code you do not have access to the functions you have set from this menu!

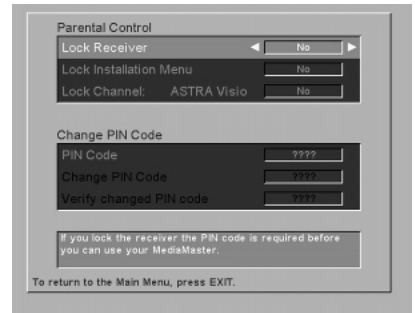
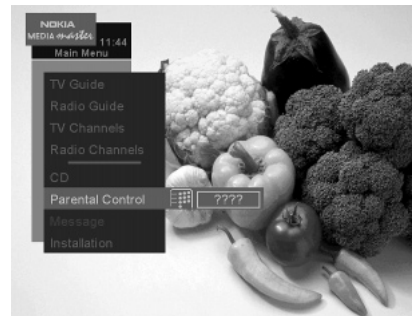

Installation

The Installation Menu lets you add or change settings already made. More about this Menu follows in the chapter "Installation Submenus" starting on the next page.

Common interface (9600 S only)

From here you will get access to information and menus connected to the Common Interface (CA) Module.

This information may vary a lot depending on the Service Provider. Please see the documentation delivered together with your CA Module.

Installation Submenus

Installation

Select this Menu from the line "Installation" in the Main Menu. The submenu will give you the opportunity to change the preferences performed during first time installation. You can also add features that were not included from the first time installation. Please note that helpful information for every line is given at the end of the menu.

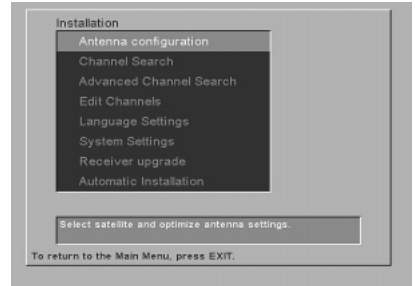

Antenna Configuration and Channel Search

The "Antenna Configuration" line will bring you to the "Antenna Configuration Set-up" menu. The settings for this menu are already described on page 14.

If you select "Channel Search", you can choose between the "Channel Search set up" described on page 15, SMATV described on page 15, and "Advanced Channel Search" described below.



Advanced Channel Search

The information to enter in this menu is available in magazines covering satellite TV reception, or from your Service Provider.

Antenna Configuration Name: Select the satellite from which the signal is to be received.

Transponder Frequency: Enter using the number buttons on the remote control.

Polarization: Select Horizontal, Vertical or Auto.

Symbol Rate: Select "Auto" or enter with the number buttons.

FEC: Enter the appropriate Forward Error Correction (FEC) value.

If the PID's are not described in the transmission you can enter them here by disable AUTO when pressing the left/right (◀▶) buttons on the remote control on any PID row. If these buttons are pressed when PID's are in the transmission, the selected PID's can be seen.

PID Video: Enter the PID (Package Identifier) for the video signal.

PID Audio: Enter the PID for the audio signal.

PID PCR: Enter the PID for the PCR (Programme Clock Reference).

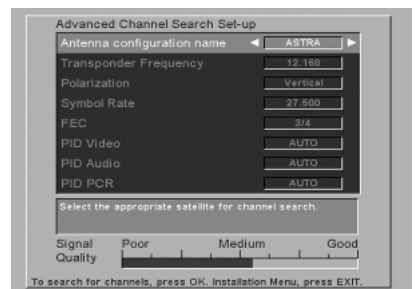

Edit TV and Radio Channels

From these menus you can change the order of the TV and Radio channels to your needs by simply selecting and moving a channel to a new position.

You may also delete unwanted channels. Follow the instructions in the menu.

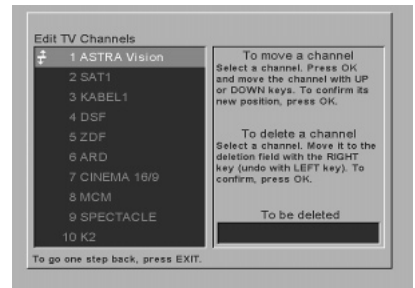

Language Settings

From here you can change the language for the menus, main audio language and alternative audio language. Just follow the instructions given at the bottom of the menu.

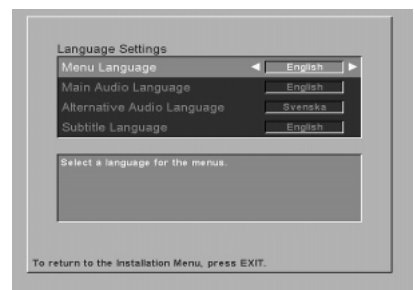

System Settings

Type of connected TV: Not used in this version

Fullscreen/Letterbox: Not used in this version.

Timeout Channel Info: Used to set the time in seconds for how long the channel info on the TV screen will be shown.

Timeout Number Keys: The delay time within which you have to press the next button.

Time Adjustment: Adjust the clock in steps of $\pm 1/2$ hour.

Display Volume Indicator: Possibility to turn on/off the Volume Indicator on screen.

LNB Adjustment: If the cable up to the LNB is very long it might be necessary to increase the Voltage by 0,5 V.

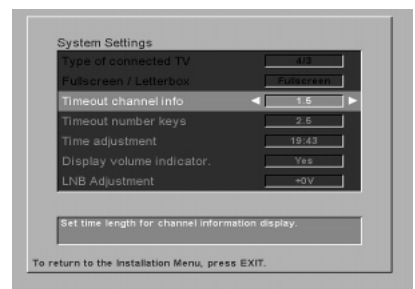

Receiver upgrade (9600 S only)

If your Service Provider has a new software version available for the Mediamaster, you can enter this menu and obtain information.

You can select "Yes" if you want to download it now, or "No" if you prefer to do it at a later time.

If no software is available, you will get the message "No new software available".

During downloading periods you are prevented from turning the Mediamaster on, or from changing any settings.



IMPORTANT! Updating via satellite may take up to one hour. DO NOT turn off the Mediamaster or disconnect the dish/LNB cable during this procedure!!



Automatic Installation

Will start the Installation procedure from the "Welcome Menu".

When you press OK in the "Welcome Menu" again, be aware of the fact, that all previous channels and settings will be erased!

To exit the "Welcome Menu" without erase, press EXIT.



Symbols on the Mediamaster display

No TS No Transport Stream
= No signal.

? No function.

Channel name.

Err Error message.



Signal indicator.
A square means full signal.

UPGRADE

The Mediamaster is busy
downloading new software.

Glossary of terms

Access Authorisation to use the coding system to purchase/order TV programmes.

AGC Automatic Gain Control

Audio system With digital satellite reception, the sound is transmitted in packages and is selected either in a special audio mode or pre-selected by using installation set-up. This gives the opportunity to select between several different languages to a movie. Amount of choices is dependent on what is available in the signal.

CA Conditional Access

Coded satellite TV programme

Some satellite TV programmes (PAY TV) are transmitted in encoded form; with black screen and no sound. A CA module and a Smart Card is needed to view such programmes.

DTH Direct to Home

DVC Digital Video Cassette

DVB Digital video broadcast

EPG Electronic Programming Guide, programme information about name, starttime etc.

FEC Forward Error Correction, parameters given by e.g. the Service provider, TV-guides etc.

GHz Abbreviation for GigaHertz. The prefix giga means billion, and Hertz means cycles per second. Signals in the GHz range are often called microwaves.

LNB (low-noise block converter) or LNBF

The LNB is an electronic unit mounted on the satellite dish. It receives the signals reflected by the dish and converts them to signals that can be used by the Mediamaster.

L.O. Local oscillator part of the LNB. It converts from the satellite frequency down to a frequency acceptable for the Mediamaster.

Mediamaster A unit that converts the digital satellite signals from the LNB into audio and video signals. The audio and video signal can be sent to the TV set either via SCART or via RF (modulator output).

MHz Abbreviation for MegaHertz. The prefix mega means million, and Hertz means cycles per second.

MPEG Moving Picture Experts Group

NVOD Near Video On Demand

PCR Program Clock Reference

PID Package Identifier

PIN code Personal Identification Number. A four-digit code that is used for locking/unlocking, eg with the parental control feature. Default value is normally 1234.

PSI Programme Specific Information

Parental control A feature that allows parents to "lock" programmes that they consider unsuitable for children. A "locked" programme can only be "unlocked" with the special secret code (PIN code).

Polarisation Polarisation allows several programmes to be fitted into the same frequency band. The signals from a satellite are transmitted either with linear (vertical or horizontal) polarisation or circular (right or left) polarisation.

RF Radio frequency (known as HF in some countries).

RS 232 Serial data port

Satellite dish A dish-shaped antenna (reflector) to receive signals from a satellite. The dish focuses the signals on the LNB.

SCART A connector used for connection of e.g. Mediamasters, video recorders and TV sets. Also named Euroconnector or Peritel connector.

SI Service Information

SMATV Single Master Antenna TV

Symbol rate Size of the digital package transmission

SW Soft ware

TS Transport stream

VCR Abbreviation for Video Cassette Recorder.

Problem solvings

Problem	Possible causes	What to do
The display on the front panel does not light up/is not lit	Mains cable is not connected	Check that the mains cable is plugged in to the power socket
No sound or picture	The satellite dish is not pointing at the satellite	Adjust the dish. Check the signal level indicator in one of the channel search submenus
	No signal or weak signal	Check the cable connections, LNB and other equipment connected between the LNB and the receiver or adjust the dish
	The LNB is faulty	Replace the LNB
Bad picture/blocking error	The satellite dish is not pointing at the satellite	Adjust the dish
	Signal too weak	Increase the LNB voltage with 0,5 V from the System Settings menu or connect a signal amplifier
	Signal too strong	Connect a signal attenuator to the LNB input
	Satellite dish is too small	Change to a larger dish
	LNB noise factor too high	Change to a LNB with lower noise factor
The remote control is not working	Battery exhausted	Change the batteries
	Fluorescent light interfering with the remote control	Switch off the light
	Remote control is incorrectly aimed	Aim the remote control at the receiver
CA Module not inserted	CA module is not installed	Insert the CA module
Viewing card error	Viewing card faulty	Contact customer services
Automatic messages: Check card	Viewing card faulty	Check the viewing card
No card in the slot		Check that the viewing card has been correctly inserted

What to do if you can't solve the problem

If you have tried all of the actions suggested above, without solving the problem, please contact your dealer.

Technical Specifications

Transmission Standards

DVB, MPEG 2

LNB / Tuner input

Connector 1x F-type (LNB)
 RF input frequency 950-2150 MHz
 RF input power level -20 to -70 dBm
 Supply voltage 13,5 / 18,5 V \pm 5%
 Max. current 400 mA, overload protected
 Control voltage 22 kHz, 0,65 V_{pp}
 DiSeqC Tone burst A/B or Level 1, 1-4
 RF impedance 75 Ω

TV SCART

Video output 1 V_{pp} (\pm 1 dB) / 75 Ω
 Audio output 0,5 V_{rms} / R_L > 10 k Ω
 RGB output Internal RGB or from SATELLITE SCART
 RGB bandwidth 6 MHz \pm 3 dB
 Fast blanking output Internal RGB or from SATELLITE SCART
 Status output 0/6/12 V / R_L 10 k Ω

VIDEO SCART

Video output 1 V_{pp} (\pm 1 dB) / 75 Ω
 Video input 1 V_{pp} / 75 Ω
 Audio output 0,5 V_{rms} / R_L > 10 k Ω
 Audio input 0,5 V_{rms} / R_L > 10 k Ω
 Status input 0/6/12 V / R_L > 10 k Ω

SAT SCART

Video input 1 V_{pp} / 75 Ω
 RGB input Yes
 Fast blanking input Yes
 Audio input 0,5 V_{rms} / R_L > 10 k Ω
 Status input 0/6/12 V / R_L > 10 k Ω

AUDIO R L

Connector 2 x RCA (R+L)
 Output 0,5 V_{rms} / R_L 10 k Ω

Low speed serial data (RS 232)

Connector 9-pin D-sub
 Signals RS232, max. 19.2 kbit/s
 Pin 1 not connected 2 RXD
 3 TXD 4 Set to high
 5 GND 6 not connected
 7 RTS 8 CTS
 9 not connected

SCSI

Connector 50 pol.
 Signal SCSI-2 (max. 3,8 MB/s)

Control output, 0/12 VOLT

Connector 1 x RCA / Cinch
 Voltage 0/12 V 50 mA

Conditional access system:

Interface for the Common Interface CA-module (DVB Standard)

Front panel

Display 8 character alphanumeric matrix, 5x7 pixels. Buttons: \odot , \blacktriangledown , \blacktriangle (standby, progr. number up and down)

General data

Article code The model code, variant and serial number, are located on a label on the underside of the housing.
 Software Software version (V.x.xxx) and Boot version (Bx.xx or Boot x.xx) are displayed in the matrix display when the Mediamaster is powered up.
 Supply voltage 230 V AC \pm 15%, 50-60 Hz
 Power consumption max 40 W
 Power consumption in standby 2 W
 Working temperature +5° C to +40°
 Storage temperature - 40° C to +65° C
 Operating distance for remote control max 10 meters
 Dimensions (w x d x h) 380 x 240 x 65 mm
 Weight 2,2 kg approx

SCART-sockets

	TV	SAT	VIDEO
1	Audio out right ch.	-	Audio out right ch.
2	-	Audio in right ch.	Audio in right ch.
3	Audio out left ch.	-	Audio out left ch.
4	Audio ground	Audio ground	Audio ground
5	RGB blue ground	RGB blue ground	-
6	-	Audio in left ch.	Audio in left ch.
7	RGB blue signal out	RGB blue signal in	-
8	Switch voltage out	Switch voltage in	Switch voltage in
9	RGB green ground	RGB green ground	-
10	-	-	-
11	RGB green signal out	RGB green signal in	-
12	-	-	-
13	RGB red ground	RGB red ground	-
14	Fast blank. ground	Fast blank. ground	-
15	RGB red signal out	RGB red signal in	-
16	Fast blanking out	Fast blanking in	-
17	Video out ground	-	Video out ground
18	-	Video in ground	Video in ground
19	Video out	-	Video out
20	-	Video in	Video in
21	Ground (casing)	Ground (casing)	Ground (casing)



The EMC Directive 89/336/EEC is applied to this product.

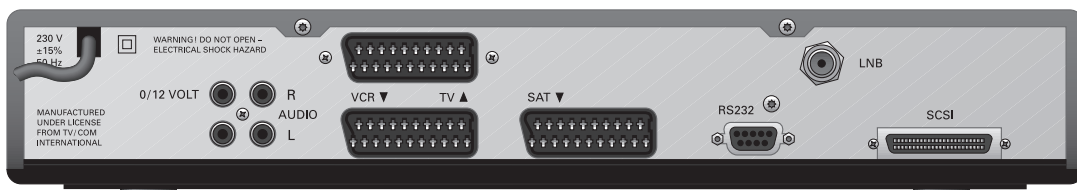

9200 S

9600 S

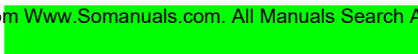

Free Manuals Download Website

<http://myh66.com>

<http://usermanuals.us>

<http://www.somanuals.com>

<http://www.4manuals.cc>

<http://www.manual-lib.com>

<http://www.404manual.com>

<http://www.luxmanual.com>

<http://aubethermostatmanual.com>

Golf course search by state

<http://golfingnear.com>

Email search by domain

<http://emailbydomain.com>

Auto manuals search

<http://auto.somanuals.com>

TV manuals search

<http://tv.somanuals.com>