



Owner's Manual

MEDIAMASTER 9802 S



NOKIA
CONNECTING PEOPLE

Hereby, Nokia declares that this digital receiver, Nokia Mediamaster 9802 S, is in conformity with essential requirements and other relevant provisions of Directive 1999/5/EC. This Terminal Equipment is intended for connection to the analogue Public Switched Telephone Networks (PSTNs), in which network addressing, if provided, is by means of Dual Tone Multiple Frequency (DTMF) signalling.

NOKIA

Declaration of Conformity

Manufacturer: Nokia Corporation through its unit Nokia Home Communication

Address: Keilalahdentie 4,
FIN-02150 Espoo,
Finland

Declares that the product

Product: Multimedia Terminal 9802 S

is in conformity with the following Directives and Standards

Directives: 73/23/EEC
93/68/EEC
89/336/EEC
1999/5/EC

Standards: EN 50081-1:1992
EN 50082-1:1997
EN 55013:1990 + A12 + A13
EN 55020: 1994 + A11
EN 55022: 1998 (class B)
EN 60065: 1998
EN 41003: 1998

Linköping, 14 May, 2002

Nokia Home Communications

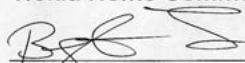

Bengt Jönsson
Head of Product Creation, MT

Postal Address
Nokia Home Communications
P.O. Box 226, FIN-00045 NOKIA GROUP

Phone
+358 7180 180 71

Fax
+358 7180 646 712

MEDIAMASTER 9802 S

Contents

General information	4	Guide	25
For your safety	4	List of TV and radio channels	26
Remote control	5	Options (green button)	26
Front and rear panel	6	TV release (0)	27
Viaccess smartcard	7	Video recording	27
CA module with its smartcard	7	The TEXT button (Teletext)	27
Preparing the remote control	8	EXIT TV	27
Connecting the Mediamaster to the dish	8	Main menu	28
Connecting the Mediamaster	9	General information	28
Connecting to the TV	9	TV and radio channels	28
Connecting a TV and VCR	9	Edit channels	28-31
Connecting an analogue satellite receiver and VCR	10	Update channels	32
Nokia smart switch	10	Guide	33
Connecting a HiFi system	10	System configuration	33
Switching on for the first time with SCART connections	11	Channel search	33-34
Tuning procedure when RF connections are used	11	Edit satellites	35-36
First time installation	12	Antenna/Satellite configuration	37
General information	12	TV settings	37
The Welcome menu	12	Time adjustment	38
Language	12	Modem configuration	38
RF modulator type	13	Receiver upgrade	39
Antenna/Satellite selection menu	13	Reinstall	39
Antenna/Satellite selection	14-19	User preferences	39
Antenna motor installation	20-23	Language preferences	39
Channel search progress	23	Parental control	40
Time adjustment	23	Appearance preferences	41
Viewing mode	24	System information	42
General information	24	Timer	43-44
Programme information	24	Glossary	45
The "i" (information) button	25	Problem solving	46
		Front panel display	47
		Technical specifications	48

Nokia and Nokia Connecting People are registered trademarks of Nokia Corporation. Other product and company names mentioned herein are be trademarks or trade names of their owners.

Nokia operates a policy of continuous development. Therefore we reserve the right to make changes and improvements to any of the products described in this manual without any prior notice.

Copyright © 2002. Nokia Corporation. All rights reserved.



GB 3

GENERAL INFORMATION ABOUT THE MEDIAMASTER

Throughout this manual you will notice that the everyday operation of your Mediamaster is based on a series of user friendly on-screen displays and menus. These menus will help you get the most from your Mediamaster, guiding you through installation, channel selection, viewing and many other functions.

All functions can be carried out using the buttons on the remote control, and some of the functions can also be carried out using the buttons on the front panel.

Please be aware that new software may change the functionality of the Mediamaster.









Should you experience any difficulties with the operation of your Mediamaster, please consult the relevant section of this manual, including the Problem Solving, or alternatively call your dealer or a customer service adviser.

FOR YOUR SAFETY

- Allow 10 cm space around the Mediamaster for sufficient ventilation.
- Do not cover the Mediamaster's ventilation openings with items such as newspapers, tablecloths, curtains etc.
- Do not place the Mediamaster on top of a unit that emits heat.
- Do not place naked flame sources, such as lighted candles, on the Mediamaster.
- Use a soft cloth and a mild solution of washing-up liquid to clean the casing.
- Do not expose the Mediamaster to dripping or splashing liquids.
- Do not place any objects filled with liquids, such as vases, on the Mediamaster.
- To give your Mediamaster an extra protection, e.g. at a thunderstorm, we recommend that you connect it via an external surge protection device.
- Do not connect or modify cables when the Mediamaster is plugged in.
- Do not remove the cover.
- Do not allow the unit to be exposed to hot, cold or humid conditions.
- Service should be carried out only at a Nokia Authorised Service Centre.
- Please note that the only way to isolate the Mediamaster completely from the mains supply is to unplug the mains cable!

REMOTE CONTROL

This section describes how to operate the Mediamaster using the buttons on the remote control. Some of the functions can also be carried out using the buttons on the front panel.

- ⏻ Switch the Mediamaster in and out of standby mode.
- EXIT TV**  Return to the viewing mode from a menu without storing any settings (in menu mode).
Switch between TV or Radio mode (in viewing mode).
-  Turn the sound off/on (mute).
-  Adjust the volume of digital programmes.
The Mediamaster's maximum level is controlled by the TV's present volume setting.
- 0 - 9** Change channel and to select individual menu options.
Note: If 0 is entered as the first digit, the TV Release functionality is activated (see below).
- 0**  TV Release. To switch between digital TV/Radio, analogue TV and analogue satellite TV and VCR, when your systems are connected by SCART cables.
- i** Info. To display short and extended information (if transmitted) about current and next programmes.
- BACK** Go back one level at the time within menus without storing any settings.
- TEXT** Select teletext information.
Press to enter teletext (if available).
- MENU** To show and to exit from the Main Menu.
- GUIDE** Obtain a list of present and following programmes for the available channels. This information is only shown if your Service Provider transmits programme information (EPG information).
- P+ P-** Change channels up and down, one at the time.
Return to TV mode from an "Open TV" application.
-  Change page in a menu/list/text if more than one page is available. To browse through teletext history.
-  Move up/down in the menus and to change channels.
-  Change settings in menus.
- OK** Confirm choices and selection of a highlighted item.
Show the TV/Radio channel list.
-  (Red) Download an "Open TV" application.
- OPTION** (Green) Select service options in viewing mode.
OPTION + code will open locked channels.
- FREEZE** (Yellow) Press once to freeze the screen picture.
Press any other key to return to normal mode again.
-  (Blue) To toggle between present and previous TV/Radio channel.



FRONT AND REAR PANEL

Front panel

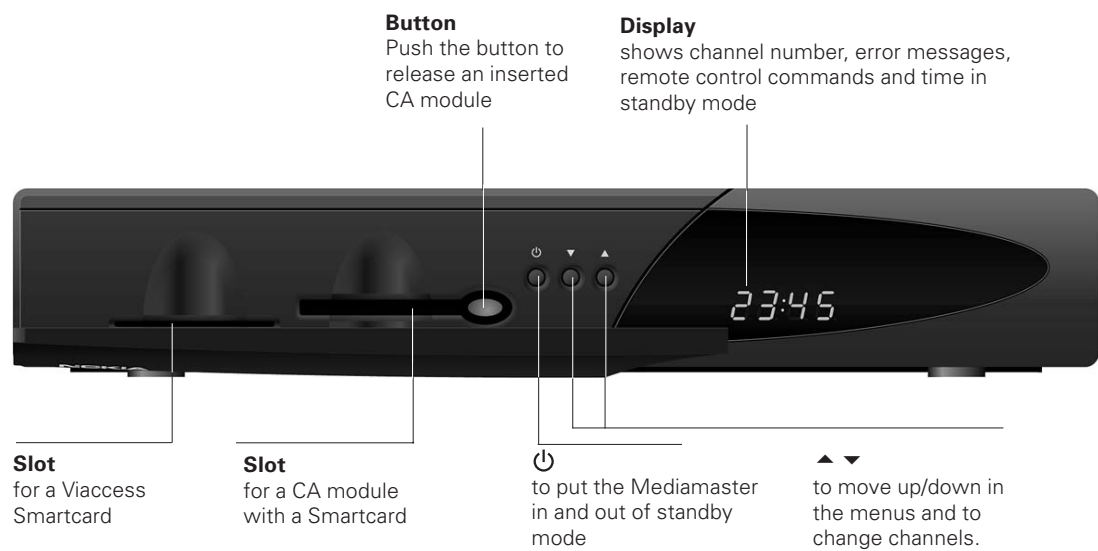

Rear panel

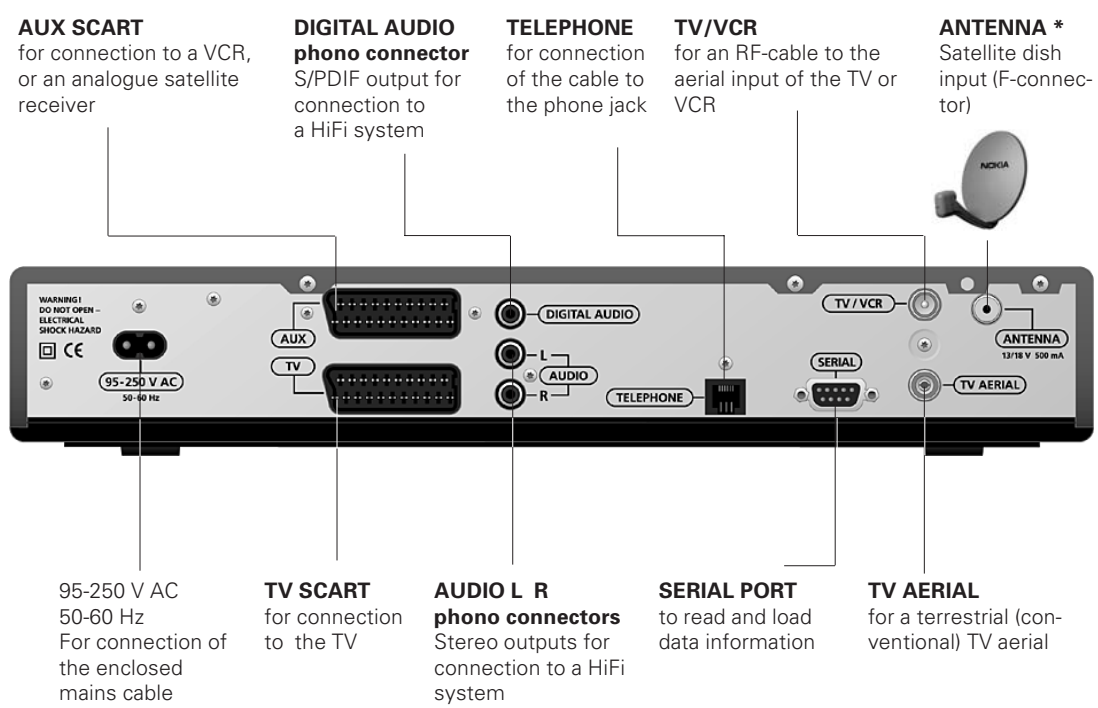

* LNB cable also feeds the LNB with a supply voltage of 13/18 V (V/H polarization) and a 0/22 kHz signal (bandswitch). Max LNB current is 500 mA.

ABOUT THE SMARTCARD AND CA MODULE

To be able to receive scrambled digital satellite channels you will need a Smartcard and/or a Common Interface CA (Conditional Access) module* from a Service Provider of your choice.

There are a few different CA modules on the European market. Each one of the CA modules support a certain kind of encryption system. The Mediamaster supports CA modules which are made to work according to the DVB standard. Depending on which country you use the Mediamaster in, your local dealer will provide you with the right type of CA module.

Please note that a smart card may only be valid for a single Service Provider and due to this, a specific range of channels.

The smart card and the CA module may cause special menus, not described in this manual, to appear. Follow the instructions from the Service Provider.

Note: CA modules and smart cards are only distributed by Service Providers and special distributors, not by Nokia.

After inserting a card, leave it in the slot permanently. Do not remove it again, unless you will be asked to do so. This is important because, for example, if your Service Provider wants to download new information to the smart card, the card has to be in the slot.

* Only use a DVB Standard Common Interface CA Module

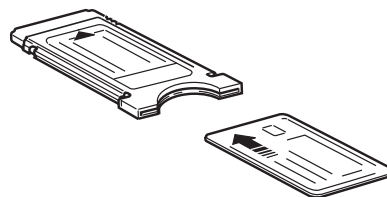
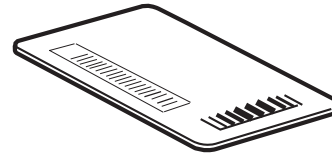

Viaccess smartcard

Only for services coded with the Viaccess CA system.

- Insert your smartcard fully into the left slot behind the lid of the front panel of the Mediamaster. The gold chip should face **downwards and inwards**.



CA module with its smartcard

- Follow the instructions from your Service Provider how to insert the CA module and the belonging smartcard
- Insert the CA module fully into the slot behind the lid of the front panel of the Mediamaster.
- Press the grey button on the front panel if you need to remove the CA module.



PIN Code

The Smartcard is loaded with a 4-digit code, also called a PIN code (Personal Identification Number).

The code is essential in order to access future services offered by the Service Provider.

INSTALLATION OF THE MEDIAMASTER

The box for your Mediamaster should contain the following items:

- the Mediamaster
- remote control with 2 AAA batteries
- SCART cable (fully connected 1,0 metre)
- aerial/RF cable (double screened 1,5 metres)
- owner's manual and software license agreement
- mains cable

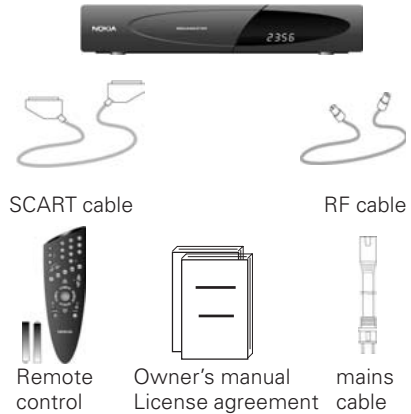

About the SCART sockets

The rear panel of the Mediamaster is equipped with 2 **SCART** sockets (see diagram). When you connect other devices to any of these sockets, always **use fully connected** SCART cables (as the one supplied.) There are SCART cables available which do not have all the pins connected. The picture quality could be reduced if you use them.



Preparing the remote control

- Remove the cover on the battery compartment at the bottom of the remote control.
- Insert the 2 AAA (1,5 V) batteries, as shown in the diagram, taking care to observe the + and - markings indicated inside.
- Replace the cover.

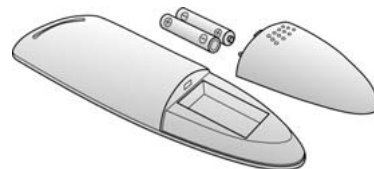

Connecting the Mediamaster to the dish

If you need to fit the F-connectors onto the cable

- Prepare each end of the cable as shown in the diagram. You will need to fold back the outer braid (as shown).
- Slide the F-connector onto the cable, then turn it clockwise until it grips the braid.
- Ensure that 3 mm of the core is protruding from the end of the connector.

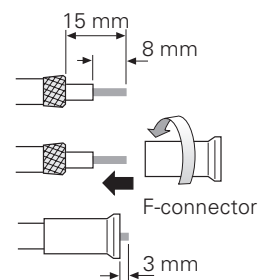

Installing the satellite dish

- See the "Fitting instructions for satellite dish" on how to install the dish.
- Connect the coaxial cable, with F-connectors fitted, from the LNB on the satellite dish to the socket marked "ANTENNA" on the rear panel of the Mediamaster.



INSTALLATION OF THE MEDIAMASTER

General

There are many different types of TV/VCR and other equipment that you can connect to the Mediamaster.

In this manual you will see some of the most common ways to connect your equipment.

If you use RF cables you will have to tune your TV and VCR to the Mediamaster output channel (see page 11).

If you have problems with your connections and need help, contact **your dealer or Service Provider**.

Connecting to the TV

- Connect the SCART cable between the main SCART socket on the TV and the TV SCART socket on the Mediamaster.
- Connect an RF cable from the TV/VCR output on the Mediamaster to the RF input socket on the TV.
- Connect the TV aerial to the TV AERIAL input socket on the Mediamaster.

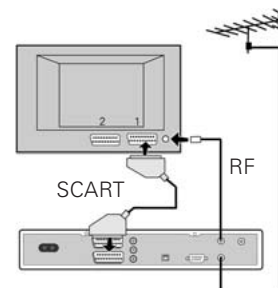

Connecting a TV and VCR

Refer to your VCR's manual for full instructions.

- Connect one SCART cable between the main SCART socket on the TV and the TV SCART socket on the Mediamaster.
- Connect another SCART cable between the VCR and the AUX SCART socket on the Mediamaster.
- Connect the RF cable from the RF output on the VCR to the TV aerial input on the TV.
- Connect the TV aerial to the RF input socket on the VCR.

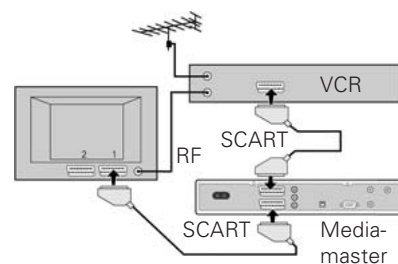

If your TV has a SCART socket, but your VCR does not

- Connect a SCART cable between the main SCART socket on the TV and the TV SCART socket on the Mediamaster.
- Connect an RF cable from the RF output on the VCR to the TV aerial input on the TV.
- Connect an RF cable from the TV/VCR output on the Mediamaster to the RF input socket on the VCR.
- Connect the TV aerial to the TV AERIAL input socket on the Mediamaster.

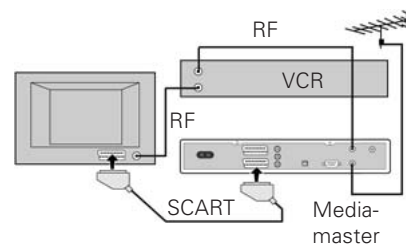

INSTALLATION OF THE MEDIAMASTER

Connecting a satellite receiver and a VCR

- Connect a SCART cable between the main SCART socket on the TV and the TV SCART socket on the Mediamaster.
- Connect a SCART cable between the VCR and the AUX SCART socket on the Mediamaster.
- Connect an RF cable from the RF output on the VCR to the TV aerial input on the TV.
- Connect an RF cable from the RF output on the satellite receiver to the RF input socket on the VCR.
- Connect the TV aerial to the RF input socket on the satellite receiver.

In order to switch the signal from the dish between the satellite and digital receivers, you need a Nokia smart switch (at A B in the diagram) or a Universal Twin LNB.

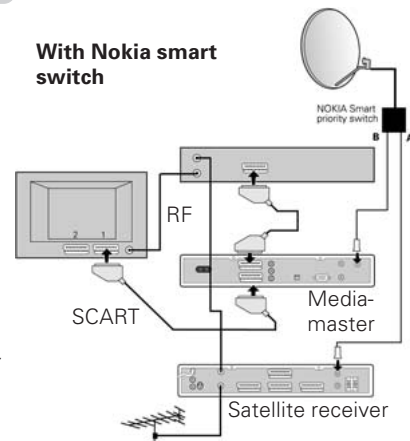

Nokia smart switch

- Connect a coaxial cable between output **A** on the smart switch (accessory) to the LNB socket **on the satellite receiver**.
- Connect a coaxial cable between output **B** on the smart switch to the ANTENNA socket **on the Mediamaster**.



Nokia smart switch

The satellite receiver must be switched OFF (in standby mode) when you want to watch digital satellite channels from the Mediamaster.

Connecting a HiFi system

- Connect an RCA/Cinch stereo cable from the AUDIO L R sockets on the Mediamaster to the LINE, AUX, SPARE or EXTRA input sockets on your HiFi system.
- If available you can connect an RCA/Cinch single cable from the DIGITAL AUDIO socket on the Mediamaster to your HiFi or Dolby Pro Logic system.

Note: To avoid interference you must use a **screened** audio cable.

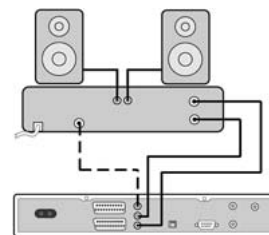

Connecting to the built in phone modem

The built in phone modem makes it possible for you to use interactive services. Refer to page 38.

- Connect the attached telephone cable between the socket marked TELEPHONE on the rear of the Mediamaster and the ordinary telephone socket in the wall.

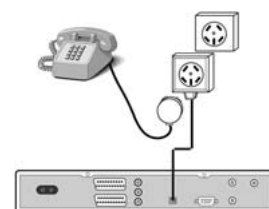

INSTALLATION OF THE MEDIAMASTER

Switching on for the first time with SCART connections

- Plug in your Mediamaster
- Now you will see the "Welcome" menu on the screen.
- Press **OK** on the Mediamaster remote control to start the Installation procedure.

You may now proceed to "First time installation", see next page.



Tuning procedure when RF connections are used

This procedure is necessary if your Mediamaster is connected to the TV with an RF cable, and not via SCART.

To tune your TV to the RF signal you might also need your TV manual in addition to this manual. The steps below explain what to do if you have been unable to use SCART cables in your connection.

- Plug in your Mediamaster.

Tuning your TV to the Mediamaster

- Select a channel number on the TV that is not currently used for other TV channels.
- Follow the instructions in your TV manual to tune the TV channel selector to UHF channel 43 (this is the Mediamaster's factory preset UHF channel). If you are already using this channel, select another non occupied UHF channel between 21 to 69 on the TV.
- For example, if you select UHF channel 45 on your TV, you must change your Mediamaster to the same channel. Use the **▲** or **▼** buttons on the front panel of the Mediamaster, or on the remote, to change to the corresponding channel. You will see the UHF channel number displayed on the front panel of the Mediamaster.
- When you have correctly changed the UHF channel number you will see the "Welcome" menu on the TV screen. If there is interference from other channels you will have to change the chosen UHF channel.
- Follow the instructions in your TV manual to store this UHF channel as the channel used by your Mediamaster. You will have to select it when you want to watch digital TV/Radio channels.
- Once the welcome message is visible, press the **OK** button on the Mediamasters remote control to start the "First time installation" procedure, see next page.

CH43



If for some reason you have to change the RF channel later, you can do this by using TV settings menu further on in this manual.

If you have a VCR connected it must be tuned to a different UHF channel (between 21 to 69) than the Mediamaster.

FIRST TIME INSTALLATION

General information

Once you have correctly connected the Mediamaster, you also have to perform a "First Time Installation."

During this procedure, helpful information is displayed at the bottom of the menus.

Please note!

The **OK** button always **confirms** a selection within these menus, and pressing it will take you to the next step in the installation process. However, and this is important, often more than one value has to be entered in a menu. First, perform all necessary settings on the different lines. Then, confirm them all simultaneously by pressing **OK**.

You can always go back to the previous menu by pressing the **BACK** button.

Use the ▲ ▼ buttons to move upwards and downwards from one line to another. Use ◀ ▶ to change settings.

You can also use the numeric buttons on the remote control to select a line in a menu and to enter numeric values.

The "Welcome" menu

This picture indicates that you have started the installation procedure.

Press the **OK** button to proceed.



Language

Select the desired menu language.

This will also be the main language for audio and subtitling.

To select the Norwegian, Finnish and Greek language alternative you first have to press the double arrow button ⇄.



FIRST TIME INSTALLATION

RF modulator type

If the Mediamaster is connected to the TV with a RF cable, you must select the right RF modulator alternative, which is dependent on the country where the Mediamaster is being used.

Select "**Normal (PAL B/G)**" for all countries except the UK.

Select "**UK (PAL I)**" when the box is used in the UK.

If you get picture but no sound, the RF modulator selection might be wrong.

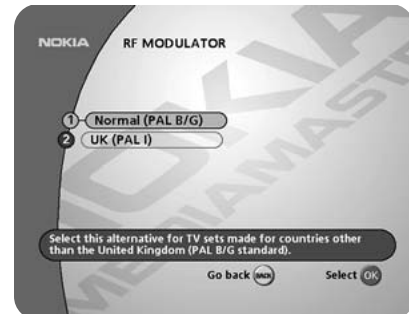

Antenna/satellite selection

Select one of the alternatives from line 1 to 4 if you have a single antenna equipped with one LNB for receiving signals from either ASTRA, HOTBIRD, THOR or SIRIUS.

Select one of the alternatives from line 5 or 6 if you have one antenna with two LNBs or two antennas with one LNB on each for receiving signals from the combination ASTRA/HOTBIRD or THOR/SIRIUS. In these cases you also need a 2-way DiSEqC switch.

Select alternative 7 for any other antenna/satellite combination, e.g. antenna motor.

Alternatives 1-6 requires the use of a Universal LNB(s.)

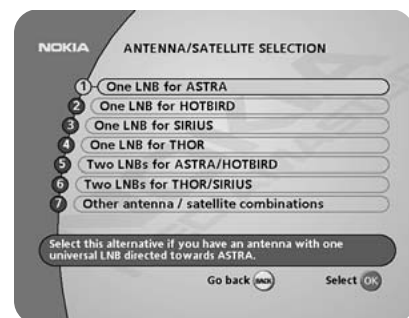

FIRST TIME INSTALLATION

Line ① through ④ on the antenna satellite selection menu

Select one of the alternatives ASTRA, HOTBIRD, SIRIUS or THOR when you have a single LNB directed towards any of these satellites.

Pressing **OK** from the selected alternative will display the "Antenna adjustment" menu (shown to the right) on the screen.

For each satellite, (e.g. ASTRA, HOTBIRD, SIRIUS, THOR), up to 4 different channels are preprogrammed and shown in the menu. When you adjust the antenna, your Mediamaster will use the **selected** channel to find signals from a satellite. (You can select a channel with the ◀ ▶ buttons.)

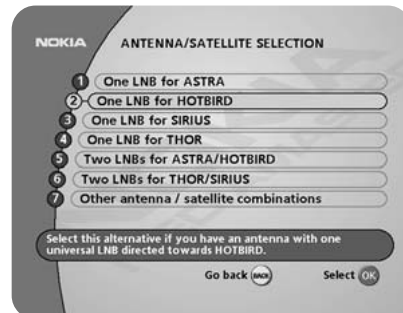

OK

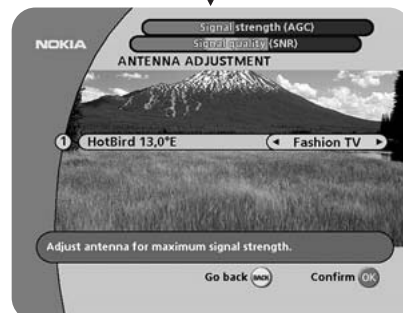

OK



Antenna adjustment and signal check

- Adjust the antenna towards the desired satellite until you have a high value on the Signal strength (AGC) *) indicator (the red bar at the top of the menu) and on the Signal quality (SNR) *) indicator (the red, yellow and green bar at the top of the menu).

If you do not get a picture, you may have tuned in an analogue signal source. Another reason could also be that the antenna is positioned towards wrong satellite.

The reason could also be that the marked channel is not transmitting at the moment. If so, try one of the other preprogrammed channels with the ◀ ▶ buttons.

When you have picture from a TV channel, press **OK**. The Mediamaster automatically starts searching for and downloads channels from the satellite. Please refer to page 23.

(If you have a good indication in the signal quality menu, but no picture from any of the channel alternatives, try proceeding with the channel search anyway by pressing **OK**.)

*) About Signal strength (AGC) and Signal quality (SNR)

The different signal indicators at the top of the menu provide information about two things:

AGC: The AGC, shown with a red bar, will indicate the average strength of any incoming signal, digital as well as analogue.

SNR: The SNR, shown with a red, yellow and green bar, will indicate the signal quality **for the selected preprogrammed channel**.

FIRST TIME INSTALLATION

Line 5 and 6 on the antenna satellite selection menu

Select one of these alternatives when you have a single antenna equipped with 2 LNBS, or two antennas with one LNB on each, and want to watch channels from ASTRA/HOTBIRD or THOR/SIRIUS.

In this case you must first connect the LNBS to an external switch since there is only one antenna input on the Mediamaster. Once installed the switch automatically selects the correct LNB for the selected channel.

This external switch is better known as a **DiSEqC™** switch. Since the switch can be located **close to the LNBS**, you only need **one** cable down to the Mediamaster.

Connection of a DiSEqC switch:

- Connect the cable from the LNB intended for channels from ASTRA (or THOR) to the connector marked LNB 1 or A on the switch.
- Connect the cable from HOTBIRD (or SIRIUS) to the connector marked LNB 2 or B.
- Then, connect the antenna cable to the connector marked OUT on the switch.
- Connect the other end of this cable to the ANTENNA input in the rear of the Mediamaster.

On the **most common type of DiSEqC switches** the connections are usually marked **1** and **2**.

On the **mini DiSEqC switches** the connections are usually marked **A** and **B**.

As a principle they perform the same work, but demands different electric commands from the receiver in order to start working.

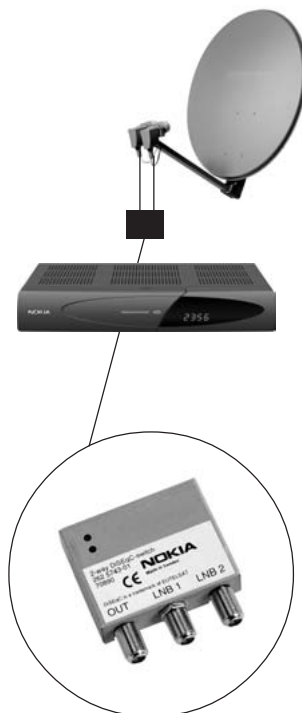
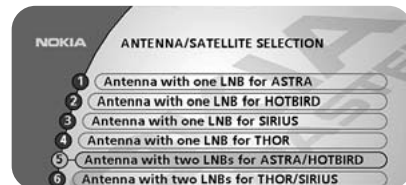

DiSEqC switch with 2 inputs

- First check, as described in paragraph **Antenna adjustment and signal check** on page 14, that you get picture and sound from ASTRA (THOR).
- When you have picture and sound continue to the next row and check HOTBIRD (SIRIUS) for picture and sound.
- When the HOTBIRD(SIRIUS) check is ready, press **OK** to start the channel search procedure. The box now starts searching and downloading channels from both satellites. See "Channel search" on page 18.

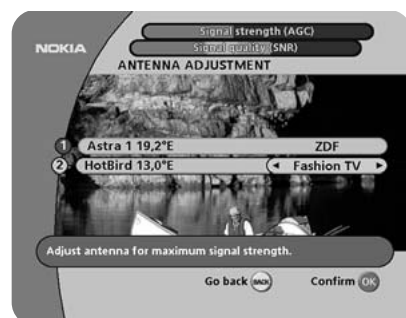

FIRST TIME INSTALLATION

Line 7 on the antenna satellite selection Menu

This selection is necessary **only when your satellite choice differs** from the preprogrammed satellite alternatives in the following ways;

- if you do not use an universal LNB
- when you have more than two LNB's.
- You also must select this alternative when your antenna is controlled by motor (ref. to page 20.)

One antenna/one LNB configuration

Select this alternative if you have **one (1) LNB** mounted on the antenna and you want to select another preprogrammed satellite (than those from line 1-4.)

You also must select this alternative when you **not** use an Universal LNB.

LNB type

Select the local oscillator (L. O.) frequency valid for the present LNB. The most common values, including Universal LNB, are selectable with the ◀ ▶ buttons.

You can also enter a value with the numeric buttons when the symbol for the remote control is visible on the line.

LNB offset voltage

If the cable down from any of the LNB's is very long, it might be necessary to increase the voltage to these LNB's by 0,5 V.

In most cases nothing has to be altered here. Leave the default value "0 V" as it is. If the switch does not change between horizontal and vertical polarization, the voltage to a LNB can be increased later.

Increase the voltage:

- a. only if a LNB does not change polarization
- b. only to the specific LNB mentioned in a. above

Satellite

Select one of the preprogrammed satellites.

Predefined channel

Select one of the preprogrammed channels and adjust your antenna according to the "**Antenna adjustment and signal check**" section on page 14.

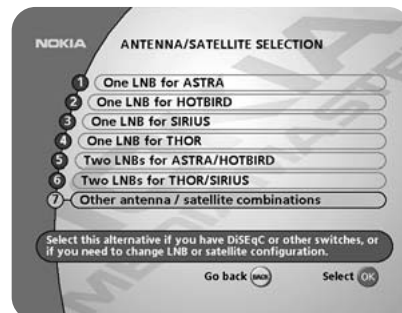

OK

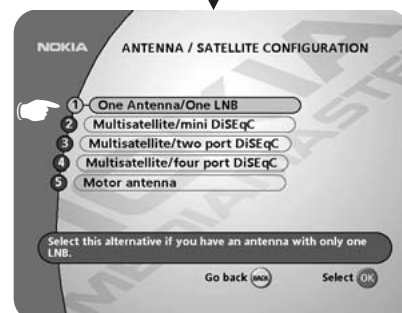

OK

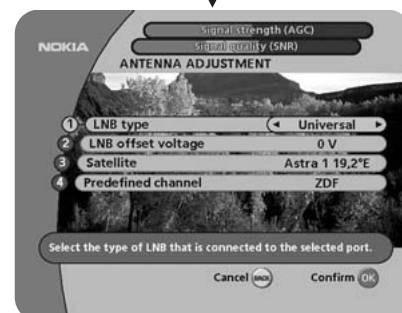

OK

Please follow the procedure described on page 14.

FIRST TIME INSTALLATION

Multisatellite/"mini DiSEqC" and "two port DiSEqC"

Select one of these alternatives when your antenna system **has two LNBS** and when you **not** use any of the alternatives on the lines 5 - 6 from the menu "Antenna/satellite selection" on page 13.

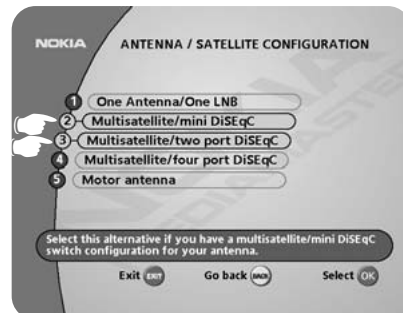

For each LNB you connect to the DiSEqC switch, the following configuration has to be performed.

As an example the following part will describe how the LNB intended for Hispasat will be configured to the DiSEqC input 1 (A) on the switch and the LNB intended for Eutelsat W2 to DiSEqC input 2 (B).

Switch type and port

Here you select the input for each LNB that will be connected.

LNB type

Select "Universal" or the local oscillator (L. O.) frequency valid for the connected LNB.

LNB Offset voltage

See page 16.

Satellite

In this example, select **Hispasat** because its LNB is connected to the **DiSEqC 1 (A)** input on the switch.

Predefined channel

Select one of the predefined channels and adjust the antenna as described on page 14, "Antenna adjustment and signal check". Before you can continue, a TV picture from the predefined channel must be visible in the background.

When you do have a picture; press **OK** to continue with DiSEqC 2 (B). The same procedure as for Hispasat has to be repeated. But this time select **Eutelsat W2** as the satellite.

When the configuration of DiSEqC 2 (B) is ready, press **OK** to proceed with the channel search.

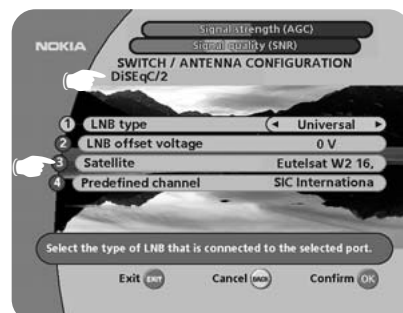
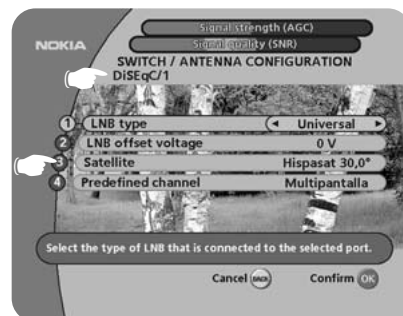

FIRST TIME INSTALLATION

Multisatellite/four port DiSEqC

Select this alternative if your antenna system **has four LNBS** and when you are **not** using any of the alternatives on the lines 5 - 6 from the menu "Antenna/satellite selection" on page 13.

The selection of the different LNBS must be controlled by an external DiSEqC switch. Refer to page 15.

The procedure is the same as for mini DiSEqC and two port DiSEqC, but you have to configure four LNBS the same way as described on page 17.

Connection of a four port DiSEqC switch:

The following is an example of how you can connect 4 LNBS when you want to watch channels from ASTRA, HOTBIRD, SIRIUS and THOR.

Connect the LNBS to the switch the following way:

- the LNB intended for ASTRA to input 1
- HOTBIRD to input 2
- SIRIUS to input 3
- THOR to input 4

When the configuration of all four inputs are ready, press **OK** to proceed with the channel search.

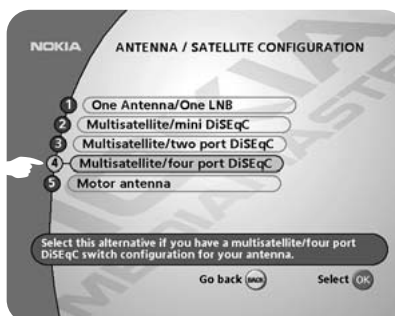

DiSEqC switch with 4 inputs

Channel search

The Channel search procedure can be performed in different ways.

- If there are predefined channels, you can make an Automatic, Manual or Advanced search.
- If no predefined channel is available you can make a Manual or Advanced search only.

Automatic search

Check that there is a programme picture in the background from each channel.

Start an Automatic search by pressing **OK**.

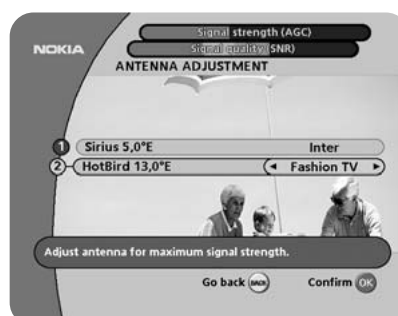
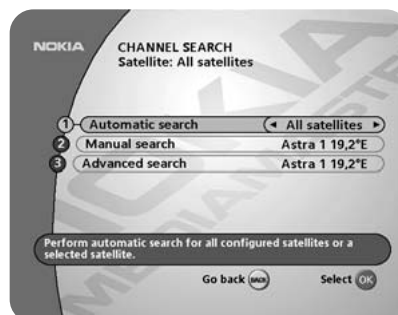

FIRST TIME INSTALLATION

Manual search

When you perform a Manual search you first need to enter some parameters for the channel search to work.

The information you need to enter in this menu is available in magazines covering satellite TV reception, on the Internet or from your Service Provider.

Transponder frequency: Specify the frequency in GHz. If you enter the wrong figure(s), erase with the ◀ button.

Polarization: Select Horizontal, Vertical, Circular left or Circular right.

Symbol rate (MSym/s): Enter with the numeric buttons. If you enter the wrong figure(s), erase with the ◀ button.

FEC: Select "Auto" or any of the preprogrammed values.

Network search: Select "Yes" if you want to search on all transponders connected to a specific network.

Adjust motor: Adjust (if necessary) the motor for the current satellite.

Press **OK** to start searching for channels.

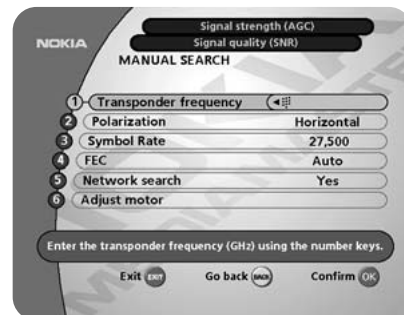

Advanced search

The information to enter in this menu is available in magazines covering satellite TV reception, or from your Service Provider.

You can use this menu if you are looking for some "special" channels (i.e. non-DVB standard channels) which can only be found when you have entered the necessary settings here.

Transponder frequency: Specify the frequency in GHz.

Polarization: Select Horizontal, Vertical, Circular left or right.

Symbol rate (MSym/s): Enter with the numeric buttons.

FEC: Enter the appropriate Forward Error Correction (FEC) or select AUTO

PID Video: Enter the PID (Packet Identifier) for the video signal.

PID Audio: Enter the PID for the audio signal.

PID PCR: Enter the PID for the PCR (Programme Clock Reference).

Adjust motor: Adjust (if necessary) the motor for the current satellite.

Press **OK** to start searching for channels.

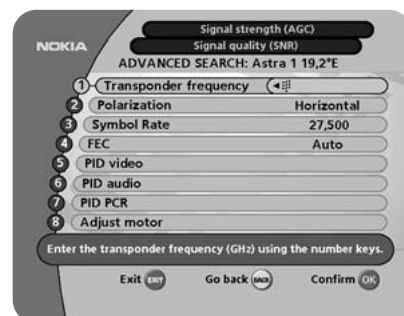

FIRST TIME INSTALLATION

Motor antenna

In case you have an antenna motor to control your satellite antenna you have to make the following settings. If the antenna is prevented from reaching its predefined east/west limit positions, you have to set new limits. See page 37 for instructions.

- From the "Antenna/Satellite selection" menu select line 7 (refer to page 13) and press **OK**.

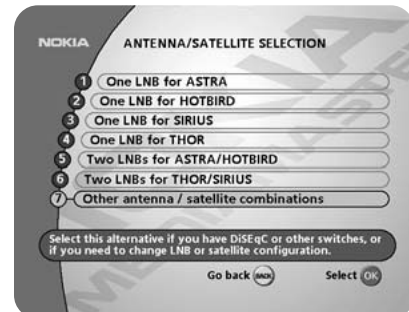

- Select line 5, "Motor antenna configuration" and press **OK**.

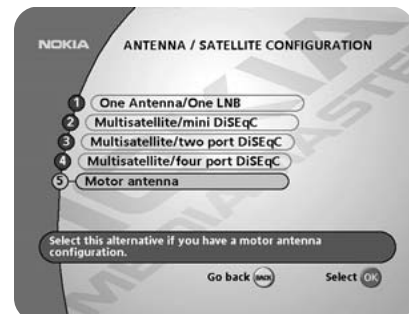

Type of motor

- Select SATSCAN if it is a Nokia SatScan motor.
- Select DiSEqC in case the motor you use is controlled by DiSEqC commands.

LNB type

- Select Universal, one of the fixed frequencies or enter the LNB frequency with the numeric buttons on the remote control.

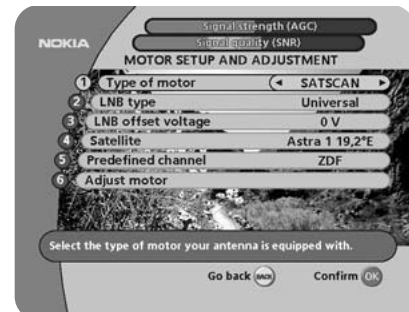

LNB offset voltage

If the cable down from the antenna is very long, the voltage at the LNB could be too low to change the polarization. You can increase the voltage to the LNB by 0,5 Volt.

Satellite

Select Astra if you have a SatScan motor and Hotbird if you have a DiSEqC motor.

FIRST TIME INSTALLATION

Adjust motor for Astra/Hotbird

To continue the installation you now have to determine the angle to Astra 1/Hotbird. The motor and the antenna must be adjusted towards the Astra 1 satellites on 19.2° East (Hotbird satellites on 13° East) as this is the reference setting. All other preprogrammed satellite positions are oriented relative to Astra 1/Hotbird.

You also have to mount the antenna at a proper place outdoors.

How to do all this, please read the separate fitting instructions for the SatScan or DiSEqC positioner.

Predefined channel

Select the predefined channel that will give the best Signal quality (SNR) bar indication. Within a few seconds you will get picture from the channel in the background.

Adjust motor

- If necessary, fine tune the motor with the ◀ ▶ buttons on the remote control.

As you now have a picture in the background, it is time to perform a Channel search procedure.

- Press **OK**.....

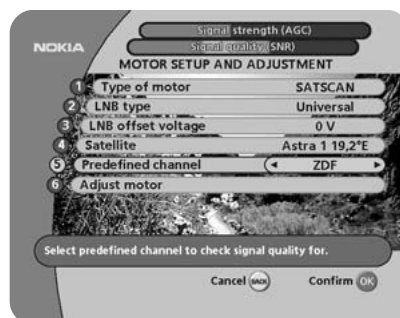

....and you will get the Channel search menu.

The most common is to start from the "Automatic search" line. (You can always make a Manual or Advanced Search later on.)

- On the line Automatic Search select the satellite from which you want to search for channels, for example Astra.
- Press **OK**.....

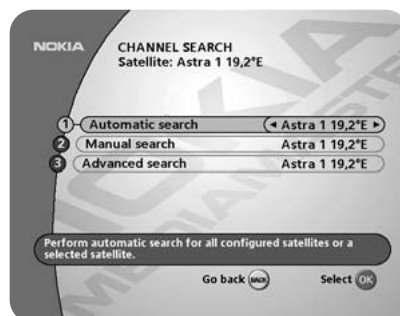

.....and you get the antenna adjustment menu

- If necessary, adjust the motor until the Signal strength (AGC) and the Signal quality (SNR) are optimal. Please note, that this will only affect the present satellite position.

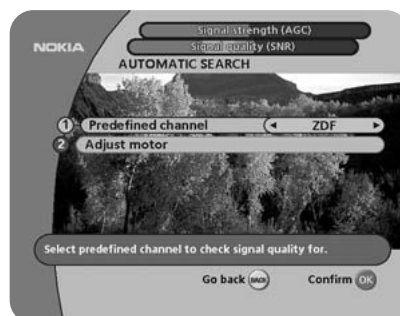

FIRST TIME INSTALLATION

- Select one of the Predefined channels and press **OK** to.....

.....start the main search procedure for (in this case) the ASTRA channels. The search procedure will take a while. Please refer to page 23.



When the channel search from ASTRA is finished you can search for channels from other satellites when you have a motor antenna.

- Press **MENU** on the remote control and the Main menu will appear on the screen.
- Select line 5, System configuration.

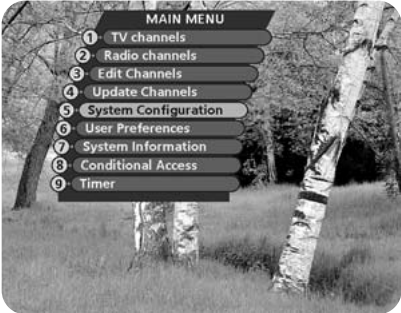

- On demand, enter the Access code 1234.....

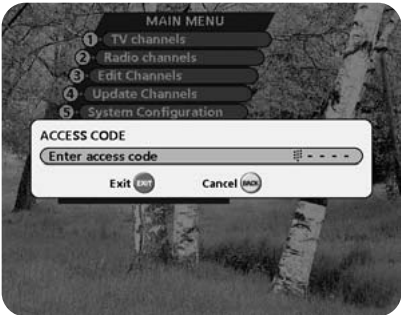

.....and the System configuration menu will appear.

- Select Channel search
- Press **OK** to get the Channel search menu again.

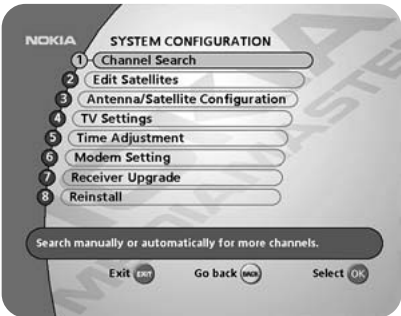

FIRST TIME INSTALLATION

The position of 22 satellites are preprogrammed in the SatScan motor.

As long as you select satellite positions from the line "Automatic search" you also have access to preprogrammed TV channels that makes it easy to check the signal quality.

- From line 1 Automatic search, select the satellite from which you want to search for channels.

Then the procedure is the same as for the first satellite installation.

However, you must give the antenna motor some time to turn itself to the new position!



Channel search progress

This menu will be shown as long as the Mediamaster is searching for channels to download

All channels found will be listed in two columns on the screen; with TV channels in one column and radio channels in the other.

Please note that the search procedure may take a few minutes.

When the search procedure has ended, a message will tell how many TV and radio channels have been found.

Press **OK** to continue.

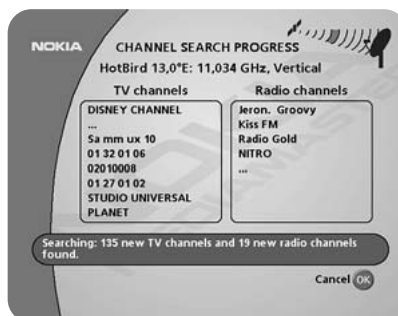

Time adjustment

The time is adjusted by using the ▲ ▼ buttons, ±1/2 an hour at a time.

You can also adjust the minutes by using the ◀ ▶ buttons.

Press **OK** to finish the first time installation, see below.

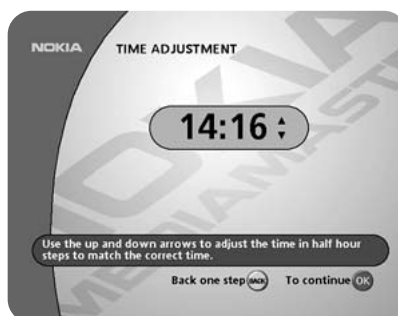

Finishing the first time installation

The channels found at the search procedure will now be saved. A message telling that the installation procedure is completed will be shown on the screen.

Press **OK** in order to start watching channels from the box.

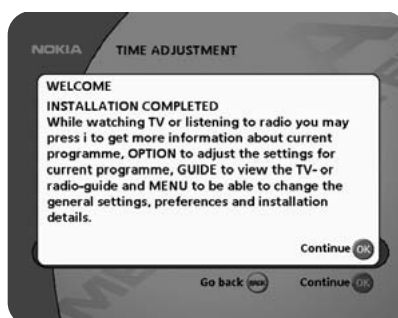

VIEWING MODE

General information

The following describes the basic functions of your Mediamaster while watching satellite TV or listening to satellite radio.

Some of the functions described here are dependent on the Service Provider and can only be used if they are included in the transmitted programme information.

Please note, that during the Channel search procedure, the Mediamaster may have downloaded a large number of channels. This may include channels from various Service Providers, also those to which you do not have access unless you have a Smartcard from one of those Service Providers.

If you select a programme to which you do not have access, you will get a message on the screen. This message may vary, depending on Service Provider and used Smartcard/CA module.

While viewing, the current channel number will be shown on the front panel display.

In addition to the normal functions like switching the Mediamaster in/out of standby, changing the volume etc. there are also other useful functions which will be explained in this part of the manual.

You can always leave a menu at any time you want, without affecting any settings, by pressing the **EXIT** button.

Programme information

Every time you change channels you will receive programme information for a few seconds. (In the "User preferences" menu you can select how long this information will be shown.)

The information may include:

Current time.

Channel list.

Channel number and name.

Name of the current and next programme.

The start and total time of the current programme.

A bar, indicating the elapsed time of the current programme.

Recommended lowest age limit for watching the programme.

The start and total time of the next programme.

Programme information will only be available if it is included in the transmission. Otherwise a "No information available" message will be shown.

You may change channel lists with the ◀ ▶ buttons.

This symbol will be shown in the upper left corner of the screen when a downloadable application ("Open TV") is included in a channel transmission.

To close an application and return to watch TV, press the **P+** or **P-** button on the remote control.

Please refer to page 40 for more information.

GB 24

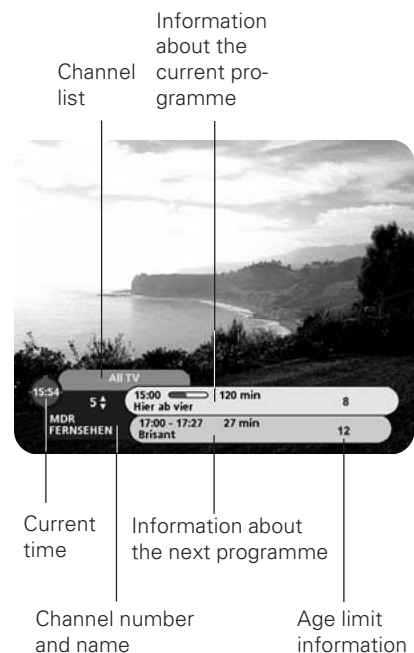

Press the red button on the remote control to start downloading an "Open TV" application

VIEWING MODE

The "i" (information) button

The Mediamaster has the ability to display information about programmes currently being broadcast as well as those being broadcast next.

This procedure is the same for both TV and radio mode.

By pressing the "i" button while watching TV you will get a special "Programme information" banner. Select channel with ▲ ▼ or the numeric buttons.

The "i" symbol is coloured blue when displaying information about the current channel, and red when information for another channel is shown.

Press "i" again to get more information about the current programme.

If a lot of information is available you can use the double arrow button to see the rest of the text.

Press "i" a third time to return to TV/radio mode.



In this view, you can select to get information about the current and next programme by using the ◀ ▶ buttons.

You can leave the menus at any time and return to viewing TV by pressing **EXIT**.



GUIDE

By pressing the **GUIDE** button you get access to the Mediamaster **TV guide** (or Radio guide if you are listening to radio channels) which will give the titles of the current and next programmes on different channels. The information is only available from the network (e.g. DF1, TPS) to which the channel you are watching belongs.

Use the ▲ ▼ buttons to move the cursor to another programme. Use the double arrow buttons to move a page at a time up and down.

When a line is highlighted, you can get more information about this programme by pressing the "i" button.

When you are watching a channel from Viasat while pressing the **GUIDE** button, the Viasat Portal will be shown. Follow the instructions from there how to get programme information.

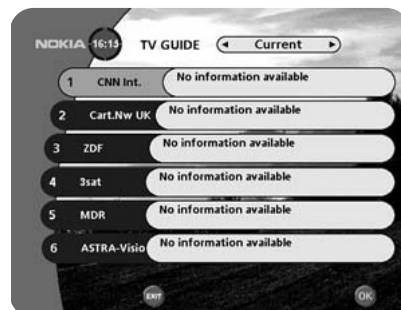

VIEWING MODE

List of TV and radio channels

At the channel search procedure, three channel lists are created. One list named "All TV" containing all channels, another named "Free TV" containing only free channels and "Viasat" containing channels distributed by Viasat.

In the "All TV" list scrambled channels are marked with a picture of a Smartcard (if this information is transmitted in the signal) and locked channels are marked with a padlock.

If you have performed a new channel search, the new channels found will be marked with a star ★ in the "All TV" list.

When viewing TV or listening to radio channels you can access the channel list by pressing **OK**. The lists are sorted by satellite, network and channel.

At the top of the menu you will see the name of the list. The current list is the one in which the channel you are watching right now is located.

- If the list contains a large number of channels, you can close satellites or networks to reduce the number of channels. You open/close a satellite or network by marking it and pressing **OK**. A closed satellite/network is indicated with .

Change channel lists with **Left/Right**.

To open the radio channel list you first have to enter radio mode by pressing **"EXIT TV"** and then **OK**.

You can change channel by stepping with the **Up/Down** buttons or enter the channel number with the numeric buttons on the remote control.

Press **OK** when a channel name is highlighted to start watching/listening to it.

To change one channel list page at a time, use the **double arrow** buttons.

You can also get more information about a marked (highlighted) channel by pressing the **"i"** button.

Options (green button)

By pressing the **OPTION** button, you open a menu in which it is possible to enter **temporary** settings. The menu will only appear if the programme contains any options to change.

Settings made in this "options menu" are only valid for the programme you currently are watching. If you leave the programme and return to it again, the temporary settings will be gone.

Audio language

If available, you can select among the different languages being broadcast.

Subtitle language

If available, you can select among different subtitle languages. If you select "OFF", you will not get any subtitling at all.

Format

If you have a TV set with a 4:3 picture format, and the transmission is in 16:9, you can select Fullscreen or Letterbox to change display format. Fullscreen will fill up the screen vertically, but cut off some information from the left and right sides of the picture. Letterbox will give a complete picture, but leave black areas at the top and bottom.

GB 26

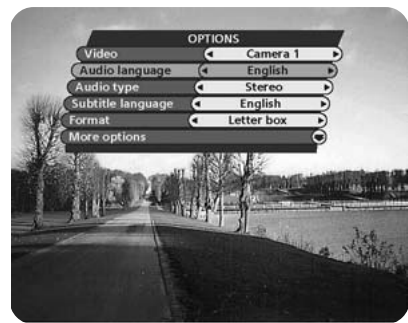
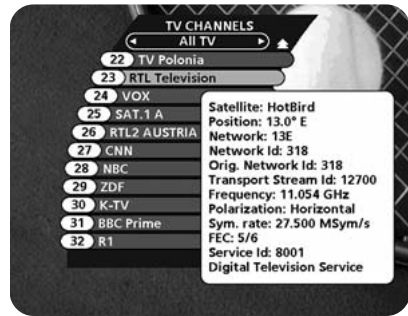
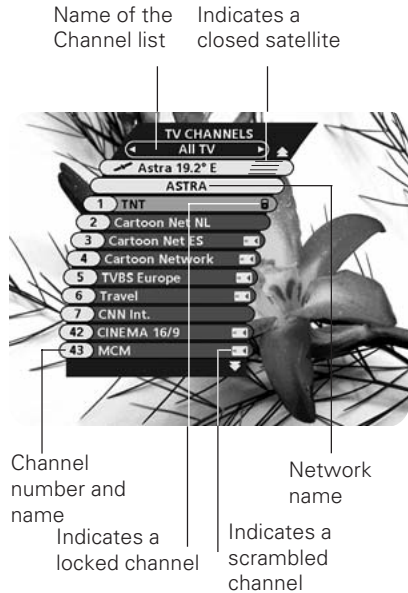

VIEWING MODE

TV release (0)

With the **0** button you can toggle between analogue terrestrial TV, video, analogue and digital satellite TV signals. (This is only valid if the units are connected via SCART cables, and not by a RF connection.)

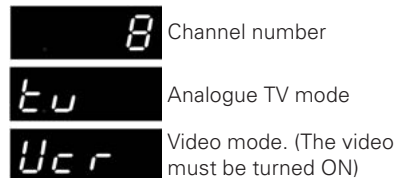

Video recording

Please note, that during the recording of a programme, **everything** shown on the screen will be registered! For example, if you call up a menu from the Mediamaster on the screen, the menu will be recorded!

When recording digital channels from the Mediamaster and the Videorecorder is connected with a SCART cable: put the video into AV/AUX or E1 mode.

When recording digital channels from the Mediamaster and the Videorecorder is connected with a RF cable: you must give the Mediamaster an own position number on the video. (The same way as you probably already have given e.g. SVT1 and other channels their own positions.)

The TEXT button (teletext)

Pressing the **TEXT** button will open a teletext page (if teletext is transmitted.) Select teletext pages with the numeric buttons on the remote control.

You can also quickly step to the different page alternatives shown in any page by pressing ◀ ▶. Press **OK** on a selected number to go to that page.

Press **EXIT**, **BACK** or **TEXT** to return to TV/radio mode.

The **"0"** button will show the index page (normally page 100.)

▲ ▼ will show the next or previous teletext page.

You can use the **double arrow** buttons to browse through the pages you just have visited.

When "hidden text" is applicable it can be shown by pressing the **"i"** button.

On most new TV sets you can use the TV's remote control to open and control the teletext functions while watching digital TV channels. (The function is called VBI insertion.) **NOTE:** Also see "Subtitles" settings on pages 39 and 41.



EXIT TV 🎵

This button has double functions.

While watching TV: The **TV/🎵** function is used to switch from TV to radio mode and vice versa.

When you have entered a menu, the **EXIT** function is used to leave the menu at any time without changing anything.

MAIN MENU

General information

Many of the functions of the Mediamaster are available from the Main menu.

Press **MENU** to open it.

You can always leave a menu at any time you want, without affecting any settings, by pressing the **EXIT** button.

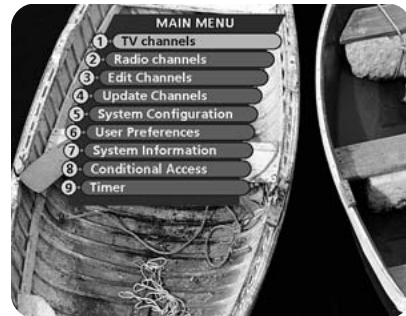

TV and radio channels

Please refer to "List of TV and radio channels" on page 26.

Edit channels

From these menus you can create and edit channel lists. You can, among other things, create favourite lists; add, delete, rename and arrange the order of the channels within the lists.

The "All TV" list might contain lots of channels. By creating your own favourite lists you can make channel handling a bit more convenient.



Important about editing channels

Before you start you must select which list, TV or radio, you want to edit. While you are watching TV and press the **MENU** button and select Edit channels, you can edit TV channels. While listening to radio channels and doing the same, you can edit radio channels.

After the selection, radio or TV, use the ◀ ▶ buttons on the remote control to select the name of the list to edit.

MAIN MENU

Create list

From here you create your own favourite lists, containing the channels you watch most frequently. You must give each list a specific name, e.g. "Sport" or "Films."

When a favourite list is selected, you see only those channels defined in the list.

When you have given the list a name; press **OK** and you will enter the "Select channels" menu (see next page) from where you add channels to the list.

You can create separate favourite lists for TV and radio channels.

How to give a specific name

This procedure is the same whether you enter a name for the first time or change an existing.

- Move to a new character position by using **▶** .
- To delete the last character use **◀** .
- Enter the characters one by one (A...Z, 0...9) by using **▲ ▼** . To speed up the procedure a bit you can use the double arrow buttons to jump 3 letters at the time.
- Figures can also be entered with the numeric buttons on the remote control.
- The next letter will be shown above the current, and the previous below it.
- Toggle between capital and lowercase letters with the **blue button**.

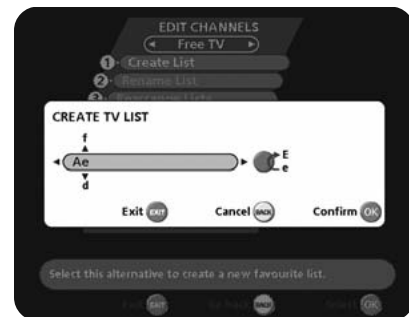

Rename list

From here you can give an existing list a new name. Use the arrow buttons the same way as when you created the list.

Rearrange lists

If you have created several Favourite lists you can determine the sequence in which the lists will appear.

Delete list

If you want to delete a Favourite list completely, select the list and press **OK**.

MAIN MENU



Select channels

From this menu you add and remove the channels in your Favourite lists. You use the "All TV" or "All radio" list as basis to select the channels from.

A channel is added or removed by pressing the **OK** button. The square to the right on a line will be empty for removed channels, and will contain an "x" for added channels.

- If you have a Favourite list that contains several satellites and networks, you can close the one(s) you are not going to work with. You open/close a satellite or network by first marking it and then pressing .

A closed satellite/network is indicated with  on the line.

- Move to desired channel(s) with  , double arrows or the numeric buttons, and add/remove them by pressing **OK**.
- When you are ready, confirm the selections and leave the menu by pressing **BACK** or **EXIT**.

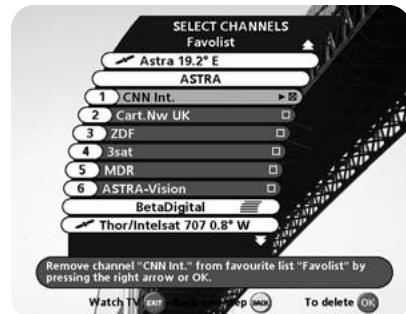

Lock channels

To get to this menu you first have to enter your access code.

From here you can lock (and later unlock) channels in any of the lists in order to prevent e.g. your children from watching.

Select the channel you want to lock and press **OK**. Repeat the procedure for each channel you want to lock. When you lock a channel in any list, the channel will automatically be locked in all other lists.

A locked channel will be marked with a padlock symbol.

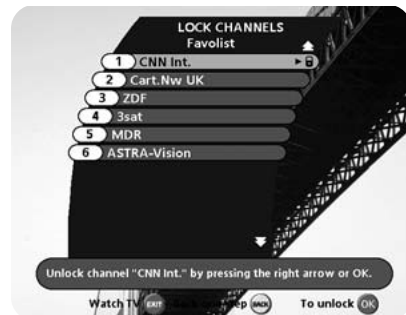

Press the OPTION (green) button and enter your access code to open a locked channel.

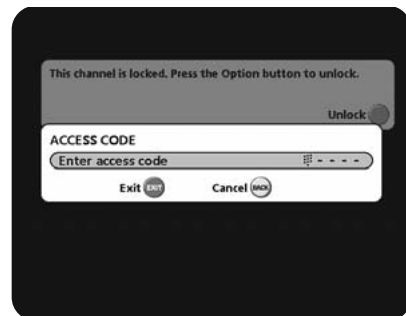

Rename channels

Mark the channel you want to rename and press **OK**. The Rename dialogue box will then appear and let you modify the existing name.

Delete the present name by using . To enter the new name, please follow the instructions under the headline "**How to give a specific name**" on page 29.

When you have changed a channel name, the new name will appear in all lists where the channel is included.

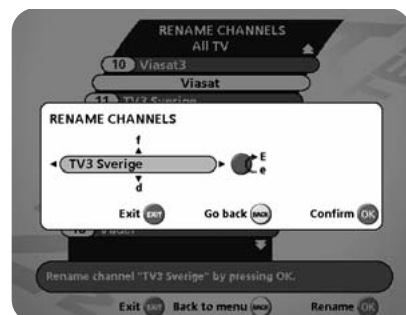

MAIN MENU

Rearrange channels

From here you can arrange the sequence for the channels within your favourite lists.

- With **▶**, mark the channel you want to move to a new position within the list.
- Press **▶** again and the right side of the marked channel will change to **▲▼**.
- Move the channel to the desired position with **▲▼** and press **OK**.

It is also possible to first mark several channels, and then move them all simultaneously.

- For each channel, press the **▶** button to add it to the set of marked channels.
- When a number of channels are marked this way and you want to move the whole set of channels, press **▶** again.
- The marked channels will now be put together into one group.
- The right side of the first and last marked channel will change to **▲▼** arrows respectively.
- Use the corresponding buttons to move the selected channels to a new position within the list.
- When the channels are in the position you want, press **OK**.

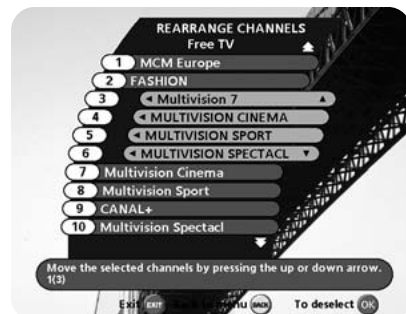
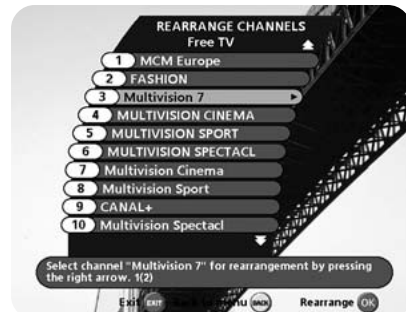

Delete channels

From here, when the **"All TV" list** is selected in the "Edit channels" menu, you can delete channels.

Please note. Channels deleted this way will be permanently deleted. The only way to get them back is to perform a new channel search.

To delete channels:

Mark the channel you want to delete and press **OK**. You will be asked if you really want to delete it. If so, confirm by pressing **OK** once more. If not, press **BACK**.

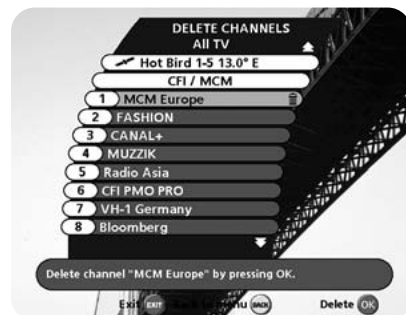

Remove channels

From here, when the **"Free TV" or a favourite list** is selected in the "Edit channels" menu, you can remove channels from those lists.

To remove channels:

Mark the channel you want to remove and press **OK**. You will be asked if you really want to remove it. If so, confirm by pressing **OK** once more. If not, press **BACK**.

Channels removed from a list this way are **not** permanently deleted. They are still available from the "All TV" list.

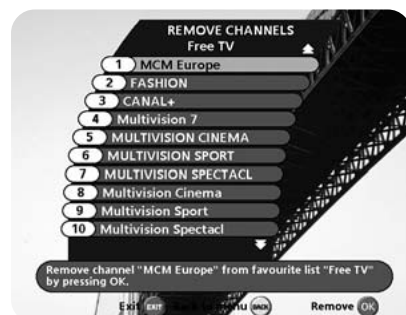

MAIN MENU

Update channels

When new TV and radio channels are added to the different satellites, you can check and automatically update the channel lists. New channels will be marked with a star ★ in the channel lists. After each download, check the channel lists for new channels marked with ★.

During the search procedure the old channels will be coloured light blue, and new channels found will be coloured black in the "Channel search progress" menu.



The following alternatives are selectable:

1 **All configured satellites:** Will search and update the lists from those satellites you use to watch channels from. If you, for example, have downloaded channels from ASTRA, THOR and SIRIUS, those three satellites will be updated.

Note: This alternative is only possible for fixed antennas. If your antenna is controlled by motor, the first line will not be selectable.

2 **Current satellite:** Will search and update the lists from the satellite you right now are watching TV.

3 **Current network:** Will search and update the lists from the network the present channel belongs to.

4 **Current transponder:** Will search and update the lists from the transponder the present channel belongs to.

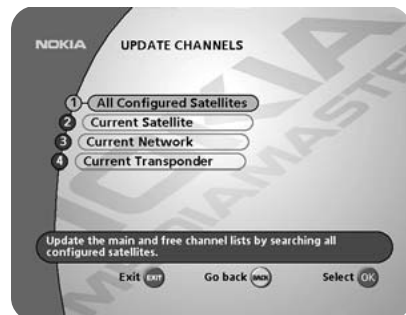

You can find out which satellite and network the channel you are watching right now belongs to:

While watching a channel, first press **OK**, then the "i" button.

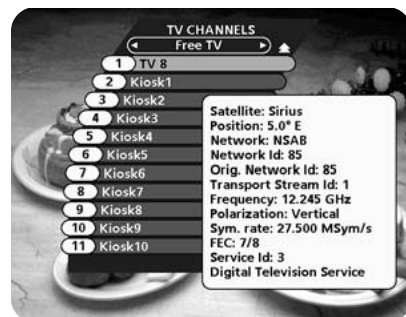

Update channels via a PC

It is also possible to update new channels via internet and a PC. You will find information how this is done on the URL <http://www.lyngsat.com/nokia>

MAIN MENU

System configuration

You will be asked to enter your access code before you can enter this menu. The code is preset to 1234 from the factory. (The code can be changed from the Parental control menu. Refer to page 40.)

If you want to customize the system to suit you better, you can specify some settings from the submenus in the "System configuration" menu.

Please note that many of these functions are the same as in the "First time installation."

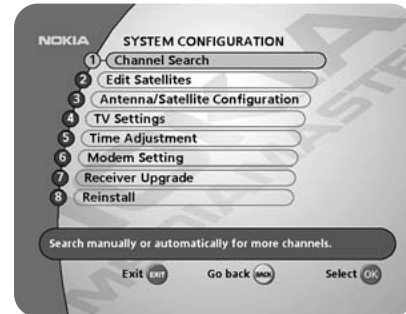

Channel search

The Channel search procedure can be performed in different ways.

- If there are predefined channels, you can make an Automatic, Manual or Advanced search.
- If no predefined channel is available you can make a Manual or Advanced search.

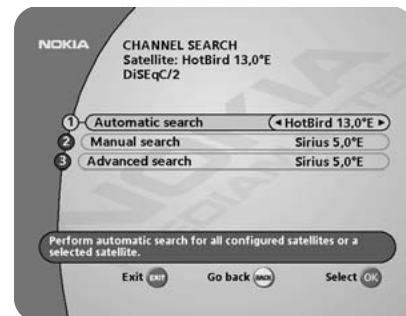

Automatic search

Start an Automatic search on a selected satellite by pressing **OK**.

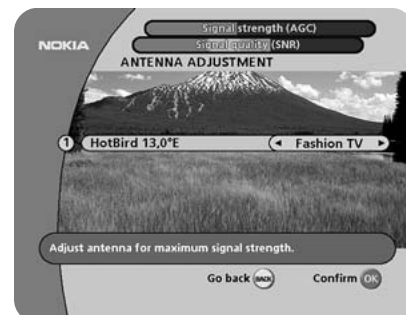

MAIN MENU

Manual search

When you perform a Manual search you first need to enter some parameters for the channel search to work.

The information you need to enter in this menu is available in magazines covering satellite TV reception, on the Internet or from your Service Provider.

Transponder frequency: Specify the frequency in GHz. If you enter the wrong figure(s), erase with the ◀ button.

Polarization: Select Horizontal, Vertical, Circular left or Circular right.

Symbol rate (MSym/s): Enter with the numeric buttons. If you enter the wrong figure(s), erase with the ◀ button.

FEC: Select "Auto" or any of the preprogrammed values.

Network search: Select "Yes" if you want to search on all transponders connected to a specific network.

Adjust motor: Adjust (if necessary) the motor for the current satellite.

Press **OK** to start searching for channels.

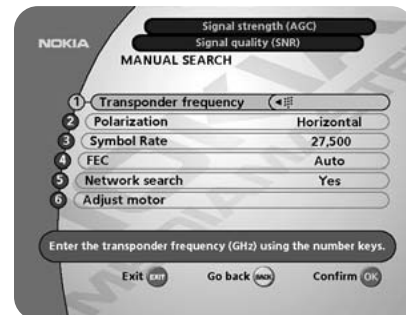

Advanced search

The information to enter in this menu is available in magazines covering satellite TV reception, or from your Service Provider.

You can use this menu if you are looking for some "special" channels (i.e. non-DVB standard channels) which can only be found when you have entered the necessary settings here.

Transponder frequency: Specify the frequency in GHz.

Polarization: Select Horizontal, Vertical, Circular left or right.

Symbol rate (MSym/s): Enter with the numeric buttons.

FEC: Enter the appropriate Forward Error Correction (FEC) or select AUTO

PID Video: Enter the PID (Packet Identifier) for the video signal.

PID Audio: Enter the PID for the audio signal.

PID PCR: Enter the PID for the PCR (Programme Clock Reference).

Adjust motor: Adjust (if necessary) the motor for the current satellite.

Press **OK** to start searching for channels.

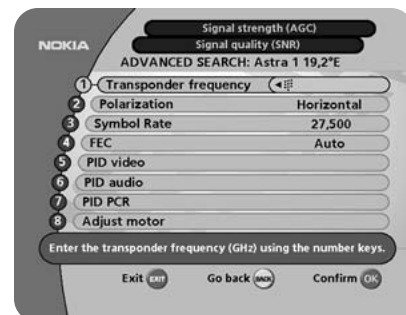

MAIN MENU

Edit satellites

When a new satellite has been sent into orbit, or if you select a not preprogrammed satellite, you can add it to the existing satellite list.

To add a new satellite

- Select the line "New satellite".
- Press **OK**.
- Enter the name of the new satellite. (How to enter a name is described on page 29.)
- Enter the position (in degrees) with the numeric buttons on the remote control. (Use the left arrow button to erase digits.)
- Select orientation; East or West.
- Press **OK** to save these settings.

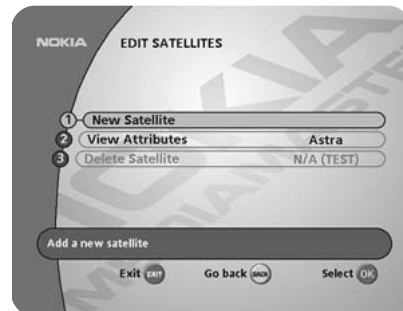

Before you can watch channels from that new satellite you must also carry out the following steps:

For a fixed antenna:

- Select "Antenna/Satellite configuration" in the "System configuration" menu.
- Follow the instructions on page 16 and 17. On the line **Satellite**, select the **new** satellite name.
- Adjust the antenna towards the new satellite. Watch the Signal strength (AGC) and Signal quality (SNR) bar indications to check the levels. **Please note:** In this case, (a brand-new satellite), you do **not** get a TV picture in the background on the screen, even when the SNR indication is good! When both indication bars (AGC and SNR) are good:
- Press the **BACK** button until you return to the "System configuration" menu.
- Select "Channel search".
- Select "Manual" or "Advanced" search.
- Select the new satellite name.
- Enter the settings for Transponder frequency, Polarization etc. for the new satellite.
- Press **OK** to start the channel search procedure in order to download channels from the new satellite.
- When you get the message on the screen that "you have found X new TV-channels and X new radio channels", press **OK** to save the new channels.

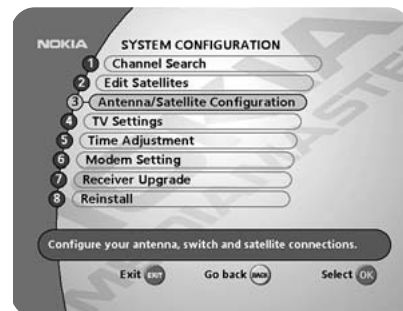

If any new channels are found, they will be saved in the channel list they belong to.

At the same time as you save the new channels, also the settings for the new satellite will be saved.

MAIN MENU

When your antenna is controlled by a motor:

- Enter the "Channel search" menu.
- Select "Manual" or "Advanced" search.
- Select the new satellite name.
- Enter the settings for Transponder frequency, Polarization etc. for the new satellite.
- Select the last line, "Adjust motor", from where you now, by pressing the ◀ ▶ buttons on the remote control, can move the antenna to the position for the new satellite. Watch the Signal strength (AGC) and Signal quality (SNR) bar indications to check the levels. **Please note:** In this case, (a brand-new satellite), you do **not** get a TV picture in the background on the screen, even when the SNR indication is good! When both indication bars (AGC and SNR) are good:
- Press **OK** to start the channel search procedure in order to download channels from the new satellite.
- When you get the message on the screen that "you have found X new TV-channels and X new radio channels", press **OK** to save the new channels.

If any new channels are found, they will be saved in the channel list they belong to.

The position of the new satellite will be added to the pre-programmed satellite positions in the antenna motor.

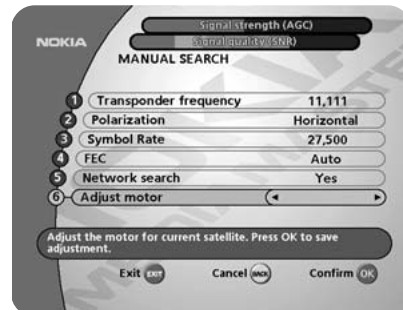

View attributes

Check position and orientation for different satellites by selecting the line "View attributes".

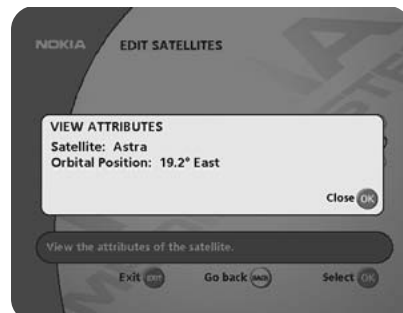

Delete satellite

You can also delete an added satellite. (This is not possible for the factory preprogrammed satellites.)

If you want to delete the satellite from which you right now are watching a channel, you will get a screen message about how to proceed.

When you delete a satellite you also delete its channels from the channel lists.

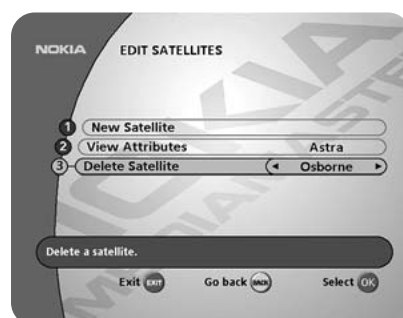

MAIN MENU

Antenna/Satellite configuration

Set up and adjust motor

The procedure is the same as performed during the First Time Installation. Please refer to page 20.

East/West limit setup

You only have to set one or both of these limits if the antenna is prevented from reaching its East/West limit positions. This could be the case e.g. if the antenna is mounted too close to a wall or in any similar situation.

- To set these limits, select East or West limit setup and press **OK**.
- Adjust the antenna using the ◀ ▶ buttons.

Watch the antenna movement, and when it has reached its possible limit, press **OK**. The other limit is set in the same way (if needed).

Reset limits

In case you need to reset limits.

When you perform this command you do not just reset the limits. The motor will also turn itself to the 0° (Zero) position. However, next time you select a channel the motor will turn to its proper position.

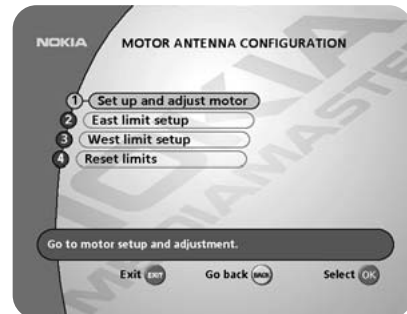
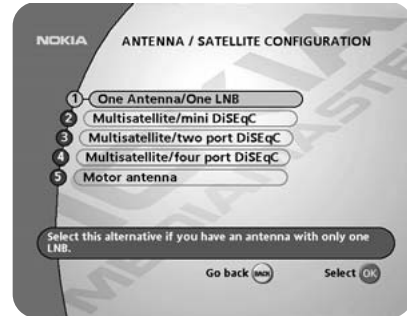

TV settings

TV screen format

Select your TV screen format.

The 4:3 format is the standard format for most TV screens. Select 16:9 for a wide screen TV.

TV signal

If the teletext function does not work when watching channels from an analogue satellite receiver connected to the Mediamaster, change this setting from RGB to PAL.

RF channel

Select this alternative if you have to change the RF channel. If you change the RF channel number, you must also change it to the same value on the TV. If you do not, the picture will become black.

RF modulator type

If the Mediamaster is connected to the TV by an RF cable, you can select the RF modulator type. The RF modulator affects a channel's audio. If you get picture but no sound, the RF modulator selection might be wrong.

Select "**Normal (PAL B/G)**" for all countries except the UK.

Select "**UK (PAL I)**" when the box is used in the UK. →

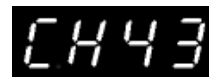
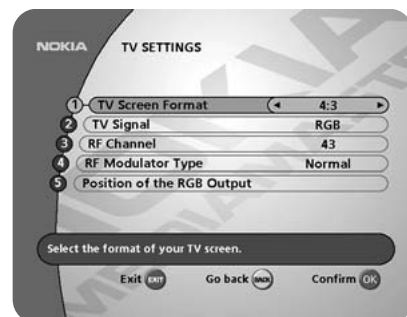

The RF channel number will be indicated on the front display of the Mediamaster.

MAIN MENU

Position of the RGB output

Adjust the horizontal position of the TV picture with the ◀ ▶ buttons. (The "TV signal," see above, must be set to RGB for this function to work.)

Time adjustment

The time is adjusted by using the ▲ ▼ buttons, ±1/2 an hour at a time.

You can also adjust the minutes by using the ◀ ▶ buttons.

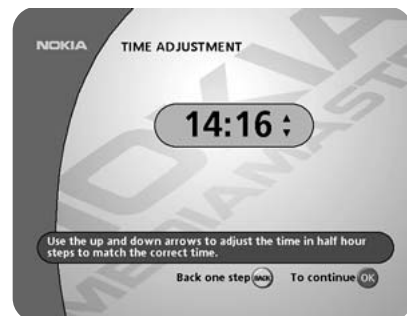

Modem configuration

The modem function is only working in the Scandinavian countries and Greece.

The Mediamaster is equipped with a built in telephone modem. Via the modem so called "interactive services", such as e.g. ordering movies, can be performed.

You will get more information concerning this service by your service provider. More information may also be available in the "System information" menu, ref. to page 42.

When configuring the modem, the following parameters have to be set.

Country: Select the country where the box is installed.

Pulse or tone: Select the alternative valid for your system. If in doubt, please contact your phone operator.

Prefix: If the connection has to pass a switch board, enter the figure that will open the line.

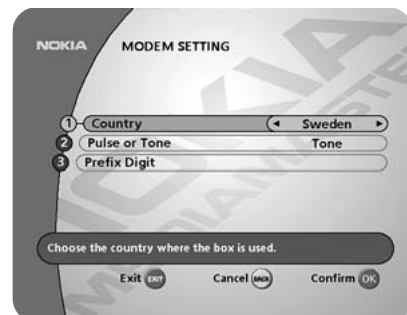

Information about the modem

This equipment has been approved pursuant to Council Decision 98/482/EC [CTR 21] for pan-European single terminal connection to the Public Switched telephone Network (PSTN). However, due to differences between the individual PSTNs provided in different countries, the approval does not, of itself, give an unconditional assurance of successful operation on every PSTN termination point.

In the event of problems, you should contact your equipment supplier in the first instance.

GB 38

MAIN MENU

Receiver upgrade

In order to keep the Mediamaster up-to-date, it will be possible to download new versions of the system software via satellite and from the Internet. New software may include new or improved features for existing menus.

Enter this menu to check for new software. If new software is available you will get information in the menu on how to proceed.

If you download new software from "Nokia Internet pages", you transfer the software from the computer to the Mediamaster via the serial port.

IMPORTANT! Updating via satellite may take a while. The front display will indicate the percent left to download.

NEVER turn off the Mediamaster, never use the remote control or disconnect the antenna/LNB cable during the download procedure! This will damage the software and the receiver will have to be sent in for service!



Reinstall

Use this option **only** if you have to start the complete installation procedure from scratch. If you continue from here, **all** your previous settings, parental code and favourite channels etc. will be erased!

If you do not want to perform a reinstallation you can leave this menu when the warning is displayed by pressing BACK.

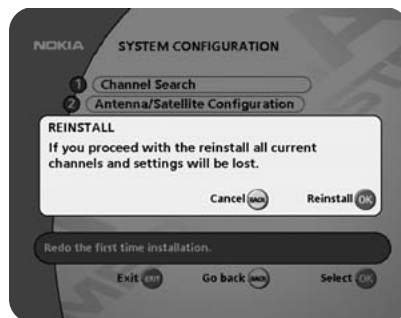

User preferences

From here you can change the menu language. You also have access to the Parental Control and the Appearance menus.

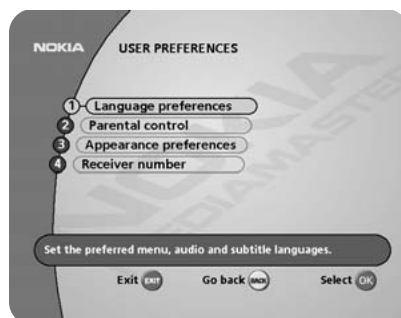

Language preferences

Menu language

Here you may select in which language the menus will be shown .

Main and alternative audio language

If more than one audio language is transmitted, you may select the main and an alternative language.

Subtitles

If you select the "Visible" alternative for subtitling and more than one language is available, you may select a main language and an alternative.

In case you want to control the Teletext function with your TV remote control, this parameter must be set to "Invisible".



MAIN MENU

Parental control

To open this menu you will be asked to enter your access code. **From the factory the access code is set to 1234.**

The following settings can be altered from this menu.

Receiver lock

If you select "On," you will have to enter the access code every time you start the Mediamaster from standby.

Age rating control

If you want everybody to have access to all available types of programmes, select "Off."

If you select "On," you may block programmes unsuitable for children. Select an age limit between 4 and 18 years on the line that appears.

However, you should be aware that not all Service Providers have the necessary codes for these functions implemented in their transmissions.

Do not use this Age rating control function if you are using the Age rating control from any of your Service Providers.

Change access code

From here you can change the access code from the standard 1234. DO NOT FORGET IT! Without it you do not have access to any of the functions where the code is required! If you forget it, you have to contact an Authorized Nokia Service Center to get help.

Application download ("Open TV" applications)

From some channels it is possible to download specific programme applications such as games and various information. When you select the alternative "Manual" below, channels which provide these services will show a symbol in the upper left corner of the screen. By pressing the red button on the remote control you start the download of an application.

Manual: You select to download the application manually. A Symbol will be shown on the screen.

Automatic: When you select a channel containing a downloadable application, it will automatically be downloaded when you select the channel.

Off: It will not be possible to download applications. No symbol will be shown on the screen.

Aut. Viasat: Automatic downloading from the Viasat Service Provider.

To close an application and return to watch TV, press the **P+** or **P-** button on the remote control.



Symbol on screen



During an application download the picture above will be shown on the TV screen

MAIN MENU

Appearance preferences

Banner time-out

When you switch channels, an information banner will be shown for a few seconds. You can select for how long the banner will be shown.

Volume bar

Select whether or not you want the volume bar to appear on the screen when you change the volume.

Volume bar time-out

Select how long the banner will be visible on the screen.

Subtitles

Select whether or not subtitles will be visible on the screen. In case you want to control the Teletext function with your TV remote control, this parameter must be set to "Invisible".

Picture format

If you have a TV set with the 4:3 picture format and the transmission is in 16:9, you can select Fullscreen or Letterbox.

Fullscreen will fill up the screen but cut off some information on the left and right sides.

Letterbox will give a complete picture, but leave black areas at the top and bottom.



fullscreen



letterbox

Receiver number

If you have more than one digital satellite receiver using the same IR protocol, you can use the same remote control to control them. To do that you have to give each receiver a specific number. There are four numbers to choose from.

To access a specific receiver, press **◀ ▶ + X** on your remote control **simultaneously**, where **X** is the number you have assigned for the specific receiver.

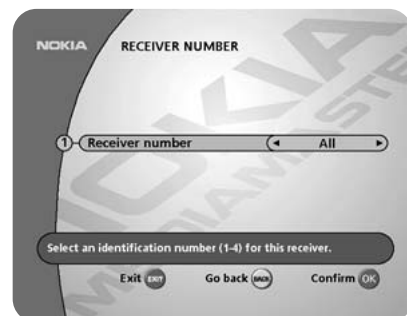

MAIN MENU

System information

If you have to contact your service provider or a service center, they might ask for information available from this menu. Therefore, it is important that you first check the information in the following menus.



System information

This gives general information about which hardware and software version your Mediamaster is running on.

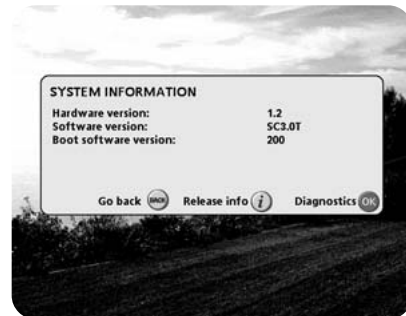

Release info

The alternative "Release Info", from the menu above right, will only be available when the new downloaded software contains information.

If so, by pressing the **i** button you will get a message describing the new functions in the latest software release you have downloaded to the Mediamaster.



Diagnostics

To find out the condition of certain parts of the Mediamaster, you can run a diagnostic test.

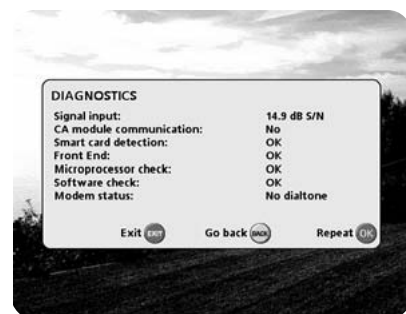

MAIN MENU

Conditional Access

This menu will only be activated if you have inserted a valid Smartcard in the slot behind the front lid.

If more than one CA system is activated, select the one from which you want information.

The Viaccess Conditional Access (CA) System is embedded in the Mediamaster. A Smartcard that supports this standard can be used in the left slot on the front panel.

Different CA modules (with their Smartcards) supporting the DVB Common Interface (CI) standard can be used in the right slot.



Viaccess embedded

From here you get subscription information from a Smartcard supplied by a Viaccess Service Provider.

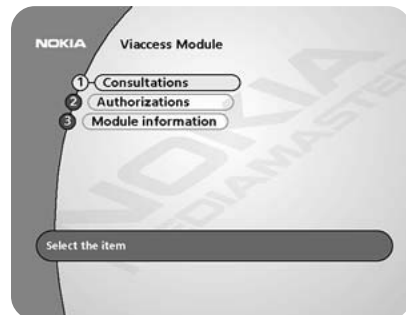

Timer

General

You can program the Mediamaster to start and stop at a predefined time.

The function is very useful when you want to record a programme and you are unable to start/stop the recording event yourself. Or when you just want to be reminded of the start of a programme you do not want to miss.

The display on the box will indicate "t x" (where x is the channel number) during recording/while you are watching a programme started by the Timer function.

Furthermore, a programme that has been started by the Timer function will lock the box. You can not change channels or call up a menu the normal way until the stop time is reached.

However, you can unlock the box by pressing the **MENU** button (about 5-10 seconds) until a channel number appears in the display. Please note, that this is the only recommended way * to unlock the box as long as "t x" is visible in the display.

* Apart from pulling the plug from the mains, which is **not** to recommend!



MAIN MENU

Timer settings

Select **Timer** from the Main Menu.



From this menu you first must select a not already occupied line before you press **OK** to go on with the Timer settings. If you have made earlier settings and any of those are marked, that setting will be replaced with the new one you are going to make!



Select channel list and channel with the ◀ ▶ buttons. The channel can also be entered with the numeric buttons.

The present date (month/day) will automatically be preselect.

Always enter settings with **two digits** for month, day, hour and minute.

If you regret a time or date setting you can erase it with the ◀ button.

When you enter the different start times they can not overlap each other. If you try to enter a start or stop time within an already occupied time event you will be informed about it.

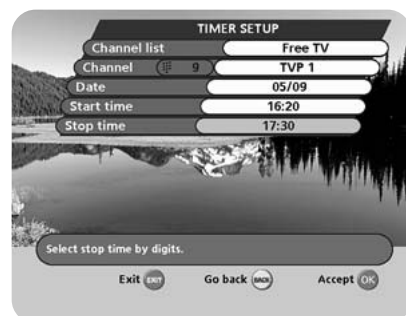

Up to 9 different events can be predefined. The events will be sorted in start time order.

When the box starts from standby mode, it will return to standby at the stop time you have set.

You can erase a predefined event by marking the line and press the ▶ button **twice**.

(If you regret the command after the first press, go to another line by pressing either ▼ or ▲ and the event will not be erased.)



Important information related to the timer settings

If you program the box to start e.g. in the middle of the night (or at any other unsuitable time), be sure to turn the TV set off with the mechanical switch located on the TV! If you turn the TV set off by just putting it into standby mode with the remote control, it will be turned on at the time for the recording!

GLOSSARY OF TERMS

Access

Authorisation to use the coding system to purchase / order TV programmes.

AGC

Automatic Gain Control.

CA

Conditional Access. A system to control subscriber access to services, programmes and events.

CA module

A device for the decoding of scrambled signals.

Common Interface

Describes a DVB standard hardware and software architecture for Conditional Access systems.

DVB

The Digital Video Broadcast group was created to establish a technical framework for the introduction of digital video broadcasting systems.

EPG

Electronic Programme Guide. A software that enables viewers to navigate easily among the large number of channels provided by digital technology, in order to select the service they desire.

FEC

Forward Error Correction. Correction of faulty bits in the received signal.

GHz

The prefix giga means billion, and Hertz means cycles per second. Signals in the GHz range are often called microwaves.

LNB (low-noise block converter)

An electronic unit mounted on the satellite dish. It receives the signals reflected by the dish and converts them to signals that can be used by the Mediamaster.

L.O.

Local oscillator part of the LNB. It converts from the satellite frequency down to a frequency acceptable for the Mediamaster.

Mediamaster

A unit that converts the digital satellite signals into audio and video signals. The audio and video signal can be sent to the TV set either via SCART or via RF (modulator output).

MHz

The prefix mega means million, and Hertz means cycles per second.

MPEG

Moving Picture Experts Group. Established by the International Standards Organisation to provide the basis for a picture coding and compression system.

Network

A number of digital channels transmitted from one source. Grouped under separate headings in the channel list.

Parental control

A feature that allows parents to "lock" programmes that they consider unsuitable for children. A "locked" channel or programme can only be "unlocked" with the special parental access code.

Parental Access code

A four-digit code stored in the Mediamaster. Used to lock the Mediamaster.

PCMCIA

Personal Computer Memory Card International Association. The Common Interface slot follows this standard.

PCR

Program Clock Reference.

PIN code

Personal Identification Number. A four-digit code stored in the Smartcard. For PPV (Pay Per View) or other services together with the subscription.

Polarization

Polarization allows several programmes to be fit into the same frequency band. The signals from a satellite are transmitted either with linear (vertical or horizontal) polarization or circular (right or left) polarization.

RF

Radio frequency (known as HF in some countries).

SERIAL RS 232

A serial communication standard data port.

SCART

A 21-pin connector used for connection of the Mediamaster, VCR and TV. Also named Euroconnector or Peritel connector.

Scrambled satellite TV programme

Some satellite TV programmes are transmitted in scrambled form. A Smartcard, and possibly a CA module, will be needed to view such programmes.

Service provider

Is a company that collects a number of programmes/services and distributes them to customers.

SNR

Signal to Noise Ratio. Signal quality measure.

S/PDIF

Sony/Philips digital interface format. Digital audio output.

Symbol rate

Speed of the digital transmission

SW

Software. Programme code.

TS

Transport stream.

VCR

Video Cassette Recorder.

PROBLEM SOLVING

Problem	Possible causes	What to do
The display on the front panel does not light up/is not lit.	Mains cable is not connected.	Check that the mains cable is plugged into the power socket.
No sound or picture, but the front panel shows the time or -- : --.	The Mediamaster is in standby mode.	Press the standby button or any number button to bring the Mediamaster out of standby mode.
No sound or picture.	The satellite dish is not pointing at the satellite. No signal or weak signal.	Adjust the dish. Check the signal level indicator in one of the channel search submenus. Check the cable connections, LNB and other equipment connected between the LNB and the receiver, or adjust the dish. Replace the LNB.
No sound or picture on horizontal modulated transponder.	The LNB is faulty.	Increase the LNB voltage with 0,5 V from the System Configuration menu if you have a long cable.
Bad picture/blocking error.	The satellite dish is not pointing at the satellite. Signal too strong. Satellite dish is too small. LNB noise factor too high. The LNB is faulty.	Adjust the dish. Connect a signal attenuator to the LNB input. Change to a larger dish. Change to an LNB with lower noise factor. Change the LNB.
There is no Welcome menu on the screen after you switched on the Mediamaster for the first time.	The system is connected by SCART cables and the TV is not in AV/EXT mode. The system is connected by RF cables and the TV is not set to the channel tuned for satellite TV.	If the system is connected by SCART cables, switch the TV to the appropriate AV input. If the system is connected by RF cables, switch the TV to the channel for satellite TV. If you have not tuned in the TV you may do this first. Please look in the TV manual for instructions. You can also change the RF-channel in the Mediamaster. See TV settings.
There is interference on your digital satellite channels, an existing terrestrial channel or video signal.	The system is connected by RF cables and the output channel of the Media-master interferes with an existing terrestrial channel or video signal.	Change the Mediamaster output channel to a more suitable channel between 21-69, or connect the system by SCART cables.
You made a video recording of a satellite channel but the programme was not recorded.	The system is connected by SCART cables and the VCR is not in AV/EXT mode. The system is connected by RF cables and the VCR is not set to the channel tuned for satellite TV.	If the system is connected by SCART cables, switch the VCR to appropriate AV input. If the system is connected by RF cables, switch the VCR to the channel for satellite TV. If you have not tuned in the VCR you may do this first. Please look in the VCR manual for instructions.

PROBLEM SOLVING

Problem	Possible causes	What to do
The remote control is not working.	Battery exhausted. Remote control is incorrectly aimed. The Mediamaster is in standby mode.	Change the batteries (both). Aim the remote control at box. Check that nothing blocks the front panel. Check if (.) is flashing on the front panel display when you press a button. If not replace the batteries (both).
You see the on-screen message. Viewing card error.	The Mediamaster can't recognise your Smartcard.	Check that you are using the proper Smartcard. Check that the Smartcard has been correctly inserted with the gold chip downwards. If the problem persists, you may have a problem with the card. Contact your dealer or Service Provider.
You have forgotten your secret PIN code.		Contact your Service Provider.
CA Module is not working.	CA module is not installed. CA module is not correctly inserted.	Check that the CA module has been correctly inserted. Contact your dealer or Service Provider.
No picture.	CA module is inserted but not working correctly.	Eject the CA module and reinsert it again.

Please note: The first thing to do before sending the Mediamaster to service is to:













- 1: Perform "Diagnostic" procedure in System Information menu.
- 2: Try downloading new software into the Mediamaster.

With this procedure, the new software may solve the problem in the quickest and most efficient way. See the relevant section "Receiver Upgrade" earlier on in this manual.

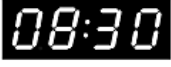
What to do if you can't solve the problem

If you have tried all of the actions suggested above, without solving the problem, please contact your dealer or Service Provider.

FRONT PANEL DISPLAY

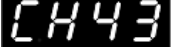
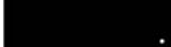
	When power-up, boot version, product family and system software version is shown.		In TV mode.
	When starting from standby, product variant and system software version is shown.		In video mode.
	Remaining time in percent during the download procedure.		When downloading new software via the air.
	The Mediamaster is in standby mode, and current time is shown.		When downloading new software via the Serial RS232 socket.
	Channel number in TV mode.		Error messages. For service personnel
	Channel number in radio mode.		Lights when no signal is being received.
	RF channel in tuning mode.		Flashes when pressing a button on the remote control.

TECHNICAL SPECIFICATIONS

Transmission standards

DVB, MPEG 2

LNB / Tuner input

Connector	1x F-type (LNB)
RF input frequency	920-2150 MHz
RF input power level	-20 to -70 dBm
Supply voltage	13,5 / 18,5 V \pm 5%
Max. current	500 mA, overload protected
Control voltage	22 kHz, 0,65 V _{pp}
DiSEqC	Tone burst A/B or Level 1.2
RF impedance	75 Ω

RF modulator

In-/output connector	IEC female / IEC male
Modulator frequency	470 to 862 MHz
Output level	70 \pm 5dBV
Output channel	21-69
Preset channel	43
Output signal	PAL B/G or PAL I

TV SCART

Video output	1 V _{pp} (\pm 1 dB) / 75 Ω
Audio output	0,5 V _{rms} / R _L > 10 k Ω
RGB output	Internal RGB or from AUX SCART
RGB bandwidth	5,8 MHz \pm 3 dB
Fast blanking output	Internal or from AUX SCART
Status output	0/6/12 V / R _L 10 k Ω

AUX SCART

Video output	1 V _{pp} (\pm 1 dB) / 75 Ω
Video input	1 V _{pp} / 75 Ω
Audio output	0,5 V _{rms} / R _L > 10 k Ω
Audio input	0,5 V _{rms} / R _L > 10 k Ω
Status input	0/6/12 V / R _L > 10 k Ω
Fast blanking input	0/2 V for RGB, bypass to TV SCART
RGB input	Yes

DIGITAL AUDIO (S/PDIF)

Connector	1 x RCA
-----------	---------

AUDIO R L

Connector	2 x RCA (R+L)
Output	0,5 V _{rms} \pm 0,5 dB / R _L 10 k Ω

SERIAL (RS 232) serial data

Connector	9-pin D-sub male
Signals	RS232, max. 57600 bit/s
Pin 1 DCD	(Data carrier detect) not connected
2 RXD	(Receive data)
3 TXD	(Transmit data)
4 DTR	(Data terminal ready) Set to high
5 GND	(Signal ground)
6 DSR	(Data set ready) not connected
7 RTS	(Ready to send)
8 CTS	(Clear to send)
9 RI	(Ring indicator) not connected

Telephone (return channel on the phone line)

Contact	modular 6-pin jack
Protocol	V22, 1200 bits/sec

Security information

The modem connection is made according to the TNV 3 circuit type. All other connections are made according to the SELV circuit type.

Conditional Access system

Embedded Viaccess. One PCMCIA interface for a Common Interface CA module (DVB Standard)

Smartcard Interface

Interface for one card according to ISO 7816
Supports embedded Viaccess descrambler.

Front panel

4x7 segment numeric LED display, Buttons: Φ , \blacktriangledown , \blacktriangle (standby, progr. number up and down)

Other data

The model code, variant and serial number, are located on a label on the underside of the housing.

Supply voltage	95-250 V AC, 50-60 Hz
Power consumption max	27 W at 500 mA LNB load
Power consumption in standby	5 W
Operating temperature	+5° C to +45° C
Storage temperature	- 40° C to +65° C
Humidity	25 to 90 % rel humidity
Operating distance for remote control	max 10 meters
Dimensions (w x d x h)	380 x 240 x 65 mm
Weight	1,8 kg approx

SCART sockets

	TV	AUX
1	Audio out right ch.	Audio out right ch.
2	-	Audio in right ch.
3	Audio out left ch.	Audio out left ch.
4	Audio ground	Audio ground
5	RGB blue ground	RGB blue ground
6	-	Audio in left ch.
7	RGB blue signal out	RGB blue signal in
8	Switch voltage out	Switch voltage in
9	RGB green ground	RGB green ground
10	Connect to pin 10 in AUX scart	
11	RGB green signal out	RGB green signal in
12	-	-
13	RGB red ground	RGB red ground
14	Fast blank. ground	Fast blank. ground
15	RGB red signal out	RGB red signal in
16	Fast blanking out	Fast blanking in
17	Video out ground	Video out ground
18	-	Video in ground
19	Video out	Video out
20	-	Video in
21	Ground (casing)	Ground (casing)





Nokia is a registered trademark of Nokia Corporation

www.nokia.com

66 76963-43



© 0232



Free Manuals Download Website

<http://myh66.com>

<http://usermanuals.us>

<http://www.somanuals.com>

<http://www.4manuals.cc>

<http://www.manual-lib.com>

<http://www.404manual.com>

<http://www.luxmanual.com>

<http://aubethermostatmanual.com>

Golf course search by state

<http://golfingnear.com>

Email search by domain

<http://emailbydomain.com>

Auto manuals search

<http://auto.somanuals.com>

TV manuals search

<http://tv.somanuals.com>