

# **Installation Guide**

## **For the 5000*i*<sup>®</sup> Scanner**

NCS Pearson Publication Number 202 234 027



# **Installation Guide**

## **For the 5000i<sup>®</sup> Scanner**

NCS Pearson Publication Number 202 234 027



Copyright © 1996, 1997, 1998, 2001 NCS Pearson, Inc. All rights reserved. Printed in the United States of America. No part of this book may be reproduced in any form, or by any means, without permission in writing from the publisher.

#### **For Users in the United States**

This equipment complies with the requirements in part 15 of FCC Rules for a Class A computing device. Operation of this equipment in a residential area may cause unacceptable interference to radio and TV reception requiring the operator to take whatever steps are necessary to correct the interference,

#### **For Users in Canada**

The digital apparatus does not exceed the Class A limit for radio noise emission from digital apparatus set in the Radio Interference Regulations of the Canadian Department of Communications.

Le présent appareil numérique n'émet pas de bruits radioélectriques dépassant les limites applicables aux appareils numériques de la classe A prescrit dans le règlement sur le brouillage radioélectrique édicté par le Ministre des Communications du Canada.

5000i and ScanTools are registered trademarks and Dynamic Deskew, Image ScanTools, Image Quality Sentry, NCS Pearson, the NCS Pearson logo, and Picture Perfect are trademarks of NCS Pearson, Inc.

IBM is a trademark of International Business Machines Corporation.

Microsoft, Windows, and Windows NT are registered trademarks of Microsoft Corporation.

# Revision Log

Tab/Rev	Date	Description
	12/96	Manual Released
019	04/97	<p>Deleted all instances of the term NCS where it refers to the product except for the first instance in the preface, p. v.</p> <p>Trademarked the first instance of 5000<i>i</i>, cover page.</p> <p>Added instructions for installing the Catgut board in the microcomputer, pp. 16 and 20.</p> <p>Updated microcomputer installation instructions, pp. 16 and 20.</p> <p>Updated Figure 3-5 illustrating cable connections, p. 25.</p> <p>Updated NCS responsibilities for periodic maintenance in the "Customer Hand-off" section, p. 30.</p> <p>Added Quick Check to the "Customer Hand-off" section, p. 31.</p>
027	10/01	<p>Changed 5000<i>i</i><sup>TM</sup> to 5000<i>i</i><sup>®</sup>.</p> <p>Changed NCS to NCS Pearson.</p> <p>Changed National Computer Systems to NCS Pearson, Inc.</p> <p>Changed Customer Support Services Division to Customer Support.</p> <p>Changed Image ScanTools<sup>®</sup> to Image ScanTools<sup>TM</sup>.</p> <p>Reformatted manual.</p> <p>Edited text to reflect changes in hardware and software; e.g. changed Scanex utility to Scanner Exerciser Utility, updated other menu selections to reflect software changes.</p> <p>Updated physical dimensions of 5000<i>i</i> from 33" x 40" x 24" t "57.5" x 48" x 29", p. 6.</p> <p>Added note under Cabling, Step 5: "Connect this cable to the 15-pin connector on the video card in the first expansion slot. Do not connect to the 15-pin connector on the system board." p. 17 and under Cabling, Step 6, p. 22.</p> <p>Changed "Connect the other end (5 BNCs) to the back of the monitor labeled" to "Connect the other end (15-pin) to the back of the monitor," and removed the list of monitor labels, pp. 18 and 25.</p> <p>Updated Figure 3-2 illustrating changes in Standalone Board/Connector Locations, p. 19.</p> <p>Updated Figure 3-4 illustrating changes in Network Board/Connector Locations, p. 24.</p> <p>Added to Cable Part Numbers and Connections Table: "913 406 005, Gender Changer, HD 15 Female/Female/NA," p. 25.</p> <p>Added to Customer hand-off, step 1, "Output Hopper Height Adjustment Switch - Adjusts the input hopper up or down," p. 30.</p> <p>Changed "ImageTool" to "Image ScanTools<sup>TM</sup>," p. 30.</p> <p>Changed microcomputer to computer.</p>

Publication Number 202 234 027



# Preface

This manual describes how to set up and install the NCS Pearson™ 5000i® scanner. This manual does not document how to install and configure the 5000i system software. 5000i scanner system software is pre-installed and configured at NCS Pearson.

For information on operating the scanner, refer to the *Operator's Guide for the 5000i® Scanner*.

The following components of the system are described in separate manuals:

<b>System Component</b>	<b>Manual Title</b>
5000i Scanner	<i>Operator's Guide for the 5000i® Scanner</i>
	<i>Operator's Quick Reference Card for the 5000i® Scanner</i>
	<i>Quick Check Guide for the 5000i® Scanner</i>
	<i>Maintenance Manual for the 5000i® Scanner</i>
	<i>Parts Manual for the 5000i® Scanner</i>
ScanTools (Windows®)	<i>Image ScanTools™ User's Guide</i>





# Table of Contents

<b>1. SCANNER OVERVIEW .....</b>	<b>1</b>
<b>Overview of the Scanner .....</b>	<b>1</b>
<b>Typical Standalone Configuration .....</b>	<b>2</b>
<b>Customer Support.....</b>	<b>3</b>
<i>Technical Support for Hardware Problems.....</i>	<i>3</i>
<i>Technical Support for Software Problems.....</i>	<i>4</i>
<b>2. SCANNER INSTALLATION .....</b>	<b>6</b>
<b>Preparation .....</b>	<b>6</b>
<i>Hardware .....</i>	<i>6</i>
<i>Software .....</i>	<i>6</i>
<b>Installation .....</b>	<b>7</b>
<b>Checking the Installation Site .....</b>	<b>7</b>
<b>Installing the Scanner .....</b>	<b>9</b>
<i>Unpacking the Scanner.....</i>	<i>9</i>
<i>Spares .....</i>	<i>9</i>
<i>Checking the Voltage.....</i>	<i>10</i>
<i>Site Power Wiring Recommendations.....</i>	<i>14</i>
<i>Electrical Requirements .....</i>	<i>15</i>
<b>3. INSTALLATION OF COMPUTER AND OTHER PERIPHERALS .....</b>	<b>20</b>
<b>Standalone Installation .....</b>	<b>21</b>
<i>Computer .....</i>	<i>21</i>
<i>Work Table .....</i>	<i>23</i>
<i>Monitor and Keyboard .....</i>	<i>23</i>
<b>Network Installation .....</b>	<b>25</b>
<i>Computer .....</i>	<i>25</i>
<i>Monitor and Keyboard .....</i>	<i>28</i>
<i>Networking Equipment .....</i>	<i>29</i>
<b>Internal Cable Connections.....</b>	<b>30</b>

Optional Equipment.....	33
<i>System Printers</i> .....	33
<i>Bar Code Reader</i> .....	34
<b>4. SCANNER CHECKOUT .....</b>	<b>36</b>
Scanner Checkout Procedures.....	36
System Software .....	36
System Verification.....	36
<i>Requirements</i> .....	36
<i>5000i Scanner System Software</i> .....	38
Customer Hand-off .....	38
<b>INDEX .....</b>	<b>41</b>

# Introduction

This manual describes how to install the 5000*i* scanner. The scanner is typically used with a computer, a color monitor, a printer, and can be connected to a server as part of a scanning network system.

This guide is intended for use by NCS Pearson-trained field engineers. It is assumed that the field engineers have had some training or experience in computer setup and installation, scanners and scanning technology, and networks.

**Chapter 1** provides an overview of the 5000*i* scanner's features and parts.

**Chapter 2** describes the process of unpacking and positioning the system components, setting up, and installing the 5000*i* scanner.

**Chapter 3** provides information on installing the scanner computer and other peripherals.

**Chapter 4** provides information on scanner checkout procedures, system software, system verification, and customer hand-off.



# 1. Scanner Overview

This chapter presents an overview of the 5000i scanner and provides information on how to receive technical support for hardware and software problems.

## Overview of the Scanner{ XE "Scanner, 5000i:Overview" }

The 5000i is a device that captures the image{ XE "Image capture" \i } of a form. It sends that image to a host computer for analysis. Figure 1-1 illustrates the parts of the scanner.

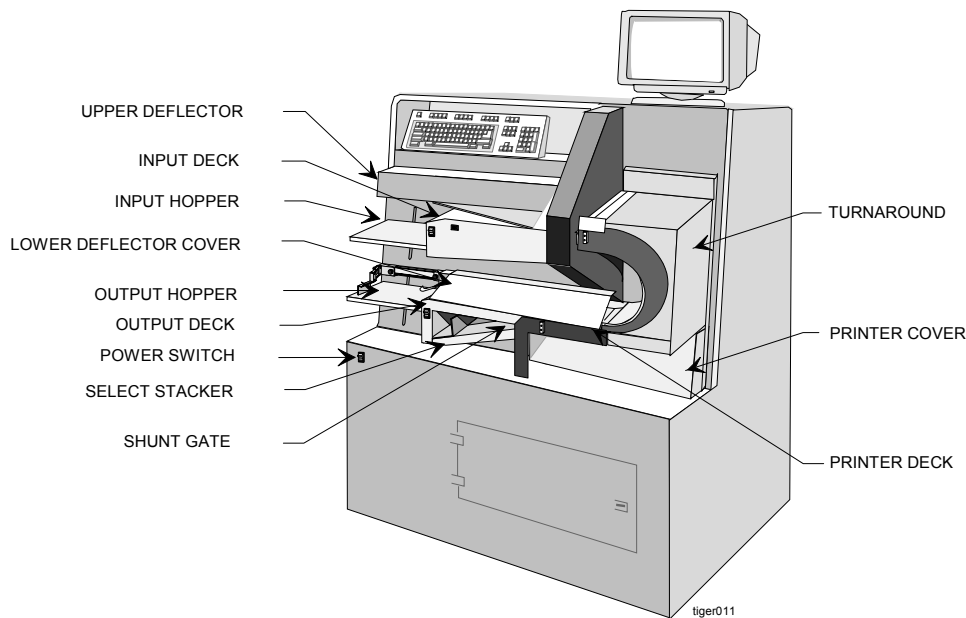

**Figure 1 – 1: Scanner Parts**

In a typical scanning session, these components function as follows:

- The **power switch** { XE "Power switch" } turns on the scanner and any other system components that are plugged into the scanner's internal power strip.
- The **READY switch** { XE "READY switch" } starts and stops the scanner.
- The **input hopper** { XE "Input hopper" \i } holds the forms that are ready to be scanned. When the scanner is made READY, the input hopper raises; when the scanner stops, the hopper lowers, allowing you to load more documents. The input hopper accepts stacks of up to 750 forms, depending on the thickness and condition of the sheets.
- The **input hopper height adjustment switch** { XE "Input hopper height adjustment switch" \i } allows you to adjust the height of the input hopper so that the scanner can pick a sheet. Refer to the *Operator's Guide for the 5000i<sup>®</sup> Scanner* for instructions on setting this adjustment.

- The **output hopper** { XE "Output hopper" } receives the forms that are successfully scanned. When the scanner starts, the output hopper is raised; when the scanner stops, the stacker is lowered, allowing you to remove the sheets. Before scanning, the **output sheet stop adjustment knob** { XE "Output sheet-stop adjustment knob" } should be set to the length of the scanned forms, so they will stack properly. The **output hopper height adjustment switch** { XE "Output hopper height adjustment switch" } adjusts the height at which the hopper halts. Refer to *the Operator's Guide for the 5000i Scanner* for instructions on making these adjustments.
- The scanner picks the forms from the input hopper one at a time. From there, the form moves along the **transport bed** by rollers that continually drive the form into the rail to remove possible skew { XE "Dynamic deskew station" }. The form then passes through the **read heads** where the **cameras** capture the image of the form.
- The form now goes through the **turnaround station**, { XE "Turnaround station" } where the form is turned over and sent to the **wait station**. At this point the software application determines where the form should go. If the system includes the optional **transport printer**, { XE "Transport printer" } then any information that needs to be printed on the form will be sent there. The form is imprinted as it passes over the print head. The form is then sent to one of two places:
  - The **output hopper** accepts up to 750 forms, depending on the thickness and condition of the sheets. This hopper is reserved for forms that are read with no errors.
  - The **select stacker** { XE "Select stacker" } accepts up to 200 forms, depending on the thickness and condition of the sheets. The software controls the hopper's use. It is used for forms with correctable and non-correctable system errors. For example, if the system detects a multiple response on a grid, it sends the form to the select stacker. The operator can fix the form and scan it again.

## **Typical Standalone Configuration { XE "Scanner, 5000i:Standalone configuration" } { XE "Standalone configuration" }**

---

Figure 1-2 illustrates the components of a typical standalone 5000i scanner configuration. The forms image is sent from the 5000i scanner to the computer for processing.

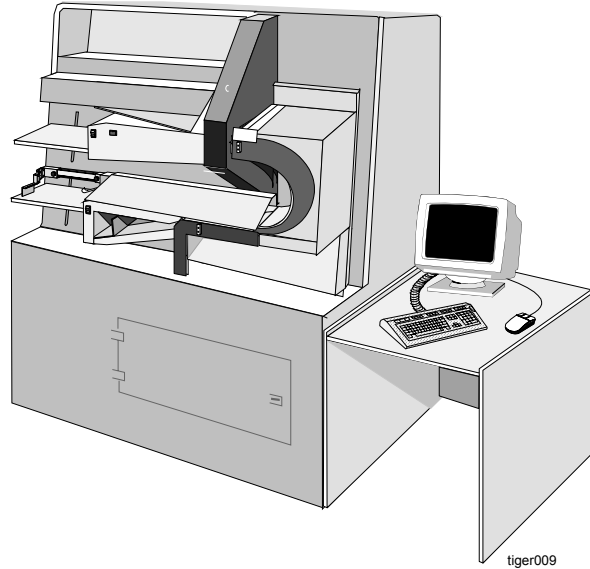

**Figure 1 – 2: Scanner Standalone Configuration**

## Customer Support

---

When you call NCS Pearson Customer Support{ XE "Scanner, 5000i:Customer Support" } { XE "Customer Support" } for either hardware or software technical support, an operator will ask you to describe your problem. The operator will then relay information regarding your problem to a support analyst who will call you back as soon as possible.

**NCS PEARSON CUSTOMER SUPPORT - 1-800-338-5544**

## Technical Support for Hardware Problems

When you have questions concerning the scanner hardware that are not answered in this guide, call NCS Pearson Customer Support.

Before calling, you should:

- Know your Customer ID Number,{ XE "Customer ID number" } your{ XE "Serial number, scanner" } scanner's serial number, and the sheet count. The serial number is located in two places: on the back of the cabinet near the power cord and on the mechanism plate under the outer turnaround deflector.
- Write down a description of your problem. This helps ensure that you will have all the details you need when you talk to a dispatch operator.
- Note all error messages that appear on your computer's screen. Write down any error messages that are related to your problem.
- Have a description of your hardware ready. Include the type of computer or scanner.

## Technical Support for Software Problems

When you have questions concerning the scanner system software, call NCS Pearson Customer Support.

Before calling, you should:

- Write down a description of your problem. This helps ensure that you will have all the details you need when you talk to an analyst.
- Note all error messages that appear on your computer's screen. Write down any error messages that are related to your problem.
- Have a description of your software problem ready. Include the software registration number (located on the software registration card).





## 2. Scanner Installation

---

This chapter describes how to set up and install the standalone 5000i scanner{ XE "Installation:Scanner" },{ XE "Scanner installation:Introduction" } the computer, the monitor, and the mouse.

The 5000i scanner system consists of the following { XE "Scanner installation:Components" }components.

- Model 5000i
- Computer
- SVGA monitor
- Duplex Heads (InfraRed/Red Ink—I/R--heads)
- Transport Printer (optional)
- Bar Code (optional)

### Preparation

---

Before assembling{ XE "Scanner installation:Preparation" } the standalone 5000i scanner, check to make sure that you have all the hardware and accompanying documentation as listed below.

#### Hardware

- Computer with SVGA monitor, keyboard, mouse, and furniture (standalone only)  
Documentation: Manufacturer's user manuals
- A model 5000i image scanner with interface card and cable  
Documentation: *Operator's Guide for the 5000i® Scanner* and the *Maintenance Manual for the 5000i® Scanner*
- Normalization and Calibration forms packet  
Documentation: *Operator's Guide for the 5000i Scanner*

#### Software

- Microsoft® Windows NT® software  
Documentation: *NT User Guide*
- Scanner application software  
Documentation: *Image ScanTools™ User's Guide*
- Scanner Exerciser diagnostic software (or equivalent)  
Documentation: *Operator's Guide for the 5000i* and *Maintenance Manual for the 5000i® Scanner*

# Installation

---

The installation { XE "Scanner installation:Sequence of events" } sequence for the 5000i scanner includes:

1. Check the installation site { XE "Check the installation site" } { XE "Installation site:verify readiness" } to verify that it is ready for setup and installation of the 5000i scanner with its computer, monitor, keyboard, and mouse.
2. Install the scanner.
3. Install the computer, monitor, keyboard, mouse, and furniture.
4. Check the voltages.
5. Connect the network cable (optional)s.
6. Configure the internet network addresses and test the network (optional).
7. Verify that all software has been pre-loaded.
8. Run the **Scanner Exerciser Utility** to check the following:
  - Sheet feeding (in the **Scan Sheets** menu).
  - Selecting and printing (in the **Scan Options** menu).
  - Color selection (under **Configuration**).
9. Run the **Scanner Exerciser Utility** to check alignment (under Check Alignment).
10. Run the **Camera Setup** utility to check and adjust camera/mirror alignment and focus.
11. Run the **Normalize and Calibrate Utility** on the scanner.
12. Run sample application using Image ScanTool.
13. Power off the system.

The above installation sequence and the following instructions serve as a typical step-by-step guide only. They may not exactly fit your setup.

## Checking the Installation Site

---

Before you begin installing the 5000i scanner, verify { XE "Scanner installation:Check the site" } the following site conditions:

- Check the physical dimensions { XE "Installation site checkout:Physical requirements" } { XE "Physical dimensions required" } of the selected site to ensure adequate space.
  - The 5000i scanner is 57.5 inches high, 48 inches wide, and 29 inches deep.
  - If the scanner is near a wall, be sure to leave approximately 24 inches of space between the scanner and the wall. This space is required so that an operator can open the rear panel doors.
- Check that the site selected for the scanner meets all power { XE "Installation site checkout:Power requirements" } { XE "Power requirements" } and environmental requirements { XE "Environmental requirements" } { XE "Installation site checkout:Environmental requirements" }.

- The temperature must be between 60° and 80° Fahrenheit (16 - 27 C).
- The humidity must be between 40% and 60% (non-condensing).
- Heat { XE "Heat dissipation requirements" \i } { XE "Installation site checkout:Heat dissipation requirements" }dissipation is 5300 - 5500 BTU/hr.
- Check that the circuit { XE "Installation site checkout:Power strip" } { XE "Power strip" }from the power source is a dedicated circuit{ XE "Dedicated circuit" } { XE "Installation site checkout:Dedicated circuit" } for the scanner.

## Installing the Scanner

---

The 5000i scanner is delivered to the customer shrink-wrapped and up-right on its own four casters. Roll the scanner to its permanent location.

### Unpacking the Scanner

To unpack { XE "Scanner installation:Unpacking" }{ XE "Unpacking the scanner, procedure" \t "See" }the scanner, do the following:

1. Remove the clear vinyl dust cover.

Do NOT throw the clear vinyl dust cover away. It can be used to protect the scanner

- during periods of non-use, or
  - when moving to another location.
2. Remove the clear plastic shrink-wrap.
  3. Remove the packing materials (sheets of paper) located
    - on the transport bed,
    - on the hopper tables, and
    - between the read head glass.
  4. Remove the packing materials (blocks of styro-foam) located
    - between the printer deck and printer cover (holds the printer cover in place), and
    - between the sliding tray for the PC and interior bulkhead (prevents the PC tray from sliding during shipping).

### Spares{ XE "Spares kit, contents" }

A separate box of { XE "Scanner installation:Spares" }spares is provided with each scanner. This includes the following:

- Retard pads
- Pick belts
- Manuals
- A key for the front panel door

---

**For safekeeping, place the key in the hole located below the printer deck and to the left of the printer cover. Keep the spare retard pads and pick belts in a safe place such as on the computer shelf inside the scanner cabinet. These spares are used as replacements (See the *Operator's Guide for the 5000i Scanner* for instructions on removing/replacing retard pads and pick belts).**

---

## Checking the Voltage{ XE "Scanner installation:Check the voltage" }

Before you plug the 5000*i* scanner into the designated wall outlet, the following power and grounding requirements must be met and maintained to ensure optimum performance of the scanner and its peripherals. To verify that the power and grounding requirements have been met, refer to the following topics: Power Noise, Grounding, and Site Power Wiring{ XE "Wiring" \t "See Site power wiring recommendations" } Recommendations.

### Power Noise

The 5000*i* scanner is designed to operate satisfactorily under conditions of reasonable input power noise. Input power noise specifications { XE "Power noise specifications" } are as follows:

Condition	Description
Definitions	<p><b>Surge or Sag</b> – any sudden positive or negative excursion in the level of the input voltage having a duration from 0.005 to 5 seconds.</p> <p><b>Transient { XE "Transient specifications" }</b>– any sudden positive or negative change in the level of the input voltage having a duration of between 1 nanosecond and 5 milliseconds.</p>
Limits	<p>No surge or sag shall exceed <math>\pm 15\%</math> of the normal rated voltage. However, the surge or sag shall be considered acceptable provided its amplitude does not exceed <math>\pm 50\%</math> of the normal rated voltage and it returns to the steady-state rated level within 3 cycles of input power.</p>
Recommendations	<p>Dedicate a feeder line between the main building power panel and the system branch circuit power panel serving the 5000<i>i</i> system.</p> <p>If transients, surges, or sags outside of the limits stated above exist with a dedicated feeder, do one or both of the following.</p> <ul style="list-style-type: none"> <li>• Install a line conditioner to limit transients.</li> <li>• Use a constant-voltage isolation transformer to control surges or sags.</li> </ul>

### Grounding

Proper system grounding is extremely important to the safe and reliable operation of the system. The 5000*i* scanner ground must meet two requirements:

1. It must serve as a return path for current in case of a short circuit between the power line and the chassis of any system component.
2. It must serve as the ground reference point for the 5000*i* system components and data cables.

### ***Dedicated Ground***

A dedicated isolated/insulated ground { XE "Dedicated ground specifications" }for the 5000i system must be provided. If possible, route a dedicated ground conductor { XE "Conductor:Ground, dedicated" }between the main power panel and the 5000i system branch circuit (with the dedicated feeder). If a dedicated ground conductor is not feasible,

then another code-approved method must be used. (The isolated ground conductor is noted in the National Electrical Code{ XE "National Electrical Code" }{ XE "NEC" \t "See National Electrical Code" }, Section 250-74, Exception 4.) Use of an isolated ground rod or grounding to a water pipe is not acceptable.

An isolated/insulated ground conductor, equal to or larger in size than the heaviest gauge AC feeder conductor in the circuit, should be bonded to the ground bus in the building main power panel. Route it with the circuit conductors in the wiring conduit. Pass this ground through any intermediate panel boards without connection to the panel board grounding terminal bars. The National Electric Code, cited above, allows for the installation at the intermediate panel board of an isolated ground bus, constructed from a terminal block kit, for the interconnection of the isolated ground conductor.

This isolated/insulated ground conductor runs as a single, uninterrupted circuit between the building main power panel and the 5000i system branch power panel. It forms the interconnection point for the third-wire { XE "Ground:Third-wire" \i }grounds of all 5000i system components. Connect all 5000i system component third-wire grounds to this ground; do not connect any equipment other than 5000i system components to this ground conductor. This condition is met if all system components are plugged into the { XE "Switched convenience outlet" \t "See Convenience outlet" }switched convenience outlet{ XE "Convenience outlet:switched" }{ XE "Electrical outlet, convenience" \t "See convenience outlet" \i }{ XE "Outlet, convenience" \t "See Convenience outlet" } in the base of the scanner.

- 
- 1) **At some sites, local regulations require that all installed equipment be connected to a system common ground. In this case, connect all 5000i system components to the common ground at only one point. Connect third wire grounds of system components onto a common bus that is connected to the common ground at a single point.**
  
  - 2) **Make sure the equipment third-wire { XE "Ground:Third-wire" \i }ground (green wire) does not become connected to the conduit at the outlet box or connector. To avoid an inadvertent connection, use a NEMA 5-20R type isolated-ground receptacle, such as a Hubble IG-5362.**
- 

### ***Grounding in Multi-Story Buildings{ XE "Grounding:In multistory building" \i }***

When installing the 5000i system in a multi-story building{ XE "Multistory building, grounding" \t "See Grounding in multistory building" }, provide a low noise ground by connecting the isolated { XE "Conductor:Isolated/insulated" }ground { XE "Ground:Conductor" \i }of the system to the structural steel of the building. Install the isolated ground system as described above. In addition, bond one end of a heavy gauge wire or copper braid to the isolated ground bus in the branch circuit panel serving the 5000i system. Weld the other end of this wire or braid to the nearest vertical steel structural member. Do not substitute a water pipe or an isolated ground rod for the vertical steel member.



**Ground-To-Neutral Specifications**{ XE "Conductor:Specifications, ground-to-neutral" \t "See" }{ XE "Voltage:Ground-to-neutral" }

With circuit power turned off, the resistance between the circuit neutral conductor{ XE "Conductor:Neutral" }{ XE "Neutral conductor" \t "See Conductor, neutral" } and the isolated ground conductor must be less than 2.1 ohms.

With circuit power on and all 5000i system components unplugged, the voltage between the circuit neutral conductor and the isolated ground conductor must be less than 0.6 VAC.

## Site Power Wiring Recommendations

The table below describes the conditions{ XE "Scanner installation:Site power wiring recommendations" }{ XE "Power wiring recommendations" }for power wiring at a scanner site.

Condition	Description
Dedicated Feeder	Run a separate dedicated feeder from the building main power panel to the branch power panel serving the 5000 <i>i</i> system. The cabling should be of sufficient diameter to produce no less than 110V at the outlet when the 5000 <i>i</i> is connected and powered on. This feeder should be a minimum of 30 amp service to allow for future growth of the system.
Dedicated Isolated/ Insulated Ground	An isolated/dedicated ground is required. Run this ground conductor as an uninterrupted circuit from the power panel to the 5000 <i>i</i> system branch panel. The gauge of this conductor must be at least as large as that of the AC circuit conductors in all stages of the circuit.
Panel Branch Circuits	All branch circuits leaving the 5000 <i>i</i> branch power panel should be at least 10 AWG copper wire. There should be no circuits from this power panel serving devices that are not part of the 5000 <i>i</i> system.  One branch circuit from this power panel should be dedicated at the scanner (this circuit will also service the computer and monitor), and there should be at least one additional dedicated circuit for each additional scanner.
Additional Utility Convenience Connectors	Provide additional convenience outlets in the vicinity of the 5000 <i>i</i> scanner. Connect these outlets (may be used for vacuums, paper jiggers, and other electrical devices) to a branch panel other than the scanner branch panel to provide maximum noise isolation for the 5000 <i>i</i> system components.
Scanner Electrical Connections	Dedicate one 15 amp (120 VAC) or 7.5 amp (220 VAC) circuit to each 5000 <i>i</i> scanner at the site. All may be served from the same branch panel, provided its rated capacity is not exceeded.
Electrical Outlets{ XE "Electrical outlet" \i }	All 120V outlets for the 5000 <i>i</i> scanner should be Hubble IG-5362 or equivalent (NEMA 5-20R). All 240V outlets should be Hubble IG2410A or equivalent. Outlets for the peripheral equipment should be of the type and rating specified in the hardware reference manuals for the equipment.  The quantity of outlets that must be provided for the peripheral equipment varies according to system configuration. (See Panel Branch circuits above.) Outlets should be located within 6 feet (2 meters) of the working location of the equipment.

## Electrical Requirements{ XE "Scanner installation:Electrical requirements" }

The steady-state line-to-neutral voltage should be maintained within -10% to +5% of the normal rated voltage. The short term and long term frequency variations must be maintained at less than  $\pm 5\%$  of the specified power line frequency, as measured at the input power side of the scanner when it is powered on. The table below lists the electrical requirements for the power operation of the 5000i scanner.

Power	Frequency Limits	Voltage Limits	Other Data
Standard	60 HZ $\pm 5\%$	115V $\pm 10\%$	On 15 Amp., single-phase dedicated circuit.
Option 1	50 HZ $\pm 5\%$	100 or 110V $\pm 10\%$	On 15 Amp., single-phase dedicated circuit.
Option 2	50 HZ $\pm 5\%$	220 or 240V $\pm 10\%$	On 7.5 amp., single-phase dedicated circuit.

After you have verified the power and grounding requirements, perform the "Power Supply Check-out Procedures."

### ***Power Supply Check-out Procedures{ XE "Scanner installation:Power supply checkout procedure" }***

Perform the following checks with the scanner on but with the transport bed motor off (unless otherwise directed by the procedure).

The 5000i scanner is equipped with four power { XE "Power supply:Checkout procedures" } supplies.

They are:

- 914 022 769, +12V 250W Power Supply
- 914 022 264, +12V 200W Solenoid Boost Power Supply (Unregulated)
- 914 022 744, +5V Power Supply (LEDs){ XE "Power supply:+5V logic" }
- 914 022 751, +5V and  $\pm 15V$  Logic Power Supply

The +12V, 250W power supply produces +12.5V { XE "Power supply:12.5V logic" } for the transport bed solenoids and hopper drive motors. The +12V, 200W, power supply produces +12V boost voltage to pull the solenoids. The +5V power supply{ XE "Power supply:+5V logic" } produces +5V for the read head LEDs. The logic power supply produces +5V, +15V and -15V logic power for the cameras and various scanner PC boards.

The logic power supply and the LED power supply require periodic check-out and adjustment. In addition, the 12V, 250W power supply needs to be adjusted to 12.5V. If any voltage is outside the proper range, adjust the outputs as described in the following "Logic Voltage Checkout Procedures." If you cannot adjust the output, replace the power supply. There are no field repair procedures for any of the scanner's power supplies.

## Logic Voltage Check-out Procedure{ XE "Adjustment:Multivolt logic power supplies" }

The outputs of the power supplies { XE "Power supplies, multivolt logic:Adjustment" } { XE "Power supplies, multivolt logic:Voltage checkout procedure" } { XE "Logic power supplies" } \t "See power supplies, multivolt logic" } are read at their most critical point – the input to the Camera Controller board, the Solenoid Clutch Activation board, and the Top LED Mother board.

1. Turn on the scanner power switch.
2. Use a DVM to measure { XE "Measurement:Multivolt logic power supply" } the outputs to the voltages { XE "Checkout:Logic voltages" } { XE "Logic voltages" } { XE "Voltage:Power supply, multivolt logic" } listed in Table 2-4. Be sure to connect your ground probe to TPG1, TPG2, TPG3, or TPG4 on the Camera Controller board.

Table 2- 4

Nominal Voltage	Camera Controller Pin Location	Solenoid Clutch Activation Board (SCAB) Pin Location	Top LED Mother Board Pin Location	Acceptable Range
+5V{ XE "Logic power supply" \t "See power supply, +5V logic" }	J5 - 3			+4/95 to +5.20V DC
-15V	J5 - 1			-15.0 to -15.20V DC
+15V	J5 - 2			+15.0 to -15.20V DC
Ground	TPG1, TPG2, TPG3, TPG4			
+12.5V		J9 - 4		+12.5 to +13V
+V Boost		J9 - 7		+12 to +16V
+5V			J3 - 1	+5 to +5.5V

### +12V Boost Power Supply

There are no adjustments{ XE "Power supplies, multivolt logic:Voltage outside specified range" } { XE "Power supplies, multivolt logic" } \t "See Power supply, 15V logic" } { XE "Power supplies, multivolt logic" } \t "See Checkout procedures - logic voltages" } to the +12V, 200W boost power supply{ XE "Checkout:Power supply voltages" } { XE "Power supply voltages" }. If its output is not +12.5V{ XE "+12.5V power supply" } \t "See Power supply, +15V" } to 16V{ XE "Power supply, +15V:No adjustments" }, replace the supply{ XE "Power supply:No field repair" }.

### Location of the Power Supplies

Figures 2-1 and 2-2 illustrate the location of the power supplies { XE "Checkout:Multivolt logic power supply voltage" } { XE "Multivolt logic power supply voltage" } and the location of

the adjustment potentiometers. The power supplies that may require checkout and periodic adjustments are:

- +12V, 250W, Solenoid{ XE "Solenoid:Voltage source" } and DC Motors Power Supply (adjusted to +12.5V){ XE "Power supply, +12.5V voltage" || XE "Power supply, 12.5V logic:Voltages" }
- +5V LED Power Supply
- +5V{ XE "Power supply, +5V logic:Voltages" } and  $\pm 15V$  Logic Power Supply{ XE "Power supply, +15V:Voltage checkout" }

---

**The Logic Power Supply is labeled  $\pm$ { XE "Voltage: $\pm 12.5$  power supply" }12V, but it should be adjusted to  $\pm 15V$ .**

---

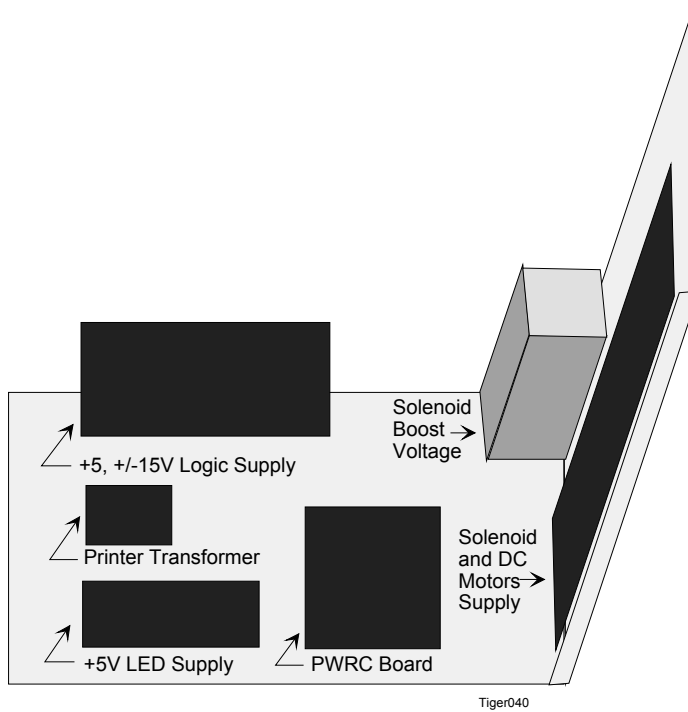

**Figure 2 – 1: Location of the Power Supplies**

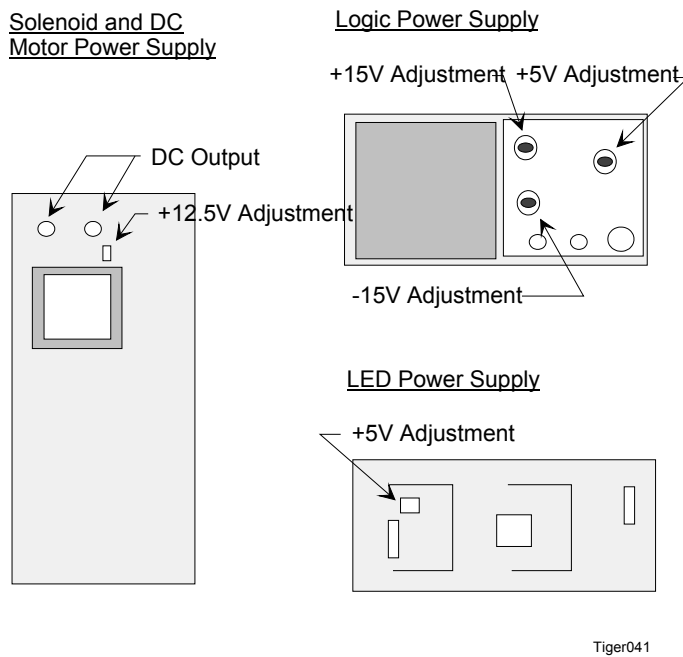

**Figure 2 - 2: Adjustment Locations**



# 3. Installation of Computer and Other Peripherals

---

This chapter provides information on setting up and installing the computer and other peripheral components in a 5000i scanner standalone or network configuration. Installation information on optional equipment, such as a system printer and/or Bar Code Reader, is also provided.

Begin by unpacking the computer, the monitor, and the keyboard. Unpack other equipment as required. Refer to the manufacturer's user manuals for installation instructions and assistance when performing the procedures discussed on the following pages.

**CAUTION: The monitor and printer power cords should be plugged into AC wall outlets or a power strip located outside the scanner.**

There may be situations where you are installing additional 5000i scanners, additional peripheral equipment, or printers and you need to power the system down. In this case, you should use the following shutdown procedures.

- Hold down the ALT key and press F4. The following menu is displayed.

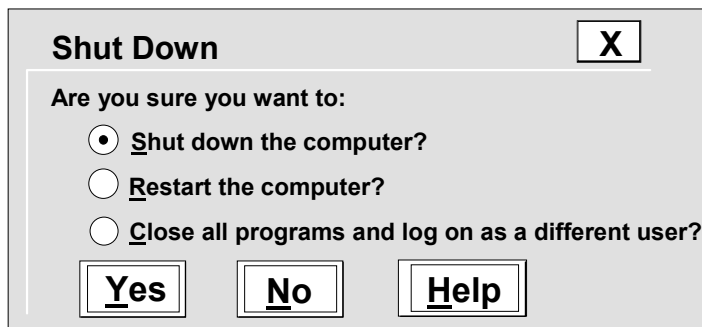

tigsm15

- Click on **Shut down the computer?**
- Click on **Yes.**

Wait for the message **It is now safe to turn off the computer**, and then turn off your computer.



## Standalone Installation

---

The 5000i scanner in a standalone configuration requires a computer, a monitor, a keyboard, a mouse, and a table (for the monitor, keyboard, and mouse). An optional printer may also be installed.

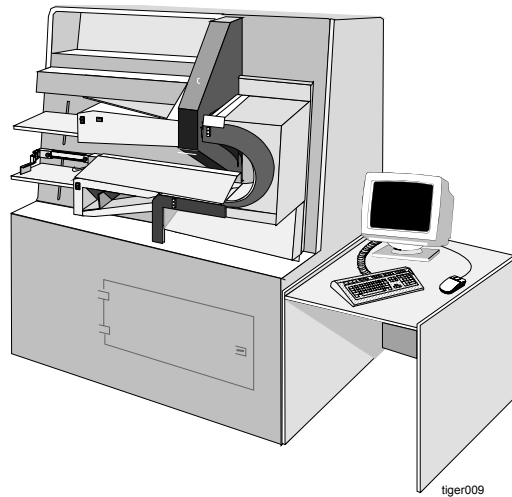

Figure 3 – 1: Standalone Configuration

### Computer{ XE "Standalone installation:Computer" }

This section discusses installation and internal cabling for the computer in a standalone configuration.

#### *Installation*

Before installing { XE "Computer:standalone checkout" } { XE "Computer:Preparing for standalone installation" } the computer in the scanner, do the following.

1. Use your fingers (or a screwdriver) to remove the screw (knurled knob) at the rear of the computer (center-top) and lift off the cover. Some models have green plastic covered screws, and some have two screws.

**CAUTION: Use ESD precautions (including a grounded wrist strap) for steps 2, 3, and 4.**

2. Make sure that the scanner interface cards and all ribbon cables are fully seated.
3. Remove the Catgut board{ XE "Catgut board" } from its separate packaging and do the following:
  - Ensure that the three 40-pin DIP and one 40-pin SIP headers which connect the Catgut II board to the Catgut I board are fully seated.
  - Ensure that the SIMMs on the Catgut II{ XE "Daughter card (Catgut II)" } { XE "Catgut II (daughter card)" } board are fully seated.

- Attach one end of the Hobbes to Catgut cable assembly (flat, 40-pin polarized cable) to the Hobbes board{ XE "Hobbes board" \i }.
  - Set the Catgut board into the PCI slot – two slots to the right of the Hobbes board – making certain that the Catgut board (and the Hobbes board) are firmly seated.
  - Attach the other end of the Hobbes to Catgut cable to the Catgut board.
4. Ensure that the high density ribbon cable connector connecting the Hobbes board to the Catgut board is fully seated.
  5. Replace the cover on the computer.
  6. Open the rear panel doors and place the computer on the shelf. The front of the computer must face the front of the scanner.

## **Cabling**

In preparation for{ XE "Standalone installation:Cabling" } cabling, NCS Pearson recommends that you do the following:

- Set the computer on the back lip of the shelf during cable installation so that the back of the computer is tilted up. This provides easier access to the computer's ports.
- Uncoil all cords and cables, separate them, and lay them out on the floor.

The following cabling instructions are for a standalone configuration{ XE "Cabling:Standalone configuration" }. Refer to Figures 3-4 and 3-5, and Table 3-1 at the end of this chapter.

1. Install the computer power cord.
  - Attach the power cord connector to the back of the computer.
  - Ensure that the other end is plugged into the scanner's power strip.
2. Complete installation of the 25-pin straight through cable - the **PRTCON** board (for the optional printer) to the back of the computer.
  - One end of this cable is already attached to the **PRTCON** board.
  - Connect the other end (free end) to the back of the computer.
3. Complete installation of one 6-pin DIN cable - the **KEMCON** board (for the keyboard) to the back of the computer.
  - One end of this cable is already attached to the **KEMCON** board.
  - Connect the other end (free end) to the back of the computer in the keyboard port.
4. Complete installation of the other 6-pin DIN cable - the **KEMCON** board (for the mouse) to the back of the computer.
  - One end of this cable is already attached to the **KEMCON** board.
  - Connect the other end (free end) to the back of the computer in the mouse port.
5. Complete installation of the 5 BNC/15-pin DIN cable - from the bulkhead (for the monitor) to the back of the computer.
  - One end (5 BNC end) is already attached to the bulkhead.
  - Connect the other end (15-pin DIN) to the back of the computer.

---

**Connect this cable to the 15-pin connector on the video card in the first expansion**

**slot. Do not connect to the 15-pin connector on the system board.**

---

6. Complete installation of the 50-pin high density ribbon cable - the **Camera Controller** board to the Hobbes interface connector on the computer.
  - One end of this cable is already connected to the scanner's **Camera Controller** board at J1.
  - Connect the other end (free end) to the external connector for the scanner interface (Hobbes) card (P2) on the back of the computer.
7. Complete installation of one 9-pin D cable - the **Scanner Controller** main board to the Com1 port on the back of the computer.
  - One end of this cable is already attached to the scanner's **Scanner Controller** main board at J9.
  - Connect the other end (free end) to the **Com1** port on the back of the computer.

Once all computer cabling connections have been made, set down the computer flat on the shelf, coil any extra cabling under the computer shelf, and close the rear panels.

## Work Table

The standalone 5000i scanner comes with a { XE "Standalone installation:Work table" }work table. This work table is for the monitor, the keyboard, and the mouse. Instructions for assembling the work table are provided by the manufacturer.

## Monitor and Keyboard

Place the monitor, the keyboard, and the mouse on the work table. The monitor, the keyboard, and the mouse need to be cabled to the computer. (See Figure 3-5 for cable locations.)

### ***Monitor{ XE "Standalone installation:Monitor" }***

1. Connect the power cord:
  - Plug the female end of the power cord into the port labeled **AC Outlet** on the back of the monitor.
  - Plug the other end (male end) into an AC wall outlet or power strip.
2. Ensure that the monitor cable is connected. (See Step 6 under cabling.)
3. Complete installation of the 5 BNC cable - from the bulkhead to the back of the monitor.
  - Connect one end of this cable to the bulkhead. Install the cable according to the colors labeled on the bulkhead.
  - Connect the other end (15-pin) to the back of the monitor.

### ***Keyboard and Mouse{ XE "Standalone installation:Keyboard and mouse" }***

1. Plug the keyboard cable connector into the port labeled **KEYBOARD** located on the scanner's back panel (bottom and second cutout from the left).
2. Plug the mouse cable connector into the port labeled **MOUSE** located on the scanner's back panel (bottom and second cutout from the left).

## Board/Connector Relationship

Figure 3-2 illustrates the relationship between PC boards { XE "Standalone:Board/connector relationship" } attached to the bulkhead inside the cabinet and the connectors on the exterior surface of the cabinet.

---

**There is a LINE PRINTER/NETWORK connector on the bottom left side of the cabinet. Only the LINE PRINTER connector is used in a standalone configuration.**

---

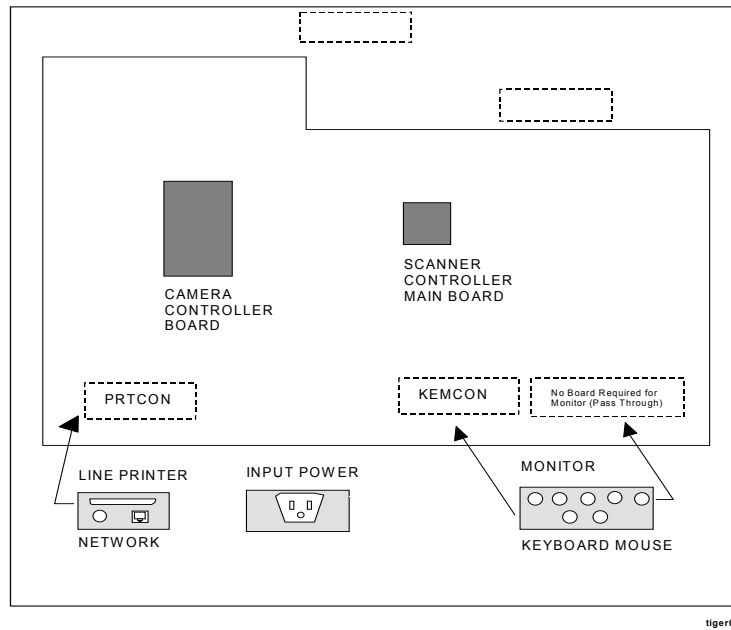

**Figure 3 – 2: Standalone Board/Connector Locations**

## Network Installation{ XE "Scanner, 5000i:Network configuration" }

---

The 5000i scanner in a network configuration requires an NCS Pearson-supplied computer, monitor, keyboard, mouse and required networking equipment. An optional printer may also be installed.

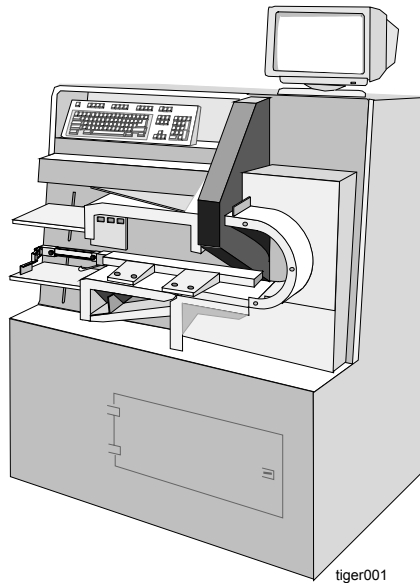

Figure 3 – 3: Network Connection

### Computer

This section discusses installation and internal cabling for the computer{ XE "Network installation:Computer" } in a network configuration.

#### *Installation*

Before installing the computer in the scanner, do the following.

1. Use your fingers (or a screwdriver) to remove the screw (knurled knob) at the rear of the computer (center-top) and lift off the cover. Some models have green plastic covered screws, and some have two screws. Some models have green plastic covered screws, and some have two screws.

**CAUTION: Use ESD precautions (including a grounded wrist strap) for steps 2, 3, and 4.**

2. Make sure that the scanner interface cards and all ribbon cables are fully seated.
3. Remove the Catgut board from its separate packaging and do the following:
  - Ensure that the three 40-pin DIP and one 40-pin SIP headers that connect the Catgut II board to the Catgut I board are fully seated.

- Ensure that the SIMMs on the Catgut II board are fully seated.

- Attach one end of the Hobbes to Catgut cable assembly (flat, 40-pin polarized cable) to the Hobbes board.
  - Set the Catgut board into the PCI slot – two slots to the right of the Hobbes board – making certain that the Catgut board (and the Hobbes board) are firmly seated.
  - Attach the other end of the Hobbes to Catgut cable to the Catgut board.
4. Ensure that the high density ribbon cable connector connecting the Hobbes board to the Catgut board is fully seated.
  5. Replace the cover on the computer.
  6. Open the rear panel doors and place the computer on the shelf. The front of the computer must face the front of the scanner.

## **Cabling**

In preparation for cabling{ XE "Network Installation:Cabling" }, NCS Pearson recommends that you do the following:

- Set the computer on the back lip of the shelf during cable installation so that the back of the computer is tilted up. This provides easier access to the computer's ports.
- Uncoil all cords and cables, separate them, and lay them out on the floor.

The following cabling instructions are for a network configuration{ XE "Cabling:Network configuration" }. Refer to Figures 3-4 and 3-5, and Table 3-1 at the end of this chapter.

1. Install the computer power cord
  - Attach the power cord connector to the back of the computer.
  - Ensure that the other end is plugged into the scanner's power strip.
2. Complete installation of the 25-pin straight through cable - the **PRTCON** board (for the optional printer) to the back of the computer.
  - One end of this cable is already attached to the **PRTCON** board.
  - Connect the other end (free end) to the back of the computer.
3. Complete installation of the network cable (10BaseT, 10Base2, or Token Ring) - the **NETCON** board (for the network) to the back of the computer.
  - One end of this cable is already attached to the **NETCON** board.
  - Connect the other end (free end) to the back of the computer.
4. Complete installation of one 6-pin DIN cable - the **KEMCON** board (for the keyboard) to the back of the computer.
  - One end of this cable is already attached to the **KEMCON** board.
  - Connect the other end (free end) to the back of the computer in the keyboard port.
5. Complete installation of the other 6-pin DIN cable - the **KEMCON** board (for the mouse) to the back of the computer.
  - One end of this cable is already attached to the **KEMCON** board.
  - Connect the other end (free end) to the back of the computer in the mouse port.

6. Complete installation of the 5 BNC/15-pin DIN cable - from the bulkhead (for the monitor) to the back of the computer.
  - One end (5 BNC end) is already attached to the bulkhead.
  - Connect the other end (15-pin DIN) to the back of the computer.

---

**Connect this cable to the 15-pin connector on the video card in the first expansion slot. Do not connect the cable to the 15-pin connector on the system board.**

---

7. Complete installation of the 50-pin high density ribbon cable - the **Camera Controller** board to the Hobbes interface connector on the computer.
  - One end of this cable is already connected to the scanner's **Camera Controller** board at J1.
  - Connect the other end (free end) to the external connector for the scanner interface (Hobbes) card (P2) on the computer.
8. Complete installation of one 9-pin D cable - the **Scanner Controller** main board to the Com1 port on the back of the computer.
  - One end of this cable is already attached to the scanner's **Scanner** Controller main board at J9.
  - Connect the other end (free end) to the **Com1** port on the back of the computer.

Once all computer cabling connections have been made, set down the computer flat on the shelf, coil any extra cabling under the computer shelf, and close the rear panels.

## Monitor and Keyboard

Place the monitor on top of the scanner on the right-hand side (Figure 3-3). Install the keyboard using the four pressure sensitive adhesive backed velcro pads that were shipped with the keyboard. Peel off the paper backing on one side of the pads and affix to the four corners of the keyboard. Peel off the paper backing from the other side and affix the keyboard to the angled shelf on the upper left-hand side of the scanner. Place the mouse and mouse pad on the flat surface just to the right of the keyboard (Figure 3-3).

To cable the monitor and the keyboard to the computer, do the following.

### ***Monitor{ XE "Network installation:Monitor" }***

1. Attach the power cord.
  - Plug the female end of the power cord into the back of the monitor.
  - Plug the male end into a nearby AC power outlet or a power strip.
2. Ensure that the monitor cable is properly connected. (Refer to Step 7 under "Cabling.")
3. Complete installation of the 5 BNC cable - from the bulkhead to the back of the monitor.
  - Connect one end of this cable to the bulkhead. Install the cable according to the colors labeled on the bulkhead.
  - Connect the other end (15-pin) to the back of the monitor.



### **Keyboard and Mouse{ XE "Network installation:Keyboard and mouse" }**

1. Plug the keyboard cable into the port labeled **KEYBOARD** located behind the angled panel next to the keyboard.
2. Plug the mouse cable into the port labeled **MOUSE** located behind the angled panel next to the keyboard.

### **Networking Equipment{ XE "Network installation:Networking equipment" }**

5000i scanners may be integrated into networking configurations consisting of third-party equipment.

The appropriate vendor personnel are responsible for unpacking, setting up, configuring, and testing the networking equipment. NCS Pearson field engineers are responsible for positioning the networking equipment in accordance to the system and network layout plans. These plans should be made available by the site preparation project manager.

Once the 5000i scanner has been installed and the networking equipment has been positioned, you can now connect the scanner to the network cable. Before connecting the cable to the system, verify the following:

- The scanner is positioned in the appropriate location.
- The network cable is installed.
- The 5000i and peripherals are turned off.
- The cable is in good condition. It should not be crimped, have damaged insulation, and it should not be placed near heat sources, power cables, or high traffic areas without adequate protection.

### **Connecting a Scanner to a Network{ XE "Network installation:Connecting to a network" }**

1. Locate the network cable for the scanner. A network connector (10BaseT, 10Base2, or Token Ring) should be attached to the network cable and located near each scanner (if more than one).
2. Attach the network connector (10BaseT{ XE "Cable, 10BaseT" \t "" }, 10Base2{ XE "Cable, 10Base2" }, or Token Ring) to the jack labeled **NETWORK** located on the scanner's back panel (bottom and second cutout from the left).
3. Repeat steps 1 and 2 for each additional scanner.
4. Connect the other end of each network cable (from each scanner) to the network concentrator.
5. Locate and attach the cable from the concentrator to the connector jack located on the back of the file server.

## Board/Connector Relationship

Figure 3-4 illustrates the relationship between PC boards{ XE "Network installation:Board/connector relationship" } attached to the bulkhead inside the cabinet and the connectors on the exterior surface of the cabinet in a network configuration.

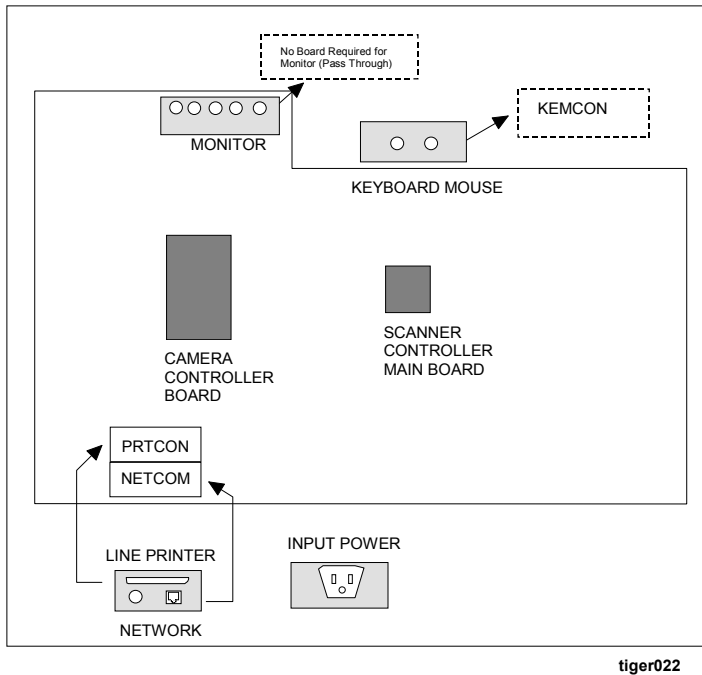

Figure 3 – 4: Network Board/Connector Locations

## Internal Cable Connections{ XE "Internal cable connections" }

This section provides additional information regarding connection of the monitor, keyboard, mouse, cameras, power, network, and printer (optional) cables to the appropriate connectors on the boards located inside the scanner (Figure 3-4).

**The PRTCON, NETCON, and KEMCON, boards are attached to the interior of the scanner's bulkhead to provide an appropriate exterior connection to both standard and optional devices.**

The PC boards include the following:

- Scanner Controller main board (bed control logic).
- Camera Controller board (camera, light source, and pixel normalization logic).
- NETCON board (Network).
- KEMCON board (Keyboard and mouse).
- PRTCON board (Printer, optional).

The schematic in Figure 3-5 identifies the cable connections to the appropriate boards and the appropriate connections of these cables to ports on the computer. The scanner is shipped with the

cables already connected to the appropriate boards. Because the computer is shipped separately, you must install the computer and then make the necessary cable connections.

Figure 3-5 is a schematic illustrating a typical configuration; it may change depending on version of computer. Table 3-1 lists cables, part numbers, and connection.

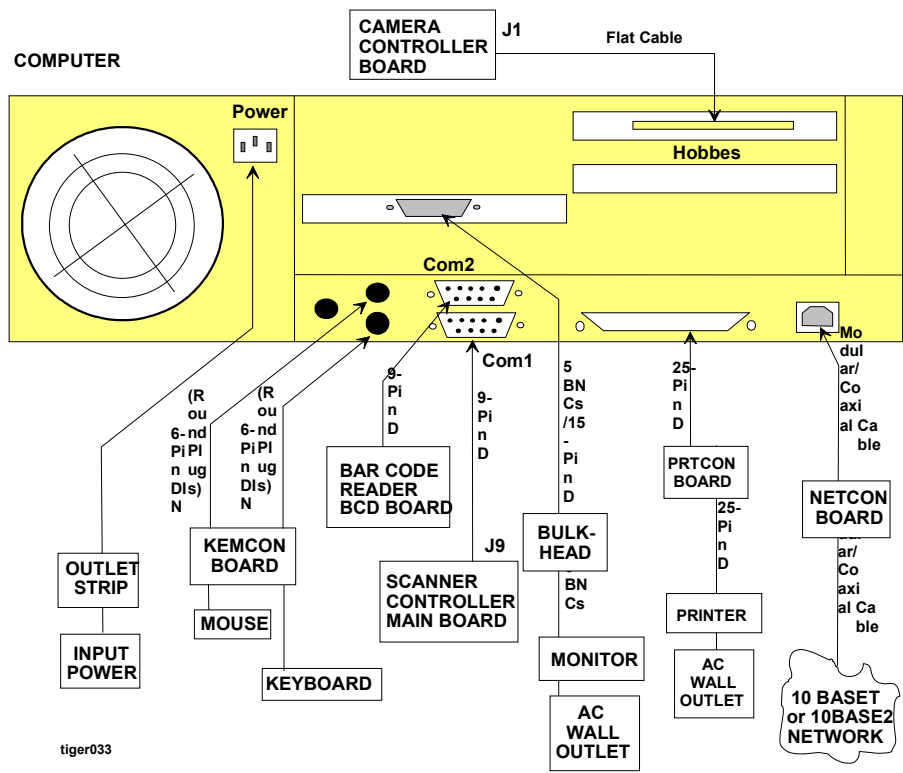

Figure 3 – 5: Computer and PC Board Connections{ XE "PC boards" }

Table 3 – 1: Cable Part { XE "Cable part numbers" }Numbers and Connections

Part Number	Description	Type	PC Connection
322 701 004	Scanner controller	9-pin D	Com1
342 915 006	Hobbes, camera controller	50-pin flat cable	Hobbes connector
920 256 005	Bulkhead to Monitor	5 BNCs	N/A
913 406 005	Gender Changer	HD 15 Female/Female	N/A
920 256 013	Bulkhead to PC	5 NBCs/15-pin D	Video
920 401 015	Keyboard/Mouse connectors (2)	6-pin DIN (round plug)	KeyBrd/Mouse
920 401 023	Printer connector	25-pin D	Parallel
913 027 017	Phone-14' wire male	Modular cable	10BaseT
920 255 007	BNC Coaxial, 8'	Coaxial	10Base2
315 941 013	Bar code to PC (optional)	9-pin D	Com2

## Optional Equipment

---

Optional equipment includes system printers and the Bar Code Reader.

### System Printers

Cabling for system printers is slightly different for standalone and network configurations.

#### ***Standalone Printer{ XE "Standalone installation:Printer (optional)" }***

Unpack the printer and place it on the printer cabinet (a separate piece of furniture). Follow the instructions in the manufacturer's user manuals and install the printer as a parallel device. Use the 25-pin parallel interface cable to connect the printer to the port labeled **LINE PRINTER** located on the scanner's back panel (bottom and first cutout from the left).

For cabling instructions, do the following.

1. Attach the power cord.
  - Plug the female end into the back of the printer.
  - Plug the male end into the power strip (or wall outlet).
2. Attach the parallel interface cable.
  - Plug the male end of the parallel interface cable into the appropriate port on the back of the printer.
  - Plug the other end of the cable into the appropriate port labeled **LINE PRINTER** located on the lower left-hand side of the scanner's back panel.

#### ***Network Printer{ XE "Network installation:Printer (optional)" }***

Unpack the printer and place it on the printer cabinet (a separate piece of furniture). Follow the instructions in the manufacturer's user manuals and install the printer as a parallel device, using the parallel interface cable to connect the printer to the network server or to a port located on the back of the scanner.

For cabling instructions, do the following: (See Figure 3.5.)

1. Attach the power cord.
  - Plug the female end into the back of the printer.
  - Plug the male end into the power strip.
2. Attach the parallel interface cable.
  - Plug the male end of the parallel interface cable into the port on the back of the printer.
  - Plug the other end of the cable into the appropriate port on the back of the network server or to a port labeled **LINE PRINTER** located at the bottom of the scanner's rear panel.

## Bar Code Reader

The optional Bar Code Reader { XE "Bar code installation" } is usually installed at NCS Pearson Manufacturing. It can also be installed in the field by an NCS Pearson technician. In both cases, the following cable connections must be performed as part of the initial installation.

There are two cables:{ XE "Bar code cabling" }

- 25-pin flat cable (I/O cable)
- 25-pin D-SUB to 9-pin D-SUB cable (Bar Code to PC cable)

The 25-pin flat cable has been pre-installed at NCS Pearson Manufacturing. You need to locate the 9-pin D-SUB end of the Bar Code to PC cable and plug it into the **Com2** serial port on the back of the computer.

1. Ensure that the female end of the 25-pin flat cable is securely connected to the BCD board.
2. Ensure that the other end (also female) is securely connected to the 25-pin D-SUB end of the Bar Code to PC cable.
3. Plug the 9-pin D-SUB end of the Bar Code to PC cable into the **Com2** port on the back of the computer.



# 4. Scanner Checkout

---

This chapter discusses the procedures for scanner checkout, pre-installed system software, system verification and backup, and customer hand-off.

## Scanner Checkout Procedures{ XE "Scanner, 5000i:Checkout procedures" }{ XE "Software checkout" }

---

To checkout the 5000i scanner, refer to the following sections in the *Maintenance Manual for the 5000i® Scanner*.

1. Hopper and Stacker Operational Checkout (Section 2.6)
2. Sensor Checkout Procedures (Section 2.8)
3. Read Station Adjustments (Section 3.2)
4. Check Alignment test (Section 5.2.4.8)
5. Hopper Height Adjustments (Section 3.5)
6. Pick Area Adjustments (Section 3.3)
7. Calibrating (and Normalizing) the Scanner (Section E.2)

## System Software

---

5000i scanner system software is pre-installed at NCS Pearson. For information regarding this software{ XE "Checkout:Software" }, refer to the following publications:

- *Image ScanTools™ for 5000i® Scanners* - includes information on installation, setup, and configuration. Error messages are not documented in this publication. Error messages are displayed in On-Line Help.
- *NCS Accra™* - includes information on installation, setup, and configuration. Error messages are not documented in this publication; error messages are displayed on Online Help.

## System Verification{ XE "Checkout:System verification" }

---

This section describes how to update the 5000i scanner system software.

### Requirements

You need to have an additional 90 to 100 MB of disk space if you intend to maintain a copy of the old and new software.



You need to have 128 MB of paging space for the file server and 32 MB of paging space for each edit workstation.

Before updating the 5000i scanner software, make sure that the following are installed and configured for version x.x.

- Windows NT operating system
- Scanner software

For more information on special requirements for your site, see the *Release Notes* accompanying the update media.

## 5000i Scanner System Software

The 5000i scanner system software arrives completely configured.

## **Customer Hand-off{ XE "Checkout:Customer hand-off" }{ XE "Customer hand-off" }**

---

Once everything is working properly, go through the customer training checklist to ensure the customer understands the operation and maintenance of the scanner.

1. Identify the main scanner parts and explain the purpose.
  - Power Switch - Turns on the system's power
  - READY switch - Starts and stops the scanner
  - Input hopper - Holds up to 750 sheets
  - Input hopper height adjustment switch - Adjusts the input hopper up/down
  - Transport bed - Senses if the form is aligned and passes it between the read heads
  - Bar code reader - Reads bar codes on forms
  - Turnaround station - Sends the forms to the output hopper or the select stacker
  - Transport printer - Prints information on the forms
  - Select Stacker - Holds forms with errors (up to 200 sheets)
  - Output Hopper - Holds forms without errors (up to 750 sheets)
  - Output Hopper Height Adjustment Switch - Adjusts the input hopper up or down
2. Demonstrate how to operate the scanner.
  - Turn on the system.
  - Load the input hopper.
  - Run Image ScanTools™ and select the appropriate application.
  - Monitor the scanning process for operational messages.
  - Stop the scanner/restart.
  - Unload the select stacker/output hopper.
  - Turn off the system.
3. Demonstrate the operation of other system components.
  - Computer
  - Printer
4. Correct errors using Image ScanTools with sample application.
  - Feed a form with timing mark in the wrong position.
  - Create a mechanical error and correct it.
  - Create a paper jam and correct it.
  - Repair a damaged form.

5. Demonstrate periodic maintenance.
  - Clean the upper transport bed.
  - Clean the lower transport bed.
  - Clean the outer turnaround.
  - Clean the glass on the light source assembly.
  - Clean/replace the scanner cooling fan filter.
  - Remove/replace the pick belt.
  - Remove/replace the sheet retard pad.
6. Demonstrate transport printer maintenance.
  - Change the printer ribbon cartridge.
  - Explain the one-time ribbon intensity adjustment.
7. Demonstrate bar code reader operation.
  - Reader position adjustment
  - Bar code reader problem solving
8. Demonstrate how to run the Quick Check Utility (See *Quick Check Guide for the 5000i® Scanner*).
9. Demonstrate how to run the Scanner Exerciser Utility (See Appendix C in the *Operator's Guide for the 5000i® Scanner*).
10. Identify system user manuals.
11. Discuss operator safety.
  - Turn off the scanner while working on it.
  - Only one person – preferably – should maintain the scanner.
  - Do not wear loose clothing or jewelry while working on the scanner.
12. Identify who to call for assistance.
  - NCS Pearson Customer Support: 1-800-338-5544

This completes the customer hand-off procedure.



# Index

---

## +

+12.5V power supply. *See* Power supply, +15V

## A

Adjustment

Multivolt logic power supplies, 12

## B

Bar code cabling, 27

Bar code installation, 27

## C

Cable part numbers, 25

Cable, 10Base2, 23

Cable, 10BaseT.

Cabling

Network configuration, 21

Standalone configuration, 17

Catgut board, 16

Catgut II (daughter card), 16

Check the installation site, 6

Checkout

Customer hand-off, 30

Logic voltages, 12

Multivolt logic power supply voltage, 12

Power supply voltages, 12

Software, 29

System verification, 29

Computer

Preparing for standalone installation, 16

standalone checkout, 16

Computer installation

Introduction, 15

Conductor

Ground, dedicated, 8

Isolated/insulated, 9

Neutral, 9

Specifications, ground-to-neutral. *See*

Convenience outlet

switched, 9

Customer hand-off, 30

Customer ID number, 3

Customer Support, 3

## D

Daughter card (Catgut II), 16

Dedicated circuit, 6

Dedicated ground specifications, 8

Dynamic deskew station, 2

## E

Electrical outlet, 10

Electrical outlet, convenience. *See* convenience outlet

Environmental requirements, 6

## G

Ground

Conductor, 9

Third-wire, 9

Grounding

In multistory building, 9

## H

Heat dissipation requirements, 6

Hobbes board, 16

## I

Image capture, 1

Input hopper, 1

Input hopper height adjustment switch, 1

Installation

Computer, 15

Scanner, 5

Installation site

verify readiness, 6

Installation site checkout

Dedicated circuit, 6

Environmental requirements, 6

Heat dissipation requirements, 6

Physical requirements, 6

Power requirements, 6

Power strip, 6

Internal cable connections, 24

## L

Logic power supplies. *See* power supplies, multivolt logic

Logic power supply. *See* power supply, +5V logic

Logic voltages, 12

## M

Measurement

Multivolt logic power supply, 12

Multistory building, grounding. *See* Grounding in multistory building

Multivolt logic power supply voltage, 12

## N

- National Electrical Code, 9
- NEC. *See* National Electrical Code
- Network installation
  - Board/connector relationship, 24
  - Computer, 20
  - Connecting to a network, 23
  - Keyboard and mouse, 23
  - Monitor, 22
  - Networking equipment, 23
  - Printer (optional), 26
- Network Installation
  - Cabling, 21
- Neutral conductor. *See* Conductor, neutral

## O

- Outlet, convenience. *See* Convenience outlet
- Output hopper, 2
- Output hopper height adjustment switch, 2
- Output sheet-stop adjustment knob, 2

## P

- PC boards, 25
- Physical dimensions required, 6
- Power noise specifications, 8
- Power requirements, 6
- Power strip, 6
- Power supplies, multivolt logic. *See* Checkout procedures - logic voltages. *See* Power supply, 15V logic
  - Adjustment, 12
  - Voltage checkout procedure, 12
  - Voltage outside specified range, 12
- Power supply
  - +5V logic, 11
  - 12.5V logic, 11
  - Checkout procedures, 11
  - No field repair, 12
- Power supply voltages, 12
- Power supply, +12.5V voltage, 12
- Power supply, +15V
  - No adjustments, 12
  - Voltage checkout, 12
- Power supply, +5V logic
  - Voltages, 12
- Power supply, 12.5V logic
  - Voltages, 12
- Power switch, 1
- Power wiring recommendations, 10
- Powering the system down, 15

## R

- READY switch, 1

## S

- Scanner installation
  - Check the site, 6
  - Check the voltage, 8
  - Components, 5
  - Electrical requirements, 11
  - Introduction, 5
  - Power supply checkout procedure, 11
  - Preparation, 5
  - Sequence of events, 6
  - Site power wiring recommendations, 10
  - Spares, 7
  - Unpacking, 7
- Scanner, 5000i
  - Checkout procedures, 29
  - Customer Support, 3
  - Network configuration, 20
  - Overview, 1
  - Standalone configuration, 2
  - Select stacker, 2
  - Serial number, scanner, 3
  - Shutdown procedure, 15
  - Software checkout, 29
  - Solenoid
    - Voltage source, 12
  - Spares kit, contents, 7
  - Standalone
    - Board/connector relationship, 19
  - Standalone configuration, 2
  - Standalone installation
    - Cabling, 17
    - Computer, 16
    - Keyboard and mouse, 18
    - Monitor, 18
    - Printer (optional), 26
    - Work table, 18
- Switched convenience outlet. *See* Convenience outlet

## T

- Transient specifications, 8
- Transport printer, 2
- Turnaround station, 2

## U

- Unpacking the scanner, procedure. *See*

## V

- Voltage
  - ±12.5 power supply, 12
  - Ground-to-neutral, 9
  - Power supply, multivolt logic, 12

## W

- Wiring. *See* Site power wiring recommendations

## Free Manuals Download Website

<http://myh66.com>

<http://usermanuals.us>

<http://www.somanuals.com>

<http://www.4manuals.cc>

<http://www.manual-lib.com>

<http://www.404manual.com>

<http://www.luxmanual.com>

<http://aubethermostatmanual.com>

Golf course search by state

<http://golfingnear.com>

Email search by domain

<http://emailbydomain.com>

Auto manuals search

<http://auto.somanuals.com>

TV manuals search

<http://tv.somanuals.com>