

Numark®

AXIS 8 Premium CD Player

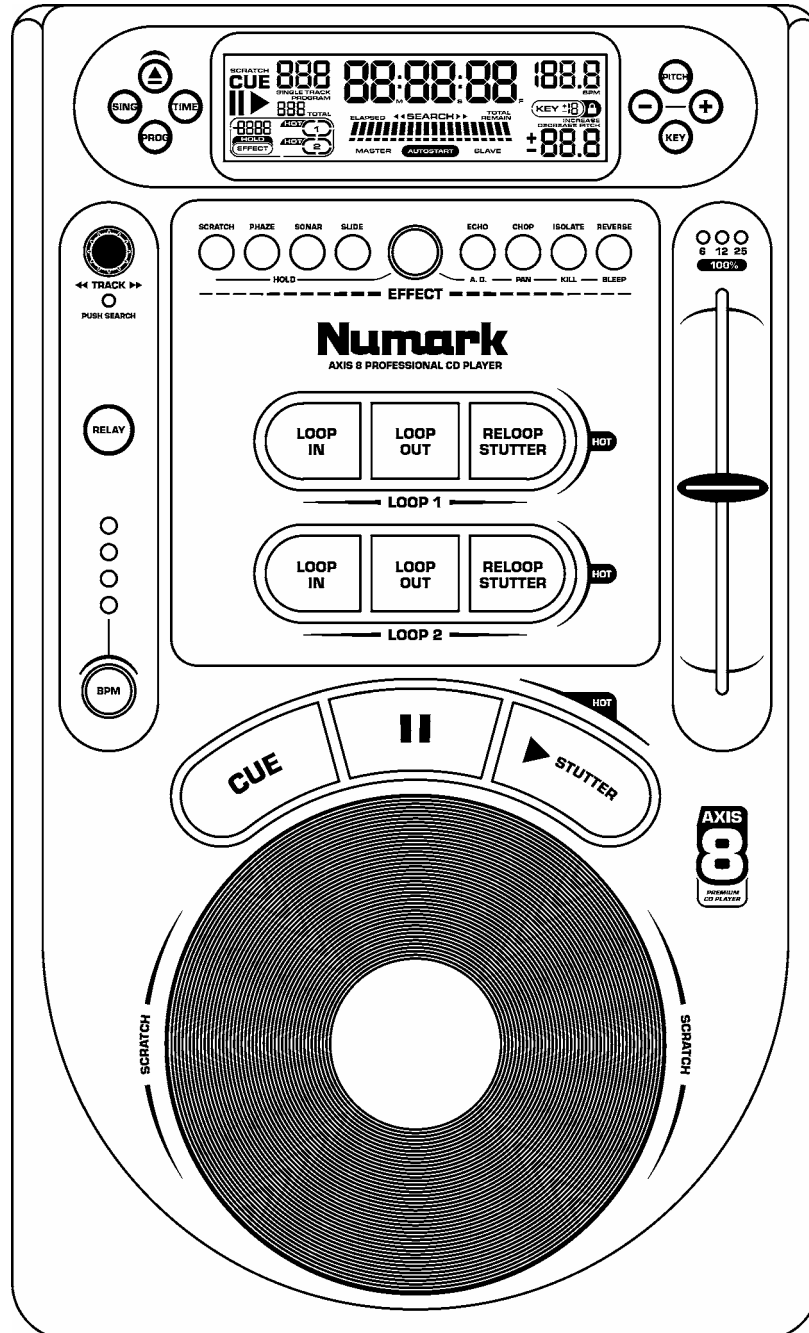

Owner Manual

AXIS 8

SAFETY INSTRUCTIONS

- a) Read Instructions - All the safety and operating instructions should be read before this product is connected and used.
- b) Retain Instructions - The safety and operating instructions should be kept for future reference.
- c) Heed Warnings - All warnings on this product and in these operating instructions should be followed.
- d) Follow Instructions - All operating and other instructions should be followed.
- e) Placement - place the unit in a clean dry location.
- f) Water and Moisture - This product should be kept away from direct contact with liquids. The apparatus shall not be exposed to dripping or splashing and that no objects filled with liquids, such as vases, shall be placed on the apparatus.
- g) Temperature - Avoid placing this product too close to any high heat sources such as radiators. Do not use this unit at temperatures below 41°F/5°C or higher than 95°F/35°C.
- h) Ventilation - The appliance should be situated so that its location or position does not interfere with its proper ventilation. For example, the appliance should not be situated on a bed, sofa, rug, or similar surface that may block the ventilation opening; or, placed in a built-in installation, such as bookcase or cabinet that may impede the flow of air through the ventilation openings.
- i) Power Sources - This product should be connected to a power supply only of the type described in these operating instructions, or as marked on the unit.
- j) Power Cord Protection - Power supply cords should be routed so that they are not likely to be walked upon or pinched by items placed on or against them. When removing the cord from a power outlet be sure to remove it by holding the plug attachment and not by pulling on the cord.
- k) Object and Liquid Entry - Take care that objects do not fall into and that liquids are not spilled into the inside of the mixer.
- l) Cleaning - The appliance should be cleaned only as recommended by the manufacturer. Do not use chemical solvents to clean the unit.
- m) Non-use Periods - The power cord of the appliance should be unplugged from the outlet when left unused for long periods of time.
- n) Damage Requiring Service - Only qualified personnel should service this product. If you have any questions about service please contact Numark at the number(s) shown on the back cover of this manual.
- o) Grounding or Polarization - Precautions should be taken so that the grounding or polarization means built into the CD player is not defeated.
- p) Internal/External Voltage Selectors - Internal or external voltage selector switches, if any, should only be reset and re-equipped with a proper plug for alternative voltage by a qualified service technician. Do not attempt to alter this yourself.
- q) Carts and Stands - The appliance should be used only with a cart or stand that is recommended by the manufacturer of the cart or stand. An appliance and cart combination should be moved with care. Quick stops, excessive force, and uneven surfaces may cause the appliance and cart combination to overturn.

SERVICE INSTRUCTIONS

- Disconnect power cord before servicing
- Replace critical components  only with factory parts or recommended equivalents
- For AC line powered units - Before returning repaired unit to user, use an ohmmeter to measure from both AC plug blades to all exposed metallic parts. The resistance should be no more than 100,000ohms.

DANGER: INVISIBLE LASER RADIATION WHEN OPEN AND INTERLOCK FAILED OR DEFEATED. AVOID DIRECT EXPOSURE TO BEAM.

USE OF CONTROLS OR ADJUSTMENTS OTHER THAN THOSE SPECIFIED HEREIN MAY RESULT IN HAZARDOUS RADIATION EXPOSURE



CAUTION
RISK OF ELECTRIC SHOCK
DO NOT OPEN



CAUTION: TO REDUCE THE RISK OF ELECTRIC SHOCK DO NOT REMOVE ANY COVER. NO USER-SERVICEABLE PARTS INSIDE. REFER SERVICING TO QUALIFIED SERVICE PERSONNEL ONLY.

The lightning flash with arrowhead symbol within the equilateral triangle is intended to alert the user to the presence of un-insulated "dangerous voltage" within the product's enclosure that may be of sufficient magnitude to constitute a risk of electric shock.

The exclamation point within the equilateral triangle is intended to alert the user to the presence of important operating and maintenance (servicing) instructions in the literature accompanying this appliance.

CAUTION
FOR USA & CANADIAN MODELS ONLY
TO PREVENT ELECTRIC SHOCK DO NOT USE THIS (POLARIZED) PLUG WITH AN EXTENSION CORD, RECEPTACLE OR OTHER OUTLET UNLESS THE BLADES CAN BE FULLY INSERTED TO PREVENT BLADE EXPOSURE.

WARNING: To reduce the risk of fire or electrical shock, do not expose this appliance to rain or moisture. Electrical equipment should NEVER be kept or stored in damp environments.

NOTICE CONCERNING FCC REGULATIONS

This equipment generates and uses radio frequency energy and may cause interference to radio and television reception if you do not operate it in strict accordance with the procedures detailed in this OPERATING MANUAL. This unit complies with Class B computing device rules in accordance with the specifications in Sub-part J or Part 15 of the FCC Rules, which are designed to provide reasonable protection against such interference in a residential installation. There is no guarantee, however, that interference will not occur in a particular installation. If the unit does cause interference to any radio or television reception, try to reduce it by one or more of the following means:

- a) Reposition the other unit and/or its antennae
- b) Move this unit
- c) Move this unit and the other unit(s) further apart
- d) Plug this unit into a different AC outlet so that it is on a different circuit from the other equipment.

This note is in accordance with Section 15.838 of the FCC Rules.

This unit does not exceed the Class B limits for radio noise emission from digital apparatus set out in the radio interference regulations of the Canadian Department of Communications.

DOUBLE INSULATED - When servicing use only identical replacement parts

For 220-volt use in USA, use NEMA style 220-volt plug. For other countries use proper plug for local outlet.

Numark- The Leader in DJ Technology

TABLE OF CONTENTS

Safety and Warnings (PLEASE READ)	2
Table of Contents	3
Introduction Letter from the Engineers and Registration	4
Setup and Connections	5
Description of the Features	6
Basic Operation	
Play, Pause, Cue, Pitch, General CD control	8
Advanced Operations	
Pitch Change, Key Change	10
Beatkeeper	10
Matching Beats	11
Looping	12
Stuttering (Hot Starts)	13
Special Effects	14
Program Functions (A MUST READ!!!)	16
Fader Start, Relay	17
Cue Point Storage	18
Updating your Software	19
MIDI IN-OUT	20
Specifications	23
Warranty	24

Numark® AXIS 8

PREMIUM TABLETOP CD PLAYER

Congratulations, you are now the owner of one of the most technically advanced pieces of DJ equipment ever developed. The AXIS 8 is the result of many years of development and several NUMARK exclusive patents. The developers and engineers behind the AXIS 8 all have a significant amount of DJ experience and understand your needs. As we like to say, "this unit was designed by DJs for DJs", like the rest of the NUMARK's product line. That's why some of the features in this unit may work slightly differently than others on the market. To get the most out of your AXIS 8, we highly recommend reading this short manual thoroughly.

We have taken great pride in developing features that will enhance your creativity when using CDs.

- **Scratching:** it really sounds like a vinyl record. Though we fully believe that nothing can replace the skills or excitement of the turntablist, we also know this feature is tremendous fun to use on CD and will change the way approach those little shiny discs.
- **Triple Anti-Shock memory:** Improves our patented Anti-Shock™ technology, not only in programming, but also with the use of 2X speed CD mechanisms for faster loads and mechanical vibration protection. Add to that 48 seconds of buffer memory, and the unit really is shock proof.
- **The Beatkeeper™ III:** Improves our patented Beatkeeper™ technology for even faster and more accurate readouts through the buffer memory. The primary use of this technology is an essential tool of many effects in the unit itself. Our goal is to enhance the DJ's skills. Remember you are not just a DJ but a musician as well.
- **200% pitch control:** Why not? This gives you + or - 100% control over your music. Exploit your creativity!
- **Key Lock:** Similar yet different from "master tempo". With "master tempo" the pitch only locks at the 0% point. So often a DJ is in the middle of a pitched mix and determines they need to make rapid and drastic changes in speed to bring in a record or change the mood. With KEY LOCK you can lock on right in at your current position, no returning to 0%. On top of that we took it one step further. Because we developed our own technology for this feature our KEY LOCK can go + or - 100%. Why not?
- **End of Track Dead Space Elimination:** So often a DJ will play a CD continuously for the cocktail or dinner hour. This feature eliminates the inconsistent space often found between tracks and keeps the music going.
- **Flash Updateable:** As new features are added to your unit you will be able to easily upgrade your unit via CD Rom.
- **Effects:** We took the liberty of adding some effects never before seen in a CD Player. Because we do the effects from a real time buffer, the effects are far more impressive then if provided from an external effects processor. Beat synchronized echo, pan and chop are perfectly aligned. The echo can actually be set to play before the music. Standard filter effects such as PHAZE, SONAR, ARTIFICIAL-DISEMINATION, SLIDE, ISO, and KILL are also included. We also added BLEEP to get rid of those dirty lyrics on the fly and true REVERSE with no time limits.

We hope you have as much fun performing with the AXIS 8 as we did developing it.

The NUMARK product team

Please record the serial number of your unit as shown on the back of the chassis as well as the name of the dealer from whom you purchased the unit. Retain this information and your original purchase receipt for your records. Please return the enclosed warranty card to register your CD player with us.

MODEL: _____ PURCHASED FROM: _____
 SERIAL NUMBER: _____ DATE OF PURCHASE: _____

Numark- The Leader in DJ Technology

SETUP AND CONNECTIONS

Typical connection with a mixer is illustrated below.

1. Find a level surface free of excessive vibration to place your equipment
2. Connect the line output connections using the supplied audio cable from the CD Player to the line inputs of your mixer.
3. Connect Fader start cable. Attach your CD play to a similarly equipped DJ mixer with this supplied cable. *(This connection can also be used with a remote switch (Page 17))*
4. If setting up 2 units, you can connect a relay cable between the units.
(This cable is a standard 1/8" mono – 1/8" mono cable like your fader start cable. It can be purchased from your local music or electronics store or you can use the fader start cable instead for this purpose)
5. Check the voltage selection switch is set to correctly match your local power supply.
6. Connect IEC power cord to the back of the unit then to your power source.

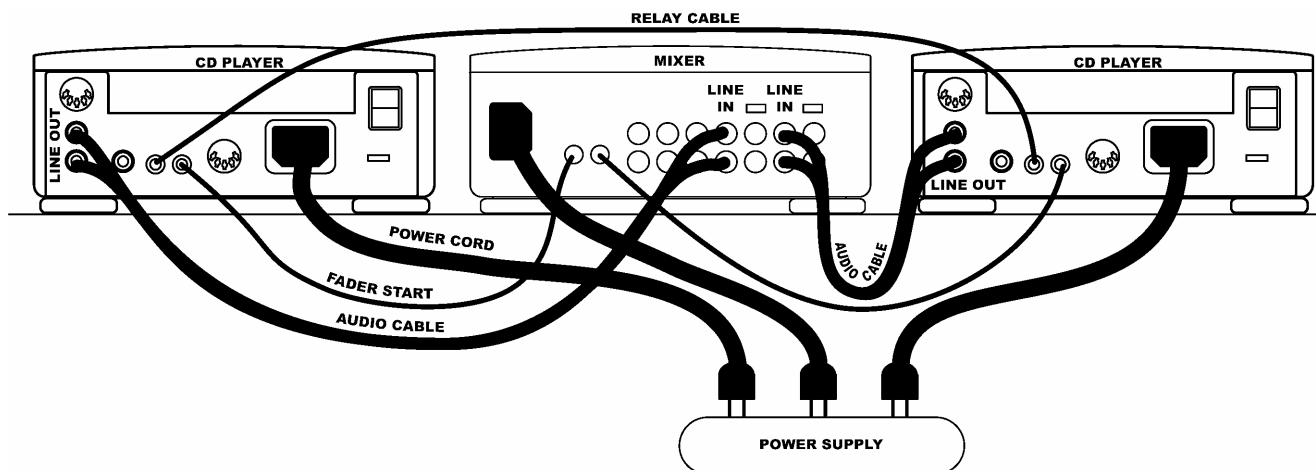

DIGITAL OUTPUTS: This CD player is specially equipped with digital outputs. The format is type 2, form 1, also known as S/PDIF (Sony/Phillips Digital Interface Format).

Check the program functions section of this manual for proper activation

LINE VOLTAGE SELECTION

- 1) The desired voltage may be set with the VOLTAGE SELECTOR switch on the rear panel of the unit.
- 2) Do not move the VOLTAGE SELECTOR switch with excessive force as this may cause damage.
- 3) If the VOLTAGE SELECTOR switch does not move smoothly contact a qualified serviceman.

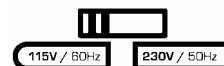

FEATURES

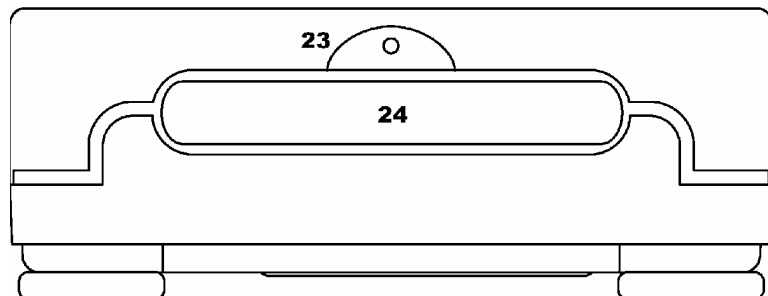
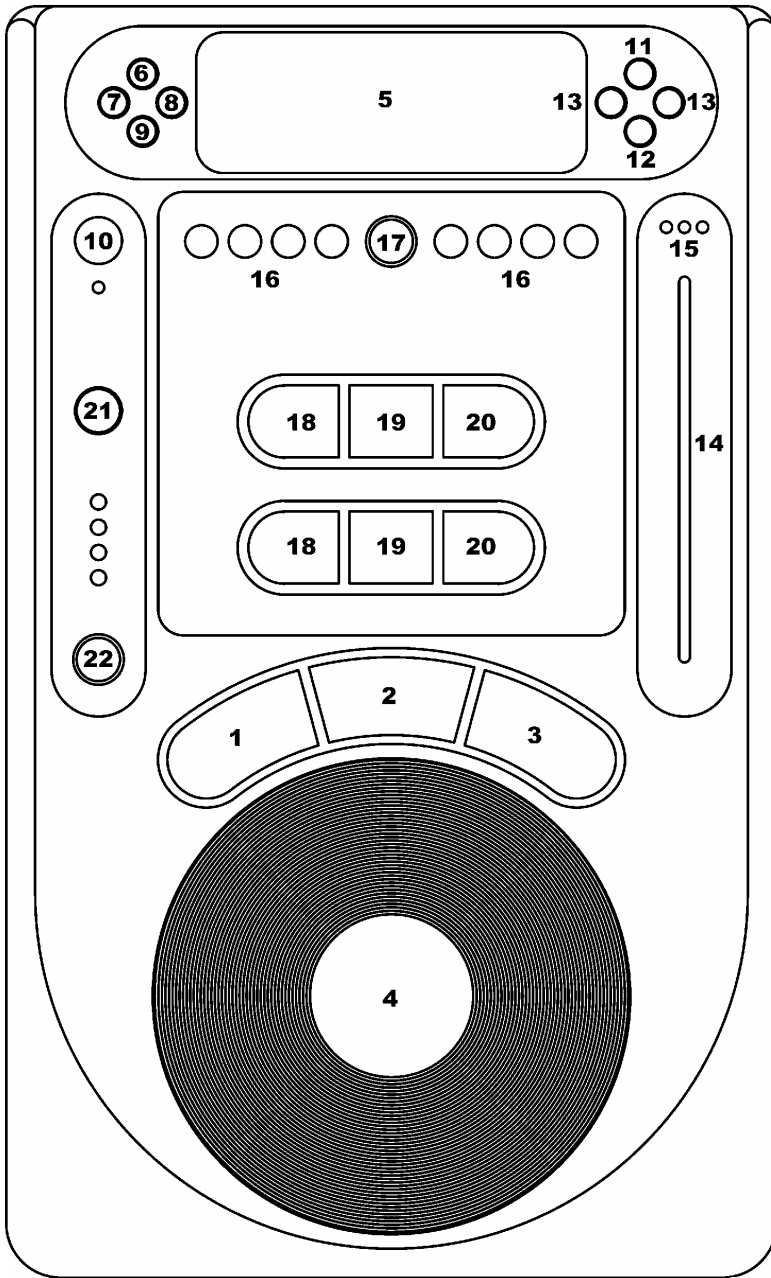

1. **PLAY/STUTTER-** To start the music from the initial cue point.
2. **PAUSE-** To pause the music.
3. **CUE-** To move the music to the cue point and preview the selection.
4. **WHEEL-** Used for various functions such as cueing, scratching, pitch bend, searching, and effect control
5. **LCD DISPLAY-** Indicates all the functions, as they are occurring, with the CD.
6. **OPEN/CLOSE-** Pressing will open or close the disc tray on the transport.
7. **SING-** To set play mode in single or continuous play.
8. **TIME-** Controls display indication of time mode.
9. **PROGRAM-** Used for setting track order and various special commands.
10. **TRACK SELECT/SEARCH-**
Rotation – selects tracks
Pressing while rotating – selects tracks +10
Pressing once- Puts wheel in search mode.
11. **PITCH-** Actives and sets pitch slider range.
12. **-,+ -** Works as pitch bend and controls key and pitch functions.
13. **KEY-** Used for various key control.
14. **PITCH SLIDER-** Controls the overall speed of the music.
15. **PITCH RANGE LED-** Indicates current pitch range of the pitch slider
16. **EFFECT BUTTON-** Used to determine desired effect.
17. **EFFECT HOLD-** Used to set effects to an alternate position
18. **LOOP IN-** Used to set stutter and loop in points.
19. **LOOP OUT-** Used to set loop out points and release the loop.
20. **RELOOP/STUTTER-** Used for repeated play (stutter) from the loop in point, repeating a previously set, and hot start.
21. **RELAY-** Used for setting Alternating play start between attached units.
22. **BEAT SYNC with MARCHING BAR GRAPH-** Tracks the beats and measure position of music
23. **CD Illumination Light** – lights up the CD drawer and CD when open.
24. **CD Drawer** – Place your CDs you wish to play in here. This unit is designed to play commercially available CD and properly burned and finalized CDR and CDRW formats. Due to variances on the specification of certain CD burners and CDs some discs home made CDs may not play properly.

Numark- The Leader in DJ Technology

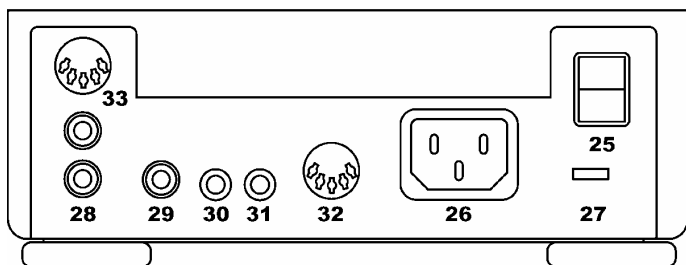

- 25. **Power Switch**- Turn on and turn off the machine with this button. The unit should always be shut down with this button first before any external power is removed. Typically it is recommended that the CD player is powered on before amplifiers and off after amplifiers to avoid an audio spike to be sent through your equipment.
- 26. **IEC Power Plug Connector** - Plug your supplied power cord in here.
- 27. **Voltage Selector** - Set this switch to the voltage for your location.
- 28. **RCA Audio Connectors** - Connect your CD player to your mixer from this line level output.
- 29. **Digital Output** - The format is type 2, form 1, also known as S/PDIF (Sony/Phillips Digital Interface Format). To active digital output, hold down "PROG" followed by "PITCH". This allows digital audio information to be sent. Some CDs also have information encoded in the original audio output such as CDG graphic CDs for Karaoke.

- 30. **Relay Connector**- If you wish to use the relay function plug in your 3.5mm stereo control cables into here and then into your other unit. The cable must be a stereo style plug for the units to work properly
- 31. **Remote Start Connector** – Use this connector to plug into your fader start compatible mixer or remote switch. This function is always active. To use this connector for fader start, connect the supplied fader start cable to a fader start compatible mixer. Every time you move the crossfader on the mixer over to the side that the unit is on, it will automatically start playing. When you move the fader away from that side, the unit will stop. Moving the fader *back* to the unit side will start play again. Foot switches can also be attached to this jack for creative mixing techniques and can be found in most music shops. Connector plugs are often 1/4" and an adapter to 1/8" will be needed for connection. There are also two types of footswitches that will work with this connector. The first is a typical, on/off pushbutton switch and are generally used for switching channels on guitar amps. The second switch is a momentary footswitch and is usually used for keyboard sustain pedals.
- 32. **MIDI IN Connector** – The port is for receiving MIDI (Musical Instrument Digital Interface) signals from other MIDI devices such as CD players, Keyboards, or Drum machines.
- 33. **MIDI OUT Connector** –The port is for sending MIDI signals to other MIDI devices .

DISPLAY FEATURES

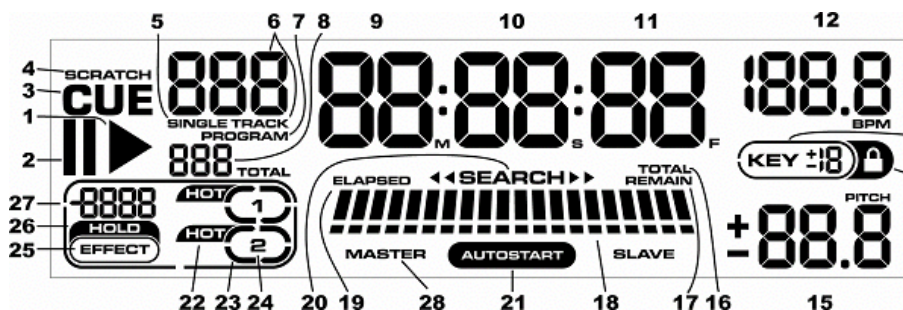



- 1. **PLAY** - Active while the unit is actually playing a CD.
- 2. **PAUSE** - Active when the unit is paused.
- 3. **CUE** - Flashing when the unit is setting a cue point. Active when the unit is paused at a cue point.
- 4. **SCRATCH** – indicates when the wheel will cue as a smooth transition over the music creating a scratch effect. When not lit the wheel will cue in the customary stutter style.
- 5. **SINGLE** - Shows when the unit is set to play just one track at a time.
- 6. **TRACK** - Shows the track that the unit is playing.
- 7. **PROGRAM** – On when a sequence of songs is preprogrammed into the unit.
- 8. **TOTAL TRACK** – shows number of tracks available on the CD.
- 9. **MINUTES** - Shows the minutes elapsed or remaining depending on mode setting.
- 10. **SECONDS** - Shows the seconds elapsed or remaining depending on mode setting.
- 11. **FRAMES** - The CD Player breaks down a second into 75 frames for accurate cueing. This shows the frames elapsed or remaining depending on mode setting.
- 12. **BPM** – Indicates the current BPM.
- 13. **KEY** – Lights when key effects are active and indicates key position.
- 14. **LOCK** – Lights when key has been locked
- 15. **PITCH** – Shows current pitch position.
- 16. **TIME MODE (TOTAL)** indicates when full CD remain time is showing.
- 17. **TIME MODE (REMAIN)** shows how much time is left on a particular track.
- 18. **TIME BAR** - Shows either track time remaining, total CD time remaining or track elapsed time depending on the setting of the "TIME" button.
- 19. **TIME MODE (ELAPSED)** is for showing time as it is taking place.
- 20. **SEARCH** – Shows when the wheel is active for the search effect.
- 21. **AUTOSTART**- Indicates when the CD is set to relay.
- 22. **HOT** – Active when hot points have been set.
- 23. **LOOP INDICATOR** – Activates as loops are playing.
- 24. **1,2** – Indicates which hot points or loops are set.
- 25. **EFFECT** – indicates when wheel is in effect mode.
- 26. **HOLD** – indicates when effects are being held in position.
- 27. **EFFECT PARAMETER** – Shows the current effect setting.
- 28. **MASTER/SLAVE** – indicates unit dominance in MIDI interlock functions

Numark- The Leader in DJ Technology





BASIC OPERATIONS

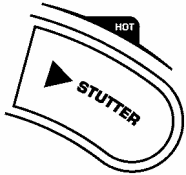





Open/Close: Press to load or eject the disc. The drawer will automatically close to protect the tray from accidental damage while open. *NOTE: Tray will not open if the disc is in play.* In order to program the automatic close time press and hold  followed by . The display will indicate options of 30 seconds, 60 seconds, 120 seconds, and (no) for no auto close. *This setting will be remembered at power down.*



Play/Stutter: Starts the music from either the first set cue point or the last point of pause. By starting from the last pause point while the unit is paused a new cue point is set. Pressing this button while the unit is in play restarts the unit from the last cue point, creating a “stutter” effect.

Startup speed of initial play can be adjusted by pressing  followed by  and then rotating the wheel until the desired seconds of startup are shown. Pressing  followed by  twice will toggle startup between 0 to the desired seconds. *This setting will be remembered at power down.*



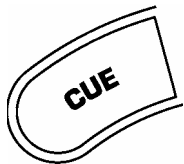

Pause: Stops the music while in play. Pressing play following this sets a new cue point. Holding down the button while scratching or stuttering the music will stop the music at the current position, allowing you to capture a loop in or cue point. Pause speed (BRAKING) can be adjusted, by pressing  followed by  and then rotating the wheel until the desired seconds of startup are shown. Pressing  followed by  twice will toggle startup from 0 to the desired seconds. *This setting will be remembered at power down.*

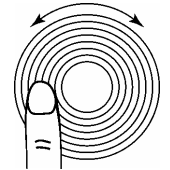

Cue: Returns and pauses the music at the last set cue point. The cue point is the last place in which the unit was paused and then play was pressed. Pressing a second time allows for temporary play of this point. You can easily edit the cue point by turning the wheel. As you rotate the wheel the music will sound. By stopping the wheel and pressing play a new point is set. The sound during wheel rotation can be adjusted from a smooth “scratch” sound to the tradition



“stutter” sound. To alternate modes hold  followed by . The display will indicate “SCRATCH” when the scratch sound is active. This indication will go away when the style of cue is stutter. *This setting will be remembered at power down.*



Time: switches the time modes on the display between elapsed playing time, remaining time on the track and remaining time on the entire CD. *This setting will be remembered at power down.*



Single: toggles the unit to play back just one track at a time (single) or play continuously through all tracks and then start over repeating the CD infinitely (continuous). *This setting will be remembered at power down.*



Track Selection: Rotate the dial to quickly find the desired track. To advance by +10, press the knob while rotating.

Search: Pressing the selector changes the mode of the jog wheel to a search mode. Search will remain active while the wheel is being moved and for 8 seconds after. Moving the wheel clockwise rapidly moves forward through the music. Counterclockwise moves backwards through the music. There are 2 search speeds depending upon wheel rotation speed.

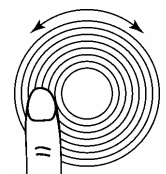

SETTING CUE POINTS

PLAY and CUE

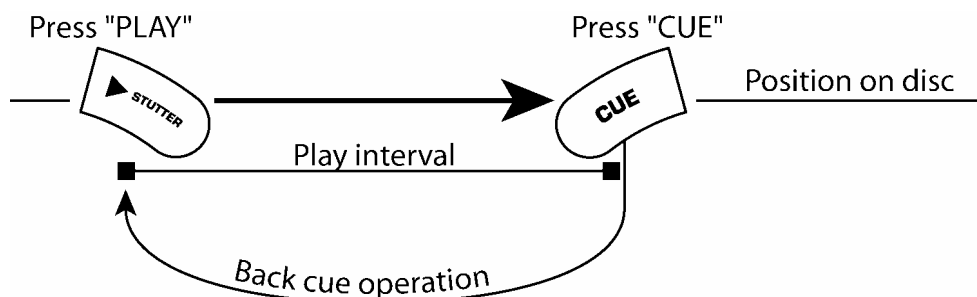

Pressing the "PLAY" button starts the disc. Pressing the "CUE" button will reset the disc to the last place where the disc was started. This is called the cue point. By alternately pressing the "PLAY" button and the "CUE" button, the disc may be returned and played from the cue point any number of times. This function is called back cue.

PLAY, PAUSE and CUE

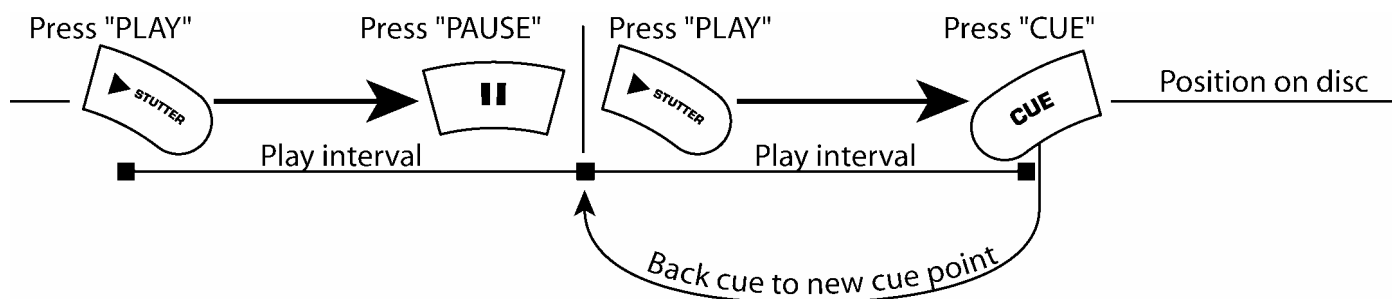

Pressing "Play" to start then pressing "Pause" and then "Play" again, a new cue point will be set. Pressing "Cue" will return to the last pause position and will be the new cue point.

EDITING CUE POINT

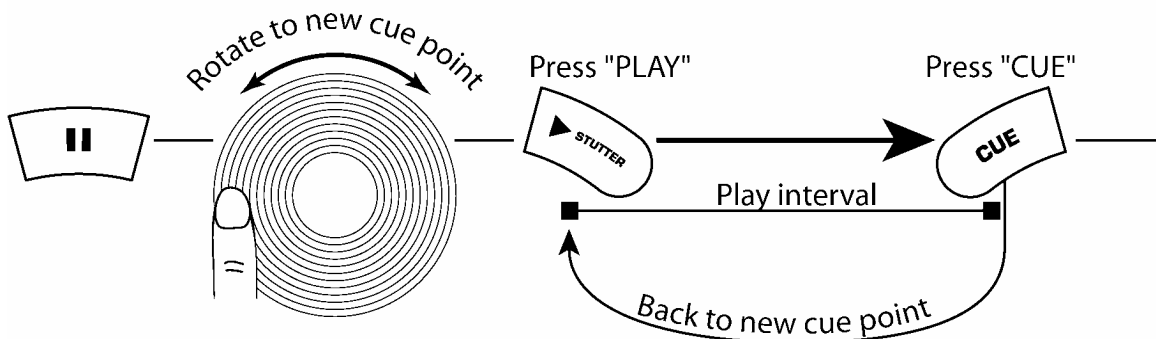

When the jog wheel is turned while paused, a new cue point can be located. By pressing "PLAY" while paused that point will be set. By pressing "PLAY" again (STUTTER) the point can be checked as desirable.

ADJUSTING PITCH

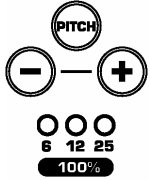

Pitch Range: activates the pitch slider and adjusts the amount of control the pitch slider has on the overall speed of music. On depression of will toggle the slider on and off. Range adjustments of 6, 12, 25, and 100% can be achieved by holding down and then pressing to cycle through the range options. *This setting will be remembered at power down.*



Pitch Slider: By moving the slider toward the front the speed of the music speeds up. By moving away the speed slows down. With 100% control the music can be stopped or play at 2 times original speed. To match the speeds of two units you can either monitor the music of both units by ear or use the automatic BPM readout and adjust the pitch to match. When the tempo of the music of the CD you wish to match is slow compared to the tempo of the other music, move the slider to the (+) end and match the BPM. When faster, move the pitch slider to the (-) end. By making this adjustment the speeds will be matched though the beats may not yet be aligned.

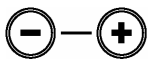

Pitch Bend: Buttons and Jog Wheel: Allows the user to temporarily change the speed of the music to align beats. When the beats of the music of the CD you wish to match is fast compared to the tempo of the other music press the or rotate the jog wheel counter clockwise (to the left). When PLAYER 2 is behind press the or rotate the jog wheel clockwise (to the right). The pitch changes temporarily while the or button is being pressed or the jog wheel is rotated. The faster you rotate the wheel or the longer you hold the buttons the more you change. Releasing the button or wheel results in a return to the original pitch.

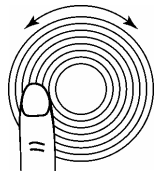

KEY LOCK / KEY CHANGE



The AXIS 8 uses Numark exclusive technology to lock the key of the music in place at the current pitch position or change it from the current position. This is different than "master tempo" often found on many modern units because the key lock to the current pitch position and not automatically set to the "0" pitch position. By doing this we have allowed you to activate this function while playing without changing the key.

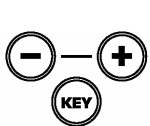

Key Lock: Pressing holds the key in place. The display will indicate to show the current key is locked. If pitch (tempo) is changed the current key will continue to play. By putting the pitch at 100% you can actually slow the music to a complete stop while playing the last heard tones of the music. This works very well on vocals and can be a very cool effect. If the unit has Key Lock active after the track has been changed and before play is hit, the unit will lock to 0. If Key is deactivated during pause the unit will reset to match the current pitch position.

Key Change: Pressing and then or will change the key. The display will indicate the and the new key. The key can increase to 1 octave above normal key or up to 2 octaves above normal key when the Slide effect is used. The key can decrease up to 5 octaves below normal key. The display will limit to 19 half steps above or below normal key. If the key is higher, the display will show "H". If it is lower, the display will show "L".

THE BEATKEEPER™ III

The AXIS 8 includes the latest Numark patented Beatkeeper™ technology. The Beatkeeper™ automatically tracks beats based upon a combination of frequencies and rhythm patterns in the music. It shows BPM in the display and outputs 4-count (a.k.a. measure) information about the music in a marching bar graph.



The Bar Graph: Most dance music and rock is set up in 4 beat increments called measures. Many of the features within the AXIS-8 use this information for incredible results. It's important to understand the basics of how the Beatkeeper works to effectively take advantage of other advanced features in the unit. The bottom LED is for the 1st beat or "Down Beat". Typically most music starts on the downbeat so the unit sets the first beat to where the music begins. Occasionally this may not be correct

or you may wish to reset it. To reset the downbeat simply tap the at the new downbeat location as the music is playing or in pause.

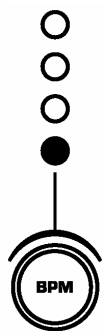
Numark- The Leader in DJ Technology



BPM: This button is used for resetting the downbeat and also re-calibrating the BPM. The Beatkeeper is considered by many to be the most accurate automatic beat counter on the market today, however, it occasionally may have trouble determining the correct BPM. This will happen when the music contains complex rhythms or may start without a beat at all. If the BPM showing in the display you know is incorrect or the beat LEDs are not flashing with the beat you have 2 options to reset the

Beatkeeper. The first way is to tap  on the downbeat and hold for a second. This will tell the unit to search and display the next BPM it finds. If this doesn't work you can manually tap  on the beat and the display will indicate the new BPM. The BPM will be based upon the average of your last 8 taps. The Beatkeeper will then know which beats in the music it should be using to determine the correct BPM and track them through the song. Occasionally the unit will be tracking the wrong beat but have the correct BPM. To reset the downbeat, simply tap the  once on the downbeat.

MATCHING THE BEATS PER MINUTE (BPM)

Match the tempo by monitoring the music of 2 CD players by ear or look at the BPM readout and adjusting the pitch. When the tempo of the music of the selected CD player is slow compared to the tempo of the other player, move the slider to the "+" side and match the BPM. When faster, move the pitch slider to the "-" side. The following description is for the case of matching the pitch of player 2 to the pitch of the music being played on player 1.

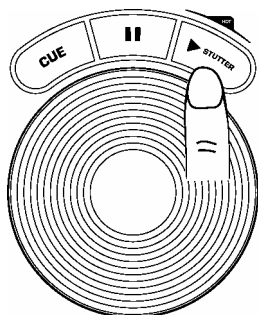

Press "PLAY" on Player 1

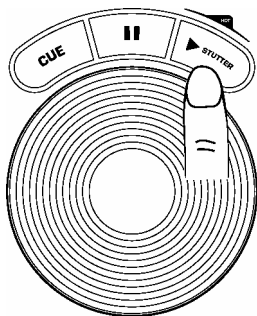

Press "PLAY" on Player 2
Listen to Player 2 or look at the BPM display

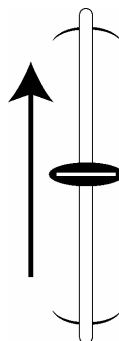

Speed Up Player 2
if Player 2 is slow compared to Player 1

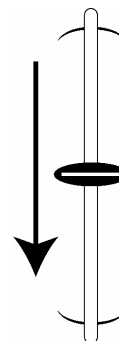



Slow Down Player 2
if Player 2 is fast compared to Player 1

USING PITCH BEND

If you find the BPM's (Beats Per Minute or Tempos) are the same, however, the drum beats are not matched you will need to temporarily change the pitch. This description is for the case of matching the beat of Player 2 to the beat of the music being played on Player 1.

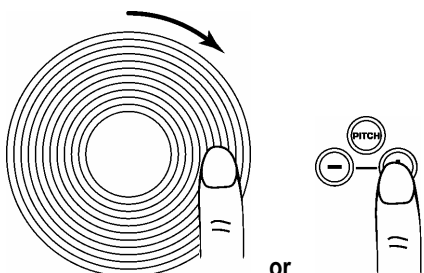
After matching the BPM's, as described above, adjust the pitch temporarily as follows:



When Player 2 is behind rotate the jog wheel clockwise
or press  to bend pitch faster

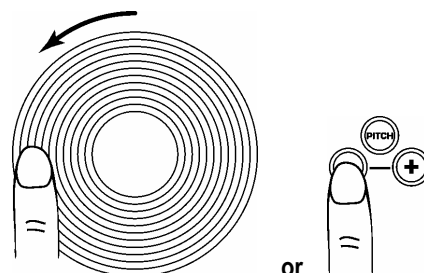

When Player 2 is ahead rotate the jog wheel counter-clockwise
or press  to bend pitch slower.

The pitch changes automatically while the jog wheel is rotated. The faster you rotate the wheel the more you change. Releasing the wheel results in a return to the original pitch.

Numark- The Leader in DJ Technology

LOOPING OPERATIONS

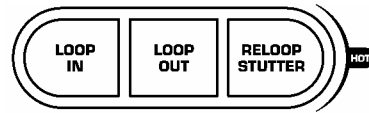

LOOPING

A loop is any area of a CD that you choose to repeat with no breaks. On the AXIS 8 two seamless loops are possible.



The "LOOP IN" point is where you wish for the loop to start. The initial "CUE" point of the CD is also the default "LOOP IN" point for both loops or "Hot Start" point. If

you wish to set a new "LOOP IN" point, just press while the CD is playing when it reaches the desired point. The button will light indicating a new loop is

set. The button and **HOT** in the display will also illuminate indicating a point has been set and is accessible for "STUTTER". *By default the "LOOP IN" also becomes the "STUTTER" or "HOT START" point.*

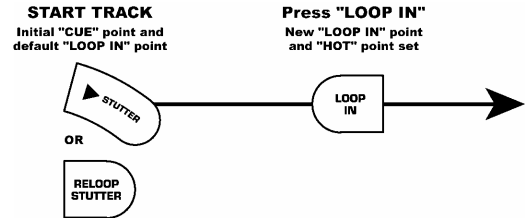

NOTE: The CD Player will always remember a new set point as the "LOOP IN" or "HOT START" point until you actually set a new "LOOP IN" point or put in a new CD. The new point will be accessible until you remove the CD from the unit. If

you change tracks and you previously set a "Loop In" on another track, pressing will jump to that point.



The "LOOP OUT" determines the end point for a loop. The first time you press while a CD is in play mode, the "LOOP OUT" LED will turn on and flash while the song automatically returns to the "LOOP IN" point with no breaks and continues to play. When the song reaches the "LOOP OUT" point again it returns to the "LOOP IN" point and continues to repeat this action. You will notice the "LOOP IN" LED will also be flashing

during loop action. To release or end the LOOP press a second time and play will continue forward when the song passes the previously set "LOOP OUT" point. The "LOOP OUT" LED will be lit solid indicating that the "LOOP" is now in memory for "RELOOP" purposes.

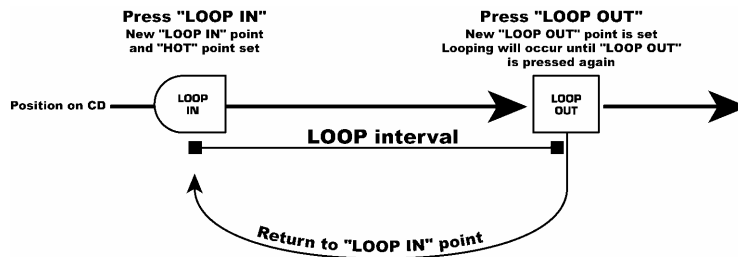

Note: The "LOOP OUT" point will be erased if "LOOP IN" is pressed or a new "CUE" point is set after the "LOOP OUT" point. This is important because without this point "RELOOP" will not be possible.

SMART LOOPING

The Beatkeeper and Looping can work together to set perfect loops every time. In order to work correctly first properly align the Beatkeeper™ on the beat. To active smart looping hold down followed by at the same time. After this has been done all loop points and stuttering will play perfectly to the beat of the music.

MOVING LOOP POINTS

The "LOOP IN" point can be moved while the music is

playing just by pressing  at the new desired point. The next time "LOOP OUT" is reached the CD will return to this new "LOOP IN" point. If "LOOP IN" is pressed after the "LOOP OUT" point it will clear the "LOOP OUT" point.

The "LOOP IN" point can also be edited while paused. First

hold down  then press  to move to the loop in point.

Next rotate the wheel to search for a new cue point

and then press  again to set the new point.

Check your point by pressing .

The "LOOP OUT" point can also be moved while a

loop is playing. Press  to release the old "LOOP OUT" point and pressing it again at the new desired point.

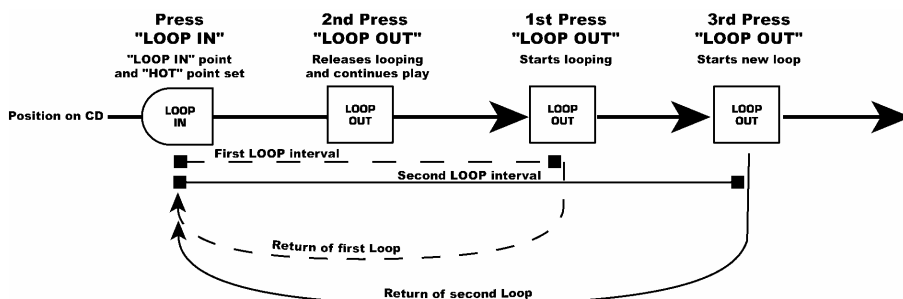
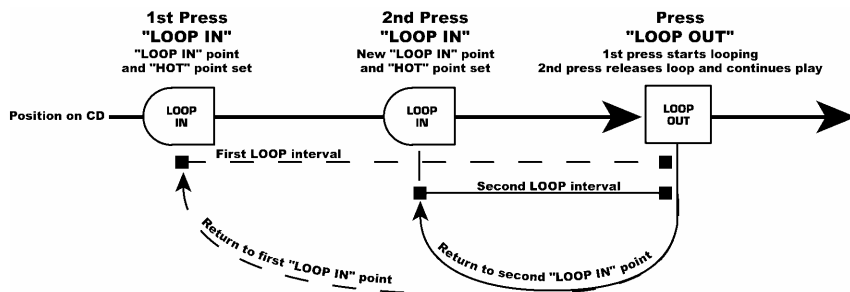

RELOOP/STUTTER

This button performs 2 different functions depending on loop setting.

Reloop is only possible if "LOOP" points have been previously set. The "RELOOP" function automatically returns the music to the "LOOP IN" point and will play the loop until it is released with the "LOOP OUT" button.

Stutter starts instant play from previously set "Hot" points. Simply set your stutter (Hot Start) point by following the directions for setting loop in because the points are the same. **Remember the button serves also for the reloop function so if a loop out has been set the unit will also loop until released.** This function lets you set 3 Hot Start points. The first is based on the "PLAY" cue point and the second two are based upon "LOOP IN". Since the default "LOOP IN" points are also the initial start point your unit can be "stutter" started from up to 3 buttons.

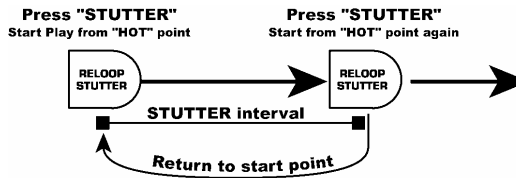
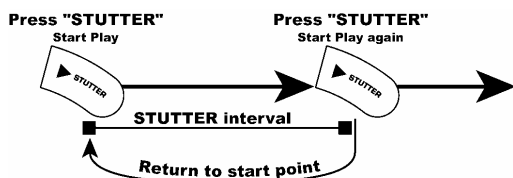
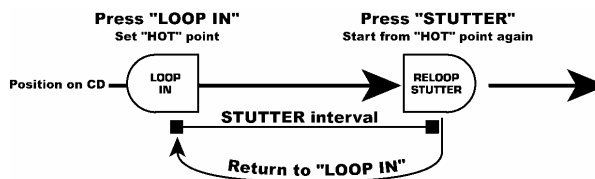
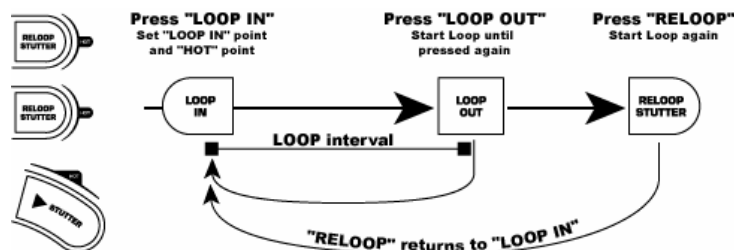

NOTE: The CD Player will always remember a new set "Hot" points until you actually set a new "LOOP IN" point or put in a new CD. The new point will be accessible until you remove the CD from the unit.

If you change tracks and you previously set a "Loop In" on another track, pressing  will jump to that point.

Numark- The Leader in DJ Technology

SPECIAL EFFECTS

Your AXIS 8 is equipped with some of most advanced effects on the market today. To fully take advantage of these effects it's helpful to practice and understand their use.



EFFECT SELECTION

To select and activate an effect tap on it's button, it will light to indicate activation and effect will indicate in the display. To put the effect into hold mode or active alternate effects press the center button. The button will light indicating the hold has been activated and hold will show in the display. To release any button, tap it once again.

EFFECT PARAMETER SELECTION

Once an effect is active, rotate the wheel to the desired parameter. The Parameter for most effects will show in the display above the effect indication. *Note: For all effects except reverse, pitch bend on the jog wheel will be deactivated so you must use the pitch bend buttons instead.*

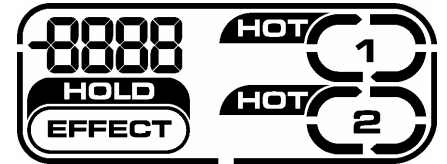

NOTE: The effect parameter can also be preset or changed without activation. Press on the desired effect and rotate the wheel without releasing the button. When the desired parameter is reached in the display, release the button. If an effect is already playing, the new parameter will be heard upon button release. If the effect is not active, then the next time the effect is activated it will be set to play from this parameter in "hold" mode. If you wish to preset an alternate effect such as SLIDE, PAN, or KILL press the hold button first, then hold down the effect button and spin the wheel as described above.

EFFECTS:



SCRATCH – This effect makes it possible for the wheel to scratch the music while it is playing. If you move the wheel back and forth the music will stop and play slowly as the wheel is moved similar to scratching a record. There are two modes of operation for this effect. By pressing followed by the scratch button you can toggle between Scratch 1,2,3, and 4. In "Scratch 1" the unit automatically returns to play when the wheel stops moving. In "Scratch 2", when the wheel is brought to a stop the music will stop and when you push the wheel forward the unit will automatically play. In "Scratch 3" the unit scratches from the current buffer until the unit is released. When released, the unit jumps ahead to the point where the music would have been, if not interrupted. This essentially allows a bleep of dirty lyrics through scratch. In "Scratch 4" the unit scratches from the last set cue point until released. This allows you to scratch from a set "sample"



SCRATCH HOLD – This effect works like the above except the music will not release when the wheel is pushed forward. It is basically the same as scratching on a powered off turntable. *Scratch is similar to working with a playing turntable, while the Scratch hold is similar to scratching a turntable with the power off.*



PHAZE – Creates an effect on the music similar to the sound of an airplane taking off. As the wheel is moved the effect is created. If the wheel stops moving the effect will return to the beginning on it's own. If the effect is in "Hold" the effect will stay at the current sound until the effect is released by the button or hold removed.



SONAR – creates a metallic hollow effect to create a slightly different sound. The wheel works a similar way as Phaze.



SLIDE – Smoothly changes the key of the music. In the key display you will see the key change as the wheel is moved.



ECHO – this effect adds echo to the music also based upon the Beatkeeper™. The start parameter is no echo "0". If you move the wheel to the right the numbers will go 1-64, 1-32, 1-16, 1-8, 1-4, 1-2, and 1-1 indicating the amount of echo added to the unit. If you move the wheel to the left you will create negative or preceding echo. This essentially plays the music before you get to it. At 1-1 the music will echo 1 full measure or 4 beats of music. If you turn off the effect then back on again it remembers the last set parameter.

(Note: a preceding echo requires the unit to play from buffer memory. If the buffer becomes unavailable the effect will stop until buffer is regained.)

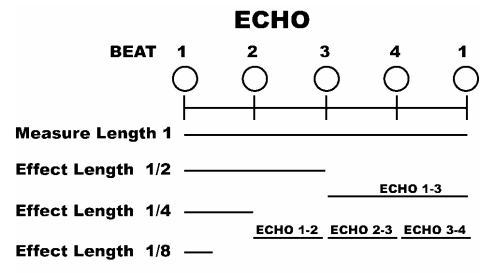



A.D. (Artificial-Dissemination) – Reduces the bit rate of the music creating increasing distortion with intensity.



CHOP – This effect works best when the Beatkeeper™ is properly aligned. Chop breaks up the music by turning the volume on and off based upon the BPM of the Beatkeeper™. First activation of the effect plays 1/8th note or half of every beat. In the BPM display will indicate an 1-8 which means one measure (4 beats) of music has been broken into 8 parts. Rotation of the wheel to the left decreases the parts to 1-4, 1-2, and 1-1. At 1-1 the music plays for 4 beats then is silent. Rotating to the right breaks up the music into 1-16, 1-32, 1-64, then smaller increments making for another interesting effect. When the effect is first activated the music will play the section then turn off for a section. This is important because you can reverse the sections that are off and on by activating the effect in the other section. If you deactivate the effect then turn it on again it remembers the last set parameter.

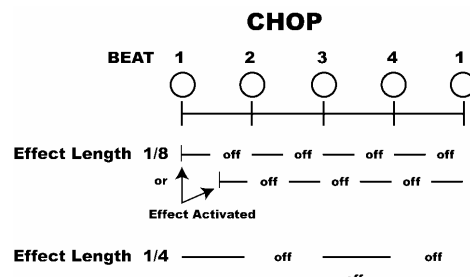

PAN - This effect also works best when the Beatkeeper™ is properly aligned. Auto-pan alternates playing right and left audio based upon the BPM of the Beatkeeper™. First activation of the effect plays alternates on 1/8th notes or half of every beat. In the BPM display will indicate an 1-8 which means one measure (4 beats) of music has been broken into 8 parts. Rotation of the wheel to the left decreases the parts to 1-4, 1-2, and 1-1. Rotating to the right makes faster changes of 1-16, 1-32, 1-64, then smaller increments making for another interesting effect. If you deactivate the effect then turn it on again it remembers the last set parameter.

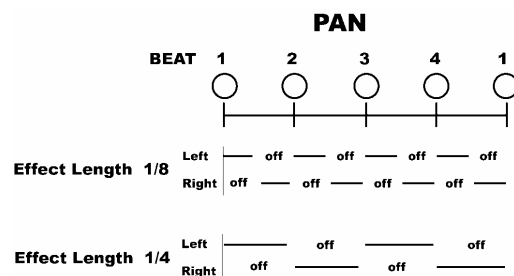

Isolate - This isolation filter lets you play only a specific frequency of the music. Rotation of the wheel moves the frequency played through the audio spectrum. If you turn off the effect then on again it remembers the last set parameter.

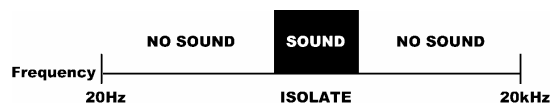

KILL- This elimination filter lets you play all but a specified frequency. Rotation of the wheel moves the frequency not played through the audio spectrum. If you turn off the effect then on again it remembers the last set parameter.



Reverse- Plays the music backwards. When the effect is activated the music will play backwards until it is released. There is no limit to the amount of time you can reverse.



Bleep- The effect activates as soon as the button is pressed. It is a temporary (forward) reverse function for “bleeping” dirty lyrics or creating interesting effects. By pressing the button the music plays backwards from buffer until released or until the buffer runs out. When the button is release, or the buffer runs out, the audio plays forward from the point where the music would have been if the button was never pressed. For example, is the effect is activated for 5 seconds at 10 seconds into a song, forward play will resume at 15 seconds. The buffer time for this operation is variable depending upon the number of loops set and anti-shock buffer available.

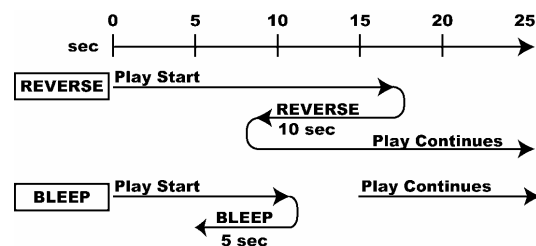



PROGRAM FUNCTIONS



PLEASE READ!!!!

This button provides several programmable functions depending upon the combination of buttons used.



Track Sequence Programming - Depress  while the unit is stopped and "PROGRAM" will light. Select each track to be programmed then press  between selections. Press "PLAY/STUTTER" to start the track sequence program playing. To exit and erase program hold  for more than 2 seconds while the unit is stopped, open the disc tray, or turn off the power.

The following functions will work by pressing  followed by appropriate function while still holding the program button:

SCRATCH



Effect Options - pressing program with an effect button will offer alternative options to that effect. In the case of the "SCRATCH" effect the display will toggle between "Scr 1" and "Scr 2". Not all effects offer options. More information on these options is available in the effects section of this manual.



End of track dead space elimination – this will give an option for eliminating the dead space at the end of tracks. The unit already automatically removes dead space at the beginning of tracks. End of track dead space elimination is useful if you are playing a CD continuously and want to eliminate all the gaps between songs. The display will indicate "SPR E" when the function is set to eliminate space and indicates "– SPR E" when the unit is left to leave the natural space between tracks. *This setting will be remembered at power down.*



Cueing Style Selection – this will alternate the jog wheel cue function from a smooth "scratch" sound to the traditional "stutter" sound modes during cue operations. The display will indicate "SCRATCH" when the "scratch" style is active. This indication will go away when the style of cue is stutter. *This setting will be remembered at power down.*



Brake Speed – this allows you to adjust the speed of 'PAUSE', or braking. Press "PAUSE" then rotate the wheel until the desired seconds of startup are shown. Pressing "PAUSE" twice will toggle startup from "OFF" to the desired seconds.



Startup Speed – this allows you to adjust the startup speed of initial play. Press "PLAY/STUTTER" then rotate the wheel until the desired seconds of startup are shown. The "STUTTER" function will not be affected. Pressing "PLAY/STUTTER" twice will toggle startup between "OFF" and the desired seconds.



Relay time – this gives options for the amount of time used for relaying between tracks on two connected units. Options will appear to relay immediately after the track (0), with time added of 1, 2, or 3 seconds (1,2,3), or a reduction of 1,2, or 3 seconds (-1,-2,-3). By reducing time the attached CD player will start playing before the end of a track, creating an automatic segue. *This feature will also work in track sequence program mode; however, if the units are also in SINGLE mode the same number of tracks programmed should be the same. Play will stop at the end of the last track. This setting will be remembered at power down.*



Remote Start – The sets the mode for the "remote" jack on the rear of the unit. Details can be found in the relay and remote start sections of this manual.



Automatic door close protection – this option automatically closes the door at the specified time. The display will indicate 30 seconds, 60 seconds, 120 seconds, and (no) for no auto close. *This setting will be remembered at power down.*



Digital Output – This activates digital output and allows digital audio information to be extracted from the unit. Some tracks also have other information encoded in the original audio output such as CDG graphic CDs for Karaoke. – ***Please see Specifications Page 19 for important manufacturer information.**



Smart Looping – When active the display will indicate "S-LOOP" and all looping and stuttering will follow the beat of the music based upon the Beatkeeper information.



Sleep Mode – The unit will automatically enter sleep mode after 15 minutes of inactivity. In this mode the unit will still start instantly from buffer, however, the laser will turn off to extend its life. If this feature is undesirable, then it can be turned off. *This setting will be remembered at power down.*

RELAY PLAY

This mode will be operational only when 2 units are connected via a relay cable.





1. Insert CDs into both of the units.
2. We recommend putting both sides in SINGLE play mode while learning this function.
3. Press the "RELAY" button on one unit to activate.
4. Press play on the first unit. When that unit has finished play it will send a signal to the second unit to start play. You will see the second unit start play and the first unit pause and cue to the beginning of the next track. When unit 2 has completed play unit 1 will start.

Note: The play signal is sent at the end of specified play. If the unit is in SINGLE mode the play signal will start the second unit at the end of the track. If the unit is in CONTINUOUS mode the play signal will be sent at the end of the full CD. Two CDs will play continuously, alternating from unit to unit.

FADER START

Fader Start is achievable by attaching your CD player to a similarly equipped DJ mixer and setting the rear panel selection switch to "mixer" mode.

1. Connect cables between the CD player and your DJ mixer.
2. Press the button or switch on your mixer into fader start mode to activate the fader start capability.
3. Set the CD player to fader start by hold down  followed by tapping  until the display says **FADER**.
4. Typically if you move the crossfader toward the active channel, the attached CD player will activate. When it is moved away the unit will cue or pause depending upon CD player setting.

To select start/stop mode hold the time button for 2 seconds.



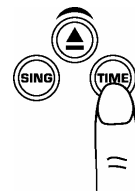

If the display shows **PAUSE** then the CD will pause when the crossfader is moved away.

If the display shows **CUE** then the CD will CUE when the crossfader is moved away.



REMOTE SWITCH START



Remote switch start is achievable by attaching your CD player to a switch like a foot switch found in most music shops. Foot switch connector plugs are often 1/4" and an adapter to 1/8" will be needed for connection.

1. Connect the remote switch to your CD player.
2. Select the type of foot switch you will use. There are two types of footswitches that will work with this connector. The first is a typical, ON-OFF pushbutton switch and are generally used for switching channels on guitar amps. Set the CD player to a ON-OFF switch by hold down  followed by tapping  until the display says **ON - OFF**. The second switch is a momentary footswitch and is usually used for keyboard sustain pedals. Set the CD player to a ON-ON switch by hold down  followed by tapping  until the display says **ON - - ON**. If you are unsure of the style of switch you have, try each position until it works as desired.
3. Typically if you press the switch once, the attached CD player will activate. When it is pressed again the unit will cue or pause depending upon CD player setting.



Note: You can also use a momentary switch in the ON-OFF switch position. In this case the unit will only play while the switch is depressed. When the button is release it will either cue or pause depending upon mode.

CUE/LOOP POINT STORAGE AND RECALL



To SAVE Cue and Loop points on the current CD:

- CD should still in the drawer with cue and loop points set.
- Press  + .
- Cue points are stored and LCD shows "CUE STORE" for 1 second.
- If MIDI OUT goes to another CD player's MIDI IN, the cue point is stored on the other CD player.

To RECALL Cue points on the current CD:

- Press  + .
- If CD player is open, it will automatically close and LCD will show "CUE FETCH" to indicate cue point loading.
- If CD is already in the player, it will stop the current function and show "CUE FETCH" to indicate cue point loading. If the CD doesn't have cue points stored on the CD player, then the LCD will show "NO FETCH".
- All cue, loop in, and loop out points are restored along with the BPM and downbeat for immediate access to beatkeeper functions.

To TRANSFER stored cue points from another unit:

- "No Disc" should be in the player
- The CD Player needing cue points, (Player A), should be looped via MIDI to another CD player with the cue points already stored (Player B).
- Press  +  on Player A to retrieve cue points from Player B.
- Player B will flash "CUE FETCH" and send all of its cue points to Player A
- Player A will then flash "CUE STORE" and store all cue points received.

Notes:

- *If over 1024 CDs have cue points written, the oldest cue points are overwritten.*
- *If the same CD is found with other cue points, the old cue point data is replaced by the new cue point data.*

UPGRADING YOUR UNIT

This unit contains the latest software available at the time of manufacturing. Our engineering staff will be working hard to constantly improve and offer additional features in the future. The unit software has been designed to be easily updateable by you through supplied CD updates from Numark. To obtain the latest software version contact your local Numark Dealer or visit us on the web at <http://www.numark.com>.

In order to check your unit's software version press "PROG" followed by the "+" button. Three sets of numbers will appear. 000 00 00 00. Your units function software will be in the "seconds" set of numbers. For example if R1 05 34 09 appears in the display you have version 34, revision 1 of the unit code

Audio CD Programming Procedure

Downloading

1. Go to www.numark.com and download the latest version of the unit software.
2. Load update wave file onto a computer with CD Drive capable of burning Audio CDs.
3. If zipped, using an unzip program on your computer, unzip the file.

Burning

4. Open up your CD burning software to burn an AUDIO CD.
5. Add the software wave file to the audio program contents. It is advisable to burn the CD at the slowest speed possible to ensure an accurate burn. If you have a disc-at-once option it should be used.
6. You should set the program to finalize the CD.
7. Burn the disc.

Programming

8. Power up your CD player with no CD inside.
9. Place in the CD in the tray and close the drawer with the OPEN/CLOSE button. Do not close the drawer by pressing PLAY.
10. Wait until the display indicates time remaining.
11. Press the Play button. In the effect parameter display you will see the word "test" as the time counts down. The unit will then go through the cycle again and indicate "busy" while the unit is programmed.
12. At completion of the procedure the CD should eject automatically and the display will indicate "good".

Completion

13. Remove the CD and power the unit off for 3 seconds and then on again.
14. Recalibrate the unit following the "calibration procedure" included with the software update.

Note: CD burning is dependant upon both the recording equipment and the CD players ability to read the burned information. On rare occasions the unit may have difficulty reading the burned CD. If the CD is ejected during the test procedure, remove the CD and try again. If it fails again try re-burning the CD. If this doesn't work, contact Numark service at 401-295-9000 or techsupport@numark.com for a free upgrade CD.

AXIS 8

MIDI IN-OUT

MIDI – stands for musical instrument digital interface. Basically this means you can hook up 2 MIDI compatible devices and they will talk to each other. In this case you might connect 2 AXIS 8s and have them synchronize beats, add a MIDI keyboard and have it control the CD players or hook up a drum machine and play a rhythm pattern in time with the music.

INTERLOCK MODE: For interlock you will need 2 units hooked up via 2 MIDI cables input to output. Pressing PROG + BPM will put the unit in INTERLOCK mode when (2) AXIS 8 are connected via MIDI. This mode will automatically match the BPM on (2) AXIS 8 units and lock them together on the beat. *Before using this function it is important to be sure the Beatkeeper is tracking the correct BPM and is actually synchronized with the beat.* In order to match effectively one unit will indicate master and the other, slave. **The master is always the first unit to be playing.** The slave follows the master. As soon as the master is stopped for any reason the opposite side becomes the new master control. Before using this function it is advisable to activate the key lock since pitch shifts are automatic and can be audible. When interlock is pressed you will see the BPM display of the slave automatically change to match the master and the pitch indication in the display change the amount needed to match speeds. During interlock all pitch functions of the slave will deactivate and follow



everything you do with the master. All actions of the slave such as loop functions, , and PLAY will now also be beat aligned with the master.

- If both units are playing the slave will adjust to match to the nearest beat of the master.



- If  is pressed the slave will now start with the next beat of the master.



- If  is pressed during INTERLOCK, the slave will automatically start the next time the master matches the beat of the slave.

SLAVE TO MIDI CLOCK: When the AXIS 8 is hooked up to receive another clock device through it's MIDI input, such as a drum machine, beat synchronization can be achieved similarly to the above. In this case the AXIS 8 will receive and synchronize to the global clock and always remain as the slave device.

GLOBAL MIDI CLOCK TRANSMIT: when the MIDI output of the AXIS 8 is attached to another clock receiving device, such as a drum machine, the device will receive global clock information from the AXIS 8. Play and Pause commands will be sent as well.

INCREASE/DECREASE: When the slave becomes the master or is released from interlock and still playing, the pitch playing will often be different than the original position of the pitch slider. The pitch slider will not function until it is brought to the new position. Move the pitch slider in the direction shown in the display. For example if the display says "**INCREASE 4.5%**" move the slider in the positive direction 4.5% (increase). If it says "**DECREASE -3%**" then move the slider in the negative direction 3% (decrease). As you get closer to the correct position the indication will reduce until you are at the pitch currently playing. After this has been achieved all pitch functions will return to the player and pitch can be adjusted as normally. If the unit is stopped for any reason the pitch will automatically reset to the current position of the slider. **Note: Interlock may automatically deactivate when effects are engaged that can not be beat aligned such as live scratch.**

HOOKING UP A MIDI KEYBOARD: attach the MIDI output of the keyboard to the MIDI input of the CD Player. Set your keyboard to transmit on Channel 6. Add a foot pedal to the keyboard for added control. The chart below details key reaction.

SET TRANSMIT TO MIDI CHANNEL 6

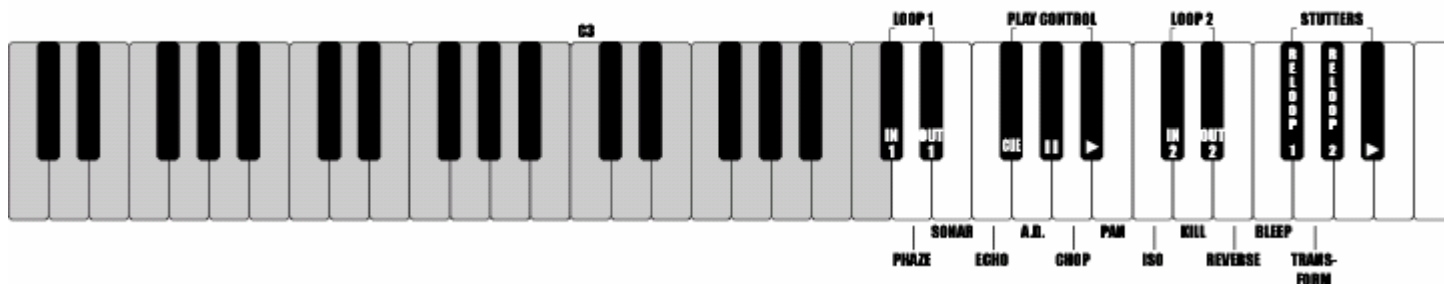

MIDI IMPLEMENTATION CHART

MIDI IMPLEMENTATION CHART				
MODEL: AXIS 8				Date: 4/24/2002 Version: 1
		Transmitted	Recognized	Remarks
Basic Channel	Default	5	1,5,6	1=turntable, 5=CD player
	Changed	X	X	6=keyboard
Mode	Default	Omni On	Omni On	
	Messages	X	X	
	Altered	X	X	
Note Number	True Voice	X	21-72	Key transpose, keyboard channel
	Other	X	73-95	CD functions, keyboard channel
Velocity	Note On	X	O	
	Note Off	X	O	
After Touch	Keys	X	X	
	Channel	X	X	
Pitch Bend		X	O	Turntable channel only
Control Change	16	O	O	CD player channel only
	64	X	O	Keyboard channel only
Program Change		X	X	
	True Number	X	X	
System Exclusive System		X	X	
	Song Position	X	X	
	Song Select	X	X	
Common System	Tune Request	X	X	
	Clock	O	O	
Real Time	Commands	O	O	*1
	Local On/Off	X	X	
Aux Messages	All Notes Off	X	X	
	Active Sensing	X	O	Needed to keep Axis 8 in slave mode
	System Reset	X	X	

Notes: *1 System Real Time commands will not play/pause CD player. These are only used for MIDI clock repositioning.

*note: further MIDI Specs can be found at our web site <http://www.numark.com>

AXIS 8

BEFORE SWITCHING OFF THE POWER:

When you have finished using the CD player, be sure that the disc tray is closed with the "OPEN/CLOSE" button before switching off the power.

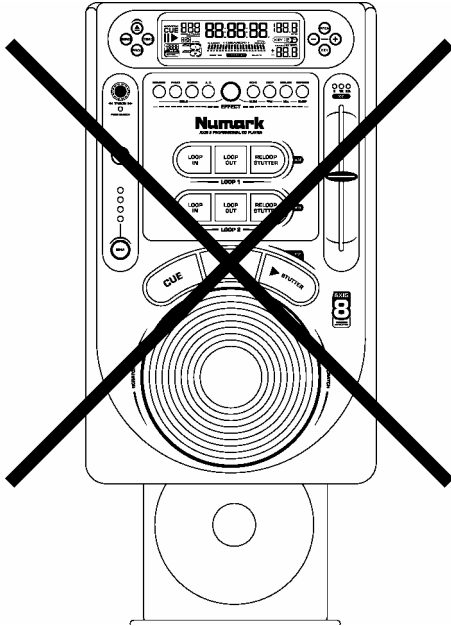

DO NOT switch off the power when the disc holder is open.

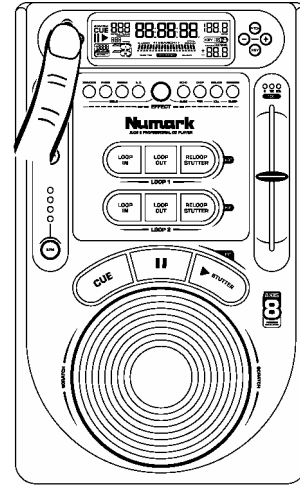

Switch off the power **after** the disc holder has been closed with the "OPEN/CLOSE" button

TROUBLESHOOTING:

Symptom	Possible Cause	Corrective Action
The power fails to switch on when the POWER switch is set to on	Poor power plug connection at the AC outlet or IEC Power cord loose from rear of unit	Insert the power plug firmly into the AC outlet and make sure connection is good in unit rear
Disc play does not start	The disc is loaded upside down The disc is too dirty	Reload the disc with the label side up Clean the disc
No sound	Improper output cable connections Improper amplifier operation	Connect the output cables correctly Check amplifier setup
Sound skips	The CD player is subject to vibrations or physical shock even with Anti-Shock™ The disc is too dirty	Change the installation location Clean the disc
Hum	Loose cable connections	Firmly connect all audio plugs

Numark- The Leader in DJ Technology

SPECIFICATIONS

TECHNICAL

Disc Type	Standard Compact discs (12 cm & 8 cm)
Time Display	Track Elapsed, Track Remain, or Total Remain
Quantization	1 bit linear/Channel, 3 Beam Laser
Oversampling rate	8 Times
Sampling Frequency	88.2 kHz
Frequency response	20 Hz to 20 kHz
T.H.D. + NOISE	Less Than 0.005%
S/N ratio (IHF-A)	> 96 dB
Dynamic range	> 94 dB
Output level	1.3 Volts R.M.S.
Start Time	within 0.006 seconds
Pitch control range	± 6, 12, 25, 100% slider
Pitch bend	± 50% rotary and buttons ± 16%
Digital Output	type 2, form 1, S/PDIF (Sony/Phillips Digital Interface Format)

GENERAL

Dimensions:	9.75" x 8.5" x 3.25" (247 x 216 x 82.5mm)
Weight:	6.5 lbs (2.95 kg)
Power Supply:	115/230V AC, 50/60Hz
Power Consumption:	15W

* Specifications are subject to change due to ongoing improvements

Numark[®]

Professional Disc Jockey Products

LIMITED PRODUCT WARRANTY

1. What is covered and for how long? NUMARK INDUSTRIES LCC ("NUMARK") warrants to the original purchaser that NUMARK'S DJ Mixers, Amplifiers, CD players, turntables, preamplifiers, beatkeepers, equalizers, microphones, headphones, and all other accessories are free from defects in material and workmanship under normal use and service for the period commencing upon the date of purchase from an authorized NUMARK dealer and continuing for the following period of time after that date for (1) Year.
2. What is not covered? This Limited Warranty is conditioned upon proper use of the product by the purchaser.
This Limited Warranty does not cover: (a) defects or damage resulting from accident, misuse, abuse, neglect, unusual physical or electrical stress, modification of any part of the product, or cosmetic damage; (b) equipment that has the serial number removed or made illegible; (c) all plastic surfaces and other externally exposed parts that are scratched or damaged due to normal use; (d) defects or damage from improper testing, operation, maintenance, installation, adjustment, or service of the mixers; (e) crossfaders.
3. What are NUMARK'S obligations? During the applicable warranty period, NUMARK will repair or replace, at NUMARK'S sole discretion, without charge to the purchaser, any defective component part of the mixer. To obtain service under this Limited Warranty, purchaser must first contact NUMARK and obtain a return authorization number ("RA#"). Purchaser must then return the mixer to NUMARK in an adequate container for shipping, accompanied by purchaser's sales receipt or comparable proof of sale showing the date of purchase, the serial number of the product, and the seller's name and address. To obtain an RA# and assistance on where to return the mixer, contact NUMARK customer service at 401-295 9000. Upon receipt, NUMARK will repair or replace the defective products. NUMARK may, at NUMARK'S sole discretion, use rebuilt, reconditioned, or new parts or components when repairing any product or replace a product with a rebuilt, reconditioned or new product. Repaired mixers will be warranted for a period equal to the remainder of the original Limited Warranty on the original mixer or for (90) days, whichever is longer. All replaced parts, components, boards and equipment become the property of NUMARK. If NUMARK determines that any mixer is not covered by this Limited Warranty, purchaser must pay all parts, shipping, and labor charges for the repair or return of such mixer.
4. What are the limits on NUMARK'S liabilities? THE WARRANTIES GIVEN IN THIS LIMITED WARRANTY, TOGETHER WITH ANY IMPLIED WARRANTIES COVERING NUMARK MIXERS, INCLUDING WITHOUT LIMITATION ANY WARRANTIES OF MERCHANTABILITY OR FITNESS FOR A PARTICULAR PURPOSE, ARE LIMITED TO THE DURATION OF THIS LIMITED WARRANTY. EXCEPT TO THE EXTENT PROHIBITED BY APPLICABLE LAW, NUMARK SHALL NOT BE LIABLE FOR ANY SPECIAL, INCIDENTAL, CONSEQUENTIAL, INDIRECT OR SIMILAR DAMAGES, LOSS OF PROFITS, DAMAGES TO PURCHASER'S PROPERTY, OR INJURY TO PURCHASER OR OTHERS ARISING OUT OF THE USE, MISUSE OR INABILITY TO USE ANY NUMARK MIXER, BREACH OF WARRANTY, OR NEGLIGENCE, INCLUDING BUT NOT LIMITED TO NUMARK'S OWN NEGLIGENCE, EVEN IF NUMARK OR ITS AGENT HAS BEEN ADVISED OF SUCH DAMAGES, OR FOR ANY CLAIM BROUGHT AGAINST PURCHASER BY ANY OTHER PARTY. THIS LIMITED WARRANTY IS THE COMPLETE WARRANTY FOR NUMARK'S MIXERS, AND IS GIVEN IN LIEU OF ALL OTHER EXPRESS WARRANTIES. THIS LIMITED WARRANTY SHALL NOT EXTEND TO ANYONE OTHER THAN THE ORIGINAL PURCHASER OF THIS PRODUCT AND STATES PURCHASER'S EXCLUSIVE REMEDY. IF ANY PORTION OF THIS LIMITED WARRANTY IS ILLEGAL OR UNENFORCEABLE BY REASON OF ANY LAW, SUCH PARTIAL ILLEGALITY OR UNENFORCEABILITY SHALL NOT AFFECT THE ENFORCEABILITY OF THE REMAINDER OF THIS LIMITED WARRANTY WHICH PURCHASER ACKNOWLEDGES IS AND WILL ALWAYS BE CONSTRUED TO BE LIMITED BY ITS TERMS OR AS LIMITED AS THE LAW PERMITS. This Limited Warranty allocates risk of product failure between purchaser and NUMARK, and NUMARK'S product pricing reflects this allocation of risk and the limitations of liability contained in this Limited Warranty. The agents, employees, distributors, and dealers of NUMARK are not authorized to make modifications to this Limited Warranty, or make additional warranties binding on NUMARK. Accordingly, additional statements such as dealer advertising or presentation, whether oral or written, do not constitute warranties by NUMARK and should not be relied upon.
5. How does state law apply to this warranty? SOME STATES DO NOT ALLOW THE EXCLUSION OR LIMITATIONS OF INCIDENTAL OR CONSEQUENTIAL DAMAGES OR HOW LONG AN IMPLIED WARRANTY LASTS, SO THE ABOVE LIMITATIONS OR EXCLUSIONS MAY NOT APPLY TO PURCHASER.
6. This Limited Warranty gives you specific legal rights. You may also have other rights, which vary from one jurisdiction to another.

RETURN INFORMATION

- A Return Authorization number must be obtained from Numark through the address or phone numbers below.
- A copy of the original sales receipt must also be included for the equipment to be repaired under warranty.
- The faulty equipment must be packed in its original packaging.
- One additional outer layer of packaging must be included to ensure product safety. Failure to do so may inadequately protect the equipment in transit and, therefore, jeopardize the customer's warranty.
- Numark will not accept COD shipments and no call tags will be issued for merchandise return.
- Numark will not return repaired merchandise to customers by priority service, unless by written request at the customer's cost. Requests must be submitted in writing with merchandise returned.
- The defective Numark equipment should be sent, FREIGHT PREPAID with Return Authorization number clearly printed on the outer packaging and original sales receipt enclosed to:

Numark INDUSTRIES
Attention: Service Department
11 Helmsman Avenue
North Kingstown, RI 02852 USA

Phone: +1 (401) 295-9000
Fax: +1 (401) 295-5200
Web: www.numark.com

Free Manuals Download Website

<http://myh66.com>

<http://usermanuals.us>

<http://www.somanuals.com>

<http://www.4manuals.cc>

<http://www.manual-lib.com>

<http://www.404manual.com>

<http://www.luxmanual.com>

<http://aubethermostatmanual.com>

Golf course search by state

<http://golfingnear.com>

Email search by domain

<http://emailbydomain.com>

Auto manuals search

<http://auto.somanuals.com>

TV manuals search

<http://tv.somanuals.com>