

# Numark®

## AXIS 2 CD Player with ANTI-SHOCK™

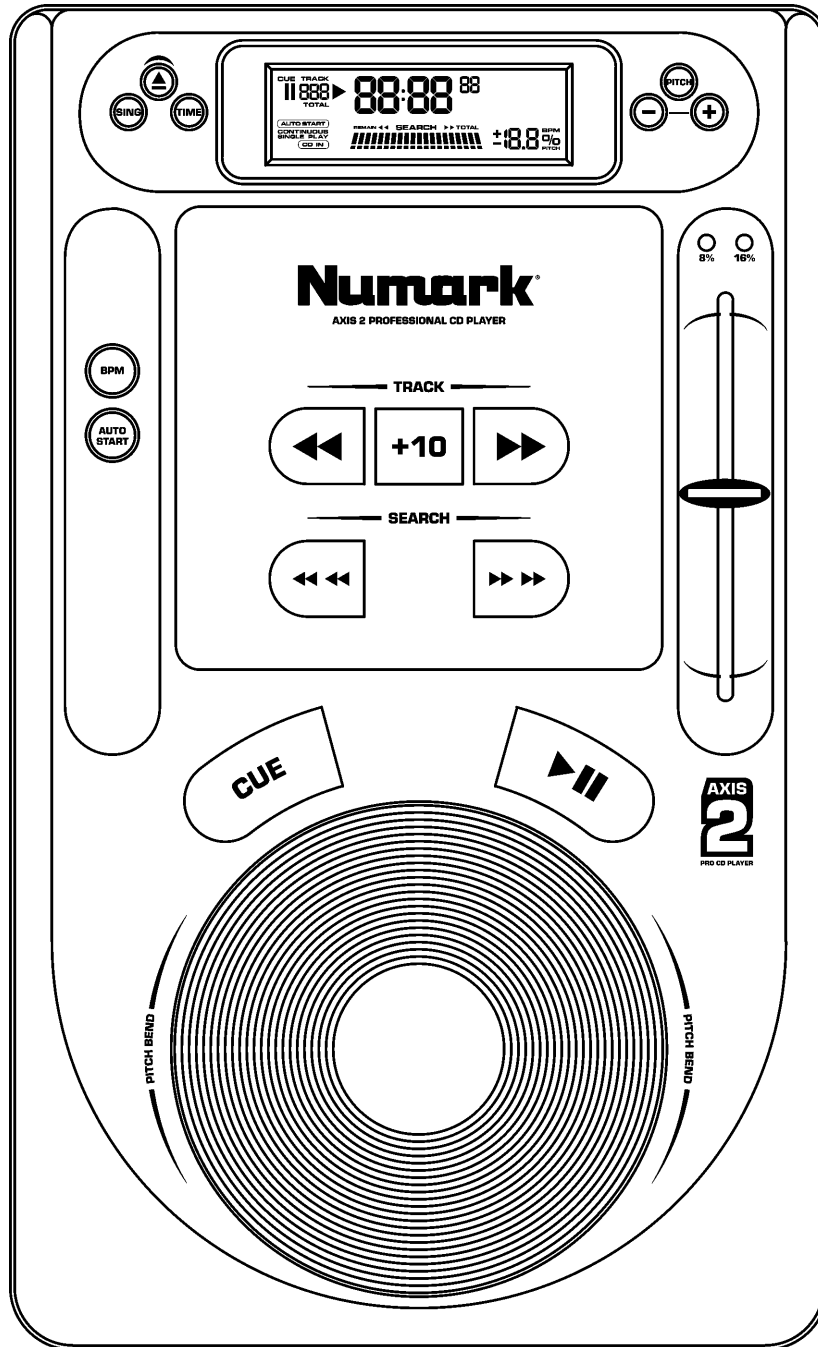

# MANUAL

## AXIS 2

### **SAFETY INSTRUCTIONS**

- a) **Read Instructions** - All the safety and operating instructions should be read before this product is connected and used.
- b) **Retain Instructions** - The safety and operating instructions should be kept for future reference.
- c) **Heed Warnings** - All warnings on this product and in these operating instructions should be followed.
- d) **Follow Instructions** - All operating and other instructions should be followed.
- e) **Placement** - place the unit in a clean dry location.
- f) **Water and Moisture** - This product should be kept away from direct contact with liquids. The apparatus shall not be exposed to dripping or splashing and that no objects filled with liquids, such as vases, shall be placed on the apparatus.
- g) **Temperature** - Avoid placing this product close to any high heat sources such as radiators. Do not use this unit at temperatures below 41°F/5°C or higher than 95°F/35°C.
- h) **Ventilation** - The appliance should be situated so that its location or position does not interfere with its proper ventilation. For example, the appliance should not be situated on a bed, sofa, rug, or similar surface that may block the ventilation opening; or, placed in a built-installation, such as bookcase or cabinet that may impede the flow of air through the ventilation openings.
- i) **Power Sources** - This product should be connected to a power supply only of the type described in these operating instructions, or as marked on the unit.
- j) **Power Cord Protection** - Power supply cords should be routed so that they are not likely to be walked upon or pinched by items placed on or against them. When removing the cord from a power outlet be sure to remove it by holding the plug attachment and not by pulling on the cord.
- k) **Object and Liquid Entry** - Take care that objects do not fall into and that liquids are not spilled into the inside of the mixer.
- l) **Cleaning** - The appliance should be cleaned only as recommended by the manufacturer. Do not use chemical solvents to clean the unit.
- m) **Non-use Periods** - The power cord of the appliance should be unplugged from the outlet when left unused for long periods of time.
- n) **Damage Requiring Service** - Only qualified personnel should service this product. If you have any questions about service please contact Numark at the number(s) shown on the back cover of this manual.
- o) **Grounding or Polarization** - Precautions should be taken so that the grounding or polarization means built into the CD player is not defeated.
- p) **Internal/External Voltage Selectors** - Internal or external voltage selector switches, if any, should only be reset and re-equipped with a proper plug for alternative voltage by a qualified service technician. Do not attempt to alter this yourself.
- q) **Carts and Stands** - The appliance should be used only with a cart or stand that is recommended by the manufacturer of the cart or stand. An appliance and cart combination should be moved with care. Quick stops, excessive force, and uneven surfaces may cause the appliance and cart combination to overturn.

#### **SERVICE INSTRUCTIONS**

- Disconnect power cord before servicing
- Replace critical components  only with factory parts or recommended equivalents
- For AC line powered units - Before returning repaired unit to user, use an ohmmeter to measure from both AC plug blades to all exposed metallic parts. The resistance should be no more than 100,000ohms.

**DANGER: INVISIBLE LASER RADIATION WHEN OPEN AND INTERLOCK FAILED OR DEFEATED. AVOID DIRECT EXPOSURE TO BEAM.**

**USE OF CONTROLS OR ADJUSTMENTS OTHER THAN THOSE SPECIFIED HEREIN MAY RESULT IN HAZARDOUS RADIATION EXPOSURE**



**CAUTION**  
**RISK OF ELECTRIC SHOCK**  
**DO NOT OPEN**



**CAUTION: TO REDUCE THE RISK OF ELECTRIC SHOCK DO NOT REMOVE ANY COVER. NO USER-SERVICEABLE PARTS INSIDE. REFER SERVICING TO QUALIFIED SERVICE PERSONNEL ONLY.**

The lightning flash with arrowhead symbol within the equilateral triangle is intended to alert the user to the presence of un-insulated "dangerous voltage" within the product's enclosure that may be of sufficient magnitude to constitute a risk of electric shock.

**The exclamation point within the equilateral triangle is intended to alert the user to the presence of important operating and maintenance (servicing) instructions in the literature accompanying this appliance.**

#### **CAUTION**

**FOR USA & CANADIAN MODELS ONLY**  
**TO PREVENT ELECTRIC SHOCK DO NOT USE THIS (POLARIZED) PLUG WITH AN EXTENSION CORD, RECEPTACLE OR OTHER OUTLET UNLESS THE BLADES CAN BE FULLY INSERTED TO PREVENT BLADE EXPOSURE.**

**WARNING:** To reduce the risk of fire or electrical shock, do not expose this appliance to rain or moisture. Electrical equipment should NEVER be kept or stored in damp environments.

#### **NOTICE CONCERNING FCC REGULATIONS**

This equipment generates and uses radio frequency energy and may cause interference to radio and television reception if you do not operate it in strict accordance with the procedures detailed in this OPERATING MANUAL. This unit complies with Class B computing device rules in accordance with the specifications in Sub-part J or Part 15 of the FCC Rules, which are designed to provide reasonable protection against such interference in a residential installation. There is no guarantee, however, that interference will not occur in a particular installation. If the unit does cause interference to any radio or television reception, try to reduce it by one or more of the following means:

- a) Reposition the other unit and/or its antennae
- b) Move this unit
- c) Move this unit and the other unit(s) further apart
- d) Plug this unit into a different AC outlet so that it is on a different circuit from the other equipment.

This note is in accordance with Section 15.838 of the FCC Rules.

This unit does not exceed the Class B limits for radio noise emission from digital apparatus set out in the radio interference regulations of the Canadian Department of Communications.

## **DOUBLE INSULATED - When servicing use only identical replacement parts**

For 220-volt use in USA, use NEMA style 220-volt plug. For other countries use proper plug for local outlet.

**Numark - The Leader in DJ Technology**

# Numark<sup>®</sup> AXIS 2

## PROFESSIONAL TABLETOP CD PLAYER

### CONGRATULATIONS...

You have just purchased a CD player designed specifically for the professional DJ. This unit has been designed to provide CD mixing with the same ease and creativity that you have enjoyed with records. Please take a few moments to familiarize yourself with the AXIS 2 by reading the following information before attempting to operate the unit.

Once again, congratulations and thank you for making the AXIS 2 your choice in professional CD players.

### FEATURES:

- Large interactive pitch wheel adjustment
- Back lit buttons
- Fader/relay start
- Digital Output
- Frame search
- Auto cue
- +10 tracks skip search
- Pitch display

CHECK TO BE SURE  
THE FOLLOWING ITEMS ARE IN THIS BOX:

CD UNIT  
IEC POWER CORD  
FADER START CABLE

OWNERS MANUAL (THIS BOOKLET)  
RCA CONNECTING CABLES

Please record the serial number of your unit as shown on the back of the chassis as well as the name of the dealer from whom you purchased the unit. Retain this information and your original purchase receipt for your records. Please return the enclosed warranty card to register your CD player with us.

MODEL: \_\_\_\_\_ PURCHASED FROM: \_\_\_\_\_  
SERIAL NUMBER: \_\_\_\_\_ DATE OF PURCHASE: \_\_\_\_\_

**Numark - The Leader in DJ Technology**

## **TABLE OF CONTENTS**

<b>Safety Instructions</b>	2
<b>Introduction and Registration</b>	3
<b>Set-up &amp; Connections</b>	5
<b>Description of the Features</b>	
Top Panel	6
Front Panel	8
Rear Panel	8
Display	9
<b>Basic Operation</b>	
Play, Pause and Cue Operations	10
Matching the Tempo	11
Beat Matching Using Pitch Bend	11
Relay and Fader Start	12
<b>Example of Mixing</b>	13
<b>Before Switching off the Power</b>	14
<b>Troubleshooting Guide</b>	14
<b>Information and Specifications</b>	15
<b>Warranty</b>	16

## SETUP and CONNECTIONS

Typical connection with a mixer is illustrated below.

1. Find a level surface free of excessive vibration to place your equipment
2. Connect the line output connections using the supplied audio cable from the CD Player to the line inputs of your mixer.
3. Connect Fader start cable. Attach your CD play to a similarly equipped DJ mixer. *(This connection can also be used with a remote switch)*
4. If setting up 2 units, you can connect a relay cable between the units. *(This cable is a standard 1/8" stereo - 1/8" stereo cable obtainable from your local music or electronics store)*
5. Connect IEC power cord to appropriate power source.

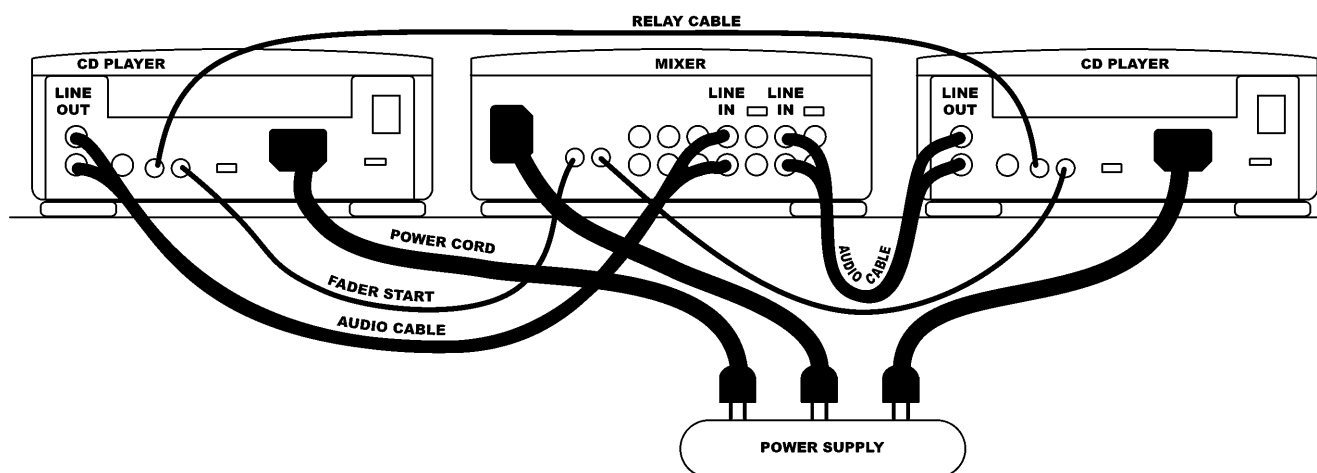

**DIGITAL OUTPUTS:** This CD player is specially equipped with digital outputs. The format is type 2, form 1, also known as S/PDIF (Sony/Phillips Digital Interface Format). When the digital output is used the variable pitch slider and pitch bend buttons or pitch wheel should not be used.  
**Note:** If digital information is allowed to change in pitch, other devices may not read the digital output properly.

### LINE VOLTAGE SELECTION

- 1) The desired voltage may be set with the VOLTAGE SELECTOR switch on the rear panel of the unit.
- 2) Do not move the VOLTAGE SELECTOR switch with excessive force as this may cause damage.
- 3) If the VOLTAGE SELECTOR switch does not move smoothly contact a qualified serviceman.



**Numark**- The Leader in DJ Technology

## TOP PANEL FEATURES

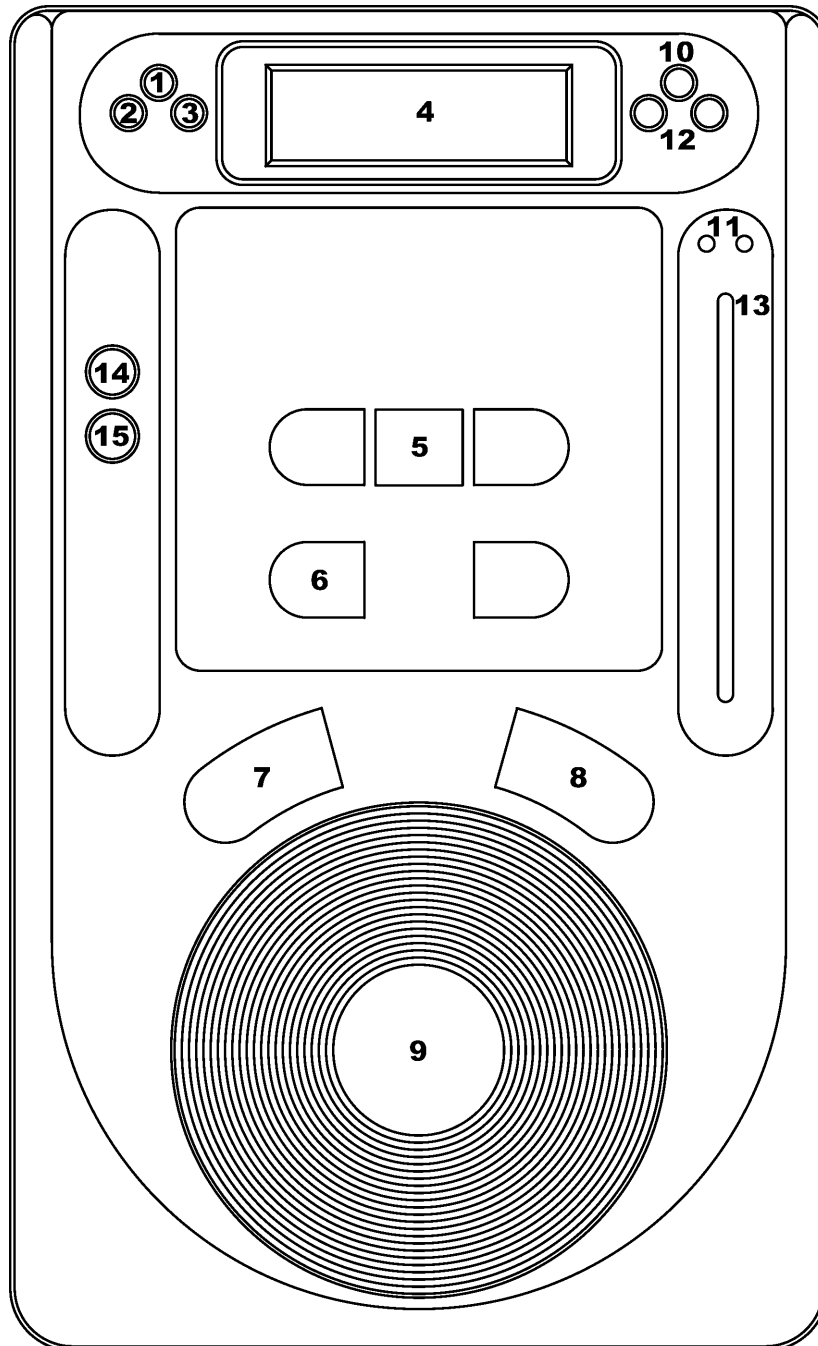

1. **Open/Close:** Press to load or eject the disc. The tray will not open if a disc is in play. The tray door will automatic close in 30 seconds if left open. This is to protect the tray from accidental damage while open
2. **Single:** toggles the unit to play back just one track at a time (single) or play continuously through all tracks and then start over repeating the CD infinitely (continuous).
3. **Time:** switches the time modes on the display between elapsed playing time, remaining time on the track, and remaining time on the total CD. When toggled to remaining time total the total number of remaining tracks will also show.
4. **LCD DISPLAY** - Indicates all the functions, as they are occurring, with the CD.
5. **Track Buttons:** These buttons are used to select the track to be played. “+10” allows the user to quickly move through tracks on the CD.
6. **Search Buttons:** Pressing these buttons create a rapid scan of the music to find a cue point.
7. **Cue:** Returns and pauses the music at the last set cue point. The cue point is where the music will begin when play is pressed. The cue point is set as the initial start point on a track or can be moved when play is started at a different point. For instance, if the music is paused, pressing play will set a new cue point. You can easily edit the cue point by turning the wheel during pause. As you rotate the wheel the music will sound. By stopping the wheel and pressing play a new point is set. Alternately pressing the PLAY button and the CUE button allows the CD to be played from the same position any number of times.  
*Note: Pressing cue 2 times plays music temporarily from this point until the button is released.*
8. **Play/Pause:** Starts the music from the cue point or pauses it while in play. By pressing play after pause a new cue point will be set
9. **Jog Wheel:**  
**Cue Function:** As explained under “CUE”, when the music is paused and you rotate the wheel, music will sound. By pressing play a new cue point is set.  
**Pitch Bend Function:** allows the user to temporarily change the speed of the music to align beats. When the beats of the music of the CD you wish to match is fast compared to the tempo of the other music rotate the jog wheel counter clockwise (to the left). When the CD is behind rotate the jog wheel clockwise (to the right). The pitch changes temporarily while the jog wheel is rotated. The faster you rotate the wheel the more pitch is changed. Releasing the wheel results in a return to the original pitch.
10. **Pitch Range:** activates the pitch slider and adjusts the amount of control the pitch slider has on the overall speed of music. Tapping the pitch will toggle slider between 8% and 16% pitch ranges. Holding the pitch for 3 seconds will deactivate the pitch control.
11. **Pitch Range LEDs:** indicate current pitch range. When both LEDs are off the pitch slider is not active
12. **Pitch Bend Buttons:** Allows the user to temporarily change the speed of the music to align beats. When the beats of the music of the CD you wish to match is fast compared to the tempo of the other music press the (-). When the CD is behind press the (+). The pitch changes temporarily while the (+) or (-) button is being pressed. The longer you hold the buttons the more pitch is changed. Releasing the buttons results in a return to the original pitch.
13. **Pitch Slider:** By moving the slider in the (+) direction the speed of the music permanently speeds up. By moving the slider in the (-) direction the speed of the music permanently slows down. To match the speeds of two CDs you can adjust the pitch. When the tempo of the music of the CD you wish to match is slow compared to the tempo of the other music, move the slider to the (+) side and match the speed. When faster, move the pitch slider to the (-) side. By making this adjustment the speeds will be matched though the beats may not yet be aligned.
14. **BPM** - Tapping this button with the beat of the music indicates the current Beats Per Minute (BPM) in the display. The unit will average your taps to determine the BPM so multiple taps is recommended.
15. **Relay** – Pressing this button on two units connected by the relay cable will cause the units to alternate play as one stops and the other starts. If the units are set to single play mode then relay will alternate after each track. If the unit is set to continuous it will relay after the entire CD is played.

## FRONT PANEL

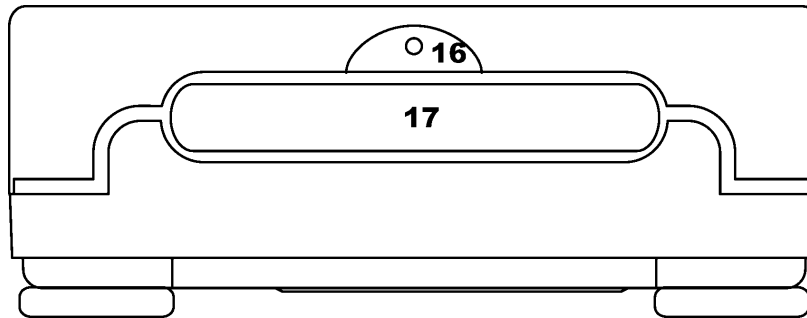

16. **CD Illumination Light** – lights up the CD drawer and CD when open.
17. **CD Drawer** – Place your CDs you wish to play in here. This unit is designed to play commercially available CD and properly burned and finalized CDR and CDRW formats. Due to variances on the specification of certain CD burners and CDs some discs home made CDs may not play properly.

## REAR PANEL

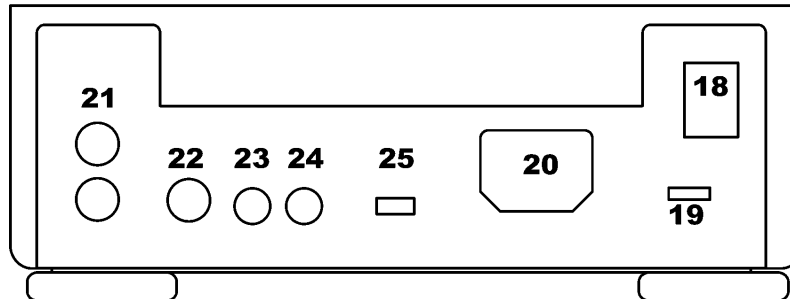

18. **Power Switch**- Turn on and turn off the machine with this button. The unit should always be shut down with this button first before any external power is removed. Typically it is recommended that the CD player is powered on before amplifiers and off after amplifiers to avoid an audio spike to be sent through your equipment.
19. **Voltage Selector** - Set this switch to the voltage for your location.
20. **IEC Power Plug Connector** - Plug your supplied power cord in here.
21. **RCA Audio Connectors** - Connect your CD player to your mixer from this line level output.
22. **Digital Output** - The format is type 2, form 1, also known as S/PDIF (Sony/Phillips Digital Interface Format). In order to use the digital output you should not use variable pitch slider and the pitch bend buttons. *If you adjust the pitch, other devices may not read the digital output properly because the sampling rate changes*
23. **Relay Connector**- If you wish to use the relay function plug in your 3.5mm stereo control cables into here and then into your other unit. The cable must be a stereo style plug for the units to work properly
24. **Remote Start Connector** – Use this connector to plug into your fader start compatible mixer or remote switch. This function is always active. To use this connector for fader start, connect the supplied fader start cable to a fader start compatible mixer. Every time you move the crossfader on the mixer over to the side that the unit is on, it will automatically start playing. When you move the fader away from that side, the unit will stop. Moving the fader *back* to the unit side will start play again.
- There are two potential modes associated with the switch PLAY-CUE and PLAY/PAUSE. The factory setting is PLAY-CUE mode. This means that when the unit is remotely stopped it will go back to the cue point automatically. To change modes hold down the time button for 3 seconds and the display will flash the play “▶” and pause “||” icons. In PLAY/PAUSE mode, moving the crossfader away from the unit side pauses right where it is, and resumes when the fader is brought back to the unit. To change modes back to PLAY-CUE hold down the time button for 3 seconds and the display will flash the play “▶” and cue “**CUE**” icons in the display.
25. **Remote Assignment Switch** - Set this switch in the position for the method of remote start you will be using. Foot switches are often used for creative mixing techniques and can be found in most music shops. Connector plugs are often ¼” and an adapter to 1/8” will be needed for connection. There are also two types of footswitches that will work with this connector. The first is a typical, on/off pushbutton switch and are generally used for switching channels on guitar amps. The second switch is a momentary footswitch and is usually used for keyboard sustain pedals. If you are unsure of the style of switch you have, try each position until it works as desired.
- **ON-OFF** – for use with an ON-OFF switch.
  - **MOMENTARY** – for use with a momentary style of switch.
  - **MIXER** – for use with a fader start compatible DJ mixer

**Numark- The Leader in DJ Technology**



## DISPLAY FEATURES

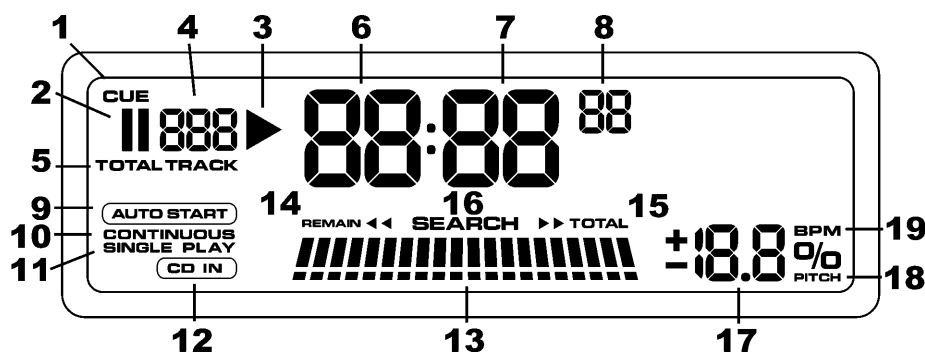

1. **CUE** - Flashing when the unit is setting a cue point. Lit continuously when the unit is paused at a cue point.
  2. **PAUSE (II)**- Active when the unit is paused.
  3. **PLAY (>)**- Active while the unit is actually playing a CD.
  4. **TRACK** - Shows the track that the unit is playing.
  5. **TOTAL** – indicates when total CD remaining tracks are displayed.
  6. **MINUTES** - Shows the minutes elapsed or remaining depending on mode setting.
  7. **SECONDS** - Shows the seconds elapsed or remaining depending on mode setting.
  8. **FRAMES** - The CD Player breaks down a second into 75 frames for accurate cueing. This shows the frames elapsed or remaining depending on mode setting.
  9. **AUTOSTART** – will light when the unit is set to relay from CD unit to CD unit.
  10. **CONTINUOUS PLAY** – Shows when the unit is set to play back the entire CD without stopping between tracks.
  11. **SINGLE PLAY**- Shows when the unit is set to play just one track at a time.
  12. **CD IN** – indicates a standard CD is in the unit.
  13. **TIME BAR** - Shows either track elapsed time, remaining track time, or remaining total time depending on the setting of the "time" button.
- TIME MODE -**
14. (Remain) indicates when track remain time is displayed.
  15. (Total) indicates when total CD remain time is displayed
- note: if both indications are not lit, the unit will be showing "elapsed" time*
16. **SEARCH** – indicates when the unit is searching through the music
  17. **Numeric display** - indicating either current pitch or BPM
  18. **PITCH** - is lit when pitch is being displayed
  19. **BPM** – is lit when BPM is being displayed

## DESCRIPTION OF THE PLAY/PAUSE AND CUE OPERATIONS

### PLAY and CUE

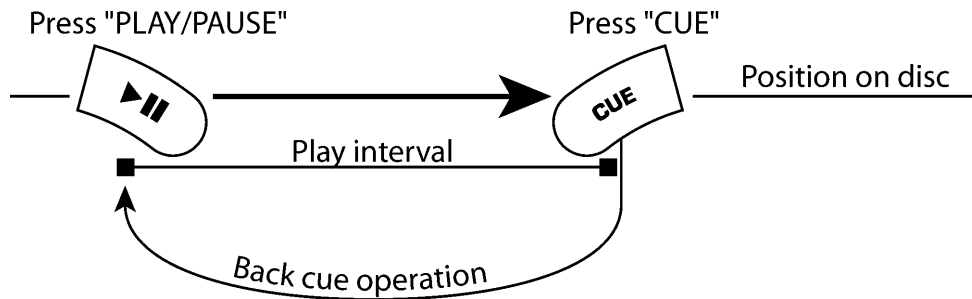

Pressing the "PLAY/PAUSE" button starts the disc. Pressing the "CUE" button will reset the disc to the last place where the disc was started. This is called the cue point. By alternately pressing the "PLAY/PAUSE" button and the "CUE" button, the disc may be returned and played from the cue point any number of times. This function is called back cue.

### PLAY, PAUSE and CUE

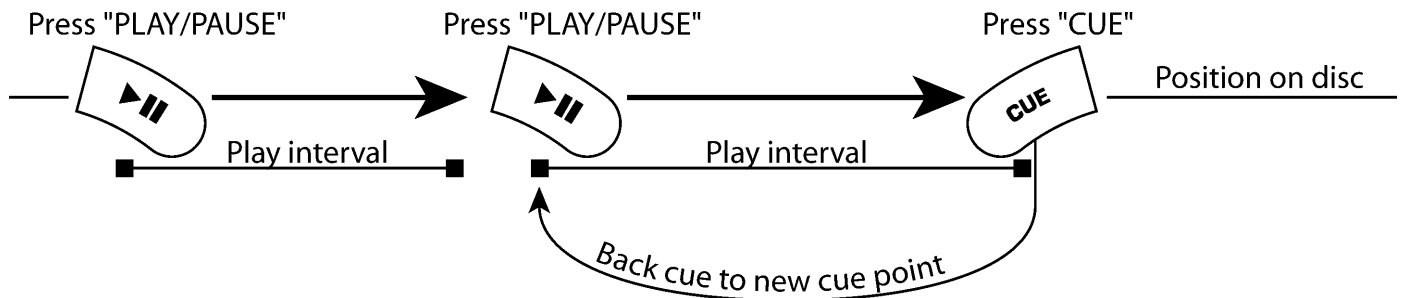

When Play is paused and then started again, the return position for the back cue will be updated as the new cue point

### EDITING CUE POINT

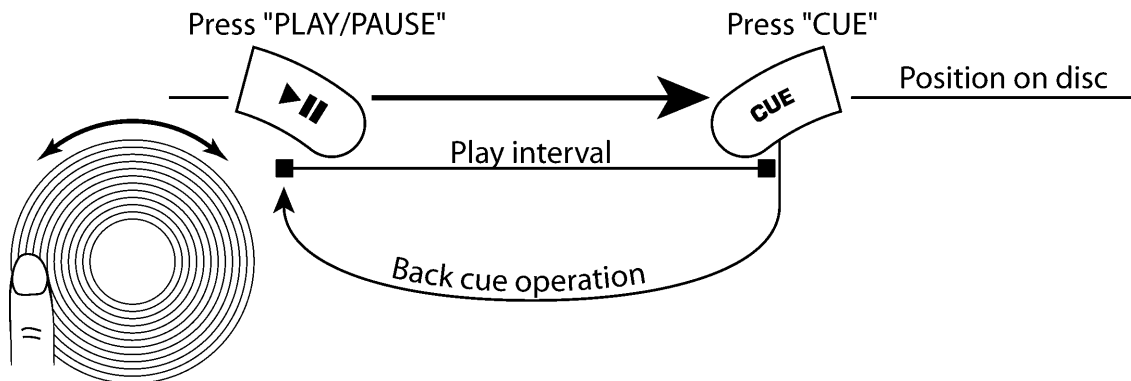

When the jog wheel is turned while a cue point is set, a new cue point can be located. The CD player will repeatedly play small parts of the CD as you move it to the desired position. By pressing "PLAY/PAUSE" then "CUE" you can confirm that this new cue point is desirable.

**Numark - The Leader in DJ Technology**

## RELAY PLAY

This mode will be operational only when 2 units are connected via the supplied relay cable.

1. Insert CDs into both of the units.
2. Press the "RELAY" button on both units to activate.
3. We recommend putting both sides in SINGLE play mode while learning this function.
4. Press play on the first unit. When that unit has finished play it will send a signal to the second unit to start play. You will see the second unit start play and the first unit pause and cue to the beginning of the next track. When unit 2 has completed play unit 1 will start.



*Note: The play signal is sent at the end of specified play. If the unit is in SINGLE mode the play signal will start the second unit at the end of the track. If the unit is in CONTINUOUS mode the play signal will be sent at the end of the full CD. Two CDs will play continuously, alternating from unit to unit.*

## FADER START

Fader Start is achievable by attaching your CD player to a similarly equipped DJ mixer and setting the rear panel selection switch to "mixer" mode.

1. Connect cables between the CD player and your DJ mixer.
2. Press the button or switch on your mixer into fader start mode to activate the fader start capability.
3. Typically if you move the crossfader toward the active channel, the attached CD player will activate. When it is moved away the unit will cue or pause depending upon CD player setting.

To select start/stop mode hold the time button for 3 seconds.

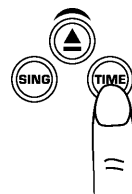

If the display shows  then the CD will pause when the crossfader is moved away.

If the display shows  then the CD will CUE when the crossfader is moved away.

## REMOTE SWITCH START

Remote switch start is achievable by attaching your CD player to a switch like a foot switch found in most music shops. Foot switch connector plugs are often 1/4" and an adapter to 1/8" will be needed for connection.

1. Connect the remote switch to your CD player.
2. Select the type of foot switch you will use. There are two types of footswitches that will work with this connector. The first is a typical, ON-OFF pushbutton switch and are generally used for switching channels on guitar amps. The second switch is a momentary footswitch and is usually used for keyboard sustain pedals. If you are unsure of the style of switch you have, try each position until it works as desired.
3. Typically if you press the switch once, the attached CD player will activate. When it is pressed again the unit will cue or pause depending upon CD player setting.

*Note: You can also use a momentary switch in the ON-OFF switch position. In this case the unit will only play while the switch is depressed. When the button is release it will either cue or pause depending upon mode.*

**MATCHING THE BEATS PER MINUTE (BPM)**

Match the tempo by monitoring the music of both PLAYER 1 and PLAYER 2 by ear and adjusting the pitch. When the tempo of the music of the selected CD player is slow compared to the tempo of the other player, move the slider to the “+” side and match the tempo. When faster, move the pitch slider to the “-” side. The following description is for the case of matching the pitch of PLAYER 2 to the pitch of the music being played on PLAYER 1.

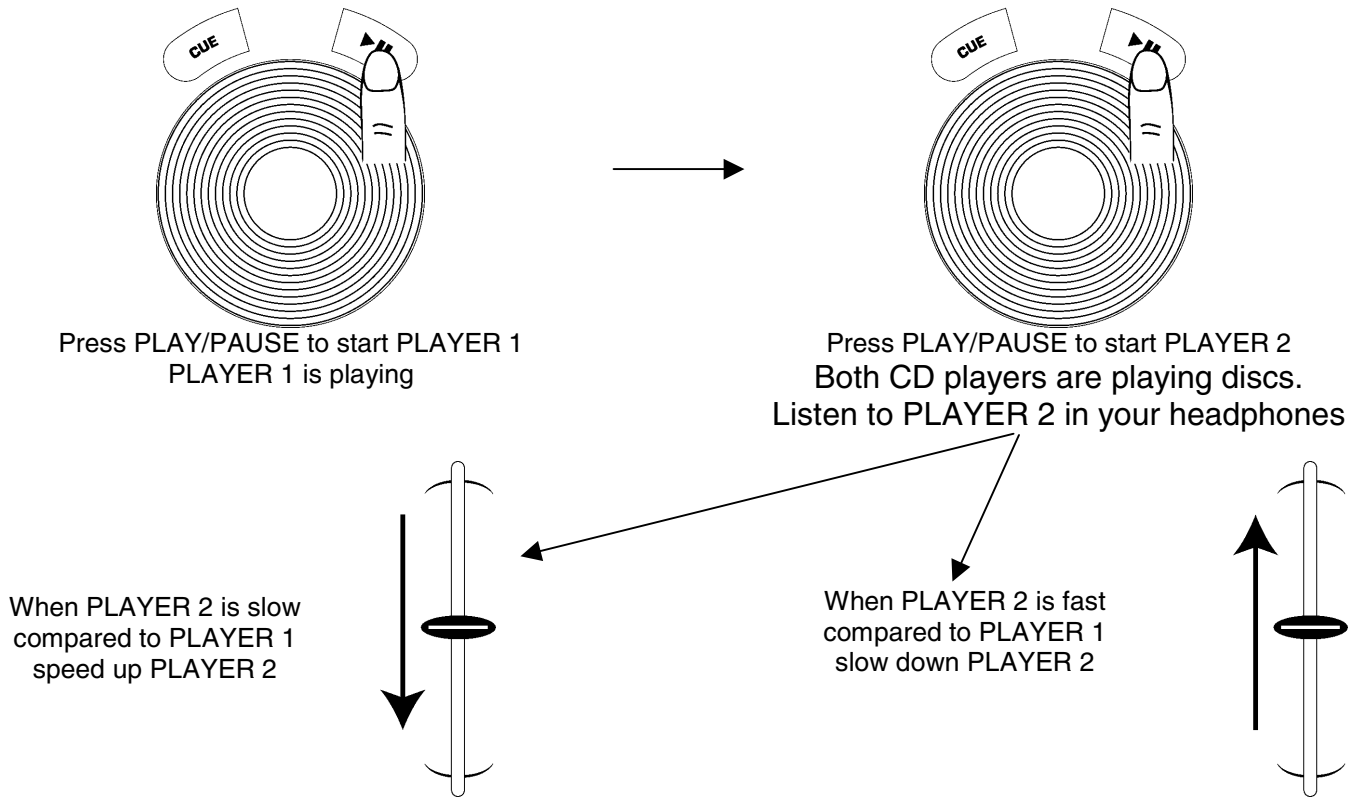

**MATCHING BEATS USING PITCH BEND**

If you find the BPM's (Beats Per Minute or Tempos) are the same, however, the drum beats are not matched you will need to temporarily change the pitch. This description is for the case of matching the beat of PLAYER 2 to the beat of the music being played on PLAYER 1. (This procedure can be done on either PLAYER).

**After matching the BPM's adjust the pitch temporarily as follows:**

When PLAYER 2 is behind rotate the jog wheel clockwise or press “+” to bend pitch faster

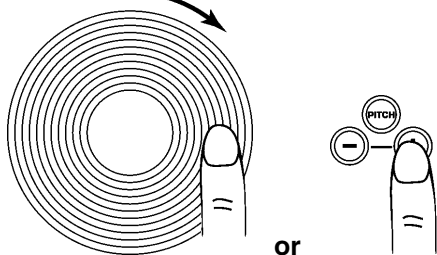

When PLAYER 2 is ahead rotate the jog wheel counter clockwise or press “-“ to bend pitch slower.

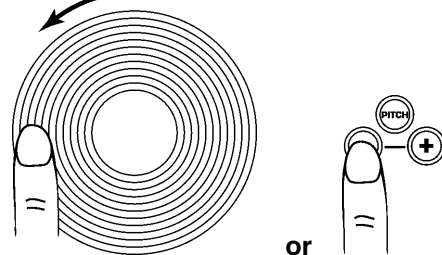

The pitch changes automatically while the jog wheel is rotated. The faster you rotate the wheel the more you change. Releasing the wheel results in a return to the original pitch. (So the BPM's are once again the same)

## EXAMPLE OF MIXING USING TWO CD PLAYERS

While playing a disc on PLAYER 1 load a disc into PLAYER 2 and select your next track, match its pitch to the track playing on PLAYER1 and when you are ready use the crossfader on your mixer to fade from PLAYER 1 to PLAYER 2.

Load a disc in PLAYER 1 and select the track and press PLAY.

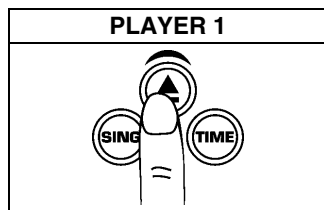

Load a disc and press the OPEN/CLOSE button.

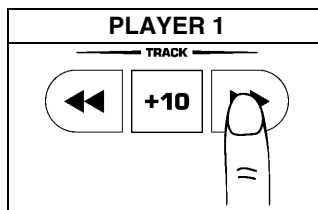

Select the track to be played.

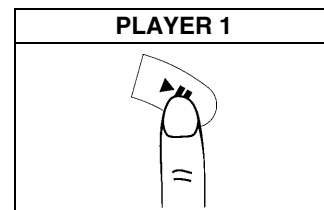

Press the PLAY button

Load a disc in PLAYER 2 and select the track then play.

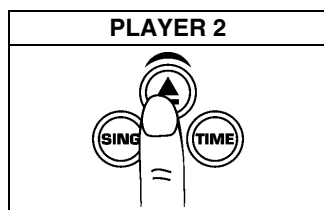

Load a disc and press the OPEN/CLOSE button.

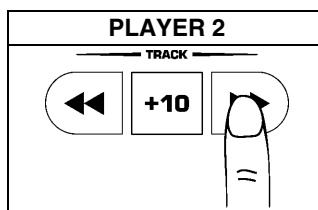

Select the track to be played.

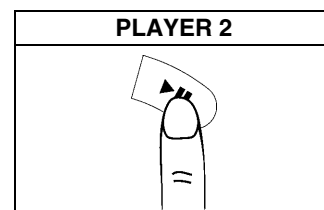

Press the PLAY button

Set and edit a start cue point on PLAYER 2

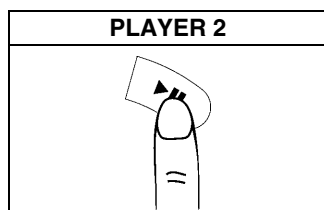

Press the Pause button of PLAYER 2.

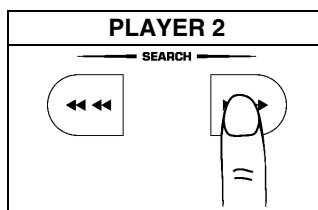

Rapidly search for a cue point using the buttons

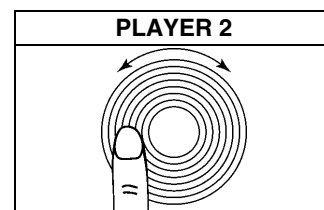

Slowly set the right point using the jog wheel

Check you new cue point

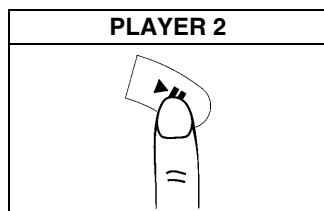

Listen with the monitor and press the play button.

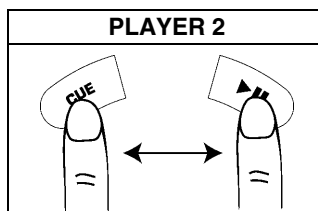

Press the cue button then play to be sure of the set cue point.

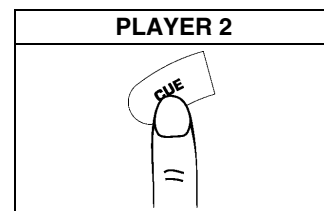

Set the player to the Cue point by pressing Cue

Do a MIX!

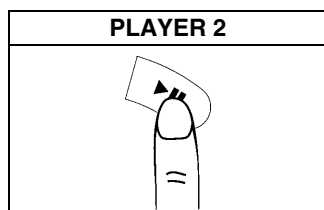

With a matching downbeat from Player 1 press the play button.

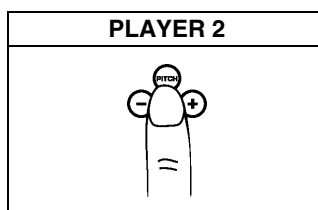

If you are beat mixing turn on your Pitch adjust and follow the directions for beat matching.

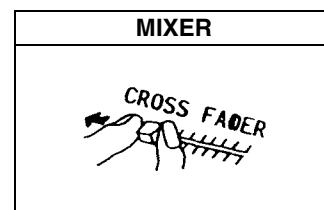

When you are happy with you mix adjust you mixer accordingly.

**Numark**- The Leader in DJ Technology

**BEFORE SWITCHING OFF THE POWER:**

When you have finished using the CD player, be sure that the disc tray is closed with the "OPEN/CLOSE" button before switching off the power.

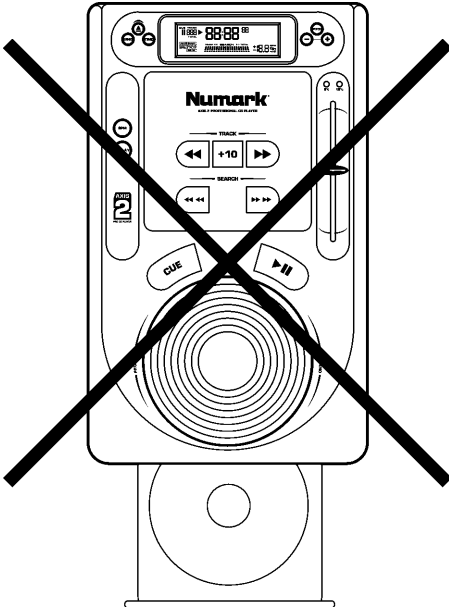

**DO NOT** switch off the power when the disc holder is open.

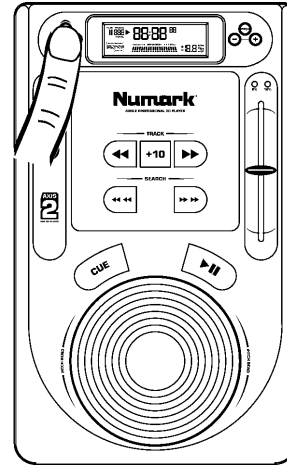

Switch off the power **after** the disc holder has been closed with the "OPEN/CLOSE" button

**TROUBLESHOOTING:**

Symptom	Possible Cause	Corrective Action
The power fails to switch on when the POWER switch is set to on	Poor power plug connection at the AC outlet or IEC Power cord loose from rear of unit	Insert the power plug firmly into the AC outlet and make sure connection is good in unit rear
Disc play does not start	The disc is loaded upside down The disc is too dirty	Reload the disc with the label side up Clean the disc
No sound	Improper output cable connections Improper amplifier operation	Connect the output cables correctly Check amplifier setup
Sound skips	The CD player is subject to vibrations or physical shock The disc is too dirty	Change the installation location Clean the disc
Hum	Loose cable connections	Firmly connect all audio plugs

## **SPECIFICATIONS**

### **TECHNICAL**

Disc Type	Standard Compact discs (12 cm & 8 cm)
Time Display	Track Elapsed, Track Remain, or Total remain
Quantization	1 bit linear/Channel, 3 Beam Laser
Oversampling rate	8 Times
Sampling Frequency	44.1 kHz
Frequency response	20 Hz to 20 kHz
T.H.D. + NOISE	Less Than 0.005%
S/N ratio (IHF-A)	> 96 dB
Dynamic range	> 94 dB
Output level	1.9 Volts R.M.S.
Start Time	within 0.03 seconds
Pitch control range	+/- 8 and 16% slider
Pitch bend	+/-16% rotary and buttons
Digital Output	type 2, form 1, S/PDIF (Sony/Phillips Digital Interface Format)

### **GENERAL**

Dimensions:	9.75" x 8.5" x 3.25" (247 x 216 x 82.5mm)
Weight:	5 lbs (2.3 kg)
Power Supply:	115/230V AC, 50/60Hz
Power Consumption:	15W

\* Specifications are subject to change due to ongoing improvements

# **Numark<sup>®</sup>**

## ***Professional Disc Jockey Products***

### **LIMITED PRODUCT WARRANTY**

1. What is covered and for how long? NUMARK INDUSTRIES LCC ("NUMARK") warrants to the original purchaser that NUMARK'S DJ Mixers, Amplifiers, CD players, turntables, preamplifiers, beatkeepers, equalizers, microphones, headphones, and all other accessories are free from defects in material and workmanship under normal use and service for the period commencing upon the date of purchase from an authorized NUMARK dealer and continuing for the following period of time after that date for **(1) Year**.
2. What is not covered? This Limited Warranty is conditioned upon proper use of the product by the purchaser. This Limited Warranty does not cover: (a) defects or damage resulting from accident, misuse, abuse, neglect, unusual physical or electrical stress, modification of any part of the product, or cosmetic damage; (b) equipment that has the serial number removed or made illegible; (c) all plastic surfaces and other externally exposed parts that are scratched or damaged due to normal use; (d) defects or damage from improper testing, operation, maintenance, installation, adjustment, or service of the mixers; (e) crossfaders.
3. What are NUMARK'S obligations? During the applicable warranty period, NUMARK will repair or replace, at NUMARK'S sole discretion, without charge to the purchaser, any defective component part of the mixer. To obtain service under this Limited Warranty, purchaser must first contact NUMARK and obtain a return authorization number ("RA#"). Purchaser must then return the mixer to NUMARK in an adequate container for shipping, accompanied by purchaser's sales receipt or comparable proof of sale showing the date of purchase, the serial number of the product, and the seller's name and address. To obtain an RA# and assistance on where to return the mixer, contact NUMARK customer service at 401-295 9000. Upon receipt, NUMARK will repair or replace the defective products. NUMARK may, at NUMARK'S sole discretion, use rebuilt, reconditioned, or new parts or components when repairing any product or replace a product with a rebuilt, reconditioned or new product. Repaired mixers will be warranted for a period equal to the remainder of the original Limited Warranty on the original mixer or for (90) days, whichever is longer. All replaced parts, components, boards and equipment become the property of NUMARK. If NUMARK determines that any mixer is not covered by this Limited Warranty, purchaser must pay all parts, shipping, and labor charges for the repair or return of such mixer.
4. What are the limits on NUMARK'S liabilities? THE WARRANTIES GIVEN IN THIS LIMITED WARRANTY, TOGETHER WITH ANY IMPLIED WARRANTIES COVERING NUMARK MIXERS, INCLUDING WITHOUT LIMITATION ANY WARRANTIES OF MERCHANTABILITY OR FITNESS FOR A PARTICULAR PURPOSE, ARE LIMITED TO THE DURATION OF THIS LIMITED WARRANTY. EXCEPT TO THE EXTENT PROHIBITED BY APPLICABLE LAW, NUMARK SHALL NOT BE LIABLE FOR ANY SPECIAL, INCIDENTAL, CONSEQUENTIAL, INDIRECT OR SIMILAR DAMAGES, LOSS OF PROFITS, DAMAGES TO PURCHASER'S PROPERTY, OR INJURY TO PURCHASER OR OTHERS ARISING OUT OF THE USE, MISUSE OR INABILITY TO USE ANY NUMARK MIXER, BREACH OF WARRANTY, OR NEGLIGENCE, INCLUDING BUT NOT LIMITED TO NUMARK'S OWN NEGLIGENCE, EVEN IF NUMARK OR ITS AGENT HAS BEEN ADVISED OF SUCH DAMAGES, OR FOR ANY CLAIM BROUGHT AGAINST PURCHASER BY ANY OTHER PARTY. THIS LIMITED WARRANTY IS THE COMPLETE WARRANTY FOR NUMARK'S MIXERS, AND IS GIVEN IN LIEU OF ALL OTHER EXPRESS WARRANTIES. THIS LIMITED WARRANTY SHALL NOT EXTEND TO ANYONE OTHER THAN THE ORIGINAL PURCHASER OF THIS PRODUCT AND STATES PURCHASER'S EXCLUSIVE REMEDY. IF ANY PORTION OF THIS LIMITED WARRANTY IS ILLEGAL OR UNENFORCEABLE BY REASON OF ANY LAW, SUCH PARTIAL ILLEGALITY OR UNENFORCEABILITY SHALL NOT AFFECT THE ENFORCEABILITY OF THE REMAINDER OF THIS LIMITED WARRANTY WHICH PURCHASER ACKNOWLEDGES IS AND WILL ALWAYS BE CONSTRUED TO BE LIMITED BY ITS TERMS OR AS LIMITED AS THE LAW PERMITS. This Limited Warranty allocates risk of product failure between purchaser and NUMARK, and NUMARK'S product pricing reflects this allocation of risk and the limitations of liability contained in this Limited Warranty. The agents, employees, distributors, and dealers of NUMARK are not authorized to make modifications to this Limited Warranty, or make additional warranties binding on NUMARK. Accordingly, additional statements such as dealer advertising or presentation, whether oral or written, do not constitute warranties by NUMARK and should not be relied upon.
5. How does state law apply to this warranty? SOME STATES DO NOT ALLOW THE EXCLUSION OR LIMITATIONS OF INCIDENTAL OR CONSEQUENTIAL DAMAGES OR HOW LONG AN IMPLIED WARRANTY LASTS, SO THE ABOVE LIMITATIONS OR EXCLUSIONS MAY NOT APPLY TO PURCHASER.
6. This Limited Warranty gives you specific legal rights. You may also have other rights, which vary from one jurisdiction to another.

### **RETURN INFORMATION**

- A Return Authorization number must be obtained from Numark through the address or phone numbers below.
- A copy of the original sales receipt must also be included for the equipment to be repaired under warranty.
- The faulty equipment must be packed in its original packaging.
- One additional outer layer of packaging must be included to ensure product safety. Failure to do so may inadequately protect the equipment in transit and, therefore, jeopardize the customer's warranty.
- Numark will not accept COD shipments and no call tags will be issued for merchandise return.
- Numark will not return repaired merchandise to customers by priority service, unless by written request at the customer's cost. Requests must be submitted in writing with merchandise returned.
- The defective Numark equipment should be sent, FREIGHT PREPAID with Return Authorization number clearly printed on the outer packaging and original sales receipt enclosed to:

**Numark** INDUSTRIES  
Attention: Service Department  
11 Helmsman Avenue  
North Kingstown, RI 02852 USA

Phone: +1 (401) 295-9000  
Fax: +1 (401) 295-5200  
Web: [www.numark.com](http://www.numark.com)



## Free Manuals Download Website

<http://myh66.com>

<http://usermanuals.us>

<http://www.somanuals.com>

<http://www.4manuals.cc>

<http://www.manual-lib.com>

<http://www.404manual.com>

<http://www.luxmanual.com>

<http://aubethermostatmanual.com>

Golf course search by state

<http://golfingnear.com>

Email search by domain

<http://emailbydomain.com>

Auto manuals search

<http://auto.somanuals.com>

TV manuals search

<http://tv.somanuals.com>