

Numark®

Professional Disc Jockey Products

DM1090X PROFESSIONAL DJ MIXER

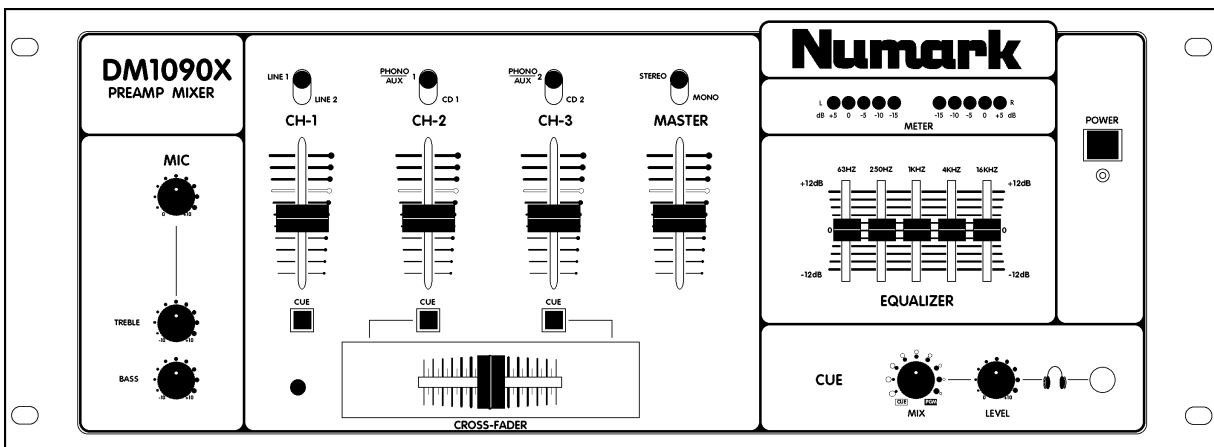

USER'S MANUAL

Safety Information



CAUTION
RISK OF ELECTRIC SHOCK
DO NOT OPEN



CAUTION: TO REDUCE THE RISK OF ELECTRIC SHOCK DO NOT REMOVE ANY COVER. NO USER-SERVICEABLE PARTS INSIDE. REFER SERVICING TO QUALIFIED SERVICE PERSONNEL ONLY.

The lightning flash with arrowhead symbol within the equilateral triangle is intended to alert the user to the presence of un-insulated "dangerous voltage" within the product's enclosure that may be of sufficient magnitude to constitute a risk of electric shock.

The exclamation point within the equilateral triangle is intended to alert the user to the presence of important operating and maintenance (servicing) instructions in the literature accompanying this appliance.

CAUTION

FOR USA & CANADIAN MODELS ONLY
TO PREVENT ELECTRIC SHOCK DO NOT USE THIS (POLARIZED) PLUG WITH AN EXTENSION CORD, RECEPTACLE OR OTHER OUTLET UNLESS THE BLADES CAN BE FULLY INSERTED TO PREVENT BLADE EXPOSURE.

SAFETY INSTRUCTIONS

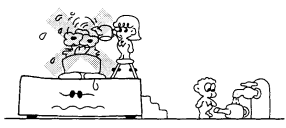
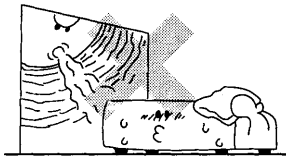
- Read Instructions** - All the safety and operating instructions should be read before this product is connected and used.
- Retain Instructions** - The safety and operating instructions should be kept for future reference.
- Heed Warnings** - All warnings on this product and in these operating instructions should be followed.
- Follow Instructions** - All operating and other instructions should be followed.
- Water and Moisture** - This product should be kept away from direct contact with liquids. 
- Heat** - Avoid placing this product too close to any high heat sources such as radiators.
- Ventilation** - The appliance should be situated so that its location or position does not interfere with its proper ventilation. For example, the appliance should not be situated on a bed, sofa, rug, or similar surface that may block the ventilation opening; or, placed in a built-installation, such as bookcase or cabinet that may impede the flow of air through the ventilation openings. 

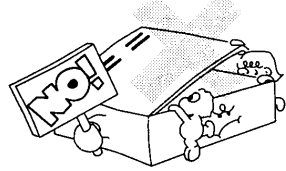
- Power Sources** - This product should be connected to a power supply only of the type described in these operating instructions, or as marked on the unit.
- Power Cord Protection** - Power supply cords should be routed so that they are not likely to be walked upon or pinched by items placed on or against them. When removing the cord from a power outlet be sure to remove it by holding the plug attachment and not by pulling on the cord. 
- Object and Liquid Entry** - Take care that objects do not fall into and that liquids are not spilled into the inside of the mixer.
- Cleaning** - The appliance should be cleaned only as recommended by the manufacturer.
- Non-use Periods** - The power cord of the appliance should be unplugged from the outlet when left unused for long periods of time.
- Damage Requiring Service** - Only qualified personnel should service this product. If you have any questions about service please contact Numark at the number(s) shown on the back cover of this manual. 
- Grounding or Polarization** - Precautions should be taken so that the grounding or polarization means built into the CD player is not defeated.
- Internal/External Voltage Selectors** - Internal or external voltage selector switches, if any, should only be reset and re-equipped with a proper plug for alternative voltage by a qualified service technician. Do not attempt to alter this yourself.

WARNING: To reduce the risk of fire or electrical shock, do not expose this appliance to rain or moisture. Electrical equipment should NEVER be kept or stored in damp environments.

SERVICE INSTRUCTIONS

- Disconnect power cord before servicing
- Replace critical components  only with factory parts or recommended equivalents
- For AC line powered units - Before returning repaired unit to user, use an ohmmeter to measure from both AC plug blades to all exposed metallic parts. The resistance should be no more than 100,000ohms.

Numark - The Leader in DJ Technology

VERY IMPORTANT**Please read this entire manual before connecting this unit to your system**

For optimum performance:

- The crossfader is a user replaceable item and subject to wear. Excessive force can wear out the fader quickly. This is not a warranted item.
- Never use spray cleaners on the slide controls. Residues cause excessive dirt build-up and this will void your warranty. In normal use slide controls can last for many years. If they malfunction (usually because of a dirty or dusty environment) consult a professional technician.
- Always make sure that AC power is OFF while making any connections.
- Use appropriate cables throughout your system. Do not use excessively long cables (i.e. over 50ft/14m) Be sure plugs and jacks are tightly mated. Loose connections can cause hum, noise or intermittents that could easily damage your speakers. Make the input and output connections with readily available low-capacitance stereo cables. Quality cable makes a big difference in audio fidelity and punch. See your Numark dealer or an electronics or audio specialist store if you are not sure which cables to get.
- Never attempt to make any adjustments or repairs other than those described in this manual. Take the unit to your dealer or to an authorized Numark Service Center.
- ALWAYS remember: "TURN AMPS ON LAST AND OFF FIRST". Begin with master faders or volume controls on minimum and the amplifier gain/input control(s) down. Wait 8 to 10 seconds before turning up the volume. This prevents transients which may cause severe speaker damage.
- Use restraint when operating controls. Try to move them slowly. Rapid adjustments could damage speakers due to amplifier clipping.
- Avoid amplifier "clipping" at all costs: this occurs when the red LEDs (usually on the front panel of most professional power amplifiers) start flashing. "Clipping" is when the power amplifier is distorting and working beyond it's limits. Amplifier distortion is THE major cause of speaker failure.
- To prevent fire or shock hazard, do not expose the unit to rain or moisture. Never place cans of beer, soda, glasses of water or anything wet on top of the unit!

Product Registration

Please record the serial number of your unit as shown on the back of the chassis as well as the name of the dealer from whom you purchased the unit. Retain this information and your original purchase receipt for your records. Please return the enclosed warranty card to register your unit with us.

MODEL: _____
 SERIAL NUMBER: _____

PURCHASED FROM: _____
 DATE OF PURCHASE: _____

Numark - The Leader in DJ Technology

Numark® DM1090X

PROFESSIONAL DJ MIXER

CONGRATULATIONS!

You have purchased the **DM1090X** Stereo Mixer by **Numark**. This mixer has been designed to provide dependable control over your input and output sources. The **DM1090X** brings to you the finest quality of DJ equipment at a reasonable price. The **DM1090X** features all new circuitry and the latest in manufacturing and design technology to give you greater quality and better reliability than ever before.

Thank you for buying Numark DJ products!

FEATURES...

- 6 line, 2 phono, 1 mic input
- 5-band Equalizer
- Master outputs with Stereo/Mono control
- Cues on each channel
- Master output meter
- Bass and treble control for Mic input
- Tape Out for direct recording

.....

TABLE OF CONTENTS

| | |
|-----------------------------|---|
| Safety Measures | 2 |
| Important Information | 3 |
| Registration | 3 |
| Introduction | 4 |
| Quick Setup Diagram | 5 |
| Specifications | 5 |
| Description of the Features | 6 |
| Warranty | 8 |

Numark - The Leader in DJ Technology

QUICK SETUP DIAGRAM

Study this setup diagram. Make sure all faders are at "zero" and all devices are off. First, connect all stereo input sources. Next, connect your microphone(s) and monitor headphones. Finally, connect the stereo outputs to the power amplifier(s) and/or audio sources. Plug your mixer into AC power. Now you are ready to switch everything on. Always switch on your audio input sources such as turntables or CD players first, then your mixer, and finally any amplifiers. When turning off, always reverse this operation by turning off amplifiers, then your mixer, and then input devices.

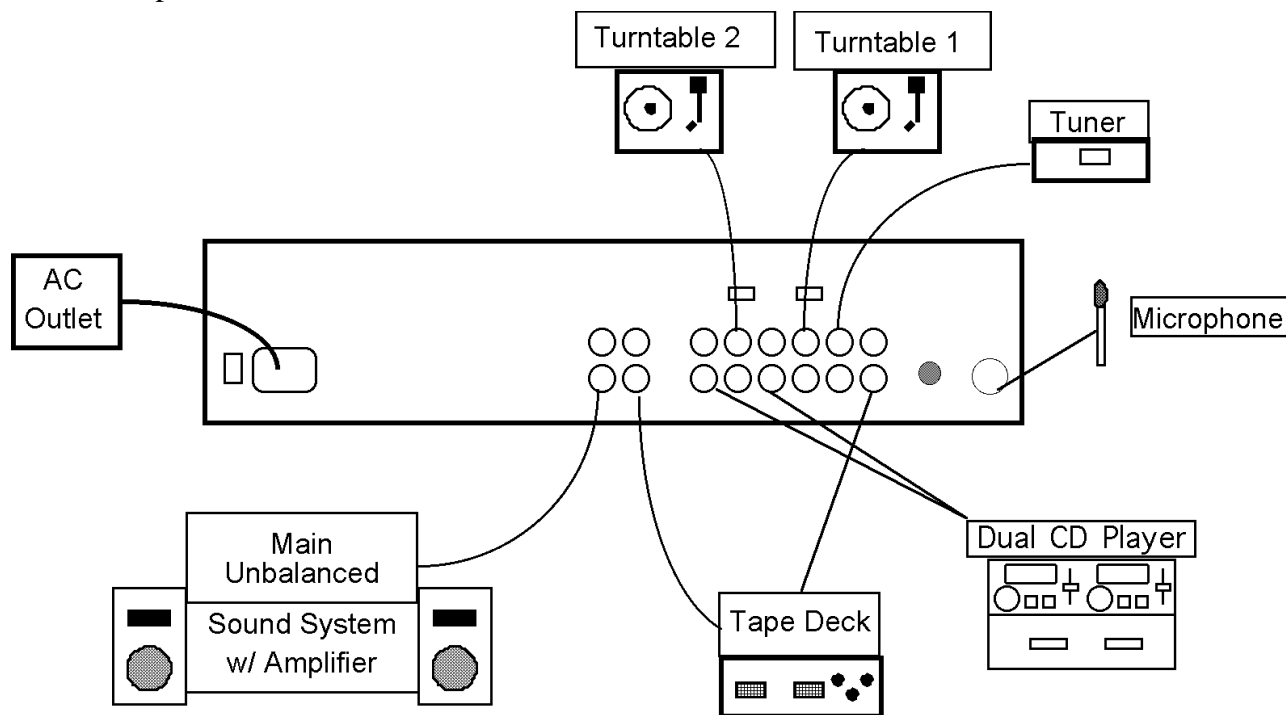

SPECIFICATIONS

INPUTS:

Line: 10k input impedance
90mV rms sensitivity (for 1.22V output)
Mic: 10k input impedance unbalanced
2 mV rms sensitivity (for 1.22V output)
78mV rms max input
Phono: 47k input impedance
1.8mV rms sensitivity @ 1 KHz
(for 1.22V output)

OUTPUTS:

Line: 9V rms max
Headphone Amp: 0.5 watt into 47

Distortion less than 0.01%

SIGNAL TO NOISE RATIOS* (vs. maximum output):

Line: Better than 96 dB
Mic: Better than 78 dB
Phono: Better than 87 dB

*JIS - weighted

FREQUENCY RESPONSE:

Line: 20 Hz- 22k Hz ± 0.5 dB
Line: 20 Hz- 20k Hz ± 0.5 dB
Phono: ± 1 dB except for controlled attenuation of -3 dB
@ 20 Hz to reduce rumble and feedback

EQUALIZER:

± 12 dB @ 63.250.1K.5K.17KHz

POWER CONSUMPTION:

10 Watt typical
15 watt with full headphone output

DIMENSIONS:

480mm(W) x 175mm(H) x 95mm(D)
19" (W) x 7" (H) x 4 (D)

WEIGHT: 3.5 kgs, 7.6 lbs

Numark - The Leader in DJ Technology

MIXER FEATURES

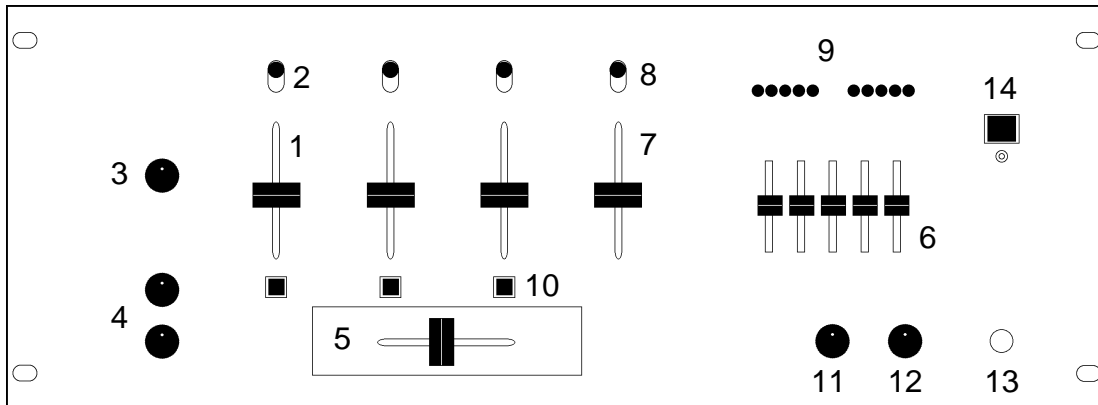

We have divided this section into various functional blocks: Inputs, Microphone, Crossfader, Equalizer, Outputs, and Headphone Cueing. It is important to learn how each of these work.

INPUTS

1. **Input faders** - control individual source levels in the mix.
2. **Input Toggle Switches** - select which source will be live to that channel based on what you have connected to the rear panel input section.

MICROPHONE

3. **Mic Gain** - controls the mic volume for the 1/4" connector on the rear of the mixer.
4. **Treble and Bass** - for fine-tuning the tone of your voice on both mics through the sound system. The controls are detented for setting tone "flat". For best results, use a dynamic cardioid microphone.

CROSSFADER

5. **Replaceable Crossfader** - achieves clean segues between channels 2 and 3.



"Hard left" selects Channel 2 and "Hard right" selects Channel 3. With the crossfader centered, both channels are live. Use the crossfader for fast and seamless segues from one selected channel to the other.

Note: The crossfader is user replaceable in case of failure. Simply unscrew the two large screws that hold it in place, lift it out and disconnect its cable. Re-attach the new crossfader and screw the mounting plate back onto the unit - you're back in business!

EQUALIZER

6. **5-Band Stereo Graphic Equalizer (EQ)** - compensates for differences in source material sound quality. In ultra-compact mobile systems this EQ can be used to tailor the sound to the acoustical requirements of the room. Center frequencies are 63Hz, 250Hz, 1kHz, 4kHz and 16kHz. Faders have a center detent for an accurate "flat" response.

This is a typical "house" EQ curve. Notice how the knobs above "0" balance out the knobs below. Start with this setting if you've never used a graphic EQ before.

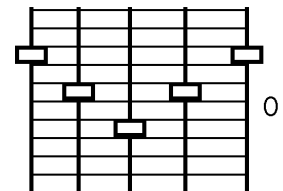

This is an example of a poor EQ curve because it cuts the output volume down by 6-12dB. You have to compensate by running the **Master** output higher.

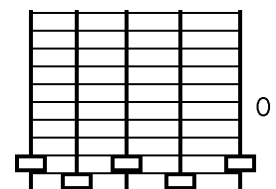

Below is the worst sort of curve to use because you are using EQ to *add volume*. With exaggerated boost, you can easily run your power amplifiers into "clipping" and damage your speakers.

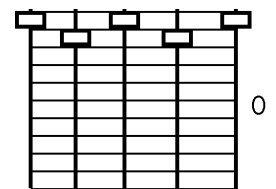

GENERAL EQ HINTS

- Boost the 63Hz band for deep bass tones and solid kick drum sound. Use sparingly because this dramatically increases demand on power amplifiers and could drive them into "clipping".
- Cut slightly at 250Hz and more at 1kHz for extra clarity.

Note: Cutting is preferable to boosting.

- Boost 16kHz for a little "sizzle".
- As a general rule, less equalization is better!

OUTPUTS

7. **Master Fader** – to control the overall output level.
8. **Stereo/Mono toggle** - adjusts the **Master** output for stereo or mono operation.
9. **Volume Meter**- quickly and accurately tracks dB level of audio sent to it from the master fader. It's OK to "tap the red" as long as the red LEDs aren't constantly lit. Set the equalizer and master fader to avoid overload and distortion. Proper attention to the meter results in the punchiest possible sound without audible distortion.

HEADPHONE CUEING

10. **Channel Cue/Send Assign** - are used to route PFL channel audio to the **Monitor Section**. The channel faders do not control the **Cue** send volume. This audio is also sent to a rear panel output for use with an external sampler or other source such as booth monitor.
11. **Headphone Mix** - controls the mix of PFL and PGM signals to your headphones. When the slider is moved to the left, all you will hear is the cue source. When the slider is all the way right, you will hear what is playing through the master output. By blending, beats can be matched exactly and segues can be smooth when a song is cued.
12. **Headphone Level** – to adjust cue volume.
13. **Headphone Input** – for your 1/4" headphone.
14. **Power Button** – turns unit off and on.

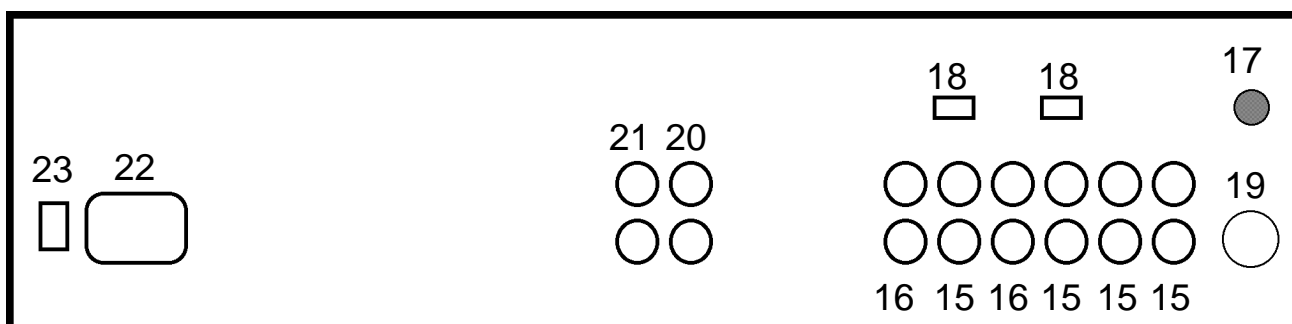
REAR PANEL FEATURES

15. **Line Inputs** – are unbalanced RCA jacks for connecting stereo audio from line level sources such as CD players, HiFi VCRs, cassette and reel-to-reel tape decks, DAT machines, laser discs, tuners, even synthesizers or other mixing consoles.
***NOTE:** Plug mono audio sources into both Left and Right inputs using a "Y" cable connector.*
16. **Phono Inputs** – for attaching your turntables. When these connectors are used, your signal is fed directly to the high-quality RIAA phono pre-amplifiers. Use this position only for turntables. Line level sources will overload the sensitive phono pre-amps and will cause distortion.
17. **Grounding lug** - for turntable connection. Always use this connection when using turntables. (your turntable cable should have a grounding wire)
18. **Line/Phono Input switch** - to allow line level equipment to be plugged into your phono inputs giving you a total of 8 line input options.
19. **Mic Input** – for your 1/4" Microphone plug.
20. **Record Outputs** – are unbalanced RCA jacks used to send the output of the program to any connected recording device.
21. **Stereo Main Outputs** – are unbalanced RCA connectors controlled by the **Master** fader.
22. **IEC Power Connector** – to plug in your power cord.
23. **Voltage Selector** – to set to your country's standard.

Numark®

Professional Disc Jockey Products

LIMITED PRODUCT WARRANTY

What is covered and for how long?

1. NUMARK INDUSTRIES LCC ("NUMARK") warrants to the original purchaser that NUMARK'S DJ mixers and amplifiers are free from defects in material and workmanship under normal use and service for the period commencing upon the date of purchase from an authorized NUMARK dealer and continuing for the following period of time after that date for (2) Years. The warranty is extended to (3) Years with the completion of the warranty card provided that the warranty card is completed and returned within (30) days from the date of purchase. All other NUMARK products are warranted for (1) Year including but not limited to CD players, CD Mix Stations, turntables, preamplifiers, beatkeepers, equalizers, microphones, headphones, and all other accessories.

What is not covered? This Limited Warranty is conditioned upon proper use of the product by the purchaser.

2. This Limited Warranty does not cover: (a) defects or damage resulting from accident, misuse, abuse, neglect, unusual physical or electrical stress, modification of any part of the product, or cosmetic damage; (b) equipment that has the serial number removed or made illegible; (c) all plastic surfaces and other externally exposed parts that are scratched or damaged due to normal use; (d) defects or damage from improper testing, operation, maintenance, installation, adjustment, or service of the mixers; (e) crossfaders.
3. What are NUMARK'S obligations? During the applicable warranty period, NUMARK will repair or replace, at NUMARK'S sole discretion, without charge to the purchaser, any defective component part of the mixer. To obtain service under this Limited Warranty, purchaser must first contact NUMARK and obtain a return authorization number ("RA#"). Purchaser must then return the mixer to NUMARK in an adequate container for shipping, accompanied by purchaser's sales receipt or comparable proof of sale showing the date of purchase, the serial number of the product, and the seller's name and address. To obtain an RA# and assistance on where to return the mixer, contact NUMARK customer service at 401-295 9000. Upon receipt, NUMARK will repair or replace the defective products. NUMARK may, at NUMARK'S sole discretion, use rebuilt, reconditioned, or new parts or components when repairing any product or replace a product with a rebuilt, reconditioned or new product. Repaired mixers will be warranted for a period equal to the remainder of the original Limited Warranty on the original mixer or for (90) days, whichever is longer. All replaced parts, components, boards and equipment become the property of NUMARK. If NUMARK determines that any mixer is not covered by this Limited Warranty, purchaser must pay all parts, shipping, and labor charges for the repair or return of such mixer.
4. What are the limits on NUMARK'S liabilities? THE WARRANTIES GIVEN IN THIS LIMITED WARRANTY, TOGETHER WITH ANY IMPLIED WARRANTIES COVERING NUMARK MIXERS, INCLUDING WITHOUT LIMITATION ANY WARRANTIES OF MERCHANTABILITY OR FITNESS FOR A PARTICULAR PURPOSE, ARE LIMITED TO THE DURATION OF THIS LIMITED WARRANTY. EXCEPT TO THE EXTENT PROHIBITED BY APPLICABLE LAW, NUMARK SHALL NOT BE LIABLE FOR ANY SPECIAL, INCIDENTAL, CONSEQUENTIAL, INDIRECT OR SIMILAR DAMAGES, LOSS OF PROFITS, DAMAGES TO PURCHASER'S PROPERTY, OR INJURY TO PURCHASER OR OTHERS ARISING OUT OF THE USE, MISUSE OR INABILITY TO USE ANY NUMARK MIXER, BREACH OF WARRANTY, OR NEGLIGENCE, INCLUDING BUT NOT LIMITED TO NUMARK'S OWN NEGLIGENCE, EVEN IF NUMARK OR ITS AGENT HAS BEEN ADVISED OF SUCH DAMAGES, OR FOR ANY CLAIM BROUGHT AGAINST PURCHASER BY ANY OTHER PARTY. THIS LIMITED WARRANTY IS THE COMPLETE WARRANTY FOR NUMARK'S MIXERS, AND IS GIVEN IN LIEU OF ALL OTHER EXPRESS WARRANTIES. THIS LIMITED WARRANTY SHALL NOT EXTEND TO ANYONE OTHER THAN THE ORIGINAL PURCHASER OF THIS PRODUCT AND STATES PURCHASER'S EXCLUSIVE REMEDY. IF ANY PORTION OF THIS LIMITED WARRANTY IS ILLEGAL OR UNENFORCEABLE BY REASON OF ANY LAW, SUCH PARTIAL ILLEGALITY OR UNENFORCEABILITY SHALL NOT AFFECT THE ENFORCEABILITY OF THE REMAINDER OF THIS LIMITED WARRANTY WHICH PURCHASER ACKNOWLEDGES IS AND WILL ALWAYS BE CONSTRUED TO BE LIMITED BY ITS TERMS OR AS LIMITED AS THE LAW PERMITS.
5. This Limited Warranty allocates risk of product failure between purchaser and NUMARK, and NUMARK'S product pricing reflects this allocation of risk and the limitations of liability contained in this Limited Warranty. The agents, employees, distributors, and dealers of NUMARK are not authorized to make modifications to this Limited Warranty, or make additional warranties binding on NUMARK. Accordingly, additional statements such as dealer advertising or presentation, whether oral or written, do not constitute warranties by NUMARK and should not be relied upon.
6. How does state law apply to this warranty? SOME STATES DO NOT ALLOW THE EXCLUSION OR LIMITATIONS OF INCIDENTAL OR CONSEQUENTIAL DAMAGES OR HOW LONG AN IMPLIED WARRANTY LASTS, SO THE ABOVE LIMITATIONS OR EXCLUSIONS MAY NOT APPLY TO PURCHASER.
7. This Limited Warranty gives you specific legal rights. You may also have other rights, which vary from one jurisdiction to another.

RETURN INFORMATION

- a) A Return Authorization number must be obtained from Numark through the address or phone numbers below.
- b) A copy of the original sales receipt must also be included for the equipment to be repaired under warranty.
- c) The faulty equipment must be packed in its original packaging.
- d) One additional outer layer of packaging must be included to ensure product safety. Failure to do so may inadequately protect the equipment in transit and, therefore, jeopardize the customer's warranty.
- e) Numark will not accept COD shipments and no call tags will be issued for merchandise return.
- f) Numark will not return repaired merchandise to customers by priority service, unless by written request at the customer's cost. Requests must be submitted in writing with merchandise returned.
- g) The defective Numark equipment should be sent, FREIGHT PREPAID with Return Authorization number clearly printed on the outer packaging and original sales receipt enclosed to:

Numark INDUSTRIES
Attention: Service Department
11 Helmsman Avenue
North Kingstown, RI 02852 USA

Phone: +1 (401) 295-9000
Fax: +1 (401) 295-5200
Web: www.numark.com

Free Manuals Download Website

<http://myh66.com>

<http://usermanuals.us>

<http://www.somanuals.com>

<http://www.4manuals.cc>

<http://www.manual-lib.com>

<http://www.404manual.com>

<http://www.luxmanual.com>

<http://aubethermostatmanual.com>

Golf course search by state

<http://golfingnear.com>

Email search by domain

<http://emailbydomain.com>

Auto manuals search

<http://auto.somanuals.com>

TV manuals search

<http://tv.somanuals.com>