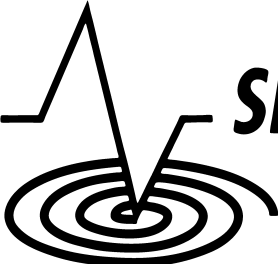
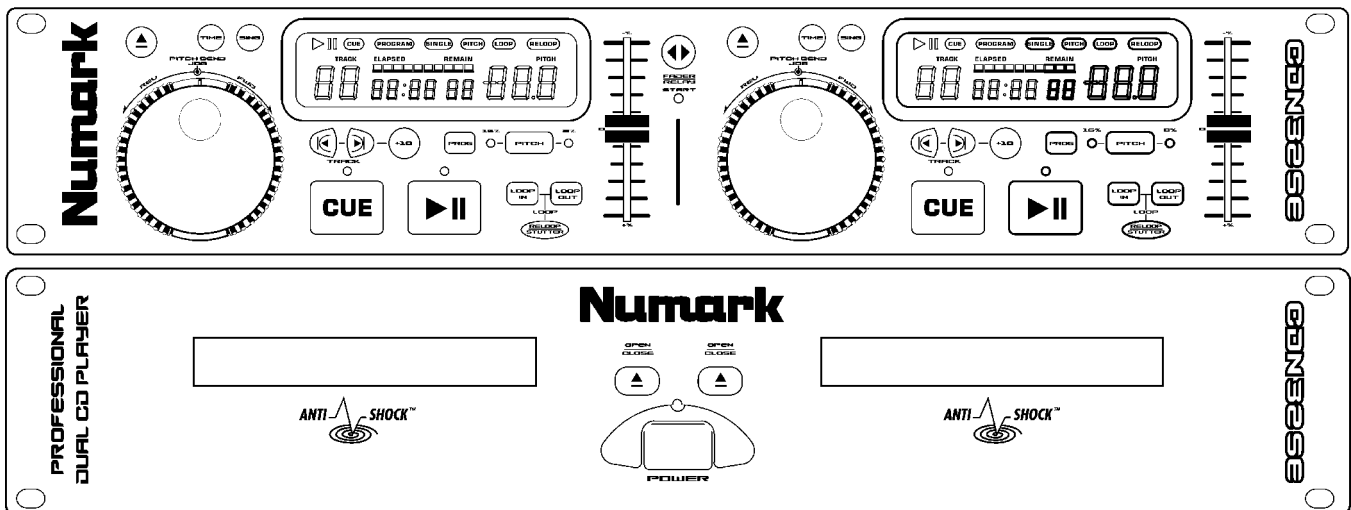

Numark®

Professional Disc Jockey Products

CDN-32SE PROFESSIONAL DUAL CD PLAYER

with
ANTI-SHOCK™

Buffered memory



OPERATING MANUAL

Safety Information and Product Registration



CAUTION
RISK OF ELECTRIC SHOCK
DO NOT OPEN



CAUTION: TO REDUCE THE RISK OF ELECTRIC SHOCK DO NOT REMOVE ANY COVER. NO USER-SERVICEABLE PARTS INSIDE. REFER SERVICING TO QUALIFIED SERVICE PERSONNEL ONLY.

The lightning flash with arrowhead symbol within the equilateral triangle is intended to alert the user to the presence of un-insulated "dangerous voltage" within the product's enclosure that may be of sufficient magnitude to constitute a risk of electric shock.

The exclamation point within the equilateral triangle is intended to alert the user to the presence of important operating and maintenance (servicing) instructions in the literature accompanying this appliance.

CAUTION
FOR USA & CANADIAN MODELS ONLY
TO PREVENT ELECTRIC SHOCK DO NOT USE THIS (POLARIZED) PLUG WITH AN EXTENSION CORD, RECEPTACLE OR OTHER OUTLET UNLESS THE BLADES CAN BE FULLY INSERTED TO PREVENT BLADE EXPOSURE.

SAFETY INSTRUCTIONS

- 1) Read Instructions - All the safety and operating instructions should be read before this product is connected and used.
- 2) Retain Instructions - The safety and operating instructions should be kept for future reference.
- 3) Heed Warnings - All warnings on this product and in these operating instructions should be followed.
- 4) Follow Instructions - All operating and other instructions should be followed.
- 5) Water and Moisture - This product should be kept away from direct contact with liquids.
- 6) Heat - Avoid placing this product to close to any high heat sources such as radiators.
- 7) Ventilation - The appliance should be situated so that it's location or position does not interfere with it's proper ventilation. For example, the appliance should not be situated on a bed,

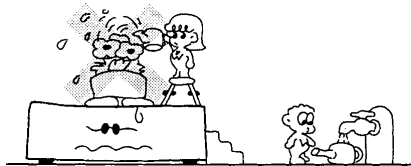

sofa, rug, or similar surface that may block the ventilation opening; or, placed in a built-installation, such as bookcase or cabinet that may impede the flow of air through the ventilation openings.

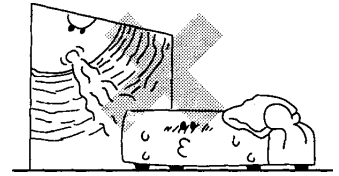

- 8) Power Sources - This product should be connected to a power supply only of the type described in these operating instructions, or as marked on the unit.
- 9) Power Cord Protection - Power supply cords should be routed so that they are not likely to be walked upon or pinched by items placed on or against them. When removing the cord from a power outlet be sure to remove it by holding the plug attachment and not by pulling on the cord.
- 10) Object and Liquid Entry - Take care that objects do not fall into and that liquids are not spilled into the inside of the mixer.
- 11) Cleaning - The appliance should be cleaned only as recommended by the manufacturer.
- 12) Non-use Periods - The power cord of the appliance should be unplugged from the outlet when left unused for long periods of time.
- 13) Damage Requiring Service - Only qualified personnel should service this product. If you have any questions about service please contact Numark at the number(s) shown on the back cover of this manual.

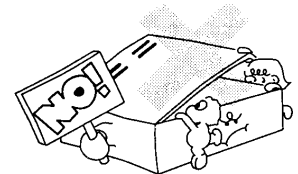

- 14) Grounding or Polarization - Precautions should be taken so that the grounding or polarization means built into the CD player is not defeated.
- 15) Internal/External Voltage Selectors - Internal or external voltage selector switches, if any, should only be reset and re-equipped with a proper plug for alternative voltage by a qualified service technician. Do not attempt to alter this yourself.
- 16) Carts and Stands - The appliance should be used only with a cart or stand that is recommended by the manufacturer of the cart or stand. An appliance and cart combination should be moved with care. Quick stops, excessive force, and uneven surfaces may cause the appliance and cart combination to overturn.

Numark - The Leader in DJ Technology

WARNING: To reduce the risk of fire or electrical shock, do not expose this appliance to rain or moisture. Electrical equipment should NEVER be kept or stored in damp environments.

DANGER: INVISIBLE LASER RADIATION WHEN OPEN AND INTERLOCK FAILED OR DEFEATED. AVOID DIRECT EXPOSURE TO BEAM.

CAUTION: This product utilizes a laser. Use of controls or adjustments other than those specified herein may result in hazardous radiation exposure.

SERVICE INSTRUCTIONS

- Disconnect power cord before servicing
- Replace critical components  only with factory parts or recommended equivalents
- For AC line powered units - Before returning repaired unit to user, use an ohmmeter to measure from both AC plug blades to all exposed metallic parts. The resistance should be no more than 100,000ohms.

NOTICE CONCERNING FCC REGULATIONS

This equipment generates and uses radio frequency energy and may cause interference to radio and television reception if you do not operate it in strict accordance with the procedures detailed in this OPERATING MANUAL.

This unit complies with Class B computing device rules in accordance with the specifications in Sub-part J or Part 15 of the FCC Rules, which are designed to provide reasonable protection against such interference in a residential installation. There is no guarantee, however, that interference will not occur in a particular installation. If the unit does cause interference to any radio or television reception, try to reduce it by one or more of the following means:

- a) Reposition the other unit and/or its antennae
- b) Move this unit
- c) Move this unit and the other unit(s) further apart
- d) Plug this unit into a different AC outlet so that it is on a different circuit from the other equipment.

This note is in accordance with Section 15.838 of the FCC Rules.

This unit does not exceed the Class B limits for radio noise emission from digital apparatus set out in the radio interference regulations of the Canadian Department of Communications.

DOUBLE INSULATED - When servicing use only identical replacement parts

For 220-volt use in USA, use NEMA style 220-volt plug. For other countries use proper plug for local outlet.

LINE VOLTAGE SELECTION

- 1) The desired voltage may be set with the VOLTAGE SELECTOR switch on the rear panel of the main unit, using a screwdriver.
- 2) Do not twist the VOLTAGE SELECTOR switch with excessive force as this may cause damage.
- 3) If the VOLTAGE SELECTOR switch does not move smoothly contact a qualified serviceman.



Please record the serial number of your unit as shown on the back of the chassis as well as the name of the dealer from whom you purchased the unit. Retain this information and your original purchase receipt for your records. Please return the enclosed warranty card to register your CD player with us.

MODEL: _____ PURCHASED FROM: _____
 SERIAL NUMBER: _____ DATE OF PURCHASE: _____

Numark® CDN-32SE

PROFESSIONAL DUAL CD PLAYER

WITH

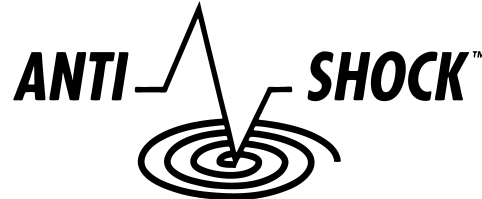

CONGRATULATIONS...

You have just purchased a dual CD player designed specifically for the professional DJ. This unit has been designed to provide CD mixing with the same ease and creativity that you have enjoyed with records. Please take a few moments to familiarize yourself with the CDN-32SE by reading the following information before attempting to operate the unit.

Once again, congratulations and thank you for making the CDN-32SE your choice in professional CD players.

FEATURES:

- Anti-Shock buffered memory
- True buffered instant start
- Interactive pitch wheel adjustment
- Seamless Looping
- Fader/relay start
- Digital Output
- 3 speed scanning
- Frame search
- Auto cue
- +10 tracks skip search
- 30 tracks program play
- Pitch display
- 8 times oversampling
- 8cm single CD compatible

Numark- *The Leader in DJ Technology*

TABLE OF CONTENTS

Safety and Registration	2
Introduction	4
Set-up Instructions & Connections	7
Description of the Features	
Remote Control Unit	8
Display	9
Transport	9
Basic Operation	
Play, Pause and Cue Operations	10
Matching the Tempo	11
Beat Matching Using Pitch Bend	11
Relay and Fader Start	12
Example of Mixing	13
Looping	14
Stuttering	17
Before Switching off the Power	18
Troubleshooting Guide	18
Information and Specifications	19
Warranty	20

**CHECK TO BE SURE
THE FOLLOWING ITEMS ARE IN THIS BOX:**

- 1) DUAL-TRANSPORT PLAYER UNIT
- 1) REMOTE CONTROL UNIT
- 1) OWNERS MANUAL (THIS BOOKLET)
- 2) RCA CONNECTING CABLES
- 2) CONTROL CABLES
- 1) FADER START CABLE
- 1) IEC POWER CORD

DESCRIPTION OF ANTI-SHOCK BUFFER MEMORY

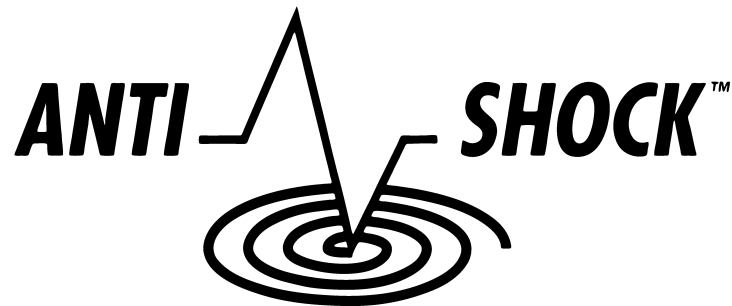

The CDN-32SE is equipped with a total of 24 Seconds of RAM Buffer memory. 12 Seconds of this is used for the Anti-Shock Buffer and the other 12 are used for instant start functions. Anti-shock is to allow the unit to be bumped around **hard** for 6 seconds per side and not stop. When the CD is first placed in the tray and a track is selected, the CD player quickly reads the beginning of the track and stores it into a buffer memory, the same way a computer stores information in RAM. This initial operation takes about 5 seconds. As you play the track, the CD Player continues to read ahead of the music and stores this information in the buffer. If the unit is bumped the CD Player will continue to play from this buffer until the unit recovers and can start filling the buffer again. The buffer should be long enough to allow recovery from most situations, however, continual shocks can erase the buffer memory. If the unit should ever run out of buffer and still be receiving shocks, then the last 2 seconds will repeat until continuation can occur. ***The music never stops.***

NOTE: The CD player can not store buffer information during the setting of a cue point with the jog wheel. If you start a CD without giving it an opportunity to load the buffer it will still start instantly and load buffer slowly. It will recover 1 second of buffer for every 6 seconds of music played at 0% pitch.

CONNECTIONS

Typical connection with a mixer is illustrated right.

1. Connect the output connection cords from the CD Player to the line inputs of your mixer.
2. Connect the remote control connection cable from the Unit 1 connector on the main unit to the Unit 1 connector on the remote control unit. Repeat for Unit 2.
3. The output connection cords and the remote control connection cables are supplied with the main unit. Be sure to use the remote control connection cables which have been supplied. Use of another cable type might cause damage.
4. Connect Fader start cables by attaching both side of your CD player to a similarly equipped DJ mixer, as in the top drawing.

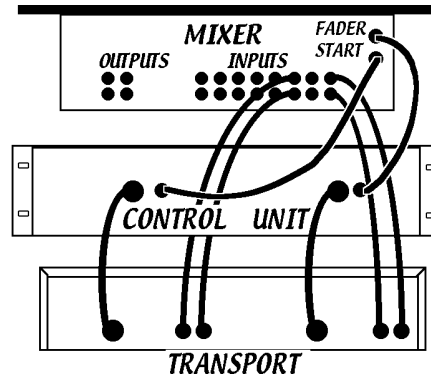

DIGITAL OUTPUTS: This CD player is specially equipped with digital outputs. The format is type 2, form 1, also known as S/PDIF (Sony/Phillips Digital Interface Format). In order to use the digital output you must activate the rear panel switch. When the digital output is active the variable pitch slider and pitch bend buttons or pitch wheel will not work.

Note: If digital information was allowed to change in pitch, other devices will not read the digital output properly.

MOUNTING YOUR CD PLAYER

- Mount the units in your console or rack with 19" EIA rails
- The transport should be mounted not to exceed an angle of 15 degrees.
- Your CD player can be affected by excess vibration so mount the units in a secure environment if possible.

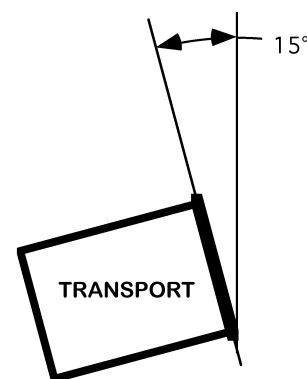

DESCRIPTION CDN-32SE REMOTE FEATURES

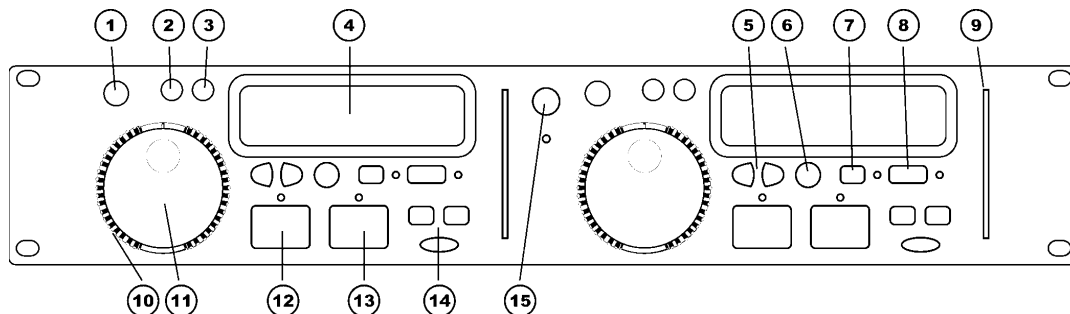

1. **OPEN/CLOSE (Disc Tray Open/Close)** - Press to load or eject the disc. Each press will open or close the disc tray on the transport. *NOTE: Tray will not open unless the disc has been paused. Tray will automatically close after 30 seconds.*
2. **TIME (Time Button)** - Switches the time display between elapsed playing time and remaining time on the track and remaining time on the entire CD.
3. **CONT/SING** - Will cause just a single track to play or all tracks in order by pressing once or twice.
4. **LCD DISPLAY** - Indicates all the functions, as they are occurring, with the CD. These functions are explained in the next section.
5. **TRACK (Track Buttons)** - Used to select the track to be played.
6. **Track 10 Button** - This button is for quickly advancing to higher tracks on a CD.
7. **PROGRAM** - Depress this button and the unit will stop and the program indicator will light. Select each track to be programmed and press the PROGRAM button between selections. You can program up to 30 tracks. Press PLAY to start the program. To exit and erase program, either hold the program button down for more than 2 seconds while the unit is stopped, open the disc tray, or turn off the power.
8. **PITCH (Pitch Button)** - Activates the Pitch Slider.
9. **PITCH SLIDER** - The pitch can be changed up to +/-12% by pressing the PITCH button so the PITCH LED is lit, then moving the sliding fader. The pitch will not be changed if the PITCH LED is off.
10. **SEARCH WHEEL (OUTER RING)** - 3 forward and 3 reverse speed positions for searching through songs. The more you turn the wheel in either direction the faster you search through the music.
11. **PITCH BEND/JOG WHEEL (INNER RING)** - The jog wheel serves 2 functions depending on the current mode.
 - The jog wheel will control a slow frame search when the CD is not playing. To set a new frame cue point, spin the wheel then press play when you have determined the proper position. Press CUE to return to the "CUE POINT".
 - When both CD players are playing a CD, the pitch bend function allows the positioning of the bass beats to be matched after the pitch of each disc is matched. Either player can "catch up" or "fall back" to match the other player. The jog wheel will temporarily bend the pitch of the music if the song is already playing by rotating the wheel clockwise to speed up or counterclockwise to slow down. By changing the pitch of one disc with respect to the pitch of the other disc, the beats can be matched.
12. **CUE** - Pressing the CUE button during play provides a return to the position at which play was started. If PAUSE is used before CUE, that will become the cue point. Alternately pressing the PLAY button and the CUE button allows the CD to be played from the same position any number of times. The CUE LED will light up from the time the CUE button is pressed until the CD has been reset to the position at which play was started. Steady lighting of this LED indicates the ready condition.
13. **START/PAUSE (Play/Pause Button)** - Each press of the Play/Pause Button causes the operation to change from play to pause or from pause to play.
14. **LOOP BUTTONS**
 - LOOP IN** - Used for setting a start loop point and new cue points during play.
 - LOOP OUT** - Used for setting the end loop point and releasing the loop action.
 - RELOOP/STUTTER** - Depending on mode, as explained further, this button is used for either repeating a previously set loop or seamlessly stuttering on the last set cue point.
15. **RELAY/FADER START** - Pressing this offers 2 functions. If the players are set in single mode it will alternate (relay) between players after each track or in Continuous after each CD. This also activates the Fader Start function in you CD player when connected to compatible fader start mixer.

LCD DISPLAY FEATURES

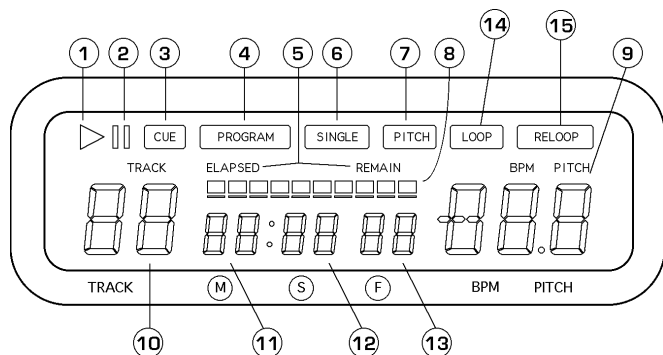

1. **PLAY** - Active while the unit is actually playing a CD.
2. **PAUSE** - Active when the unit is paused.
3. **CUE** - Flashing when the unit is setting a cue point. Lit continuously when the unit is paused at a cue point.
4. **PROGRAM** - Used for preprogramming the track order to be played automatically by the unit. This is a great function if you need to leave the CD player alone.
5. **TIME MODE** -
(Elapsed) is for showing time as it is taking place.
(Remain) shows how much time is left on a particular track. This function is controlled by the TIME BUTTON (4).
6. **SINGLE** - Shows when the unit is set to play just one track at a time. When this is not lit the CD will play continuously through all tracks. This function is controlled by the SING/CONT BUTTON (2).
7. **PITCH** - Is lit when the PITCH BUTTON is active.
8. **TIME BAR** - Shows either time remaining or elapsed depending on the setting of the TIME BUTTON (4).
9. **PITCH** - Shows the percentage change in pitch.
10. **TRACK** - Shows the track that the unit is playing with.
11. **MINUTES** - Shows the minutes elapsed or remaining depending on mode setting.

12. **SECONDS** - Shows the seconds elapsed or remaining depending on mode setting.
13. **FRAMES** - The CD Player breaks down a second into 75 frames for accurate cueing. This shows the frames elapsed or remaining depending on mode setting.
14. **LOOP** - shows when the CD is repeating a particular area with the music on the CD.
15. **RELOOP** - shows when the CD has had a loop set previously and can go back to it to loop again.

TRANSPORT FEATURES

19. **DISC TRAY** - Place your CD in here.
20. **OPEN/CLOSE (Disc Tray Open/Close)** - Press to load or eject the disc. Each press will open or close the disc tray on the transport. NOTE: Tray will not open unless the disc has been paused.
21. **POWER BUTTON** - Turn on and turn off the machine from this button. The unit should always be shut down with this button first before any external power is removed.
22. **RCA AUDIO JACKS** - Connect your CD player to your mixer from this line level output.
23. **VOLTAGE SELECTOR** - Set this switch to the voltage for your location.
24. **POWER CORD** - Plug your unit into a power outlet after checking voltage setting.
25. **CONTROL CONNECTOR** - Plug your control cables for each unit into here and the back of the remote unit.
26. **DIGITAL OUTPUTS** - The format is type 2, form 1, also known as S/PDIF (Sony/Phillips Digital Interface Format). In order to use the digital output you must set the digital output selector to on. This will deactivate the variable pitch slider and the pitch bend buttons or pitch wheel. *If you were able to adjust the pitch, other devices will not read the digital output properly.*

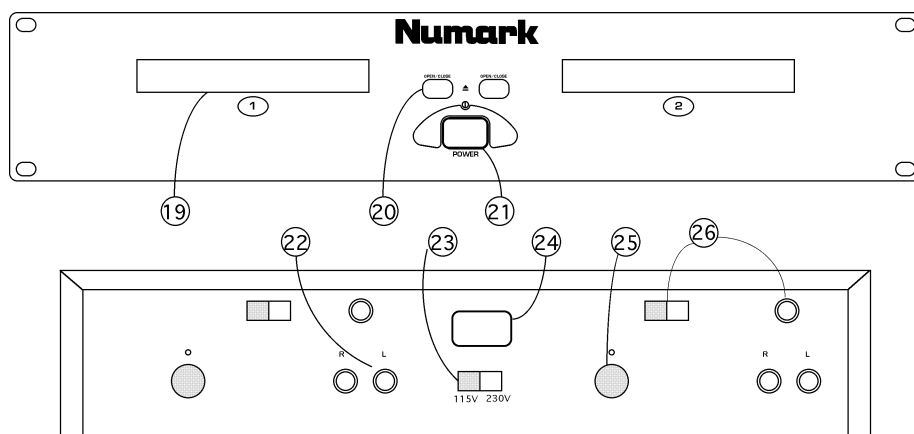

Numark - The Leader in DJ Technology

DESCRIPTION OF THE PLAY/PAUSE AND CUE OPERATIONS

STARTING PLAY OPTIONS

Play can be started any 1 of 3 ways

1. Pressing the "PLAY/PAUSE" button
2. Pressing the "STUTTER" button as explained in the STUTTER SECTION
3. When the cue button is pressed a second time, it will temporarily play a section and will stop it when the button is released. (to check a cue point)

PLAY and CUE

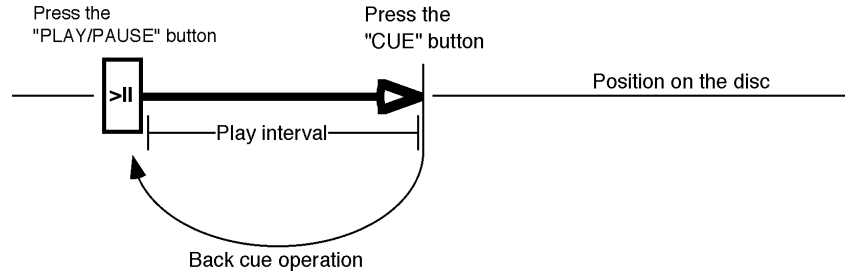

Pressing the "PLAY/PAUSE" button starts the disc. Pressing the "CUE" button will reset the disc to the last place where the disc was started. This is called the cue point. By alternately pressing the "PLAY/PAUSE" button and the "CUE" button, the disc may be returned and played from the cue point any number of times. This function is called back cue.

PLAY, PAUSE and CUE

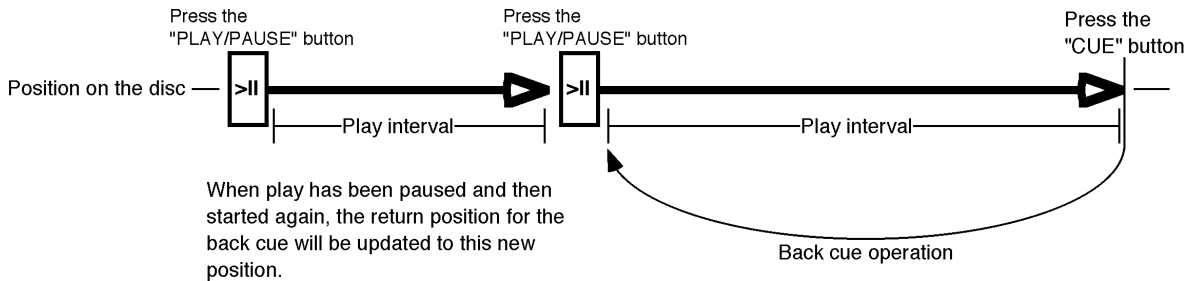

EDITING CUE POINT

When the inner search dial is turned while a cue point is set, a new cue point can be located. The CD player will repeatedly play small parts of the CD as you move it to the desired position. By pressing "PLAY/PAUSE" then "CUE" you can confirm that this new cue point is desirable

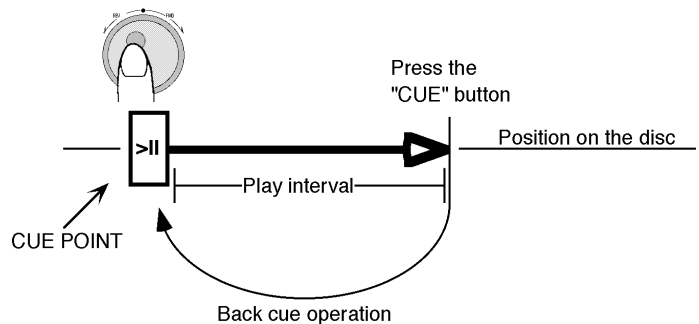

MATCHING THE BEATS PER MINUTE (BPM)

Match the tempo by monitoring the music of both PLAYER 1 and PLAYER 2 by ear and adjusting the pitch. When the tempo of the music of the selected CD player is slow compared to the tempo of the other player, move the slider to the (+) side and match the tempo. When faster, move the pitch slider to the (-) side. The following illustration shows the case of matching the pitch of PLAYER 2 to the pitch of the music being played on PLAYER 1.

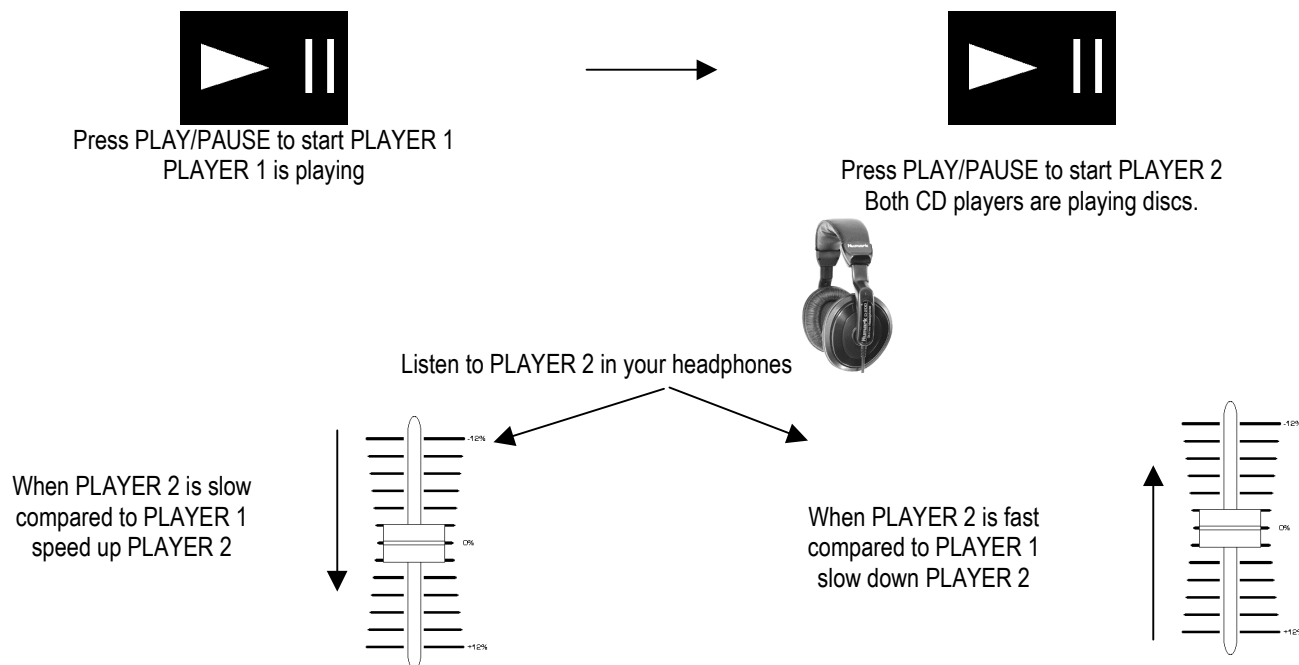

BEAT MATCHING USING PITCH BEND

If you find the BPM's (Beats Per Minute or Tempos) are the same, however, the drum beats are not matched you will need to temporarily change the pitch. The illustration below shows how to match the beat of PLAYER 2 to the beat of the music being played on PLAYER 1. (This procedure can be done on either PLAYER).

After matching the BPM's adjust the pitch temporarily as follows:

When PLAYER 2 is rotate the jog wheel counter clockwise

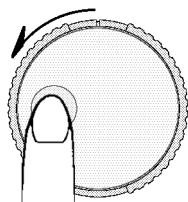

When PLAYER 2 is behind rotate the jog wheel clockwise

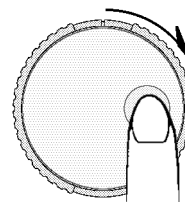

The pitch changes automatically while the jog wheel is rotated. The faster you rotate the wheel the more you change. Releasing the wheel results in a return to the original pitch. (So the BPM's are once again the same.)

RELAY PLAY

1. Press the RELAY-FADER START button while CDs are in both sides of the unit.
2. Put both sides in SINGLE play mode while learning this function.
3. Press play on PLAYER A of the unit. When that PLAYER A has finished play it will send a signal to PLAYER B to start play. You will see PLAYER B start play and PLAYER A pause and cue to the beginning of the next track. When PLAYER B has completed play PLAYER A will start.

In relay mode the play command is sent at the end of specified play. If the unit is in SINGLE mode the play command will start at the end of the track. If the unit is in CONTINUOUS mode the play command will be sent at the end of the full CD. Two CDs will play continuously, alternating from side to side. This feature will also work in program mode; however, if the sides are also in SINGLE mode the same number of tracks programmed should be the same. Play will stop at the end of the last track.

FADER-START MODE

This mode is achievable by attaching both sides of your CD player to a similarly equipped DJ mixer.

1. Connect cables between the CD remote unit and your DJ mixer.
2. Active the RELAY-FADER button.
3. Follow the directions in your mixer manual

Typically if you move the crossfader toward the active channel, the attached CD player will activate. When it is moved away that side will cue, (similar to pressing the cue button).

EXAMPLE OF MIXING USING BOTH PLAYERS OF YOUR CD PLAYER

While playing a disc on PLAYER 1 load a disc into PLAYER 2 and select your next track, match its pitch to the track playing on PLAYER1 and when you are ready use the crossfader on your mixer to fade from PLAYER 1 to PLAYER 2.

Load a disc in PLAYER 1 and select the track and press PLAY.

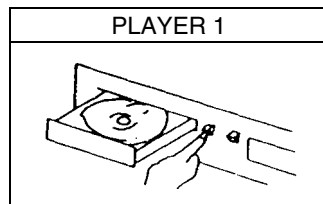

Load a disc and press the OPEN/CLOSE button.

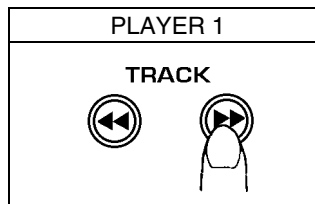

Select the track to be played.

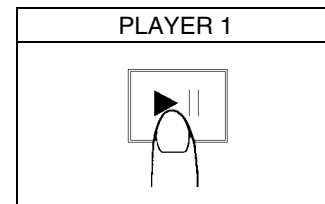

Press the PLAY button

Load a disc in PLAYER 2 and select the track then play.

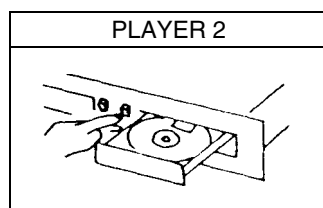

Load a disc and press the OPEN/CLOSE button.

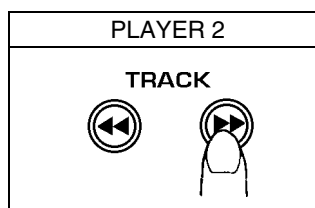

Select the track to be played.

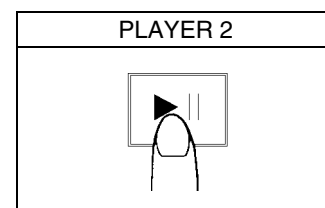

Press the PLAY button

Set and edit a start cue point on PLAYER 2

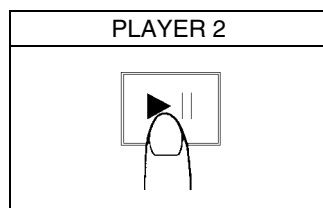

Press the Pause button of PLAYER 2.

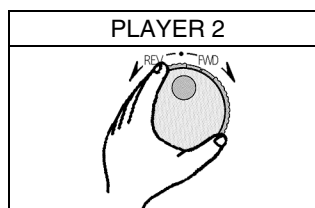

Rapidly search for a cue point using the outer wheel

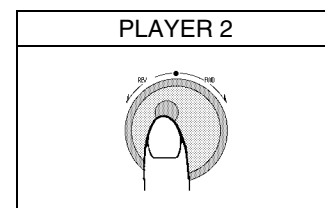

Slowly set the right point using the inner wheel

Check you new cue point

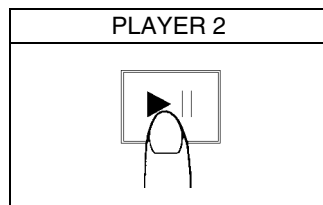

Listen with the monitor and press the play button.

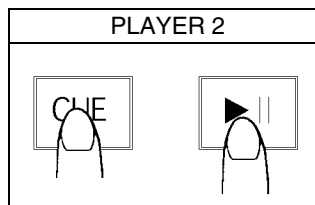

Press the cue button then play to be sure of the set cue point.

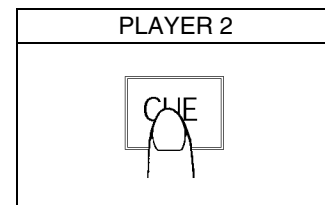

Set the player to the Cue point by pressing Cue

Do a MIX!

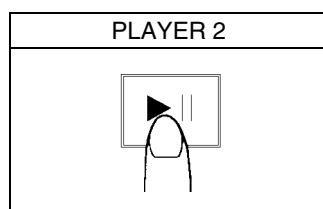

With a matching downbeat from Player 1 press the play button.

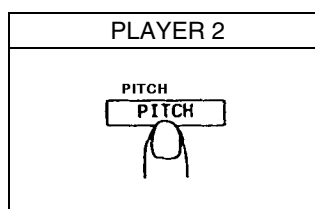

If you are beat mixing turn on your Pitch adjust and follow the directions for beat matching.

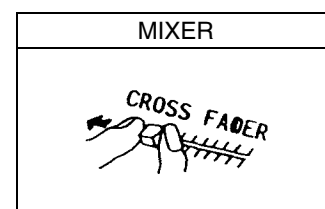

When you are happy with you mix adjust you mixer accordingly.

Numark- The Leader in DJ Technology

USING THE LOOPING FEATURES

These feature are for seamlessly looping certain areas of the CD. A loop is any area of a CD that you choose to repeat with no breaks.

There are 3 buttons associated with the loop feature.

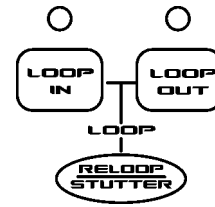

LOOP IN

The "LOOP IN" is where you wish for the loop to actually start. You will notice the "LOOP IN" LED will be lit every time you put in a new CD and select a new track. This means that the initial "CUE" point of the CD is also the default "LOOP IN" point. If you wish to set a new "LOOP IN" point, just press the "LOOP IN" button while the CD is playing when it reaches the desired point. *By default this also becomes the new "CUE" point.*

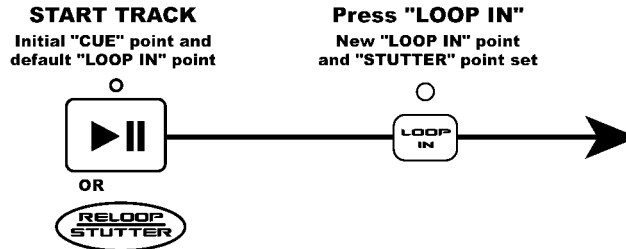

NOTE: The CD Player will always remember a new set point as the "LOOP IN" point until you actually set a new "LOOP IN" point, erase the loop, or put in a new CD. If you set a "LOOP IN" point and then do a track search prior to the point position, thus setting a new auto-cue point, the LOOP IN LED will turn off. This indicates that the CD player has stored a "LOOP IN" point but the point is not accessible until the CD player plays through the "LOOP IN" point. The "CUE" button will return you to the start position until you play through the "LOOP IN" point. Then it will return to "LOOP IN"

LOOP OUT

The "LOOP OUT" determines the end point for a loop. The first time you press this button while a CD is in play mode, the "LOOP OUT" LED will turn on and flash while the song automatically returns to the "LOOP IN" point with no breaks and continues to play. When the song reaches the "LOOP OUT" point again it returns to the "LOOP IN" point and continues to repeat this action. You will notice the "LOOP IN" LED will also be flashing during loop action. To release or end the LOOP press the "LOOP OUT" button a second time and play will continue forward when the song passes the previously set "LOOP OUT" point. The "LOOP OUT" and "LOOP IN" LEDs will also be lit solid indicating that these "LOOP" points are now in memory for "RELOOP" purposes.

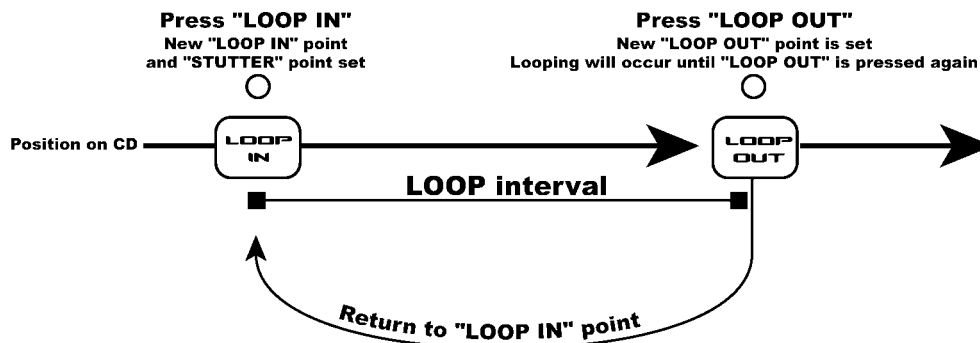

Note: The "LOOP OUT" point will be erased if "LOOP IN" is pressed or a new "CUE" point is set after the "LOOP OUT" point. This is important because without this point "RELOOP" will not be possible.

MOVING LOOP POINTS

The "LOOP IN" point can be moved while a loop is playing just by pressing the "LOOP IN" button at the new desired point. The next time "LOOP OUT" is reached the CD will return to this new "LOOP IN" point. If you should accidentally set a new "LOOP IN" point at the same place as your "LOOP OUT" point the "LOOP OUT" point will be erased and play will continue.

Note: If for any reason you should press pause then play to restart a track in between these loop points, setting a new cue point, this will also set a new "LOOP IN" point.

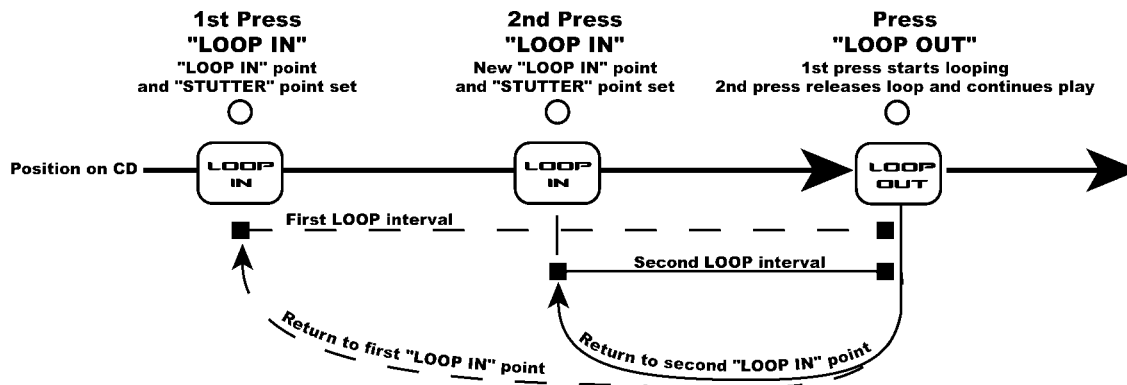

The "LOOP OUT" point can also be moved while a loop is playing just by first pressing this button to release the old "LOOP OUT" point and pressing it again at the new desired point.

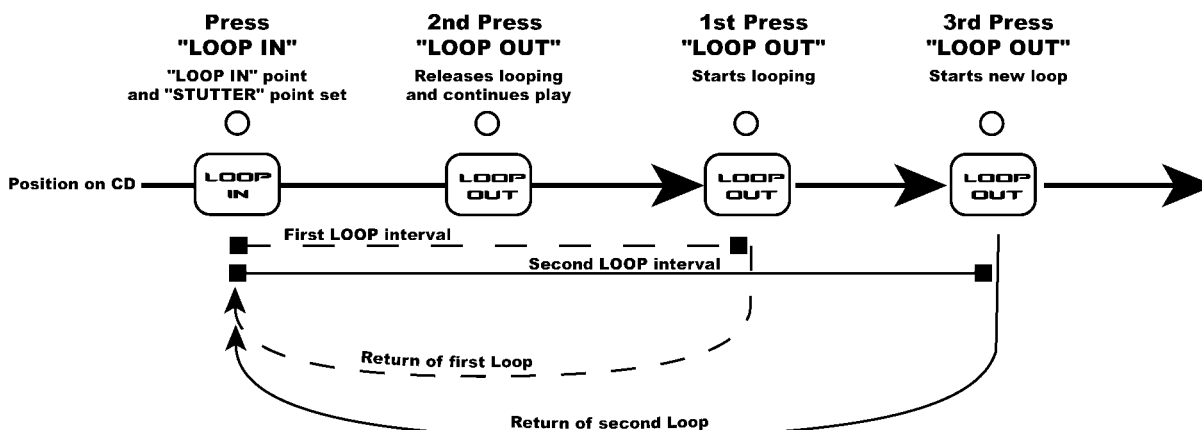

RELOOP

The "RELOOP/STUTTER" button performs 2 different functions depending on your state of play. The Reloop function is possible only if "LOOP" points have been previously set and the CD is playing beyond the "LOOP OUT" point.

The "RELOOP" button automatically causes a loop to be played again until it is released with the "LOOP OUT" button. The LEDs will flash during the loop and then become solid following the loop.

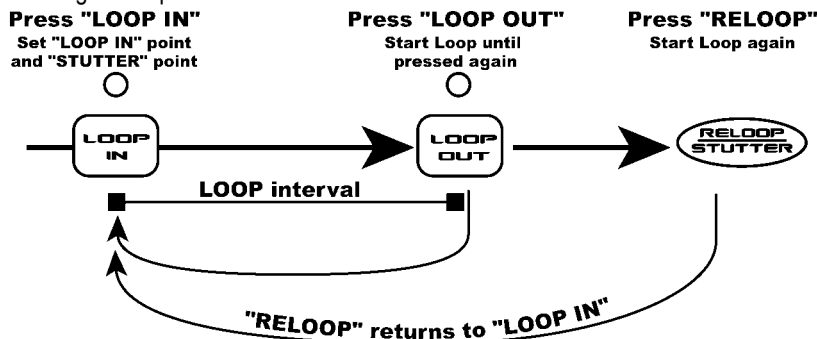

The second function of this button is described in the section called "STUTTERING FUN"

Numark- The Leader in DJ Technology

PRE-PROGRAMMING AND EDITING A LOOP

LOOP IN PRE-PROGRAM

To pre-program your "LOOP IN" point either play your song or search for the desired "LOOP IN" point using the search and jog wheels. When you get to the desired point press "LOOP IN". If you wish to edit this point turn the jog wheel until you find the desired point. When you press play the CD will begin play from the new "LOOP IN" point. This also is the *temporary* new "CUE" point. If you then hit play to listen to the point and cue to go back you can continue to edit with the jog wheel.

LOOP OUT PRE-PROGRAM

To pre-program your "LOOP OUT" point play your song until you get to the desired "LOOP OUT" point and press "LOOP OUT". To rapidly advance over a long distance you can use the search wheel with no center cue-jog. **DO NOT USE THE TRACK BUTTONS****. If the CD player is presently in play mode, the song will return to the "LOOP IN" point and continue playing the LOOP.

If you wish to precisely set the "LOOP OUT" point while searching;

- a. press "PAUSE" once only before you reach the desired point, if you are currently in play.
- b. turn the jog wheel until you find the desired point.
- c. hit "LOOP OUT" .

REVIEW YOUR LOOP

To review, press "RELOOP" only and the CD will begin playing the LOOP from the "LOOP IN" point so you may listen to the entire LOOP. **DO NOT PRESS PLAY OR YOU WILL SET A NEW "CUE" AND "LOOP IN" POINT AND ERASE THE "LOOP OUT" POINT!** If you wish to advance quickly through a long loop, use the search wheel only.

If you wish to edit this point again;

- a. Press "LOOP OUT" to release the loop.
- b. Repeat the above steps.

To review your loop while the CD is already playing press "CUE". This returns the CD to the "LOOP IN" point, then press play.

**** Pressing the track buttons puts the CD player into an auto-cue mode. Multiple tracks are often found for single songs on remix service CDs. The track select mode automatically sets new cue points and would set a new "LOOP IN" point if set after the original "LOOP IN" point.**

PLAYING YOUR LOOP

To return to the beginning of the song and play after you are happy with the loop:

1. Press "PAUSE" to stop the play action of the CD or "CUE" to return to the "LOOP IN" point.
2. Track backwards until you reach the beginning of the song. (*Remix CD's often contain multiple track numbers for the same song.*)
3. Auto-cue to the beginning of the track will then occur. Once this occurs your cue button will return you to this point until you pass over the "LOOP IN" point. Then "LOOP IN" will be the new "CUE" point.
4. The "LOOP OUT" LED will be flashing indicating a preset loop is ahead and will be played when reached.
5. When the "LOOP IN" point is reached both "LOOP IN" and "LOOP OUT" LEDs should flash.
6. The LOOP should occur as preset by you until you release it with the "LOOP OUT" button.
7. Both "LOOP IN" and "LOOP OUT" LEDs should then go solid again indicating the possibility of RELOOP.

NOTE: If you should decide that you do not want to automatically play a preset loop after you start a song, just press "LOOP OUT" anytime before you actually reach the "LOOP OUT" point and the "LOOP OUT" LED will remain solid. (You can press it again before the "LOOP IN" point if you change your mind.) The "LOOP IN" LED will come on solid when this point is reached indicating the possibility of RELOOP. This will allow you to use the selection for reloop purposes. However, until you pass the "LOOP OUT" point the "RELOOP/STUTTER" button only acts as a STUTTER function as explained in STUTTERING FFFUN.

If you turned off your "LOOP OUT" while practicing your loop, remember to turn it on again before reaching the "LOOP IN" point.

ERASING YOUR LOOP

To erase presets loop either;

- a. Open and close the door.
- b. Press the program button twice.
- c. Select a track, a new "CUE" point, or new "LOOP IN" point beyond the "LOOP OUT" point.
- d. Press "LOOP IN" prior to the old point to set a new loop.

DESCRIPTION OF LED DISPLAY

LOOP IN on /LOOP OUT off: This means that there is a LOOP IN point available for looping and stuttering, but no LOOP OUT point is set yet.

LOOP IN flashing /LOOP OUT flashing : This indicates that the CD player is actively looping from LOOP IN to LOOP OUT.

LOOP IN on /LOOP OUT on: This indicates that the LOOP IN and LOOP OUT points are set and a RELOOP will return to the LOOP IN to play the loop.

LOOP IN off /LOOP OUT off : This indicates that:

- There is a LOOP IN point stored into memory, but this looping function and this STUTTER point are disabled until the music plays through the point.
- There is no LOOP OUT point set yet.

LOOP IN off /LOOP OUT on: A future loop has been stored into memory. This loop will be inactive until either LOOP OUT is pressed prior to the CD playing through the LOOP IN point or RELOOP is pressed after the LOOP IN point.

LOOP IN off /LOOP OUT flashing : An active loop is stored into memory and will automatically play after the music plays through the LOOP IN point.

DESCRIPTION OF STUTTERING FFFFUN.....

This function allows music to be replayed from the last set cue point seamlessly.

Carefully read all of the following conditions to fully understand this button's operation. Don't forget this button serves two functions depending upon the CD player's state of play.

- If the CD is paused either at the beginning of a track or at some other "CUE" point the "STUTTER/RELOOP" can start play of the song and actually seamlessly restart every time the button is pressed.
- If the song is already playing and no additional cue or loop in points have been set then the CD will return to the place where you originally started playing and seamlessly start playing again. If this was on a beat this would be a quick way to seamlessly extend a mix.
- If another "CUE" or "LOOP IN" point has been set, but you have not reached this point yet, the song will return to the start position and seamlessly restart playing.
- If a "LOOP IN" point but no "LOOP OUT" point has been set and you have passed this point, then the song will return to the "LOOP IN" point and start playing. The reason for this is that every time you set a "LOOP IN" point you are also resetting the "CUE" point.

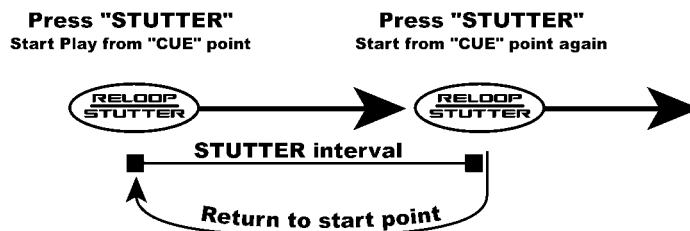

- If another "CUE" or "LOOP IN" point has been set, but you have not reached this point yet, the song will return to the start position and seamlessly restart playing.

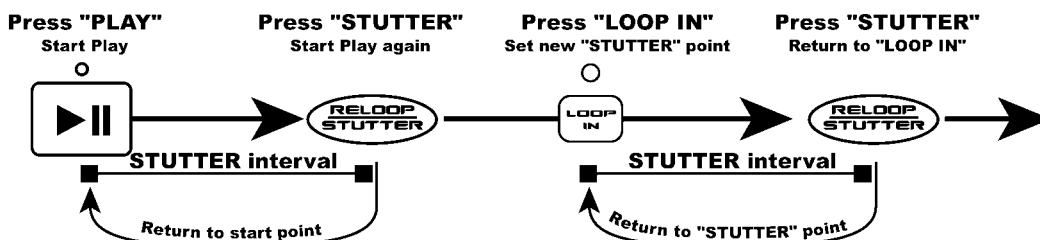

- If a "LOOP IN" point but no "LOOP OUT" point has been set and you have passed this point, then the song will return to the "LOOP IN" point and start playing. The reason for this is that every time you set a "LOOP IN" point you are also resetting the "CUE" point.
- If a "LOOP IN" point and "LOOP OUT" point have been set, and the CD is in the middle of playing a loop, then the "STUTTER/RELOOP" button will create a stutter back to the "LOOP IN" point and continue the set loop until the "LOOP OUT" button is pressed, to release the loop.

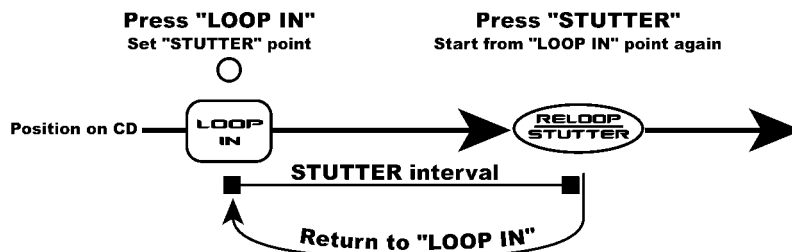

Again it is important to remember that "STUTTER" and "RELOOP" are the same button.

- If a "LOOP IN" point and "LOOP OUT" point have been set and the CD is finished playing a loop then the "STUTTER/RELOOP" will return to the "LOOP IN" and continue to RELOOP until the "LOOP OUT" is pressed.
- If a new "LOOP IN" point is set after the last "LOOP OUT" point then this can be a new "STUTTER" point.

Simply put, you can Stutter on either your initial cue point or a set "LOOP IN" point, whichever is immediately prior to your current play position.

(PRACTICE ALL OF THIS BEFORE SHOWING YOUR SKILLS TO THE AUDIENCE!)

Numark- The Leader in DJ Technology

BEFORE SWITCHING OFF THE POWER:

When you have finished using the CD player, be sure that the disc tray is closed with the "OPEN/CLOSE" button before switching off the power.

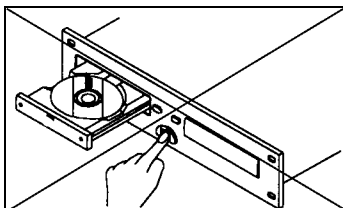

DO NOT switch off the power when the disc holder is open.

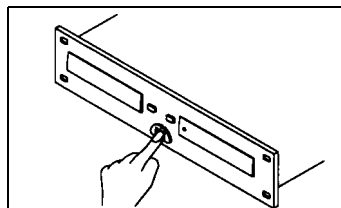

Switch off the power **after** the disc holder has been closed with the "OPEN/CLOSE" button

TROUBLESHOOTING:

Symptom	Possible Cause	Corrective Action
The power fails to switch on when the POWER switch is set to on	Poor power plug connection at the AC outlet or IEC Power cord loose from rear of unit	Insert the power plug firmly into the AC outlet and make sure connection is good in unit rear
Disc play does not start	The disc is loaded upside down The disc is too dirty	Reload the disc with the label side up Clean the disc
No sound	Improper output cable connections Improper amplifier operation	Connect the output cables correctly Check amplifier setup
Sound skips	The CD player is subject to vibrations or physical shock The disc is too dirty	Change the installation location Clean the disc
Programmed disc play will not function	The CD player is in normal disk play mode	Hold down the Program button for 3 seconds then program the tracks
Hum	Loose cable connections	Firmly connect all audio plugs

SPECIFICATIONS

TECHNICAL

Quantization	16-bit linear/channel, 3 beam laser
Oversampling rate	8 times
Frequency response	20Hz-20KHz
Channel separation	86dB
T.H.D. + NOISE	0.01%
S/N ratio (IHF-A)	94dB
Output level	2.0Vrms
Short access time (Play next track)	less than 1.7sec
Long access time (Track 1 ->Track 20)	less than 3sec
Instant start	less than .015 sec
Pitch control range	+/-12%
Pitch bend	+/-16%
Digital Output	type 2, form 1, S/PDIF (Sony/Phillips Digital Interface Format)

GENERAL

Dimensions:	Main Unit:	482 (W) x 88.8 (H) x 264 (D) mm (without feet) 19 (W) x 3.5 (H) x 10 3/8 (D) inches (without feet)
	Control Unit:	482 (W) x 88.8 (H) x 74 (D) mm (without feet) 19 (W) x 3 1/2 (H) x 2 7/8 (D) inches (without feet)
Weight:	Player Unit:	5 Kgs., 11 lbs.
	Control Unit:	2 Kgs., 4.4 lbs.
Power Supply:		115/230V AC, 50/60Hz
Power Consumption:		25W

Numark®

Professional Disc Jockey Products

LIMITED PRODUCT WARRANTY

1. What is covered and for how long? NUMARK INDUSTRIES LCC ("NUMARK") warrants to the original purchaser that NUMARK'S DJ mixers and amplifiers are free from defects in material and workmanship under normal use and service for the period commencing upon the date of purchase from an authorized NUMARK dealer and continuing for the following period of time after that date for (2) Years. The warranty is extended to (3) Years with the completion of the warranty card provided that the warranty card is completed and returned within (30) days from the date of purchase. All other NUMARK products are warranted for (1) Year including but not limited to CD players, turntables, preamplifiers, beatkeepers, equalizers, microphones, headphones, and all other accessories.
2. What is not covered? This Limited Warranty is conditioned upon proper use of the product by the purchaser.
This Limited Warranty does not cover: (a) defects or damage resulting from accident, misuse, abuse, neglect, unusual physical or electrical stress, modification of any part of the product, or cosmetic damage; (b) equipment that has the serial number removed or made illegible; (c) all plastic surfaces and other externally exposed parts that are scratched or damaged due to normal use; (d) defects or damage from improper testing, operation, maintenance, installation, adjustment, or service of the mixers; (e) crossfaders.
3. What are NUMARK'S obligations? During the applicable warranty period, NUMARK will repair or replace, at NUMARK'S sole discretion, without charge to the purchaser, any defective component part of the mixer. To obtain service under this Limited Warranty, purchaser must first contact NUMARK and obtain a return authorization number ("RA#"). Purchaser must then return the mixer to NUMARK in an adequate container for shipping, accompanied by purchaser's sales receipt or comparable proof of sale showing the date of purchase, the serial number of the product, and the seller's name and address. To obtain an RA# and assistance on where to return the mixer, contact NUMARK customer service at 401-295 9000. Upon receipt, NUMARK will repair or replace the defective products. NUMARK may, at NUMARK'S sole discretion, use rebuilt, reconditioned, or new parts or components when repairing any product or replace a product with a rebuilt, reconditioned or new product. Repaired mixers will be warranted for a period equal to the remainder of the original Limited Warranty on the original mixer or for (90) days, whichever is longer. All replaced parts, components, boards and equipment become the property of NUMARK. If NUMARK determines that any mixer is not covered by this Limited Warranty, purchaser must pay all parts, shipping, and labor charges for the repair or return of such mixer.
4. What are the limits on NUMARK'S liabilities? THE WARRANTIES GIVEN IN THIS LIMITED WARRANTY, TOGETHER WITH ANY IMPLIED WARRANTIES COVERING NUMARK MIXERS, INCLUDING WITHOUT LIMITATION ANY WARRANTIES OF MERCHANTABILITY OR FITNESS FOR A PARTICULAR PURPOSE, ARE LIMITED TO THE DURATION OF THIS LIMITED WARRANTY. EXCEPT TO THE EXTENT PROHIBITED BY APPLICABLE LAW, NUMARK SHALL NOT BE LIABLE FOR ANY SPECIAL, INCIDENTAL, CONSEQUENTIAL, INDIRECT OR SIMILAR DAMAGES, LOSS OF PROFITS, DAMAGES TO PURCHASER'S PROPERTY, OR INJURY TO PURCHASER OR OTHERS ARISING OUT OF THE USE, MISUSE OR INABILITY TO USE ANY NUMARK MIXER, BREACH OF WARRANTY, OR NEGLIGENCE, INCLUDING BUT NOT LIMITED TO NUMARK'S OWN NEGLIGENCE, EVEN IF NUMARK OR ITS AGENT HAS BEEN ADVISED OF SUCH DAMAGES, OR FOR ANY CLAIM BROUGHT AGAINST PURCHASER BY ANY OTHER PARTY. THIS LIMITED WARRANTY IS THE COMPLETE WARRANTY FOR NUMARK'S MIXERS, AND IS GIVEN IN LIEU OF ALL OTHER EXPRESS WARRANTIES. THIS LIMITED WARRANTY SHALL NOT EXTEND TO ANYONE OTHER THAN THE ORIGINAL PURCHASER OF THIS PRODUCT AND STATES PURCHASER'S EXCLUSIVE REMEDY. IF ANY PORTION OF THIS LIMITED WARRANTY IS ILLEGAL OR UNENFORCEABLE BY REASON OF ANY LAW, SUCH PARTIAL ILLEGALITY OR UNENFORCEABILITY SHALL NOT AFFECT THE ENFORCEABILITY OF THE REMAINDER OF THIS LIMITED WARRANTY WHICH PURCHASER ACKNOWLEDGES IS AND WILL ALWAYS BE CONSTRUED TO BE LIMITED BY ITS TERMS OR AS LIMITED AS THE LAW PERMITS. This Limited Warranty allocates risk of product failure between purchaser and NUMARK, and NUMARK'S product pricing reflects this allocation of risk and the limitations of liability contained in this Limited Warranty. The agents, employees, distributors, and dealers of NUMARK are not authorized to make modifications to this Limited Warranty, or make additional warranties binding on NUMARK. Accordingly, additional statements such as dealer advertising or presentation, whether oral or written, do not constitute warranties by NUMARK and should not be relied upon.
5. How does state law apply to this warranty? SOME STATES DO NOT ALLOW THE EXCLUSION OR LIMITATIONS OF INCIDENTAL OR CONSEQUENTIAL DAMAGES OR HOW LONG AN IMPLIED WARRANTY LASTS, SO THE ABOVE LIMITATIONS OR EXCLUSIONS MAY NOT APPLY TO PURCHASER.
6. This Limited Warranty gives you specific legal rights. You may also have other rights, which vary from one jurisdiction to another.

RETURN INFORMATION

- A Return Authorization number must be obtained from Numark through the address or phone numbers below.
- A copy of the original sales receipt must also be included for the equipment to be repaired under warranty.
- The faulty equipment must be packed in its original packaging.
- One additional outer layer of packaging must be included to ensure product safety. Failure to do so may inadequately protect the equipment in transit and, therefore, jeopardize the customer's warranty.
- Numark will not accept COD shipments and no call tags will be issued for merchandise return.
- Numark will not return repaired merchandise to customers by priority service, unless by written request at the customer's cost. Requests must be submitted in writing with merchandise returned.
- The defective Numark equipment should be sent, FREIGHT PREPAID with Return Authorization number clearly printed on the outer packaging and original sales receipt enclosed to:

Numark INDUSTRIES
Attention: Service Department
11 Helmsman Avenue
North Kingstown, RI 02852 USA

Phone: +1 (401) 295-9000
Fax: +1 (401) 295-5200
Web: www.numark.com

Free Manuals Download Website

<http://myh66.com>

<http://usermanuals.us>

<http://www.somanuals.com>

<http://www.4manuals.cc>

<http://www.manual-lib.com>

<http://www.404manual.com>

<http://www.luxmanual.com>

<http://aubethermostatmanual.com>

Golf course search by state

<http://golfingnear.com>

Email search by domain

<http://emailbydomain.com>

Auto manuals search

<http://auto.somanuals.com>

TV manuals search

<http://tv.somanuals.com>