

Numark

OPERATING INSTRUCTIONS

TT200

CAUTION!

TO PREVENT THE RISK OF ELECTRIC SHOCK, DO NOT REMOVE COVER (OR BACK). NO USER-SERVICEABLE PARTS INSIDE. REFER SERVICING TO QUALIFIED SERVICE PERSONNEL.



IMPORTANT

The lightning flash with arrowhead symbol, within an equilateral triangle, is intended to alert the user to the presence of un-insulated "dangerous voltage" within the product's enclosure that may be of sufficient magnitude to constitute a risk of electric shock to persons.



NOTICE

The exclamation point within an equilateral triangle is intended to alert the user to the presence of important operating and maintenance (servicing) instructions in the literature accompanying the appliance.

NOTICE

The apparatus shall not be exposed to dripping or splashing and that no objects filled with liquids, such as vases, shall be placed on the apparatus.

CONTENTS

Safety Precautions	1
Setup & Installation	2
Platter Setup	3
Cartridge Setup	4
Interchanging Tonearm Tubes	5
Tone Arm Setup	6
Controls	7
Cable Setup	10
Operation	11
Specifications	11
Trouble Shooting	12
Warranty Information	13
Return Information	14

Thank you for buying this Numark product.

Please read these operating instructions so you will know how to operate this equipment properly. After you have finished reading these instructions, keep them for future reference.

WARNING: TO PREVENT FIRE OR SHOCK HAZARD, DO NOT EXPOSE THIS APPLIANCE TO RAIN OR MOISTURE.

CAUTION:

This product satisfies FCC regulations when shielded cables and connectors are used to connect the unit to other equipment. To prevent electromagnetic interference with electric appliances such as radios and televisions, use shielded cables and connectors for connections.

IMPORTANT NOTICE:

RECORD THE MODEL NUMBER AND SERIAL NUMBER OF THIS EQUIPMENT BELOW.

MODEL NO: _____

SERIAL NO: _____

SAFETY PRECAUTIONS

READ INSTRUCTIONS

All the safety and operating instructions should be read before the product is operated.

RETAIN INSTRUCTIONS

The safety and operating instructions should be retained for future reference.

HEED WARNINGS

All warnings on the product and in the operating instructions should be adhered to.

FOLLOW INSTRUCTIONS

All operating and use instructions should be followed.

CLEANING

Unplug this product from the wall outlet before cleaning. The product should be cleaned only with a polishing cloth or a soft dry cloth. Never clean with furniture wax, benzene, insecticides or other volatile liquids since they may corrode the cabinet.

ATTACHMENTS

Do not use attachments not recommended by the product manufacturer as they may cause hazards.

WATER AND MOISTURE

Do not use this product near water - for example, near a bathtub, washbowl, kitchen sink, or laundry tub; in a wet basement; or near a swimming pool; and the like.

ACCESSORIES

Do not place this product on an unstable cart, stand, tripod, bracket, or table. The product may fall, causing serious injury to a child or adult and serious damage to the product. Use only with a cart, stand, tripod, bracket, or table recommended by the manufacturer, or sold with the product. Any mounting of the product should follow the manufacturer's instructions, and should use a mounting accessory recommended by the manufacturer.

CART

A product and cart combination should be moved with care. Quick stops, excessive force, and uneven surfaces may cause the product and cart combination to overturn.

POWER SOURCES

This product should be operated only from the type of power source indicated on the marking label. If you are not sure of the type of power supply to your home, consult your product dealer or local power company.

LOCATION

The appliance should be installed in a stable location.

NONUSE PERIODS

The power cord of the appliance should be unplugged from the outlet when left unused for a long period.

GROUNDING OR POLARIZATION

If this product is equipped with a polarized alternating current line plug (a plug having one blade wider than the other), it will fit into the outlet only one way. This is a safety feature. If you are unable to insert the plug fully into the outlet, try reversing the plug. If the plug should still fail to fit, contact your electrician to replace your obsolete outlet. Do not defeat the safety purpose of the polarized plug. If this product is equipped with a three-wire grounding type plug, a plug having a third (grounding) pin, it will only fit into a grounding type power outlet. This is a safety feature. If you are unable to insert the plug into the outlet, contact your electrician to replace your obsolete outlet. Do not defeat the safety purpose of the grounding type plug.

POWER-CORD PROTECTION

Power-supply cords should be routed so that they are not likely to be walked on or pinched by items placed upon or against them, paying particular attention to cords at plugs, convenience receptacles, and the point where they exit from the product.

OUTDOORS ANTENNA GROUNDING

If an outside antenna or cable system is connected to the product, be sure the antenna or cable system is grounded to provide some protection against voltage surges and built-up static charges. Article 810 of the National Electrical Code, ANSI/NFPA 70, provides information with regard to proper grounding of the mast and supporting structure, grounding of the lead-in wire to an antenna discharge unit, size of grounding conductors, location of antenna-discharge unit, connection to grounding electrodes, and requirements for the grounding electrode.

LIGHTNING

For added protection for this product during a lightning storm, or when it is left unattended and unused for long periods, unplug it from the wall outlet and disconnect the antenna or cable system. This will prevent damage to the product due to lightning and power-line surges.

POWER LINES

An outside antenna system should not be located in the vicinity of overhead power lines or other electric light or power circuits, or where it can fall into such power lines or circuits. When installing an outside antenna system, extreme care should be taken to keep from touching such power lines or circuits, as contact with them might be fatal.

OVERLOADING

Do not overload wall outlets, extension cords, or integral convenience receptacles as this can result in a risk of fire or electric shock.

OBJECT AND LIQUID ENTRY - Never push objects of any kind into this product through openings as they may touch dangerous voltage points or short-out parts that could result in a fire or electric shock. Never spill liquid of any kind on the product.

SERVICING

Do not attempt to service this product yourself as opening or removing covers may expose you to dangerous voltage or other hazards. Refer all servicing to qualified service personnel.

DAMAGE REQUIRING SERVICE

Unplug this product from the wall outlet and refer servicing to qualified service personnel under the following conditions:

When the power-supply cord or plug is damaged.

If liquid has been spilled, or objects have fallen into the product.

If the product has been exposed to rain or water.

If the product does not operate normally by following the operating instructions. Adjust only those controls that are covered by the operating instructions as an improper adjustment of other controls may result in damage and will often require extensive work by a qualified technician to restore the product to its normal operation.

If the product has been dropped or damaged in any way.

When the product exhibits a distinct change in performance - this indicates a need for service.

REPLACEMENT PARTS

When replacement parts are required, be sure the service technician has used replacement parts specified by the manufacturer or have the same characteristics as the original part. Unauthorized substitutions may result in fire, electric shock, or other hazards.

SAFETY CHECK

Upon completion of any service or repairs to this product, ask the service technician to perform safety checks to determine that the product is in proper operating condition.

HEAT

The product should be situated away from heat sources such as radiators, heat registers, stoves, or other products (including amplifiers) that produce heat.

SETUP & INSTALLATION

This turntable has been designed exclusively for DJ use and can be setup in a variety of different ways depending on your mixing style. The turntable should rest on a level and stable surface that is clear of obstructions. If a mixer is placed between two turntables make sure that there is at least 1/4" (7mm) between the mixer and the turntables to prevent damage to the turntables and to reduce unwanted system noise.

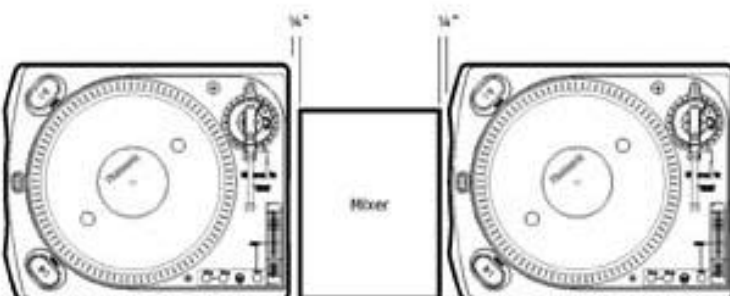
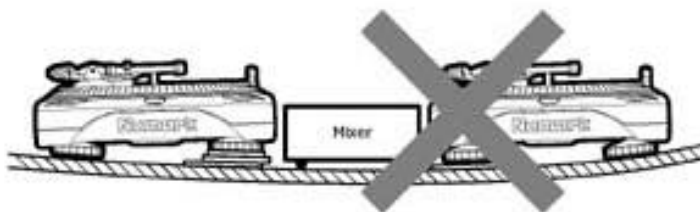

Setup Style 1 (traditional)

Best For:
Long mixes and blending techniques

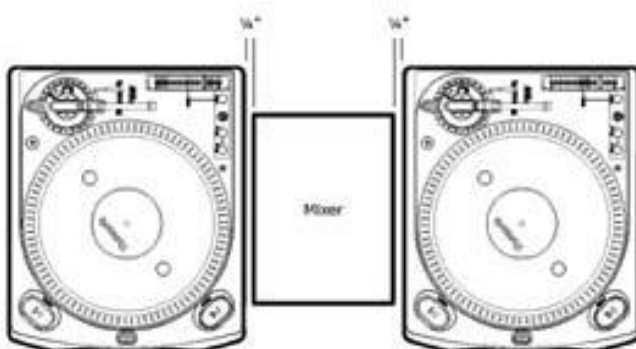

Setup Style 2 (battle style, scratching)

Best For:
Scratching, cutting, and aggressive mixing techniques

There are many variations of these setups. Find the best setup that works for your mixing style by experimenting with different turntable and mixer placements. It is strongly recommended that the top mixer surface and the top flat surface of the turntable be at the same level.

PLATTER SETUP

WARNING: Incorrect Platter setup can lead to poor turntable performance, platter instability, or permanent motor damage.

1. Start by inspecting the bottom of the aluminum platter to check that both locking pins have rubber fittings on them.
2. Next, rotate the top of the motor assembly (brass in color) so that two holes are aligned parallel with the front of the turntable.
3. Install the platter onto the center spindle and motor assembly making sure that the Numark logo and the two holes are aligned parallel with the front of the turntable.
4. The two locking pins should drop into the top of the motor assembly for a stable and secure fit. If they do not, grasp the center spindle with one hand while rotating the platter with the other until the locking pins drop into place. If the platter is properly installed, it should not wobble and should rotate smoothly without any noise.

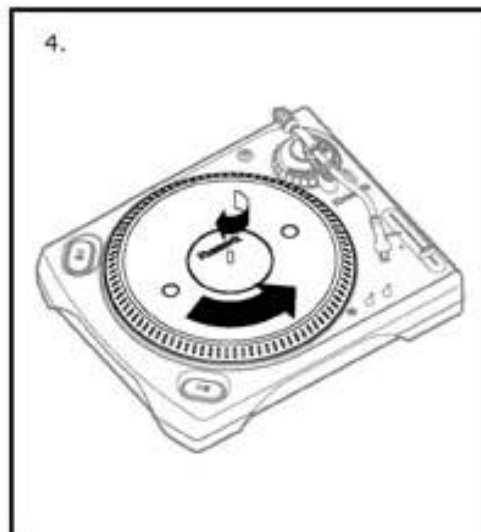
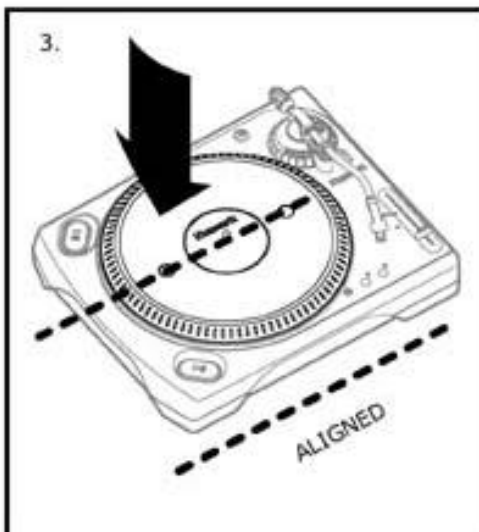
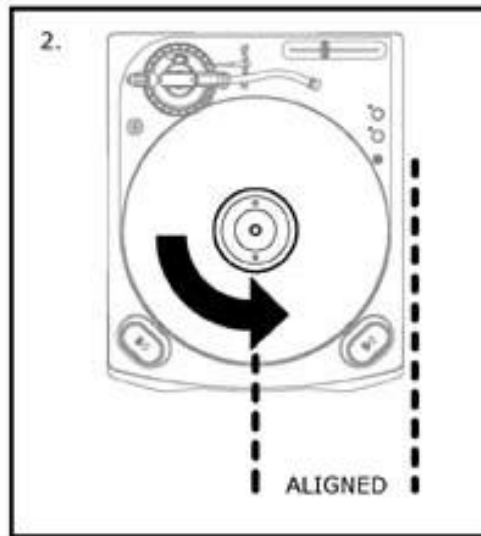
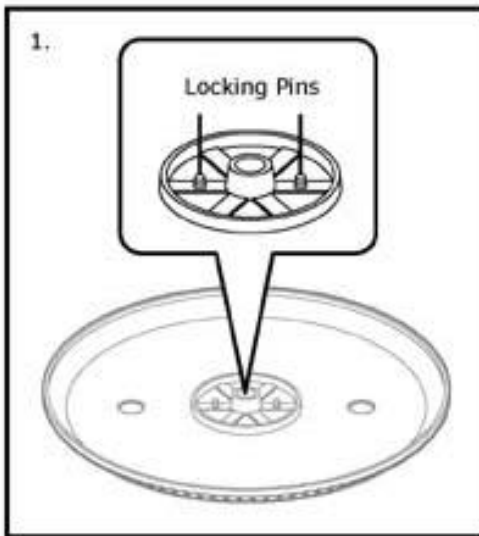

CARTRIDGE SETUP

For Head Shell Mounted Cartridges:

The cartridge that comes with this turntable should be preinstalled on the head shell. If it isn't, please follow the below instructions for installing a cartridge onto the head shell.

1. Position the head shell and the cartridge so that the four connector pins are visible. Make sure that the stylus cover is installed to prevent damage to the stylus during installation.
2. Prepare to connect the cartridge to the head shell using the green, red, blue and white connector wires.
3. Starting with the upper left pin and going clockwise install the white, the red, the green and finally the blue wires to the connector pins. Be careful not to bend the metal clips on the end of the wires. These metal connectors should never make contact with one another.
4. Using the screws and bolts that are included with the cartridge, loosely fasten the cartridge to the head shell body.
5. Once temporarily fastened, position the cartridge so that both screws are aligned with the optimum position mark on the Head shell (Numark HS 1 Head shell and Numark Cartridges only.) Moving the both screws to a mark away from the optimum position indicated on the head shell may increase or decrease performance depending on the cartridge used. For safe vinyl record treatment, the screws should always be aligned perpendicular to the head shell (any angle may increase "record burn.")
6. Once the cartridge is positioned correctly, secure the cartridge to the head shell by tightening the mounting screws.

For Integrated Head Shell Cartridges (Numark CS-1, CC-1, CX-1, etc.)

7. Align the pin on the rear of the Cartridge Assembly so that it is in a vertical position and insert it into the tone arm lock nut.
8. Secure the cartridge to the tone arm by turning the tone arm lock nut clockwise until the head shell feels secure and does not wobble to the left or right. **WARNING:** Over tightening the tone arm lock nut may result in permanent damage to the tone arm or the cartridge.
9. Remove the stylus protector before playback.

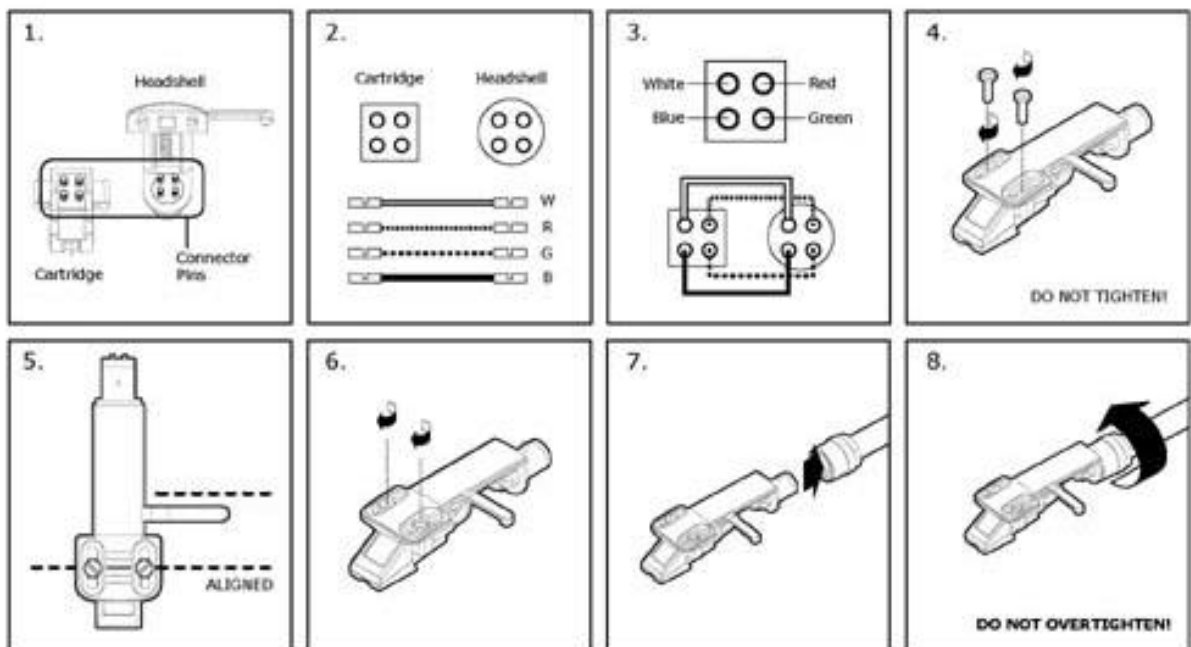

INTERCHANGING TONEARM TUBES

WARNING: An incomplete understanding of this procedure could lead to permanent damage to the headshell, your records, or the tonearm assembly.

NOTICE: Interchanging tonearm tubes unnecessarily may shorten the life of the tonearm tubes and/or tonearm components.

This turntable features the world's only tonearm assembly capable of accommodating two different tonearm tube styles: S-Shaped and Straight. The S-Shaped tube produces a higher signal to noise ratio with most cartridge assemblies. The Straight tube is ideal for heavy back-cueing or scratching. Decide which tube to use based on your mixing style.

1. Power off the turntable and any connected mixers, amplifiers or monitoring devices.
2. Remove the Cartridge from the tonearm tube that is currently installed on the tonearm tube by rotating the locking collar counter clockwise.
3. Unclip the tonearm tube from the armrest.
4. Remove the tonearm tube by rotating the locking collar counter clockwise.
5. Insert the desired tonearm into the tonearm assembly with the screws **FACING TOWARDS THE TURNTABLE BODY**.
6. Tighten the tonearm tube in place by rotating the inner collar clockwise.
WARNING: It is only necessary to tighten the tonearm tube lock collar until resistance is felt. Over tightening the tonearm tube lock collar will damage the tonearm tube.
7. Reinstall the headshell and proceed to **TONEARM SETUP**.

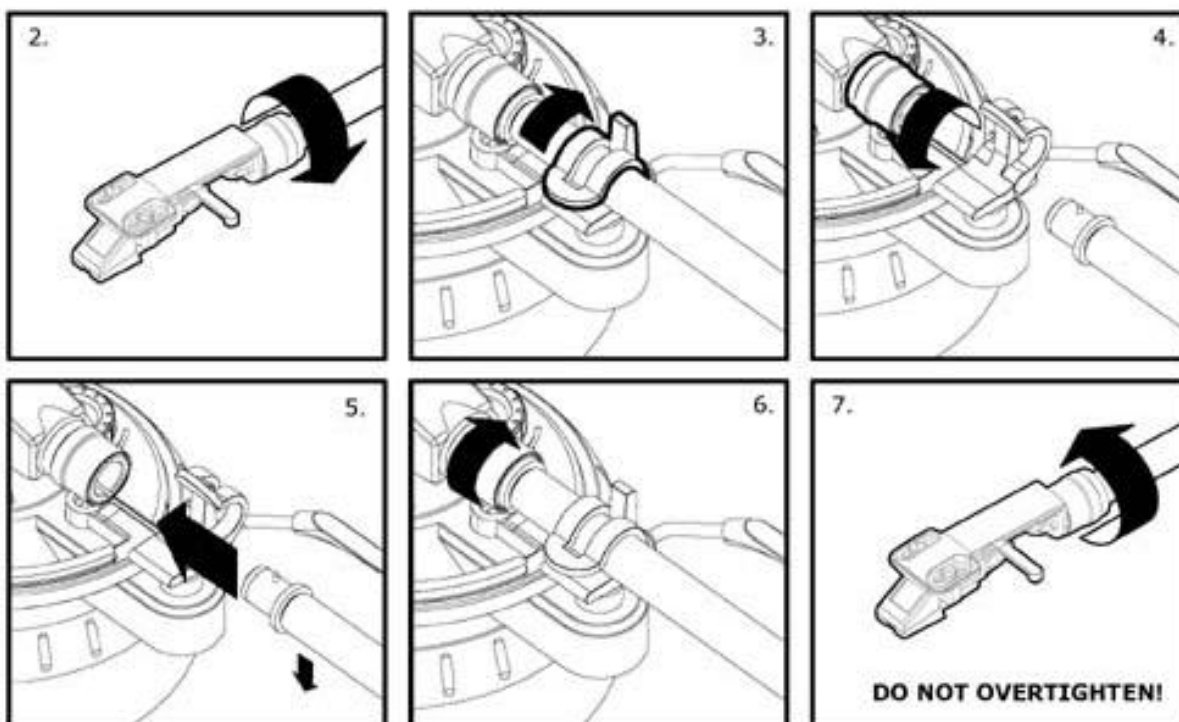

TONE ARM SETUP

A properly adjusted tone arm and cartridge setup will minimize vinyl record wear and optimize the performance of the turntable. Follow these simple steps for setting the tone arm on the turntable:

NOTE: In most cases, when using the S-Shaped tonearm tube, the additional S-Weight must be fastened to the tonearm to achieve proper stylus pressure. Balancing the Tone Arm

1. Begin the balancing process by lifting the cue lever to the up position (or make sure that the stylus protector is on the cartridge.)
2. Next, rotate the counterweight clockwise until it is in the complete forward position (NOTE: this is also the maximum amount of pressure that can be applied to the cartridge.)
3. Now there should be a feeling of weight and resistance when the head shell is raised and lowered. Begin rotating the counterweight counter-clockwise (away from the pivot point) until this weight and resistance feeling is gone. If done properly, the tone arm will pivot with very little resistance back and forth indicating that there is exactly 0 grams of stylus pressure.
4. With the counterweight in its new position further away from tone arm pivot point, grasp the scale ring of the counter weight and rotate it until "0" is in the vertical position.
5. Finally, rotate the counterweight (and scale ring) clockwise (towards the pivot point) until the desired amount of weight is reached. If the scale rotates 360 degrees beyond the zero point, the new scale reading should be added to 3.5.

*The included head shell and cartridge assembly requires a minimum of 3 grams and no more than 5 grams for optimum performance.

Setting the Anti-Skate Adjustment

In most cases, the Anti-Skate should be set to its minimum setting. Anti-Skate compensates for inward tracking forces that occur with certain cartridges when the stylus nears the center of the record. If the turntable is experiencing excessive skipping during back-cueing and scratching while nearing the center spindle, try increasing the Anti-Skate in the increments indicated on the dial. Start by adding an increment of 1, test its performance, than increase it more, and so on.

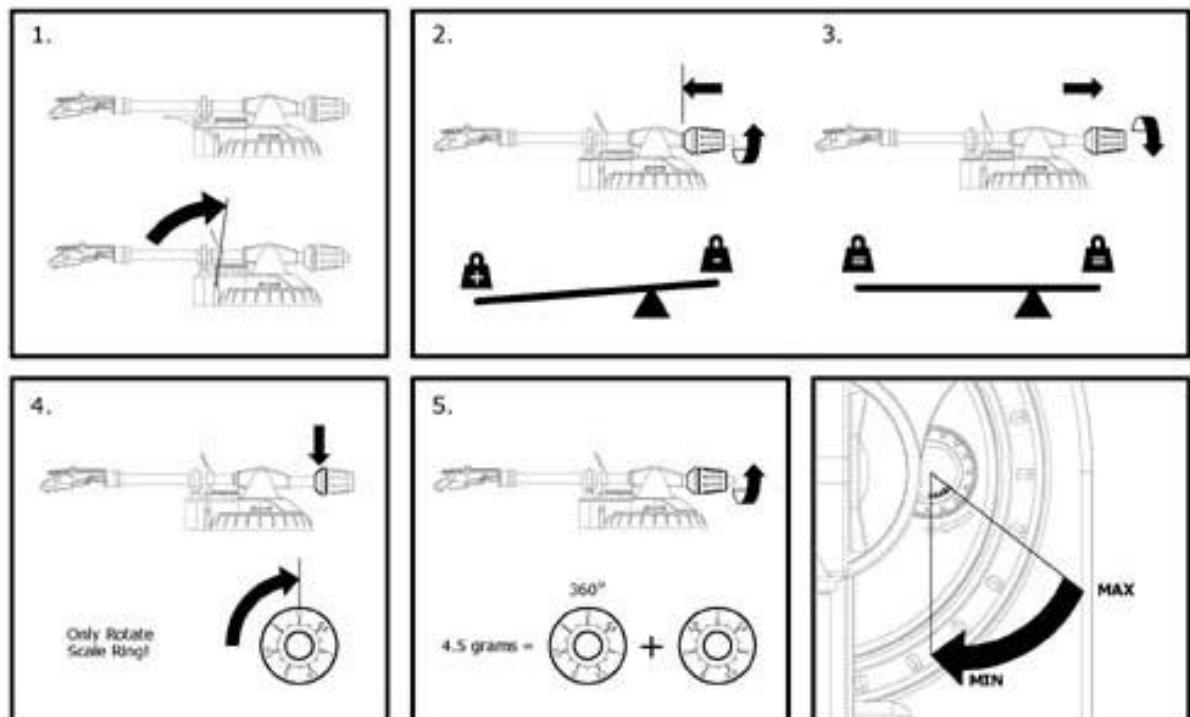

CONTROLS

General Controls

1. Power Button

Pushing this button down turns on the turntable. It illuminates red when the turntable is switched on.

2. Start/Stop Buttons

These buttons start and stop the turntable motor. Both buttons have the same function.

3. Platter

This turntable has a special edge design that has been optimized for "dragged" platter slow downs.

4. Reverse Button

Pushing this button down reverses the rotation direction of the turntable platter.

5. Pitch Slider

This slide control allows the pitch to be increased or decreased by 10%. In the center position the pitch is at 0%. When moved away from the center and towards the tone arm decreases the pitch (slows down the platter) and moving the pitch slider away from the tone arm increase the pitch (speeds up the platter)

6. Target Light

This aluminum target light can be removed and rotated depending on the head shell position and the amount of light required on the vinyl record surface.

7. Target Light Power Jack

This RCA Jack supplies power to the Target Light. IT HAS NO AUDIO FUNCTION-DO NOT CONNECT AUDIO CORDS TO THIS POWER JACK.

8. 33 and 45 RPM Buttons

These buttons control the RPM of the turntable platter. A red LED indicates which RPM mode has been selected. When both the 33 and 45 RPM buttons are pressed, both LED's illuminate indicate 78 RPM mode has been engaged.

9. Quartz Button

The Pitch LED illuminates green when the pitch is set at 0% or the Quartz Button is engaged. When the pitch slider is moved away from zero, the LED illuminates red indicating the pitch is no longer at 0%.

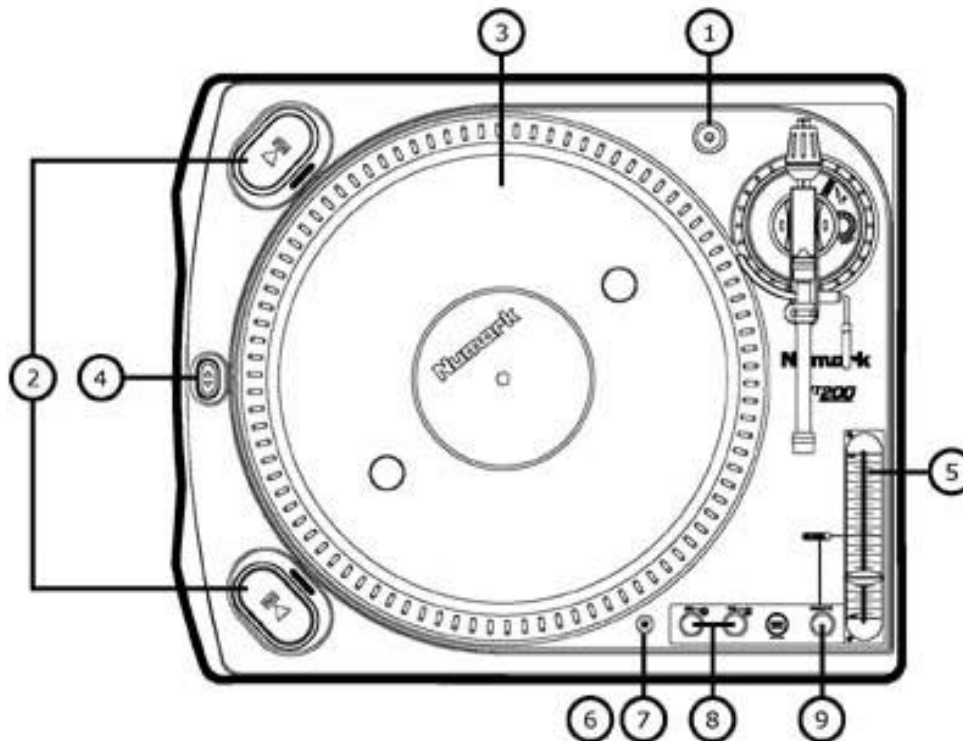

CONTROLS continued

Tone Arm Parts

10. Counterweight and Scale Ring and S-Weight

The Counterweight is used to balance the head shell and cartridge assembly so that the proper amount of stylus pressure is applied to the record. The S-Weight should be used in most cases when the S-Shaped tube is used. It is fastened to the tonearm by threading it into the rear weight balance shaft. The S-weight can be stored below the counterweight in the top cabinet while not in use.

11. Height Adjust Ring

Turning this ring counter-clockwise raises the tonearm up to 6mm to accommodate for different Slipmat thicknesses. This ring can not be adjusted unless the Height Lock Lever (12) is unlocked.

12. Height Lock Lever

Turning this lever towards the direction of the arrow (clockwise) unlocks the Height Adjust Ring (11) so that the tonearm height can be adjusted.

13. Anti-Skate Adjustment

This knob is used to compensate for inward tracking forces. See tonearm setup for more details on its settings.

14. Secondary Tube Lock Collar

This collar is used to secure the tonearm tubes (straight or s-shaped) to the tonearm assembly.

WARNING:

DO NOT OVERTIGHTEN THIS LOCK COLLAR!

WARNING:

CONNECTING HEADSHELLS TO THIS COLLAR MAY DAMAGE THE INTERNAL PIN HEIGHTS OF THE CONTACTS! ONLY CONNECT NUMARK TUBES TO THE SECONDARY TUBE LOCK COLLAR.

15. Arm Clip

This specially designed arm clip secures the tone arm while it is being transported or not in use. The arm clip has been designed to remain in the up position while unlocked.

16. Tonearm Cue System

This cueing system allows the tone arm to be positioned at a certain point above the record and slowly engaged. When the lift lever is in the up position the tone arm should rest on the armrest. When the lift lever is lowered, the tone arm is slowly lowered until the stylus is resting on the record.

17. Tone Arm Lock Nut

This Aluminum nut is used to secure the head shell and cartridge assembly to the tone arm tube. See cartridge setup for more details.

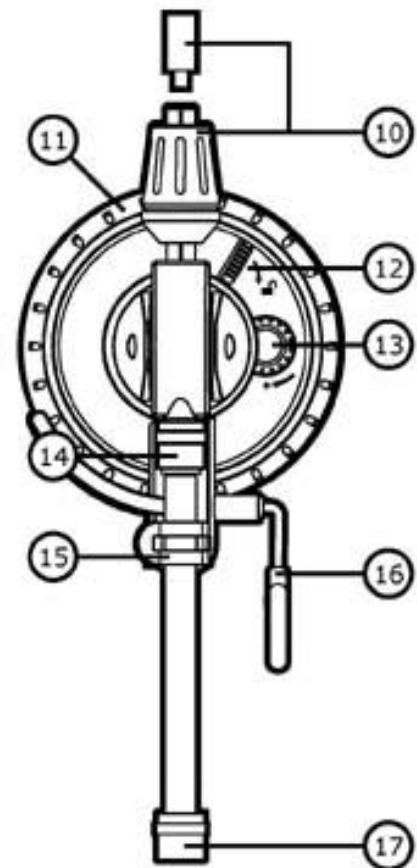

CONTROLS *continued*

Bottom Parts

18. Adjustable Rubber Dampening Feet

When all of the feet of the turntable are completely tightened, the top flat surface of the turntable will be at 85mm. Unscrewing these feet raises the turntable up to compensate for unlevelled surfaces.

19. Carrying Handles

These handles provide a secure grip so that the turntable may be comfortably transported.

20. Voltage Selector Fuse

This rotating Fuse Holder switches the internal voltage transformer between 100V, 120V, 220V and 240V. The turntable should be shipped with the proper voltage setting for your region. Check that the arrow is pointing to the proper voltage before connecting the IEC power cord to prevent damage to the turntable.

21. IEC Power Terminal

This IEC Power Terminal can be used with any IEC power cable, but it is recommended that the supplied IEC power cable be used.

22. RCA Output Jacks

These stereo output jacks allow the turntable to be connected to a compatible device with a PHONO level input.

23. Remote Start Jack (CABLE NOT INCLUDED)

This 3.5mm jack allows the turntable to be remotely started or stopped by a foot switch or other "Lock-Switch" based device. NOTE: This jack may provide undesired results when used with "Fader Start" mixers. Test performance with each device until the desired performance is reached.

24. Ground Screw

This Ground Screw is used to run a ground line between the turntable and the device it is connected to.

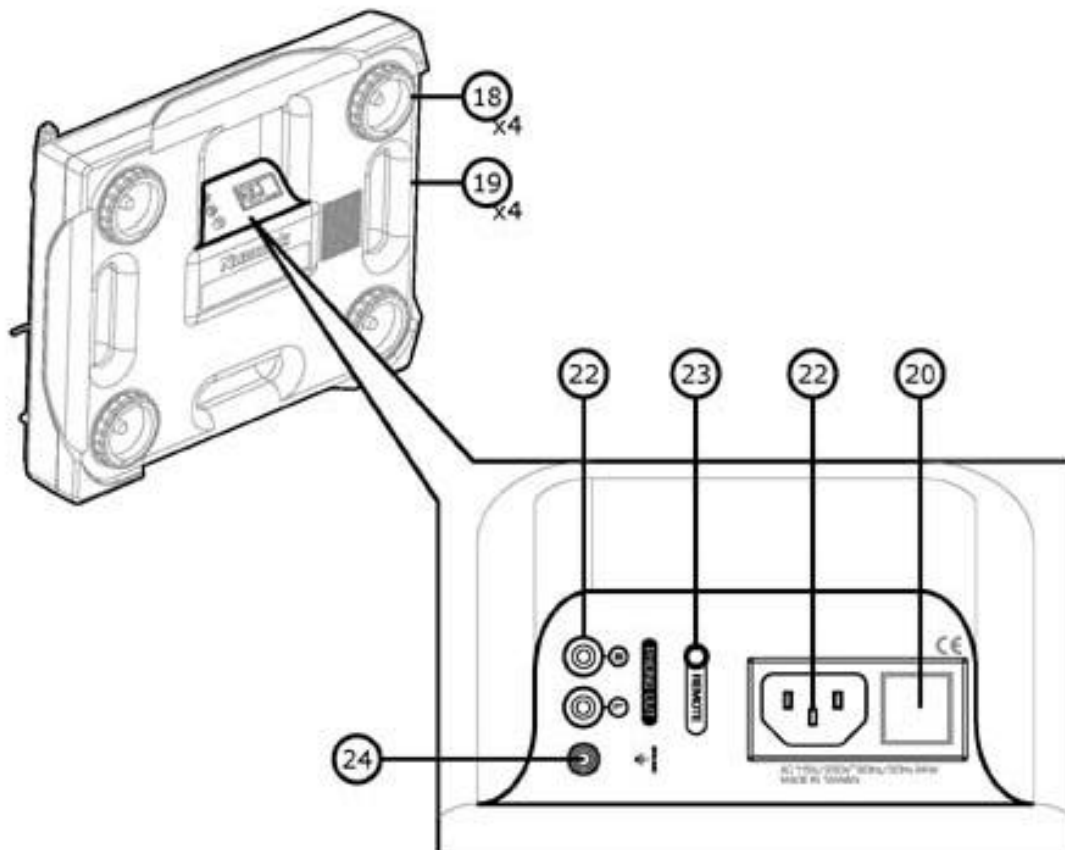

CABLE SETUP

This turntable is shipped with two sets of special cables:

- (1) Right Angle IEC Power Cord
- (1) Right Angle RCA cord w/ground wire

NOTE: Before connecting any cables, make sure that the voltage selector switch is set to the proper setting!

Making the power and audio connections:

1. Begin by lifting the turntable up from the rear handle and resting it on its side. (**NOTE:** The turntable must be supported because it is not stable in this position!)
2. First, using the side of the RCA cable with the Right Angle plugs, slightly loosen the ground screw and slide the ground clip underneath it. Tighten the ground screw against the ground clip so that the cable exits towards the IEC Power Terminal.
3. Next connect the Red Right Angle RCA Plug to the Red RCA jack with the "R" indication.
4. Then connect the White Right Angle RCA Plug to the White RCA jack with the "L" indication.
5. Finally connect the IEC power cord to the IEC Power terminal. It should only fit in the Terminal one way.
6. Rest the turntable back down on a level surface and route the cables to nearby power and audio accessories.

NOTE: When connecting this turntable to a DJ mixer, the ground wire must always be connected to prevent unwanted noise. It is also important that the RCA outputs of the turntable are connected to a mixer (or other preamp device) marked as PHONO or TURNTABLE. This turntable will not work properly if connected to a LINE LEVEL input or CD input.

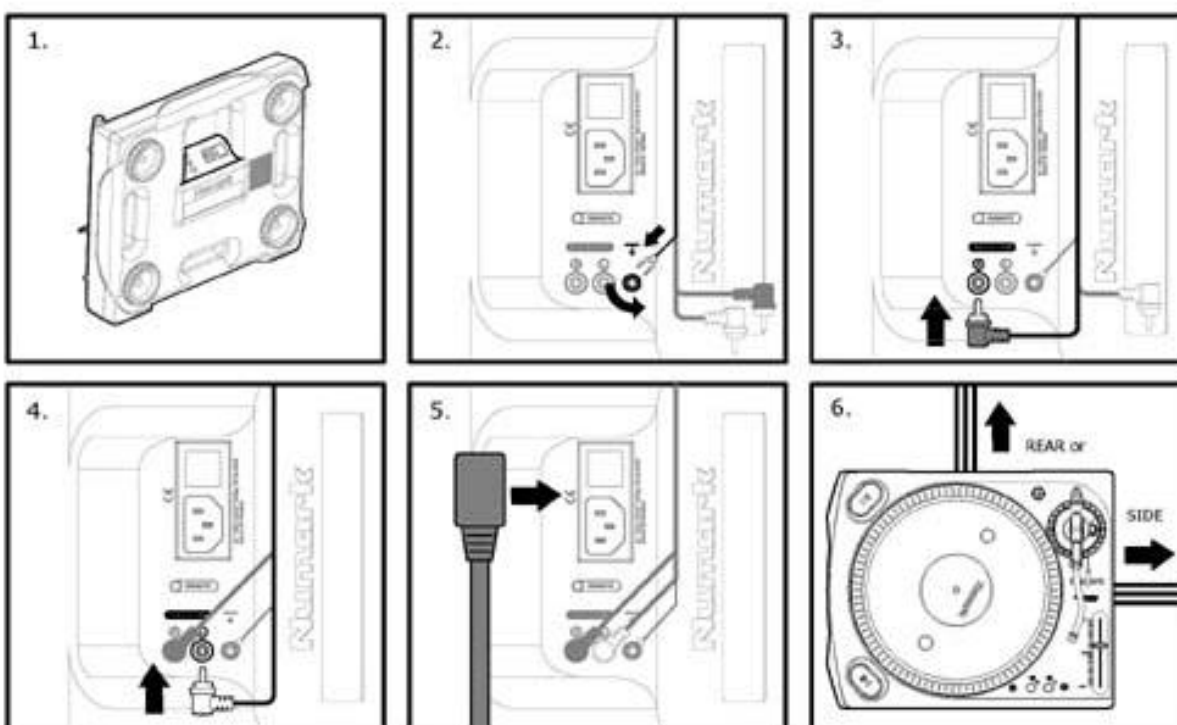

SPECIFICATIONS

Turntable Section:

Type:	3 speed, fully manual
Motor:	Direct Drive- 8 Pole, 3 Phase
Starting Torque:	1.6 kg/cm
Start Time:	0-33.33 RPM in 0.8 sec
Braking System:	Electronic Servo Brake
Platter:	Aluminum Diecast
Speeds:	33.33, 45, and 78 RPM
Wow & Flutter: Separation:	<0.2% WRMS 20 dB
Rumble:	-40dB (IEC 98A Unweighted) -50dB (IEC 98A Weighted)
Power Consumption:	35 Watts
Pitch Range:	+/-10%

Tonearm Section:

Type:	Locking collar based interchangeable tube system Diecast Aluminum 3-bearing construction
Height Range:	0-6 mm
Cue System:	Dampened Lift Lever, Arm Rest and Arm Clip
Weight:	18 lbs (8.2 kg)
Balance Weight:	7 gram S-weight 75 gram Aluminum Plated w/ 0-3.5 gram range scale

General:

Dimensions:	370mm(W) by 460mm(D) by 135mm(H)
Weight:	18 lbs (8.2 g)

OPERATION

This turntable was designed to accommodate a variety of different mixing styles. Here are some general operation guidelines to optimize the performance of the turntable.

1. Do not place the turntable on or near a speaker or subwoofer. This may cause unwanted noise depending on the environment conditions.
2. ALWAYS use the included Slip Mat during record playback. This Slip Mat was designed to reduce friction between the platter and the record to allow for rapid back cueing and efficient scratch play.
3. Using the tone arm Cue System may prevent damage to your stylus. First lift the Cue Lever, then position the tone arm over the desired groove of the record, and finally lower the Cue Lever to slowly drop the tone arm onto the record.
4. Always secure the tone arm using the Arm Clip when not in use. This can prevent stylus damage and accidental tone arm engagement.
5. To reduce needle skipping, follow the guidelines in the Tone Arm Setup section of this manual. Too much weight on a cartridge may cause erratic skipping or stylus damage.

Another guideline that may reduce skipping is back cueing and adjusting playback tempo by applying pressure towards the center of the record near the spindle as indicated below.

Skipping induce by rapid cueing or scratching may be reduce by applying inward pressure to the side of the record instead of applying pressure down on the record (see diagram below.)

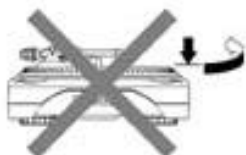

Problem	Cause?	Solution
Turntable does not turn on.	Disconnected Power Cord?	Connect Power Cord.
The sound level is very low.	The Turntable is not connected to a device with a PHONO preamp.	Connect the device to a preamp DJ mixer or an AV receiver that has an input labeled PHONO, not AUX or LINE.
The sound is on one side only.	The Cartridge is not properly wired. The Stylus is worn out. The RCA audio cord is disconnected. The RCA audio cord is damaged.	Reconnect the wires from the headshell to the cartridge. See the "Cartridge Setup" section for more detail. Replace the stylus on the cartridge. Replacement styli are available from most Numark Retailers. Properly secure the RCA cable to the preamp device and the bottom of the turntable. See the "Cable Connections" section for more detail. If the RCA cord is frequently connected and disconnected, it may have become damaged and needs to be replaced.
The output sound is very distorted.	The Cartridge is not properly wired. The Stylus is worn out.	Reconnect the wires from the headshell to the cartridge. See the "Cartridge Setup" section for more detail. Replace the stylus on the cartridge. Replacement styli are available from most Numark Retailers.
The Target Light glows inconsistently, flickers, or doesn't work at all.	The Target Light Lamp is burning or burned out.	Replace the entire target light with a compatible part like the Numark TL-1.
The Output sound exhibits excessive hum or buzzing.	The Turntable Grounding wires are not connected.	Connect the Turntable Ground wires to their respective Grounding Lug on all equipment (mixer, etc.)
The turntable skips like crazy.	The Turntable is on an unstable surface. The Tone Arm is not balanced properly. The Stylus is worn out. Excessive force is being applied directly down on the platter. The record is warped.	Follow the guidelines for installation in the "Setup & Installation" Section. Follow the guidelines for optimum setup in the "Tone Arm Setup" Section. Replace the stylus on the cartridge. Replacement styli are available from most Numark Retailers. Reread the "Operation" section of this manual. Buy new records.

NOTE:

Static electricity and/or other external interference may cause this unit to malfunction. To reset the unit to its normal condition, turn the power off and then on again. If the problem continues to persist, refer to the connected component's troubleshooting guides. If the problem is not resolved after checking these items, contact the nearest authorized Numark dealer.

LIMITED PRODUCT WARRANTY

1. What is covered and for how long? NUMARK INDUSTRIES LCC ("NUMARK") warrants to the original purchaser that NUMARK'S mixers are free from defects in material and workmanship under normal use and service for the period commencing upon the date of purchase from an authorized NUMARK dealer and continuing for the following period of time after that date:

2 Years

3 Years with the completion of the warranty card provided that the warranty card is completed and returned within 30 days from the date of purchase.

2. What is not covered? This Limited Warranty is conditioned upon proper use of the product by the purchaser. This Limited Warranty does not cover:

- (a) Damage caused by improper installation or improper connection to any peripheral
- (b) Damage caused by an external electrical fault
- (c) Damage from use of parts not manufactured or sold by Numark
- (d) Product purchased from anyone other than a Numark authorized dealer
- (e) Modifications to product not approved in writing by Numark
- (f) Equipment that has the serial number removed or made illegible
- (g) Normal cosmetic and mechanical wear
- (h) Damage or loss during transit to an Authorized Numark Repair Center
- (i) Crossfaders

3. What are NUMARK'S obligations? During the applicable warranty period, NUMARK will repair or replace, at NUMARK'S sole option, without charge to the purchaser, any defective component part of the mixer. To obtain service under this Limited Warranty, purchaser must first contact NUMARK and obtain a return authorization number ("RA#"). Purchaser must then return the mixer to NUMARK in an adequate container for shipping, accompanied by purchaser's sales receipt or comparable proof of sale showing the date of purchase, the serial number of the product, and the seller's name and address. To obtain an RA# and assistance on where to return the mixer, contact NUMARK customer service at 401-295-9000. Upon receipt, NUMARK will repair or replace the defective products. NUMARK may, at NUMARK'S sole option, use rebuilt, reconditioned, or new parts or components when repairing any product or replace a product with a rebuilt, reconditioned or new product. Repaired mixers will be warranted for a period equal to the remainder of the original Limited Warranty on the original mixer or for 90 days, whichever is longer. All replaced parts, components, boards and equipment become the property of NUMARK. If NUMARK determines that any mixer is not covered by this Limited Warranty, purchaser must pay all parts, shipping, and labor charges for the repair or return of such mixer.

4. What are the limits on NUMARK'S liabilities? THE WARRANTIES GIVEN IN THIS LIMITED WARRANTY, TOGETHER WITH ANY IMPLIED WARRANTIES COVERING NUMARK MIXERS, INCLUDING WITHOUT LIMITATION ANY WARRANTIES OF MERCHANTABILITY OR FITNESS FOR A PARTICULAR PURPOSE, ARE LIMITED TO THE DURATION OF THIS LIMITED WARRANTY. EXCEPT TO THE EXTENT PROHIBITED BY APPLICABLE LAW, NUMARK SHALL NOT BE LIABLE FOR ANY SPECIAL, INCIDENTAL, CONSEQUENTIAL, INDIRECT OR SIMILAR DAMAGES, LOSS OF PROFITS, DAMAGES TO PURCHASER'S PROPERTY, OR INJURY TO PURCHASER OR OTHERS ARISING OUT OF THE USE, MISUSE OR INABILITY TO USE ANY NUMARK MIXER, BREACH OF WARRANTY, OR NEGLIGENCE, INCLUDING BUT NOT LIMITED TO NUMARK'S OWN NEGLIGENCE, EVEN IF NUMARK OR ITS AGENT HAS BEEN ADVISED OF SUCH DAMAGES, OR FOR ANY CLAIM BROUGHT AGAINST PURCHASER BY ANY OTHER PARTY. THIS LIMITED WARRANTY IS THE COMPLETE WARRANTY FOR NUMARK'S MIXERS, AND IS GIVEN IN LIEU OF ALL OTHER EXPRESS WARRANTIES. THIS LIMITED WARRANTY SHALL NOT EXTEND TO ANYONE OTHER THAN THE ORIGINAL PURCHASER OF THIS PRODUCT AND STATES PURCHASER'S EXCLUSIVE REMEDY. IF ANY PORTION OF THIS LIMITED WARRANTY IS ILLEGAL OR UNENFORCEABLE BY REASON OF ANY LAW, SUCH PARTIAL ILLEGALITY OR UNENFORCEABILITY SHALL NOT AFFECT THE ENFORCEABILITY OF THE REMAINDER OF THIS LIMITED WARRANTY WHICH PURCHASER ACKNOWLEDGES IS AND WILL ALWAYS BE CONSTRUED TO BE LIMITED BY ITS TERMS OR AS LIMITED AS THE LAW PERMITS.

This Limited Warranty allocates risk of product failure between purchaser and NUMARK, and NUMARK'S product pricing reflects this allocation of risk and the limitations of liability contained in this Limited Warranty. The agents, employees, distributors, and dealers of NUMARK are not authorized to make modifications to this Limited Warranty, or make additional warranties binding on NUMARK. Accordingly, additional statements such as dealer advertising or presentation, whether oral or written, do not constitute warranties by NUMARK and should not be relied upon.

5. How does state law apply to this warranty? SOME STATES DO NOT ALLOW THE EXCLUSION OR LIMITATIONS OF INCIDENTAL OR CONSEQUENTIAL DAMAGES OR HOW LONG AN IMPLIED WARRANTY LASTS, SO THE ABOVE LIMITATIONS OR EXCLUSIONS MAY NOT APPLY TO PURCHASER.

This Limited Warranty gives you specific legal rights. You may also have other rights, which vary from one jurisdiction to another.

NUMARK INDUSTRIES
Attention: Service Department
11 Helmsman Avenue
North Kingstown, RI 02852 USA
Phone: 1 (401) 295-9000
Fax: 1 (401) 295-5200

Web: www.numark.com

RETURN INFORMATION (US ONLY)

- a) A Return Authorization number must be obtained from Numark through the address or phone numbers below.
- b) A copy of the original sales receipt must also be included for the equipment to be repaired under warranty.
- c) The faulty equipment must be packed in its original packaging.
- d) One additional outer layer of packaging must be included to ensure product safety. Failure to do so may inadequately protect the equipment in transit and, therefore, jeopardize the customer's warranty.
- e) Numark will not accept COD shipments and no call tags will be issued for merchandise return.
- f) Numark will not return repaired merchandise to customers by priority service, unless by written request at the customer's cost. Requests must be submitted in writing with merchandise returned.
- g) The defective Numark equipment should be sent, FREIGHT PREPAID with Return Authorization number clearly printed on the outer packaging and original sales receipt enclosed to:

NUMARK INDUSTRIES
Attention: Service Department
11 Helmsman Avenue
North Kingstown, RI 02852 USA
Phone: 1 (401) 295-9000
Fax: 1 (401) 295-5200
Web: www.numark.com

INSIDE THE BOX:



*(1) TT-200 w/Straight
Tonearm*

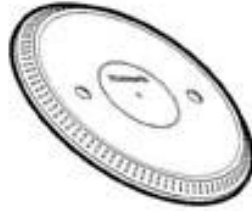

(1) Aluminum Platter

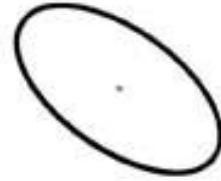

(1) Slipmat



(1) Headshell



*(1) 2.5 Gram Headshell
Weight*



*(1) Target Light
Weight*



*(1) 45 RPM Adapter
Weight*



*(1) S-Shaped Tonearm
Tube*



(1) Counter Weight



*(1) S-Tube Tonearm
Weight*



(1) IEC Power Cable



*(1) RCA Cord w/
Ground Wire*



(1) Service Tool

Free Manuals Download Website

<http://myh66.com>

<http://usermanuals.us>

<http://www.somanuals.com>

<http://www.4manuals.cc>

<http://www.manual-lib.com>

<http://www.404manual.com>

<http://www.luxmanual.com>

<http://aubethermostatmanual.com>

Golf course search by state

<http://golfingnear.com>

Email search by domain

<http://emailbydomain.com>

Auto manuals search

<http://auto.somanuals.com>

TV manuals search

<http://tv.somanuals.com>