

atom 2.0



Wireless

personal

dive

watch

computer

operating

manual

OCEANIC®

Download from Www.Somanuals.com. All Manuals Search And Download.

NOTICE

STORAGE and INITIAL ACTIVATION

Beginning with firmware revision 2E, ATOM Watch/Dive Computers are placed in a Deep Sleep mode prior to being shipped from the factory. The intent is to extend storage life of the Battery for up to 7 years, before the unit is initially placed in service.

In this mode, Date and Time are updated as they normally would be. However, they are not displayed. Upon waking the ATOM up, the correct Date and Pacific Time will be displayed and it will be ready to operate with full functions.

To wake the ATOM up from Deep Sleep mode, simultaneously depress the upper/right (S) and lower/left (A) buttons for 2 to 3 seconds until the display comes full ON displaying the MAIN TIME screen, then release them.

△ NOTE: Once the ATOM is brought out of the Deep Sleep mode, it can only be placed back in it by the factory.

CONTENTS

WARRANTY, NOTICES, DECOMPRESSION MODEL	7
FULL DISPLAY	8
INTRODUCTION AND GENERAL FEATURES AND DISPLAYS	9
INTERACTIVE CONTROL CONSOLE	10
OPERATING MODE STRUCTURE	11
OPERATION AS A DIVE COMPUTER	12
PC INTERFACE	13
SYMBOLS AND ALPHA NUMERIC GRAPHICS	13
AUDIBLE ALARM	14
BACKLIGHT	16
POWER SUPPLY	16
WATCH FEATURES AND DISPLAYS	19
LOCAL DEFAULT TIME	20
MAIN TIME	21
SET MAIN TIME	22
ALTERNATE TIME	25
SET ALTERNATE TIME	26
COUNTDOWN TIMER	27
SET COUNTDOWN TIMER	28
CHRONOGRAPH	29
DAILY ALARM	31
SET DAILY ALARM	32
DIVE COMPUTER FEATURES AND DISPLAYS	33
BAR GRAPH	34
ALPHA / NUMERIC DISPLAYS	36
Tank Pressure Display	36
Depth Displays	36
Time and Date Displays	37
Temperature Display	38

CONTENTS (continued)

DIVE COMPUTER SURFACE SEQUENCE AND OPERATING MODES	39
SURFACE MODE	40
Normal Surface Main Display	41
Normal Surface Main Button Operations	43
ATOM Battery Status	44
Transmitter Status	45
Normal Surface Secondary Display	45
Normal Surface Alternate Display	46
NORMAL AND GAUGE SURFACE SET MODES	47
SET F GROUP (FO2)	47
Set FO2 for NORM Nitrox Dives	48
Set FO2 GAS 1	50
Set FO2 GAS 2	51
Set FO2 GAS 3	52
Set FO2 50% Default	53
SET A GROUP (NORM/GAUG ALARMS)	54
Set Audible Alarm	55
Set Depth Alarm	56
Set EDT (Elapsed Dive Time) Alarm	57
Set TLBG (Tissue Loading Bar Graph) Alarm	58
Set DTR (Dive Time Remaining) Alarm	59
Set Turn Pressure Alarm (TMT1)	60
Set End Pressure Alarm	61
Set PO2 Alarm	62
SET U GROUP (UTILITIES)	63
Set Wet Activation	64
Set Units of Measure	65
Set NORM Safety Stop	66
Set Conservative Factor	67
Set Backlight Duration	68
Set Sampling Rate	69

CONTENTS (continued)

Set TMT1 (Transmitter 1 Link Code)	70
Set TMT (Transmitter) 2-3 Use	72
Set TMT2 (Transmitter 2 Link Code)	73
Set TMT3 (Transmitter 3 Link Code)	75
SERIAL NUMBER (ATOM)	77
NORM (Normal Dive) PLAN MODE	78
FLY MODE	81
SAT MODE (NORM)	82
NORM/GAUG LOG MODE	83
HISTORY MODE (NORM/GAUG)	87
OVERVIEW OF DIVE MODE INFORMATION	91
POSITIONING OF THE ATOM	93
Link Interruption Underwater	93
DIVE TIME REMAINING (DTR)	94
No Decompression Dive Time Remaining (NDC)	95
Oxygen Accumulation Time Remaining (OTR)	96
Air Time Remaining (ATR)	96
Air Time Remaining Alarm	97
VARIABLE ASCENT RATE	98
ELAPSED DIVE TIME	99
CONTROL OF DISPLAYS	99
NORM TYPE DIVE MODES (AIR/NITROX)	101
WET CONTACTS	102
NORM NO DECOMPRESSION DIVE MODE	103
NORM Dive No Deco Safety Stop	106
DECOMPRESSION DIVE MODE	107
VIOLATION MODES	111
HIGH PO2	116
HIGH OXYGEN ACCUMULATION	117
SUMMARY OF WARNING AND ALARM MESSAGES	118

CONTENTS (continued)

SWITCHING GAS MIXES AND BUDDY PRESSURE CHECK	119
SWITCHING GAS MIXES (NORM ONLY)	120
BUDDY PRESSURE CHECK (NORM ONLY)	125
NORM POST DIVE MODES	129
TRANSITION PERIOD	130
AFTER THE TRANSITION PERIOD	131
GAUGE OPERATING MODE	133
GAUG SURFACE DISPLAYS	134
GAUG DIVE DISPLAYS	135
FREE DIVE OPERATING MODE	137
FREE SURFACE DISPLAYS	138
FREE COUNTDOWN TIMER (CDT)	140
SET FREE CDT	142
SET FREE ALARMS (EDT, FDA)	143
FREE DIVE DISPLAYS	148
REFERENCE	153
UPLOADING SETTINGS AND DOWNLOADING DATA	154
CARE AND CLEANING	156
INSPECTIONS AND SERVICE	156
BATTERY REPLACEMENT	158
INSTALLING A TRANSMITTER ON A REGULATOR	164
TRANSMITTER COMPATIBILITY WITH NITROX	164
ALTITUDE SENSING AND ADJUSTMENT	165
CHARTS OF NO DECOMPRESSION LIMITS AT ALTITUDE	166
CHART OF OXYGEN EXPOSURE LIMITS	167
SPECIFICATIONS	168
INSPECTION/ SERVICE RECORD	174
OCEANIC WORLD WIDE	175

LIMITED TWO-YEAR WARRANTY

For details, refer to the Product Warranty Registration Card provided. Register on-line at www.OceanicWorldwide.com

COPYRIGHT NOTICE

This operating manual is copyrighted, all rights are reserved. It may not, in whole or in part, be copied, photocopied, reproduced, translated, or reduced to any electronic medium or machine readable form without prior consent in writing from Oceanic / 2002 Design.

ATOM 2.0 Operating Manual, Doc. No. 12-2698

© 2002 Design, 2005

San Leandro, CA USA 94577

TRADEMARK, TRADE NAME, AND SERVICE MARK NOTICE

Oceanic, the Oceanic logotype, the Oceanic 'O' symbol, ATOM, the ATOM 2.0 logo, Air Time Remaining (ATR), Diver Replaceable Batteries, Graphic Diver Interface, Tissue Loading Bar Graph (TLBG), Pre Dive Planning Sequence (PDPS), Set Point, Control Console, Turn Gas Alarm, and OceanLog are all registered and unregistered trademarks, trade names, and service marks of Oceanic. All rights are reserved.

PATENT NOTICE

U.S. Patents have been issued, or applied for, to protect the following design features: Air Time Remaining (U.S. Patent no. 4,586,136 and 6,543,444) and Data Sensing and Processing Device (U.S. Patent no. 4,882,678). Set TLBG Alarm and other patents pending. User Setable Display (U.S. Patent no. 5,845,235) is owned by Suunto Oy (Finland).

DECOMPRESSION MODEL

The programs within the ATOM simulate the absorption of nitrogen into the body by using a mathematical model. This model is merely a way to apply a limited set of data to a large range of experiences. The ATOM dive computer model is based upon the latest research and experiments in decompression theory. **Still, using the ATOM, just as using the U.S. Navy (or other) No Decompression Tables, is no guarantee of avoiding decompression sickness, i.e. "the bends."** Every diver's physiology is different, and can even vary from day to day. No machine can predict how your body will react to a particular dive profile.

! Pay special attention to items marked with this Warning symbol.

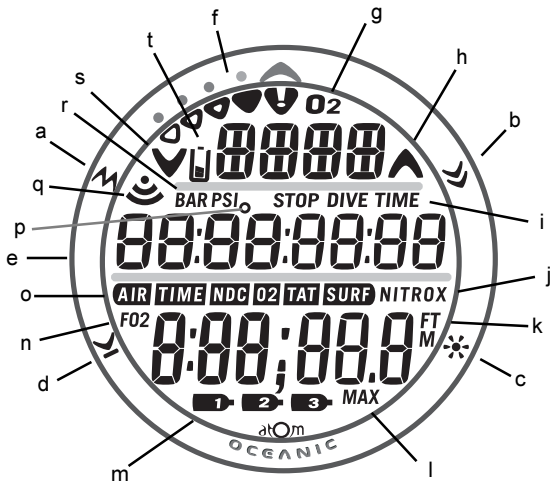

Components:

- a. Mode (M) Button
- b. Select (S) Button
- c. Light (L) Button
- d. Advance (A) Button
- e. LED Warning Light
- f. Bar Graph
- g. Icon - indicates O2BG
- h. Icon - Ascend Arrow
- i. Symbol - STOP TIME
DIVE TIME
- j. Symbol - NITROX (Mode)
- k. Symbol - FT or M (Depth)
- l. Symbol - MAX
- m. Icons - Tank 1, 2, 3
- n. Symbol - FO2
- o. Symbols - AIR TIME
TIME NDC
TIME O2
TIME TAT
TIME SURF
- p. Icon - degrees (Temperature)
- q. Icon - Daily Alarm, or -
Transmitter Link
- r. Symbol - PSI or BAR (Pressure)
- s. Icon - Descend Arrow
- t. Icon - Low Battery

ATOM 2.0 FULL LCD



WARNING: Prior to diving with the **ATOM 2.0**, you must also read and understand the **Oceanic Dive Computer Safety and Reference Manual**, Doc. No. 12-2262, which provides **Important Warnings and Safety Recommendations** as well as general product information.

INTRODUCTION AND GENERAL FEATURES AND DISPLAYS

INTRODUCTION

Welcome to OCEANIC and thank you for choosing the ATOM 2.0 !

It is extremely important that you read this Operating Manual in sequence and understand it completely before attempting to use the ATOM 2.0 as a dive computer.

It is equally important that you read the Oceanic Dive Computer Safety and Reference Manual (Doc. No. 12-2262) provided with your ATOM 2.0. It contains information that you must become familiar with prior to diving with your ATOM 2.0.

Remember that technology is no substitute for common sense, and a dive computer only provides the person using it with data, not the knowledge to use it.

INTERACTIVE CONTROL CONSOLE

The Interactive Control Console consists of four Control Buttons that allow you to select mode options and access specific information. They are also used to link the Transmitter(s), enter Settings, activate the Backlight, and acknowledge the Audible Alarm.

Throughout this manual they will be referred to as the M, S, L, and A buttons.

- Upper/Left - Mode (M) button
- Upper/Right - Select (S) button
- Lower/Right - Light (L) button
- Lower/Left - Advance (A) button

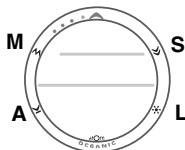

OPERATING MODE STRUCTURE

Unless it is operating in Dive Computer mode, the ATOM will be ON in the default WATCH MAIN TIME (home time) mode (Fig. 1), like a standard WATCH, until the Mode is changed.

The M button is used to access 4 other Modes that include Alternate Time Mode, Countdown Timer, Chronograph (stop watch/lap timer), and Daily Alarm. It is also used to revert to the Local Default Time display and access Computer Modes.

The screens of the Main Modes and Sub Modes will remain on display until a button is pressed to access another screen or Mode, activate a sequence, or for 2 minutes if no button is pressed. The Chronograph remains on display as long as it is running unless another Mode is accessed.

When Wet Activation is set On, the ATOM 2.0 will enter selected Dive Mode upon descent to 5 FT (feet)/1.5 M (meters), regardless of what operating Mode it is in.

⚠ WARNING: When Wet Activation is set OFF, the ATOM 2.0 must be in Dive Surface Mode (NORM < GAUG, or FREE prior to the first dive of a new series. Commencing a dive while in Watch modes will not activate Dive Mode unless Wet Activation is set ON.

<u>Main Sequence</u> (while at home) Main Time Alternate Time Countdown Timer Chronograph Daily Alarm
<u>Alternate Sequence</u> (at a travel location) Alternate Time Main Time (home) Countdown Timer Chronograph Daily Alarm



Fig. 1 - MAIN TIME

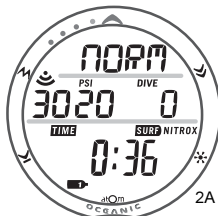

2A

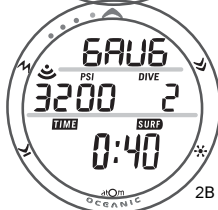

2B

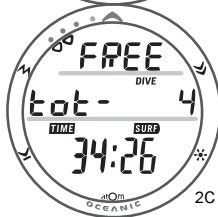

2C

OPERATION AS A DIVE COMPUTER

The ATOM 2.0, hereafter referred to as the ATOM, features 3 Dive Computer (DC) Operating Modes, NORM (Fig. 2A) which is used for Air and Nitrox dives, GAUG (Fig. 2B) used for dives in which Nitrogen-Oxygen calculations are not performed, and FREE (Fig. 2C) used for activities that do not use SCUBA.

Entering Settings and Plan Mode are only available in NORM SURF Mode which also allows access to Battery/Transmitter Status, Fly, Desat, Log, and History Modes. Tank Pressure is displayed if a Transmitter is active and Linked with the ATOM.

GAUG Mode only allows access to Battery/Transmitter Status, Fly, Log, and History Modes. It also displays Tank Pressure.

FREE Mode only allows access to ATOM Battery Status, Log, and History Modes. It does not display Tank Pressure.

Once a dive is made in GAUG Operating Mode, the ATOM is locked into that Mode for 24 hours after the dive.

The ATOM also features 2 modes for use of Transmitter Pressure. A setting allows you to choose whether Transmitters 2 and 3 are for your use (SELF) or for checking 1 or 2 Buddies' Tank Pressure(s). The setting remains fixed until changed in the NORM/GAUG SET U menu.

Fig. 2 - DC MODES

PC INTERFACE

Interface with a PC is accomplished by connecting the ATOM to a PC USB Port using the USB Interface Cable provided. The same Cable is used for Upload and Download.

The software program is on the CD provided, together with a USB Driver. The program's Help serves as the user manual and can be printed for personal use. The Settings Upload program is used to check the ATOM's existing Settings and for entering Time, Alarm, and Dive Computer settings into the ATOM. The Data Download program is used to retrieve Data that was sampled during dives and stored in the ATOM's memory.

The ATOM checks for an External Access request once every second while in the Watch Main Time. Checks are not made if the unit is WET. For a connection to be made, the Interface Cable is clipped onto the ATOM's Data Port and plugged into a PC USB Port. To establish the connection, the PC program must be running. When the connection is made, all segments of the ATOM appear on the display until completion of the Upload or Download operation.

- The ATOM reverts to the Watch Main Time screen after completion of the Upload or Download operation, or after 2 minutes if no PC action was taken.

SYMBOLS AND ALPHA NUMERIC GRAPHICS

The upper line of digits on the LCD screen is used to convey alpha Messages such as Day of the Week, Operating Modes, items being Set, Gas and Transmitter identification, Altitude level, and Alarm identification. At times, the second line is also used to display alpha numeric graphics such as PO2 and On/Off. The FO2 setting of a selected Gas will appear in the lower line.

AUDIBLE ALARM

Most warning situations that activate the Audible Alarm while operating in NORM or GAUG Mode cause the ATOM to emit 1 beep per second for 10 seconds, or until the situation is corrected, or it is acknowledged by momentarily pressing and releasing the S button (less than 2 seconds). After being acknowledged and the situation corrected, the Alarm will sound again upon reentry into the warning situation, or entry into another type of warning situation.

FREE Dive Mode has its own set of Alarms which emit 3 short beeps either 1 or 3 times which cannot be acknowledged or set Off.

A red LED Warning Light, located on the left side of the housing, is synchronized with the Audible Alarm. It will flash as the Audible Alarm sounds. It will turn Off when the Alarm is acknowledged or the situation is corrected. The Audible and LED will not be active if the Alarm is Set OFF (a group A setting).

Situations that will activate the NORM/GAUG 10 second Alarm include -

- Air Time Remaining (ATR) at 5 minutes, then again at 0 minutes.
- ATR becomes less than No Deco and O₂ Time Remaining for 1 minute.
- Turn Pressure at the Set Point selected (Transmitter 1).
- End Pressure at the Set Point selected (active Transmitter).
- Descent deeper than the Max Depth Set Point selected.
- Dive Time Remaining at the Set Point selected.
- Elapsed Dive Time at the Set Point selected.
- High PO₂ of 1.60 ATA or the Set Point selected.
- High O₂ of 300 OTU (single or daily exposure).

- Tissue Loading Bar Graph at the segment Set Point selected.
- NORM/GAUG Ascent Rate exceeds 60 FPM (18 MPM) when deeper than 60 FT (18 M), or 30 FPM (9 MPM) at 60 FT (18 M) and shallower.
- Loss of the active Transmitter Link signal for more than 15 seconds during a dive.
- Entry into Decompression Mode (Deco).
- Conditional Violation (above a required Deco Stop Depth for less than 5 minutes).
- Delayed Violation (above a required Deco Stop Depth for more than 5 minutes).
- Delayed Violation (a Deco Stop Depth greater than 60 FT/18 M is required).
- Delayed Violation (Maximum Operating Depth of 330 FT/100 M is exceeded).
- A Gas Switch to another tank would expose the diver to PO₂ greater than 1.60 ATA.

A single short beep (which cannot be disabled) is emitted for the following -

- Upon completion of a Hot Swap battery change.
- Change from Delayed to Full Violation 5 minutes after the dive.

3 short beeps (which cannot be disabled) are emitted for the following -

- NORM/GAUG Ascent Rate is 51 to 60 FPM (15.1 to 18 MPM) when deeper than 60 FT (18 M), or 26 to 30 FPM (7.5 to 9 MPM) at 60 FT (18 M) and shallower.
- Air Time Remaining becomes less than No Deco and O₂ Time Remaining.
- FREE Dive Elapsed Dive Time Alarm (3 beeps every 30 seconds if set On).
- FREE Dive Depth Alarms 1/2/3 (set sequentially deeper) - each 3 beeps 3 times.
- FREE Dive TLBG Alarm (Caution zone, 4 segments) - 3 beeps 3 times.
- Entry into Deco during a FREE Dive (Permanent Violation) - 3 beeps 3 times.
- Watch Daily Alarm reaches time set (disabled during Dive Modes).
- Watch or Free Dive Mode Countdown Timer reaches 0:00 - each 3 beeps 3 times.

During the following NORM Dive situations, the 10 second continuous tone will be followed by a 5 second steady beep that will not turn off when acknowledged -

- Ascending above a required Decompression Ceiling Stop Depth for more than 5 minutes (referred to as a Delayed Violation).
- Decompression requires a Ceiling Stop Depth of 70 FT/21 M or deeper.
- Being on the Surface for 5 minutes after a Conditional Violation (Permanent Violation).

BACKLIGHT

To activate the Backlight - press the L button.

- The Backlight will activate and illuminate the display for button depression time* plus the user set Duration time of 0, 5, or 10 seconds, for a maximum of 20 seconds. (*The Backlight will turn Off if the button is held depressed for more than 10 seconds.)
- Press the button again to activate as desired.

 **NOTE: Extensive use of the Backlight reduces estimated Battery life. Also, the Backlight does not operate during a Low ATOM Battery Condition or when the ATOM is connected to a PC.**

POWER SUPPLY

The ATOM (Watch) utilizes one 3 volt CR2430 Lithium Battery. When used as a Dive Computer, the ATOM's battery should operate normally for 1 year or 300 dive hours if 2 dives are conducted during each dive period. The ATOM checks its battery voltage every 2 minutes during surface operation.

- If voltage of the ATOM decreases to the Warning level (2.75 volts), the Battery icon will appear on Surface display screens (fig. 3a) as an indication that the Battery should be changed prior to commencing a series of dives.
- If the ATOM's voltage decreases to the Alarm level (2.50 volts), the Battery icon will flash and the message CHNG > BATT will scroll at the top of the display (Fig. 4). Operation will automatically revert to Main Time Mode. The ATOM would then only operate in Watch modes until the Battery becomes completely depleted.
- Low Battery Warning/Alarm conditions are not displayed during Dive Modes.
- If a Low Battery Condition was not displayed prior to starting a Dive, and a Low Battery Condition occurs during the dive, there will be sufficient Battery power remaining to maintain operation for the remainder of that dive.

Transmitters use one 3 volt, CR2 Lithium Battery. A Transmitter's battery should provide normal operation for 1 year or 300 dive hours. Transmitters check battery voltage when they are pressurized and will send a Low Battery signal to the Receiver in the ATOM when the voltage drops below the Warning level.

- Transmitter Low Battery Warning/Alarm conditions are only displayed on Status screens that can be accessed while viewing the NORM Surface Display.



Fig. 3 - LOW BATTERY WARNING

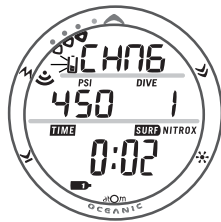

Fig. 4 - LOW BATTERY ALARM



Fig. 5 - ATOM BATT GOOD



Fig. 6A - TMT 1 BATT LOW



Fig. 6B - TMT 3 BATT
(Not Available)

To check the condition of the ATOM or a Transmitter's Battery if NORM or GAUG Mode is selected, depress the S button for 2 seconds while viewing the NORM, GAUG, or FREE Surface Main Display, then release it.

- As the button is depressed, the ATOM's Receiver will activate, if in NORM or GAUG Mode.
- 2 seconds later, the ATOM's Battery status will be displayed for 3 seconds (Fig. 5), then -
- if active and linked, Transmitter 1's Battery status will be displayed for 3 seconds (Fig. 6A), then -
- if active and linked, Transmitter 2's Battery status will be displayed for 3 seconds, then -
- if active and linked, Transmitter 3's Battery status will be displayed for 3 seconds, then -
- the display will then revert to Surface Mode.
- If a Transmitter is not active and linked, the message NotAvAil (not available) will be displayed (Fig. 6B).

Tank Pressure (described later) will also appear on the active Transmitters Battery Status displays.

△ NOTE: If Transmitter 2-3 Use is set for BUD (Buddy Pressure Check), Battery Status of those Transmitters is not displayed (only Pressure).



WARNING: Prior to diving with the ATOM, you must also read and understand the Oceanic Dive Computer Safety and Reference Manual, Doc. No. 12-2262, which provides Important Warnings and Safety Recommendations as well as general product information.

WATCH FEATURES AND DISPLAYS



Fig. 7 - MAIN TIME

LOCAL DEFAULT TIME

Watch Main Time (Fig. 7) is the current Time at your home location and is normally selected as the Local Default Time.

The normal Watch screen sequence accessed with momentary presses (less than 2 seconds each) of the M button is -

Main Time > Alternate Time > Countdown Timer >
Chronograph > Daily Alarm

Watch Alternate Time (Fig. 8), which is set by Hour Differential, is the current Time at a remote travel location. Upon arrival at the location, Alternate Time can be interchanged with Main Time to make it the Local Default Time while visiting the travel location.

The M button will then access the screens in this sequence -

Alternate Time > Main Time > Countdown Timer >
Chronograph > Daily Alarm



Fig. 8 - ALTERNATE TIME

While viewing Alternate Time, depressing and holding the S button for 2 seconds will replace Main Time with Alternate Time that will then become the Local Default Time until changed.

While viewing any of the Watch Mode displays, pressing and holding the M button for 2 seconds or if no button is pressed for 2 minutes, operation will revert to the Watch Time screen selected to be the Local Default Watch Time (Main or Alternate).

MAIN TIME, information displayed includes:

- > Tissue Loading Bar Graph, if any after NORM/FREE dives.
- > Alarm icon - if the Daily Alarm is its set On (Fig. 9a)
- > Day of the Week graphic MON (or TUE, WED, THU, FRI, SAT, SUN), or the graphic WET (if the unit is wet).
- > Battery icon - if a Low Battery Condition exists.
- > Month and Day (Day and Month if set for Metric)
- > Time of Day (hours, minutes, seconds*)
(*seconds appear in the middle row, Fig. 9b)

- Pressing and releasing the M button momentarily and repeatedly (< 2 seconds each time) will step through the Main Modes.
- Pressing and releasing the S button (< 2 seconds) will silence and acknowledge the Daily Alarm (if set On and it sounds).
- Pressing the L button will activate the Backlight.
- Pressing both the A and S buttons simultaneously for 2 seconds will access the SET MAIN TIME Mode.

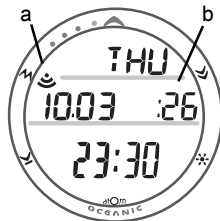

Fig. 9 - MAIN TIME
(24 Hour Format)

SET MAIN TIME

This Mode allows the Date and Time of Day to be set which will also serve as the basis for ALTERNATE TIME values.

There are 3 Time Set screens - Set Hour Format, Set Time of Day, and Set Date.

△ NOTE: MAIN TIME must be selected as the Local Default Time in order to set the Time and Date.

Sequence of Time/Date settings:

Hour Format screen > Time screen (Hour > Minute) > Date screen (Year > Month > Day)

Day of the Week is set automatically when the Date is set.

- Depressing and holding the M button at any time for 2 seconds and if no button is pressed during a period of 2 minutes, the unit will revert to the MAIN TIME screen.

While the MAIN TIME screen is being displayed, pressing the A and S buttons simultaneously for 2 seconds will access the **Set Hour Format** screen displaying the graphic HOUR, symbol TIME, and the Hour Format Set Point 12 or 24 flashing (Fig. 10).



Fig. 10 - SET HOUR
FORMAT

- Pressing and releasing the S button momentarily (< 2 seconds) will toggle the flashing setting between 12 and 24.
- Pressing the A button momentarily (< 2 seconds) will save the Hour Format Set Point and access the SET TIME screen with the HOUR Set Point flashing (Fig. 11).
- HINT - Pressing the A button repeatedly (< 2 seconds each time) will step through the Time/Date Settings, bypassing those that don't require setting.



Fig. 11 - SET HOUR

Set Hour and Minute

The graphic Am or Pm displayed when Time in 12 Hour Format.

- Depressing and holding the S button while the HOUR Set Point is flashing will scroll through the Set Points in 1 Hour increments at a rate of 4 per second from 12: Am to 11: Pm (or 0: to 23: if set for 24 Hour Format).
- Pressing and releasing the A button momentarily (< 2 seconds) will save the Hour Set Point and/or advance to SET MINUTE with the MINUTE Set Point flashing (Fig. 12).
- Depressing and holding the S button while the MINUTE Set Point is flashing will scroll through the Set Points in 1 minute increments at a rate of 4 per second from :00 to :59.
- Pressing and releasing the A button momentarily (< 2 seconds) will save the Minute Set Point and/or advance to the SET DATE screen with the YEAR Set Point flashing.



Fig. 12 - SET MINUTES



Fig. 13 - SET YEAR

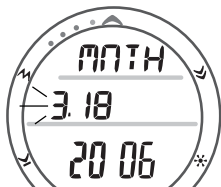

Fig. 14 - SET MONTH



Fig. 15 - SET DAY

Displayed on the **SET DATE** screen will be the graphic YEAR, Month and Day (or Day and Month if set for metric) with the **YEAR** Set Point flashing (Fig. 13).

- Depressing and holding the S button while the YEAR Set Point is flashing will scroll through the Set Points in 1 year increments at a rate of 4 per second from 2006 to 2049 (with leap year corrections).
- Pressing and releasing the A button momentarily (< 2 sec) will save the Year Set Point and/or advance to **SET MONTH** with the Set Point flashing and the graphic MNTN (Fig. 14).

△ NOTE: The YEAR will not be displayed in any Mode other than SET DATE. The DATE will reset to 1.1 2006 when the Battery is replaced.

- Depressing and holding the S button while the MONTH Set Point is flashing will scroll through the Set Points in 1 month increments at a rate of 4 per second from 1 to 12.
- Pressing and releasing the A button momentarily (< 2 seconds) will save the Month Set Point and/or advance to **SET DAY** with the Set Point flashing and the graphic DAY (Fig. 15).

- Depressing and holding the S button while the **DAY** Set Point is flashing will scroll through the Set Points in one day (01) increments at a rate of 4 per second from 1 to 31.
- Pressing and releasing the A button momentarily (< 2 seconds) will save the Set Point and/or advance to the MAIN TIME screen.

△ NOTE: DAY of the WEEK is set automatically based upon the Date that has been set.

ALTERNATE TIME

- Pressing and releasing the M button momentarily 1 time (< 2 seconds) while the MAIN TIME screen is displayed will access the ALTERNATE TIME screen.

Information provided includes (Fig. 16):

- > Tissue Loading Bar Graph, if any after NORM/FREE dives.
- > Alarm icon (solid) - if the Daily Alarm is set On.
- > Lazy 8 symbol (Fig. 16a) identifies Time as Alternate Time.
- > Day of the Week graphic MON (or TUE, WED, THU, FRI, SAT, SUN), or WET (if the unit is wet).
- > Battery icon, if an ATOM Low Battery Condition exists.
- > Month and Day (Day and Month if set for Metric).
- > Time of Day (hour, minute, seconds).

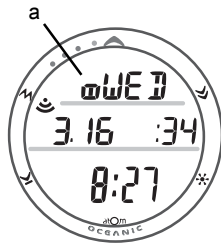

Fig. 16 - ALTERNATE TIME

Main Time/Date can also be set using the PC Settings Upload program included on the ATOM's OceanLog software CD.

Prior to shipment from the factory, any error of the ATOM's Main Time is determined and corrected.

- Pressing and releasing the M button momentarily and repeatedly (< 2 seconds) will step through the other Main Watch Modes.
- Pressing and releasing the S button (< 2 seconds) will silence and acknowledge the Daily Alarm (if its set and it sounds).
- Depressing the S button for 2 seconds will interchange ALTERNATE TIME with MAIN TIME making ALTERNATE TIME the Local Default Time screen.
- Pressing the L button will activate the Backlight.
- Pressing and holding the M button for 2 seconds will revert to the MAIN TIME screen.
- Depressing both the A and S buttons simultaneously for 2 seconds will access the SET ALTERNATE TIME Mode with the Set Point flashing.



Fig. 17 - SET ALTERNATE TIME

SET ALTERNATE TIME

- ALTERNATE TIME can be set OFF, or to an Hour based numeric time Differential ranging from + 1 through +23 through - 23 through -1 (hours).
- Once the Differential is selected and saved, ALTERNATE Time/Date values will be based upon the MAIN TIME Set Points plus/minus the Differential.

Displayed will be the Lazy 8 symbol and graphic OFF, or the +/- numeric Hour Differential Set Point flashing (Fig. 17).

- Depressing and holding the S button while the Set Point is flashing will scroll through the Set Points in increments of 1 Hour at a rate of 4 per second.
- Pressing and releasing the A button momentarily (< 2 seconds) will save the Set Point and/or advance to the ALTERNATE TIME screen.
- Depressing and holding the M button for 2 seconds will revert to the MAIN TIME screen.

If no button is pressed during a period of 2 minutes, the unit will revert to the MAIN TIME screen.

WATCH COUNTDOWN TIMER (HR:MIN)

Pressing the M button momentarily 2 times (< 2 seconds each) while the Local Default Time screen is displayed will access the Countdown TIMER screen, displaying the remaining Countdown Time (hr:min) if running, or OFF flashing (Fig. 18) and the previously set Countdown Time (hr:min) if the set Countdown started and has ended, or OFF (solid) and 0:00 if no time was previously set.

Once set ON, a Countdown will run in the background until it counts down to 0:00, or it is set OFF, or a Dive is made at which time it will default to OFF and the value previously set.

FREE Dive Mode has a separate Min:Sec Countdown Timer.



Fig. 18 - WATCH COUNT-DOWN TIMER

When a set Countdown Time reaches 0:00, the Audible Alarm will beep 10 times and the red LED warning light will flash.

- Pressing and releasing the S button (< 2 seconds) will acknowledge and silence the Alarm.
- Pressing and releasing the S button (< 2 seconds) will silence and acknowledge the Daily Alarm (if its set and it sounds).
- Pressing the L button will activate the Backlight.
- Depressing and holding the M button for 2 seconds will revert to the Local Default Watch Time screen (MAIN or ALTERNATE TIME).
- Depressing both the A and S buttons simultaneously for 2 seconds will access the **SET WATCH COUNT DOWN TIMER** screen indicated by the graphics TIMR and SET, symbol TIME, and HOUR Set Point flashing (Fig. 19).
- If no button is pressed during a period of 2 minutes, the unit will revert to the Local Default Watch Time screen.
- Depressing and holding the S button while the **HOUR** Set Point is flashing will scroll through the Set Points in 1 hour increments at a rate of 4 per second from 0: to 23: (hr).
- Pressing and releasing the A button momentarily (< 2 seconds) will save the HOUR Set Point and/or advance to **SET MINUTES** with the MINUTES Set Point flashing.

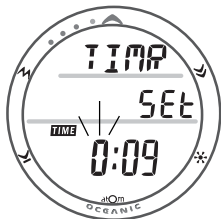

Fig. 19 - SET WATCH CDT

- Depressing and holding the S button while the MINUTES Set Point is flashing will scroll through the Set Points in 1 minute increments at a rate of 4 per second from :00 to :59 (min).
- Pressing and releasing the A button momentarily (< 2 seconds) will save the MINUTES Set Point and/or advance to the COUNTDOWN TIMER screen indicated by the graphic OFF (flashing) in place of the graphic SET.
- Pressing and releasing the S button momentarily (< 2 seconds) will toggle from OFF to ON and Start the Timer (Fig. 20).
- Depressing and holding the M button for 2 seconds will revert to the Local Default Watch Time screen.
- If no button is pressed during a period of 2 minutes, the unit will revert to the Local Default Watch Time screen.



Fig. 20 - CD TIMER STARTED

CHRONOGRAPH (Stop Watch/Lap Timer)

- Pressing and releasing the M button momentarily 3 times (< 2 seconds each) while the MAIN TIME screen is displayed will access the CHRONOGRAPH displaying the elapsed time if previously started or 0:00:00.00 (hr:min:sec.1/100th sec), flashing (Fig. 21).
- Pressing and releasing the S button momentarily (< 2 seconds) will start the TIMER which will begin counting up from 0:00:00.00 to 99:59:59.99 (hr:min:sec.1/100th sec) in increments of .01 (1/100th sec).



Fig. 21 - CHRONOGRAPH

- During the first 4 seconds the 1/100th second values will be displayed, then 2 dashes (. - -) will be displayed. The 1/100th values will be recorded and displayed when LAPs are frozen and when later recalled.
- Subsequent pressing and releasing of the S button (< 2 seconds each) will freeze Lap Times (LAP1 through LAP9). After 9 Laps are recorded, additional LAPs will replace LAP9, shift the others to lower LAP numbers, while discarding LAP1.
- If is Timer reaches 99:59:59.99 hr:min:sec.1/100 sec), it will stop and save that number as a LAP. Subsequent presses of the S button will then have no effect.
- Pressing and releasing the A button momentarily (< 2 seconds) will Stop the Timer and Recall LAP1, displaying the graphic LAP1 (flashing) and the LAP 1 Time. Repeat presses will display other LAPs/Times (Fig. 22).
- Depressing and holding the A button for 2 seconds will stop the Timer and reset the Time to 0:00:00.00 (flashing).
- Pressing and releasing the M button momentarily (< 2 seconds) will advance to DAILY ALARM.
- Depressing and holding the M button for 2 seconds will revert to the Local Default Watch Time screen.



Fig. 22 - LAP RECALL

While the Chronograph is running, it will remain on the screen until a button operation is performed. If another screen is accessed, it will then continue to run in the background.

Upon descending on a dive, the Chronograph operation will be terminated and reset to 0:00:00.0.

DAILY ALARM

When set ON, the DAILY ALARM will sound the Audible Alarm and flash the Red LED at the Time set every day.

- Pressing the M button momentarily 4 times (< 2 seconds each time) while the MAIN TIME screen is displayed will access the DAILY ALARM STATUS screen.

DAILY ALARM STATUS, information provided includes (Fig. 23):

- > Alarm icon
 - > Graphics ALRM and ON (or OFF), flashing.
 - > Alarm Time Set Point (hr:min).
-
- Pressing and releasing the S button momentarily (< 2 seconds) will toggle between ON and OFF.
 - Upon being toggled to ON, the Alarm will be set to sound every day at the Time indicated.
 - Depressing both the A and S buttons simultaneously for 2 seconds will access the SET DAILY ALARM screen allowing a new Time to be set.
 - Depressing and holding the M button for 2 seconds will revert to the Local Default Watch Time screen.
 - Pressing the L button will activate the Backlight.



Fig. 23 - DAILY ALARM

- If no button is pressed during a period of 2 minutes, the unit will revert to the Local Default Watch Time screen.

SET DAILY ALARM, information provided includes (Fig. 24):

- > Alarm icon
 - > Graphics ALRM and SET.
 - > Alarm Time previously set (hr:min) with the HOUR Set Point flashing.
- Depressing and holding the S button while the **HOUR** Set Point is flashing will scroll through the Set Points in 1 hour increments at a rate of 4 per second from 12: Am to 11: Pm (or 0: to 23: if 24 hour format). The graphic Am or Pm will be displayed when setting Time in 12 Hour Format.
 - Pressing and releasing the A button momentarily (< 2 seconds) will save the HOUR Set Point and/or advance to SET MINUTE with the Set Point flashing.
 - Depressing and holding the S button while the **MINUTE** Set Point is flashing will scroll through the Set Points in 1 minute increments at a rate of 4 per second from :00 to :59.
 - Pressing and releasing the A button momentarily (< 2 seconds) will save the MINUTE Set Point and/or advance to the DAILY ALARM screen indicated by the graphic ON (or OFF) flashing.
 - Depressing and holding the M button for 2 seconds will revert to the Local Default Watch Time screen.



Fig. 24 - SET DAILY ALARM



WARNING: Prior to diving with the ATOM, you must also read and understand the Oceanic Dive Computer Safety and Reference Manual, Doc. No. 12-2262, which provides Important Warnings and Safety Recommendations as well as general product information.

DIVE COMPUTER FEATURES AND DISPLAYS

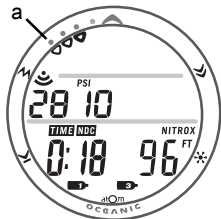

Fig. 25 - TLBG

BAR GRAPH

The ATOM features one shared Bar Graph that represents either nitrogen loading, or when accessed, oxygen accumulation. By default the Bar Graph (Fig. 25a), referred to as the Tissue Loading Bar Graph (TLBG), represents your relative no decompression or decompression status.

As your Depth and Elapsed Dive Time increase, segments will add to the TLBG, and as you ascend to shallower depths, the segments of the TLBG will begin to recede, indicating that additional no decompression time is allowed.

The Tissue Loading Bar Graph monitors 12 different nitrogen compartments simultaneously and displays the one that is in control of your dive. It consists of 5 segments, the lower 4 represent No Decompression status and the fifth at the top indicates a Decompression condition.

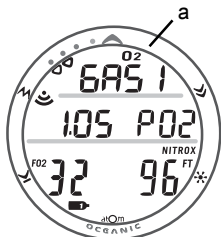

Fig. 26 - O2BG

When the ATOM is set to operate in NORM Nitrox mode, the Bar Graph will represent oxygen accumulation when the oxygen data screen (Alternate Display) is accessed temporarily. The O₂ icon (Fig. 26a) will appear as an indication.

Regardless of which parameter the Bar Graph is representing at the time, nitrogen (if NORM or FREE) and oxygen (if NORM) calculations will continue to be performed in the background.

Displays associated with oxygen and the O2 Bar Graph will be displayed if FO2 for any Gas (1, 2, or 3) has been set at a value other than 'Air' (e.g., a numerical value) and the Alternate screen that displays oxygen related data is accessed.

When the oxygen data screen is accessed during a NORM dive, the Bar Graph will show the maximum of either per dive accumulated oxygen or 24 hour period accumulated oxygen.

As your oxygen exposure (accumulation) increases during a NORM dive, segments will add to the O2 Bar Graph, and as saturation decreases, it will begin to recede, indicating that additional exposure is allowed for that dive and 24 hour period.

The ATOM will store oxygen accumulation calculations for up to 10 dives conducted during a 24 hour period. If the maximum limit for NORM dive oxygen loading has been exceeded for that day (24 hour period), all of the segments of the O2 Bar Graph will be displayed flashing (Fig. 27).

Depth/Time values will not appear in Plan Mode until the O2 Bar Graph recedes into the normal zone (lower 4 segments) indicating that your daily oxygen dosage has decreased an amount equivalent to the amount accumulated during the latest dive completed.

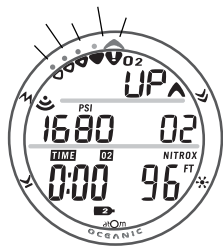

Fig. 27 - O2 EXCEEDED

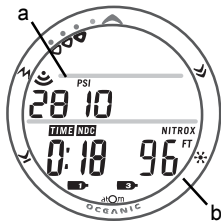

Fig. 28 - DIVE MAIN

While you cannot provide a guarantee against the occurrence of decompression sickness, you may choose your own personal zone of caution based upon age, physique, excessive weight, etc., to reduce the statistical risk.

Within the available NORM Mode parameters that can be set (described later) are a TLBG Alarm and a Conservative Factor which if set ON reduces No Decompression times allowed.

FREE Dive Mode has a separate (fixed) TLBG Alarm.

ALPHA / NUMERIC DISPLAYS

Tank Pressure Display (NORM/GAUG only)

When the ATOM's Receiver is set ON and active, Tank Pressure from the active Transmitter that is properly linked will be displayed on the NORM or GAUG MAIN screens (Fig. 28a).

Values of Pressure are displayed numerically from 000 PSI (00 BAR) up to 5,000 PSI (345 BAR) in increments of 5 PSI (1 BAR).

Depth Displays (all Modes)

During dives, the **Current Depth** display (Fig. 28b) and **Maximum Depth** which is accessed as an Alternate Display (Fig. 29a) indicate Depths from 0 to 330 FT (100 M) in increments of 1 FT (.1 M).

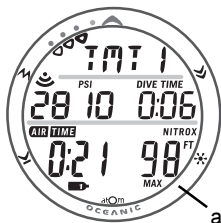

Fig. 29 - DIVE ALTERNATE

During a No Decompression Safety Stop, the set **Stop Depth** (Fig. 30a) is displayed and during a Decompression condition, the required **Ceiling Stop Depth** is displayed.

Time and Date Displays

Time of Day and NORM/GAUG Mode displays are shown in hour:minute format (i.e., 1:16 represents 1 hour and 16 minutes, not 116 minutes!). **FREE Dive Mode displays** are shown in minute:second format. The colon that separates hours and minutes (minutes and seconds) blinks once per second when the display is indicating real time (e.g., Surface Interval, Elapsed Dive Time), and is solid (non-blinking) when times are calculated projections (e.g., Time to Fly, Plan).

The **Primary Time** display, at the bottom of the screen, has the largest digits of the display (Fig. 30b). Another **time** display (Fig. 30c) is located in the middle row. Both displays are identified by the symbol TIME.

When the ATOM is operating in Dive Computer mode, **Date** is displayed only to identify dives when they are accessed in the LOG Mode (Fig. 31). When Units of Measure are set for Imperial, Month appears to the left of Day (Fig. 31a) separated by a decimal point (month.day). When set for Metric units, the Month appears to the right of Day (day.month).

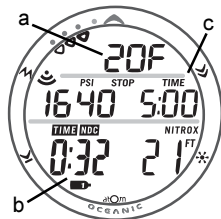

Fig. 30 - NO DECO SAFETY STOP

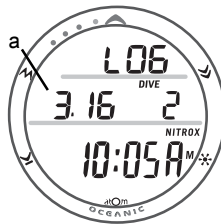

Fig. 31 - LOG PREVIEW

Temperature Display

Ambient Temperature can be viewed on the surface and during dives by accessing a Secondary Display (Fig. 32a).

The lowest Temperature recorded during each NORM/GAUG dive is recorded in the LOG for that dive.

△ NOTE: Each display represents unique pieces of information. It is imperative that you understand the formats, ranges, and values of the information represented to avoid any possible misunderstanding that could result in error.

You must also understand the icons, symbols, and alpha/numeric messages presented.

The Informational Displays are described in detail as the various operating modes they appear in are presented throughout this manual.

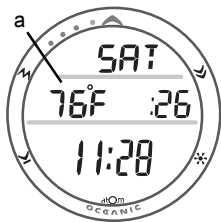

Fig. 32 - TEMPERATURE
(Secondary Display)





WARNING: Prior to diving with the ATOM, you must also read and understand the Oceanic Dive Computer Safety and Reference Manual, Doc. No. 12-2262, which provides Important Warnings and Safety Recommendations as well as general product information.

DIVE COMPUTER SURFACE SEQUENCE AND OPERATING MODES

DIVE COMPUTER (DC) OPERATING MODES

As described on page 12, the ATOM features 3 selectable DC Operating Modes -

- NORM - for Normal Air or Nitrox dives
- GAUG - for dives with no Nitrogen/Oxygen calculations
- FREE - for dives with no SCUBA

△ REMINDER: Once a dive is made in GAUG Mode, the ATOM is locked into that Mode for 24 hours after the dive.

SURFACE MODE

Pressing and holding the M button for 2 seconds while the Local Default Watch TIME screen is displayed (Main Time or Alternate Time, whichever was selected as the Default) accesses the selected SURFACE MODE screen (NORM, GAUG, or FREE).

If no dive has been taken within the past 24 hours, the NORM SURF MAIN screen will appear as the default (Fig. 33).

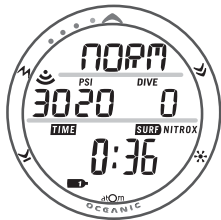

Fig. 33 - NORM SURF MAIN
(no dive made)

- The GAUG and FREE SURF MAIN screens can be accessed by subsequent 2 second presses of the M button.
- The Operating Mode selected (NORM, GAUG, or FREE) will remain on display for 2 hours until a dive is made or another Operating Mode is selected.

If a dive has been conducted within the past 24 hours, the SURF MAIN screen for that Operating Mode (NORM, GAUG, or FREE) will be displayed.

At any time while operating in Surface Modes, the ATOM will enter Dive Mode upon descent to 5 FT (1.5 M).

- During the 2 hour pre dive surface period, if the M button is pressed to access other screens in the Watch Mode sequence, Surface Mode must again be accessed prior to the first dive of a series (if WET ACTIVATION is set OFF).
- When WET ACTIVATION is set ON, the Wet Contacts will activate the selected Dive Mode regardless of what Mode the ATOM is operating in at the time of the descent.

The ATOM will enter POST DIVE SURFACE MODE following a dive upon ascent to 4 FT (1.2 M). The Surface Interval Time colon will flash during the first 10 minutes after a NORM/GAUG dive (Fig. 34), or 1 minute after a FREE dive.

During the first 10 minutes after a dive, the SURF MAIN screen for the Operating Mode selected prior to the dive (NORM, GAUG, or FREE) remains on display as the Default SURF MAIN screen. Main Watch Time can be viewed for 3 seconds during that period by pressing and releasing the M button momentarily (less than 2 seconds).

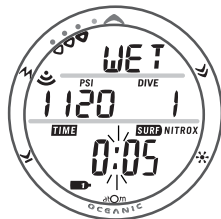

Fig. 34 - NORM SURFACE MODE
(Post Dive Unit WET)

When the 10 minute Surface Time has elapsed, the Local Default Watch TIME screen (Main or Alternate Time) will replace the Surface Mode display. The SURF MAIN screen can then be accessed by pressing the M button for 2 seconds.

NORM SURF MAIN, information provided includes (Fig. 35):

- > LINK symbol, if the Receiver is successfully Linked with a Transmitter. (Note that this is the same icon used in Watch Mode to signify that the Daily Alarm is set On.)
- > Graphic NORM alternating with the Altitude Level graphic SEA (or EL2 through EL13) and WET (if the unit is wet), each On 3 seconds then 1/4 second blank.
- > Battery icon if an ATOM Low Battery Warning Condition exists, flashing if Too Low
- > Tank Pressure and symbol PSI (or BAR), if the Receiver is successfully Linked with an active Transmitter.
- > Symbol DIVE and Number of that dive (0 if no dive has been made yet).
- > Symbols TIME and SURF, and Surface Interval Time (hour:minutes) .
- > NITROX symbol, if any GAS is set for a Nitrox dive.
- > Tank 1 icon representing GAS 1, which is the default start Gas and default Gas 10 minutes after a dive.
- > Tissue Loading Bar Graph (TLBG), if any after a NORM or FREE dive.

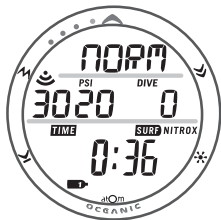

Fig. 35 - NORM SURF MAIN

NORM SURF MAIN - Button Operations:

- Pressing the L button will activate the Backlight.
- Pressing and releasing the A button repeatedly (< 2 seconds each time) will step through the NORM Surface Sequence -

SURF > PLAN > FLY > SAT > LOG > HISTORY.

- Depressing and holding the A button for 2 seconds will access the Surface Secondary Display for 3 seconds followed by the Surface Alternate Display for 3 seconds.
- Depressing both the A and S buttons simultaneously for 2 seconds will access the SET Menu (F > A > U) and an ATOM Serial Number display.

SURF > SET FO2 > SET Alarms > SET Utilities > SN

- Pressing and holding the M button for 2 seconds will access the GAUG SURF MAIN screen, then another 2 second press will access the FREE SURF MAIN screen.

NORM SURF > GAUG SURF > FREE SURF

- Pressing and releasing the M button momentarily (< 2 seconds) will revert to the Watch TIME screen.

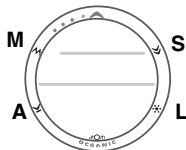

Upper/Left - Mode (M)
Upper/Right - Select (S)
Lower/Right - Light (L)
Lower/Left - Advance (A)

Button Locations



Fig. 36 - ATOM BATT GOOD

- Depressing and holding the S button for 2 seconds while viewing the NORM Surface screen will activate the ATOM's Receiver and access a series of screens that will indicate the Status of the system's Batteries and Pressures of the Tanks in use. Transmitter Battery Status is not displayed for TMT 2 and 3 if TMT 2-3 USE is set for BUD (Buddy Check).
- If a Transmitter is not active and linked to the ATOM, the message NotAvAil (Not Available) will appear.
- Each screen will be displayed for 3 seconds. ATOM Battery Status, then Transmitter 1 Battery Status and Tank Pressure, then Transmitter 2 Battery Status and Tank Pressure, then Transmitter 3 Battery Status and Tank Pressure.
- The screen will then revert to NORM SURF MAIN Display.



Fig. 37 - ATOM BATT LOW

ATOM BATTERY STATUS, information includes (Fig. 36/37):

- > Graphics ATOM and bAt
- > Graphic Good or Lo
- > Battery icon, if a Low Battery Warning Condition exists. Flashing if an Alarm Condition exists.

Transmitters (referred to as TMTs) that are active and Linked will transmit signals conveying Tank Pressure and Battery Status for display on the Status screens. If a TMT is not active or active but not Linked, the Status screen(s) will display Not Available.

TRANSMITTER STATUS, information includes:

- > Graphics TMT1 (then TMT2 and TMT3), identifying the reporting Transmitter, and bAt.
- > Graphic Good or Lo, or NotAvAil (Fig. 38A/38B)
- > Battery icon, if a Low Battery Warning Condition exists. Flashing if an Alarm Condition exists.
- > Link icon and Tank Pressure for the TMT reporting and symbol PSI (or BAR).

△ NOTE: If TMT 2-3 USE is set for BUD (Buddy Pressure Checks), TMT2 and TMT3 screens will not display Battery Status (only Pressure).

NORM SURF SECONDARY, information includes (Fig. 39):

- > Day of the Week graphic (SAT, SUN, MON, TUE, WED, THU, FRI).
- > Temperature with degree icon and graphic F (or C)
- > Time of Day (hour: minute), seconds (:xx) on middle row.
- After 3 seconds, the NORM SURF ALTERNATE screen will appear.
- Pressing and releasing the A button momentarily (< 2 seconds) will revert to the NORM SURF MAIN screen.
- Pressing the L button will activate the Backlight.

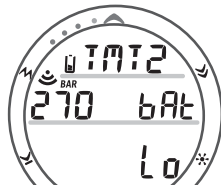

Fig. 38A - TMT2 BATT LOW



Fig. 38B - TMT3 BATT (Not Available)



Fig. 39 - NORM SURF SEC

NORM SURF ALTERNATE, information includes (Fig. 40):

- > Bar Graph representing Oxygen accumulation with the O2BG icon.
- > LINK symbol, if the ATOM's Receiver is successfully Linked with a Transmitter.
- > Altitude Level graphic SEA (or EL2 through EL13).
- > Battery icon if an ATOM Low Battery Warning Condition exists, flashing if Too Low
- > Tank Pressure and symbol PSI (or BAR), if the Receiver is successfully Linked with an active Transmitter.
- > Symbol DIVE and Number of that dive.
- > GAS 1 FO2 Set Point and symbol FO2.
- > NITROX symbol, if any GAS is set for a Nitrox dive.
- > Tank 1 icon representing GAS 1, which is the default start Gas and default Gas 10 minutes after a dive.

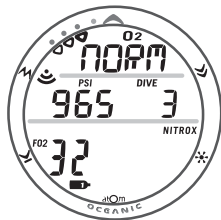

- The display will revert to the NORM SURF MAIN screen after 3 seconds.
- Pressing and releasing the A button momentarily (< 2 seconds) will revert to the NORM SURF MAIN screen.
- Pressing the L button will activate the Backlight.

GAUG and FREE Operating Modes are described in separate sections after NORM Mode.

Fig. 40 - NORM SURF ALT

NORM AND GAUG SURFACE SET MODES

NORM/GAUG Set Mode Sequence:

SURF MAIN > SET F > SET A > SET U > ATOM Serial Number.

Access and step through of the sequence is gained by repeated simultaneous 2 second presses of the A and S buttons.

Alarms (Set A) and Utilities (Set U) Set Points can also be set/changed using the PC Settings Upload program. FO2 (Set F) entries must be made using only the push buttons.

SET F GROUP (FO2)

Set F Sequence:

SET F > FO2 GAS 1 > FO2 GAS 2 > FO2 GAS 3 > FO2 50% Default.

- > Depressing the A and S buttons simultaneously for 2 seconds while the NORM or GAUG SURF MAIN screen is displayed will access SET F identified by the graphic SETF (Fig. 41).
- > Pressing and releasing the A button momentarily (< 2 seconds) while SET F is displayed will advance to SET FO2 (GAS 1) with the Set Point flashing.

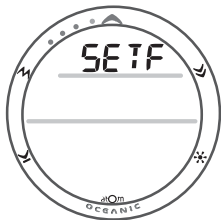

Fig. 41 - SET F

The ATOM reverts to the last Settings entered/saved when 24 hours elapse without a dive or after a dive.

Setting FO2 for NORM Nitrox Dives:

For each value of FO2, the Maximum Operating Depth (MOD) that can be achieved for the PO2 Alarm Set Point limit previously set, will be displayed.

When the FO2 50% DEFAULT is set ON and FO2 GAS 1 is set for a numerical value, 10 minutes on the surface after that dive, the FO2 for GAS 1 will be displayed as 50 and further dives will be calculated based on 50% O2 for oxygen calculations and 21% O2 for Nitrogen calculations (79% Nitrogen) unless the FO2 for GAS 1 is set before the dive.

FO2 for GAS 1 continues to reset to the FO2 50% DEFAULT after subsequent repetitive dives until 24 hours elapse after the last dive, or the FO2 50% DEFAULT is turned OFF in the Set FO2 50% DEFAULT ON/OFF MODE.

When the FO2 50% DEFAULT is set OFF, the ATOM will remain set at the last FO2 GAS 1 Set Points for that series of repetitive dives.

The default FO2 for GAS 1 each new dive Period is AIR.

When FO2 for GAS 1 is set for AIR, the calculations are the same as when it is set to an FO2 of 21%. When FO2 for GAS 1 is set to AIR, it remains set for AIR until it is set for a numerical FO2 value (21 to 50%).

When FO2 is set only to AIR, the O2 Bar Graph is not displayed at any time during a dive or on the surface. PO2 values and/or warnings will not be displayed during the dive.

FREE Dive nitrogen calculations are based on AIR and not affected by these FO2 Settings.

Maximum Operating Depths affected by the PO2 limit set will not be displayed when FO2 for GAS 1 is set to AIR.

Internally, the ATOM keeps track of the oxygen loading so that if FO2 for GAS 1 is subsequently set for a numerical value, the oxygen loading for previous AIR dives will be accounted for in the next Nitrox dive (during that dive period and series of repetitive dives).

Once FO2 GAS 1 is set for a numerical value (21 to 50%) and a dive is made, the AIR option is disabled until 24 hours elapse after the last dive. The AIR option will not be displayed in Set FO2 GAS 1 until a full 24 hour Surface Interval has elapsed.

If FO2 for GAS 1 is set for 21%, it will remain set for 21% for that series of dives until set for a higher numerical value.

If the FO2 50% DEFAULT is set OFF, FO2 for GAS 2 and 3 will remain at their respective Set Points previously selected until they are changed. If the FO2 50% DEFAULT is set ON, FO2 for GAS 2, and 3 will Default to 50% after the dive.

The ATOM is programmed to prevent FO2 for GAS 2 and 3 from being set at values lower than the FO2 Set Point for GAS 1. GAS 2 and 3 can only be set to values equal to or higher than the FO2 Set Points of GAS 1 and 2, respectively.

When setting FO2 for GAS 2 and 3, the lowest values available will be the Set Point of the previous Gas set (e.g., if FO2 GAS 1 is set for 32%, FO2 GAS 2 can only be set at values from 32 to 100%. Likewise, FO2 GAS 3 will depend on the setting for FO2 GAS 2.

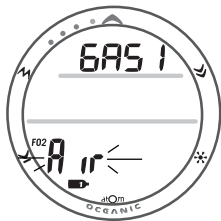

Fig. 42 - SET FO2 GAS1
(AIR setting)

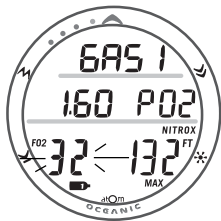

Fig. 43 - SET FO2 GAS1
(32% O2 setting)

SET FO2 GAS 1, information includes:

- > Graphic GAS1
 - > PO2 Alarm Set Point with graphic PO2
 - > Symbol FO2 and FO2 Set Point value, flashing
 - > Tank 1 icon representing GAS 1
 - > Symbol NITROX (if set for a numerical value).
 - > Max Depth allowed for the PO2 Alarm Set (if 21 to 50%)
- Depressing and holding the S button while the Set Point is flashing will scroll the Set Points from AIR (Fig. 42) to 21 through 50% in 1% increments, at a rate of 8 per second.
 - Hint: The scroll will stop when the button is released, or momentarily at 32% (even if the button is held depressed).
 - Pressing and holding the S button will resume the scroll from 32 (Fig. 43) through 50%, then stop at AIR (or 21%).
 - Pressing and releasing the S button will advance FO2 in increments of 1% per press of the button.
 - Pressing and releasing the A button momentarily (< 2 seconds) will save the setting and/or advance to SET FO2 GAS 2 with the Set Point flashing.
 - Pressing and releasing the A button momentarily and repeatedly (< 2 seconds) will step through the other SET F screens.
 - Depressing the A and S buttons simultaneously for 2 seconds will save the setting and revert back to the SET F screen.

- Depressing and holding the M button for 2 seconds or if no button is pressed for a period of 2 minutes operation will revert to the NORM or GAUG SURF MAIN screen.

SET FO2 GAS 2, information includes:

- > Graphic GAS2
 - > PO2 Alarm Set Point with graphic PO2
 - > Symbol FO2 and FO2 Set Point value, flashing
 - > Tank 2 icon representing GAS 2
 - > Symbol NITROX (if set for a numerical value).
 - > Max Depth allowed for the PO2 Alarm Set (if 21 to 100%)
- Depressing and holding the S button while the FO2 Set Point is flashing will scroll the Set Point from AIR to 21 through 100% in 1% increments, at a rate of 8 per second.
 - The scroll will start at the FO2 GAS 1 Set Point and stop when the button is released, or momentarily at 50% (Fig. 44), then 80% (even if the button is held depressed).
 - Depressing and holding the S button will resume the scroll through 100%, then stop at AIR (or 21 or the GAS1 setting).
 - Pressing and releasing the S button (< 2 seconds) will advance FO2 in increments of 1% per press of the button.
 - Pressing and releasing the A button momentarily (< 2 seconds) will save the setting and/or advance to SET FO2 GAS 3 with the Set Point flashing.

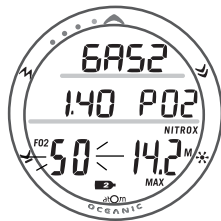

Fig. 44 - SET FO2 GAS2
(50% O2 setting)

- Pressing and releasing the A button momentarily and repeatedly (< 2 seconds) will step through the other SET F screens.
- Depressing the A and S buttons simultaneously for 2 seconds will save the setting and revert back to the SET F screen.
- Depressing and holding the M button for 2 seconds or if no button is pressed for a period of 2 minutes operation will revert to the NORM or GAUG SURF MAIN screen.

SET FO2 GAS 3 information includes:

- > Graphic GAS3
- > PO2 Alarm Set Point with graphic PO2
- > Symbol FO2 and FO2 Set Point value, flashing
- > Tank 3 icon representing GAS 3
- > Symbol NITROX (if set for a numerical value).
- > Max Depth allowed for the PO2 Alarm Set (if 21 to 100%)

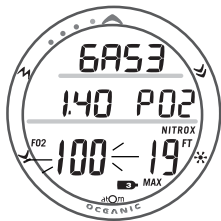

Fig. 45 - SET FO2 GAS3
(100% O2 setting)

- Depressing and holding the S button while the FO2 Set Point is flashing will scroll the Set Point from AIR to 21 through 100% (Fig. 45) in 1% increments, at a rate of 8 per second.
- The scroll will start at the FO2 GAS 2 Set Point and stop when the button is released, or momentarily at 50% then 80% (even if the button is held depressed).

- Depressing and holding the S button will resume the scroll through 100%, then stop at AIR (or 21 or the GAS2 setting).
- Pressing and releasing the S button (< 2 seconds) will advance FO2 in increments of 1% per press of the button.
- Pressing and releasing the A button momentarily (< 2 seconds) will save the setting and/or advance to SET FO2 50% DEFAULT with the Set Point flashing.
- Pressing and releasing the A button momentarily and repeatedly (< 2 seconds) will step through the other SET F screens.
- Depressing the A and S buttons simultaneously for 2 seconds will save the setting and revert back to the SET F screen.
- Depressing and holding the M button for 2 seconds or if no button is pressed for a period of 2 minutes operation will revert to the NORM or GAUG SURF MAIN screen.

SET FO2 50% DEFAULT information includes (Fig. 46):

- > Graphics DFLT and 50
- > Set Point graphic OFF (or ON), flashing.
- > Symbols FO2 and NITROX.
- Pressing and releasing the S button (< 2 seconds) will toggle between OFF and ON.

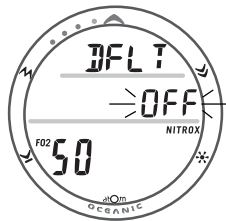

Fig. 46 - SET FO2 DEFAULT

- Pressing and releasing the A button momentarily (< 2 seconds) will save the setting and revert to the SET F screen.
- Pressing and releasing the A button momentarily and repeatedly (< 2 seconds) will step through the other SET F screens.
- Depressing and holding the M button for 2 seconds or if no button is pressed for a period of 2 minutes operation will revert to the NORM or GAUG SURF MAIN screen.

SET A GROUP (NORM/GAUG ALARMS)

Set A Sequence:

SET A > Audible > Depth > EDT > TLBG > DTR > Turn Pressure > End Pressure > PO2

△ HINT: The SET A Group can also be set/changed using the PC Settings Upload program.



Fig. 47 - SET A

- > SET A Settings remain at the values set until changed.
- > Depressing the A and S buttons simultaneously for 4 seconds while NORM or GAUG SURF MAIN is displayed will access SET A identified by the graphic SETA (Fig. 47).
- > Pressing and releasing the A button momentarily (< 2 seconds) while SET A is displayed will advance to SET AUDIBLE ALARM with the Set Point flashing.

SET AUDIBLE ALARM

This option allows the Audible Alarms and the associated red warning LED function to be disabled.

Some cautionary situations will cause the Audible alarm to sound and the LED to flash even if this feature is set to OFF.

SET AUDIBLE ALARM information includes (Fig. 48):

- > Graphic AUD
 - > Set Point graphic ON (or OFF), flashing.
- Pressing and releasing the S button (< 2 seconds) will toggle between ON and OFF.
 - Pressing and releasing the A button momentarily (< 2 seconds) will save the setting and/or advance to the SET DEPTH ALARM screen with the Set Point flashing.
 - Pressing and releasing the A button momentarily and repeatedly (< 2 seconds each time) will step through the other SET A screens.
 - Depressing the A and S buttons simultaneously for 2 seconds will save the setting and revert back to the SET A screen.
 - Depressing and holding the M button for 2 seconds or if no button is pressed for a period of 2 minutes operation will revert to the NORM or GAUG SURF MAIN screen.



Fig. 48 - SET AUDIBLE

SET DEPTH ALARM information includes (Fig. 49):

- > Graphic DPTH
 - > Symbols MAX and FT (or M)
 - > Set Point graphic value, flashing.
-
- Pressing and releasing the S button momentarily (< 2 seconds) will step through the Set Points from 30 to 330 FT (10 to 100 M) in 10 FT (1 M) increments at a rate of 1 Set Point per press of the button.
 - Depressing and holding the S button will scroll through the Set Points at a rate of 4 Set Points per second until it is released.
 - Pressing and releasing the A button momentarily (< 2 seconds) will save the setting and/or advance to the SET EDT (Elapsed Dive Time) ALARM screen with the Set Point flashing.
 - Pressing and releasing the A button momentarily and repeatedly (< 2 seconds each time) will step through the other SET A screens.
 - Pressing the A and S buttons simultaneously for 2 seconds will save the setting and revert back to the SET A screen.
 - Depressing and holding the M button for 2 seconds or if no button is pressed for a period of 2 minutes operation will revert to the NORM or GAUG SURF MAIN screen.

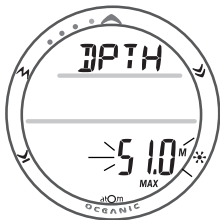

Fig. 49 - SET DEPTH

FREE Mode has separate Depth Alarms.

SET EDT (ELAPSED DIVE TIME) ALARM

Information includes (Fig. 50):

- > Graphic EDT
 - > Symbols DIVE and TIME.
 - > Set Point value (hr:min), flashing.
-
- Pressing and releasing the S button momentarily (< 2 seconds) will increase the Set Point from 0:10 to 3:00 (hours:minutes) in 5 minute (:05) increments.
 - Depressing and holding the S button will scroll through the Set Points at a rate of 4 Set Points per second until it is released.
 - Pressing and releasing the A button momentarily (< 2 seconds) will save the setting and/or advance to the SET TLBG (Tissue Loading Bar Graph) ALARM screen with the Set Point flashing.
 - Pressing and releasing the A button momentarily and repeatedly (< 2 seconds) will step through the other SET A screens.
 - Depressing the A and S buttons simultaneously for 2 seconds will save the setting and revert back to the SET A screen.
 - Depressing and holding the M button for 2 seconds or if no button is pressed for a period of 2 minutes operation will revert to the NORM or GAUG SURF MAIN screen.

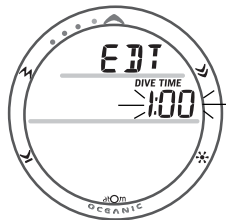

Fig. 50 - SET EDT

FREE Mode has a separate EDT Alarm.

Setting the TLBG Alarm to activate before the ATOM enters DECO is highly recommended.

SET TLBG (TISSUE LOADING BAR GRAPH) ALARM

Information includes (Fig. 51):

- > Graphic TLBG
 - > TLBG Set Point (segments), flashing.
- Pressing and releasing the S button momentarily (< 2 seconds) will decrease the Set Point from All 5 segments (Deco) to 1 in increments of 1 segment.
 - Depressing and holding the S button will scroll through the Set Points at a rate of 4 Set Points per second until it is released.
 - Pressing and releasing the A button momentarily (< 2 seconds) will save the setting and/or advance to the SET DTR (Dive Time Remaining) ALARM screen with the Set Point flashing.
 - Pressing and releasing the A button momentarily and repeatedly (< 2 seconds each time) will step through the other SET A screens.
 - Depressing the A and S buttons simultaneously for 2 seconds will save the setting and revert back to the SET A screen.
 - Depressing and holding the M button for 2 seconds or if no button is pressed for a period of 2 minutes operation will revert to the NORM or GAUG SURF MAIN screen.

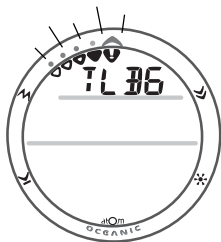

Fig. 51 - SET TLBG

FREE Mode has a separate TLBG Alarm.

SET DTR (DIVE TIME REMAINING) ALARM

Information includes (Fig. 52):

- > Graphic DTR
 - > Symbols AIR, TIME, NDC, and O2.
 - > Set Point value, flashing.
-
- Pressing and releasing the S button momentarily (< 2 seconds) will increase the Set Point from 0:00 to 0:20 (:minutes) in 1 minute (0:01) increments.
 - Depressing and holding the S button will scroll through the Set Points at a rate of 4 Set Points per second until it is released.
 - Pressing and releasing the A button momentarily (< 2 seconds) will save the setting and/or advance to the SET TURN PRESSURE ALARM screen with the Set Point flashing.
 - Pressing and releasing the A button momentarily and repeatedly (< 2 seconds each time) will step through the other SET A screens.
 - Depressing the A and S buttons simultaneously for 2 seconds will save the setting and revert back to the SET A screen.
 - Depressing and holding the M button for 2 seconds or if no button is pressed for a period of 2 minutes operation will revert to the NORM or GAUG SURF MAIN screen.

Whichever Time (No Decompression, O2, or Air Time Remaining) decreases to the Alarm Set Point will activate the Alarm.

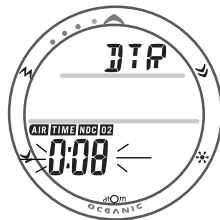

Fig. 52 - SET DTR

The TURN Pressure Alarm only applies to TMT 1.

SET TURN PRESSURE ALARM (for Transmitter 1 only)

Information includes (Fig. 53):

- > Graphic TURN
 - > Set Point OFF or a numeric value, flashing.
 - > Symbol PSI (or M)
-
- Pressing and releasing the S button momentarily (< 2 seconds) will step through the Set Points from OFF to 1000 to 3000 PSI (70 to 205 BAR) in 250 PSI (5 BAR) increments.
 - Depressing and holding the S button will scroll through the Set Points at a rate of 4 Set Points per second until it is released.
 - Pressing and releasing the A button momentarily (< 2 seconds) will save the setting and/or advance to the SET END PRESSURE ALARM screen with the Set Point flashing.
 - Pressing and releasing the A button momentarily and repeatedly (< 2 seconds each time) will step through the other SET A screens.
 - Depressing the A and S buttons simultaneously for 2 seconds will save the setting and revert back to the SET A screen.
 - Depressing and holding the M button for 2 seconds or if no button is pressed for a period of 2 minutes operation will revert to the NORM or GAUG SURF MAIN screen.

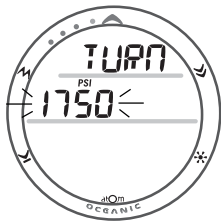

Fig. 53 - SET TURN

SET END PRESSURE ALARM information includes (Fig. 54):

- > Graphic END
 - > Set Point numeric value, flashing.
 - > Symbol PSI (or M)
-
- Pressing and releasing the S button momentarily (< 2 seconds) will increase the Set Point from 300 to 1500 PSI (20 to 105 BAR) in 100 PSI (5 BAR) increments.
 - Depressing and holding the S button will scroll through the Set Points at a rate of 4 Set Points per second until it is released.
 - Pressing and releasing the A button momentarily (< 2 seconds) will save the setting and/or advance to the SET PO2 ALARM screen with the Set Point flashing.
 - Pressing and releasing the A button momentarily and repeatedly (< 2 seconds each time) will step through the other SET A screens.
 - Depressing the A and S buttons simultaneously for 2 seconds will save the setting and revert back to the SET A screen.
 - Depressing and holding the M button for 2 seconds or if no button is pressed for a period of 2 minutes operation will revert to the NORM or GAUG SURF MAIN screen.

The END Pressure Alarm will activate when Pressure in the Tank being used at the time (TMT 1, 2, or 3) decreases to the Alarm Set Point.

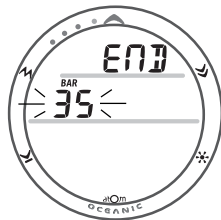

Fig. 54 - SET END PRESSURE

Setting the PO2 Alarm to activate before reaching the Max allowed limit of 1.60 ATA is highly recommended.

SET PO2 ALARM information includes (Fig. 55):

- > Graphics PO2 and AtA
 - > Set Point value, flashing.
 - > Symbol MAX
- Pressing and releasing the S button momentarily (< 2 seconds) will increase the Set Point from 1.20 (ATA) to 1.60 (ATA) in .10 (ATA) increments.
 - Depressing and holding the S button will scroll through the Set Points at a rate of 4 Set Points per second until it is released.
 - Pressing and releasing the A button momentarily (< 2 seconds) will save the setting and/or advance to the SET A screen.
 - Pressing and releasing the A button momentarily and repeatedly (< 2 seconds each time) will step through the other SET A screens.
 - Depressing the A and S buttons simultaneously for 2 seconds will save the setting and revert back to the SET A screen.
 - Depressing and holding the M button for 2 seconds or if no button is pressed for a period of 2 minutes operation will revert to the NORM or GAUG SURF MAIN screen.

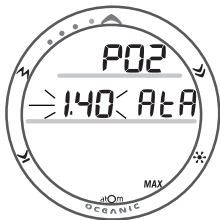

Fig. 55 - SET PO2

SET U GROUP (UTILITIES)

Set U Sequence:

SET U > Wet Activation > Units > Safety Stop > Conservative Factor > Backlight Duration > Sampling Rate > TMT 1 > TMT 2-3 USE > TMT 2 (or BUD 1) > TMT 3 (or BUD 2).

△ HINT: The SET U Group can also be set/changed using the PC Settings Upload program.

FREE Mode utilizes these settings for Wet Activation, Units, and Backlight Duration. It has a separate Sampling Rate fixed at a 1 second interval not affected by the SET U setting.

- > SET U Settings remain at the values set until changed.
- > Depressing the A and S buttons simultaneously for 6 seconds while the NORM or GAUG SURF MAIN screen is displayed, will access SET U identified by the graphic SETU (Fig. 56).
- > Pressing and releasing the A button momentarily (< 2 seconds) while SET U is displayed will advance to SET WET ACTIVATION with the Set Point flashing.

TMT is the abbreviation for Transmitter.

BUD is the abbreviation for Buddy.



Fig. 56 - SET U

Prior to the first dive of a repetitive series, WET Activation must be set ON for the ATOM to enter Dive Mode while operating as a Watch.

SET WET ACTIVATION information includes (Fig. 57):

- > Graphic WET
- > Set Point graphic ON (or OFF) flashing.
- Pressing and releasing the S button will toggle between ON and OFF.
- Pressing and releasing the A button momentarily (< 2 seconds) will save the setting and/or advance to the SET UNITS screen with the Set Point flashing.
- Pressing and releasing the A button momentarily and repeatedly (< 2 seconds each time) will step through the other SET U screens.
- Depressing the A and S buttons simultaneously for 2 seconds will save the setting and revert back to the SET U screen.
- Depressing and holding the M button for 2 seconds or if no button is pressed for a period of 2 minutes operation will revert to the NORM or GAUG SURF MAIN screen.



Fig. 57 - SET WET ACTIVATION

△ HINT: To change this setting while operating in FREE Mode, first access the NORM SURF Mode.

SET UNITS information includes (Fig. 58):

- > Graphic UNIT
 - > Set Point symbols/graphics PSI, F, and FT (or BAR, C, and M), flashing.
-
- Pressing and releasing the S button will toggle between Imperial (F, FT, PSI) and Metric (C, M, BAR).
 - Pressing and releasing the A button momentarily (< 2 seconds) will save the setting and/or advance to the SET SAFETY STOP screen with the Time Set Point flashing.
 - Pressing and releasing the A button momentarily and repeatedly (< 2 seconds each time) will step through the other SET U screens.
 - Depressing the A and S buttons simultaneously for 2 seconds will save the setting and revert back to the SET U screen.
 - Depressing and holding the M button for 2 seconds or if no button is pressed for a period of 2 minutes operation will revert to the NORM or GAUG SURF MAIN screen.

△ HINT: To change this setting while operating in FREE Mode, first access the NORM SURF Mode.

UNITS set will apply to NORM, GAUG, and FREE Modes.



Fig. 58 - SET UNITS

Refer to page 106 for a description of the No Decompression dive mode Safety Stop feature.



Fig. 59 - SET SAFETY STOP

SET NORM SAFETY STOP information includes (Fig. 59):

- > Graphic SAFE
- > Symbols STOP and TIME.
- > Safety Stop Time Set Point, flashing.

- > Safety Stop Depth Set Point and symbol FT (or M).
- Pressing and releasing the S button momentarily (< 2 seconds each time) will step through the Stop Time Set Points of OFF, 3:00, and 5:00 (minutes:seconds).
- Pressing and releasing the A button momentarily (< 2 seconds) will save the Stop Time setting and the Stop Depth Set Point will flash, or if Stop Time is set OFF advance to the SET CONS (Conservative Factor) screen with the Set Point flashing.
- Pressing and releasing the S button momentarily (< 2 seconds each time) will step through the Stop Depth Set Points of 10, 15, and 20 FT (or 3, 4, 5, and 6 M).
- Pressing and releasing the A button momentarily (< 2 sec) will save the Safety Stop settings and/or advance to the SET CONS screen with the Set Point flashing.
- Pressing the A button momentarily and repeatedly (< 2 seconds) will step through the other SET U screens.
- Depressing the A and S buttons simultaneously for 2 seconds will save the settings and revert back to the SET U screen.

- Depressing and holding the M button for 2 seconds or if no button is pressed for a period of 2 minutes operation will revert to the NORM or GAUG SURF MAIN screen.

SET CONSERVATIVE FACTOR information includes (Fig. 60):

- > Graphic CONS
 - > Set Point ON (or OFF), flashing.
 - > Symbols TIME and NDC.
- Pressing and releasing the S button (< 2 seconds) will toggle between ON and OFF.
 - Pressing and releasing the A button momentarily (< 2 seconds) will save the setting and/or advance to the SET BACKLIGHT DURATION screen with the Set Point flashing.
 - Pressing and releasing the A button momentarily and repeatedly (< 2 seconds each time) will step through the other SET U screens.
 - Depressing the A and S buttons simultaneously for 2 seconds will save the setting and revert back to the SET U screen.
 - Depressing and holding the M button for 2 seconds or if no button is pressed for a period of 2 minutes operation will revert to the NORM or GAUG SURF MAIN screen.

Use the Conservative Factor option to help reduce your exposure to Decompression Sickness.

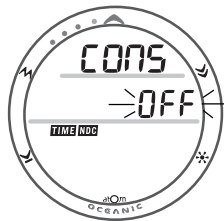

Fig. 60 - SET CONSERVATIVE FACTOR

The Backlight will not remain On for the additional Duration time set if the L button is held depressed longer than 10 seconds.

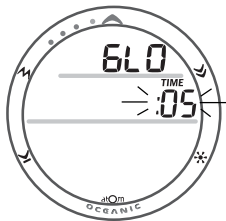

Fig. 61 - SET BACKLIGHT DURATION

△ NOTE: When the Conservative Factor is set ON, the No Deco Limit times are reduced to values equivalent to those that would be available at the next higher 3000 foot (915 meter) Altitude. Refer to the tables on Pages 166/167.

SET BACKLIGHT DURATION information includes (Fig. 61):

- > Graphic GLO.
- > Symbol TIME.
- > Set Point, flashing.

- Pressing and releasing the S button momentarily (< 2 seconds each time) will step through the Set Points of 0, 5, and 10 (:XX seconds).
- Pressing and releasing the A button momentarily (< 2 seconds) will save the setting and/or advance to the SET SAMPLING RATE screen with the Set Point flashing.
- Pressing and releasing the A button momentarily and repeatedly (< 2 seconds each time) will step through the SET U screens.
- Depressing the A and S buttons simultaneously for 2 seconds will save the setting and revert back to the SET U screen.
- Depressing and holding the M button for 2 seconds or if no button is pressed for a period of 2 minutes operation will revert to the NORM or GAUG SURF MAIN screen.

△ HINT: To change the Duration while operating in FREE Mode, first access the NORM SURF Mode.

SET SAMPLING RATE information includes (Fig. 62):

- > Graphic SAMP
 - > Symbol TIME.
 - > Set Point, flashing.
- Pressing and releasing the S button momentarily (< 2 seconds) will step through the Set Points of 2, 15, 30, 60 (:XX seconds).
 - Depressing and holding the S button will scroll through the Set Points at a rate of 4 Set Points per second until it is released.
 - Pressing and releasing the A button momentarily (< 2 seconds) will save the setting and/or advance to the SET TMT 1 screen with the Set Point flashing.
 - Pressing and releasing the A button momentarily and repeatedly (< 2 seconds each time) will step through the other SET U screens.
 - Depressing the A and S buttons simultaneously for 2 seconds shall save the setting and revert back to the SET U screen.
 - Depressing and holding the M button for 2 seconds or if no button is pressed for a period of 2 minutes operation will revert to the NORM or GAUG SURF MAIN screen.

SAMPLING RATE is the frequency (time interval) at which data is sampled and stored in memory for subsequent download to the PC OceanLog program.

FREE Mode has a fixed 1 second Sampling Rate.

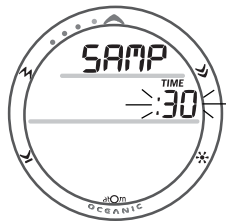

Fig. 62 - SET SAMPLING RATE

TMT 1 is the Default Transmitter while on the Surface, prior to a dive and 10 minutes after a dive.

SET TMT 1 information includes (Fig. 63):

- > Graphics TMT1 and ON (or OFF) flashing.
 - > Set Point (Transmitter's Serial Number (Link Code)).
- Pressing and releasing the S button momentarily (< 2 seconds) will toggle between ON and OFF.
 - Pressing and releasing the A button momentarily (< 2 seconds) will accept the ON/OFF selection.
 - If OFF is selected, SET TMT 2 and TMT 3 will be bypassed and the operation reverts to the SET U screen.
 - If ON is selected, the first (left) digit of the Code will flash.
 - Pressing and releasing the S button momentarily and repeatedly (< 2 seconds each time) will increase the First Digit from 0 to 9 in increments of 1.
 - Depressing and holding the S button will scroll through the Set Points at a rate of 4 per second.
 - Pressing and releasing the A button (< 2 seconds) will accept the First Digit of the Code and/or advance to the Second Digit which will be flashing.
 - Pressing and releasing the S button shall increase the Second Digit from 0 to 9 in increments of 1.
 - Depressing and holding the S button will scroll through the Set Points at a rate of 4 per second.
 - Pressing and releasing the A button (< 2 seconds) will accept the Second Digit of the Code and/or advance to the Third Digit which will be flashing.

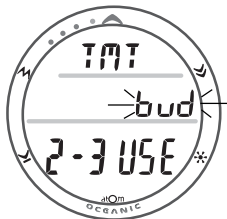

Fig. 63 - SET TMT 1

- Pressing and releasing the S button momentarily and repeatedly (< 2 seconds each time) will increase the Third Digit from 0 to 9 in increments of 1.
- Depressing and holding the S button will scroll through the Set Points at a rate of 4 per second.
- Pressing and releasing the A button (< 2 seconds) will accept the Third Digit of the Code and/or advance to the Fourth Digit which will be flashing.
- Pressing and releasing the S button momentarily and repeatedly (< 2 seconds each time) will increase the Fourth Digit from 0 to 9 in increments of 1.
- Depressing and holding the S button will scroll through the Set Points at a rate of 4 per second.
- Pressing and releasing the A button (< 2 seconds) will accept the Fourth Digit of the Code and/or advance to the Fifth Digit which will be flashing.
- Pressing and releasing the S button momentarily and repeatedly (< 2 seconds each time) will increase the Fifth Digit from 0 to 9 in increments of 1.
- Depressing and holding the S button will scroll through the Set Points at a rate of 4 per second.
- Pressing and releasing the A button will accept the Fifth Digit of the Code and/or advance to the Sixth Digit which will be flashing.
- Pressing and releasing the S button momentarily and repeatedly (< 2 seconds each time) will increase the Sixth Digit from 0 to 9 in increments of 1.
- Depressing and holding the S button will scroll through the Set Points at a rate of 4 per second.
- Pressing and releasing the A button (< 2 seconds) will accept the TMT 1 Link Code and/or advance to SET TMT 2 (or BUD 1) with the Set Point flashing.
- Depressing the A and S buttons simultaneously for 2 seconds will save the setting and revert back to the SET U screen.

SET TMT 2-3 USE information includes (Fig. 64):

- > Graphics TMT and 2-3 USE.
- > Set Point graphic SELF (or bud) flashing.
- Pressing and releasing the S button momentarily (< 2 seconds) will toggle between SELF and bud.
- Pressing and releasing the A button momentarily (< 2 seconds) will accept the setting and/or advance to SET TMT 2 (or BUD 1) with ON or OFF flashing.
- Depressing the A and S buttons simultaneously for 2 seconds shall save the setting and revert back to the SET U screen.
- Depressing and holding the M button for 2 seconds or if no button is pressed for a period of 2 minutes operation will revert to the NORM or GAUG SURF MAIN screen.



When set for SELF, TMT 2 and TMT 3 are associated with Transmitters to be used by a diver using the ATOM for Gas Switching.

When set for BUD, TMT 1 is associated with the user of the ATOM and TMT 2 and TMT 3 are associated with Transmitters to be used by other divers (Buddies) whose Pressure can be checked by the user of the ATOM.

Fig. 64 - SET TMT 2-3 USE

SET TMT 2 (or BUD 1) information includes (Fig. 65):

- > Graphics TMT2 (or BUD1) and ON (or OFF) flashing.
- > Set Point (Transmitter's Serial Number (Link Code)).
- Pressing and releasing the S button momentarily (< 2 seconds) will toggle between ON and OFF.
- Pressing and releasing the A button momentarily (< 2 seconds) will accept the ON/OFF selection.
- If OFF is selected, SET TMT 3 (or BUD 2) will be bypassed and the operation reverts to the SET U screen.
- If ON is selected, the first (left) digit of the Code will flash.
- Pressing and releasing the S button momentarily and repeatedly (< 2 seconds each time) will increase the First Digit from 0 to 9 in increments of 1.
- Depressing and holding the S button will scroll through the Set Points at a rate of 4 per second.
- Pressing and releasing the A button (< 2 seconds) will accept the First Digit of the Code and/or advance to the Second Digit which will be flashing.
- Pressing and releasing the S button shall increase the Second Digit from 0 to 9 in increments of 1.
- Depressing and holding the S button will scroll through the Set Points at a rate of 4 per second.
- Pressing and releasing the A button (< 2 seconds) will accept the Second Digit of the Code and/or advance to the Third Digit which will be flashing.



If TMT 2-3 USE is set for Gas Switching

- OR -



If TMT 2-3 USE is set for Buddy Pressure Check

Fig. 65 - SET TMT 2

- Pressing and releasing the S button momentarily and repeatedly (< 2 seconds each time) will increase the Third Digit from 0 to 9 in increments of 1.
- Depressing and holding the S button will scroll through the Set Points at a rate of 4 per second.
- Pressing and releasing the A button (< 2 seconds) will accept the Third Digit of the Code and/or advance to the Fourth Digit which will be flashing.
- Pressing and releasing the S button momentarily and repeatedly (< 2 seconds each time) will increase the Fourth Digit from 0 to 9 in increments of 1.
- Depressing and holding the S button will scroll through the Set Points at a rate of 4 per second.
- Pressing and releasing the A button (< 2 seconds) will accept the Fourth Digit of the Code and/or advance to the Fifth Digit which will be flashing.
- Pressing and releasing the S button momentarily and repeatedly (< 2 seconds each time) will increase the Fifth Digit from 0 to 9 in increments of 1.
- Depressing and holding the S button will scroll through the Set Points at a rate of 4 per second.
- Pressing and releasing the A button will accept the Fifth Digit of the Code and/or advance to the Sixth Digit which will be flashing.
- Pressing and releasing the S button momentarily and repeatedly (< 2 seconds each time) will increase the Sixth Digit from 0 to 9 in increments of 1.
- Depressing and holding the S button will scroll through the Set Points at a rate of 4 per second.
- Pressing and releasing the A button (< 2 seconds) will accept the TMT 2 (or BUD 1) Link Code and/or advance to SET TMT 3 (or BUD 2) with ON or OFF flashing.
- Depressing the A and S buttons simultaneously for 2 seconds will save the setting and revert back to the SET U screen.

SET TMT 3 (or BUD 2) information includes (Fig. 66):

- > Graphics TMT3 (or BUD2), and ON (or OFF) flashing.
 - > Set Point (Transmitter's Serial Number (Link Code)).
- Pressing and releasing the S button momentarily (< 2 seconds) will toggle between ON and OFF.
 - Pressing and releasing the A button momentarily (< 2 seconds) will accept the ON/OFF selection.
 - If OFF is selected, the operation reverts to the SET U screen.
 - If ON is selected, the first (left) digit of the Code will flash.
 - Pressing and releasing the S button momentarily and repeatedly (< 2 seconds each time) will increase the First Digit from 0 to 9 in increments of 1.
 - Depressing and holding the S button will scroll through the Set Points at a rate of 4 per second.
 - Pressing and releasing the A button (< 2 seconds) will accept the First Digit of the Code and/or advance to the Second Digit which will be flashing.
 - Pressing and releasing the S button shall increase the Second Digit from 0 to 9 in increments of 1.
 - Depressing and holding the S button will scroll through the Set Points at a rate of 4 per second.
 - Pressing and releasing the A button (< 2 seconds) will accept the Second Digit of the Code and/or advance to the Third Digit which will be flashing.

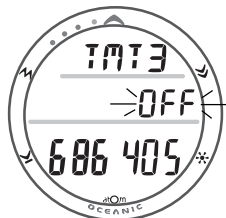

If TMT 2-3 USE is set for Gas Switching

- OR -

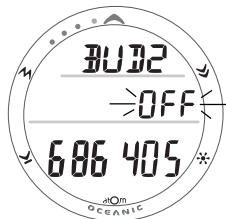

If TMT 2-3 USE is set for Buddy Pressure Check

Fig. 66 - SET TMT 3

- Pressing and releasing the S button momentarily and repeatedly (< 2 seconds each time) will increase the Third Digit from 0 to 9 in increments of 1.
- Depressing and holding the S button will scroll through the Set Points at a rate of 4 per second.
- Pressing and releasing the A button (< 2 seconds) will accept the Third Digit of the Code and/or advance to the Fourth Digit which will be flashing.
- Pressing and releasing the S button momentarily and repeatedly (< 2 seconds each time) will increase the Fourth Digit from 0 to 9 in increments of 1.
- Depressing and holding the S button will scroll through the Set Points at a rate of 4 per second.
- Pressing and releasing the A button (< 2 seconds) will accept the Fourth Digit of the Code and/or advance to the Fifth Digit which will be flashing.
- Pressing and releasing the S button momentarily and repeatedly (< 2 seconds each time) will increase the Fifth Digit from 0 to 9 in increments of 1.
- Depressing and holding the S button will scroll through the Set Points at a rate of 4 per second.
- Pressing and releasing the A button will accept the Fifth Digit of the Code and/or advance to the Sixth Digit which will be flashing.
- Pressing and releasing the S button momentarily and repeatedly (< 2 seconds each time) will increase the Sixth Digit from 0 to 9 in increments of 1.
- Depressing and holding the S button will scroll through the Set Points at a rate of 4 per second.
- Pressing and releasing the A button (< 2 seconds) will accept the TMT 3 (or BUD 2) Link Code and/or advance to the SET U screen.

SERIAL NUMBER (ATOM)

- Depressing the A and S buttons simultaneously for 8 seconds while viewing the NORM SURF MAIN screen will access the ATOM's SERIAL NUMBER screen displaying (Fig. 67):
 - > Graphic SN
 - > Factory programmed Serial Number of the ATOM.
 - > Firmware revision number (e.g., graphic r1A).
- Depressing the A and S buttons simultaneously for 2 seconds will revert to the NORM SURF MAIN screen.
- Depressing and holding the M button for 2 seconds will revert to the NORM SURF MAIN screen.
- If no button is pressed during a period of 2 minutes, the unit will revert to the NORM SURF MAIN screen.

△ NOTE: The Serial Number and Firmware Revision will be requested in the event that you contact Oceanic regarding the ATOM. Enter them in the Records section provided in the back of this Manual.

SN and Firmware Rev are set by the factory and cannot be changed by the user.



Fig. 67 - SERIAL NUMBER
(of the ATOM)

NORM PLAN MODE

Oceanic strongly recommends that you review the Pre Dive Planning Sequence (PDPS) prior to every NORM dive to help you Plan your dive as required to avoid exceeding no decompression or oxygen exposure limits.

This is especially important for repetitive dives when the PDPS indicates adjusted dive times that are available for the next dive, based on residual nitrogen or oxygen accumulation (whichever is in control) following the last dive and surface interval.

△ NOTE: No Decompression Dive Times in PLAN MODE are based on the FO2 setting for GAS 1. The FO2 settings for GAS2 and GAS3 are not utilized for Plan calculations.

- Pressing and releasing the A button momentarily (< 2 seconds) 1 time while in the NORM SURF MAIN screen is displayed will access PLAN MODE (NORM SURF > PLAN).
- While in the PLAN MODE, pressing and releasing the S button momentarily and repeatedly (< 2 seconds each time) will increase the Planned Depth in increments of 10 FT (3 M), displaying the information one screen at a time.

Information provided includes Depths and allowable No Decompression Dive Times. The Pre Dive Planning Sequence will sequence through Depths from 30 to 190 FT (9 to 57 M), or the Maximum Depth that will allow theoretical No Decompression Dive Time of at least 1 minute based upon the previous dive profiles in a series of repetitive dives and taking into account descent and ascent rates of 60 FPM (18 MPM).

△ NOTE: When the Conservative Factor is set ON, No Decompression Dive times are reduced to the values of the next 3000 foot (915 meter) higher Altitude.

If FO2 for GAS1 is set for a numerical value (21 to 50%), the NITROX graphic and Maximum Operating Depth defined by the PO2 ALARM Set Point will be displayed.

If the limiting time factor is Oxygen controlled, the symbols TIME and O2 will be displayed.

If Nitrogen controlled, the symbols TIME and NDC will be displayed.

- Prior to a first dive of a series, pressing and releasing the A button momentarily (< 2 seconds) will advance to LOG MODE (PLAN Lead-in > LOG > HISTORY > NORM SURF).
- After a dive is made, it will advance to FLY MODE (PLAN Lead-in > FLY > SAT > LOG > HISTORY > NORM SURF).
- Depressing and holding the M button for 2 seconds or if no button is pressed during a 2 minute period operation will revert to the NORM SURF MAIN screen.

DEPTH	NDL
FT (M)	HR:MIN
30 (9)	4:20 (4:43)
40 (12)	2:17 (2:24)
50 (15)	1:21 (1:25)
60 (18)	:57 (:59)
70 (21)	:40 (:41)
80 (24)	:30 (:32)
90 (27)	:24 (:25)
100 (30)	:19 (:20)
110 (33)	:16 (:17)
120 (36)	:13 (:14)
130 (39)	:11 (:11)
140 (42)	:09 (:09)
150 (45)	:08 (:08)
160 (48)	:07 (:07)
170 (51)	:07 (:06)
180 (54)	:06 (:06)
190 (57)	:05 (:05)

NDLs, AIR Dive at Sea Level (no dive made yet)

Refer to the charts on pages 166 and 167 for complete listings of No Decompression Limits for Sea Level and Altitudes up to 14,000 feet (4,270 meters).

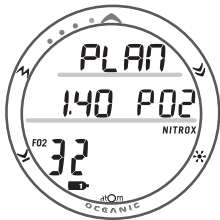

Fig. 68 - PLAN MODE
LEAD-IN SCREEN

PLAN MODE LEAD-IN information includes (Fig. 68):

- > Graphic PLAN.
- > PO2 Alarm Set Point and graphic PO2, if set for Nitrox.
- > FO2 icon and FO2 Set Point for GAS 1.
- > Tank 1 icon representing GAS 1.
- > Symbol NITROX, if set for Nitrox.

- Press and release the S button momentarily (< 2 seconds) to access the first screen (30 FT/9 M) of the Pre Dive Planning Sequence (PDPS).

PDPS information includes (Fig. 69):

- > Plan Depth values and symbol F (feet) or M (meters).
- > PO2 Alarm Set Point and graphic PO2, if set for Nitrox.
- > Symbols TIME and NDC (or O2 if in control).
- > Dive Time (HR:MIN) allowed for the FO2 set for GAS 1.
- > Tank 1 icon representing GAS 1.
- > Symbol NITROX, if set for a Nitrox dive.
- > Maximum Depth allowed and symbols MAX and FT (or M).

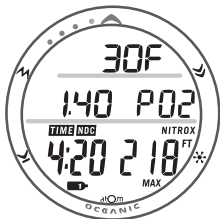

Fig. 69 - PDPS

- Press and release the S button momentarily and repeatedly (< 2 seconds each time) to increase the Planned Depth in increments of 10 FT (3 M), displaying the information one screen at a time.
- Depressing and holding the M button for 2 seconds to revert to the NORM SURF MAIN screen.

FLY MODE

Time to Fly is a counter that begins counting down 10 minutes after surfacing from a dive from 23:50 to 0:00 (hr:min).

Two hours after a dive, the ATOM's operation reverts to the Watch Local Time screen (Main or Alternate, whichever one was selected as the Default screen) at which time the Time to Fly Countdown continues in the background. Access to the FLY screen is then gained by first accessing the NORM or GAUG SURF MAIN screen.

- Pressing and releasing the A button 2 times momentarily (< 2 seconds each time) while the NORM SURF MAIN screen is displayed will access FLY MODE (NORM SURF > PLAN > FLY, or pressing and releasing the A button 1 time momentarily (< 2 seconds) while the GAUG SURF MAIN screen is displayed will access FLY MODE (GAUG SURF > FLY).

TIME TO FLY information includes (Fig. 70):

- > Graphic FLY and symbol TIME.
- > Countdown Time (hr:min).
- > Battery icon if an ATOM Low Battery Warning Condition exists, flashing if Too Low

Time to Fly is not a calculation, it is a 24 hour countdown timer provided for your post dive reference.

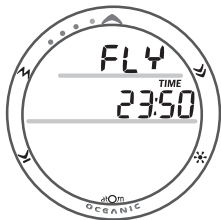

Fig. 70 - TIME TO FLY

- Pressing and releasing the A button momentarily (< 2 seconds) will advance to SAT MODE.
- Depressing and holding the M button for 2 seconds will revert to the NORM SURF MAIN screen.
- If no button is pressed during a 2 minute period, operation will revert to the NORM SURF MAIN screen.
- Pressing the L button will activate the Backlight.

SAT MODE (NORM only)

The Time to Desaturate counter provides calculated time for Tissue Desaturation at sea level taking into consideration the Conservation Factor setting. It begins counting down 10 minutes after surfacing from a dive, counting down from 23:50 max to 0:00 (hr:min).

When the Countdown reaches 0:00, which will generally occur prior to the FLY countdown reaching 0:00, the SAT screen remains in the sequence of accessible screens displaying 0:00 until the FLY counter shuts the Dive Computer operations Off 24 hours after a last dive.

- > The SAT screen is not displayed after a Violation Dive.
- > Desaturation requiring Times greater than 24 hours will display 23: - - .
- > In the event that Time to Desaturate still remains at the end of 24 hours, the added time will be zeroed.
- > Two hours after a dive, the ATOM's operation reverts to the Watch TIME screen (Main or Alternate, whichever one was selected as the Default screen) at which time the Time to Desaturate Countdown continues in the background. Access to the SAT screen is then gained by first accessing the NORM SURF MAIN screen.

- Depressing and releasing the A button momentarily and repeatedly 3 times (< 2 seconds each time) while viewing the NORM SURF MAIN screen will access SAT MODE. (NORM SURF > PLAN > FLY > SAT)

TIME TO DESAT information includes (Fig. 71):

- > Graphic SAT and symbol TIME.
 - > Countdown Time (hr:min).
 - > Battery icon (if an ATOM Low Battery Warning Condition exists), flashing if Too Low
- Pressing and releasing the A button momentarily (< 2 seconds) will advance to LOG MODE.
 - Depressing and holding the M button for 2 seconds will revert to the NORM SURF MAIN screen.
 - If no button is pressed during a 2 minute period, the unit will revert to the NORM SURF MAIN screen.
 - Pressing the L button will activate the Backlight.

NORM/GAUG LOG MODE

LOG MODE displays information from the latest 24 NORM/GAUG dives sequentially in reverse order (the most recent first). LOG information is retained until deleted by another dive. Battery removal will not affect the LOG data stored for viewing.

Time to Desaturate is a calculation based upon calculated residual nitrogen.

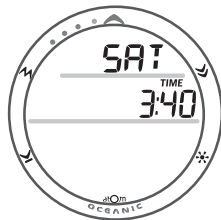

Fig. 71 - TIME TO DESAT

After exceeding 24 dives, the most recent Dive completed will be added to the LOG and the oldest deleted.

Dives will be numbered 1 to 24 starting at #1 each time a new series of dives begins. After it shuts Off 24 hours after a dive, the first dive of the next new series will be #1.

- During the first 10 minutes after a dive, pressing and releasing the A button momentarily (< 2 seconds) 1 time while the NORM SURF MAIN screen is displayed will access LOG MODE. (NORM SURF > LOG)
- 10 minutes after a Non-Violation Dive, pressing and releasing the A button momentarily and repeatedly 4 times (< 2 seconds each time) while the NORM SURF MAIN screen is displayed will access the LOG MODE (NORM SURF > PLAN > FLY > SAT > LOG).
- 10 minutes after a Violation Dive, pressing and releasing the A button momentarily and repeatedly 2 times (< 2 seconds each time) will access LOG MODE (NORM SURF > FLY > LOG). PLAN and SAT screens will not be available after a Violation Dive.

Upon entering LOG MODE the most recent dive's LOG PREVIEW screen will be displayed.

- Depressing the S button for 2 seconds will display the previous dive's PREVIEW screen. Subsequent presses of S will step through other previous dives' PREVIEW screens.
- Pressing and releasing the S button momentarily (< 2 seconds) while viewing a PREVIEW screen will display that dive's LOG DATA 1 screen (Nitrogen Data).

- If that was a Nitrox dive, pressing and releasing the S button again will display that dive's LOG DATA 2 screen (Oxygen Data). If in GAUGE MODE (Violated or User Selected), this screen will not be displayed.
- LOG screens remain on display until further button occurs.
- Pressing and releasing the A button momentarily (< 2 seconds) button will advance to the NORM SURF MAIN screen.
- Depressing and holding the M button for 2 seconds or if no button is pressed during a 2 minute period operation will revert to the NORM SURF MAIN screen.
- Pressing the L button will activate the Backlight.

FREE Dives are not recorded in the LOG, they are stored in Memory for Download.

LOG PREVIEW screen information includes (Fig. 72):

- > Graphic LOG.
 - > Date (month . day or day . month if set for metric).
 - > Symbol DIVE and dive number (1 to 24) for that series.
 - > Time of Day the dive began (HR:MIN) with graphic Am/Pm if set for 12 Hour Format. This will be the Local Default Time selected, either Main or Alternate (with lazy 8 symbol if Alternate).
 - > Symbol NITROX if a Nitrox dive, none if an AIR, GAUG, or FREE dive.
- Pressing and releasing the S button momentarily (< 2 seconds) button will advance to the LOG DATA 1 screen.



Fig. 72 - LOG PREVIEW

LOG DATA 1 information includes (Fig. 73):

- > Alpha graphic NO-D, DECO, GAUG, or VIOL.
- > TLBG with the maximum accumulation segment flashing, others fixed up to end-of-dive accumulation. All segments flashing for delayed and full violation.
- > Temperature (minimum recorded that dive) and graphic F (or C if metric).
- > Symbol DIVE TIME and Elapsed Dive Time (hours:minutes).
- > Symbols TIME and SURFACE.
- > Pre dive Surface Interval time (hr:min), 10 - through 23 - for times greater than 9 hours and 59 minutes, 'blank' for Dive #1 of a series.
- > Maximum Depth and symbol FT (or M).
- > Operating Mode symbol NITROX, none if an AIR or GAUG dive.

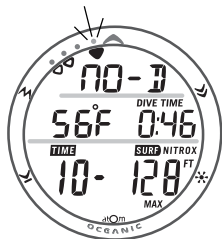

Fig. 73 - LOG DATA 1

- Pressing and releasing the S button momentarily (< 2 seconds) button will advance to the LOG DATA 2 screen.
- Depressing and holding the M button for 2 seconds or if no button is pressed during a 2 minute period operation will revert to the NORM SURF MAIN screen.
- Pressing the L button will activate the Backlight.

LOG DATA 2 (if a Nitrox dive) information includes (Fig. 74):

- > Graphic O₂.
 - > O₂ bar graph segments representing Oxygen accumulated at the end of the dive and symbol O₂BG.
 - > Value of Max PO₂ achieved (ATA) and graphic PO₂.
 - > FO₂ Set (GAS 1) for that dive and symbol FO₂.
 - > Tank 1 icon representing GAS 1.
 - > Symbol NITROX.
-
- Pressing and releasing the S button momentarily (< 2 seconds) button will advance to the previous dive's LOG PREVIEW screen.
 - Depressing and holding the M button for 2 seconds or if no button is pressed during a 2 minute period operation will revert to the NORM SURF MAIN screen.
 - Pressing the L button will activate the Backlight.

HISTORY MODE

HISTORY Mode displays accumulative information for up to 9999 Dives, 9999 Dive Hours, and the Maximum Depth achieved. HISTORY information is retained indefinitely. Battery removal will not affect the HISTORY data stored for viewing.

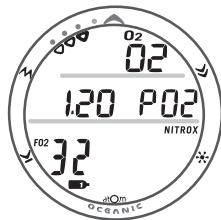

Fig. 74 - LOG DATA 2

- 10 minutes after a Non Violation Dive, pressing and releasing the A button momentarily and repeatedly 5 times (< 2 seconds each time) while the NORM SURF MAIN screen is displayed will access the HISTORY MODE (NORM SURF > PLAN > FLY > SAT > LOG > HIST).
- 10 minutes after a Violation Dive, pressing and releasing the A button 3 times will access LOG MODE (SURF > FLY > LOG > HIST). PLAN and SAT MODES will not be available after a Violation Dive.
- Pressing and releasing the A button momentarily (< 2 seconds) will advance to the NORM SURF MAIN screen.
- Depressing and holding the M button for 2 seconds or if no button is pressed during a 2 minute period operation will revert to the NORM SURF MAIN screen.
- Pressing the L button will activate the Backlight.

HISTORY 1 screen information includes (Fig. 75):

- > Graphic HIST.
- > Symbol DIVE and total number of All dives recorded up to 9999. Includes No Deco, Deco, GAUG, FREE, and VIOL.
- > Symbol TIME and graphic Hr with the Total Hours of Elapsed Dive Time (1 to 9,999).
- Pressing and releasing the S button momentarily (< 2 seconds) button will advance to the HISTORY 2 screen.

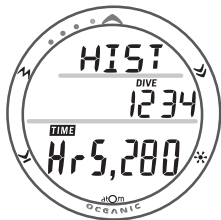

Fig. 75 - HISTORY 1

HISTORY 2 screen information includes (Fig. 76):

- > Graphic SEA (or EL 2 through EL 13), Altitude conducted.
 - > Temperature, lowest recorded of all dives.
 - > Maximum Depth achieved during all dives with symbols FT (or M) and MAX.
-
- Pressing and releasing the S button momentarily (< 2 seconds) button will advance to the NORM SURF MAIN screen.
 - Depressing and holding the M button for 2 seconds or if no button is pressed during a 2 minute period operation will revert to the NORM SURF MAIN screen.
 - Pressing the L button will activate the Backlight.

△ NOTE: FREE Dives are not recorded in the ATOM's LOG or HISTORY. The data is stored in Memory for subsequent Download to the Oceanlog PC Interface program.

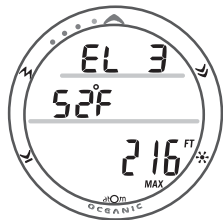

Fig. 76 - HISTORY 2

OVERVIEW OF DISPLAYED SYMBOLS AND ICONS

SYMBOLS

BAR (or) PSI
 STOP TIME (or) DIVE TIME
 AIR TIME (or) -
 TIME NDC (or) -
 TIME O2 (or) -
 TIME TAT (or) -
 TIME SURF
 NITROX
 FO2
 FT (or) M
 MAX

MEANING

Selected Tank's Pressure Units
 Ceiling Stop Time or Elapsed Dive Time (hr:min) or Dive #
 Air Time Remaining (hr:min)
 No Decompression Dive Time Remaining (hr:min)
 O2 Dive Time Remaining (hr:min)
 Ascent Time plus Deco Stop Times (hr:min)
 Elapsed Surface Interval Time (hr:min)
 FO2 for any GAS is set at a numerical value (=>21%)
 FO2 set point is being displayed
 Depth Units (Feet or Meters)
 Maximum (Depth or PO2)

ICONS

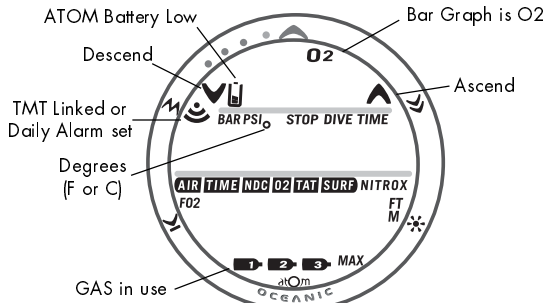



WARNING: Prior to diving with the ATOM, you must also read and understand the Oceanic Dive Computer Safety and Reference Manual, Doc. No. 12-2262, which provides Important Warnings and Safety Recommendations as well as general product information.

OVERVIEW OF DIVE MODE INFORMATION

**Poor
Reception
Distance
(greater than 6 feet/2 meters)**

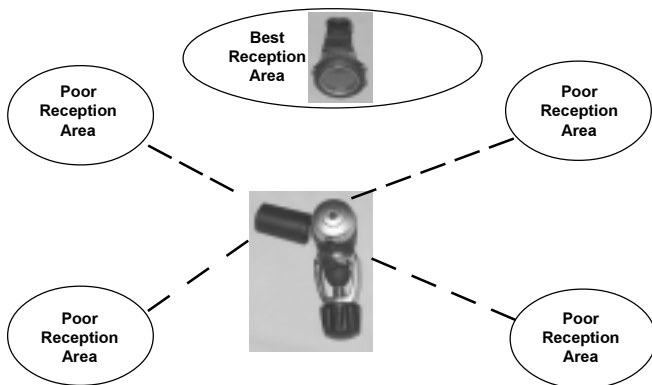

POSITIONING OF THE ATOM

The Transmitters (TMTs) emit low frequency signals that radiate outward in semicircular patterns that are parallel to the length dimension of the TMT. A coiled antenna inside the ATOM receives the signals when it is positioned within a zone parallel to or at a 45 degree angle to the TMT as illustrated on page 92.

The ATOM cannot effectively receive a signal when it is held out to the sides of the TMT or held at distances greater than 6 feet (2 meters) in front of the TMT. Best reception is achieved when the ATOM is within 3 feet (1 meter) of the TMT.

When installed into the high pressure ports of the Regulator First Stages, the TMTs must be positioned so that they face horizontally outward from the Tank Valves.

Link Interruption Underwater

During a dive, you may at times move the ATOM out of the signal pattern of the TMT, resulting in a temporary interruption of the Link signal.

An interruption lasting greater than 15 seconds will cause the Tank Pressure value to flash, the Link icon to flash, the Audible Alarm to sound, and message TMTx > LINK > LOST to scroll (Fig. 77). The Link will be restored within 4 seconds after the ATOM is moved back into its correct position.

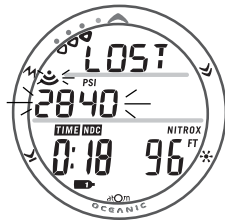

Fig. 77 - LOST LINK UNDERWATER

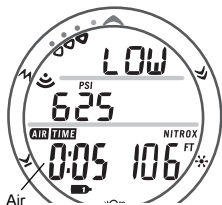
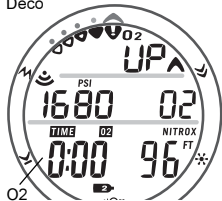
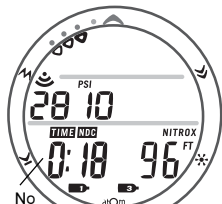

Fig. 78 DIVE TIME REMAINING

An interruption of the TMT Link may also occur while the ATOM is in an area within 3 to 4 feet (1 meter) of a running Dive Propulsion Vehicle. The Link will be restored within 4 seconds after the Vehicle is shut off or the ATOM is moved out of that area. When using a Strobe, a temporary interruption may occur shortly after the Strobe flashes. The Link will be restored within 4 seconds.

DIVE TIME REMAINING (DTR)

One of the most important pieces of information on Oceanic dive computers is the Dive Time Remaining numeric display. The ATOM constantly monitors No Decompression status, Oxygen Accumulation, and Breathing Gas Consumption Rate.

The Dive Time Remaining display (Fig. 78) will indicate the No Deco, O₂, or Air Time, whichever Time is the least amount available. The specific Time being displayed is identified by the symbols TIME and NDC (or O₂ or AIR).

In the event that Air Time Remaining (ATR) becomes less than NDC and O₂ Time, after 1 minute the Audible Alarm will sound, the LED will flash, and the Pressure value will flash.

No Decompression Dive Time Remaining (NDC)

No Decompression Dive Time Remaining is the maximum amount of time that you can stay at your present Depth before entering a Decompression situation. It is calculated based on the amount of Nitrogen absorbed by hypothetical tissue compartments. The rates each of these compartments absorb and release Nitrogen is mathematically modeled and compared against a maximum allowable Nitrogen level. Whichever one is closest to this maximum level is the controlling compartment for that Depth. Its resulting value will be displayed numerically along with the symbols TIME and NDC (Fig. 79a) and graphically as the Tissue Loading Bar Graph (Fig. 79b).

As you ascend from Depth following a dive that has approached the No Decompression Limit, the Nitrogen Bar Graph segments will recede as control shifts to slower compartments. This is a feature of the Decompression Model that is the basis for Multi-level Diving, one of the most important advantages that Oceanic dive computers offer.

The ATOM's algorithm is based upon Haldane's theory using maximum allowable nitrogen levels developed by Merrill Spencer. Repetitive diving control is based upon experiments designed and conducted by Dr. Ray Rogers and Dr. Michael Powell in 1987. Diving Science and Technology® (DSAT), a corporate affiliate of PADI®, commissioned these experiments.

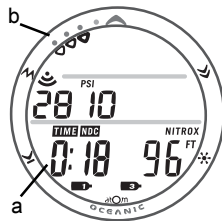

Fig. 79 - NO DECO DTR

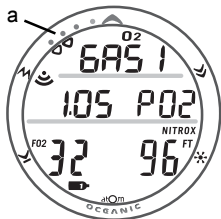

Fig. 80 - O2BG

Oxygen Accumulation Time Remaining (OTR)

When the ATOM is set for Nitrox operation, Oxygen Accumulation (saturation or exposure) during a dive, or 24 hour period, appears graphically as the O2 Bar Graph (Fig. 80a) when the Alternate #2 (O2) screen is accessed. As time remaining before reaching the Oxygen Exposure Limit decreases, segments are added to the O2 Bar Graph.

When the amount of time remaining before reaching the Oxygen Limit becomes less than the No Decompression Dive Time Remaining, calculations for that Depth will be controlled by Oxygen. Oxygen Time Remaining will then appear as the Dive Time Remaining display (Fig. 81a) as signified by the symbols O2 and TIME. As Oxygen Accumulation continues to increase, segments will add to the O2 Bar Graph.

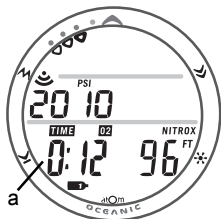

Fig. 81 - O2 TIME REMAINING

Air Time Remaining (ATR)

The ATOM calculates Air Time Remaining using a patented algorithm that is based on a diver's individual Air Consumption Rate and Current Depth. Tank Pressure is measured once each second and an average rate of Consumption is calculated over a 0 second period. This Rate of Consumption is then used in conjunction with a knowledge of the Depth dependence to predict the Air required for the diver to make a safe controlled Ascent including any required Decompression Stops.

Air Consumption and Depth are continuously monitored and Air Time Remaining reflects any change in circumstances. For example, when a buddy starts breathing from your Octopus or you suddenly find yourself swimming against a strong current and begin breathing more rapidly, the ATOM will recognize the change and adjust the Air Time Remaining accordingly.

Air Time Remaining is the time you can remain at the present Depth and still safely surface with the Tank Pressure Reserve that you selected during setup (End Pressure Alarm Setting).

Air Time Remaining (Fig. 82a), identified by the symbols AIR and TIME, can be viewed when the Alternate #1 Display is accessed during dive modes. In the event that ATR becomes less than No Deco and O2 Time, it will be displayed on the Main Display as Dive Time Remaining until it becomes greater than one or the other.

Air Time Remaining (ATR) Alarm

When Air Time Remaining (ATR) decreases to 5 minutes (0:05), the Audible Alarm will sound and the LED will flash. If it decreases to 0:00, the Audible will sound again and the LED will flash. The message LOW > AIR > TIME will scroll at the top of the screen (Fig. 83) until Air Time Remaining becomes greater than 5 minutes (0:05).

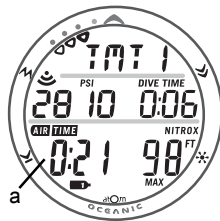

Fig. 82 - AIR TIME REMAINING

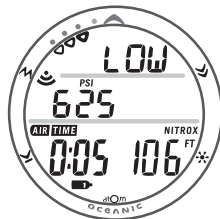

Fig. 83 - ATR WARNING

You should immediately initiate a controlled Ascent while monitoring your Tank Pressure. However, there is no reason to panic, the ATOM has allowed for the Air necessary for a safe Ascent including the No Deco Safety Stop, if set On, and any Decompression Stops required.

Example:

- You set the End Pressure Alarm for 300 PSI (20 BAR)
- You are at a Depth of 60 FT (20 M)
- Air Time Remaining decreases to 0:00
- You Ascend at a maximum rate of 30 FPM (10 MPM)
- You surface with 300 PSI (20 BAR) pressure still in your Tank

VARIABLE ASCENT RATE

Alerts associated with Ascent Rate are based upon 2 sets of speeds which change at a reference depth of 60 FT (18 M).

⚠ WARNING: At depths greater than 60 FT (18 M), Ascent Rates should not exceed 60 FPM (18 MPM). At depths of 60 FT (18 M) and shallower, Rates should not exceed 30 FPM (9 MPM).

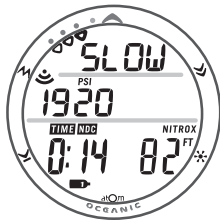

Fig. 84 - ASCENT RATE WARNING

Ascent Rate Warning

At depths deeper than 60 FT (18 M), a Warning (Fig. 84) will be given when Ascent Rates exceed 50 FPM (15 MPM). The message SLOW > SLOW will scroll until the Ascent is slowed.

At 60 FT (18 M) and shallower, the Warning will be given when Ascent Rates exceed 25 FPM (7.5 MPM).

Ascent Rate Alarm

At depths deeper than 60 FT (18 M), an Alarm will sound when Ascent Rates exceed 60 FPM (20 MPM).

At 60 FT (18 M) and shallower, the Alarm will sound when Ascent Rates exceed 30 FPM (10 MPM).

The Audible will sound, the red LED will flash, and the message SLOW > SLOW will scroll on/off at the top of the screen. The Audible and LED will stop when acknowledged with the S button or when the Ascent is slowed. After acknowledged, the Alpha message SLOW > SLOW will continue to scroll until the Ascent is slowed below the Alarm rate.

ELAPSED DIVE TIME

The maximum duration that Elapsed Dive Time will be displayed is 9 hours and 59 minutes (9:59). In the event that the ATOM is at depth for a greater time, it will cease operation as a Dive Computer and revert to operation as a Watch, displaying the Main Time screen.

CONTROL OF DISPLAYS

During Dive Modes, there is a Main (Default) Display of important information relevant to the specific mode that the ATOM is operating in (No Deco, Deco, GAUG, FREE, etc.).

Alternate Displays can be accessed by pressing and releasing the **A** button to view additional information. They will automatically revert to the Main Display after 3 seconds.

- Dive Main > Alternate 1 (ATR) > Alternate 2 (O2 Data, if set for Nitrox)

A Secondary Display can be accessed by pressing the **A** button for 2 seconds. It will also automatically revert to the Dive Main Display after 3 seconds.

- Main > Secondary (Temperature and Time of Day)

The **S** button is used to acknowledge and silence Alarms.

The **L** button is used to activate the Backlight.

- The display will be illuminated as long as the L button is depressed, plus the Backlight Duration time that has been set (0, 5, or 10 seconds) for a maximum of 20 seconds
- The Backlight will not activate during a Low Battery condition.

When TMT 2-3 USE is set for SELF, the **M** button is used for viewing Gas Switch Preview screens (FO2) and Switching Gas. When TMT2-3 USE is set for BUD, the M button is used for viewing Tank Pressure of 1 or 2 buddies whose TMTs have been coded as the ATOM's Set TMT 2 and TMT 3.

-
- Upper/Left - Mode (M) button
 - Upper/Right - Select (S) button
 - Lower/Right - Light (L) button
 - Lower/Left - Advance (A) button

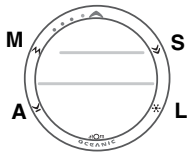



WARNING: Prior to diving with the ATOM, you must also read and understand the Oceanic Dive Computer Safety and Reference Manual, Doc. No. 12-2262, which provides Important Warnings and Safety Recommendations as well as general product information.

NORM TYPE DIVE MODES



Fig. 85 - MAIN TIME WET

WET CONTACTS

The Wet Contact Dive Mode Activation feature is active any time WET ACTIVATION is set ON.

The ATOM is configured with contacts that will automatically activate Dive Mode when the space between the contacts is bridged by a conductive material (immersed in water) and it senses a Depth of 5 FT (1.5 M).

The contacts are the pins of the PC Interface Data Port and the stems of the Push Buttons.

As long as the contacts are bridged on the Surface, the graphic WET will alternate with the Day of Week graphic (MON - SUN) on the Watch MAIN TIME (Fig. 85) and ALT TIME displays and the graphics NORM and SEA (or EL2 to EL13) on the NORM SURF MAIN screen (Fig. 86). Also on the GAUG and FREE SURF MAINs.

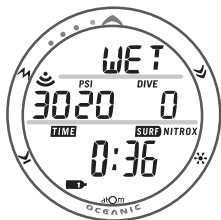

Fig. 86 - NORM SURF WET

Upon removing the bridge between the contacts (drying the ATOM), the graphic WET will no longer be displayed.

The ATOM will continue checking for Depth, until a dive is made or it reverts to the Local Default Time screen after 2 hours.

NORM NO DECOMPRESSION DIVE MODE

When the Wet Activation feature is set ON, the ATOM will enter the NORM No Decompression Dive Mode any time you descend to 5 FT (1.5 M).

When the Wet Activation feature is set OFF, the ATOM will not enter Dive Mode upon descent unless it is operating in one of the NORM Dive Computer modes (menus) at that time. Modes such as Surface Mode, Plan, Fly, etc.

At any time during the dive -

- Depress the L button to activate the Backlight.
- Press/release the S button to acknowledge and silence Alarms.

NORM DIVE NO DECO MAIN Display (Default),

information provided includes (Fig. 87) -

- > Tissue Loading Bar Graph representing Nitrogen
- > TMT Link icon and Tank Pressure with the PSI (or BAR) icon, if a TMT is active and linked
- > Dive Time Remaining (hr:min) with symbols TIME and NDC (or O₂ or AIR)
- > Tank icon representing the GAS selected (1, 2, or 3)
- > Symbol NITROX (if set for Nitrox)
- > Current Depth with symbol FT (or M)

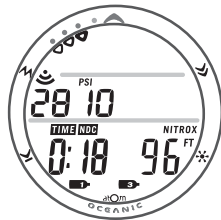

Fig. 87 - NORM DIVE
NO DECO MAIN

During the time that an Alarm is sounding, Alternate, Secondary, and Gas Switch Preview displays cannot be accessed.

- While the NORM DIVE MAIN screen is displayed, press/release the A button (< 2 sec) to view NORM DIVE ALT 1.
- While the NORM DIVE ALT 1 screen is displayed, press/release the A button (< 2 sec) to view NORM DIVE ALT 2.
- Press/hold the A button (2 sec) to view the Secondary Display (Temperature/Time).
- Press/hold the M button (2 sec) to access the TMT 2-3 USE screen and Gas Switch Routine (or Buddy Pressure Check).

NORM DIVE NO DECO ALT 1 DISPLAY,

information provided includes (Fig. 88) -

- > Tissue Loading Bar Graph
- > Graphic TMT1 (or 2 or 3), Link icon, and Tank Pressure with the PSI (or BAR) icon, if a TMT is active and linked
- > Elapsed Dive Time (hr:min) with symbols DIVE and TIME
- > Air Time Remaining (hr:min) with symbols AIR and TIME
- > Tank icon representing the GAS selected (1, 2, or 3)
- > Symbol NITROX (if set for Nitrox)
- > Max Depth with icons FT (or M) and MAX

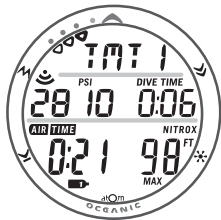

Fig. 88 - NORM DIVE
NO DECO ALT 1

- The display will revert to the MAIN Display after 3 seconds.
- Press/release the A button to view NORM DIVE ALT 2

NORM DIVE NO DECO ALT 2 DISPLAY (if set for Nitrox),
Information includes (Fig. 89) -

- > O2 Bar Graph and symbol O2BG (O2 accumulated)
- > TMT Link icon, if a TMT is active and linked
- > Graphic GAS1 (or 2 or 3)
- > Level of PO2 (ATA) with graphic PO2
- > FO2 Setting and symbol FO2
- > Tank icon representing the GAS selected (1, 2, or 3)
- > Symbol NITROX (if set for Nitrox)
- > Current Depth and symbol FT (or M)

- The display will revert to the MAIN Display after 3 seconds.

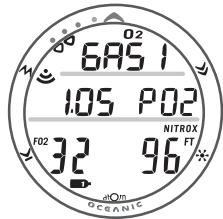

Fig. 89 - NORM DIVE
NO DECO ALT 2

NORM DIVE NO DECO SECONDARY DISPLAY, information includes (Fig. 90) -

- > Day of the Week graphic (MON, TUE, etc.)
- > Temperature with degrees icon and graphic F (or C)
- > Time of Day (hour:minute:second).
This will be the Default Watch Time selected (MAIN or ALTERNATE).

- The display will revert to the MAIN Display after 3 seconds.



Fig. 90 - NORM DIVE
NO DECO SECONDARY

△ NOTE: The Alternate and Secondary Displays cannot be accessed during the time when an Alarm is sounding.

NORM DIVE NO DECO SAFETY STOP

Upon ascending to the Safety Stop Depth set on any No Decompression dive in which Depth exceeded 30 FT (9 M), a short beep will be emitted and a Safety Stop at the Depth set will appear on the display with a countdown timer that begins at the Safety Stop Time set and counts down to 0:00 (min:sec).

The Safety Stop will be displayed until the countdown times out, or you descend below 30 FT (10 M), or you surface. There is no Penalty if you surface prior to completing the Safety Stop.

If the Safety Stop was set to OFF, the screen will not appear during the ascent.

NORM DIVE NO DECO SAFETY STOP MAIN DISPLAY,

Information includes (Fig. 91) -

- > Graphics SAFE, STOP, and xxF or xxM (value of the Stop Depth set) scrolling at the top
- > Tissue Loading Bar Graph representing Nitrogen
- > TMT Link icon and Tank Pressure with the PSI (or BAR) icon, if a TMT is active and linked
- > Symbols STOP and TIME and the Stop Time (min:sec) set
- > Dive Time Remaining (hr:min) with symbols TIME and NDC (or O2 or AIR)
- > Tank icon representing the GAS selected (1, 2, or 3)
- > Symbol NITROX (if set for Nitrox)
- > Current Depth with symbol FT (or M)

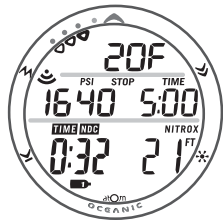

Fig. 91 - NORM DIVE NO DECO SAFETY STOP MAIN

- Press/release the A button to view the NORM MAIN and ALT Displays
- Press/hold the A button (2 sec) to view Temperature/Time
- Press/release the L button to activate the Backlight
- Press/release the S button to acknowledge/silence Alarms

DECOMPRESSION DIVE MODE

The ATOM is designed to help you by providing a representation of how close you are to entering Decompression.

Decompression Dive Mode activates when theoretical No Decompression time and depth limits are exceeded.

Upon Entry into Decompression Mode, the Audible Alarm will sound, the red LED Warning Light will flash, and the graphic message DECO > STOP will scroll each 3/4 second On and 1/4 second Off (Fig. 92A), until acknowledged or for 10 seconds (unless set OFF).

Once silenced, the graphics DECO > STOP > xxF or xxM will scroll each 2 seconds On 2 seconds blank (Fig. 92B).

- Press/release the S button to acknowledge/silence the Audible Alarm.
- The UP Arrow will flash if you are greater than 10 FT (3 M) deeper than the Required Stop Depth.

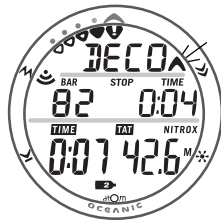

Fig. 92A - DECO ENTRY
METRIC UNITS
(when Alarm strikes)

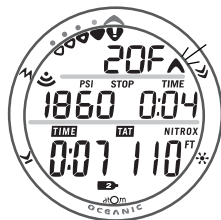

Fig. 92B - DECO ENTRY
IMPERIAL UNITS
(after acknowledged)

- Once you are within 10 FT (3 M) of, and below, the Required Stop Depth, the UP Arrow will be removed.

At any time during the dive -

- Depress the L button to activate the Backlight.
- Press/release the S button to acknowledge/silence Alarms.
- Press/hold the A button (2 sec) to view the common Secondary Display (Temperature/Time).

Managing Decompression Stops

To fulfill your decompression obligation, you should make a safe controlled Ascent to a depth slightly deeper than (Fig. 93a), or equal to, the Required Ceiling Stop Depth indicated (Fig. 93b) and decompress for the Stop Time indicated (Fig. 93c).

The amount of decompression Credit Time that you receive is dependent on Depth, with slightly less Credit given the deeper you are below the Stop Depth indicated.

You should stay slightly deeper than the Required Stop Depth indicated until the next shallower Stop Depth appears. Then, you can slowly ascend to, but not shallower than that indicated Ceiling Stop Depth.

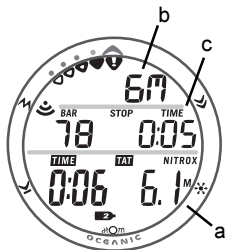

Fig. 93 - DECO STOP

DECO STOP MAIN Display (Default),

information provided includes (Fig. 94) -

- > Tissue Loading Bar Graph (all segments indicating DECO)
 - > Graphic message DECO > STOP > xxF or xxM, scrolling
 - > TMT Link icon and Tank Pressure with the PSI (or BAR) icon, if a TMT is active and linked
 - > Stop Time (hr:min) with symbols STOP and TIME
 - > Total Ascent Time with symbols TIME and TAT
 - > Symbol NITROX (if set for Nitrox)
 - > Current Depth with symbol FT (or M)
-
- While the DECO STOP MAIN screen is displayed, press/release the A button (< 2 sec) to view DECO STOP ALT 1.
 - While the DECO STOP ALT 1 screen is displayed, press/release the A button (< 2 sec) to view DECO STOP ALT 2.
 - Press/hold the M button (2 sec) to access the TMT 2-3 USE screen and Gas Switch Routine (or Buddy Pressure Check).

Total Ascent Time

Total Ascent Time (Fig. 94a) includes Stop Times required at all required decompression ceilings and vertical Ascent Time calculated at 60 FPM (18 MPM) for depths deeper than 60 FT (18 M), and 30 FPM (9 MPM) for depths of 60 FT (18 M) and shallower.

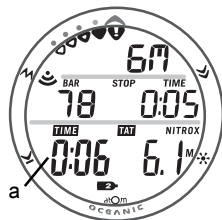

Fig. 94 - DECO STOP MAIN

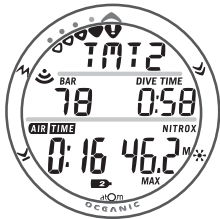

Fig. 95 - DECO STOP ALT 1

DECO STOP ALT 1 DISPLAY, information includes (Fig. 95) -

- > Tissue Loading Bar Graph (all segments)
- > Graphic TMT1 (or 2 or 3), Link icon, and Tank Pressure with the PSI (or BAR) icon, if a TMT is active and linked
- > Elapsed Dive Time (hr:min) with symbols DIVE and TIME
- > Air Time Remaining (hr:min) with symbols AIR and TIME
- > Tank icon representing the GAS selected (1, 2, or 3)
- > Symbol NITROX (if set for Nitrox)
- > Max Depth with icons FT (or M) and MAX

- The display will revert to the DECO STOP MAIN Display after 3 seconds.
- Press/release the A button to view DECO STOP ALT 2.

DECO STOP ALT 2 DISPLAY, information includes (Fig. 96) -

- > O2 Bar Graph and symbol O2BG (O2 accumulated)
- > Graphics GAS1 (or GAS2 or GAS3)
- > Link icon, if a TMT is active and linked
- > Level of PO2 (ATA) with graphic PO2
- > FO2 Setting and symbol FO2
- > Tank icon representing the GAS selected (1, 2, or 3)
- > Symbol NITROX
- > Current Depth and symbol FT (or M)
- The display will revert to the DECO MAIN after 3 seconds.

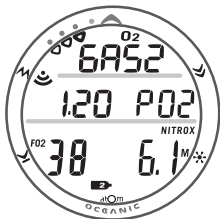

Fig. 96 - DECO STOP ALT 2

DECO SECONDARY DISPLAY, information includes (Fig. 97)-

- > Day of the Week graphic (MON, TUE, etc.)
- > Temperature with icon and graphic F (or C)
- > Time of Day (hr:min:sec)
 - This will be the Default Watch Time (Main or Alternate).
- The display will revert to the DECO MAIN after 3 seconds.



Fig. 97 - DECO
SECONDARY

VIOLATION MODES

While in Violation Modes, the Alternate Displays previously described can be accessed using the A button, the Backlight can be activated using the L button, and Alarms can be acknowledged and silenced with the S button.

- The Alternate and Secondary Displays of information will be similar to the DECO screens. They revert to the MAIN (Default) Display after 3 seconds.

CONDITIONAL VIOLATION

If you ascend shallower (Fig. 98a) than a Required Decompression Ceiling Stop Depth (Fig. 98b), the Audible Alarm will sound, and the red LED, Down Arrow, and Full TLBG will flash until you descend below the Required Stop Depth. The graphic message DOWN > DOWN will scroll at the top of the display until the Alarm is acknowledged/silenced, then the message DOWN > TO > xxF or xxM will scroll.

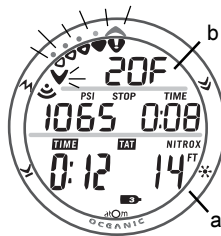

Fig. 98 - CONDITIONAL
VIOLATION MAIN

If you descend below the required Decompression Ceiling before 5 minutes have elapsed, the ATOM will continue to function in Decompression Dive Mode. In this case, no off gassing Credit will be given, and for each minute above the Ceiling $1\frac{1}{2}$ minutes of **Penalty Time** will be added to Required Stop Time. The added Penalty (decompression) Time will have to be 'worked off' first, before obtaining off gassing credit.

Once the Penalty Time is worked off, and off gassing Credit begins, required Deco Stop Depths and Time will decrease toward zero. The TLBG will recede into the No Deco Zone and the ATOM will revert to the No Deco Dive Mode.

△ NOTE: Upon entry into following Delayed Violation Modes, the red LED flash and the Audible Alarm will sound, even if Set OFF. When these events occur, the Alarm cannot be acknowledged (silenced) by pressing the S button.



Fig. 99 - DELAYED VIOLATION #1 MAIN

DELAYED VIOLATION # 1 (Fig. 99)

If you remain above the Required Ceiling Stop Depth for more than 5 minutes, the full TLBG and DOWN Arrow will flash until you descend below the Required Stop Depth. Also, the graphic message DOWN > TO > xxF (or xxM) will continue to scroll. This is a continuation of a Conditional Violation.

DELAYED VIOLATION #2 (Fig. 100)

The ATOM cannot calculate Decompression times for Stop Depths much greater than 60 FT (18 M) and offers no indication of how much time spent underwater would result in the need for a greater Stop Depth.

If the Decompression obligation requires a Ceiling Stop Depth between 60 FT (18 M) and 70 FT (21 M), the TLBG will flash and the graphic message DECO > STOP > 60F (18M) will scroll at the top of the display.

When this occurs, you must make a controlled Ascent to just deeper than, and stay as close as possible to, 60 FT (18 M) without causing the TLBG to flash. When the Required Stop Depth indicates 50 FT/ 15 M, etc., you can ascend to those Stop Depths and continue decompressing.

DELAYED VIOLATION #3 (Fig. 101)

If you descend deeper than the Maximum Operating Depth of 330 FT (100 M), the UP Arrow will flash, and the Current Depth and Max Depth displays will only indicate 3 dashes (---) signifying that you are Out of Range.

The graphic message TOO > DEEP will scroll at the top of the display until Ascent is made above 330 FT (100 M).

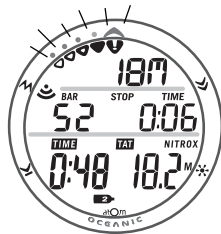

Fig. 100 - DELAYED VIOLATION #2 MAIN

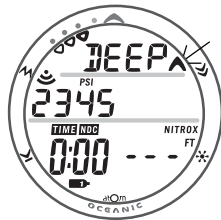

Fig. 101 - DELAYED VIOLATION #3 MAIN

Upon ascending above 330 FT (100 M), the Current Depth display will be restored, however Max Depth will only display 3 dashes for the remainder of that dive. Also, the Log for that dive will display 3 dashes as the Max Depth achieved.

IMMEDIATE VIOLATION AND VIOLA GAUGE MODE

If a Decompression Ceiling Stop Depth much greater than 60 FT (18 M) is required, an Immediate Violation Mode will be entered. This situation would be preceded by entering Delayed Violation Mode #2.

The ATOM would then operate in Violation Gauge Mode during the remainder of that dive and for 24 hours after surfacing. Violation Gauge Mode turns the ATOM into a digital instrument without any decompression or oxygen monitoring functions.

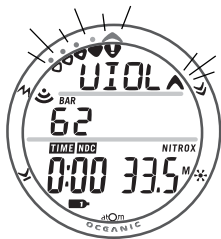

Fig. 102 - VIOLATION
GAUGE DIVE MAIN

VIOLATION GAUGE DIVE MAIN DISPLAY (Default),

information provided includes (Fig. 102) -

- > Full TLBG and UP Arrow, flashing
- > Message UP > VIOL, scrolling
- > TMT Link icon and Tank Pressure with the PSI (or BAR) icon, if a TMT is active and linked
- > Symbols TIME and NDC with 0:00 (hr:min) Time Remaining
- > Tank icon representing the GAS selected (1, 2, or 3)
- > Symbol NITROX (if set for Nitrox)
- > Current Depth with symbol FT (or M)

The ATOM will also enter an Immediate Violation Mode (Violation Gauge Mode) 5 minutes surfacing from a dive in which a Delayed Violation occurred.

Violation Gauge Mode on the Surface does not allow access to the SET F, PLAN, FLY, and SAT features/screens.

The countdown timer that appears when you try to access Time to Fly does not represent Time to Fly. It is only provided to inform you of the time remaining before normal ATOM Dive Computer operation can resume with full features and functions.

This condition is a Permanent Violation, and in the event that a dive is made during the 24 hour period, a full 24 hour surface interval must then be served before all functions are restored.

VIOLENT GAUGE SURF MAIN DISPLAY (Default),

information provided includes (Fig. 103) -

- > Full TLBG, flashing
- > Message VIOL > VIOL, scrolling
- > TMT Link icon and Tank Pressure with the PSI (or BAR) icon, if a TMT is active and linked
- > Symbols TIME and SURF with Surface Interval Time (hr:min)
- > Tank icon representing GAS1 (surface default)
- > Symbol NITROX (if set for Nitrox)
- > Current Depth with symbol FT (or M)

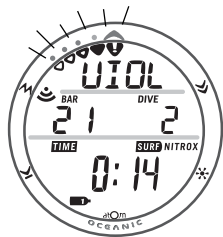

Fig. 103 - VIOLENT GAUGE SURF MAIN

If a High PO2 condition occurs while in Deco Mode, the message HIGH > PO2 will replace the DECO message until PO2 < 1.60.

HIGH PO2

When partial pressure of oxygen (PO2) becomes equal to, or greater than, 0.2 ATA less than the PO2 Alarm Set Point (a SET A Group setting); the red LED warning light will flash, the Audible Alarm will sound, and the message HIGH > PO2 will scroll until the Alarm is acknowledged/silenced.

- The graphic PO2 and UP Arrow will appear solid on the MAIN Display (Fig. 104) as a warning until PO2 decreases.
- After the Alarm is silenced, the graphic message UP > HIGH > PO2 will scroll.

If PO2 continues to increase, the value displayed will increase toward a maximum value of 5.00 ATA in increments of .01 ATA.

When PO2 reaches the PO2 Alarm Set Point, the red LED warning light will flash and the Audible Alarm will sound again.

- > The graphic PO2 and UP Arrow will flash as a warning until PO2 decreases below the Alarm Set Point.
- > The message UP > HIGH > PO2 will continue to scroll.
- The value of PO2 can be viewed by accessing the ALT 2 Display by pressing the A button 2 times.
- The unit will revert to the MAIN Display after 3 seconds.



Fig. 104 - HIGH PO2 MAIN

HIGH OXYGEN ACCUMULATION

The O₂ Bar Graph displays either oxygen accumulated during that nitrox dive, or during the repetitive nitrox dives you conduct during that 24 hour period, whichever of the two is greater at that time. The O₂ Bar Graph allows you to monitor how close you are coming to the limits of oxygen exposure.

If the theoretical amount of oxygen accumulated equals, or exceeds, the limit for a single exposure, or the exposure limit for a 24 hour period (300 OTU), Oxygen Dive Time Remaining becomes 0:00 (hr:min), the graphic O₂ appears and the full O₂ Bar Graph and UP Arrow will be displayed flashing (Fig. 105).

The red LED warning will flash, the Audible Alarm will sound, and the message HIGH > O₂ will scroll at the top of the display. When the Alarm is acknowledged/silenced, the message UP > HIGH > O₂ will scroll until the level of oxygen decreases below the limit.

- Press the A button to view the Alternate and Secondary Displays.
- The unit will revert to the MAIN Display after 3 seconds.

Upon surfacing, operation will lock in to NORM Mode until the O₂BG recedes to 4 segments. Access to Watch Mode is allowed but access to GAUG and FREE is blocked.

Refer to page 167 for
a Chart of NOAA
Oxygen Exposure
Limits.

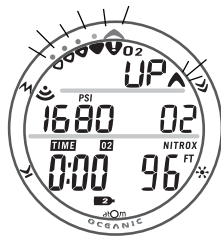

Fig. 105 - HIGH O₂

SUMMARY OF NORM/GAUG WARNING AND ALARM MESSAGES

MESSAGE

MEANING

DECO > STOP > xxF (M)	Entry into Decompression Mode.
DOWN > TO > xxF (M)	Above a Required Decompression Stop Depth.
DECO > STOP > 60F (18M)	Deco Stop greater than 60 FT (18 M) required.
HIGH > PO2	High PO2 while in Deco Mode.
UP > HIGH > PO2	High PO2 set point alarm while in No Deco Mode.
UP > HIGH > O2	High O2 alarm.
TOO > DEEP	Depth set point alarm.
UP > VIOL	Deco Stop greater than 70 FT (21 M) required.
SLOW > SLOW	Ascent Rate Too alarm.
LOW > AIR > TIME	Air Time Remaining less than 5 minutes alarm.
LOW > DIVE > TIME	Dive Time Remaining (NDC, O2, or ATR) set point alarm.
TURN > GAS > ALRM	TMT1 Turn Pressure set point alarm.
END > GAS > ALRM	TMT End Pressure set point alarm (TMT in use).
TIME > TOO > LONG	Elapsed Dive Time set point alarm.
UP > HIGH > NI	TLBG set point alarm.
TMT1 > LINK > LOST	Active TMT1 Transmission Link lost (also TMT2 and TMT3).
TMT1 > NotAvail	TMT1 not active (also TMT2 and TMT3).
DONT > SWCH	Don't Switch to the new Gas (exposure to excess PO2).



WARNING: Prior to diving with the ATOM, you must also read and understand the Oceanic Dive Computer Safety and Reference Manual, Doc. No. 12-2262, which provides Important Warnings and Safety Recommendations as well as general product information.

SWITCHING GAS MIXES AND BUDDY PRESSURE CHECK

SWITCHING GAS MIXES (NORM only)

During NORM Dives, the ATOM can be manually switched from GAS 1 to GAS 2 to GAS 3, changing FO2 displays and calculations from the FO2 value set for GAS 1 to the FO2 value set for GAS 2 to the FO2 value set for GAS 3, and if TMTs (Transmitters) are used, changing Pressure related displays and calculations from TMT 1 to TMT 2 to TMT 3.

△ NOTE: Switching the ATOM from one GAS (and TMT) to another cannot be performed while on the surface, and during dives when TMT 2-3 USE is set for Buddy Pressure Check.

Every dive begins with GAS 1. 10 minutes after surfacing from a multiple gas dive, the ATOM's operation defaults to the GAS 1 FO2.

Access to NORM DIVE Gas Switching screens can only be accomplished during the time that a NORM DIVE MAIN screen is being displayed and cannot be performed during the time that an Alarm is sounding.

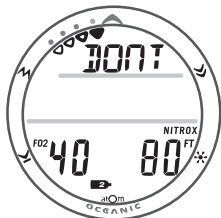

△ NOTE: If a Switch to a new Gas Mix would expose the diver to a prohibitive PO2 level of 1.60 ATA or greater, the Audible Alarm will sound, the red LED will flash, and the message DONT > SWCH will scroll at the top of the display (Fig. 106) until acknowledged by pressing/releasing the S button momentarily.

Fig. 106 - DON'T SWITCH
GAS ALARM

Due to the possibility that sufficient air may not be available in the Switch From tank to complete the dive, the Switch to the prohibitive Mix can still be made. If the Switch is made to the prohibitive Mix while in NORM NO DECO DIVE Mode, the High PO2 Alarm will activate. If the Switch is made to the prohibitive Mix while in DECO DIVE Mode, the message HIGH > PO2 will replace the scrolling DECO message until the High PO2 condition clears.

Switching of Gas Mixes can only to be performed during the time that a Gas Switch Preview screen is being displayed. These are accessed from a NORM DIVE MAIN screen.

- Pressing and holding the M button for 2 seconds while viewing a NORM DIVE MAIN screen will access the TMT 2-3 USE screen displaying the Set Point SELF (Fig. 107). If BUD is displayed, indicating that the ATOM is set for Checking Buddy Pressure, a Gas Switch cannot be made.
- Pressing and releasing the M button momentarily (< 2 seconds) while the TMT 2-3 USE screen is displayed (with the setting SELF) will access the GAS 1 Switch Preview Display.
- The ATOM will revert to the NORM DIVE MAIN screen after 10 seconds of no further M button action.

When a switch is made to another GAS, there may be a delay of 5 to 15 seconds before the ATOM's Receiver picks up the TMT's signal.



Fig. 107 - TMT 2-3 USE
(set for SELF)

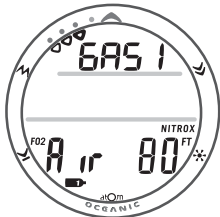

Fig. 108 - GAS 1 SWITCH PREVIEW

GAS 1 SWITCH PREVIEW DISPLAY

Information includes (Fig. 108) -

- > TLBG, representing Nitrogen Loading.
- > Graphic GAS1
- > FO2 Set Point for GAS 1 and the symbol FO2
- > Tank icon representing GAS 1
- > Symbol NITROX
- > Current Depth and symbol FT (or M)

- Press/release the M button momentarily (< 2 seconds) to access the GAS 2 Switch Preview Display for 10 seconds.

GAS 2 SWITCH PREVIEW DISPLAY

Information includes (Fig. 109) -

- > TLBG, representing Nitrogen Loading.
- > Graphic GAS2
- > FO2 Set Point for GAS 2 and the symbol FO2
- > Tank icon representing GAS 2
- > Symbol NITROX
- > Current Depth and symbol FT (or M)

- Press/release the M button momentarily (< 2 seconds) to access the GAS 3 Switch Preview Display (or GAS 1 if GAS 3 is not active) for 10 seconds.

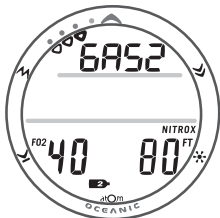

Fig. 109 - GAS 2 SWITCH PREVIEW

TO SWITCH FO2 FROM GAS 1 TO GAS 2

- Depressing the M button for 2 seconds while viewing the GAS 2 Switch Preview Display will manually Switch the ATOM's FO2 from GAS 1 to GAS 2 and the ATOM's Receiver from TMT 1 to TMT 2 (if active).
- When the switch is made, the NORM MAIN DIVE Display (Fig. 110) will represent GAS 2 and display the Pressure of Tank 2 (if active). Air Time Remaining is then calculated based on TMT 2.

If the ATOM is not Switched to the new Gas being breathed, Air Time Remaining will increase to maximum after 1 minute without a change in transmitted Pressure.

TO SWITCH FO2 FROM GAS 2 BACK TO GAS 1

A Switch Back to FO2 GAS 1 can be performed, as follows:

- Press/release the M button momentarily (< 2 seconds) to step through the Switch Preview screens.
- Depressing the M button for 2 seconds while the GAS 1 Switch Preview screen is displayed will switch the ATOM from GAS 2 back to GAS 1 and the ATOM's Receiver from TMT 2 back to TMT 1.
- When the switch is made, the NORM DIVE MAIN Display will then represent GAS 1 and display the Pressure of Tank 1. Air Time Remaining is then calculated based on Tank 1.

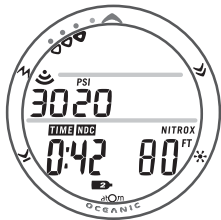

Fig. 110 - NORM MAIN after Switch from GAS1 to GAS2

GAS 3 SWITCH PREVIEW DISPLAY

Information includes (Fig. 111) -

- > TLBG, representing Nitrogen Loading.
 - > Graphic GAS3
 - > FO2 Set Point for GAS 3 and the symbol FO2
 - > Tank icon representing GAS 3
 - > Symbol NITROX
 - > Current Depth and symbol FT (or M)
- Press/release the M button momentarily (< 2 seconds) to access the GAS 1 Switch Preview Display for 10 seconds.

TO SWITCH FO2 FROM GAS 2 TO GAS 3

- Depressing the M button for 2 seconds while viewing the GAS 3 Switch Preview Display will manually Switch the ATOM's FO2 from GAS 2 to GAS 3 and the ATOM's Receiver from TMT 2 to TMT 3 (if active).
- When the Switch is made, the NORM MAIN DIVE Display will represent FO2 GAS 3 and display the Pressure of Tank 3 (if active). Air Time Remaining is then calculated based on TMT 3.
- A Switch Back to FO2 GAS 2 can be performed, as previously described for switching GAS 2 Back to GAS 1.

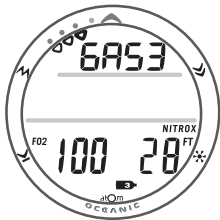

Fig. 111 - GAS 3 SWITCH
PREVIEW

BUDDY PRESSURE CHECK (NORM only)

During NORM Dives, the ATOM can be used to check (display) Tank Pressure of 1 or 2 buddies whose TMT Link Codes (Serial Numbers) have been entered as TMT 2 and TMT 3 in the ATOM's SET U menu.

△ NOTE: Using the ATOM for a Buddy Pressure Check cannot be performed when TMT 2-3 USE is set for SELF (Gas Switching).

Access to Buddy Pressure Check screens during dives can only be accomplished during the time that a NORM DIVE MAIN screen is being displayed and cannot be performed during the time that an Alarm is sounding.

TO BUDDY PRESSURE CHECK DURING DIVES

- Bring the ATOM within range, 3 feet (1 meter), of the Buddy's Transmitter.
- Press and hold the M button for 2 seconds while viewing a NORM DIVE MAIN screen to access the TMT 2-3 USE screen displaying the Set Point bud (Fig. 112). If SELF is displayed, indicating that the ATOM is set for FO2 GAS Switching, a Buddy Pressure Check cannot be performed.

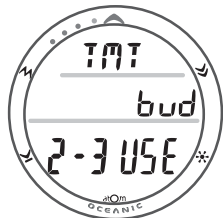

Fig. 112 - TMT 2-3 USE
(set for BUD)



Fig. 113 - BUDDY SEARCH



Fig. 114 - BUDDY 1
PRESSURE CHECK



Fig. 115 - BUDDY 2
PRESSURE CHECK

- Pressing and releasing the M button momentarily (< 2 seconds) while the TMT 2-3 USE screen is displayed (with the setting BUD) will start a Search for BUDDY 1 (TMT 2) displaying the graphics BUD and SEArCH (Fig. 113) for a maximum of 5 seconds.

NOTE: No further button action is required. The displays will change automatically, then revert to the NORM DIVE MAIN Display

- After 5 seconds, or less if BUD1 (TMT2) is acquired, the BUD1 screen will appear displaying the graphics BUD 1 and BUD 1's (TMT 2's) Pressure (Fig. 114), or the graphic NotAvAil (Not Available), for 3 seconds.
- After BUD 1's screen has been displayed for 3 seconds, the BUD 2 screen will appear displaying the graphics BUD 2 and BUD 2's (TMT 3's) Pressure, or the graphic NotAvAil (Fig. 115), for 3 seconds.

NOTE: The graphic NotAvAil (Not Available) indicates that the Buddy is out of range or the ATOM's BUD 1 (or 2) setting does not match the Serial Number of the TMT being checked.

- After BUD 2's screen has been displayed for 3 seconds, the screen will revert to the NORM DIVE MAIN Display.

TO BUDDY PRESSURE CHECK ON SURFACE

A Buddy Pressure Check can be performed when on the Surface by accessing the TMT Status Check screens while the NORM SURF MAIN screen is being displayed.

- Depressing and holding the S button for 2 seconds will activate the ATOM's Receiver and access the TMT Status screens and Pressures of the Tanks reporting.
- TMT 2 and TMT 3 Battery Status is not displayed when TMT 2-3 USE is set for BUD (Buddy Pressure Check).
- If a TMT is not active and linked to the ATOM, the message NotAvAil (Not Available) will appear.
- Each screen will be displayed for 3 seconds. ATOM Battery Status, then TMT 1 Battery Status and Pressure (Fig. 116), then BUD 1 Pressure (Fig. 117), then BUD 2 Pressure (Fig. 118).
- The screen will then revert to the NORM SURF MAIN screen.



Fig. 116 - TMT 1 STATUS



Fig. 117 - TMT 2 STATUS



Fig. 118 - TMT 3 STATUS

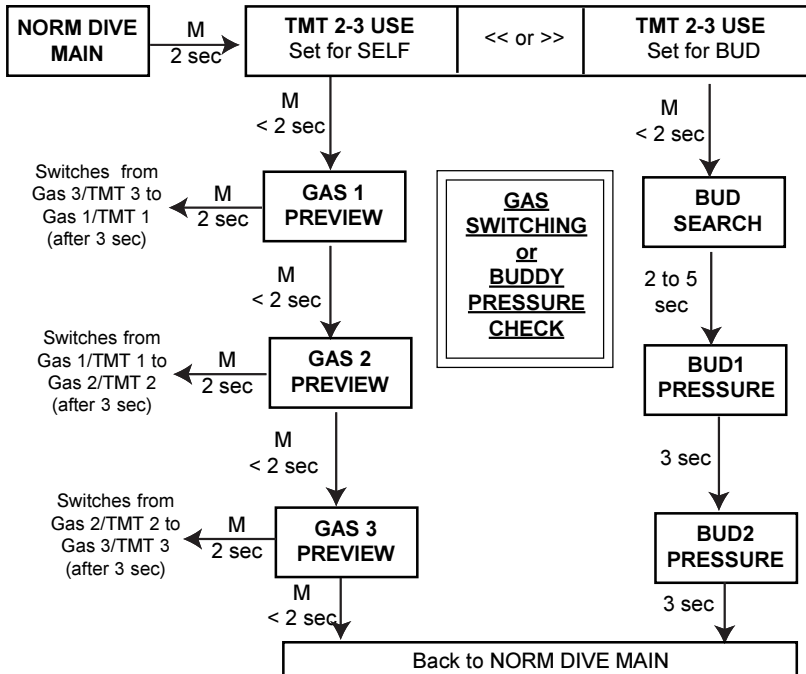



WARNING: Prior to diving with the ATOM, you must also read and understand the Oceanic Dive Computer Safety and Reference Manual, Doc. No. 12-2262, which provides Important Warnings and Safety Recommendations as well as general product information.

NORM POST DIVE MODES

POST DIVE SURFACE MODE

When you ascend to 4 FT (0.6 M), the ATOM will enter Surface Mode and begin counting your Surface Interval.

TRANSITION PERIOD

If you descend during the first 10 minutes after surfacing (referred to as the Transition Period), time underwater will be considered a continuation of that dive. The time at the surface (if less than 10 minutes) will not be added as Dive Time.

Transition Period information on the surface includes (Fig. 119):

- > TLBG, representing Nitrogen loading.
- > LINK icon and Tank Pressure with symbol PSI (or BAR), if the Receiver is Linked with a TMT.
- > Graphic NORM alternating with the Altitude Level graphic SEA (or EL2 through EL13) and WET (if the unit is wet).
- > Battery icon if an ATOM Low Battery Warning Condition exists, flashing if Too Low.
- > Symbol DIVE and Number of that dive.
- > Symbols TIME and SURF, and Surface Interval Time (hr:min).
- > NITROX symbol, if any GAS is set for a Nitrox dive.
- > Tank icon representing the GAS in use.

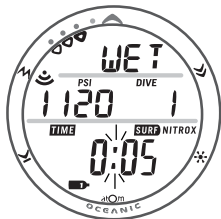

Fig. 119 - TRANSITION PERIOD

During the Transition Period, Alternate displays and the Log for that dive can be accessed. Other modes (e.g., Plan, Fly, Sat, Hist, Set) are accessible after 10 minutes on the surface.

To view that dive's Log during the Transition Period -

- Press and release the A button (< 2 seconds) to access the Preview screen (Fig. 120).
- Press the S button to view the Log 1 screen (Nitrogen data).
- Press the S button again to view the Log 2 screen (Oxygen data), if a Nitrox dive.
- Press the S button again to return to the NORM SURF screen.
- The screen will revert to NORM SURF after 2 minutes if no button is pressed.



Fig. 120 - LOG PREVIEW
(during Transition Period)

Log Data will not be stored in the ATOM's memory until the 10 minute Transition Period on the surface is completed.

Once 10 minutes have elapsed, the Surface Interval time display colon will stop flashing indicating that the Dive and Transition Period are completed, and a subsequent descent will be considered a new dive. Operation will revert to the MAIN TIME Display.

AFTER THE TRANSITION PERIOD

Once the Transition Period has ended, NORM MAIN SURF (Fig. 121) can be accessed from MAIN TIME by pressing the M button 2 seconds. You will then have full access to other NORM DC modes (e.g., Plan, Fly, Sat, Log, Hist, Set, etc.).

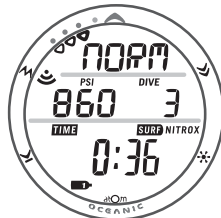

Fig. 121 - NORM MAIN SURF
(after Transition Period)

To activate the Backlight -

- Press the L button at any time.

To access NORM PLAN Mode (refer to page 78) -

- Press the A button 1 time while NORM SURF MAIN is displayed.

The Planning Sequence now displays adjusted No Decompression Limits based on residual nitrogen and accumulated oxygen calculated to be remaining from the previous dives.

To access the FLY Mode (refer to page 81) -

- Press/release the A button 2 times while NORM SURF MAIN is displayed.

To access the SAT Mode (refer to page 82) -

- Press/release the A button 3 times while NORM SURF MAIN is displayed.

If a Violation occurred during the dive, Desaturation Time will not be displayed.

The Time to Desaturate counter provides calculated time for tissue desaturation at sea level.

To access the NORM/GAUG LOG Mode (refer to page 83) -

- Press/release the A button 4 times while NORM SURF MAIN is displayed.

To access the NORM/GAUG HISTORY Mode (refer to page 87) -

- Press/release the A button 5 times while NORM SURF MAIN is displayed.



WARNING: Prior to diving with the ATOM, you must also read and understand the Oceanic Dive Computer Safety and Reference Manual, Doc. No. 12-2262, which provides Important Warnings and Safety Recommendations as well as general product information.

GAUGE OPERATING MODE

GAS 1 and TMT 1 are the Defaults for GAUG Mode, GAS 2/3 and TMT 2/3 are not available in GAUG Mode.

GAUGE MODE

When Gauge Mode (GAUG) is selected as the Operating Mode, the ATOM will operate as a Digital Depth Gauge/Timer without performing nitrogen and oxygen calculations.

- To access GAUG Operating Mode while Watch MAIN TIME is displayed, press the M button 2 times (2 seconds each time), or while the NORM SURF MAIN screen is displayed, press the M button 1 time for 2 seconds.
- If no GAUG dive has been conducted, press the M button for 2 seconds to advance to the FREE SURF MAIN Display.

MAIN TIME > NORM SURF > GAUG SURF > FREE SURF

GAUG SURF MAIN DISPLAY (Default),

information provided includes (Fig. 122) -

- > Graphic GAUG alternating with the Altitude Level graphic SEA (or EL2 through EL13) and WET (if the unit is wet).
- > Battery icon if an ATOM Low Battery Warning Condition exists, flashing if Too Low.
- > LINK icon and Tank Pressure with symbol PSI (or BAR), if the Receiver is Linked with an active TMT.
- > Symbol DIVE and Number of that dive.
- > Symbols TIME and SURF, and Surface Interval Time (hr:min).



Fig. 122 - GAUG SURF MAIN

- Press/release the A button to access Fly, Log, and History.
- Press/hold the A button for 2 seconds to view the common Secondary Display (Temperature and Time of Day).
- Press/hold the A and S buttons simultaneously for 2 seconds to access the SET menu (F > A > U > T).
- Press/release the S button acknowledge/silence Alarms.
- Press/hold the S button for 2 seconds to access Battery/TMT Status screens.
- Press the L button to activate the Backlight.

Gas Switching or Buddy Pressure Check is not available in GAUG Mode.

When GAUG Operating Mode is selected and upon descending to 5 FT (1.5 M), the ATOM will enter GAUG DIVE Mode.

△ NOTE: Once a dive is made with the ATOM set for GAUG Operating Mode, you must wait 24 hours after surfacing before the ATOM resets and will operate as an Air or Nitrox dive computer in NORM Mode or FREE Dive Mode.

GAUG DIVE MAIN DISPLAY (Default),

information provided includes (Fig. 123) -

- > Graphic GAUG.
- > LINK icon and Tank Pressure with symbol PSI (or BAR), if TMT 1 is active and linked.
- > Current Depth and FT (or M) icon.

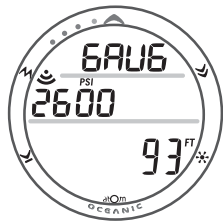

Fig. 123 - GAUG DIVE MAIN

- Press/release the A button to access the GAUG ALT display.
- Press/hold the A button for 2 seconds to view the common Secondary screen (Temperature and Time of Day) for 3 seconds.
- Press/release the S button acknowledge/silence Alarms.
- Press the L button to activate the Backlight.

GAUG DIVE ALT DISPLAY,

information provided includes (Fig. 124) -

- > Graphic TMT 1, Link icon, and Tank Pressure with the PSI (or BAR) icon, if TMT 1 is active and linked
 - > Elapsed Dive Time (hr:min) with symbols DIVE and TIME
 - > Air Time Remaining (hr:min) with symbols AIR and TIME
 - > Max Depth with icons FT (or M) and MAX
- The display will revert to the GAUG DIVE MAIN screen after 3 seconds.



Fig. 124 - GAUG DIVE ALT



WARNING: Prior to diving with the ATOM, you must also read and understand the Oceanic Dive Computer Safety and Reference Manual, Doc. No. 12-2262, which provides Important Warnings and Safety Recommendations as well as general product information.

FREE DIVE OPERATING MODE

FREE Mode uses the NORM/GAUG settings for -
>> Time/Date
>> Wet Activation
>> Units

FREE DIVE MODE

When FREE (Free Dive Mode) is selected as the Operating Mode, the ATOM will operate as a Digital Depth Gauge with select features. Nitrogen loading is calculated based upon a default FO2 of AIR and the amount remaining during 24 hours is carried over between FREE and NORM Operating Modes.

- To access FREE Operating Mode while Watch MAIN TIME is displayed, press the M button 3 times (2 seconds each time), or while NORM GAUG MAIN is displayed, press the M button 1 time for 2 seconds.
- To access the NORM SURF MAIN Display, press the M button for 2 seconds.

MAIN TIME > NORM SURF > GAUG SURF > FREE SURF



Fig. 125 - FREE SURF MAIN

FREE SURF MAIN DISPLAY, information includes (Fig. 125) -

- > Graphic FREE alternating with the Altitude Level graphic SEA (or EL 2 through EL13) or graphic WET, each 3 seconds On then 1/4 second Off.
- > Battery icon if an ATOM Low Battery Warning Condition exists, flashing if Too Low.
- > Graphic tot - with symbol DIVE and accumulated Total number of repetitive FREE Dives conducted in that series.
- > Symbols TIME and SURF and Surface Interval Time (min:sec to 59:59, then hr:min).

- Press the L button to activate the Backlight.
- Depress the A button for 2 seconds to access the common Secondary screen (Temperature and Time of Day) for 3 seconds then the FREE SURF ALT Display for 3 seconds.
- Pressing and releasing the A button momentarily (< 2 seconds) will access the FREE SURF Count Down TIMER Status Display allowing you to Set/Start/Stop the CD Timer.
- Pressing and releasing the M button momentarily (< 2 sec) while viewing the FREE SURF ALT Display will access the FREE SURF CDT (CountDown Timer) STATUS Display.
- Pressing and releasing the A button momentarily (< 2 sec) will access the Log and History screens.
- Depressing and holding the A and S buttons simultaneously for 2 seconds will access the SET FREE EDT (Elapsed Dive Time) ALARM Display from which you can then access the SET FREE DEPTH ALARM 1/2/3 Displays.

FREE SURF ALT DISPLAY, information includes (Fig. 126) -

- > Graphic FREE
- > Battery icon if an ATOM Low Battery Warning Condition exists, flashing if Too Low.
- > Graphic LAST with symbols DIVE TIME and the Elapsed Dive Time (min:sec) of the FREE dive previously made while still in FREE MODE. Resets to 0:00 after 24 hours.
- > Symbols MAX and FT (or M) and the Maximum Depth of the FREE dive previously made while still in FREE MODE.



Fig. 126 - FREE SURF ALT



Fig. 127 - CDT ON/RUNNING

- Press the L button to activate the Backlight.

The display will revert to the FREE SURF MAIN screen after 3 seconds or if the A button is pressed momentarily.

FREE MODE COUNTDOWN TIMER (CDT)

Pressing the A button momentarily (< 2 seconds) while viewing the FREE SURF MAIN screen will access the FREE SURF CDT STATUS screen.

FREE SURF CDT STATUS DISPLAY,

information includes (Fig. 127/128) -

- > Graphics TIMR and OFF (or ON), flashing
- > TIME symbol and remaining Countdown time (min:sec) with the colon flashing, if ON and a CD is in progress.
- > 0:00 (min:sec) will be displayed with the colon flashing, if the CD Timer is ON and no time is remaining.
- > If the CD Timer is OFF, the CD Time (min:sec) previously set will be displayed with the colon solid.



Fig. 128 - CDT OFF/NOT SET

- Pressing and releasing the S button momentarily (< 2 seconds) will toggle between ON and OFF.
- > If a Time has been set, a toggle from OFF to ON will start the CD Timer indicated by the colon flashing.

- An ON/OFF toggle is prevented when S is operated to acknowledge/silence the Daily Alarm.
- Press the L button to activate the Backlight.
- Pressing the A button momentarily (< 2 sec), or depressing the M button for 2 seconds, or if no button is pressed during a period of 2 minutes, will revert the Display to the FREE SURF MAIN screen.
- Depressing the A and S buttons simultaneously for 2 seconds while viewing the CD Timer Status screen when the CD Timer is OFF will access the SET CD TIMER screen with the MINUTE Set Point flashing.

The Set Point for the Watch CDT does not affect the FREE CDT.

△ NOTES: Once the CD TIMER has been Set and Started (by selecting ON), it will continue to run in the background while on the surface until turned OFF (stopped) or the Time reaches 0:00 at which time the Alarm will strike (3 short beeps 3 times), the message TIMR will be displayed, and the CD TIMER will revert to OFF.

Upon descending to 5 FT/1.5 M (i.e., entry into FREE DIVE Mode), CD TIMER operation will continue, if in progress.

During a dive, the CD TIMER can be turned OFF (stopped) and ON (started), but not Set.



**Be a -
RESPONSIBLE
FREE DIVER
at all times.**

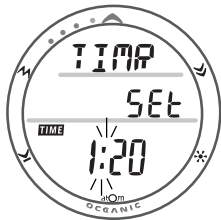

Fig. 129 - SET FREE CDT

SET FREE CDT STATUS DISPLAY (SURFACE ONLY),

information includes (Fig. 129) -

- > Graphics TIMR and SEt, solid.
 - > TIME symbol and Timer setting (min:sec), colon solid, MINUTE Set Point flashing.
- Depressing and holding the S button while the MINUTE Set Point is flashing will scroll through the Set Points at a rate of 4 per second from 0: to 59: in 1 Minute (1:) increments.
 - Pressing and releasing the A button momentarily (< 2 seconds) will save the MINUTE Set Point displayed and advance to Set SECONDS with the Set Point flashing.
 - Depressing and holding the S button while the SECONDS Set Point is flashing will scroll through the Set Points at a rate of 4 per second from :00 to :59 in 1 Second (:01) increments.
 - Pressing and releasing the A button momentarily (< 2 seconds) will save the CD Timer Set Point indicated by the graphic OFF flashing (Fig. 130) in place of the graphic SEt.
 - Pressing and releasing S button momentarily (< 2 seconds) will toggle to ON and start the CD TIMER.
 - Pressing the A button momentarily (< 2 sec), or depressing the M button for 2 seconds, or if no button is pressed during a period of 2 minutes, will revert the Display to the FREE SURF MAIN screen.



Fig. 130 - FREE CDT SET

FREE DIVE EDT (ELAPSED DIVE TIME) ALARM

The FREE EDT Alarm is factory set for 30 seconds. When set ON, the Alarm will sound 3 short beeps and the message TIME will be displayed momentarily every 30 seconds while the ATOM is operating underwater in FREE DIVE Mode.

- Depressing the A and S buttons simultaneously for 2 seconds while the FREE SURF MAIN screen is displayed, will access SET FREE EDT ALARM with the Set Point flashing.

△ NOTE: The FREE EDT Alarm can only be Set (turned OFF or ON) while on the Surface and can not be changed during a Dive.

SET FREE EDT ALARM DISPLAY,

information includes (Fig. 131) -

- > Graphic EDT.
- > Set Point OFF or ON, flashing.
- Pressing and releasing the S button momentarily (< 2 seconds) will toggle the Set Point between OFF and ON.
- Pressing the A button momentarily (< 2 sec) will accept the setting and access the SET FREE DEPTH ALARM 1 screen.
- Depressing the M button for 2 seconds, or if no button is pressed during a period of 2 minutes, will revert the Display to the FREE SURF MAIN screen.

The Set Point for the NORM/GAUG EDT Alarm does not affect the FREE EDT Alarm.



Fig. 131 - SET FREE EDT ALARM

The Set Point for the NORM/GAUG Depth Alarm does not affect the FREE Depth Alarms.

FREE DIVE DEPTH ALARMS (FDA)

The ATOM features 3 FREE Dive DEPTH Alarms that can be Set at progressively deeper Depths and turned OFF/ON.

- > If Alarm 1 is set OFF, then Alarms 2 and 3 will be disabled.
- > If Alarm 2 is set OFF, Alarm 3 will be disabled.

When each of the Depths are reached during a dive, 3 short beeps will sound 3 times and the message DPTH will be displayed 3 times.

- Pressing the A button momentarily (< 2 seconds) while the SET FREE EDT ALARM screen is displayed will access SET FREE DEPTH ALARM 1 with the Set Point flashing.

Sequence of FREE Mode Alarm Setting Access:

FREE SURF MAIN • press A and S 2 seconds >>
SET FREE EDT AL • press A less than 2 seconds >>
SET FREE DEPTH AL 1 • press A less than 2 seconds >>
SET FREE DEPTH AL 2 • press A less than 2 seconds >>
SET FREE DEPTH AL 3 • press A less than 2 seconds >>
FREE SURF MAIN



SET FREE DEPTH ALARM 1 (FDA1) DISPLAY,

information includes (Fig. 132) -

- > Graphic FDA1.
 - > Set Point ON or OFF, flashing.
 - > Depth Set Point graphic value, flashing if ON is displayed.
 - > Symbols MAX and FT (or M).
-
- Pressing and releasing the S button momentarily (< 2 seconds) will toggle the Set Point between ON and OFF.
 - If set ON, the Depth value displayed will flash.
 - > Pressing and releasing the S button momentarily and repeatedly (< 2 sec each time) will step through the Set Points from 30 to 330 FT (10 to 100 M) in increments of 10 FT (1 M) at a rate of 1 Set Point per press of the button.
 - > Pressing and holding the S button will scroll through the Set Points at a rate of 4 Set Points per second until released.
 - > Pressing the A button momentarily (< 2 sec) will accept the Depth Setting and advance to SET FREE DEPTH ALARM 2.
 - If set OFF, pressing the A button momentarily will accept the Setting and revert operation to the FREE SURF MAIN screen, bypassing SET FREE DEPTH ALARMS 2 and 3.
 - Depressing the M button for 2 seconds, or if no button is pressed during a period of 2 minutes, will revert the Display to the FREE SURF MAIN screen.

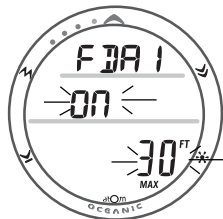

Fig. 132 - SET FREE DEPTH ALARM 1

The range of available FDA 2 Set Points begins at the next FT/M value greater than the FDA 1 Alarm Set Point.

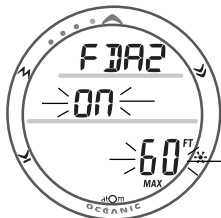

Fig. 133 - SET FREE DEPTH ALARM 2

SET FREE DEPTH ALARM 2 (FDA2) DISPLAY,

information includes (Fig. 133) -

- > Graphic FDA2.
 - > Set Point ON or OFF, flashing.
 - > Depth Set Point graphic value, flashing if ON is displayed.
 - > Symbols MAX and FT (or M).
-
- Pressing and releasing the S button momentarily (< 2 seconds) will toggle the Set Point between ON and OFF.
 - If set ON, the Depth value displayed will flash.
 - > Pressing and releasing the S button momentarily and repeatedly (< 2 sec each time) will step through the Set Points from 40 to 330 FT (11 to 100 M) in increments of 10 FT (1 M) at a rate of 1 Set Point per press of the button.
 - > Pressing and holding the S button will scroll through the Set Points at a rate of 4 Set Points per second until released.
 - > Pressing the A button momentarily (< 2 sec) will accept the Depth Setting and advance to SET FREE DEPTH ALARM 3.
 - If set OFF, pressing the A button momentarily will accept the Setting and revert operation to the FREE SURF MAIN screen, bypassing SET FREE DEPTH ALARM 3.
 - Depressing the M button for 2 seconds, or if no button is pressed during a period of 2 minutes, will revert the Display to the FREE SURF MAIN screen.

SET FREE DEPTH ALARM 3 (FDA3) DISPLAY,

information includes (Fig. 134) -

- > Graphic FDA3.
 - > Set Point ON or OFF, flashing.
 - > Depth Set Point graphic value, flashing if ON is displayed.
 - > Symbols MAX and FT (or M).
-
- Pressing and releasing the S button momentarily (< 2 seconds) will toggle the Set Point between ON and OFF.
 - If set ON, the Depth value displayed will flash.
 - > Pressing and releasing the S button momentarily and repeatedly (< 2 sec each time) will step through the Set Points from 50 to 330 FT (12 to 100 M) in increments of 10 FT (1 M) at a rate of 1 Set Point per press of the button.
 - > Pressing and holding the S button will scroll through the Set Points at a rate of 4 Set Points per second until released.
 - > Pressing the A button momentarily (< 2 sec) will accept the Depth Setting and advance to SET FREE DEPTH ALARM 3.
 - If set OFF, pressing the A button momentarily will accept the Setting and revert operation to the FREE SURF MAIN screen.
 - Depressing the M button for 2 seconds, or if no button is pressed during a period of 2 minutes, will revert the Display to the FREE SURF MAIN screen.

The range of available FDA 3 Set Points begins at the next FT/M value greater than the FDA 2 Alarm Set Point.

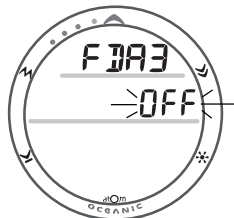

Fig. 134 - SET FREE DEPTH ALARM 3

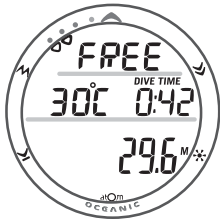

Fig. 135 - FREE DIVE MAIN

FREE DIVE MAIN DISPLAY (DEFAULT),

information includes (Fig. 135) -

- > Graphic FREE
- > TLBG, if any Nitrogen remaining from previous NORM or FREE Dives conducted within the previous 24 hours.
- > Temperature with degrees symbol and graphic F (or C)
- > Symbols DIVE and TIME and Elapsed Dive Time (min:sec).
- > Current Depth and symbol FT (or M).

- Press and release the A button momentarily (< 2 seconds) to access the FREE CDT (Count Down Timer) STATUS screen.
- Depress and hold the A button for 2 seconds to access the common Secondary screen (Temperature and Time of Day) for 3 seconds.
- Pressing the L button will activate the Backlight.



Fig. 136 - FREE DIVE CDT
STATUS (OFF)

FREE DIVE CDT STATUS DISPLAY,

information includes (Fig. 136) -

- > Graphics TIMR and OFF (or ON), flashing
- > TIME symbol and remaining Countdown time (min:sec) with the colon flashing if ON and a CD is in progress, 0:00 with the colon flashing if ON and no time is remaining. If OFF, the CD Time previously set while on the surface is to be displayed with the colon solid (Fig. 136).

- Pressing and releasing the S button momentarily (< 2 seconds) will toggle between ON and OFF. If a Time has been set, a toggle from OFF to ON will start the CD TIMER indicated by the colon flashing (Fig. 137).
- Pressing the L button will activate the Backlight.
- Depressing and holding the M button for 2 seconds will revert to the FREE DIVE MAIN screen.
- If no button is pressed during a period of 10 seconds, the display will revert to the FREE DIVE MAIN screen.



Fig. 137 - FREE DIVE CDT STATUS (ON/RUNNING)

FREE DIVE ALARMS

All FREE Dive Alarms will sound 3 short beeps (1 or 2 times) as an indication that an event is occurring and as a reminder to view the display to identify the event. After the beeps have sounded, the message will be replaced with the graphic FREE.

FREE DIVE Alarms are separate and unaffected by NORM/GAUG SCUBA Mode Alarm Settings, and the Alarms that occur in those Modes are separate and unaffected by FREE DIVE Alarm Settings.

FREE CDT (Count Down Timer) Alert

When the FREE CDT decreases to 0:00 (min:sec), 3 short beeps will sound 3 times and the message TIMR will appear on the display 3 times momentarily (Fig. 138), then revert to the message FREE.



Fig. 138 - FREE DIVE MAIN (During CDT ALARM)

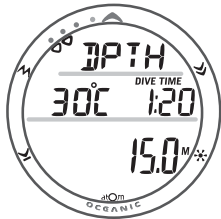

Fig. 139 - FREE DIVE MAIN
(During DEPTH ALARM)

FREE DIVE DEPTH ALARM(S)

When Depth reaches the FREE DEPTH ALARM 1 Set Point selected, 3 short beeps will sound 3 times, the red LED will flash, and the message DPTH will appear on the display 3 times momentarily (Fig. 139), then revert to the message FREE.

The beeps and message will be repeated when Depth reaches the FREE DEPTH ALARM 2 and 3 Set Points selected, if set ON.

If Ascent is made above a FREE DEPTH ALARM Set Point and then a descent is made to a Depth below it, the respective Alarm (FDA) will sound again.

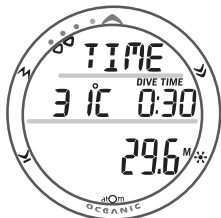

Fig. 140 - FREE DIVE MAIN
(During EDT ALARM)

FREE DIVE EDT (ELAPSED DIVE TIME) ALARM

When the FREE EDT Alarm is set ON prior to commencing a Free Dive, 3 short beeps will sound, the red LED will flash, and the message TIME will appear on the display momentarily (Fig. 140), then revert to the message FREE.

This FREE DIVE Alarm is factory set to repeat every 30 seconds during FREE DIVE Mode, when it is set ON prior to the dive.

FREE DIVE TLBG (TISSUE LOADING BAR GRAPH) ALARM

While diving in FREE DIVE Mode, nitrogen accumulation from the Free Dives and any previous NORM SCUBA Dives conducted within 24 hours is displayed as the TLBG.

When Nitrogen Loading increases to the Caution level indicated by 4 segments displayed as the TLBG and the UP Arrow appearing solid, 3 short beeps will sound 3 times, the red LED will flash, and the message UP > HIGH > NI will appear on the display (Fig. 141).

After the beeps, the message will continue to scroll until the TLBG recedes to 3 segments at which time the message will change to FREE and the UP Arrow will be removed.

ENTRY INTO DECO DURING A FREE DIVE

In the event that Nitrogen Loading increases to the Warning level indicated by all 5 segments of the TLBG and UP Arrow flashing, 3 short beeps will sound 3 times, the red LED will flash, and the message UP > VIOL will appear on the display (Fig. 142).

After the beeps, the message UP > VIOL will continue to be displayed scrolling until you surface, then the graphic VIOL will alternately be On/Off for 10 minutes after the dive.

Upon surfacing, the UP Arrow will be removed, however, the Full TLBG will continue to flash for 24 hours and dive computer operation will revert to Permanent Violation Gauge Mode until a full 24 hours elapse with no diving. Access to Watch Mode will be allowed, but access to NORM or GAUG will be blocked.

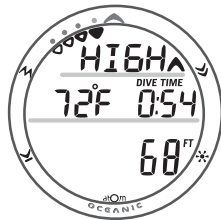

Fig. 141 - FREE DIVE MAIN
(During TLBG ALARM)

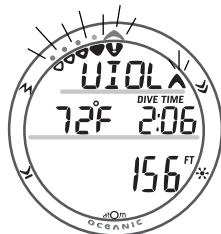

Fig. 142 - FREE DIVE MAIN
(During DECO)



WARNING: If your ATOM stops working for any reason while operating as a Dive Computer, it is important that you have anticipated this possibility and are prepared for it. This is an important reason for not pushing the no decompression and oxygen exposure limits, and a critical reason to avoid entering decompression. If you dive in situations where your trip would be ruined or your safety would be jeopardized by losing the use of your ATOM, a backup instrument system is highly recommended.

FCC ID: MH8A

FCC COMPLIANCE:

This equipment complies with Part 15 of the FCC Rules. Operation is subject to the following two conditions: 1.) this equipment may not cause harmful interference, and 2.) this equipment must accept any interference received, including interference that may cause undesired operation.

FCC INTERFERENCE STATEMENT:

This equipment has been tested and found to comply with the limits for an Intentional Radiator, a Class B Digital Device, pursuant to Part 15 of FCC Rules, Title 47 of the Code of Federal Regulations. These rules are designed to provide reasonable protection against harmful interference in a commercial or residential installation. This equipment generates, uses and can radiate radio frequency energy and, if not installed and used in accordance with the instructions, may cause harmful interference to radio communications.

There is no guarantee that interference will not occur in a particular installation. If this equipment does cause interference to radio or television reception, which can be determined by turning the equipment off and on, the user is encouraged to try to correct the interference by one or more of the following measures:

- Reorient or relocate the receiving antenna.
- Increase the separation between the equipment and receiver.
- Connect the equipment to an outlet on a circuit different from that to which the receiver is connected.
- Consult the dealer or an experienced radio/TV technician.



Warning: Changes or modifications to this unit not expressly approved by Oceanic/2002 Design could void the user's authority to operate the equipment.



WARNING: Prior to diving with the ATOM, you must also read and understand the Oceanic Dive Computer Safety and Reference Manual, Doc. No. 12-2262, which provides Important Warnings and Safety Recommendations as well as general product information.

REFERENCE

UPLOADING SETTINGS AND DOWNLOADING DATA

The ATOM is configured with a Data Port located on the back of the left side that enables it to be connected to a PC through a USB port using the special Interface Cable supplied.

A USB Driver is provided on the CD as part of the Interface System.

The Settings Upload portion of the program provided can be used to set/change the ATOM's Main Time, Date, Set A group (Alarms), and Set U group (Utilities) using the same Interface System. The Set F group (FO2) and FREE Mode Alarms must be entered using the ATOM's button controls.

Information available for retrieval (Download) from the ATOM to the PC Download portion of the program includes dive number, surface interval time, maximum depth, elapsed dive time, start date, start time, lowest temperature under water, sampling rate, dive profile, ATOM's Set Points, pressure, Air Time Remaining, OTU, OTS, TLBG, O2BG, and Gas Switching events/pressures/FO2s.

The ATOM checks for the presence of an interface device connection to the Data Port once every second while in Watch Main Time Mode. Checks are not made if the Wet Activation contacts are wet. Upon sensing an interface connection, the requesting device (PC) connects to the ATOM and is prepared for Upload of settings or Download of data which are then initiated using the PC programs.

Prior to attempting to Download data from your ATOM or Upload Settings to it, review the HELP section of the interface program. Recommended is to print those sections of HELP that you consider appropriate for your Interface activities.

PC compatibility requirements:

- IBM® or compatible, Personal Computer with USB Port
- Intel® Pentium 200 MHz or better microprocessor
- Microsoft® Windows® 98 Second Edition, ME, NT, 2000, or XP
- Super VGA card or compatible video graphics adaptor (256 color or greater) with a minimum 800 X 600 pixel screen area of display settings
- 16MB of available RAM
- 20MB of available hard drive storage
- Mouse
- CD Rom drive
- Printer (optional)

For software updates, refer to the Oceanic web site.

www.OceanicWorldwide.com

For support, call OceanLog Support toll free at -

(866) 732-7877, 8 Am to 5 Pm Pacific time.

CARE AND CLEANING

Protect your ATOM from shock, excessive temperatures, exposure to chemicals, and tampering. Protect the lens against scratches with a Instrument Lens Protector. Small scratches will naturally disappear underwater.

- Soak and rinse the ATOM in fresh water at the end of each day of diving, and check to ensure that the areas around the Low Pressure (Depth) Sensor (Fig. 143a), PC Interface Data Port (Fig. 143b), and Buttons are free of debris or obstructions. Soak and rinse the Regulator(s) with the Transmitter(s) attached.
- To dissolve salt crystals, use lukewarm water or a slightly acidic bath (50% white vinegar/50% fresh water). After removal from the bath, place the ATOM and the Regulator(s) with Transmitter(s) unit under gently running water and towel dry before storing.
- Transport your ATOM system cool, dry, and protected.

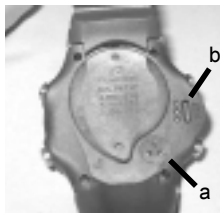

Fig. 143 - ATOM CASE BACK

INSPECTIONS AND SERVICE

Your ATOM should be inspected annually by an Authorized Oceanic Dealer who will perform a factory prescribed function check and inspection for damage or wear. To keep the 2 year limited warranty in effect, this inspection must be completed one year after purchase (+/- 30 days).

Oceanic recommends that you continue to have an inspection performed every year to ensure it is working properly. The costs of annual inspections are not covered under the terms of the 2 year limited warranty.

To Obtain Service:

Take your ATOM system to an Authorized Oceanic Dealer or send it to the nearest Oceanic Regional Distributor Facility (page 173).

To return your ATOM system to Oceanic:

- Record all dive data in the Log and/or download the data in memory. All data will be erased during factory service.
- Package it using a protective cushioning material.
- Include a legible note stating the specific reason for return, your name, address, daytime phone number, serial number(s), and a copy of your original sales receipt and Warranty Registration Card.
- Send freight prepaid and insured using a traceable method to the nearest Oceanic Regional Service Facility, or to Oceanic USA.
- If shipping to Oceanic USA, obtain an RA (Return Authorization) number by contacting Oceanic at 510/562-0500 or send an e-mail to service@oceanicusa.com.
- Non-warranty service must be prepaid. COD is not accepted.
- Additional information is available at the Oceanic web site OceanicWorldwide.com

BATTERY REPLACEMENT

△ NOTE: The procedures that follow must be closely adhered to. Damage due to improper Battery replacement is not covered by the ATOM's 2 year warranty.

When replacing the Battery in the ATOM, it is recommended that you also replace the Battery(s) in the Transmitter(s), and vice-versa.

The Battery Compartment(s) should only be opened in a dry and clean environment with extreme care taken to prevent the entrance of moisture or dust.

As an additional precautionary measure to prevent formation of moisture in the Battery Compartment(s), it is recommended that the Battery(s) be changed in an environment equivalent to the local outdoor temperature and humidity (e.g., do not change the Battery(s) in an air conditioned environment then take it outside during a hot sunny day).

Inspect the Buttons, Lens, and Housing(s) to ensure they are not cracked or damaged. If there is any sign of moisture in the ATOM or Transmitter(s), DO NOT attempt to use the ATOM for diving (NORM, GAUG, or FREE) until it receives proper service by the Oceanic factory or an Authorized Regional Distributor.

Hot Swap

If the new Battery can be inserted into the ATOM within 8 seconds after the old one is removed (referred to as a Hot Swap), settings and nitrogen and oxygen calculations for repetitive dives will be retained.

⚠ CAUTION: Damage due to improper Battery replacement is not covered by the product's limited 2 year warranty.

ATOM (Watch) Battery Removal

- Locate the Battery Compartment on the back of the unit.
- Rotate the Battery Hatch clockwise 10 degrees using the special Battery Hatch Tool provided (Fig. 144), or by pushing the lower portion to the left while pushing the upper portion to the right (Fig. 145).
- Lift the Hatch with O-ring up and away from the Housing.
- Using care not to damage the Contact (Fig. 146a), slide the Battery up and out of the Left side of the Battery Compartment.
- Discard the Battery according to local regulations governing disposal of Lithium batteries.

⚠ CAUTION: DO NOT allow a metal object to short circuit the top of the Battery which is positive (+) to the negative (-) contact of the Battery Compartment.



Fig. 144 - BATTERY HATCH REMOVAL (Tool)



Fig. 145 - ALTERNATE HATCH REMOVAL



Fig. 146 - ATOM BATTERY REMOVAL

Transmitter Battery Removal

Locate the Battery Hatch on the End of the Housing:

- Apply a coin to the recessed slot of the Hatch and turn it counter clockwise out of the Housing (Fig. 147).
- Remove the Battery from the Battery Compartment and discard according to local regulations governing disposal of Lithium batteries.

Inspection

- Closely check all of the sealing surfaces for any signs of damage that might impair proper sealing.
- Inspect the Buttons, Lens, and Housing(s) to ensure they are not cracked or damaged.



WARNING: If damage or corrosion is found, return your ATOM system to an Authorized Oceanic Dealer, and DO NOT attempt to use it until it has received factory prescribed service.

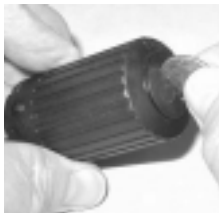

Fig. 147 - TMT BATTERY
HATCH REMOVAL

- Remove the Battery Hatch O-ring(s) and inspect them for any signs of deterioration or deformity. DO NOT use tools to remove the O-ring(s).
- To ensure proper sealing, O-ring replacement is highly recommended each time a Battery is replaced.

Inspection (continued) -

- Closely examine the threads of the Battery Hatch(es) and Housing(s) for any signs of damage that might prevent proper threading.
- Closely examine the inside of the Battery Compartment(s) for any signs of corrosion indicating entrance of moisture into the unit.
- If corrosion is found, return the ATOM system to an Authorized Oceanic Dealer, and DO NOT attempt to use it until it has received factory service.
- If moisture is found, it is best to have the unit inspected and cleaned by an Authorized Oceanic Dealer.
- If it is necessary to clean the Battery Compartment, flush it and all components with a solution of 50% white vinegar and 50% fresh water. Rinse with fresh water, and allow to dry overnight, or blow dry with a hair dryer set at no heat.

ATOM (Watch) Battery Installation

- Slide a new 3 volt type CR2430 Lithium Battery, negative side down into the Battery Cavity. Slide it in from the Left side (Fig. 148) and ensure that it slides under the contact clip on the lower/right rim of the cavity.
- Lightly lubricate the new Hatch O-ring with silicone grease and place it on the inner rim of the Battery Hatch. Ensure that it is evenly seated (Fig. 149).



Fig. 148 - ATOM BATTERY INSTALLATION

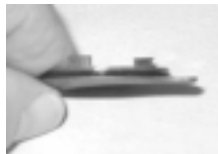

Fig. 149 - ATOM BATTERY HATCH O-RING



Fig. 150 - ATOM BATTERY HATCH INSTALLATION



Fig. 151 - ALT BATTERY HATCH INSTALLATION

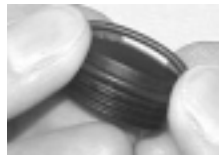

Fig. 152 - TMT O-RING INSTALLATION

△ NOTE: The ATOM's O-ring must be a genuine Oceanic part that can be purchased from an Authorized Oceanic Dealer. Use of any other O-ring will void the warranty.

- Carefully place the Battery Hatch (with O-ring) into position on the rim of the Battery Compartment, then press it evenly and completely down into place.
- Maintain the Battery Hatch securely in place and turn it counter clockwise 10 degrees using the special Battery Hatch tool provided (Fig. 150), or by pushing the lower portion to the right while pushing the upper portion to the left (Fig. 151).

Transmitter Battery Installation

- Lightly lubricate the new Battery Cap O-ring with silicone grease and install it onto the Battery Cap. **DO NOT** roll the O-ring over the Threads, instead stretch it slightly to work it down over the slotted end of the Cap into the Groove at the Base of the Threads (Fig. 152).

△ NOTE: The TMT's O-ring must be a genuine Oceanic part that can be purchased from an Authorized Oceanic Dealer. Use of any other O-ring will void the warranty.

- Place a new 3 volt, CR2, Lithium Battery (Duracell model DL-CR2 or equivalent) positive (+) side down into the Battery Compartment with the negative end facing up/out (Fig. 153).
- Ensure that the Battery is properly oriented and the Hatch O-ring is evenly seated around the Battery Hatch.
- Carefully place the Battery Hatch with Spring into the Housing and turn clockwise slowly by hand to ensure proper threading. Apply a coin and tighten until secure. The outer surface of the Battery Hatch should be flush with the outer surface of the Housing (Fig. 154).

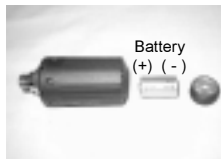

Fig. 153 - TMT BATTERY ORIENTATION

ATOM System Testing

- Observe the LCD display to ensure it is consistently clear and sharp in contrast throughout the screen.
- Set the Date Time, Alternate Time, and Daily Alarm.
- Verify all Set Points prior to diving.
- Pressurize the Regulator Assembly (and Transmitter).
- Verify that the Link icon is displayed.
- Press the S button for 2 seconds to check the Status screens.
- If any portions of the display are missing or appear dim, or if a Low Battery Condition is indicated, return your ATOM to an Authorized Oceanic Dealer for a complete evaluation before attempting to use it.



Fig. 154 - TMT BATTERY HATCH INSTALLED

INSTALLING A TRANSMITTER ON A REGULATOR

To install the Transmitter on the Regulator First Stage:

- Remove the existing Pressure Gauge and High Pressure Hose, or the High Pressure Port Plug from the Port marked HP using the proper size Hex Key.
- Lightly lubricate the O-ring and Threads of the Transmitter fitting with a halocarbon based lubricant such as Christo-Lube MCG 111 (provided in Oceanic Battery Kits).
- Thread the Transmitter clockwise by hand into the Regulator's HP Port (Fig. 155) and tighten until secure with a 5/8" open-end wrench.
- Attach the Regulator First Stage to a full Scuba Tank and pressurize by slowly opening the Tank Valve, listening for any indication of air leaking around the Fitting.
- If air leakage is present, DO NOT use, take the complete Regulator Assembly to an Authorized Oceanic dealer for inspection and service.



Fig. 155 -INSTALLING A
TMT ON A REGULATOR

TRANSMITTER COMPATIBILITY WITH NITROX

When packaged and shipped from the factory, Oceanic ATOM Transmitters are rated for use with compressed Air and/or nitrogen-oxygen (Nitrox) breathing gas mixtures containing up to 99% O₂ by volume and with 100% O₂.

ALTITUDE SENSING AND ADJUSTMENT

Prior to the first dive of a series of repetitive dives, ALTITUDE (i.e., Ambient Pressure) is measured upon activation of Dive Surface Mode and every 15 minutes until a dive is made or operation reverts to Main Time after 2 hours.

- > While it is operating in Watch Modes after a dive, measurements are taken every 15 minutes during the 24 hour period after surfacing.
- > Measurements are only taken when the unit is dry.
- > Two readings are taken, the second reading 5 seconds after the first. The readings must be within 1 foot (30 cm) of each other to record that Ambient Pressure as the current ALTITUDE.

The Mathematical Model in the ATOM accounts for the reduced No Decompression dive Time available based on National Oceanic and Atmospheric Administration (NOAA) guidelines.

When diving in high altitude waters from 2,000 to 14,000 feet (610 to 4,270 meters), the ATOM automatically adjusts to these conditions providing corrected Depth, reduced No Decompression Times, and reduced Oxygen Accumulation Times at intervals of 1,000 feet (305 meters).

No adjustments are made during any time that the Wet Contacts are bridged.

At an elevation of 2,000 feet (610 meters), Depth Calibration automatically changes from feet of seawater to feet of fresh water. This is the first adjustment to the Algorithm.

When the Conservative Factor feature is set ON, allowable dive times are calculated based upon the next higher 3,000 foot (915 meter) Altitude. All adjustments for Altitudes greater than 11,000 feet (3,355 meters) are then made to allowable dive times for 14,000 feet (4,270 meters). If the Conservative Factor is set ON while at Sea Level, calculations are based upon an Altitude of 3,000 feet.

The ATOM will not function as a Dive Computer above 14,000 feet (4,270 meters).

IMPERIAL NO DECOMPRESSION LIMITS (HOURS:MINUTES) AT ALTITUDE

Altitude [feet]	0'	2001'	3001'	4001'	5001'	6001'	7001'	8001'	9001'	10001'	11001'	12001'	13001'
	to 2000'	to 3000'	to 4000'	to 5000'	to 6000'	to 7000'	to 8000'	to 9000'	to 10000'	to 11000'	to 12000'	to 13000'	to 14000'
Depth [feet]													
30	4:20	3:35	3:21	3:07	2:55	2:45	2:36	2:28	2:21	2:15	2:10	2:04	1:58
40	2:17	1:53	1:43	1:36	1:30	1:25	1:20	1:16	1:12	1:09	1:06	1:03	1:01
50	1:21	1:07	1:03	1:00	0:58	0:55	0:52	0:48	0:45	0:43	0:41	0:39	0:37
60	0:57	0:46	0:43	0:40	0:38	0:36	0:34	0:33	0:31	0:30	0:29	0:28	0:27
70	0:40	0:33	0:31	0:30	0:28	0:27	0:26	0:24	0:23	0:22	0:20	0:19	0:18
80	0:30	0:26	0:24	0:23	0:21	0:20	0:19	0:18	0:17	0:16	0:16	0:14	0:13
90	0:24	0:20	0:19	0:18	0:17	0:16	0:15	0:14	0:13	0:12	0:11	0:10	0:10
100	0:19	0:16	0:15	0:14	0:13	0:12	0:11	0:10	0:10	0:09	0:09	0:08	0:08
110	0:16	0:13	0:12	0:11	0:10	0:09	0:09	0:08	0:08	0:08	0:07	0:07	0:07
120	0:13	0:10	0:09	0:09	0:08	0:08	0:08	0:07	0:07	0:07	0:06	0:06	0:06
130	0:11	0:09	0:08	0:08	0:07	0:07	0:07	0:06	0:06	0:06	0:06	0:05	0:05
140	0:09	0:07	0:07	0:07	0:06	0:06	0:06	0:06	0:06	0:05	0:05	0:05	0:05
150	0:08	0:07	0:06	0:06	0:06	0:05	0:05	0:05	0:05	0:05	0:04	0:04	0:04
160	0:07	0:06	0:06	0:05	0:05	0:05	0:05	0:05	0:04	0:04	0:04	0:04	0:04
170	0:07	0:05	0:05	0:05	0:05	0:04	0:04	0:04	0:04	0:04	0:04	0:04	0:03
180	0:06	0:05	0:05	0:05	0:04	0:04	0:04	0:04	0:04	0:04	0:03	0:03	0:03
190	0:05	0:05	0:04	0:04	0:04	0:04	0:04	0:04	0:03	0:03	0:03	0:03	0:03

METRIC NO DECOMPRESSION LIMITS (HOURS:MINUTES) AT ALTITUDE

Altitude [meters]	0'	611'	916'	1221'	1526'	1831'	2136'	2441'	2746'	3051'	3356'	3661'	3966'
	to 610'	to 915'	to 1220'	to 1525'	to 1830'	to 2135'	to 2440'	to 2745'	to 3050'	to 3355'	to 3660'	to 3965'	to 4270'
Depth [meters]													
9	4:43	3:51	3:37	3:24	3:10	2:58	2:48	2:39	2:31	2:24	2:18	2:12	2:07
12	2:24	2:03	1:52	1:44	1:37	1:30	1:25	1:21	1:17	1:13	1:10	1:07	1:04
15	1:25	1:10	1:06	1:03	1:00	0:57	0:55	0:52	0:49	0:46	0:43	0:41	0:39
18	0:59	0:49	0:45	0:42	0:40	0:38	0:36	0:34	0:32	0:31	0:30	0:29	0:28
21	0:41	0:34	0:33	0:31	0:29	0:28	0:27	0:26	0:24	0:23	0:21	0:20	0:19
24	0:32	0:27	0:26	0:24	0:22	0:21	0:20	0:19	0:18	0:17	0:16	0:15	0:14
27	0:25	0:21	0:19	0:18	0:17	0:16	0:16	0:14	0:13	0:12	0:12	0:11	0:10
30	0:20	0:17	0:16	0:15	0:13	0:12	0:12	0:11	0:10	0:10	0:09	0:09	0:08
33	0:17	0:14	0:12	0:11	0:11	0:10	0:09	0:09	0:08	0:08	0:08	0:07	0:07
36	0:14	0:11	0:10	0:09	0:09	0:08	0:08	0:07	0:07	0:07	0:06	0:06	0:06
39	0:11	0:09	0:08	0:08	0:07	0:07	0:07	0:06	0:06	0:06	0:06	0:05	0:05
42	0:09	0:08	0:07	0:07	0:07	0:06	0:06	0:06	0:05	0:05	0:05	0:05	0:05
45	0:08	0:07	0:06	0:06	0:06	0:06	0:05	0:05	0:05	0:05	0:05	0:04	0:04
48	0:07	0:06	0:06	0:06	0:05	0:05	0:05	0:05	0:04	0:04	0:04	0:04	0:04
51	0:06	0:06	0:05	0:05	0:05	0:05	0:04	0:04	0:04	0:04	0:04	0:04	0:04
54	0:06	0:05	0:05	0:05	0:05	0:04	0:04	0:04	0:04	0:04	0:03	0:03	0:03
57	0:05	0:05	0:04	0:04	0:04	0:04	0:04	0:04	0:03	0:03	0:03	0:03	0:03

**OXYGEN EXPOSURE LIMITS
(from NOAA Diving Manual)**

PO2 [ATA]	Max Duration Single Exposure		Max Total Duration 24 Hour Day	
	[min]	[hr]	[min]	[hr]
0.60	720	12.0	720	12.0
0.70	570	9.5	570	9.5
0.80	450	7.5	450	7.5
0.90	360	6.0	360	6.0
1.00	300	5.0	300	5.0
1.10	240	4.0	270	4.5
1.20	210	3.5	240	4.0
1.30	180	3.0	210	3.5
1.40	150	2.5	180	3.0
1.50	120	2.0	180	3.0
1.60	45	.75	150	2.0

SPECIFICATIONS

CAN BE USED AS

- Watch
- Dive Computer (Air or Nitrox)
- Digital Depth Gauge/Timer
- Free Dive activity
- With or without up to 3 Transmitters

NO DECOMPRESSION MODEL

Basis:

- Modified Haldanean Algorithm
- 12 tissue compartments

Data Base:

- Diving Science and Technology (DSAT) - Rogers/Powell

Dive Computer Performance:

- Tissue compartment halftimes (mins.) Spencer's "M" values
5, 10, 20, 40, 80, 120, 160, 200, 240, 320, 400, 480
- Reciprocal subsurface elimination
- 60 minute surface credit control for compartments faster than 60 minutes
- Tissue compartments tracked up to 24 hours after last dive

Decompression Capabilities (stop ceilings):

- 10, 20, 30, 40, 50, and 60 FT
(3, 6, 9, 12, 15, and 18M)

Altitude Algorithm and Oxygen Exposure Limits:

- Based on NOAA tables

TRANSMITTERS

- Battery and Pressure check
 - > every 2 minutes when asleep
 - > every 2 seconds when awake
- Startup
 - > Pressure equal or greater than 120 PSI (8 BAR)
 - > Battery equal or greater than 2.75 volts
- Shutdown
 - > Pressure less than 50 PSI (3.5 BAR)

WATCH MODES

- Main Time (home)
 - > Set Time/Date
- Alternate Time (remote location)
 - > Set Alternate Time (hour differential)
- Countdown Timer
 - > Set/Start/Stop
- Chronograph (Stop Watch/Lap Timer)
 - > Start/Stop/Lap Recall/Reset
- Daily Alarm (Watch Mode)
 - > Set Time, On/Off

DIVE COMPUTER SURFACE SEQUENCE/MODES

- NORM/GAUG/FREE Surface Mode
- Plan (30 to 190 FT/9 to 57 M) - NORM only
- Time to Fly Countdown - NORM/GAUG
- Time to Desaturation Countdown - NORM only
- Dive Log - NORM/GAUG
- History - NORM/GAUG
- Oxygen Data (after Nitrox dives)
- Battery/Tank Pressure Status - NORM/GAUG
- Set FO₂, Alarms, Utilities - NORM/GAUG

SPECIFICATIONS (CONTINUED)

NORM/GAUG SET MODES

- Set F Group (FO2 items):
 - > FO2 GAS1 (Air, 21 to 50%)
 - > FO2 GAS2 (Air, 21 to 100%)
 - > FO2 GAS3 (Air, 21 to 100%)
 - > FO2 Default (On/Off)
 - Set A Group (Alarms):
 - > Audible Alarm / LED Warning (On/Off)
 - > Max Depth Alarm (30 to 330 FT /10 to 100 M)
 - > Elapsed Dive Time Alarm (:10 to 3:00 hr:min)
 - > Max TLBG Alarm (1 to 5 segments)
 - > Dive Time Remaining Alarm (:00 to :20 min)
 - > Turn Press Alarm (Off, 1000 to 3000 PSI / 70 to 205 BAR)
 - > End Press Alarm (300 to 1500 PSI / 20 to 105 BAR)
 - > Max PO2 Alarm (1.20 to 1.60 ATA)
 - Set U Group (Utilities):
 - > Wet Activation (On/Off)
 - > Units of Measure (Imperial / Metric)
 - > Safety Stop Time, Depth (Off/3/5 minutes, 10/15/20 FT, 3/4/5/6 M)
 - > Conservative Factor (On/Off)
 - > Backlight Duration (0/5/10 seconds)
 - > Sampling Rate (2/15/30/60 seconds)
 - > Transmitter 1 Link Code (Off/On, 000000 to 999999)
 - > Transmitter 2-3 Use (Self/Bud)
 - > Transmitter 2 Link Code (Off/On, 000000 to 999999)
 - > Transmitter 3 Link Code (Off/On, 000000 to 999999)
 - ATOM (Watch) Serial Number
 - > Factory set
- Factory Settings:
> Air
> Air
> Air
> On

> On
> 330 FT
> 3:00 (hr:min)
> 5 segments (Deco)
> :20 (min)
> Off
> 300 PSI
> 1.60 (ATA)

> On
> Imperial
> 3:00 (min:sec)
> Off
> :05 (sec)
> 15 (sec)
> serial no.
> Self
> serial no.
> serial no.

SPECIFICATIONS (CONTINUED)

NORM No Decompression Dive Displays:

- Main (default) - TLBG, Pressure, Dive Time Remaining, Current Depth
- Alternate #1 - TLBG, Tank Identifier, Pressure, Elapsed Dive Time, Air Time Remaining, Max Depth
- Alternate #2 - O2BG, Gas Identifier, Current PO2, FO2 Set Point, Current Depth
- Secondary - Day of Week, Temperature, Time of Day (hr:min:sec)
- Safety Stop - TLBG, Pressure, Stop Depth, Stop Time, Dive Time Remaining, Current Depth

NORM Decompression Dive Displays:

- Main (default) - TLBG, Stop Depth, Mode Identifier, Pressure, Stop Time, Total Ascent Time, Current Depth
- Alternate #1 - TLBG, Tank Identifier, Pressure, Elapsed Dive Time, Air Time Remaining, Max Depth
- Alternate #2 - O2BG, Gas Identifier, Current PO2, FO2 Set Point, Current Depth
- Secondary - Day of Week, Temperature, Time of Day (hr:min:sec)

NORM Violation Modes (displays similar to Deco) - Conditional, Delayed, and Immediate/Violation Gauge

NORM High PO2 (1.20 to 1.60 ATA)

NORM High Oxygen Accumulation (300 OTU per dive / 24 hr)

NORM Gas Switch Preview (TMT 2-3 Use set for SELF) - TLBG, Gas Identifier, FO2 Set, Current Depth

NORM Buddy Pressure Check (TMT 2-3 Use set for BUD) - BUDDY Identifier, Pressure

GAUG Dive Displays:

- Main (default) - Mode graphic GAUG, Pressure, Current Depth
- Alternate - TMT 1 graphic, Pressure, Elapsed Dive Time, Air Time Remaining, Max Depth
- Secondary - Day of Week, Temperature, Time of Day (hr:min:sec)

FREE Dive Displays:

- Main (default) - Mode graphic FREE, Temperature, Elapsed Dive Time, Current Depth
- CDT Status - graphic TIMR (Timer), Timer Setting (On/Off), Countdown Time Remaining (min:sec)
- Secondary - Day of Week, Temperature, Time of Day (hr:min:sec)

SPECIFICATIONS (CONTINUED)

<u>NUMERIC DISPLAYS:</u>	<u>Range:</u>	<u>Resolution:</u>
• Dive Number	0 to 24	1
• Current Depth	0 to 330 FT (100 M)	1 FT (.1 M)
• Maximum Depth	330 FT (100 M)	1 FT (.1 M)
• Gas 1 FO2 Set Point	Air, 21 to 50 %	1 %
• Gas 2 FO2 Set Point	Air, 21 to 100 %	1 %
• Gas 2 FO2 Set Point	Air, 21 to 100 %	1 %
• PO2 Value	0.00 to 5.00 ATA	.01 ATA
• Dive Time Remaining	0:00 to 9:59 hr:min	1 minute
• Air Time Remaining	0:00 to 9:59 hr:min	1 minute
• Total Ascent Time	0:00 to 9:59 hr:min	1 minute
• No Deco Safety Stop Time	5:00 to 0:00 min:sec	1 second
• Decompression Stop Time	0:00 to 9:59 hr:min	1 minute
• Norm/Gaug Elapsed Dive Time	0:00 to 9:59 hr:min	1 minute
• Free Elapsed Dive Time	0:00 to 59:59 min:sec	1 second
• Surface Interval Time	0:00 to 23:59 hr:min	1 minute
• Free Surface Interval Time	0:00 to 59:59 min:sec	1 second
	1:00 to 23:59 hr:min	1 minute
• Dive Log Surface Interval	0:00 to 23:59 hr:min	1 minute
• Time to Fly	23:50 to 0:00 hr:min*	1 minute
	(* starting 10 min after the dive)	
• Time to Desaturate	23:50 max to 0:00 hr:min*	1 minute
	(* starting 10 min. after the dive)	
• Temperature	0 to 140°F (-9 to 60°C)	1°
• Cylinder Pressure	0 to 5000 PSI (345 BAR)	5 PSI (1 BAR)
• Time of Day	0:00:00 to 23:59:59 hr:min.sec	1 second
• Watch Countdown Timer	23:59 to 0:00 hr:min	1 minute
• Free Countdown Timer	59:59 to 0:00 min:sec	1 second
• Chronograph	0:00:00.00 to 99:59:59.99 hr:min:sec.1/100 sec	1/100 second
• Out of Range (- - -)	=> 330 FT (100 M)	
• Violation Countdown Timer	23:50 to 0:00 hr:min (after violation)	

SPECIFICATIONS (CONTINUED)

BAR GRAPH

<u>Tissue Loading Bar Graph:</u>	<u>segments</u>	<u>Oxygen (O2) Bar Graph:</u>	<u>segments</u>
• No Decompression zone	1 to 4	• Normal zone	1 to 4
• Decompression zone	5 (all)	• Danger zone	5 (all)

OPERATIONAL PERFORMANCE

Function:	<u>Accuracy:</u>
• Depth	±1% of full scale
• Timers	1 second per day

Dive Counter:

- NORM/GAUG displays Dives #1 to 24, FREE displays #1 to 99 0 if no dive made yet
- Resets to Dive #1, upon diving (after 24 hours with no dives)

NORM/GAUG Dive Log Mode:

- Stores 24 most recent NORM/GAUG dives in memory for viewing
- After 24 dives, adds 25th dive in memory and deletes the older dive

Altitude:

- Operational from sea level to 14,000 feet (4,270 meters) elevation
- Measures ambient pressure every 30 minutes in Watch Mode and when Dive Computer Mode is accessed, every 15 minutes while in NORM/GAUG/FREE Surface Modes.
- Does not measure ambient pressure when Wet.
- Compensates for Altitudes above sea level beginning at 2,000 feet (610 meters) elevation and every 1,000 feet (305 meters) higher.

Conservative Factor:

- Reduces NORM NDLS to those for the Altitude 3,000 feet (915 meters) higher.

SPECIFICATIONS (CONTINUED)

OPERATIONAL PERFORMANCE (continued)

Power:

- ATOM (Watch) Battery 1 - 3 vdc, CR2430, Lithium battery
- Transmitter Battery 1 - 3 vdc, CR2, .75 Ahr, Lithium battery (Duracell model DL-CR2 or equivalent)
- Shelf life Up to 7 years (when shipped from factory in Deep Sleep mode)
- Replacement User replaceable (annual recommended)
- Use Life (ATOM) 1 year or 300 dive hours if 2 - 1 hour dives per dive day
- Use Life (Transmitter) 300 dive hours if 2 - 1 hour dives per dive day

Battery Indicator:

- Warning - icon on solid at 2.75 volts, ATOM Battery change recommended
- Alarm - icon on flashing at 2.50 volts, change the ATOM Battery

Dive Computer Mode Activation:

- Manual - push button (recommended), required if Wet Activation is set OFF.
- Automatic - by immersion in water (if set ON)
- Graphic WET indicates Activation Contacts are Wet (unit must be dried prior to transport or storage)
- Cannot be manually activated deeper than 4 FT (1.2 M), if Water Activation is set OFF.
- Cannot operate as a Dive Computer at elevations higher than 14,000 feet (4,270 meters)
- Reverts to Main Time if no dive is made within 2 hours after entry into a Surface Mode.
- Reverts to Main Time 2 hours after last dive.

Operating Temperature:

- Out of the water - between 20 °F and 140 °F (-6 and 60 °C).
- In the water - between 28 °F and 95 °F (-2 and 35 °C).
- At extremely low temperatures, the LCD may become sluggish, but this will not affect it's accuracy. If stored or transported in extremely low temperature areas (below freezing), you should warm the unit and its battery with body heat before diving.

Storage Temperature:

- Out of the water (in storage case provided) - between 14 °F and 158 °F (-8 and 70 °C).

INSPECTION / SERVICE RECORD

ATOM 2.0 Serial Number: _____

ATOM 2.0 Firmware Revision: _____

Transmitter #1 Serial Number: _____

Transmitter #2 Serial Number: _____

Transmitter #3 Serial Number: _____

Date of Purchase: _____ Purchased from: _____

Below to be filled in by an Authorized Oceanic Dealer:

Date	Service Performed	Dealer / Technician

OCEANIC WORLD WIDE

OCEANIC USA

2002 Davis Street
San Leandro, CA 94577
Tel: 510/562-0500
Fax: 510/569-5404

Web site: <http://www.OceanicWorldwide.com>
service@oceanicusa.com

Oceanic Central/North Europe Wendelstein, Germany

Tel: 09129-9099780 Fax: 09129-9099789
E-mail: office@oceanic.de

Oceanic South Europe Genova, Italy

Tel: 0039-010-8382006 Fax: 0039-010-8365360
E-mail: info@oceanicse.it

Oceanic SW, Ltd Devon, United Kingdom

Tel: 44-1-404-89-1819 Fax: 44-1-404-89-1909
E-mail: info@oceanicuk.com

Oceanic France Marseille, France

Tel: 0033.491.25.37.78 Fax: 0033.491.72.34.48
E-mail: oceanicfrance@wanadoo.fr

Oceanic Diving Australia Pty. Ltd Sorrento, Victoria, Australia

Tel: 61-3-5984-4770 Fax: 61-3-5984-4307
E-mail: sales@oceanicaus.com.au

Oceanic Asia-Pacific Pte. Ltd Singapore

Tel: 65-6391-1420 Fax: 65-6297-5424
E-mail: info@oceanicasia.com.sg

Oceanic Japan Yokohama, Japan

Tel: 045-575-6671 Fax: 045-575-6673
E-mail: oceanic@gol.com

Oceanic International (Pacific) Kapolei, Hawaii

Tel: 808-682-5488 Fax: 808-682-1068
E-mail: oceanichi@oceanicusa.com

OCEANIC Original functions board

Standard functions



Dive mode



Gauge mode



Free dive mode



Watch mode



Oceanic Worldwide
2002 Davis Street
San Leandro,
CA 94577
USA

Phone :
(510) 562-0500
Fax :
(510) 569-5404

www.
OceanicWorldwide.com



Doc. No. 12-2698-r01
[10/15/05] - Copyright
2002 Design, 2005

Standard functions :

1. Alpha numeric display.
2. Oceanic bargraph.
3. upload and download (USB).
4. OceanGlo® Backlight.
5. Audio visual LED alarm.
6. Alarm acknowledgment.
7. Consumer replaceable battery.

Dive mode :

8. Wireless air technology, 3 independant transmitters.
9. Buddy pressure check.
10. Up to 3 Nitrox mixes.
11. Custom conservative factor.
12. Adjustable safety stop & depth.
13. History access.
14. Log book.
15. Turn pressure alarm.
16. Air time remaining.
17. Automatic altitude adjustment.

Free dive mode :

- > 1 second sampling.
- > Min: Sec dive time.
- > Elapsed dive time alarm.
- > Multiple max depth alarms.
- > Count down timer.
- > Nitrogen tissue loading bargraph.

Watch mode :

- > Alternate time zone.
- > Lap timer.
- > Daily alarm.
- > Countdown timer.

Free Manuals Download Website

<http://myh66.com>

<http://usermanuals.us>

<http://www.somanuals.com>

<http://www.4manuals.cc>

<http://www.manual-lib.com>

<http://www.404manual.com>

<http://www.luxmanual.com>

<http://aubethermostatmanual.com>

Golf course search by state

<http://golfingnear.com>

Email search by domain

<http://emailbydomain.com>

Auto manuals search

<http://auto.somanuals.com>

TV manuals search

<http://tv.somanuals.com>