

Instruction manual

ESPAÑOL: PÁGINA 29
FRANÇAIS: PAGE 57

MODEL
C5510

Oillube Single-Stage Portable Compressor

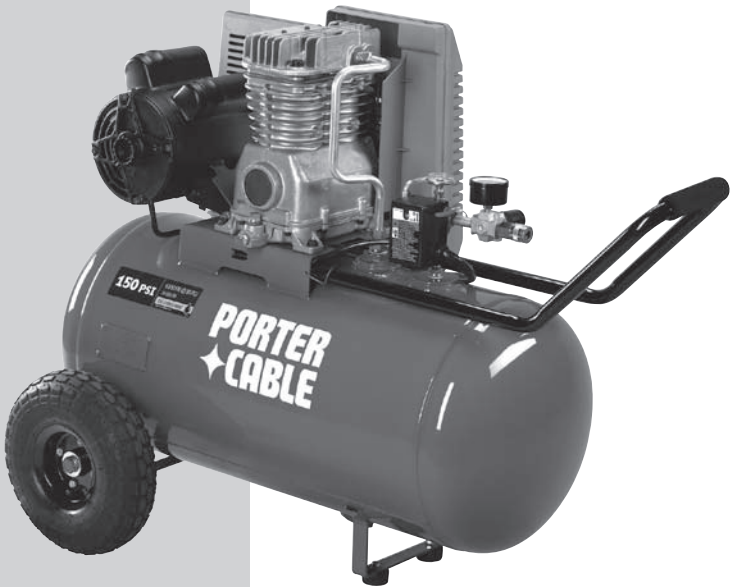

To learn more about Porter-Cable
visit our website at:

<http://www.porter-cable.com>

PORTER CABLE

IMPORTANT

Please make certain that the person who is to use this equipment carefully reads and understands these instructions before starting operations.

The Model and Serial No. plate is located on the frame. Record these numbers in the spaces below and retain for future reference.

Model No. _____

Type _____

Serial No. _____

SAFETY GUIDELINES - DEFINITIONS

This manual contains information that is important for you to know and understand. This information relates to protecting **YOUR SAFETY** and **PREVENTING EQUIPMENT PROBLEMS**. To help you recognize this information, we use the symbols below. Please read the manual and pay attention to these symbols.

⚠ DANGER Indicates an imminently hazardous situation which, if not avoided, will result in death or serious injury .	⚠ CAUTION Indicates a potentially hazardous situation which, if not avoided, may result in minor or moderate injury .
⚠ WARNING Indicates a potentially hazardous situation which, if not avoided, could result in death or serious injury .	CAUTION Used without the safety alert symbol indicates a potentially hazardous situation which, if not avoided, may result in property damage .

IMPORTANT SAFETY INSTRUCTIONS

⚠ WARNING Some dust created by power sanding, sawing, grinding, drilling, and other construction activities contains chemicals known (to the State of California) to cause cancer, birth defects or other reproductive harm. Some example of these chemicals are:

- lead from lead-based paints
- crystalline silica from bricks and cement and other masonry products
- arsenic and chromium from chemically-treated lumber

Your risk from these exposures varies, depending on how often you do this type of work. To reduce your exposure to these chemicals: work in a well ventilated area, and work with approved safety equipment, always wear MSHA/NIOSH approved, properly fitting face mask or respirator when using such tools.

When using air tools, basic safety precautions should always be followed to reduce the risk of of personal injury.

IMPORTANT SAFETY INSTRUCTIONS



Save these instructions



Improper operation or maintenance of this product could result in serious injury and property damage. Read and understand all warnings and operation instructions before using this equipment.

HAZARD

WARNING: Risk of explosion or fire



What Could Happen	How To Prevent It
<p>It is normal for electrical contacts within the motor and pressure switch to spark.</p>	<p>Always operate the compressor in a well ventilated area free of combustible materials, gasoline, or solvent vapors.</p>
<p>If electrical sparks from compressor come into contact with flammable vapors, they may ignite, causing fire or explosion.</p>	<p>If spraying flammable materials, locate compressor at least 20 feet away from spray area. An additional length of hose may be required. Store flammable materials in a secure location away from compressor.</p>
<p>Restricting any of the compressor ventilation openings will cause serious overheating and could cause fire.</p>	<p>Never place objects against or on top of compressor. Operate compressor in an open area at least 12 inches away from any wall or obstruction that would restrict the flow of fresh air to the ventilation openings. Operate compressor in a clean, dry well ventilated area. Do not operate unit indoors or in any confined area.</p>
<p>Unattended operation of this product could result in personal injury or property damage. To reduce the risk of fire, do not allow the compressor to operate unattended.</p>	<p>Always remain in attendance with the product when it is operating. Always disconnect electrical power by moving pressure switch lever to the off position and drain tank daily or after each use.</p>

HAZARD

WARNING: Risk of Bursting



Air Tank: The following conditions could lead to a weakening of the tank, and result in a violent tank explosion and could cause property damage or serious injury.

What Could Happen	How To Prevent It
Failure to properly drain condensed water from tank, causing rust and thinning of the steel tank.	Drain tank daily or after each use. If tank develops a leak, replace it immediately with a new tank or replace the entire compressor.
Modifications or attempted repairs to the tank. Unauthorized modifications to the unloader valve, safety valve, or any other components which control tank pressure.	Never drill into, weld, or make any modifications to the tank or its attachments.
Excessive vibration can weaken the air tank and cause rupture or explosion	The tank is designed to withstand specific operating pressures. Never make adjustments or parts substitutions to alter the factory set operating pressures.
<u>ATTACHMENTS & ACCESSORIES:</u> Exceeding the pressure rating of air tools, spray guns, air operated accessories, tires, and other inflatables can cause them to explode or fly apart, and could result in serious injury.	For essential control of air pressure, you must install a pressure regulator and pressure gauge to the air outlet (if not equipped) of your compressor. Follow the equipment manufacturers recommendation and never exceed the maximum allowable pressure rating of attachments. Never use compressor to inflate small low pressure objects such as children's toys, footballs, basketballs, etc.

HAZARD

WARNING: Risk from Flying Objects

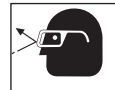

What Could Happen	How To Prevent It
The compressed air stream can cause soft tissue damage to exposed skin and can propel dirt, chips, loose particles , and small objects at high speed , resulting in property damage or personal injury.	Always wear ANSI Z87.1 approved safety glasses with side shields when using the compressor. Never point any nozzle or sprayer toward any part of the body or at other people or animals. Always turn the compressor off and bleed pressure from the air hose and tank before attempting maintenance, attaching tools or accessories.

HAZARD

WARNING: Risk of Electrical Shock



What Could Happen	How To Prevent It
<p>Your air compressor is powered by electricity. Like any other electrically powered device, if it is not used properly it may cause electric shock.</p>	<p>Never operate the compressor outdoors when it is raining or in wet conditions. Never operate compressor with protective covers removed or damaged.</p>
<p>Repairs attempted by unqualified personnel can result in serious injury or death by electrocution.</p>	<p>Any electrical wiring or repairs required on this product should be performed by authorized service center personnel in accordance with national and local electrical codes.</p>
<p>Electrical Grounding: Failure to provide adequate grounding to this product could result in serious injury or death from electrocution. See grounding instructions.</p>	<p>Make certain that the electrical circuit to which the compressor is connected provides proper electrical grounding, correct voltage and adequate fuse protection.</p>

HAZARD

WARNING: Risk to Breathing



What Could Happen	How To Prevent It
<p>The compressed air directly from your compressor is not safe for breathing. The air stream may contain carbon monoxide, toxic vapors, or solid particles from the tank. Breathing these contaminants can cause serious injury or death.</p>	<p>Air obtained directly from the compressor should never be used to supply air for human consumption. In order to use air produced by this compressor for breathing, suitable filters and in-line safety equipment must be properly installed. In-line filters and safety equipment used in conjunction with the compressor must be capable of treating air to all applicable local and federal codes prior to human consumption.</p>
<p>Sprayed materials such as paint, paint solvents, paint remover, insecticides, weed killers, may contain harmful vapors and poisons.</p>	<p>Work in an area with good cross ventilation. Read and follow the safety instructions provided on the label or safety data sheets for the materials you are spraying. Use a NIOSH/ MSHA approved respirator designed for use with your specific application.</p>

HAZARD

WARNING: Risk of Burns



What Could Happen	How To Prevent It
<p>Touching exposed metal such as the compressor head or outlet tubes, can result in serious burns.</p>	<p>Never touch any exposed metal parts on compressor during or immediately after operation. Compressor will remain hot for several minutes after operation. Do not reach around protective shrouds or attempt maintenance until unit has been allowed to cool.</p>

HAZARD

WARNING: Risk from Moving Parts



What Could Happen	How To Prevent It
<p>Moving parts such as the pulley, flywheel, and belt can cause serious injury if they come into contact with you or your clothing.</p>	<p>Never operate the compressor with guards or covers which are damaged or removed.</p>
<p>Attempting to operate compressor with damaged or missing parts or attempting to repair compressor with protective shrouds removed can expose you to moving parts and can result in serious injury.</p>	<p>Any repairs required on this product should be performed by authorized service center personnel.</p>

HAZARD

WARNING: Risk of Falling



What Could Happen	How To Prevent It
<p>A portable compressor can fall from a table, workbench, or roof causing damage to the compressor and could result in serious injury or death to the operator.</p>	<p>Always operate compressor in a stable secure position to prevent accidental movement of the unit. Never operate compressor on a roof or other elevated position. Use additional air hose to reach high locations.</p>

HAZARD

WARNING: Risk of Serious Injury or Property Damage When Transporting Compressor



(Fire, Inhalation, Damage to Vehicle Surfaces)

What Could Happen	How To Prevent It
Oil can leak or spill and could result in fire or breathing hazard; serious injury or death can result. oil leaks will damage carpet, paint or other surfaces in vehicles or trailers.	Always place COMPRESSOR on a protective mat when transporting to protect against damage to vehicle from leaks. Remove COMPRESSOR from vehicle immediately upon arrival at your destination.

HAZARD

WARNING: Risk of Unsafe Operation



What Could Happen	How To Prevent It
Unsafe operation of your air compressor could lead to serious injury or death to you or others.	Review and understand all instructions and warnings in this manual. Become familiar with the operation and controls of the air compressor. Keep operating area clear of all persons, pets, and obstacles. Keep children away from the air compressor at all times . Do not operate the product when fatigued or under the influence of alcohol or drugs . Stay alert at all times . Never defeat the safety features of this product. Equip area of operation with a fire extinguisher . Do not operate machine with missing, broken, or unauthorized parts .

SAVE THESE INSTRUCTIONS

GLOSSARY

Become familiar with these terms before operating the unit.

CFM: Cubic feet per minute.

SCFM: Standard cubic feet per minute; a unit of measure of air delivery.

PSIG: Pounds per square inch gauge; a unit of measure of pressure.

Code Certification: Products that bear one or more of the following marks: UL, CUL, ETL, CETL, have been evaluated by OSHA certified independent safety laboratories and meet the applicable Underwriters Laboratories Standards for Safety.

Cut-In Pressure: While the motor is off, air tank pressure drops as you continue to use your accessory. When the tank pressure drops to a certain low level the motor will restart automatically. The low pressure at which the motor automatically restarts is called "cut-in" pressure.

Cut-Out Pressure: When an air compressor is turned on and begins to run, air pressure in the air tank begins to build. It builds to a certain high pressure before the motor automatically shuts off - protecting your air tank from pressure higher than its capacity. The high pressure at which the motor shuts off is called "cut-out" pressure.

Branch Circuit: Circuit carrying electricity from electrical panel to outlet.

DUTY CYCLE

This air compressor pump is capable of running continuously. However, to prolong the life of your air compressor, it is recommended that a 50%-75% average duty cycle be maintained; that is, the air compressor pump should not run more than 30-45 minutes in any given hour.

SPECIFICATIONS

Model No.	C5510
Running Horsepower	1.9
Bore	2-7/8"
Stroke	2"
Voltage-Single Phase	120/240
Minimum Branch Circuit Requirement	20 amps
Fuse Type	Time Delay
Air Tank Capacity (Gallon)	20 ASME
Approximate Cut-in Pressure	120 PSIG
Approximate Cut-out Pressure	150 PSIG
SCFM @ 40 PSIG	7.4
SCFM @ 90 PSIG	5.4

ACCESSORIES

Accessories for this unit are available at the store the unit was purchased.

ASSEMBLY

Tools Required for Assembly

1 - 9/16" socket or open end wrench

1 - 1/2" socket or open end wrench

Unpacking

1. Remove unit from carton and discard all packaging. **NOTE:** Save all parts bags.

To Install Handle

⚠ CAUTION The wheels and handle do not provide adequate clearance, stability, or support for pulling the unit up and down stairs or steps. The unit must be lifted or pushed up a ramp. Do not lift the unit by the manifold assembly, the unit could be damaged.

1. To make installation easier, submerge handle grip into warm soapy water. Remove handle grip from soapy water and slide onto handle.
2. Insert the open end of the handle under the saddle. Before attaching handle, you may have to pull the open ends of the handle apart so they fit tightly against the side of the saddle. Looking in from the open end of the saddle, position the handle toward the two bent tabs, on the inside walls of the saddle.
3. Slowly push the open ends of the handle onto both tabs at the same time. Continue pushing the handle into the saddle until the holes on the side of the saddle and handle are in line.

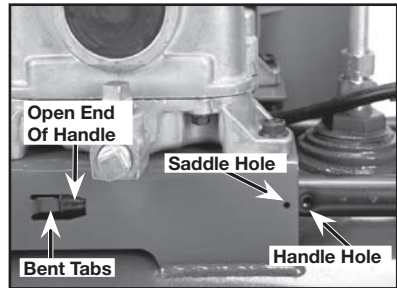
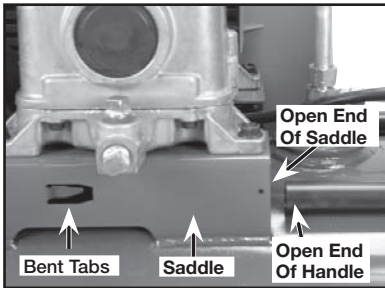

4. Guide the straight end of each retaining clip through the saddle hole and both handle holes.
5. Rotate each retaining clip and press down until it snaps into place over the handle.

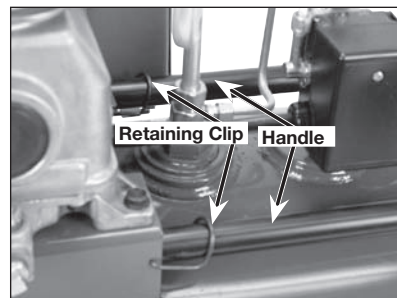
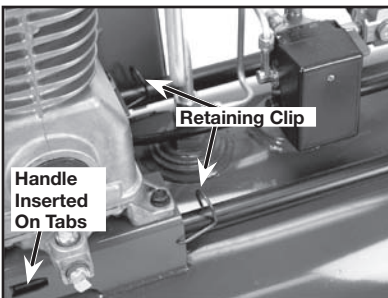

6. If the handle has excessive movement, it is improperly installed. Check the following.
 - A. Are both tabs inside the handle (Step #3)?
 - B. Does each clip pass through both the saddle and handle (Step #4)?

To Assemble Wheels

CAUTION It will be necessary to brace or support one side of the unit when installing the wheels because the compressor will have a tendency to tip.

1. Attach wheels with shoulder bolts and nuts as shown.
2. Tighten securely. **NOTE:** The unit will sit level if the wheels are properly installed.

CAUTION The wheels and handle do not provide adequate clearance, stability or support for pulling the unit up and down stairs or steps. The unit must be lifted, or pushed up a ramp.

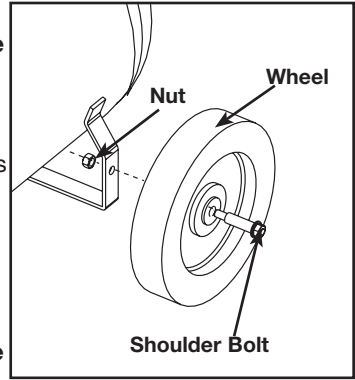

Assemble Rubber Feet

1. Attach rubber feet with the screws, washers, and nuts provided as shown.
2. Tighten securely.

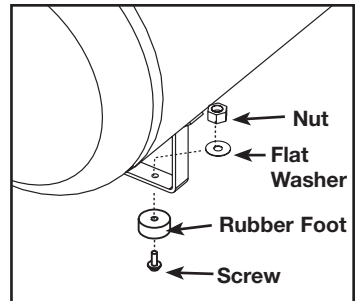

To Add Oil To Pump

⚠ CAUTION Compressors are shipped without oil. A small amount of oil may be present in the pump upon receipt of the air compressor. This is due to plant testing and does not mean the pump contains oil. Do not attempt to operate this air compressor without first adding oil to the crankcase. Serious damage can result from even limited operation unless filled with oil and broken in correctly. Make sure to closely follow initial start-up procedures.

⚠ CAUTION Multi-Viscosity motor oils, like 10W30, should not be used in an air compressor. They leave carbon deposits on critical components, thus reducing performance and compressor life. Use air compressor oil only.

NOTE: Oil is included with some units. If oil is not included, use an oil specifically formulated for use in an air compressor, such as Porter-Cable PAS1 air compressor oil. Oil may be found at the store where the air compressor was purchased.

1. Place unit on a level surface.

⚠ WARNING Risk from Flying Object. Drain tank to release air pressure before removing the dipstick. See "To Drain Tank" in the "Maintenance" section.

2. Remove oil fill plug (A) and slowly add a compressor oil until it is even with the top of the oil fill hole. **NOTE:** Do not allow oil to be lower than 3/8" (6 threads) from the top at any time. When filling the crankcase, the oil flows very slowly into the pump. If the oil is added too quickly, it will overflow and appear to be full. **NOTE:** Crankcase oil capacity is approximately 16 fluid ounces.
3. Replace oil fill plug.

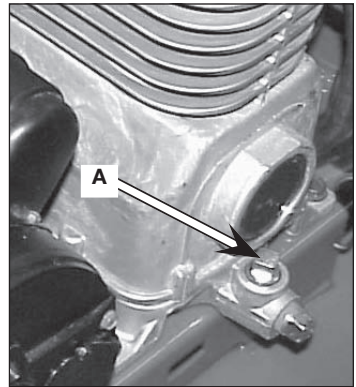

INSTALLATION

HOW TO SET UP YOUR UNIT

Location of the Air Compressor

- Locate the air compressor in a clean, dry, and well ventilated area.
- Place on a solid surface to prevent rocking or tipping.
- The air compressor should be located at least 12" away from the wall or other obstructions that will interfere with the flow of air.
- The air filter must be kept clear of obstructions which could reduce air flow to the air compressor.
- The air compressor requires fresh air flow for proper cooling. **DO NOT ALLOW THE COMPRESSOR TO GET WET.**

GROUNDING INSTRUCTIONS

⚠ WARNING Risk of Electrical Shock. In the event of a short circuit, grounding reduces the risk of shock by providing an escape wire for the electric current. This air compressor must be properly grounded.

The portable air compressor is equipped with a cord having a grounding wire with an appropriate grounding plug (see following illustrations).

1. The cord set and plug with this unit contains a grounding pin. This plug **MUST** be used with a grounded outlet.

IMPORTANT: The outlet being used must be installed and grounded in accordance with all local codes and ordinances.

2. Make sure the outlet being used has the same configuration as the grounded plug. **DO NOT USE AN ADAPTER.** See illustration.

3. Inspect the plug and cord before each use. Do not use if there are signs of damage.

4. If these grounding instructions are not completely understood, or if in doubt as to whether the compressor is properly grounded, have the installation checked by a qualified electrician.

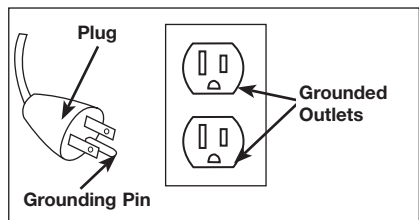

⚠ DANGER Risk of Electrical Shock. **IMPROPER GROUNDING CAN RESULT IN ELECTRICAL SHOCK.**

Do not modify the plug provided. If it does not fit the available outlet, a correct outlet should be installed by a qualified electrician.

Repairs to the cord set or plug **MUST be made by a qualified electrician.**

Extension Cords

Using extension cords is not recommended. The use of extension cords will cause voltage to drop resulting in power loss to the motor and overheating. Instead of using an extension cord, increase the working reach of the air hose by attaching another length of hose to its end. Attach additional lengths of hose as needed.

If an extension cord must be used, be sure it is:

- a 3-wire extension cord that has a 3-blade grounding plug, and a 3-slot receptacle that will accept the plug on the product
- in good condition
- no longer than 50 feet
- 12 gauge (AWG) or larger. (Wire size increases as gauge number decreases. 10 AWG and 8 AWG may also be used. DO NOT USE 14 OR 16 AWG.)

Voltage and Circuit Protection

Refer to the specification chart for the voltage and minimum branch circuit requirements.

CAUTION Certain air compressors can be operated on a 15 amp circuit if the following conditions are met.

1. Voltage supply to circuit must comply with the National Electrical Code.
2. Circuit is not used to supply any other electrical needs.
3. Extension cords comply with specifications.
4. Circuit is equipped with a 15 amp circuit breaker or 15 amp time delay fuse. **NOTE:** If compressor is connected to a circuit protected by fuses, use only time delay fuses. Time delay fuses should be marked "D" in Canada and "T" in the US.

If any of the above conditions cannot be met, or if operation of the compressor repeatedly causes interruption of the power, it may be necessary to operate it from a 20 amp circuit. It is not necessary to change the cord set.

120/240 Dual Voltage Motor

This model has a dual voltage motor, 120 and 240 volt. It is wired for 120 volt but can be converted to 240 volt operation. Instructions for connecting the motor for operation at 240 volt can be found printed on the label attached to the side of the motor.

CAUTION When converting to 240V operation, the attached three-prong 120V cord assembly must be replaced with a three-pronged 240V cord assembly (K-0080) that can be purchased through a Authorized Service Center.



120 Volt Plug



240 Volt Plug

OPERATION

Know Your Air Compressor

READ THIS OWNER'S MANUAL AND SAFETY RULES BEFORE OPERATING YOUR UNIT. Compare the illustrations with your unit to familiarize yourself with the location of various controls and adjustments. Save this manual for future reference.

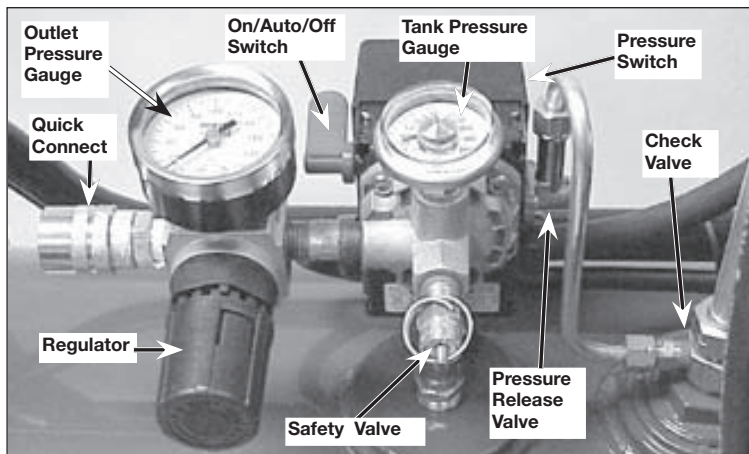

Description of Operation

Become familiar with these controls before operating the unit.

On/Auto/Off Lever: Turn this switch to "On/Auto" to provide automatic power to the pressure switch and "Off" to remove power at the end of each use.

Pressure Switch: The pressure switch automatically starts the motor when the air tank pressure drops below the factory set "cut-in" pressure. It stops the motor when the air tank pressure reaches the factory set "cut-out" pressure.

Safety Valve: If the pressure switch does not shut off the air compressor at its "cut-out" pressure setting, the safety valve will protect against high pressure by "popping out" at its factory set pressure (slightly higher than the pressure switch "cut-out" setting).

Tank Pressure Gauge: The tank pressure gauge indicates the reserve air pressure in the tank.

Outlet Pressure Gauge: The outlet pressure gauge indicates the air pressure available at the outlet side of the regulator. This pressure is controlled by the regulator and is always less than or equal to the tank pressure.

Regulator: Controls the air pressure shown on the outlet pressure gauge. Pull the knob out and turn clockwise to increase pressure and counterclockwise to decrease pressure. When the desired pressure is reached push knob in to lock in place.

Cooling System (not shown): This compressor contains an advanced design cooling system. At the heart of this cooling system is an engineered fan. It is perfectly normal for this fan to blow air through the vent holes in large amounts. You know that the cooling system is working when air is being expelled.

Air Compressor Pump (not shown): Compresses air into the air tank. Working air is not available until the compressor has raised the air tank pressure above that required at the air outlet.

Drain Valve: The drain valve is located at the base of the air tank and is used to drain condensation at the end of each use.

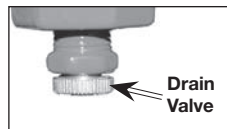

Check Valve: When the air compressor is operating, the check valve is "open", allowing compressed air to enter the air tank. When the air compressor reaches "cut-out" pressure, the check valve "closes", allowing air pressure to remain inside the air tank.

Pressure Release Valve: The pressure release valve located on the side of the pressure switch, is designed to automatically release compressed air from the compressor head and the outlet tube when the air compressor reaches "cut-out" pressure or is shut off. The pressure release valve allows the motor to restart freely. When the motor stops running, air will be heard escaping from this valve for a few seconds. No air should be heard leaking when the motor is running or after the unit reaches "cut-out" pressure.

Motor Overload Protector (not shown): The motor has an automatic reset thermal overload protector. If the motor overheats for any reason, the overload protector will shut off the motor. The motor must be allowed to cool down before restarting. The compressor will automatically restart after the motor cools.

Air Intake Filter (not shown): This filter is designed to clean air coming into the pump. This filter must always be clean and ventilation openings free from obstructions. See "Maintenance".

How to Use Your Unit

How to Stop:

1. Set the On/Auto/Off lever to "Off".

Before Starting

Break-in Procedure



Risk of Unsafe Operation. Serious damage may result if the following break-in instructions are not

closely followed.

This procedure is required **before** the air compressor is put into service and when the check valve or a complete compressor pump has been replaced.

1. Make sure the On/Auto/Off lever is in the "Off" position.
2. Check oil level in pump. See "Oil" paragraph in the "Maintenance" section for instructions.

NOTE: Pull coupler back until it clicks to prevent air from escaping through the quick connect.

3. Plug the power cord into the correct branch circuit receptacle. (Refer to "Voltage and Circuit Protection" paragraph in the "Installation" section of this manual.)
4. Open the drain valve (counter-clockwise) fully to permit air to escape and prevent air pressure build up in the air tank during the break-in period.
5. Move the On/Auto/Off lever to "On/Auto" position. The compressor will start.
6. Run the compressor for 20 minutes. Make sure the drain valve is open and there is minimal air pressure build-up in tank.
7. After 20 minutes, close the drain valve by turning clockwise. The air receiver will fill to "cut-out" pressure and the motor will stop.

The compressor is now ready for use.

Before Each Start-Up:

1. Place On/Auto/Off lever to "Off".
2. Pull the regulator knob out and turn counterclockwise to set the outlet pressure to zero.
3. Attach hose and accessories. **NOTE:** The hose or accessory will require a quick connect plug if the air outlet is equipped with a quick connect socket.

⚠ WARNING Risk of Bursting. Too much air pressure causes a hazardous risk of bursting. Check the manufacturer's maximum pressure rating for air tools and accessories. The regulator outlet pressure must never exceed the maximum pressure rating.

How to Start:

1. Turn the On/Auto/Off lever to "On/Auto" and allow tank pressure to build. Motor will stop when tank pressure reaches "cut-out" pressure.
2. Pull the regulator knob out and turn clockwise to increase pressure. When the desired pressure is reached push knob in to lock in place.

The compressor is ready for use.

MAINTENANCE

Customer Responsibilities

	Before each use	Daily or after each use	Every 8 hours	Every 40 hours	Every 100 hours	Every 160 hours	Yearly
Check Safety Valve	●						
Drain Tank		●					
Oil Leaks			●				
Check Oil			●				
Change Oil			●			●	
Unusual Noise and/or Vibration			●				
Air Filter					● ¹		
Drive Belt-Condition				●			
Motor Pulley/Flywheel alignment					●		
Air compressor pump intake and exhaust valves							●
Head Bolts - Check the torques of the head bolts after the first five hours of operation.							
1- more frequent in dusty or humid conditions							

⚠ WARNING Risk of Unsafe Operation. Unit cycles automatically when power is on. When servicing, you may be exposed to voltage sources, compressed air, or moving parts. Before servicing unit unplug or disconnect electrical supply to the air compressor, bleed tank of pressure, and allow the air compressor to cool.

To ensure efficient operation and longer life of the air compressor, a routine maintenance schedule should be prepared and followed. The above routine maintenance schedule is geared to an air compressor in a normal working environment operating on a daily basis. If necessary, the schedule should be modified to suit the conditions under which your air compressor is used. The modifications will depend upon the hours of operation and the working environment. Compressors in an extremely dirty and/or hostile environment will require a greater frequency of all maintenance checks.

NOTE: See "Operation" section for the location of controls.

To Check Safety Valve

⚠ WARNING Risk of Bursting. If the safety valve does not work properly, over-pressurization may occur, causing air tank rupture or an explosion.

1. Before starting compressor, pull the ring on the safety valve to make sure that the safety valve operates freely. If the valve is stuck or does not operate smoothly, it must be replaced with the same type of valve.

To Drain Tank

NOTE: Operation of the air compressor will cause condensation to build up in the air tank. Always drain tank on a washable surface or in a suitable container to prevent damaging or staining surfaces.

1. Set the On/Auto/Off lever to "Off".
2. Pull the regulator knob out and turn counterclockwise to set the outlet pressure to zero.
3. Remove the air tool or accessory.
4. Pull ring on safety valve allowing air to bleed from the tank until tank pressure is approximately 20 psi. Release safety valve ring.
5. Drain water from air tank by opening drain valve (counter-clockwise) on bottom of tank.

⚠ WARNING Risk of Bursting. Water will condense in the air tank. If not drained, water will corrode and weaken the air tank causing a risk of air tank rupture.

6. After the water has been drained, close the drain valve (clockwise). The air compressor can now be stored.

NOTE: If drain valve is plugged, release all air pressure. The valve can then be removed, cleaned, then reinstalled.

Oil

NOTE: Use an oil specifically formulated for use in an air compressor, such as Porter-Cable PAS1 air compressor oil. Oil may be found at the store where the air compressor was purchased.

NOTE: Crankcase oil capacity is approximately 16 fluid ounces.

Checking

1. Remove the oil fill plug (A). The oil level should be even with the top of the fill hole and no lower than 6 threads from the top of fill hole.
2. If needed, slowly add oil until it reaches the top of fill hole.

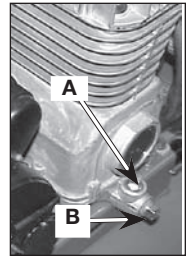

Changing

1. Remove the oil fill plug (A).
2. Remove the oil drain plug (B) and drain oil into a suitable container.
3. Replace the oil drain plug (B) and tighten securely.
4. Slowly fill crankcase to the top of the fill hole. **NOTE:** When filling the crankcase, the oil flows very slowly into the pump. If the oil is added too quickly, it will overflow and appear to be full.

⚠ CAUTION Risk of Unsafe Operation. Overfilling with oil will cause premature compressor failure. Do not overfill.

5. Replace oil fill plug (A) and tighten securely.

Air Filter - Inspection and Replacement

⚠ WARNING Hot surfaces. Risk of burn. Compressor heads are exposed when filter cover is removed. Allow compressor to cool prior to servicing.

⚠ WARNING Keep the air filter clean at all times. Do not operate the air compressor with the air filter removed.

A dirty air filter will not allow the compressor pump to operate at full capacity. Before using the compressor pump, check the air filter to make sure it is clean and in place.

If it is dirty, replace it with a new filter.

1. Using a pair of needle nose pliers or a screwdriver pull or pry out the old filter and carefully clean the filter area.
2. Push the new air filter in place. Refer to the "Repair Parts" for the correct part number.

IMPORTANT: Do not operate the compressor with the air filter removed.

To Replace Belt

⚠ WARNING Serious injury or damage may occur if parts of the body or loose items get caught in moving parts. Never operate the unit with the belt guard removed. The belt guard should be removed only when the compressor is unplugged.

1. Place the On/Auto/Off lever in the "Off" position.
2. Unplug compressor.
3. Remove the front of the belt guard by disengaging the snaps. Insert a flat bladed screwdriver at each snap location and pry the beltguard apart.
4. Loosen the wing nut on hold down plate and tilt motor to allow for easy removal or installation of the belt.
5. Remove belt.
6. Replace belt. **NOTE:** The belt must be centered over the grooves on the flywheel and motor pulley.
7. Turn the wing nut on the hold down plate until it makes contact with the washer, plus one additional turn.
8. Replace the belt guard.

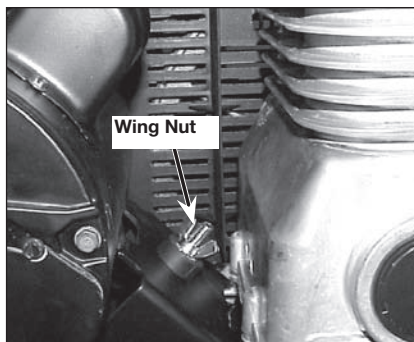

Motor Pulley/Flywheel Alignment

NOTE: Once the motor pulley has been moved from its factory set location, the grooves of the flywheel and pulley must be aligned to within 1/16" to prevent excessive belt wear.

The air compressor flywheel and motor pulley must be in-line (in the same plane) within 1/16" to assure belt retention within flywheel belt grooves. To check alignment, perform the following steps:

1. Turn air compressor off, lock out the power supply, and relieve all air pressure from the air tank.
2. Remove belt guard.
3. Place a straightedge against the outside of the flywheel and the motor drive pulley.

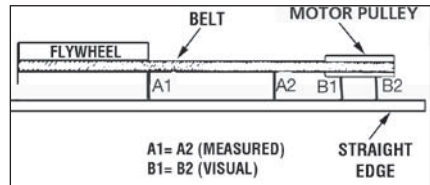

4. Measure the distance between the edge of the belt and the straightedge at points A1 and A2 in figure. The difference between measurements should be no more than 1/16".
5. If the difference is greater or less than 1/16" loosen the set screw holding the motor drive pulley to the shaft and adjust the pulley's position on the shaft until the A1 and A2 measurements are within 1/16" of each other.
6. Tighten the motor drive pulley set screw. See Parts manual for torque specifications.
7. Visually inspect the motor drive pulley to verify that it is perpendicular to the drive motor shaft. Points B1 and B2 of Figure should appear to be equal. If they are not, loosen the setscrew of the motor drive pulley and equalize B1 and B2, using care not to disturb the belt alignment performed in step 2.
8. Retighten the motor drive pulley setscrew. See Parts manual for torque specifications.
9. Reinstall belt guard.

Air Compressor Pump Intake and Exhaust Valves

Once a year have a Trained Service Technician check the air compressor pump intake and exhaust valves.

Air compressor Head Bolts - Torquing

The air compressor pump head bolts should be kept properly torqued. Check the torques of the head bolts after the first five hours of operation. Retighten if necessary. See Parts manual for torque specifications.

SERVICE AND ADJUSTMENTS

ALL MAINTENANCE AND REPAIR OPERATIONS NOT LISTED MUST BE PERFORMED BY TRAINED SERVICE TECHNICIAN.

⚠ WARNING Risk of Unsafe Operation. Unit cycles automatically when power is on. When servicing, you may be exposed to voltage sources, compressed air, or moving parts. Before servicing unit unplug or disconnect electrical supply to the air compressor, bleed tank of pressure, and allow the air compressor to cool.

To Replace or Clean Check Valve

1. Release all air pressure from air tank. See "To Drain Tank" in the "Maintenance" section.
2. Unplug air compressor.
3. Using an adjustable wrench loosen outlet tube nut at air tank and pump. Carefully move outlet tube up away from check valve.
4. Using an adjustable wrench loosen pressure relief tube nut at air tank and pressure switch. Carefully move pressure relief tube away from check valve.
5. Unscrew the check valve (turn counterclockwise) using a 7/8" open end wrench. **Note** the orientation for reassembly.
6. Using a screwdriver, carefully push the valve disc up and down. **NOTE:** The valve disc should move freely up and down on a spring which holds the valve disc in the closed position, if not the check valve needs to be cleaned or replaced.
7. Clean or replace the check valve. A solvent, such as paint or varnish remover can be used to clean the check valve.
8. Apply sealant to the check valve threads. Reinstall the check valve (turn clockwise).
9. Replace the pressure release tube. Tighten nuts.
10. Replace the outlet tube and tighten nuts.
11. Perform the Break-in Procedure. See "Break-in Procedure" in the "Operation" section.

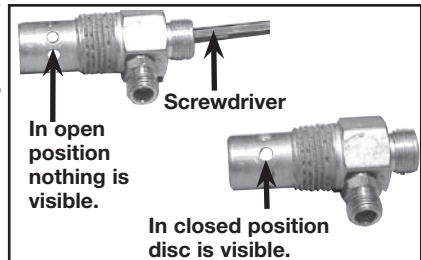
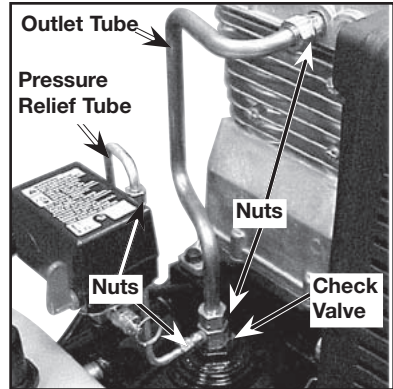

To Replace Regulator

1. Release all air pressure from air tank. See "To Drain Tank" in the "Maintenance" section.
2. Set the On/Auto/Off lever to "Off" and unplug unit.
3. Using an adjustable wrench remove the outlet pressure gauge and quick connect from the regulator.
4. Remove the regulator.
5. Apply pipe sealant tape to the nipple on the standpipe.

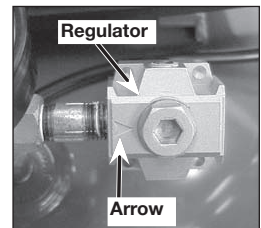
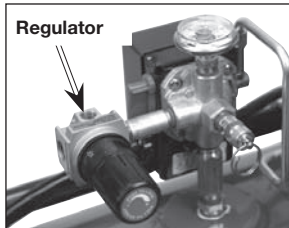
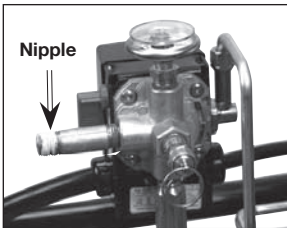
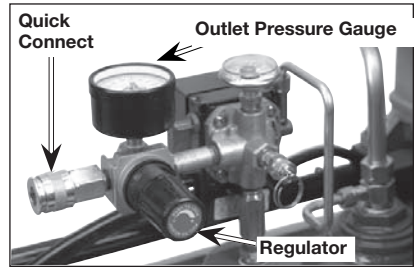

6. Assemble the regulator and orient as shown.

NOTE: Arrow indicates flow of air. Make sure it is pointing in the direction of air flow.

7. Reapply pipe sealant to outlet pressure gauge and quick connect.
8. Reassemble outlet pressure gauge and quick connect. Orient outlet pressure gauge to read correctly. Tighten connect with wrench.

STORAGE

Before you store the air compressor, make sure you do the following:

1. Review the "Maintenance" section on the preceding pages and perform scheduled maintenance as necessary.
2. Set the On/Auto/Off lever to "Off" and unplug unit.
3. Turn the regulator counterclockwise and set the outlet pressure to zero.
4. Remove the air tool or accessory.
5. Pull ring on safety valve allowing air to bleed from the tank until tank pressure is approximately 20 psi. Release safety valve ring.
6. Drain water from air tank by opening drain valve on bottom of tank.

⚠ WARNING Risk of Bursting. Water will condense in the air tank. If not drained, water will corrode and weaken the air tank causing a risk of air tank rupture.

7. After the water has been drained, close the drain or drain valve.

NOTE: If drain valve is plugged, release all air pressure. The valve can then be removed, cleaned, then reinstalled.

8. Protect the electrical cord and air hose from damage (such as being stepped on or run over). Wind them loosely around the compressor handle.
9. Store the air compressor in a clean and dry location.

TROUBLESHOOTING

⚠ WARNING Risk of Unsafe Operation. Unit cycles automatically when power is on. When performing maintenance, you may be exposed to voltage sources, compressed air, or moving parts. Personal injuries can occur. Before performing any maintenance or repair, disconnect power source from the compressor and bleed off all air pressure.

PROBLEM	CAUSE	CORRECTION
Excessive tank pressure - safety valve pops off.	Pressure switch does not shut off motor when compressor reaches "cut-out" pressure.	Move On/Auto/Off lever to the "Off" position, if the unit does not shut off contact a Trained Service Technician.
	Pressure switch "cut-out" too high.	Contact a Trained Service Technician.
Air leaks at fittings.	Tube fittings are not tight enough.	Tighten fittings where air can be heard escaping. Check fittings with soapy water solution. DO NOT OVER TIGHTEN.
Air leaks at or inside check valve.	Check valve seat damaged.	A defective check valve results in a constant air leak at the pressure release valve when there is pressure in the tank and the compressor is shut off. Replace check valve. Refer the "To Replace or Clean Check Valve" in the "Service and Adjustments" section.
Air leaks at pressure switch release valve.	Defective pressure switch release valve.	Contact a Trained Service Technician.
Air leaks in air tank or at air tank welds.	Defective air tank.	Air tank must be replaced. Do not repair the leak. ⚠ WARNING Risk of Bursting. Do not drill into, weld or otherwise modify air tank or it will weaken. The tank can rupture or explode.
Air leaks between head and valve plate.	Leaking seal.	Contact a Trained Service Technician.

PROBLEM	CAUSE	CORRECTION
Pressure reading on the regulated pressure gauge drops when an accessory is used.	It is normal for "some" pressure drop to occur.	If there is an excessive amount of pressure drop when the accessory is used, adjust the regulator as instructed in the Operation section. NOTE: Adjust the regulated pressure under flow conditions (while accessory is being used).
Air leak from safety valve.	Possible defect in safety valve.	Operate safety valve manually by pulling on ring. If valve still leaks, it should be replaced.
Compressor is not supplying enough air to operate accessories.	<p>Prolonged excessive use of air. Compressor is not large enough for air requirement.</p> <p>Hole in hose.</p> <p>Check valve restricted.</p> <p>Air leaks.</p> <p>Restricted air intake filter.</p> <p>Loose belt.</p>	<p>Decrease amount of air usage.</p> <p>Check the accessory air requirement. If it is higher than the SCFM or pressure supplied by your air compressor, you need a larger compressor. Check and replace if required.</p> <p>Remove and clean, or replace.</p> <p>Tighten fittings.</p> <p>Clean or replace air intake filter. Do not operate the air compressor with the filter removed. Refer to the "Air Filter" paragraph in the "Maintenance" section.</p> <p>Loosen wingnut and then tighten wingnut until it contacts the washer, plus one turn.</p>
Restricted air intake.	Dirty air filter.	Clean or replace. See "Air Filter" paragraph in the "Maintenance" section.
Regulator knob has continuous air leak.	Damaged regulator.	Replace.
Regulator will not shut off air outlet.	Damaged regulator.	Replace.

PROBLEM	CAUSE	CORRECTION
<p>Motor will not run.</p>	<p>Motor overload protection switch has tripped.</p> <p>Tank pressure exceeds pressure switch "cut-in" pressure.</p> <p>Check valve stuck open.</p> <p>Extension cord is wrong length or gauge.</p> <p>Possible defective motor or starting capacitor.</p> <p>Paint spray on internal motor parts.</p> <p>Pressure release valve on pressure switch has not unloaded head pressure.</p> <p>Fuse blown, circuit breaker tripped.</p>	<p>Let motor cool off and overload switch will automatically reset.</p> <p>Motor will start automatically when tank pressure drops below "cut-in" pressure of pressure switch.</p> <p>Remove and clean, or replace.</p> <p>Check for proper gauge wire and cord length.</p> <p>Have checked by a Trained Service Technician.</p> <p>Have checked by a Trained Service Technician. Do not operate the compressor in the paint spray area. See flammable vapor warning.</p> <p>Bleed the line by pushing the lever on the pressure switch to the "Off" position; if the valve does not open, replace switch.</p> <ol style="list-style-type: none"> 1. Check fuse box for blown fuse and replace as necessary. Reset circuit breaker. Do not use a fuse or circuit breaker with higher rating than that specified for your particular branch circuit. 2. Check for proper fuse. You should use a time delay fuse. 3. Check for low voltage conditions and/or proper extension cord. 4. Disconnect the other electrical appliances from circuit or operate the compressor on its own branch circuit.

PROBLEM	CAUSE	CORRECTION
Knocking Noise.	Possible defect in safety valve.	Operate safety valve manually by pulling on ring. If valve still leaks, it should be replaced.
	Defective check valve.	Remove and clean, or replace.
	Loose pulley.	Tighten pulley set screw, see Parts manual for torque specifications.
	Loose flywheel.	Tighten flywheel screw, see Parts manual for torque specifications.
	Compressor mounting screws loose.	Tighten mounting screws, see Parts manual for torque specifications.
	Loose belt.	Loosen wingnut and then tighten wingnut until it contacts the washer, plus one turn.
	Carbon build-up in pump.	Have checked by a Trained Service Technician.
	Belt too tight.	Loosen wingnut and then tighten wingnut until it contacts the washer, plus one turn.
Excessive belt wear.	Loose belt.	Loosen wingnut and then tighten wingnut until it contacts the washer, plus one turn.
	Tight belt.	Loosen wingnut and then tighten wingnut until it contacts the washer, plus one turn.
	Loose pulley.	Have checked by a Trained Service Technician.
	Pulley misalignment.	See Motor Pulley/Flywheel Alignment paragraph in the Maintenance section.
Squealing sound.	Compressor pump has no oil.	See Oil-Checking paragraph in the Maintenance section.
	Loose belt.	Loosen wingnut and then tighten wingnut until it contacts the washer, plus one turn.

LIMITED WARRANTY

PORTER-CABLE CORPORATION warrants to the original purchaser that all products covered under this warranty are free from defects in material and workmanship. Products covered under this warranty include air compressors, air tools, service parts, pressure washers, and generators, which have the following warranty periods:

3 YEARS - Limited warranty on 2-stage oil-free air compressor pumps that operate at 1725 RPM.

2 YEARS - Limited warranty on oil-lubricated air compressor pumps.

1 YEAR - Limited warranty on all other air compressor components.

2 YEARS - Limited warranty on electric generator alternators.

1 YEAR - Limited warranty on other generator components.

2 YEARS - Limited warranty on pneumatic air tools as described in Porter-Cable general catalog.

1 YEAR - Limited warranty on pressure washers used in consumer applications (i.e. personal residential household usage only).

90 DAY - Pressure washers used for commercial applications (income producing) and service parts.

1 YEAR - Limited warranty on all accessories.

Porter-Cable will repair or replace, at **Porter-Cable's** option, products or components which have failed within the warranty period. Service will be scheduled according to the normal work flow and business hours at the service center location, and the availability of replacement parts. All decisions of **Porter-Cable Corporation** with regard to this limited warranty shall be final.

This warranty gives you specific legal rights, and you may also have other rights which vary from state to state.

RESPONSIBILITY OF ORIGINAL PURCHASER (initial User):

- To process a warranty claim on this product, DO NOT return it to the retailer. The product must be evaluated by a **Porter-Cable** Authorized Warranty Service Center. For the location of the nearest **Porter-Cable** Authorized Warranty Service Center call 1-888-559-8550, 24 hours a day, 7 days a week.
- Retain original cash register sales receipt as proof of purchase for warranty work.
- Use reasonable care in the operation and maintenance of the product as described in the Owners Manual(s).
- Deliver or ship the product to the nearest **Porter-Cable** Authorized Warranty Service Center. Freight costs, if any, must be paid by the purchaser.
- Air compressors with 60 and 80 gallon tanks will be inspected at the site of installation. Contact the nearest **Porter-Cable** Authorized Warranty Service Center that provides on-site service calls, for service call arrangements.
- If the purchaser does not receive satisfactory results from the **Porter-Cable** Authorized Warranty Service Center, the purchaser should contact Porter-Cable.

THIS WARRANTY DOES NOT COVER:

- Merchandise sold as reconditioned, used as rental equipment, and floor or display models.
- Merchandise that has become damaged or inoperative because of ordinary wear, misuse*, cold, heat, rain, excessive humidity, freeze damage, use of improper chemicals, negligence, accident, failure to operate the product in accordance with the instructions provided in the Owners Manual(s) supplied with the product, improper maintenance, the use of accessories or attachments not recommended by **Porter-Cable**, or unauthorized repair or alterations.
- * An air compressor that pumps air more than the recommended duty cycle during a one hour period may be considered misuse.
- Repair and transportation costs of merchandise determined not to be defective.
- Costs associated with assembly, required oil, adjustments or other installation and start-up costs.
- Expendable parts or accessories supplied with the product which are expected to become inoperative or unuseable after a reasonable period of use, including but not limited to sanding disks or pads, saw and shear blades, grinding stones, springs, chisels, nozzles, o-rings, air jets, washers and similar accessories.
- Merchandise sold by **Porter-Cable** which has been manufactured by and identified as the product of another company, such as gasoline engines. The product manufacturer's warranty, if any, will apply.
- **ANY INCIDENTAL, INDIRECT OR CONSEQUENTIAL LOSS, DAMAGE, OR EXPENSE THAT MAY RESULT FROM ANY DEFECT, FAILURE OR MALFUNCTION OF THE PRODUCT IS NOT COVERED BY THIS WARRANTY.** Some states do not allow the exclusion or limitation of incidental or consequential damages, so the above limitation or exclusion may not apply to you.
- **IMPLIED WARRANTIES, INCLUDING THOSE OF MERCHANTABILITY OR FITNESS FOR A PARTICULAR PURPOSE, ARE LIMITED TO ONE YEAR FROM THE DATE OF ORIGINAL PURCHASE.** Some states do not allow limitations on how long an implied warranty lasts, so the above limitations may not apply to you.

PORTER-CABLE®

Porter-Cable Corporation
Jackson, TN USA
1-888-559-8550

Free Manuals Download Website

<http://myh66.com>

<http://usermanuals.us>

<http://www.somanuals.com>

<http://www.4manuals.cc>

<http://www.manual-lib.com>

<http://www.404manual.com>

<http://www.luxmanual.com>

<http://aubethermostatmanual.com>

Golf course search by state

<http://golfingnear.com>

Email search by domain

<http://emailbydomain.com>

Auto manuals search

<http://auto.somanuals.com>

TV manuals search

<http://tv.somanuals.com>