

OKI

People to People Technology

Oki Data Corporation
Tokyo, Japan

**PRODUCT SPECIFICATION
FOR
FX-051 FACSIMILE TRANSCEIVER**

ISSUE 4

September, 1999

Document Revision History

Title: FX-051 Product Specification

Revision Number	Revision Date	Item	Comments	Change Author
1	Feb, '98		ISSUE	E3 Hanazawa
2	June, '99		Correction of page 2-4(item 18), 2-5(item 24), 2-8(item 8), 2-9(item 12), 2-10(item 19), 2-12(item 37), 2-14(item 45), 2-15(item 51), 3-2(item 3.9), 4-3(item 4.2.2), 4-20(item C), 4-26(item 4.4.6.1), 4-27(item 4.4.6.2 and 4.4.7), 4-33(item 27), 4-36(item 4.4.7.9), 4-41(item 4.5.3), 4-44(item 4.6.4), 4-45(item 4.5.7), 4-50(item 4.7.2.1), 4-59, 4-60, 4-64, 4-68, 4-73, 4-75, 4-78 though 4-82, 4-84, 4-87 though 4-89, 4-93, 4-94, 4-97, 4-98, 4-101 though 4-105, 4-108, 4-113, 4-123, 4-132, 4-134, 4-135, 4-138, 4-141, 4-142, 4-146 though 4-148, 4-152, 4-158, 4-164 though 168, 5-1(item 5.2), 5-2(item 5.8.1), 5-3(item 5.11), 5-5(item 5-14), 7-2(item 7.5), 8-2(item 8.1.4.1 and 8.1.4.2), 8-4(item 8.6), 10-1(item 10.3) and 10-2(item 10.4),	E3 Hanazawa
3	Oct, '98		Correction of page 5-4(item 5.13), 5-5(item 5.14), 6-5(item 6.9) and 6-6(item 6.12)	E3 Endo
4	Sep, '99	Appendix B	Addition of page 2-1 (General Description), 2-6 (item 29), 4-60, 4-93 and 4-106 Addition of FAX2NET Product Specification)	E3 Endo

TABLE OF CONTENTS

PRODUCT SPECIFICATION

1.	SCOPE	1-1
2.	GENERAL DESCRIPTION	2-1
2.1	General Performance Specifications	2-2
2.2	General Function Specifications	2-7
2.2.1	User Functions	2-7
2.2.2	Service Functions	2-18
3.	PHYSICAL DESCRIPTION	3-1
3.1	General Appearance	3-1
3.2	Dimensions	3-1
3.3	Weight	3-1
3.4	Product Identification	3-1
3.5	Corporate Colors	3-1
3.6	Model Number Plate and Serial Number Label	3-1
3.7	Control Panel	3-1
3.8	Labels and Decals	3-2
3.9	Second Tray (Option)	3-2
3.9.1	Corporate Color	3-2
3.10	Optional Telephone	3-2
4.	OPERATION	4-1
4.1	Major Apparatus Appearing on the Machine's Cabinet	4-1
4.1.1	Document Guides	4-1
4.1.2	Tray-Paper	4-1
4.1.3	Document Stacker	4-1
4.1.4	Control Panel	4-1
4.1.5	Automatic Document Feeder (ADF)	4-1
4.1.6	Manual Paper Feeder	4-2
4.1.7	AC Inlet	4-2
4.1.8	Power Switch	4-2
4.1.9	Line Terminal	4-2
4.1.10	Telephone Terminal	4-2
4.1.11	Optional Memory Board Interface	4-2
4.1.12	Second Cassette Interface	4-2
4.1.13	PC Interface Connector	4-2
4.1.14	Optional Telephone Handset	4-2
4.2	Controls and Indicators on Control Panel (Fig. 3-3)	4-3
4.2.1	ATUO REC	4-3
4.2.2	Transmit Resolution (YES key)	4-3
4.2.3	Type of Original (NO key)	4-4

4.2.4	COPY	4-5
4.2.5	Select Function	4-5
4.2.6	Auto Dial	4-6
4.2.7	Keypad	4-6
4.2.8	REDIAL	4-6
4.2.9	STOP	4-7
4.2.10	START	4-8
4.2.11	PLUS, PAUSE and SPACE	4-8
4.2.12	One-Touch Keys	4-9
4.2.13	HYPHEN	4-9
4.2.14	V.REQUEST/HOOK	4-10
4.2.15	SEARCH	4-10
1.2.16	ALARM Indicator	4-10
4.2.17	LCD display	4-11
4.3	Typical Operations	4-11
4.3.1	Power Turning On	4-12
4.3.2	Paper Loading	4-12
4.3.3	Typical Transmission	4-12
4.3.4	Other Transmission Function (Fig. 4-3-1)	4-21
4.3.5	Typical Message Reception (Auto Receive and Manual Receive Modes)	4-22
4.3.6	Multiple Function Combination Table for Communication	4-22
4.4	User Functions	4-22
4.4.1	Method for Selection Function	4-23
4.4.2	Print from Message in Memory	4-24
4.4.3	Print from Confidential Reception Message	4-24
4.4.4	Operation of Polling Reception	4-25
4.4.5	Selection of Reports and Lists	4-25
4.4.6	Selection of Counter Display	4-26
4.4.7	User Program Menu	4-27
4.4.8	Printer Cleaning	4-36
4.5	Technical programming (Service Functions)	4-37
4.5.1	Local test	4-37
4.5.2	Technical functions	4-38
4.5.3	PTT Parameter	4-41
4.5.4	System reset	4-41
4.5.5	Default type set	4-41
4.5.6	PC-Loading	4-41
4.6	Reports and Lists	4-42
4.6.1	Message confirmation report	4-42
4.6.2	Activity report	4-43
4.6.3	Broadcast confirmation report	4-44
4.6.4	MEMORY Files report	4-44
4.6.5	Configuration reports	4-45
4.6.6	Service default report (configuration report: service-bit=ON)	4-45
4.6.7	Telephone directory	4-46
4.6.8	Protocol dump data printing	4-46
4.6.9	Log Report	4-47

4.6.10	Broadcast entry report	4-47
4.6.11	Confidential RX report	4-48
4.6.12	Power OFF report	4-48
4.6.13	Call back message	4-48
4.7	Restrictions by the Printer	4-49
4.7.1	Printing time	4-49
4.7.2	Printing area and image scaling	4-50
4.7.3	Operation on alarm occurrence during printing	4-50
4.7.4	Heater control	4-51
4.7.5	Warming up of the printer	4-51
4.8	Other Functions	4-51
4.8.1	Language	4-51
4.8.2	Incoming Ringer	4-52
4.8.3	CML-ON timing	4-52
4.8.4	Real time dialing	4-52
4.8.5	Ring duration time	4-52
4.8.6	PC printer mode	4-52
4.8.7	Hyper power save mode (This Wording is tentative)	4-53
4.8.8	V34 (33.6/22.8KBPS) MODEM	4-53
4.8.9	FAX forwarding	4-53
4.8.10	Cleaning Page mode	4-53
4.8.11	Image in MCF	4-54
4.8.12	Distinctive Ring	4-54
4.8.13	Error Criterion Value	4-54
4.8.14	DIS BIT 32	4-54
4.8.15	T1(TX) and T1(RX) Timer Value	4-55
4.8.16	T2 Timer Value	4-55
4.8.17	TAD I/F	4-55
4.8.18	Parallel Pick Up	4-55
4.8.19	Oki High speed Protocol for 14.4K	4-55
4.8.20	Error report ON/OFF	4-55
4.9	New Functions and changed operations	4-56
4.9.1	300DPI function	4-56
4.9.2	TX preparation and dual access	4-57
4.9.3	TR Latch Current	4-57
4.10	Point of difference for FX-048	4-57
4.10.1	Deleting BROADCAST/FEEDER selection	4-57
4.10.2	Instant Dialling	4-57
4.10.3	MEMORY FILES REPORT added	4-57
4.10.4	RESTRICTED ACCESS function added	4-57
4.10.5	PC Loading added	4-57
4.10.6	Personal BOX	4-58
4.10.7	BULLETIN POLLING added	4-58
4.10.8	Displaying 4-figure Christian era	4-58
4.10.9	CONTINUOUS TONE	4-58
4.10.10	Memory Password	4-58
4.10.11	MFP unlock	4-58

4.11	Reference for wordings between this series and current machines	4-58
5.	DOCUMENT INPUT	5-1
5.1	Document Width	5-1
5.2	Effective Reading Width	5-1
5.3	Transmitter Scanning Method	5-1
5.4	Transmit Document Length	5-1
5.5	Scanning Resolution	5-2
5.6	Automatic Document Feeder Capacity	5-2
5.7	Contrast Control	5-2
5.8	Input Document Characteristics	5-2
5.8.1	Base Weight	5-2
5.8.2	Thickness	5-2
5.8.3	Opacity	5-3
5.8.4	Shape	5-3
5.8.5	Document Condition	5-3
5.9	Document Damage	5-3
5.10	Document Jam Detection	5-3
5.11	Feeder Reliability	5-3
5.12	Document Jam Removal	5-4
5.13	Document Skew	5-4
5.14	Document Stacking	5-5
5.15	Feeder Separation Rubber Useful Life	5-5
6.	DOCUMENT OUTPUT	6-1
6.1	Receive Printing Method	6-1
6.2	Effective Recording Width	6-1
6.3	Recording Paper	6-3
6.3.1	Recording Paper	6-3
6.3.2	Automatic Recording Paper Feeder Capacity	6-3
6.4	Input Recording Paper Characteristics	6-3
6.4.1	Base Weight	6-3
6.4.2	Thickness	6-3
6.4.3	Shape	6-4
6.4.4	Recording Paper Condition	6-4
6.5	Recording Paper Jam Detection	6-4
6.6	Feeder Reliability	6-4
6.7	Recording Paper Jam Removal	6-4
6.8	Recording Paper Skewing	6-5
6.9	Copy Density	6-5
6.10	Copy Uniformity	6-5
6.11	Copy Stacking	6-5
6.12	Toner Cartridge/Image Drum unit useful life	6-6
7.	COMMUNICATION	7-1
7.1	Transmission Line	7-1
7.2	Telephone Line Connection	7-1

7.2.1	International NCU	7-1
7.3	Communication Mode	7-1
7.4	Modem Operation	7-1
7.4.1	Transmission Mode	7-2
7.4.2	Signal Level	7-2
7.5	Protocol and Data Transmission	7-2
7.6	Data Compression	7-3
7.7	Minimum Scan Line Time	7-3
7.8	Compatibility	7-3
7.9	Ring Detect Sensitivity	7-3
8.	ENVIRONMENTAL REQUIREMENTS	8-1
8.1	Power	8-1
8.1.1	AC Voltage Range	8-1
8.1.2	Frequency Range	8-1
8.1.3	Transients	8-1
8.1.4	Power Consumption	8-1
8.1.4.1	US/CANADA Versions	8-2
8.1.4.2	INT'L Versions	8-2
8.1.5	Rush Current	8-3
8.2	Overheat Protection	8-3
8.3	Humidity	8-3
8.4	Temperature	8-3
8.5	Shock	8-3
8.6	Vibration	8-4
8.7	Static Electricity	8-5
8.8	Acoustic Noise	8-5
8.9	Radiation	8-5
8.10	Spurious Noise Level	8-5
8.11	Electrical noise	8-5
8.12	Storage Conditions	8-6
9.	SERVICEABILITY	9-1
9.1	Fault Isolation	9-1
9.2	Adjustments	9-1
9.3	Assembly/Disassembly	9-1
9.4	Connector Designation	9-1
10.	OVERALL PERFORMANCE	10-1
10.1	Mean Time Between Failures (MTBF)	10-1
10.2	Standardization	10-1
10.3	Image Transmission Time	10-1
10.4	Copy Resolution	10-2
10.5	Readability	10-2

12.	SHIPPING CONDITIONS	12-1
12.1	Vibration	12-1
12.2	Drop Test	12-1
12.3	Static Compression	12-1
13.	APPLICABLE DOCUMENTS	13-1
13.1	ASTM-D3332-77	13-1
13.2	FCC Part 15, Class B	13-1
13.3	NSTA	13-1
13.4	UL 1950	13-1
13.5	CSA STD C22.2 No. 950	13-1
13.6	IEC Publication 950	13-1
13.7	EN60950	13-1
13.8	FCC Part 68, Subpart D	13-2
13.9	IC CS-03 Issue 7	13-2
13.10	Occupational Safety and Health Act (OSHA)	13-2
13.11	ITU-T Recommendations	13-2
13.12	No.2 IIEEJ	13-2
	(The Institute of Image Electronics Engineers of Japan)	
13.13	VDE 0878	13-2
13.14	BS6305 and relevant regulations	13-2
13.15	EMC Directive 89/336/EEC (CE-mark)	13-3
13.16	Unique International Requirement for Line Connection	13-3
13.16.1	DTS (Der Telefax Standard)	13-3
13.17	Requirement for Option	13-3
13.17.1	PC Interface	13-3
14.	MACHINE PACKAGING AND CONFIGURATIONS	14-1
14.1	Shipping Carton Marking	14-1
14.2	General Configurations	14-1
14.3	Machine Models	14-2
14.4	Package Contents	14-2

APPENDIX A MFP Function

APPENDIX B FAX2NET Product Specification

1. SCOPE

This package describes the FX-051 Facsimile Transceiver, which may be referred to as “the product” or “the machine” in this section.

The product will be manufactured by Oki Data Corporation and distributed by ODA/OEL under an appropriate product name given by ODA/OEL upon agreement with Oki Data Corporation.

2. GENERAL DESCRIPTION

The FX-051 is a half duplex, high performance, Facsimile Transceiver machine which communicates with distant stations over a voice level telephone line.

The product can have a MFP (Multi-Function Peripheral) function as option (standard for ODA version) and use as "PC-scanner", "PC-printer" and "PC-fax" by connecting with PC.

The product can have a FAX2NET service function (FAX over IP, FAX to E-mail, Virtual E-mail and Web retrieval) and a user facsimile can use internet functions by communicating with the neighboring FAX2NET server.

Note: User needs to contract with FAX2NET.

The product will be made available in "6" versions which, in general, vary with the product specifications requested by the market area.

ODA (US and CANADA) versions will be designed to meet the ITU-T G3 recommendations and operate on 120V AC.

The International versions will be designed to meet the ITU-T G3 recommendations and operate on 230V AC.

The international versions will be named as follows:

1. OEL
Denmark Norway
Holland Sweden
Finland Ireland
Spain Portugal
Greece Belgium
Italy
2. GER
Germany Switzerland
Austria
3. UKF
United Kingdom France
4. ODA (Latin America)
5. OKI-INT
Out of Europe (Australia, New Zealand, Singapore and Malaysia etc.)

Note: Each version described above is shown as below in this document.

US: ODA-US and CANADA version

INT'L: OEL, GER, UKF, ODA-Latin America, OKI-INT version

ODA: ODA-US and CANADA version and ODA-Latin America version

2.1 General Performance Specifications

General performance specifications of the product are described below for a more thorough understanding of the following descriptions:

1) Style design

Desktop design

2) Applicable network type

PSTN (Public Switched Telephone Network), PBX telephone line.

3) Compatibility

The product can communicate with a machine operating in ITU-T G3 mode.

4) Document size

NA Legal/NA Letter/ISO A4 to ISO A5

5) Effective reading width

NA Letter: 215 mm maximum (US)

ISO A4: 208 mm maximum (INT'L)

Note: Refer to 5.2 in detail

6) Scanning length

128 mm to 356 mm

Length setting = infinite is also available.

7) Printing paper size

1st Tray

Universal type (Legal/Letter/A4 changeable): 100 sheets max.

8) Printable width

NA Letter: 203.2 mm (203.2 mm for assured quality)

NA Legal: 203.2 mm (203.2 mm for assured quality)

ISO A4: 203.2 mm (197.3 mm for assured quality)

9) Printable length

NA Letter:	273.4 mm (266.7 mm for assured quality)
NA Legal:	349.6 mm (342.9 mm for assured quality)
ISO A4:	291.0 mm (284.3 mm for assured quality)

10) Copy Stacker

Copy stacker will have a capacity of 30* copies maximum.
(Faceup stacking)

** Note: Using the recommended paper*

11) Printing paper

Plain paper

12) Resolution

(1) Horizontal resolution

a) Scanning

- 300 dots per inch in horizontal line.

b) Printing

- 300 dots per inch in horizontal line.

(2) Vertical resolution

a) Scanning

- 300 dots per inch, 15.4, 7.7, and 3.85 lines per mm in vertical direction, switch-selectable.

b) Printing

[Received FAX message]

- 784 to 1076 dots per inch using image smoothing process and 300 to 412 dots per inch in the vertical direction automatically.

[Local copy]

- Refer to 2.2.1(37) Local copy

[PC printer]

- 300 dots per inch and 1200 dots per inch (Quasi 600 dpi)

Note 1: Variable resolution printing rates for vertical direction are available, so variable reduction printing rates are provided.

Note 2: The machine prints received FAX message at 300 x 784 to 1076 DPI using image smoothing process even if transmitted resolution is 8 dots/mm x 3.85, 7.7 or 15.4 lines/mm.

13) Scanning method

- 2592 bits contact image sensor.

14) Printing method

211.3 mm (2496 bits) and/or 216.7 mm (2560 bits)

15) Minimum scanning time

NSS= 0, 5, 10 ms

DCS= 0, 5, 10 ms

16) Minimum print time

NSF= 0 ms

DIS=10 milliseconds for 3.85 lines/mm.

5 milliseconds for 7.7 lines/mm.

17) Print speed

Max. 8 sheets per minute (at NA Letter size)

Note : Under following conditions, the printing speed will be at 6 PPM.

- In PC print mode

- When the paper width is smaller than JISB5(128mm).

18) Power save

The FX-051 realizes low power consumption by new power supply unit.

This function is feeding power to the necessary minimum circuit at standby state by adoption of New power supply. When the machine becomes the operation state, power supply is feeding to the all circuits.

By adoption of this system, power consumption at standby state becomes below 0.5W.

Pre-heating time (Standby to Print):

Approx.30 sec

Note 1: When the "MCF automatic printing" is set to ON, the MCF printout time is as follows. (Communication end to Print)

Approx. 20 sec

Note 2: This feature is not available FX-051 (ODA)

19) Coding scheme

Modified Modified READ (MMR), Modified READ (MR), and Modified Huffman (MH).

20) Modem

ITU-T V.29/V.27 ter./V.21 and V.17, V.33, as applicable.

21) Transmission speed

6 seconds (approx 6.9 sec) at 14.4 Kbps per sheet of ITU-T No.1 evaluation test chart, typical.

Note 1: This speed denotes the time interval corresponding to Phase C (message transmission phase) as referred to in ITU-T T.30.

22) Protocol

ITU-T T.30 and Oki special protocol (speed protocol) will be available.

23) Error correction scheme

ITU-T ECM defined in T.4, T.30 are provided.
This should be applicable to MH, MR and MMR coding schemes.

24) Speed protocol

High-speed Protocol - the T.30 handshake procedure will be conducted at message transmission speed instead of 300 bps during multi-page and multi-document transmissions.

Note : This feature disable when you set 9.6k to the H/Modem Rate (technical setting No.13) .

25) Memory capacity

1.0 M-byte

26) Major control and display apparatus

Ten-key pad for dialing and programming.

LCD display of 20 characters in 2 rows for operation guidance, clock display, and display of various kinds of information.

27) Power supply unit

120 VAC +6% or -15% (i.e., 102 V to 127 V), 50/60 Hz \pm 2% for US and CANADA versions.

230 VAC +15% or -14% (i.e., 198 V to 264 V), 50/60 Hz \pm 2% for INT'L.

28) MFP function

By installing the optional software to PC, the following MFP function can be realized:

- PC Printer function
- PC Scanner function
- PC FaxModem function
- Location Programing function

For details, see appendix A "MFP product specification"

Note 1: This function is the standard for ODA.

29) FAX2NET function

The following FAX2NET function can be realized:

- FAX over IP function
- FAX to E-mail function
- Virtual E-mail function
- Web retrieval function
- Payment Card Registration (Note2)

For details, see appendix B "FAX2NET Product Specification"

Note2: May not used according to dealer's conditions.

2.2 General Function Specifications

General function specifications for the product are given below. They are summaries of whole descriptions. For convenience of description, the functions are classified in two categories:

User functions and Service functions.

2.2.1 User functions

1) Transmissions

Transmission is available by auto dial (10 one-touch numbers, 70 two-digit numbers, as well as standard keypad dialing).

2) Reception

Reception is available by auto reception and manual reception.

3) Dual access

The machine can scan another document into document memory during memory TX/RX and paper reception.

4) Voice request

A voice request from the transmitter is available only upon completion of the total message transmission.

A voice request from the receiver is available at the end of each page being received.

A voice request function is available in normal transmission and normal reception. (refer to Table 4-x)

5) Auto redial

If a call cannot be connected to the distant station because the line is busy or no answer is returned, this feature redials the same station after a predetermined interval.

The redial interval and the number of redial tries are set by the user in the US/CANADA version and in some INT'L versions where allowed by the PTT, and by a service engineer in other INT'L versions.

If a communication terminates with an error in memory TX mode (no response to POST-COMMANDS) the machine re-dials and re-transmits from the first page to the same station.

6) Manual redial

This feature is available to repeat dialing of the last called dial number.

There is no limit on the number of repeat attempts.

However, there are several restrictions in manual redial and feeder TX operation after restoration of power.

After restoration of power, the machine can not return to the previous operation condition before the power failure.

Restoration of power means that the voltage returns to the normal value after power failure.

For example, the waiting condition of delayed preparation transmission (delayed feeder TX) changes into abandoned documents after power failure. Abandoned document means that the document was set on the feeder, and the phone number for the feeder TX or TX preparation is not set.

Moreover, the waiting of redial condition of feeder TX or feeder TX preparation turns into abandoned document conditions.

Since the registered data for redial is lost by power failure, the manual redial is not available by the past data after power failure.

7) A.D.F.

The feeder feeds 15 sheets maximum (Letter/A4-size 13-28 1b).

When using recommended paper. 20 sheets maximum can be fed.

Note: Recommended paper: 20 1b bond paper (NA Letter and ISO A4-size)

8) Multi-Copy

The machine reproduces max. 50 copies of document with 3.85 lines/mm or 7.7 lines/mm resolution locally.

9) Sender ID

Time & date, plus 32 characters maximum. The sender ID is marked to the top (outside only) of every reproduced copy in the remote receiver.

10) Personal ID

The upper 16 digits of the Sender ID are sent to the remote station separately to indicate the "personal ID".

The personal ID is displayed at the LCD display and is also printed out in the activity report in case of memory reception. This function is available only for communication using NSF signal.

11) TSI/CSI

20 characters maximum are displayed. If the function is enabled, the received TSI is marked at the top of first reproduced copy.

12) Polling (TX & RX)

Documents set on the A.D.F. or in the memory can be polled from a remote station. The machine can also receive documents from a remote station (RX).

Note: Password is not used for the Polling (TX & RX)

13) Acoustic monitor

The monitor is available about 5 seconds after dialing for TX mode only. Loudness is selectable to zero.

14) Activity report

Activity report can manually printed out the latest 30 communications (all transmission, memory reception and error reception) . Normal reception is not reported in the activity report.

Note : This function is not available for GER version.

15) Protocol dump

The protocol dump is printed out by manual operation .

16) Optional telephone

Optional telephone is not available.

17) Automatic alternate selecting call

Two facsimile numbers can be registered to each One-touch key (No. 1 to No. 10) for sending a facsimile message to either of two distant numbers. When the first remote station is busy, the machine automatically dials the other distant number.

18) Delayed TX

This function enters a message transmission time(s) and location(s) for execution at a specified time. 5 specified times can be registered (within 3 days).

19) Relay broadcast initiate

This function automatically originates a message call via a relay station (which should be equipped with a Model OF27, OF38, OKIFAX-2600 or equivalent) to up to 99 locations.

20) Group dial list

This function can store 5 lists.

21) Confidential message transmission

This function transmits a Confidential-marked message to any one of 64 predesignated mailboxes provided in a distant machine.

22) Confidential message reception (Memory)

The receiving message is not printed out on the recording paper, but is stored in 8 mailboxes (memory) specified by the sending side.

The receiving message can be extracted from the mailbox by using the password registered in advance.

23) Half-tone transmission

This function transmits/reproduces the half-tone area of a document image in a 64-scale gradation, using the Error Diffusion Image Processing algorithm.

24) Sequential broadcast

The same message can be sent to 90 at maximum, then 10 random dials are usable. Delayed broadcast is available.

25) No paper/no toner receive

When the recording paper runs out, this feature allows continued reception of documents and memorizes the received data in the built-in 1M-byte memory.

Note: FX-051 does not back up the message received in memory for the power failure.

26) Memory only reception

All received messages are stored in message memory and printed out at the operator's request.

27) Page re-transmission

This feature is a part of the memory transmission feature that re-transmits in page units image information that is distorted to a certain extent during transmission. This feature is effective only for Memory Transmission mode.

28) Distinguishing text from pictures

In half-tone scanning, half-tone image portions such as photographs, can be automatically discriminated from binary text portions by appropriate image processing.

29) Reduction printing

In the case of reception mode, in order to print the received document in one cut sheet as far as possible, the vertical reduction rate at the time of printing is about 100% to 75%.

For details, refer to 4.7.2.1 "Variable (reduction) printing".

30) Smoothing print

The machine can provide the higher resolution print with image smoothing process. Copy and received Fax messages are interpolated and printed out quasi 300 dpi with print image smoothing technology.

When the received or copy document is 8 dots/mm x 3.85, 7.7 or 15.4 lines/mm, the printed document will be 300 dots/inch x 784 lines/inch.

31) Dialing

The following four types of dialing are available.

- One-touch dial: 10 one-touch keys
Max. 32 digits
- Speed dial: 70 two-digit auto dial codes
Max. 32 digits
- Group dial: 5 dialing groups
Max. 80
- Keypad dial: Full digit keypad dialing

32) Chain dialing

This means consecutive dialing by using 2 or more One touch keys.

33) Realtime dialing

The dialing digit signal can be transmitted immediately to the line when pressing the keypad, when dialing with telephone off-hook or Hook key is pressed.

34) Automatic pause signal insertion

A pause signal can be inserted automatically only in Re-dial operation after real time dialing has been executed.

35) Mixed dialing

The DTMF tone signal is output when the * key is pressed after DP dialing.

36) TX Preparation (Hopper)

This feature enables the machine to prepare for scanning and transmitting the document set on the ADF during reception or communication of the other documents stored in memory. After completion of the communication, the document set on the ADF will be scanned and transmitted.

37) Local copy

A document sheet on the A.D.F. can be copied locally with following resolution on the print sheet.

Scanning: 200* dots/inch x 3.85 lines/mm or 300 dots/inch x 7.7 lines/mm or
15.4 lines/mm

* : Convert from 300 to 200

Printing: 300 dots/inch x 784 lines/inch

Note : The image smoothing process printing is used STD scanning resolution (200 dots/inch x 3.85 lines/mm).

38) Alpha/Location (Telephone directory)

In addition to the telephone numbers, each of the one-touch keys and the Speed-dial locations may have an alpha/numeric name registered to it.

The maximum number of characters is 15.

39) TEL/FAX automatic switching

- (1) If the machine detects a call with a CNG signal indicating an auto send facsimile call, it starts an automatic document receiving operation.
- (2) If it detects a call without a CNG signal, it sounds the buzzer to indicate a telephone call. The calling person can hear a "ring back" tone within a predetermined time.

If the operator at the called side does not lift the handset within the predetermined time, the machine automatically starts a document receiving operation.

Voice conversation will be available automatically through the handset by lifting up the handset or press the STOP key while the call buzzer is sounding.

Note 1: The predetermined time is selectable between 20 or 35 sec.

40) Session number

The session number is assigned automatically to the document transmitted and is transmitted together with Sender ID on the top of each page.

41) Time and Date print

Time and Date information of the receiver side can be printed on every page of the document received (except memory reception).

42) Closed user group (Direct mail rejection)

This feature limits communication by TSI/CSI.

The received TSI/CSI from the remote location is compared with the bottom 4-digits in One-touch and Speed-dial numbers registered in the machine. When it matches the 4 digits, message receiving is accepted.

43) TX contrast and resolution control

The document transmitted can be controlled with 3-levels of contrast (dark, normal, light) and 3-levels of resolution (standard, fine, extra fine) by the control panel.

44) Key touch tone

The key touch tone sounds when any key on the control panel is pressed.

45) Machine counter (Under planning)

The machine has five counters to count DRUM, TONER, DRUMT and PRINT for printer section and SCAN for scanner section.

Caution of "CHANGE DRUM" is displayed on LCD when the DRUM has reached the life time.

User can reset the DRUM counter when the user change the DRUM.

However, user cannot reset the DRUMT counter regarding total number of DRUM counter for the machine, to save the history.

Counter	Display		Clear Operation	
	User	Service	User	Service
DRUM COUNTER	x	○	○	○
TONER COUNTER	x	○	x*1	○
DRUMT COUNTER	x	○	x	○
PRINT COUNTER	○	○	x	○
SCAN COUNTER	○	○	x	○

○ is available. x is not available.

*1: ODA version is available

46) Message confirmation report (single address or multi-addresses)

- (i) The destination address (CSI, etc.), the result of the last transmission attempt and the total number of pages, etc., are automatically printed. In case of Memory Tx, a part of the picture is added to MCF report at automatic print-out mode. ON/OFF setting of automatic printing is available and manual control for printing is also available.
- (ii) A message confirmation report for multi-addresses communication such as broadcast can be also printed automatically with ON/OFF setting. Message confirmation is individually printed for each address.

47) Broadcast entry report (confirmation purpose)

For broadcast, each destination address and entry time etc. (immediate or delayed), is available for printing by manual control, only during programming prior to the communication.

48) Transmission error report

The destination address, error status and total number of pages etc, are printed out when a communication error takes place.

49) Confidential RX report

This report is printed out when the confidential RX message is received.

50) Speed scanning

This function is automatically activated to reduce the operation time during scanning.

51) TAD mode (For external telephone answering device)

This function switches an automatic voice message response to the calling station.

When TAD does not answer the RI signal from the line, or the machine cannot detect the OFF-HOOK state, though the machine is set to the state of TAD mode, the machine can automatic answer according to the value of T/F Timer PRG. (User's setting No. 10).

(Refer to Fig. 4-4-12)

The machine has 4 types (OFF/TYPER1/TYPER2/TYPER3) of settings in SERVICEMAN SETTING with regard to TAD mode.

OFF setting means that the machine does not have TAD MODE function.

- TYPER1 means ...
1. RING comes.
 2. The TAD makes answering, returns the recorded voice message in TAD for calling party.
 3. The FAX machine will examine to detect CNG signal while TAD works.
 4. If the FAX machine detects CNG signal or Remote Receive No., the machine will go into normal receiving mode.
 5. Even though the FAX machine does not detect CNG signal , the FAX machine will go to receiving mode in hook-on condition.

TYPER1 is the same as OKIFAX1000 series.

TYPE2 means ... The functions from #1 to #4 of upper TYPE2 are the same as TYPE1.
If the FAX machine does not detect CNG signal during working of TAD, the machine will go to standby mode.

TYPE3 means ... The functions from #1 to #2 of upper TYPE3 are the same as TYPE1.
3. The fax machine does not detect CNG signal during 15 seconds from start of TAD operation.
4. The fax machine starts CNG signal detection after 15 seconds from start of TAD operation and shifts to receiving mode after detecting CNG signal.
5. If the fax machine does not detect CNG signal during working of TAD, the machine will go to standby mode.

52) FAX forwarding

This function is not available.

53) ANIS

This function is the operation in order to utilize specific service "ANIS". This function is available only for German area.

(In case of setting Country code to GER, AUT or SUI)

Machine's performance is as follows:

When operator enters hyphen key, machine controls "FLASH process" for 250 msec.

54) Other functions

- Date and Clock adjustment
- Print out of machine configuration
- Telephone number lists registered as Local Code
- Telephone number list of One-touch keys
- TSI print
- Generate CNG signal
- Generate CED signal
- Echo protection for international TX/RX
- Parallel pick up (Switching by the external TEL)
- Distinctive ring detect
- Unique parameter (set to One-touch keys. e.g. Echo protection)
- Programmable parameter list (user dial-parameter setting)
- Power outage report
- Confidential reception
- Polling TX (Memory)
- Bulletin poll TX
- Restricted access
- Active memory files
- EXTRA FINE (15.4 lines/mm) reception capability

55) The following functions are not available.

- 2nd cassette
- Confidential broadcast
- Relay broadcast
- Delayed confidential transmission
- Delayed relay broadcast initiate
- Split transmission
- Delayed mail box transmission
- Secure poll TX
- Battery backup (picture data)
- FAX forwarding
- No reduction TX
- Reduction TX
- Secure polling RX
- Continuous polling RX
- Multiple address polling RX
- Delayed multiple address polling RX
- Internal Encryption
- DTMF operation
- Generate bell signal for external telephone
- Voice answering
- Repeat printing
- Department ID
- TEL charge account
- Auto cover sheet
- Total page set
- Memory entry report (Single address)
- Memory entry report (Multi-polling RX)
- Relay broadcast report
- RX error message print (When reception is discontinued)
- Programmed parameter list
- Verification stamp

2.2.2 Service functions

1) Local diagnosis (Refer to Fig. 4-1-1/2)

Local diagnosis consists of a LED test, MF tone test, sensor test, H-MODEM TX/RX test, tone test and print test, including memorized test pattern printing, a memory check and a program version check.

2) RMCS

- (i) The remote diagnosis consists of at least by current RMCS model 20 (Remote Management Center System)

3) Other functions

- MDY/DMY switchable
- Long document Scanning
- Attenuator
- NL equalizer
- No paper/No toner RX
- Sensor CAL.
- Service bit
- TIME/DATE print
- Service default list
- Machine configuration list
- Echo Protection (Ignore 1st DIS/CED-DIS timer/Tone for echo)
Echo Protection setting includes the Ignore 1st DIS, CED-DIS timer to unity from three to one setting.
Detailed setting is shown below.

New setting	Echo Protection	OFF	ON
Current setting	Ignore 1st DIS	OFF	ON
	CED-DIS timer	75 ms	1.5 s
	Tone for echo	OFF	ON

3. PHYSICAL DESCRIPTION

3.1 General Appearance

Overall design and mechanical structure of the product are shown in Fig. 3-1, 3-2.

3.2 Dimensions

Overall dimensions of the product are less than the following:

Width: Approx. 316 mm

Depth: Approx. 383 mm

Height: Approx. 190 mm

3.3 Weight

The nominal weight of the product, excluding recording paper and packing materials, will not exceed approx. 8 kg.

3.4 Product Identification

The ODA/OEL/OEM companies corporate logo and product name will appear on the control panel sheet.

3.5 Corporate Colors

The color and finish of the cabinet, and various attachments are shown in Table 3-1.

3.6 Model Number Plate and Serial Number Label

Model number plate and serial number label will be attached to the machine. This model number plate will give agency approvals (UL, CSA, safety requirements), model number, AC power requirements, and will identify the ODA/OEL company as the vendor.

3.7 Control Panel

The Control Panel is shown as Fig. 3-3.

3.8 Labels and Decals

Some of the following Labels and Decals shall be pasted on the machine if necessary.

- FCC Label Part 15 and Part 68
- Warning label on Power code
- DOC certification
- DOC LOAD NUMBER
- BABT Approval Label
- BABT REN Label
- Warning Label for Fuser

3.9 Second Tray

Second Tray is not available.

3.9.1 Corporate color

The color and finish of the cabinet is shown in Table 3-1 and 3-2.

3.10 Optional Telephone

Optional Telephone is not available.

Table 3-1 OKI FX-051 Corporate Colors

Parts Description	Color Name	Color Reference
Enclosures		
Cover-Top	Silver Gray	OKI DATA Original 3.5Y8/0.5
Tray-Paper	Ditto	Ditto
Cover - Front	Ditto	Ditto
Cover - Main	Ditto	Ditto
Cover - NCU	Ditto	Ditto
Cover - Rear	Ditto	Ditto
Tray - Document	Ditto	Ditto
Other Parts		
Stacker Document	Silver Gray	OKI DATA Original 3.5Y8/0.5
Telephone Set (Option)	Silver Gray	OKI DATA Original 3.5Y8/0.5
Control Panel		
Case-OPE(T)	Silver Gray	OKI DATA Original 3.5Y8/0.5
Start Button	Blue	JSR-6D7960
Stop Button	Pink	JSR-4D5780
Ten Key	Silver Gray	OKI DATA Original 3.5Y8/0.5
Function Button	Ditto	Ditto
One Touch Key	Ditto	Ditto
Function Sheet	Cool Gray	PANTONE Cool Gray 7C
One Touch Sheet	Cool Gray	PANTONE Cool Gray 7C
Ten Key Sheet	Cool Gray	PANTONE Cool Gray 5C
Status Indicator (LED)	Amber	None
Alarm Indicator (LED)	Red	None
Lettering and Symbol		
Start Button	White	N9.5
Stop Button	White	N9.5
Ten Key	Cool Gray	PANTONE Cool Gray 10C
Function Sheet	Cool Gray	PANTONE Cool Gray 11C
One Touch Sheet	Cool Gray	PANTONE Cool Gray 7C
Ten Key Sheet	White	N9
LOGO (Model name: OKIFAX4500)	Cool Gray	PANTONE Cool Gray 11C
("OKIDATA" & "84")	Red	PMS 032
("OKI")	Red	PANTONE 032C
(Model name: OKIOFFICE)	Gray	PMS 425

Note: Pending for ODA version.

Operator Panel Design (Alphabetical Characters on Ten-key Pad)

The specification is accordance with ITU (formely CCITT) recommendation, E.161.
Some other countries will also introduce this specification for the approvals in near future.

1	ABC 2	DEF 3
GHI 4	JKL 5	MNO 6
PQRS 7	TUV 8	WXYZ 9
* TONE	0 OPER/UNIQUE	#

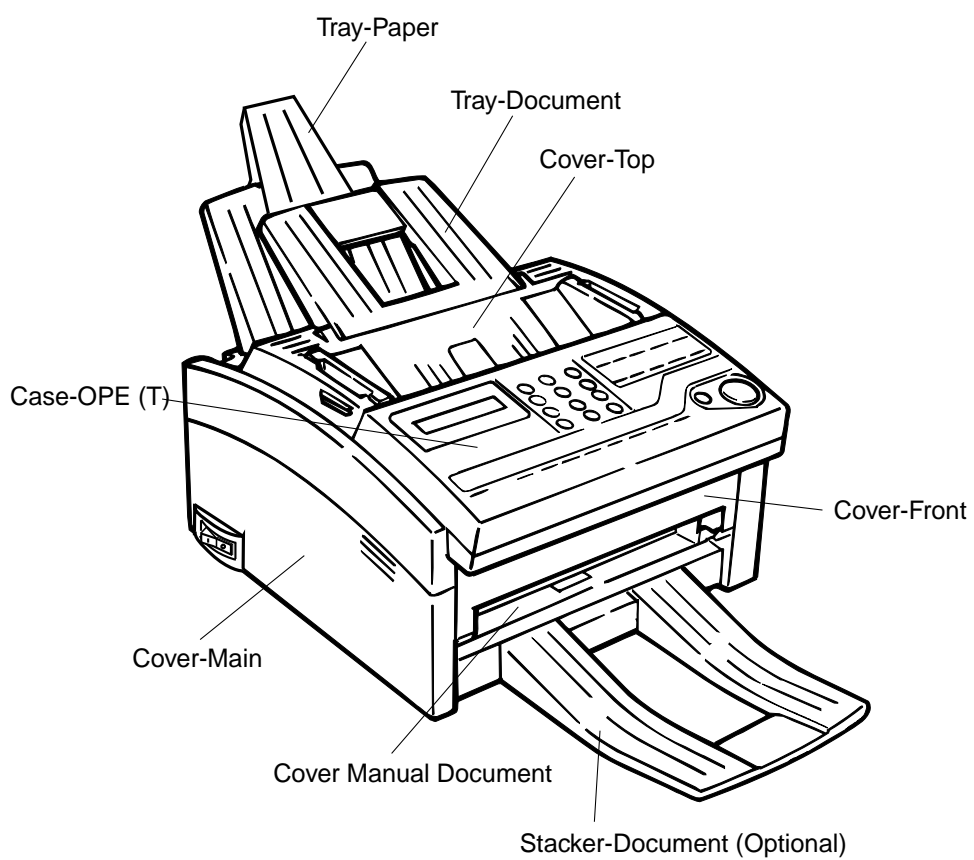
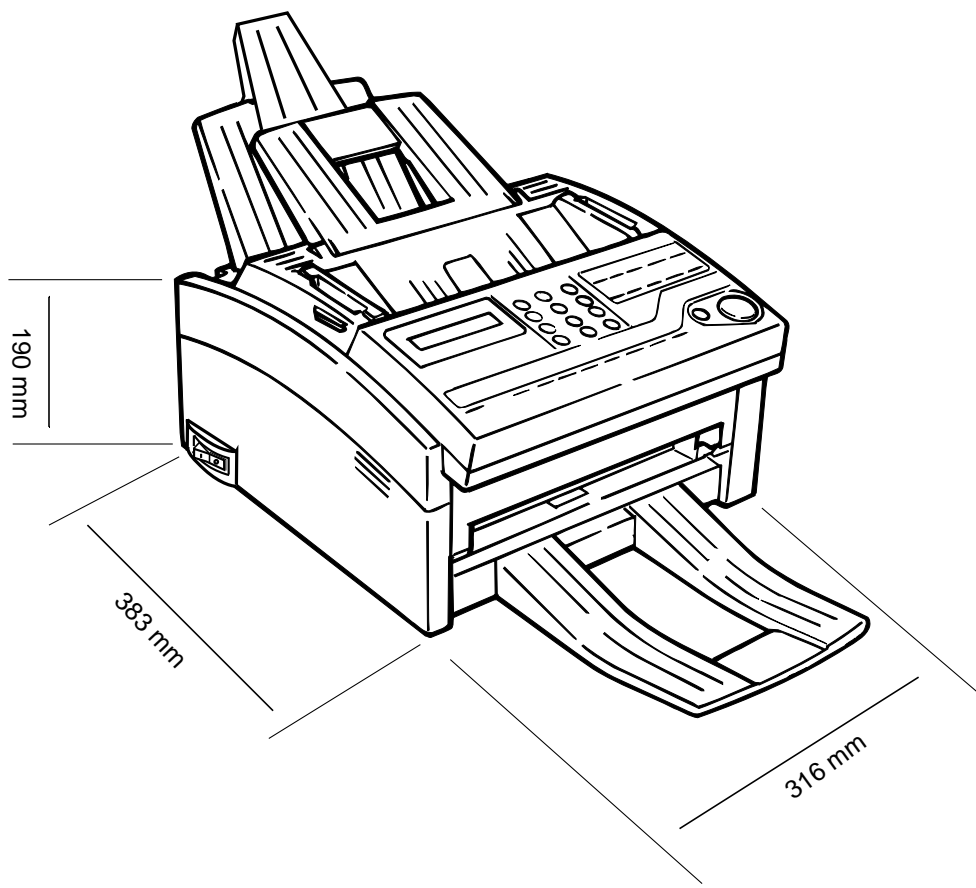

Fig. 3-1 FX-051 External View

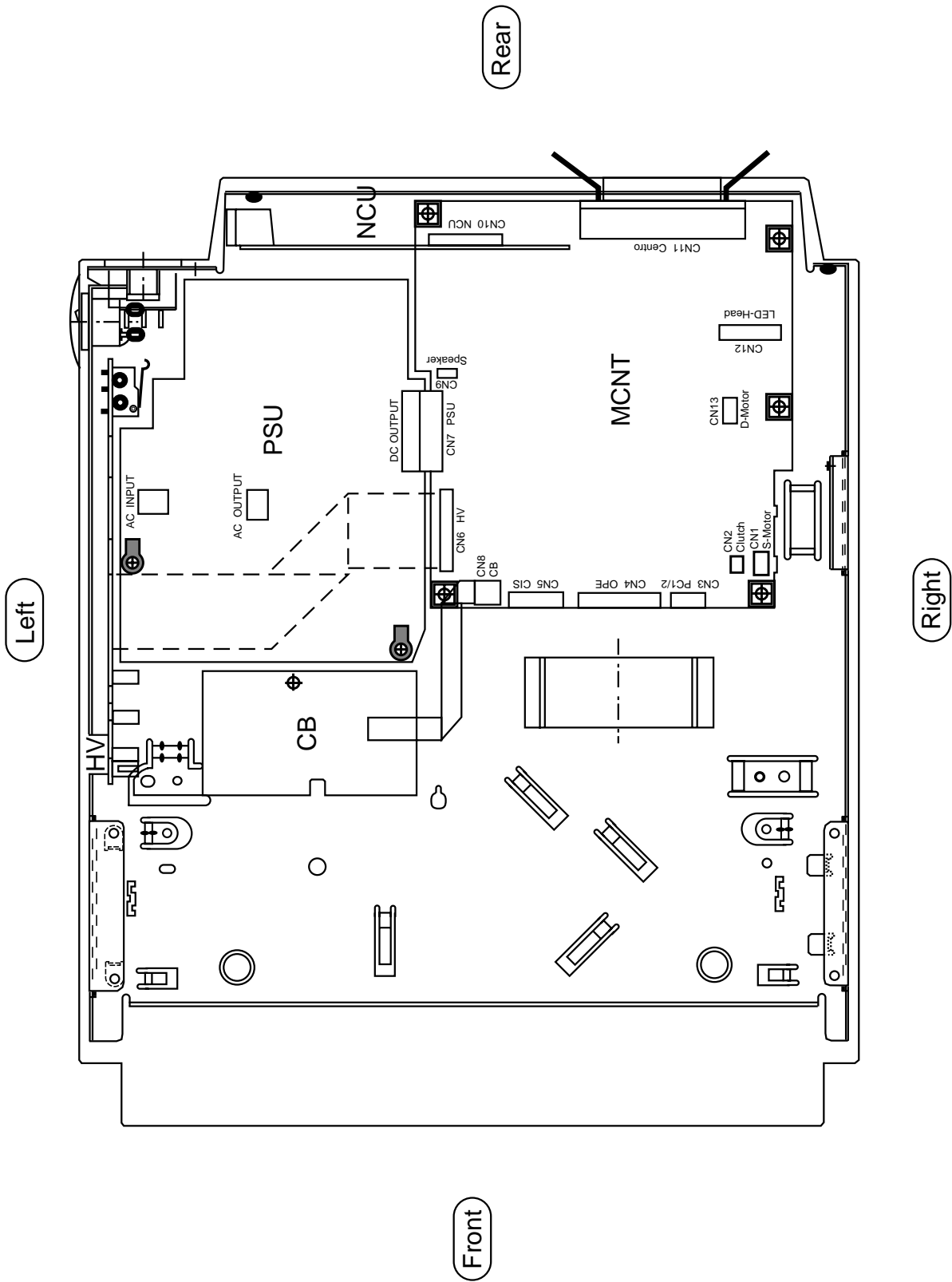

Fig. 3-2-1 Internal Configuration for FX-051

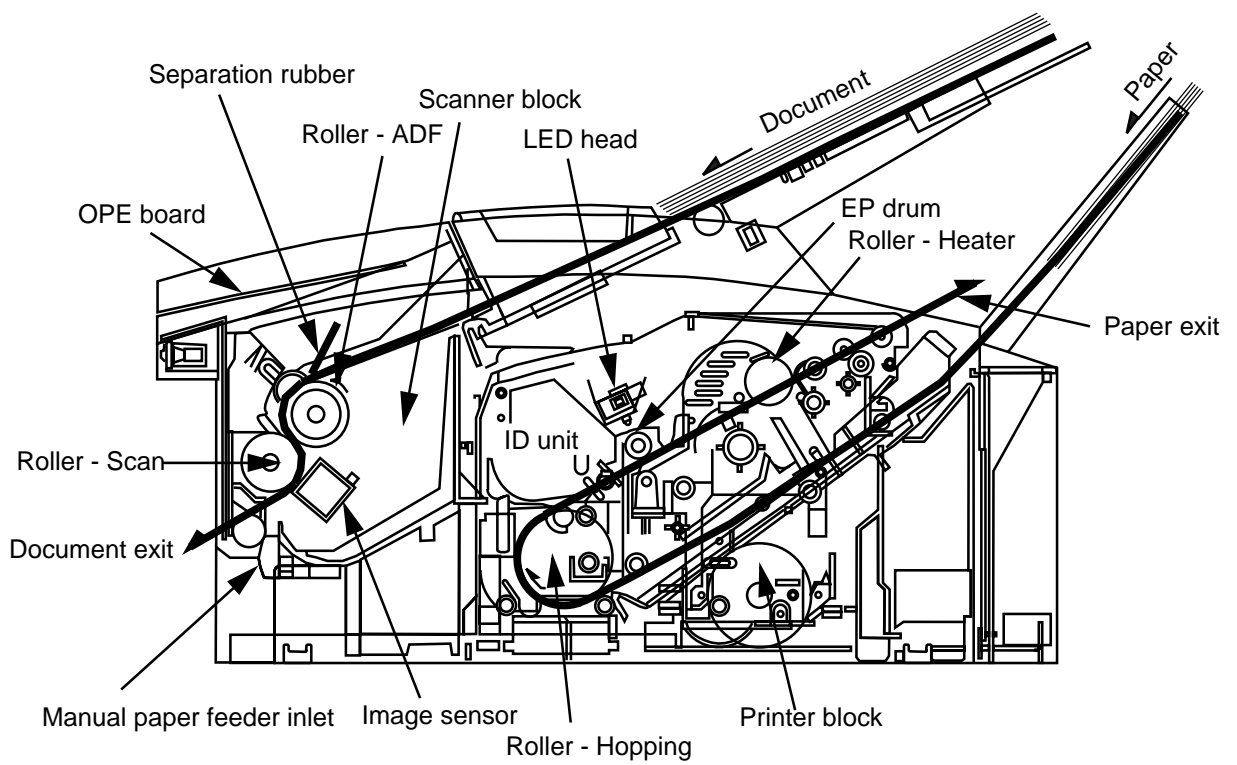

Fig. 3-2-2 Internal Configuration for FX-051

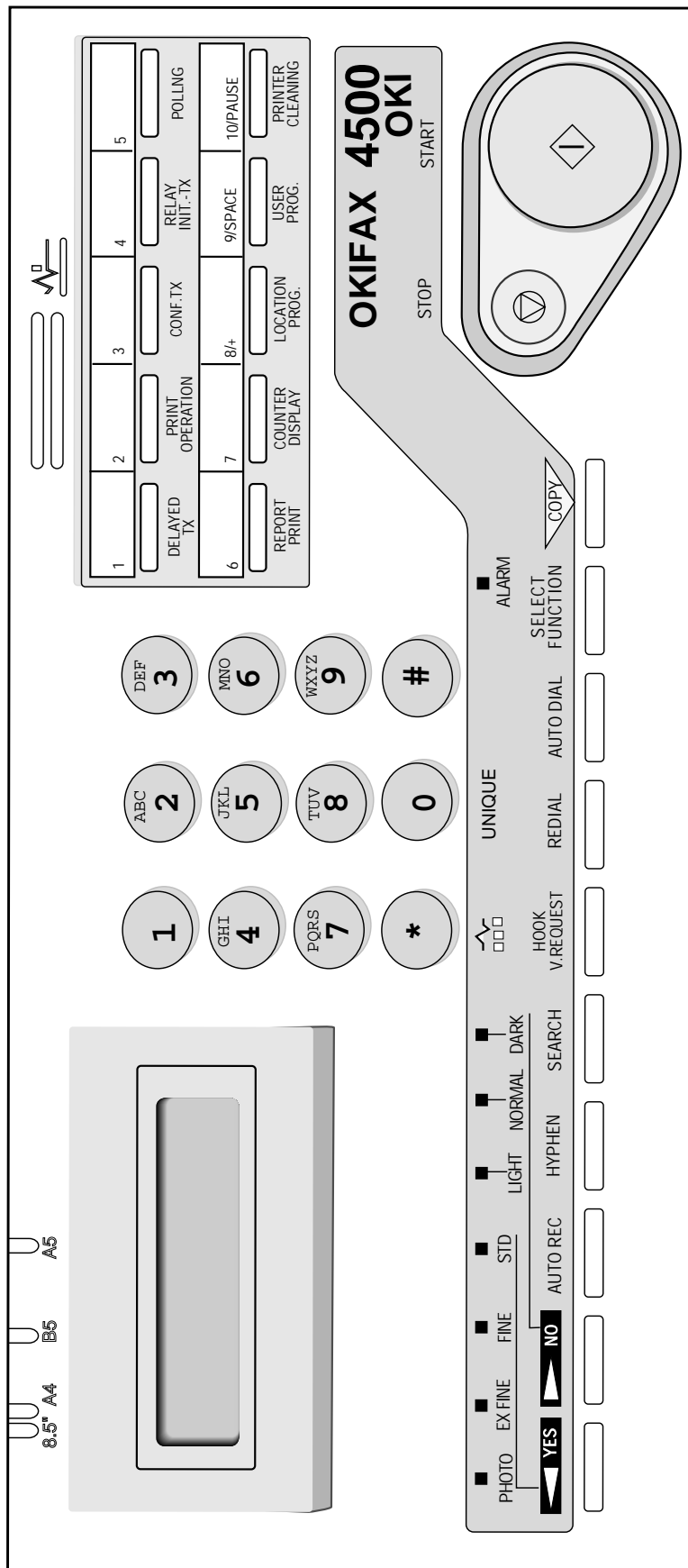

Fig. 3-3 FX-051 Control Panel

INDEX

Fig. 4-1 (1/2-2/2)	General Key Operation (No Document)
Fig. 4-1-1 (1/2-2/2)	Typical Transmission
Fig. 4-1-2	Typical Reception
Fig. 4-2-1	Power on Operation
Fig. 4-2-2 (1/2-2/2)	FX-051 Mechanical Control Sequence

Operation with Programming

Fig. 4-3-1	One Touch Key Operation
Fig. 4-3-2	Technical Programming
Fig. 4-3-3 (1/3-3/3)	Local Test
Fig. 4-3-4 (1/3-3/3)	Technical Function Programming
Fig. 4-3-5	System Reset
Fig. 4-3-6	Default Type Setting
Fig. 4-3-7	Delayed TX
Fig. 4-3-8 (1/2-2/2)	Personal Box Print Out
Fig. 4-3-9	Confidential TX Programming
Fig. 4-3-10 (1/2-2/2)	Relay Broadcast Initiate
Fig. 4-3-11	Polling TX/RX Programming
Fig. 4-3-12 (1/2-2/2)	Report Print
Fig. 4-3-13 (1/2-2/2)	Counter Display/Clear
Fig. 4-3-14	One-Touch Programming
Fig. 4-3-15	Auto-Dial Programming
Fig. 4-3-16	Group Dial Programming
Fig. 4-3-17	User Function Programming
Fig. 4-3-18 (1/4-4/4)	Function Programming
Fig. 4-3-19 (1/4-4/4)	Dial Parameters
Fig. 4-3-20	Clock Adjustment
Fig. 4-3-21	System Data Programming
Fig. 4-3-22	Personal Box Programming
Fig. 4-3-23	Memory Password Programming
Fig. 4-3-24	Restrict ID Programming
Fig. 4-3-25	Printer Cleaning Operation

Operations During Communication or Standby

Fig. 4-4-1	Copy Operation
Fig. 4-4-2	Message Confirmation Report
Fig. 4-4-3 (1/3-3/3)	AUTO REC Key Operation
Fig. 4-4-4	Transmit Resolution and Type of Original
Fig. 4-4-5 (1/3-3/3)	LCD Message During Communication
Fig. 4-4-6 (1/5-5/5)	Calling Operation
Fig. 4-4-7	Memory Cancel
Fig. 4-4-8	Stop Operation
Fig. 4-4-9	Voice Request
Fig. 4-4-10	Alarm State and Received into Memory
Fig. 4-4-11	TEL/FAX AUTO SW Reception
Fig. 4-4-12	TAD Interface
Fig. 4-4-13	Print Out from Memory Reception by Replace Paper
Fig. 4-4-14 (1/2-2/2)	Print Out from Memory (Memory Only Reception)
Fig. 4-4-15	Power Off Report
Fig. 4-4-16	TX Preparation and Dual Access
Fig. 4-4-17	PC Mode Transmission and Reception
Fig. 4-4-18	Local Printer and Scanner Operations for PC Interface
Fig. 4-4-19	Flash Memory Write Operation
Fig. 4-4-20	Power Save Mode
Fig. 4-4-21 (1/2-2/2)	Location Programming
Fig. 4-4-22 (1/2-2/2)	Chain Dial
Fig. 4-4-23	RESTRICT ACCESS
Fig. 4-4-24	Instant Dialing Operation

Reports

Fig. 4-5-1	Message Confirmation Report (MCF)
Fig. 4-5-2	IMAGE in MCF with Memory TX
Fig. 4-5-3	Activity Report
Fig. 4-5-4	Active Memory Files
Fig. 4-5-5	Configuration Report (User)
Fig. 4-5-6	Service Default Report
Fig. 4-5-7-1	Telephone Directory

Fig. 4-5-8	Protocol Dump Report
Fig. 4-5-9	Broadcast Entry Report
Fig. 4-5-10	Broadcast Confirmation Report
Fig. 4-5-11	Power Outage Report
Fig. 4-5-12	Confidential RX Report
Fig. 4-5-13	Call Back Message
Fig. 4-5-14	Self Diagnosis

FX-051 Tables Index

Table 4-1	Multiple Function Combinations for Transmissions
Table 4-2	Multiple Function Combinations for Reception
Table 4-3	Functions Combinations for Polling TX/RX
Table 4-4	Functions Combinations during Communications
Table 4-5	Preparation TX as Dual Access
Table 4-6 (1/2-2/2)	User Default Setting
Table 4-7 (1/2-2/2)	Technical Default Setting
Table 4-8	Default Setting of Dial Parameters
Table 4-9	Plug & Play ID

4. OPERATION

For operation, Table 4-1 to Table 4-9, Fig. 4-1 to Fig. 4-5 are attached at the end of this Section.

4.1 Major Apparatus Appearing on the Machine's Cabinet

Fig. 3-1, 3-3 and 3-4 shows the machine's cabinet design for US/CANADA/INT'L versions. Fig. 3-2 and Fig.4-2-8 also shows a simple illustration of the Paper Loading/Replacement Procedure. Major apparatus frequently used for machine operations are indicated.

4.1.1 Document Guides

Two sliding guides to hold documents in the central position on the hopper. The guides are interlocked to widen or narrow when either one of the guides is moved to the left or right.

4.1.2 Tray-Paper

Recording paper loader (Tray-Paper) is prepared instead of paper cassette. A tray on which the printed sheets are stacked automatically. Tray-paper is commonly used as copy stacker also. Paper exit plate separates recording paper and printed paper.

4.1.3 Document Stacker

A tray on which document sheets are stacked automatically when finished in the read section.

4.1.4 Control Panel

A panel, on which, are all the controls and indicators to perform and program various machine operations. The functions of the controls and indicators will be described later in detail. The operator can open this panel to remove a jammed document by picking up the jammed document mark position.

4.1.5 Automatic Document Feeder (ADF)

A feeder having a horizontal slit or inlet to permit documents to be fed in to the read section automatically, one at a time. Documents of width Letter-size or less can be automatically fed into the read section. The sub hopper is installed in the document table assy. This apparatus shall be referred to as "hopper" in the description of the product later.

4.1.6 Manual Paper Feeder

A slot of the manual paper feeder is prepared underneath front face.

4.1.7 AC Inlet

A male-type 3-pin connector to which the furnished AC power cord is connected.

Note: The fuse for the mains is located within the power supply unit to prevent replacement by the user. When the fuse blows, a service person needs to replace the entire power supply unit. The location therefore, is not pointed out specifically.

4.1.8 Power Switch

This is the machine's main AC power switch.

4.1.9 Line Terminal

This connects the machine to telephone line.

4.1.10 Telephone Terminal

This connects the machine to an optional telephone handset and/or an external telephone unit.

4.1.11 Optional Memory Board Interface

This interface is not provided.

4.1.12 Second Cassette Interface

This interface is not provided.

4.1.13 PC Interface Connector

IEEE 1284 bi-directional parallel interface is supplied to the back side of the machine.

4.1.14 Optional Telephone Handset

This interface is not provided.

4.2 Controls and Indicators on Control Panel (Fig. 3-3)

This Section identifies the locations of controls and indicators provided on Control Panel and explains their functions briefly. The detail of user and service functions are described in Section 4.4 "User Functions" and 4.5 "Technical Programming".

All the control and indicator apparatus are laid on Control Panel for ease of access to and operation of the control apparatus, except for a few such as the power switch (located on the back/left in the main cover).

All LED indicators provided on Control Panel are amber except ALARM which is red.

The LCD display provided is capable of indicating two rows of 20 characters.

4.2.1 AUTO REC

Function: Selects the mode from the auto receiving, manual receiving, memory receive mode, PC mode (by installing the optional software to PC), TEL/FAX automatic switching, TAD interface modes.

Display: The LCD display is changed in the order of AUTO RECEIVE MODE, MANUAL RECEIVE MODE, TEL/FAX AUTO SW MODE, and TAD/FAX SW MODE, MEMORY RX MODE, PC MODE each time the AUTO-REC key is pressed. (Refer to Fig. 4-4-3-1/3-3/3.)

4.2.2 Transmit Resolution (YES key)

Function: After having set the document, press the "YES" key to select the transmit resolution. Sequentially selects the resolution of the document vertical scanning capability of the machine in the order of STD (Standard), FINE, EXTRA FINE and PHOTO. The horizontal resolution is fixed to 300 DPI in order to LED head. 300 DPI is available when remote machine has a capability of the 300 DPI communication.

When the remote machine does not have a capability of 300 DPI communication, Horizontal resolution is reduced automatically from 300 DPI to 8 dot/mm. The vertical resolution will vary according to the position selected:

Resolution	COPY	TX	
		RX does not supports 300DPI	RX supports 300DPI
STD	200DPI × 3.85line/mm	8dot/mm × 3.85line/mm	←
FINE	300DPI × 7.7line/mm	8dot/mm × 7.7line/mm	←
EXTRA-FINE	300DPI × 15.4line/mm	8dot/mm × 15.4line/mm	300DPI × 300DPI
PHOTO	300DPI × 7.7line/mm	8dot/mm × 7.7line/mm	←

PHOTO is applicable when the original document includes half-tone images and will cause the machine to send the image data in scale grades, using error diffusion algorithm.

This key has an additional function. During an operation to select a function or to assign telephone numbers to auto dial codes, the operator can use this key to move the cursor on LCD display to the left direction.

Note: When COPY button is pressed, selected STD mode will change to FINE mode automatically. After COPY button was pressed once, it is possible for the operator to select the resolution at the time of COPY setting by pressing the Yes key.

Learning function: The machine memorizes the destination machine's ability (resolution) to each one-touch and auto-dial number in every communication.

Display: Four LED indicators corresponding to STD, FINE, EXFINE and PHOTO. When PHOTO mode is selected, only PHOTO LED is lit.

Default: Set to STD at the factory delivery.

4.2.3 Type of Original (NO key)

Function: After set the documents, press the "NO key to set the type of original. Sequentially selects the contrast compensating function of the machine in the order of DARK, NORMAL, and LIGHT to improve the picture quality of document reproduced at the receiving end, according to the contrast condition of the original document.

DARK should be select if the entire color of document is dark with a low contrast between the printed text and the paper background.

NORMAL is normally selected when the entire color of document is not too dark nor too whitish, while the contrast between the text and background is clear.

LIGHT is selected when the entire color of document is whitish with a low contrast between the printed text and paper background.

This key has an additional function. During an operation to select a function or to assign telephone numbers to auto dial codes, the operator can use this key to move the cursor on LCD display to the right direction.

Display: Three LED indicators corresponding to NORMAL, LIGHT, and DARK.

Default: Set to NORMAL at the factory delivery.

4.2.4 COPY

Function: This key is used for four purposes: document copying, transmission or communication receipt output, location programming for one-touch or autodial and service person setting mode.

When document is placed on ADF, the switch serves as a command key to direct the machine to start a copying operation.

Pressing this key without any document on the feeder causes displaying the latest transmission result on LCD and pressing this key again within 3 seconds causes the latest transmission receipt. (Refer to Fig. 4-4-2.)

Pressing this key allows the operator to location programming for one-toch or auto dial before start of dialing at the end of entering telephone number by ten key. (Refer to Fig.4-4-21-2/2)

To set the service person setting mode, either press the FUNCTION key first and press the COPY key twice or turn on the power supply on while the COPY key is being held down.

Display: When a copying operation is initiated, a message to indicate the copying status of the machine will show up on LCD display. Upon completion of the copying, LCD display will return to the indication of stand by (current time).

During printing Message Confirmation, a message to indicate the machine status will show up to LCD display. Upon completion of the printing, the message will change to stand by (current time).

4.2.5 Select Function

Function: This key is used for triggering selection of various functions. LCD display will return to standby mode immediately, when pressing this key during selection of various functions.

Display: The following message is displayed on the LCD upon pressing this key whether document is placed on the ADF or not.

SELECT FUNCTION (OT) MEMORY AVAIL = 100%

The upper line message indicate to press that One touch key to which a desired function is assigned.

The lower line message indicates the available memory as a percentage (%).

4.2.6 Auto Dial

Function: When pressed, will identify to the machine that the 2-digits code which follows is an auto-dial code registered in advance.

A total of 70 locations numbered can be programmed.

The operator can use AUTO DIAL with the external handset both on hook and off hook.

Display: When pressed, a guidance message will appear on LCD display, prompting the operator to enter a 2-digits auto dial code.

4.2.7 Keypad

Function: Twelve keys on the keypad function the same as those of a conventional keypad provided on regular telephone instruments. Numeral keys represent 1 to 0, inclusive, and "*" and "#," the corresponding symbols. The operator can use them for:

- 1) Directory dialing the full-digit telephone number and ID registration to select a distant station.
- 2) Assignment of a full-digit telephone number to an auto dial code.
- 3) Entry of numerical data in the course of programming certain user functions (for example, report printouts, Date and Time adjustment, Sender ID selection, etc.).
- 4) Designation of the first character of the destination ID as the search object in search dialing.
- 5) Registration of machine ID, TSI

Display: When a key is pressed, the numeral or symbol corresponding to the pressed key will show up on LCD display.

4.2.8 REDIAL

Function: Directs the machine to redial the same telephone number used in the previous call which failed connection to the called station by some reason (for example, line busy, no answer, etc.).

This feature is called "Manual Redial," and made effective immediately every time

Note: After restoration of power, the machine cannot return to previous operation condition before the power failure. Restoration of power means that the voltage returns to the normal value after power failure. Since the registered data for redial is lost by power failure, the manual redial is not available by the past data after power failure.

Display: A message to indicate the redial state will show up on LCD display.

4.2.9 STOP

Function: When STOP key is pressed twice within 3 seconds during message transmission, the machine will immediately stop the operation. The half-fed document to the stacker will come to a halt. To remove the document, open the Control panel cover upward.

When STOP key is pressed during message reception or during clearing of flash memory (PROGRAMMING is displayed on LCD) or during pre-feeding, the machine will not stop the reception. The machine ignores STOP key operation.

Cancellation During TX

Press STOP key twice within 3 seconds to cancel a current session's transmission.

If the machine is in waiting state of multi-session of transmission or broadcast transmission, WAITING is displayed on the bottom row of the LCD, the STOP is pressed one time to go to normal memory cancellation procedure. Refer to Fig. 4-4-7.

Operator can select the session(s) to be canceled in the procedure.

Message STOP is printed in result column on the message confirmation report (MCF).

Cancellation During RX

Cancellation of memory reception data when STOP key is pressed while recorded paper is discharging during memory reception or confidential reception. When STOP key is pressed during local copying operation, the machine will stop the copying operation after printing out current page. To remove the document, open the control panel cover upward, and remove the paper fed half-way. The recorded paper is automatically discharged.

Another function of this switch is to allow the operator or service man to terminate any key programming operation. All data entered by that time of the particular programming will be made invalid.

While you are programming, pressing STOP takes you back step-by-step through the programming functions you have already selected.

Display: Refer to fig. 4-4-8 for the stop key operation.

4.2.10 START

Function: When pressed, will cause the machine to start up for whatever the operator has commanded to the machine in advance - for example, message transmission, manual message reception, technical programming, etc.

Display: When pressed, a message will appear on LCD display, which identifies the operation the machine will conduct.

4.2.11 PLUS, PAUSE and SPACE

PLUS is No. 8, PAUSE is No. 9 and SPACE is No. 10

Function: One-Touch keys for PLUS, PAUSE and SPACE have dual functions, according to the timing at which the key is pressed.

When the operator is dial-selecting a distant location, those keys function as auto-dial One-Touch keys.

When the operator is programming assignment of telephone numbers to Auto Dial Codes, those keys represent symbols corresponding to "(plus)", "(space)" and "(pause command)", respectively.

"Plus" is used to connect the next telephone number for chain dial.

"Pause" is used to place an interval of 3 seconds between two successive digits in dialing for the exchange discrimination purpose, wherever required.

"Space" may, or may not, be inserted between digits simply for better readability.

Display: During address selection, the full-digit telephone number assigned to No. 15 will appear on LCD display. If no telephone number is assigned, LCD display will show the following example prompt for 3 seconds.

NOT PROGRAMMED

During an auto dial code programming, a symbol corresponding to Pause Command, or Space will show up at the position where the cursor is located on LCD display, depending on the key pressed.

4.2.12 One-Touch Keys

Function: One touch keys are used for following purposes.

- single destination designation
- various functions for communication or registration

a) Single destination designation

When used for single destination designation, pressing each key causes the origination of a call to preregistered destination telephone number.

Following data registration is available for the single destination designation.

Key number 1-10

- destination telephone numbers
- ID
- alternate destination telephone number

b) Various functions for communication or registration

Operator can select the various functions directly by using one touch key after pressing SELECT FUNCTION key. "SELECT FUNCTION (OT)" is displayed on LCD when one touch key can be used for various preprogrammed functions.

example

```
SELECT FUNCTION (OT)
MEMORY AVAIL.= 100%
```

These assigned various functions are shown in Fig. 4-3-1 and Fig. 3-7 ~ Fig. 3-9 control panel.

Display: When pressed to dial select the distant station, the full-digit telephone number corresponding to the auto dial code assigned to the pressed key will show up on LCD display.

4.2.13 HYPHEN

Function: This key has two functions.

- 1) Used as the "+" input key in registering TSI/CSI or Call Back Message.
- 2) Used as the "-" input key in registering One-touch/Auto dial Tel No. or ID to switch the PTT parameters.

4.2.14 V. REQUEST/HOOK

Toggle selecting action between activation and deactivation of the voice request initiated by the operator.

This function does not available in Instant dialing and memory reception. (Table 4-1)

Function: this key has 2 functions.

- 1) Used as the hook-up/hook-down key while the optional or external telephone set is held on-hook. During hook-up, the built-in speaker allows monitoring line conditions.
- 2) Used as the voice request key for triggering conversation request during communication and connection of the circuit with the telephone set. (Fig. 4-4-9)
The LCD displays the condition of voice request activating.

4.2.15 SEARCH

Function: Used for search dialing: either manual search or auto search. Destination IDs are searched from one-touch dial No. 1 through No. 10 and auto dial No. 01 to 70. Also, search key can be used to find unassigned one-touch and auto dial No. for location programming.

"Manual search"

When the SEARCH key is pressed, the search menu is displayed on the LCD. When the key assigned with the first character of the destination ID is pressed, the searched data is displayed on the LCD display.

"Auto search"

When the SEARCH key is pressed, the search menu is displayed on the LCD. Each time the SEARCH key is pressed, the search in the sequence of A to Z of the alphabet takes place.

Search Key can be used for the first head search of one touch key or Auto dial codes of unregistration at the time of telephone number registration.

4.2.16 ALARM Indicator

Type: LED, red.

Function: Will be turned on when the machine encounters:

- 1) Communication error
- 2) Local alarm condition
 - No print paper
 - Document Jam
 - Paper jam
 - No toner

Printer alarm (Printer I/F abnormal, engine error, fan alarm, and fusing unit error)
cover open

Recording paper jam or printer alarm shall be reset by opening the cover or by power off and on after remedying the cause. It is necessary to press the STOP switch in addition in case of a paper jam.

Fig. 4-4-10 shows the LCD display messages in alarm states.

4.2.17 LCD display

Type: LCD (Liquid Crystal Display) Panel.

Function: Indicates short messages which identify the current status of the machine during message transmission or which guide the operator to the next step during various operation and function programming procedures.

The display is capable of indicating two rows of 20 characters. The basic design concept is such that the top row should show the current or immediately preceding status of the machine, and that the bottom row should indicate the next step to take or the resulting current status - however, it should be noted that there are exceptions in this design principle.

When the machine is in standby, the top row of LCD will display current Time for no document and current Data and Time for document on feeder.

The detail of guidance messages will be introduced in Sections 4.3 "Typical Operations," 4.4 "User Functions," and 4.5 "Service Functions".

4.3 Typical Operations

This section provides information regarding the typical operations of the product, which includes:

Power Turned On (See Fig. 3-8 and section 4.3.1 for the location of the power switch)

Paper loading (See Fig.3-2)

Typical Transmission - (See Fig. 4-1-1 and 4-4-6)

Typical Message Reception - Auto Mode and Manual Mode (See Fig. 4-1-2 and 4-4-5)

Other Transmission Function (See Fig. 4-3-7 to 4-3-11 and 4-3-14 to 4-3-16)

By going through the description of these typical operations, the reader should be able to have a general idea of how the machine operates and also become familiar with the terms used in the subsequent descriptions regarding User Functions and Technical Programming.

4.3.1 Power Turning On

It is assumed that the machine is unpacked and installed on a desk or appropriate stand. All default conditions (the machine configuration parameters) are assumed as those set at the factory, including AUTO RECEIVE MODE which is set to ON.

- a) Connect the socket end of the furnished power cord to the AC Inlet, and the other end to the wall outlet.
- b) Turn Power Switch on.
Refer to Fig.4-4-20.
 - 1) Initial reset is executed within several seconds.
 - 2) AUTO RECEIVE will be displayed on the LCD that the machine is ready for automatic message reception by NO PAPER RECEIVE even before print paper is loaded.
 - 3) Machine goes to Power Save Mode when machine detects power save condition.
Machine shows POWER SAVE MODE PRESS "START" when machine move to power save mode.

Note: POWER SAVE MODE is not available for ODA version.

ALARM (LED) turned on indicates that the machine needs paper loading.

The machine is ready for automatic message reception into memory, - however, due to the memory capacity limited, it is not recommendable to leave the machine with no paper for prolonged time. Load print paper by using the tray as soon as possible.

4.3.2 Paper Loading

Set the recording paper into the paper loader(Tray paper) and press STOP key.

The ALARM indicator will be automatically turned off, and the message on LCD display will change to Current Time, indicating that the machine is now in the normal standby state (Auto Receive Mode set to ON).

Note: Paper size must be set by user key operation because the machine cannot detect the paper size automatically.

4.3.3 Typical Transmission

The step by step operation for typical message transmission in G3 mode will be discussed with reference to the following figures:

Fig. 4-1-1 "Typical Message Transmission"

Fig. 4-4-6 "Calling Operation"

Note 1: For convenience of description, the following assumptions are made for Fig. 4-1-1.

- 1) Five sheets of A4-size document be transmitted to an address, 3454 2111, which is placed in standby in Auto Receive Mode. The Date and Time indication is 14:59 FAX.
- 2) In One-touch Auto Dialing description, the telephone number, 3454 2111, had been assigned to One-Touch key No. 1 in advance.
- 3) In Auto-Dial code Dialing description, the telephone number, 3454 2111, has been assigned to Auto Dial Code 01 in advance.
- 4) The machine is available with a feature called "Auto-Start," which can be enabled or disabled by the user and/or service man.

Note 2: To dial select a distant station, the machine is available using six different methods:

- 1) ON Hook Dialing with Hook key

Pressing Hook key at ON-Hook status.

Machine will establish the connected line and operator can hear the dial tone from the line. Then, operator can make dialling on real time basis by pressing the numeric key on the operator panel.

Note: That it is available only when "Real Time Dial" is set to TYPE 2.

- 2) ON Hook Dialing without Hook key

Pressing numeral key (ON-Hook status)

LCD shows the numbers which are pressed.

Pressing START, then dialling starts entered number which are shown on LCD.

- 3) Manual Dialing by the use of the dialing facility of an external Telephone unit connected to the machine.
- 4) Pressing One-Touch Auto Dial key to which the telephone number is assigned in advance.

This operation corresponds to the leftmost in Fig. 4-1-1.

- 5) Pressing AUTO DIAL key followed by a 2-digits auto dial code to which the telephone number is assigned in advance.

6) Pressing the SEARCH key causes searching of the registered destinations (from among one-touch dial No. to 2-digits auto dial code). There are two following cases in this mode:

- Manual search dial (the fifth flow from the bottom in Fig. 4-4-6)
- Auto search dial (the fourth flow from the bottom in Fig. 4-4-6)

In method 1), the operator uses the local keypad of the machine to dial select the distant station. The machine can monitor the dialed number and store it in memory temporarily. This information allows the operator to use REDIAL for manual redial and/or Auto Redial when the call encounters "line busy" or "no answer."

In method 4), the operator dial selects the distant station and completes connection to the distant facsimile facility through the use of the dialing facility of the external telephone unit. This type of dialing is called "Manual Dialing." No dial information is stored in the machine, and the features such as "Manual Redial" and "Auto Redial" are not available for this type of dialing.

In any of the method 1), 2), 4), 5) and 6), the machine stores the address information in memory. Therefore, the machine can use them for redial purposes. For example, "Manual Redial," and "Automatic Redial," "Broadcast Transmission," etc.

a) Loading Document Pages on ADF (Automatic Document Feeder)

When the machine is in standby, LCD will continuously display the current time information on the top line, indicating the standby state of the machine as:

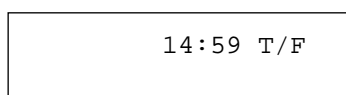

This message corresponds to "1" of Fig. 4-4-6 (Calling Operation)

Open the DOCUMENT GUIDES to the width just enough to accept the document, and load all five document sheets on the ADF facing down and the top edge leading aligned into the slit of the ADF. Preliminary feeding occurs when the documents are set.

On the Control Panel, STD for TRANSMIT RESOLUTION and NORMAL for TYPE OF ORIGINAL should glow amber, indicating the document scanning resolution and contrast compensation for use. If the operator wishes to change the parameters, he/she can do so by tapping the corresponding YES and/or No.

In addition, LCD will display:

```
07/01/1998 14:57 TEL  
SELECT LOCATION
```

which prompts the operator to enter the telephone number of the station to which the document is to be transmitted.

b) Dialing

Manual Dialing (Local Keypad)

In this mode, the operator needs to tap all digits of the telephone number, 54456182, using the keypad on the Control Panel.

The operator hears a dial tone, and taps "5". The message on the LCD will be changed to:

```
5
```

The first digit entered (in the above example "5") will appear at the rightmost character position.

As the operator enters the digits serially, the entered digits will show up on the right of the previous digits, as:

```
54456182
```

When the operator completes dialing, the machine will complete dialing accordingly and the telephone number, 54456182, will remain on the LCD. The exchange will establish the connection with the called station through PSTN (Public Switched Telephone Network). Assuming that the call is answered, the operator will hear CED (Called Station Identification) tone from the distant station, since it is assumed that the distant station is set to the AUTOREC in standby. Hearing the CED, the operator presses the START key.

Pressing the START key causes the machine to switch the line connection to the facsimile facility, and proceeds to transmit the message. The message on the LCD is now changed to:

```
MANUAL TX START
```

The machine proceeds to message transmission which is identified by the "MANUAL SEND MODE" block shown at the rightmost in Figure 4-1-1.

Manual Dialing (External Telephone)

It is assumed that the operator dials the telephone number by using the dialing facility provided on the telephone unit. This operation is indicated by the rightmost in Fig. 4-1-1.

Since the machine is not involved in this dialing operation, the message on the LCD will remain unchanged, that is Time.

When the operator completes dialing, the exchange will establish connection with the called station through PSTN (Public Switched Telephone Network). Assuming the call is answered, the operator will hear CED tone from the distant station and taps START key in a similar fashion as mentioned for Local Keypad Dialing.

Pressing START causes the machine to switch the line connection to the facsimile facility, and proceeds to transmit message. The message on LCD is now changed to:

MANUAL TX START

The machine proceeds to send message which corresponds to the "MANUAL SEND MODE" block, also shown the rightmost in Fig. 4-1-1.

One-Touch Auto Dialing

It is assumed that the telephone number "00116097784184" had been assigned to One-Touch No. 1 in advance. The handset is assumed to be on hook.

The operator taps One-Touch No. 1 on the Operation Panel. This operation is indicated by the leftmost in Fig. 4-1-1.

The machine immediately responds to the operator's action and the LCD will display the entire preprogramed telephone number corresponding to One-Touch No. 1 with a guidance message:

OKI TAKASAKI
YES (START) NO (LOC.)

The message corresponds to " " shown in Fig. 4-4-6, because "AUTO START" is disabled and the call is originated on hook.

Pressing the START key will cause the machine to seize the line and start dialing to the exchange. Fig. 4-4-6 shows AUTO START ON in parentheses, which denotes that there is the case in which the operator does not need to press the START key when "AUTO START" is enabled.

The message corresponds to " " shown in Figure 4-4-6.

```
☐ OKI TAKASAKI
    DIALING
```

The dialed digits is shown into the top message line of the LCD as:

```
0273 56 7890
    DIALING
```

When the machine has completed dialing, the message on the LCD will be changed to:

```
0273 56 7890
    CALLING
```

The machine proceeds to send the message which is identified by the "ONE-TOUCH" block shown in Fig. 4-1-1.

Assuming the call is answered, the operator may hear the CED tone returned from the distant station through the built-in speaker.

Auto-Dial Code Dialing

Assuming the handset on hook, the operator first taps AUTO DIAL key. The machine responds to the command and displays the following message on the LCD:

```
AUTO DIAL NO. ?[ _ ]
    ENTER 01-70
```

As an assumption, the desired telephone number has been assigned to AUTO DIAL 01. Then, the operator taps "01" and the message will be on the LCD:

```
☐ OKI HONJYOU
    YES(START) NO(LOC.)
```

The message corresponds to " " shown in Fig. 4-4-6 because "AUTO START" is disabled and the call is originated on hook. The operator taps the START key.

Pressing the START key will cause the machine to seize the line and start dialing to the exchange. Similar to the case of One-Touch Auto Dialing, Fig. 4-4-6 shows AUTO START ON in parentheses, which denotes that there is the case in which the operator does not need to press START when "AUTO START" is enabled.

```
☐ OKI HONJYOU  
DIALING
```

After checking dial tone or elapse time of waiting, all the digits for dialing will be appeared into the top line of the LCD as:

```
0495 22 2111  
DIALING
```

When the machine has completed dialing, the message on the LCD would change to:

```
0495 22 2111  
CALLING
```

The machine proceeds to send the message which is identified by the "TWO-DIGIT AUTO DIAL CODE" block shown in Fig. 4-1-1 Assuming that the call is answered, the operator may hear the CED tone returned from the distant station through the built-in speaker.

Keypad dialing

Assuming the handset is on hook, the operator can immediately tap the first digit, "0" in this example case. The machine responds to the command and displays the following message on the LCD.

```
0
```

Thereafter, the operator simply continues to entry the remaining digits in the telephone number.

```
00116097784184
```

The message is shown in Fig. 4-4-6. Upon completion of the entry of the telephone number, the operator taps the START key.

```
001160977484184  
DIALING
```

When the machine has completed dialing, the message on the LCD would change to:

001160977484184 CALLING

The machine proceeds to send the message which is identified by the "KEYPAD DIAL" block shown in Fig. 4-1-1.

Destination ID search dialing

Any registered destination ID can be searched and direct dialing to the destination, having the searched ID, is possible. Searching by entering the all characters of the destination ID is possible, and searching through all destination IDs is also possible.

(Operation)

The operation explained below as an example is for the search of the destination ID, "OKI-TOKYO".

(1) Manual search dialing mode

Press the SEARCH key. As the first character is O, press 6 on the key pad. Since M, N and O are assigned to the 6 key, the LCD displays a destination ID beginning with M and its dial number as follows:

<input type="checkbox"/> MINNESOTA OFFICE 987654321

As the 6 key is pressed repeatedly, the LCD will display.

<input type="checkbox"/> OKI-TOKYO 814542111

Pressing the START key in this state causes direct dialing to that destination.

(2) Auto search dialing mode

Press the SEARCH key twice. As the SEARCH key is pressed repeatedly from this state, the LCD will display the destination ID's in the lexicographical order one at a time, each time the SEARCH key is pressed as follows:

Ex.

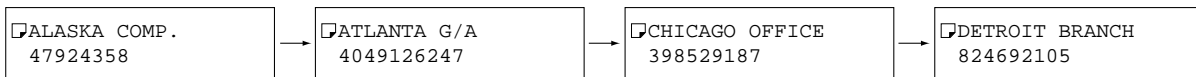

When OKI-TOKYO DIALING is displayed, press the START key.

These search modes are for all destination IDs register for the ONE TOUCH and AUTO DIAL codes.

c) Document reading timing

		Memory available	Memory full
Multi-destination (Broadcast)		Call origination after all the documents are read in the memory.	Reading impossible
Destination	FUNC. PROGRAMMING 25: INSTANT DIAL = ON	Starting the document reading upon call origination	Feeder transmission: Starting the document reading when receiving the CFR signal of the remote machines after call origination
	FUNC. PROGRAMMING 25: INSTANT DIAL = OFF	FUNC. PROGRAMMING 17: MEM./FEEDER SW = MEM.	Call origination after all the documents are read in the memory.
		FUNC. PROGRAMMING 17: MEM./FEEDER SW = FEEDER	Feeder transmission: Starting the document reading when receiving the CFR signal of the remote machines after call origination
			Feeder transmission: Starting the document reading when receiving the CFR signal of the remote machines after call origination

d) Reception of NSF (Personal ID)/CSI

If the machine receives NSF (Non-Standard Facilities) with Personal ID from the distant station, the message on the LCD will be:

OKI-TOKYO
SENDING /144

OKI-TOKYO is received as Personal ID from the distant station.

When the machine receives the CSI (Called Subscriber Identification) without NSF, the message on the LCD will be:

03 3454 2111
SENDING /144

The top line identifies the called subscriber obtained from the CSI and the bottom line indicates that the document is sent at 14400 bps.

If the machine receives no CSI and no NSF from the distant station, the message on LCD display will be:

OKI-TOKYO
SENDING /144

OKI-TOKYO is calling ID which is registered in One touch key.

SENDING /144

Calling ID does not registered in One touch key.

e) Transmission Starts

After setting the document pages and storing the image data in the memory, the machine begins the handshaking with the distant station. If the 14400 bps training is successfully completed, then the machine will start transmitting the image data in digitally coded form. If the training fails due to the line condition, an automatic fallback to a lower rate will occur. The result will be indicated on MCF REPORT.

f) Transmission Ends

When all of the document pages are transmitted successfully, the machine will automatically display the following message:

RESULT=OK

In either case mentioned above, the message on the LCD will return to time in about 5 seconds, indicating that the machine is again in standby state.

4.3.4 Other Transmission Function (Fig. 4-3-1)

This machine is provided with other transmission functions listed below.

- Delayed TX (Fig. 4-3-7)
- Confidential TX Programming (Fig. 4-3-9)
- Relayed Broadcast initiate (Fig. 4-3-10)
- Polling TX/RX Programming (Fig. 4-3-11)
- TX preparation (Fig. 4-4-16)

If a TX preparation request is made when memory full during reception or data transmission from memory, the machine sends the documents on the feeder at the completion of the current send or receive operation. In the operation of TX preparation the document is pre-feed.

This feature is available for the confidential message TX, relayed broadcast initiate, and memory transmission.

4.3.5 Typical Message Reception (Auto Receive and Manual Receive Modes)

The product is shipped with its receive mode set to Auto Rec Mode. Therefore, when the power is turned on, the LCD indicates that the machine is in the auto-receive standby state.

The operator can change the status by pressing the AUTOREC key.

The selection of "AUTO REC", "MANUAL REC", "TEL/FAX AUTO SWITCHING", "TAD MODE", MEMORY RX MODE and PC MODE (in case of installed the optional software to PC) appear in turns as the AUTO REC key is pressed. (Refer to Fig. 4-4-3)

Fig. 4-1-2 shows a flow chart illustrating the events which occur when the machine receives a message from a distant station in both AUTO and MANUAL Modes. Since the operations shown are all conventional, the explanation is abbreviated.

No Paper Reception

When prior to or during a reception the recording paper runs out, it is possible to receive the incoming message in the memory, the built-in memory is capable of accumulating the received data.

Refer to Fig. 4-4-13. The accumulated data is printed out when you push the STOP key after the new paper is loaded.

Even if the no-paper state (including door open) occurs during ECM reception, the no-paper reception operation in the ECM mode continues.

No-paper reception ends when the empty area in the memory is filled up then, the displays of "MEMORY OVERFLOW" appears. The data received in the memory, however, remains unerased and received data in memory is printed out when you push the STOP key after the new recording paper is set.

4.3.6 Multiple Function Combination Table for Communication

Some functions may conflict with some others depending on situation.

Refer to Tables 4-1 to 4-5, which cover combinations of the following features in the form of matrix table: memory TX, delayed TX, confidential message TX/RX, relayed broadcast initiated, ECM transmission or reception, page retransmission, polling transmission or reception, no toner reception, and no paper reception.

4.4 User Functions

The operations of typical transmission (manual transmission and auto dial transmission include one-touch dial, auto dial and keypad dial), typical reception (manual reception and auto reception), and other transmission function (memory transmission, delayed transmis-

sion, confidential transmission, relayed initiate transmission, feeder polling transmission, and transmission preparation) are described in Section 4.3.

Refer to Fig. 4-1 (1/2 - 2/2 General Key Operation).

4.4.1 Method for Selection Function

Press the FUNCTION key once to enter the mode for selecting the user functions. Pressing the FUNCTION key again, after setting either mode, cancels the operation. In the setting mode, the operator can turn the menu level back to the previous selection by pressing the STOP key.

a) Selection method

Detailed branching for communication operation or file management shall all be done according to the guide message on the LCD. The keys (for input) allowed to be selected by the user shall exist on the panel or LCD screen. The selection method is roughly classified into the two types as follows:

1) YES/NO selection

YES and NO are assigned to arrow keys ← and →. To affirm the data on the LCD, press the YES (←) key. Each time the NO (→) key is pressed, new alternative data for selection is displayed on the LCD. This method is always available for the user, except for the serviceman data.

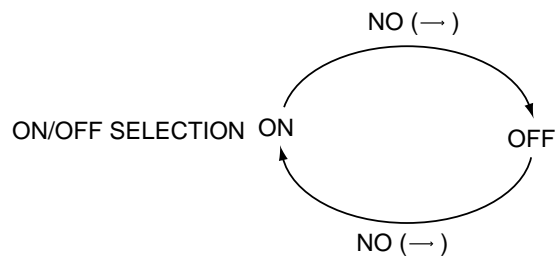

2) Multiple number designation

When there are multiple branches, it is possible to select the number (selecting value) arbitrarily given by the system by pressing the arrow key at the right (NO) and set it by pressing the arrow key at the left (YES).

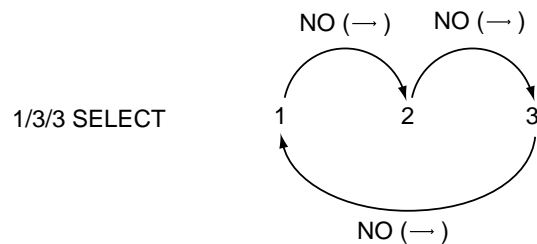

b) Data registration

Data to be registered is classified into numeric data (ex. password, telephone number, etc.) and character data (ex. calling party ID, personal ID, destination ID, etc.).

Numeric data is input by using numeric (ten) keys and, if allowed, hyphen key, pause key (one touch No. 10) and space key (one-touch No. 9) and plus key (one-touch No. 8). When registering the TSI/CSI/CIG, hyphen key can not used. When registering the telephone number, plus key can not used.

For character data input, ten keys and hyphen key are used. One-touch keys No. 9 and No. 10 are for inputting a space and 'P', respectively. Ten key 0 is assigned for special character input. When it is pressed twice or more in session, symbols (ex. '!', '"', '&', etc.) and international characters ('Ä', 'Æ', 'à', etc.) can be input. Press the "→" key to determine the special character. The space key is used for erasing the data in all cases. To register the input numeric or character data in the equipment, press the start key. The "←" and "→" keys are used for cursor movement.

Fig. 4-1 shows the general procedure of key operation.

4.4.2 Print from Message in Memory

Function: To print out the received messages from memory in "MSG.IN MEMORY" mode, or when the machine has run out of recording paper (including the door open and the no toner state). When received messages are in the memory, "MSG.IN MEMORY" is indicated on the LCD.
When printing in the Memory Only Reception, an operator has to print the received message by the Memory message printing operation. (Refer to Fig. 4-3-8.)

Operation: The operation is shown in Fig. 4-4-13 and 4-4-14.

4.4.3 Print from Confidential Reception Message (Personal Box Print)

Function: To print out the confidential received messages in the memory with 1-digit personal box number.
The maximum number of personal boxes is 8. Personal boxes are numbered 1 to 8. When confidential received messages are in the memory, MESSAGE IN MEMORY." is indicated on the LCD.

Operation: The operation is shown in Fig. 4-3-8.

4.4.4 Operation of Polling Reception

Function: This feature is effective only when the distant station is ready for polling transmission.

Operation: The operation of Polling Reception and Cancellation of Multiple Poll are shown in Fig. 4-3-11 and 4-4-6.

4.4.5 Selection of Reports and Lists

The Report Print allows selecting 6 items shown below.

1. Activity report
2. Broadcast message confirmation report
3. Memory files report
4. Phone directory
5. Configuration list without service default
(* Configuration list with service default report)
6. Protocol dump list
- *7. Log Report

Refer to Fig. 4-3-1 and 4-3-12.

*: Effective if service bit is ON.

4.4.5.1 Activity Report

Function: The function allows the operator to print out the status report manually. A brief description of "Activity Report" will be given in Section 4.6 Reports and Lists.

Operation: The operation is shown in Fig. 4-3-1 and 4-3-12.

4.4.5.2 Broadcast Message Confirmation Report

Function: The function allows the operator to print out the message confirmation report manually or automatically. A brief description of "Broadcast MCF" will be given in Section 4.6 Reports and Lists.

Operation: The operation is shown in Fig. 4-3-1 and 4-3-12.

4.4.5.3 Memory Files Report

Function: The function allows the operator to print out the Memory Files report manually.

Operation: The operation is shown in Fig. 4-5-4.

4.4.5.4 Phone Directory

Function: The function allows the operator to print out the Phone Directory report manually. A brief description of "Phone Directory Report" will be given in Section 4.6 Reports and Lists.

Operation: The operation is shown in Fig. 4-3-1 and 4-3-12.

4.4.5.5 Configuration Report

Function: The function allows the operator to print out the configuration report manually. A brief description of "Configuration Report" will be given in Section 4.6 Reports and Lists.

Operation: The operation is shown in Fig. 4-3-1 and 4-3-12.

4.4.5.6 Service Default Report (Configuration Report Service-Bit=ON)

Function: The function allows the operator to print out the service default report manually for maintenance purpose. A brief description of "Service Default Report" will be given in Section 4.6 Reports and Lists.

Operation: The operation is shown in Fig. 4-3-1 and 4-3-12.

4.4.5.7 Protocol Dump List

Function: The function allows the operator to print out the protocol dump list manually. A brief description of "Protocol Dump List" will be given in section 4.6 Reports and Lists.

Operation: The operation is shown in Fig. 4-3-1 and 4-3-12.

4.4.5.8 Log Report

Function: The function allows the operator to print out the log report manually when Service-Bit=ON. This information is used by Okidata.

Operation: The operation is shown in Fig. 4-3-1 and 4-3-12.

4.4.6 Selection of Counter Display

4.4.6.1 Drum Counter Display

Function: When I/D unit reaches run-out time, "CHANGE DRUM SOON" is appeared in LCD. Under above condition, user can see the Drum message and clear. However, No. of counter is not shown for user (Service-Bit=OFF)
After user changed the Drum and clear operation, "CHANGE DRUM SOON" in LCD is disappeared.
However, the drum counter clear is possible even if the drum is not at the end of its lifespan.

Operation: The operation is shown in Fig. 4-3-1 and 4-3-13.

4.4.6.2 Toner Counter

Function: This counter is provided to serviceman to check the number of toner counter. When Technical Function No.32 (Toner counter clear)=OFF, this counter message is skipped.
When Technical Function No.32 (Toner counter clear)=ON, this counter is cleared by operation.
User can clear the Toner counter.

Operation: The operation is shown in Fig. 4-3-1 and 4-3-13.

4.4.6.3 Drum (T) Counter Display

Function: This counter is provided to serviceman to know the total number of DRUM counter for the machine.
When service-Bit=OFF, this counter message is skipped.
When service-Bit=ON, this counter is cleared by operation.

Operation: The operation is shown in Fig. 4-3-1 and 4-3-13.

4.4.6.4 Print Counter Display

Function: This counter is provided to user.
Display shows how many times recording paper has been printed. But user cannot clear this number.

Operation: The operation is shown in Fig. 4-3-1 and 4-3-13.

4.4.6.5 Scan Counter Display

Function: This counter is provided to user.
Display shows how many times document has been passed the ADF. But user cannot clear this number.

Operation: The operation is shown in Fig. 4-3-1 and 4-3-13.

4.4.7 User Program Menu

This sub section presents default positions and telephone numbers and data programmed by user.

The kinds of user program are:

- 1) One-touch key programming (Fig. 4-3-14)
- 2) Auto dial programming (Fig. 4-3-15)
Destination ID programming

- | | | |
|----|---------------------------|-----------------------|
| 3) | Group dial programming | (Fig. 4-3-16) |
| 4) | User function programming | (Fig. 4-3-17) |
| 5) | Data programming | (Fig. 4-3-19, 20, 21) |
| 6) | Personal BOX programming | (Fig. 4-3-22) |
| 7) | MEM. password programming | (Fig. 4-3-23) |
| 8) | Restrict ID programming | (Fig. 4-3-24) |

Operation: The operation is shown in Fig. 4-3-1 and 4-3-14.

Note: The machine stops its operation for few seconds (1-2 sec.) during just programming any data into memory. It is a restriction due to the use of electrical erasable/rewritable memory, because it is needed the specified time to re-write data after erasing. You will notice this programming sequence through the LCD message because LCD shows "PROGRAMMING".

4.4.7.1 One-touch key programming

Function: Ten one-touch keys permit registering

- a. telephone number (numeral, -, P and space) in 32 digits
- b. alternate fax telephone number in 32 digits (additional registration)
- c. ID for the telephone directory function in 15 characters (alphabets, numeral and symbols). (One ID can be registered for one key).

Operation: The programming operations are described in Fig. 4-3-1 and 4-3-14.

4.4.7.2 Auto Dial Programming

Function: Auto dial No. 01 to 70 allow registering telephone number in 32 digits (numeral, - P and space) and ID for the telephone directory function in 15 characters (alphabets, numeral and symbols).

Each auto dial location No. 70 is linked to the Relay Report returning fax number.

Operation: The programming operations are described in Fig. 4-3-1 and 4-3-15.

4.4.7.3 Group Programming

Function: Grouping some one-touch keys and some two-digit auto dial codes to which telephone numbers have been assigned. Five group programming are available.

The group programming makes multiple polling reception and broadcast operation simple.

Operation: The programming operation is described in Fig. 4-3-1 and 4-3-16.

4.4.7.4 Function Programming

Default table is shown in Table 4-6.

Operation: The operation is shown in Fig. 4-3-1, 4-3-17 and 4-3-18.

01: Default arrangement for message confirmation report (Single location) (ON/OFF)

Function: To enable or disable the automatic message confirmation printout after a single location call.

Operation: The operation for setting of default position is described in Figure 4-3-17 and 4-3-18.

02: Default arrangement for message confirmation report (Multiple location) (ON/OFF)

Function: To enable or disable the automatic printout of the multiple polling reception and the broadcast.

Operation: The operation for setting of default position is described in Figures 4-3-17 and 4-3-18.

03: Default arrangement for error report MCF (ON/OFF)

Function: To enable or disable the automatic printout of the error report when error in communication is detected.

Operation: The operation for setting of default position is described in Fig. 4-3-17 and 4-3-18.

04: Default arrangement for image in MCF (ON/OFF)

Function: To enable or disable the image in MCF.

Operation: The operation for setting of default position is described in Figure 4-3-17 and 4-3-18. Refer to 4.9.7 Image in MCF.

05: Default arrangement for sender ID (ON/OFF)

Function: To enable or disable the sender ID.

Operation: The operation for setting of default position is described in Figure 4-3-17 and 4-3-18.

06: Monitor volume selection (H/L/OFF)

Function: To enable H or L or disable the line monitory sound.
In case setting H/L, monitor is enable for 5 seconds after dialing.

Operation: The operation for setting of default position is described in Fig. 4-3-17 and 4-3-18.

07: Buzzer volume selection (LOW/MID/HIGH)

Function: Selects the sound volume of each of the key touch tone, end of communication buzzer, voice request buzzer and off-hook alarm from the low, medium and high levels.

Operation: The operation for setting of default position is described in Fig. 4-3-17 and 4-3-18.

08: Default arrangement for closed network (OFF/ T/R /RX)

Function: To disable or enable (OFF) the access to the FX-048/050VP175VP from stations which are not registered in one-touch key or two digit auto dial code.

Operation: The operation for setting of the default position is described in Fig. 4-3-17 and 4-3-18.

09: Default arrangement for TX mode

Function: To select the mode automatically set up when a document is loaded in the feeder.
The following combinations are selectable.

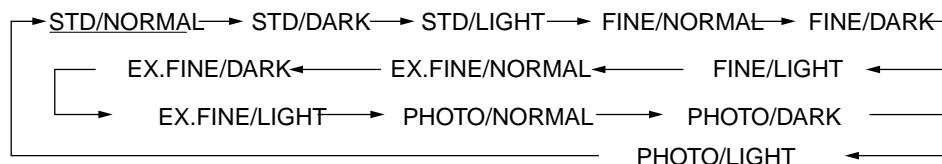

Operation: The operation for setting of default position is described in Fig. 4-3-17 and 4-3-18.

10: Default arrangement for TEL/FAX switchover timer (20 sec/35 sec)

Function: To specify the time for which the machine alerts you on reception of a call in the telephone/fax automatic switchover mode.

Operation: The operation for setting of default position is described in Fig. 4-3-17 and 4-3-18.

11: Ringing response time selection (1 RING/05/10/15/20 SEC)

This selection cannot be changed unless the service bit is set to one in some countries.

Operation: The operation for setting of the default position is described in Fig. 4-3-17 and 4-3-18.

12: Distinctive Ring (OFF/ON/SET)

Function: To select the ring pattern for FAX to apply distinctive ringing .

Operation: The operation for setting of default position is described in Fig. 4-3-17 and 4-3-18. Refer to 4.9.8 Distinctive Ring.

13: 1ST Paper Size Selection (A4/LETTER/LLEGAL)

Function: Select the first cassette size.
The operator must select the preferable paper size as the machine cannot detect the paper size automatically.

Operation: The operation for setting of size is described in fig. 4-3-17 and 4-3-18.

14: User Language (ENGLI/ANOTHER)

A choice of two languages for LCD and print messages are available.
GER, FRE etc. are displayed instead of ANOTHER.

15: Incoming Ring (ON/OFF/DRC)

Function: To enable or disable the bell signal which is generated by software.

Operation: Refer to Fig. 4-3-17 and 4-3-18.

16: Remote Receive (OFF/00/11/22/33/44/55/66/77/88/99/**/##)

Function: When operator hooks up the optional or external handset for FAX reception, operator can switch the line from telephone to FAX by using two-digit MF tone if the remote receive setting is not OFF.
Two-digit code (00 or 11 or 99 or ** or ##) by keypad is used to switch the line.
This function is applied to FX-051.

Operation: Refer to Fig. 4-3-17 and 4-3-18.

17: Memory TX/Feeder TX switch

Function: To select the transmission mode (MEM. TX/FEED. TX) of default.
This function becomes effective when Instant Dial of No. 26 is set to OFF.
(Refer to P.4-20 Document reading timing)

Operation: Refer to Fig. 4-3-18.

18: Default arrangement for power save mode (ON/OFF)

Function: To enable or disable the power save.

Operation: The operation for setting of default position is described in Figure 4-3-17,
Fig. 4-3-18 and Table 4-6.

Note: No setting for ODA version

19: Default arrangement for ECM function (ON/OFF)

Function: To enable or disable the ECM function.

Operation: The operation for setting of default position is described in Figure 4-3-17,
Fig.4-3-18 and Table 4-6.

20: Default arrangement for remote diagnosis (ON/OFF)

Function: To enable or disable the access to this machine from the remote center
for diagnosis.

Operation: The operation for setting of default position is described in Fig. 4-3-17 and
Fig. 4-3-18.

21: Default arrangement for PC/FAX switch (ON/OFF)

Function: To enable or disable PC interface function.
When PC reception is not available, for example, application is not
activated on the PC or cable is missing between PC and fax etc., this
setting allows to switch from PC to fax reception automatically.

ON: Automatically change to fax reception

OFF: No reception

Operation: The operation for setting of default position is described in Fig. 4-3-17 and
Fig. 4-3-18.

22: No toner MEM RX

Changing from service function setting to user function setting.

Function: To enable or disable MEM RX when toner low condition.
ON: To receive the message in the memory when the remaining toner level is low or none.
OFF: To print the message even the remaining toner level is low or none.

23: MEM full save

Function: Broadcast transmission and other features originate calls after all the documents read in the memory. When Memory Full occurs during reading documents and operator time out occur, all the readout data must be deleted (OFF setting) or all the data must be sent. (ON setting)
Select either ON or OFF setting as follows:
ON: Selecting display
OFF: Selecting delete at all times

Operation: To operation for setting of default position is OFF in Fig. 4-3-18.

24: Continuous tone

Function: Setting of sounding warning tone after reception.
ON: Warning tone sounding stops by operator's STOP key pressing
OFF: No warning tone

Operation: To operation for setting of default position is OFF in Fig. 4-3-18.

25: Instant dialing

Function: Setting to start reading documents upon call origination when transmitting. Refer to attached table "Document Reading Timing". (Page 4-20)

Operation: The operation for setting of default position is enable in Fig. 4-3-18.

26: Restrict Access

Function: To enable or disable restrict access function.
Restrict ID registration (Fig. 4-3-24) becomes effective when Restrict Access is set to ON.

Operation: The operation for setting of default position is disable in Fig. 4-3-18.

27: Width Reduction

Function: Performs the reduction of the horizontal scanning. (However, only when printing of Copy/reception message.)
See section 4.7.2.1 Variable (reduction) printing.

Operation: The operation for setting of default position is desable in Fig. 4-3-18.

28: One-touch keys parameter

Function: To assign the following features combined together as echo protection to each one-touch key.

Protective tone
Ignoring the 1ST DIS.

Operation: The operation for setting of default position is described in Fig. 4-3-1 and 4-3-17 and 4-3-18.

4.4.7.5 Data programming

Function: The kinds of data programming are:
1) Clock adjustment
2) System data programming
3) Dial parameter programming

Operation: The operation is shown in Fig. 4-3-1 and 4-3-17.

1. Clock adjustment

Operation: the programming operation is described in Fig. 4-3-1 and 4-3-20.

2. System data programming

Function: The kinds of system data programming are:

- a) Registration of TSI/CSI/CIG
TSI (Transmitting Subscriber Identification)
CSI (Called Subscriber Identification)
CIG (Calling Subscriber Identification)
- b) Registration of sender ID
- c) Registration of telephone number for the call-back message

3. Dial parameter programming

Parenthesis means setting variation. Default table is shown in Table 4-8.

Operation: The programming operation is described in Fig. 4-3-19 (1/4 - 4/4).

Note: Some items from (a) to (n) are available according to PTT's restriction.

- a) Redial time (0 to 10 times: one time steps)
- b) Redial interval (1 to 6 minutes: one minute steps)
- c) Dial tone detection (ON/OFF)
- d) Busy tone detection (ON/OFF)
- e) MF or DP (MF/DP)
- f) DP rate (10/16/20 pps)
- g) DP make ratio (33%/39%)
- h) DP dial type (N/10-N/N+1)
- i) MF duration (75/85/100 ms)
- j) PBX Line (ON/OFF)
- k) Flash/Earth/Normal (R/E/N)
- l) Auto start (ON/OFF)
- m) Dial prefix (0. 1. ... 9)
- n) IT2 detect (ON/OFF)

AUTO START: If the AUTO START is turned ON, dial operation is automatically started immediately.
 If the AUTO START is turned OFF, dial operation is started when the START key is pressed. If the START key is not pressed within 60 sec., the machine is initialized.

4.4.7.6 Personal box programming

To allow operator to assign a two functions to 8 personal-box.

- (a) Confidential RX
- (b) Bulletin Polling TX

Function: Used with confidential RX and Bulletin Polling TX and Advanced T30 protocol. Personal box setting for Bulletin poll using SEP frame and Confidential using SUB frame when remote machine have a SEP/SUB capability.

Operation: The programming operations are described in Fig. 4-3-1 and Fig. 4-3-22. The box No. 0 is used for only global Bulletin Polling TX.

4.4.7.7 Memory password programming

Function: Registering the password required (4-digit numerals) for outputting the data received by Memory Only Reception mode or change from Memory Only Reception mode.
 When the four-digit numeric password is registered, the password input is required upon outputting documents or change from Memory Only Reception mode.

Operation: The programming operations are described in Fig. 4-3-1 and Fig. 4-3-23.

4.4.7.8 Restrict ID programming

Function: Restrict ID is a function available only person who knows Password, and this function can register 24 types of ID when Restrict Access of user's setting No. 26 is set to ON.

Operation: The programming operations are described in Fig. 4-3-1 and Fig. 4-3-24.

4.4.7.9 Printer Counter Clear Selection

The Printer Counter Clear allows selecting 5 items shown below.

- 1) Drum counter clear
- 2) Toner counter clear **.
- 3) Drum (T) counter **.
Drum (T) will be used to know the total in-use life of the machine.
- 4) Print counter clear *.
- 5) Scan counter clear *.

Note: When service bit is OFF ** marked functions are not displayed. And * marked functions are not cleared by operator.

For the flow of key operation, refer to Fig. 4-3-1 and 4-3-13.

1. Drum counter clear
Operation: The operation is shown in Fig. 4-3-13.
2. Toner counter clear
Operation: The operation is shown in Fig. 4-3-13.
3. Drum (T) counter clear
Operation: The operation is shown in Fig. 4-3-13.
4. Print counter clear
Operation: The operation is shown in Fig. 4-3-13.
5. Scan counter clear
Operation: The operation is shown in Fig. 4-3-13.

4.4.8 Printer Cleaning

Function: To cleaning the residual toner on the charge roller.

Operation: The cleaning operation is described in Fig. 4-3-24 and 4-3-27.

4.5 Technical Programming (Service Functions)

Technical programming available with this product are classified into five categories, according to the nature and method of service functions:

- Local test
- Technical function
- System reset
- Default type set
- PC-Loading

For the flow of technical program of key operation, refer to Fig. 4-3-1 and 4-3-2.

4.5.1 Local test

Function : Local test will be described about the following items.

Operation : The operation Fig. 4-3-3.

1. Self-diagnosis
 - Flash memory check
 - RAM check
 - RAM board check (optional)
 - Print test
2. Sensor calibration
 - Adjustment of scanning level
3. LED test
 - All LEDs will be sequentially turned on for one second each in turn.

```
graph LR; ALARM --> DARK; DARK --> NORMAL; NORMAL --> LIGHT; LIGHT --> STD; STD --> FINE; FINE --> EX-FINE; EX-FINE --> PHOTO; PHOTO --> all_LED_ON[all LED ON]; all_LED_ON --> all_LED_OFF[all LED OFF]; all_LED_OFF --> ALARM;
```
4. Tone send test
5. Modem send test
6. Modem receive test
7. Multifrequency (MF) send test
 - Dual tone multifrequency tone test will be conducted by pressing designate Key-pad.
8. Tone send test for TEL/FAX.

4.5.2 Technical functions

Parentheses means setting variation. Default table is shown in Table 4-7.

Operation : The operation is shown in Fig. 4-3-4.

01. Service Bit (ON/OFF)

Switching serviceman/user operation where there is a difference between U.S. and FTZ version, as in TSI/CSI registration for example.

ON : Serviceman's features are available.

OFF : Serviceman's features are not available.

02. Monitor Control (ON/OFF)

Enable/Disable of Monitor.

03. Country Code (USA, INT, GBR, IRL, NOR, SWE, FIN, DEN, GER, HUN, TCH, POL, SUI, AUT, BEL, HOL, FRE, ESP, ITA, GRE, AUS, NZL, SIN, HNG, POR)

Selection of country.

04. Time/Date Print (OFF/ONCE/ALL)

When select to

OFF : Time and Date are not printed.

Once: Time and Date are printed at the top of the first page only.

All : Time and Date are printed at the top of every page.

05. TSI Print (ON/OFF)

To enable or disable TSI print.

When TSI print is on, the telephone number of the fax machine sending you a fax message is printed at the top of the each page of the message.

06. TAD Mode (OFF/TYPE1/TYPE2/TYPE3)

Switching of valid or invalid for TAD mode function.

TYPE1 : Machine responds as fax even if CNG was not detected.

TYPE2 : Machine responds as fax only when CNG is detected.

TYPE3 : Machine responds as fax after a certain time (15 sec.) elapses. (CNG is not detected.)

07. Real Time Dial (OFF/TYPE1/TYPE2)

Selection of real time dialing and the ability to enable or disable this feature.

TYPE1 : Real time dialing is available when the optional hand set is OFF-HOOK.

TYPE2 : Real time dialing is available when the optional hand set is OFF-HOOK or press HOOK key.

08. TEL/FAX Switch (ON/OFF)
Switching the TEL/FAX automatic switch function
09. MDY/DMY (MDY/DMY for US/CANADA version. MDY/DMY for INT'L version)
Refer to Table 4-7.
Switching LCD display and report print from month/day/year to day/month/year.
10. Long Document Scan (ON/OFF)
Switching the function of scanning long-size documents (more than 360 mm).

ON : 1500 mm or 60 min.
OFF : 360 mm or 60 min.
11. Tone for Echo (ON/OFF)
Switching this function applicable to poor circuit quality of overseas transmission, etc.
Note: Both ignoring 1st DIS (No. 14) and protective tone (No. 16) are switched at the same time in setting of one-touch key parameter.
12. MH only (ON/OFF)
Switching the function of limiting image compression to the MH code.
13. H/MODEM RATE (14.4 k/9.6 k/4.8 k)
Selection of H/MODEM RATE for TX/RX
14. T1 (TX) Timer Value (010 - 255)
Registers the time duration (in seconds) for which FX-051 waits for the remote station's answer. This timer starts when the last dial digit has been sent in the automatic transmission mode.
15. T1 (RX) Timer Value (010 - 255)
Registers the time duration (in seconds) for which FX-051 waits for the remote station's answer. This timer starts when the automatic reception is started.
16. T2 Timer Value (001 - 255)
Registers the time duration (in seconds) for which FX-051 watch for the EOL interval. This timer starts when the last EOL has been received.
(in 100 ms steps)
17. DIS BIT 32 (ON/OFF)
To enable or disable the DIS BIT 32. Refer to 4.8.14.

18. Error Criterion (00-99)
To select the error criterion ratio. Refer to 4.8.13.
19. Off-Hook Bypass (ON/OFF)
Switching the function of maintaining communication without hooking up the telephone set in usual test, etc.
20. Non-Loaded (NL) Equalizer (0, 1.8, 3.6, 7.2km)
Determining the equalizing level of the receiving signal.
0, 1.8, 3.6 and 7.2km are selectable.

Definition: Equalizing level is the difference of gain of equalized signal between 0.3 kHz and 3.4 kHz.
21. Attenuator (0 to 15 dB)
Adjusting the attenuation (dB) for the send signal power level.
22. T/F Tone Attenuator (0 to 15 dB)
Adjusting the attenuation (dB) for the tone send signal for TEL/FAX switching.
23. MF Tone Attenuator (0 to 15 dB)
Adjusting the attenuation (dB) for the MF tone send signal power level.
24. Ring Duration Detection Time (100 MS - 990 MS)
Selection of minimum ring detection time according to each country's requirement.
The time is selectable between 100 MS and 990 MS by 10 MS step.
25. CML Timing (100 MS - 1900 MS)
Selection of the time from end of the ring to CML-ON.
The time is selectable between 100 MS and 1900 MS in 100 MS step.
26. LED Head Strobe (00000 - 11111)
Selection of strobe width in LED head.
"00000" is lightest and "11111" is darkest.
27. LED Head Width
To switch the type of LED head whose width is TYPE1 (2496 bit) or TYPE2 (2560 bit).
28. MEDIA TYPE (M/MH/H)
The recording paper quality is selectable among Medium, Medium-heavy and Heavy.
29. TR Latch Current (-2/-1/0/+1/+2)
To select the latch current for transfer roller.

- 30. NSF Switch (ON/OFF)
NSF signal transmitting selectable.
- 31. ID/TSI Priority (ID/TSI)
Selects ID/TSI printing in the distant station ID column of the report.
- 32. Toner Counter Clear (ON/OFF)
Selects whether this function of toner counter clear operating is permitted for user or not.
- 33. Parallel Pickup (ON/OFF)
Selects the effective/invalid of the parallel pickup function.

4.5.3 PTT Parameter

Default table is shown in Table 4-8. Note : this table is typical value.

Operation: The programming operation is described in Fig. 4-3-1, 4-3-2 and 4-3-6.

a) PTT parameter (Country code)



4.5.4 System reset

Function : To clear or initialize the following data:

1. All data
2. Location data
3. Configuration data

Operation : The operation is shown in Fig. 4-3-1, 4-3-2, 4-3-5.

4.5.5 Default type set

This function is destination countries setting. When changing this setting, all data is initialized except the counter value.

4.5.6 PC-Loading

This function is possible to rewrite the Flash memory.

4.6 Reports and Lists

This Section presents the formats of reports and lists referred in the preceding paragraphs, with some example entries for reference purposes.

The formats are attached to the last of Section 4 for reference purposes (Fig. 4-5-1 to 4-5-13 for US/CANADA/INT'L version.)

Brief descriptions for the items and sample data are given for the reader's convenience in understanding the meaning and purpose thereof, except for those which are seemed self explanatory.

The method to print out the reports and lists are in the flow charts Fig. 4-3-1 and Fig. 4-3-12.

4.6.1 Message confirmation report

Format : See Fig. 4-5-1 and 4-5-2.

Fig. 4-5-2 is only printed out by automatic report print mode after completion of memory TX.

Purpose : To check the result of transmission just conducted or previous done.

Method : The report will be manually or automatically printed out.

- Descriptions :
1. Title of the report
 2. Date and time when the report was printed
 3. Sender ID
 4. Total transmission and reception time
 5. Date of transmission or reception
 6. Time when the communication started
(Time is not printed by automatic print out mode.)
 7. Length of time for which the FX-051 was connected to the line
 8. Identification of the remote station
Personal ID/CSI/Location ID/Dial number
 9. Mode of the communication
Calling/Called/B.C. (Broadcast)/BOX
 10. Total number of pages in particular communication
 11. Result of the communication
OK/NO/STOP/COMP./BUSY/PAPER/S JAM/R JAM/COVER
 12. Service code

13. Number of pages stored in memory
Page number is printed only in case transmission from memory is carried out.
14. Page numbers of the pages to which an RTN signal or a PIN signal received.
The asterisk (*) mark indicates that retransmission of the page met the criteria of copy quality.

4.6.2 Activity report

Format : See Fig. 4-5-3.

Purpose : To provide the user with a comprehensive communication record listing for his administrative or management purposes.
When paper RX is completed normally, result of the communication is not printed in the report. But in memory RX, result of the communication is always printed in the report.

Method : The report will be manually printed out.

- Descriptions :
1. Title of the report
 2. Date and time when the report was printed
 3. Sender ID
 4. Total TX and total RX time
 5. Date of transmission or reception
 6. Time when the communication started
 7. Length of time for which the FX-051 was connected to the line
 8. Identification of the remote station
Personal ID/TSI/Location ID/Dial number
 9. Mode of the communication
Calling/Called/B.C. (Broadcast)
BOX = $\Delta \Delta$ (Mail box number)
 10. Total number of pages in particular communication
 11. Result of the communication
OK/NO/STOP/BUSY/PAPER/COMP. (Completion of a broadcast)/S
JAM / R JAM / COVER / PUNIT / CANCL
 12. Service code

4.6.3 Broadcast confirmation report

Format : See Fig. 4-5-10.

Method : The report will be manually or automatically printed out.

- Descriptions :
1. Title of the report
 2. Date and time when the report was printed
 3. Sender ID
 4. Total numbers of pages in particular communication
 5. Specified transmission time
(Time is not printed by automatic print out mode.)
 6. Total transmission time
 7. Required transmission address (One-touch dial)
 8. Registered location ID (One-touch dial)
 9. Required transmission address (Auto dial)
 10. Registered location ID (Auto dial)
 11. Required transmission address (Ten key dial)
 12. Transmitted number or pages for each address
 13. Identification of the result of communication

4.6.4 MEMORY Files report

Format : See Fig. 4-5-4.

Method : The report will be manually or automatically printed out, for information of transmission/reception data stored in the memory.

- Descriptions :
1. Title of the report
 2. Date and time when the report was printed
 3. Sender ID

4. Reception data
 - Prints the information of no paper/no toner reception.
 - ENTRIES is the number of received communication stored in the memory.
 - PAGES is the number of total pages of the received messages stored in the memory.

5. Personal Box
 - Prints the open condition of personal Box.
 - MODE shows the type of Box.
 - ENTRIES prints the number of receipt stored in the memory.
 - PAGES prints the number of total pages of each Box.

6. Polling TX/RX
 - Prints the information of Polling RX or Polling TX of unused Box.
 - Polling TX prints "MODE" column and the number of read pages. (when Feeder Polling TX, the number of read pages is a blank.)
 - Polling RX prints the communication date and time, distant station ID and MODE.

7. Transmission
 - Prints the information of Delay memory transmission and Redial. (However, Polling RX information is printed out on the above item 6 on the page 4-45)
 - The communication date and time, distant station ID and Mode are printed.

Note: When there is no stored image data in the memory at all, this Active Memory Files is not printed out. (NO DATA IN MEMORY)

4.6.5 Configuration reports

Format : See Fig. 4-5-5.

Purpose : To allow the user or serviceman to obtain a list of features and functions available with the machine, so that he can rearrange the machine configuration for a most efficient operating environment with the machine.

Descriptions :

1. Title of the report
2. Date and time when the report was printed
3. Sender ID

4. User programmed function parameters
Function parameters are shown in sub-section 4.4.5.4.
5. Telephone and call back number
6. Dial parameters

4.6.6 Service default report (configuration report: service-bit = ON)

Format : See Fig. 4-5-6.

Method : The report will be manually printed out for maintenance purpose.

- Descriptions :
1. Title of the report
 2. Date and time when the report was printed
 3. Sender ID
 4. User programmed function parameters
 5. Telephone and call back number
 6. Dial parameters
 7. Function parameters are shown in sub-section 4.5.2.

4.6.7 Telephone directory

Format : See Fig. 4-5-7-1, 4-5-7-2 and 4-5-7-3.

Descriptions : Three pages for FX-051.

(1/2)

1. Title of the report
 2. Date and time when the report was printed
 3. Sender ID
 4. Programmed ID (15 characters) *1
 5. Programmed one-touch telephone numbers (for FAX)
 6. Programmed alternate telephone numbers (for FAX)
 7. Programmed one-touch parameters
 8. Programmed auto-dial telephone numbers (for FAX)
- *1 One-touch dial 01 to 10

(2/2)

1. Title of the report
2. Date and time when the report was printed
3. Sender ID
4. Group number (#1 - #5)
5. Programmed one-touch numbers (01 - 10)
6. Programmed auto-dial numbers (01 - 70)

4.6.8 Protocol dump data printing

Format : See Fig. 4-5-8.

Purpose : To allow the serviceman to obtain a list of protocol signals transferred between the transmitter and receiver.

Method : The report will be manually printed out for maintenance purpose.

Descriptions :

1. Title of the report
2. Date of communication
3. Time of communication
4. One message transmission/reception time
5. Identification of remote station
 - CSI and/or telephone number
6. Mode of transmission/reception according to ITU-T designation
7. Total number of pages in communication
8. Identification of the result of the communication
9. Service code
10. Communication protocol
11. TX: DIS/DTC /NSF/ NSS/ NSC
12. RX: DIS/DTC/NSF/NSS/ NSC
13. Received telephone number
14. Transmitted telephone number
15. Received SEP/SUB
16. Transmitted SEP/SUB

4.6.9 Log Report

Purpose : The report will be manually printed out for fault analysis.

4.6.10 Broadcast entry report

Format : See Fig. 4-5-9.

Purpose : To allow the operator to obtain a list of entered locations for the broadcast.

Descriptions : 1. Title of the report
2. Date and time when the report was printed
3. Sender ID
4. Session number
5. Specified transmission time
6. Reserved transmission address (One-touch dial)
7. Registered location ID (One-touch dial)
8. Reserved transmission address (2 digit auto dial)
9. Registered location ID (2 digit auto dial)
10. Reserved transmission address (Ten key dial)
Five locations are available.

4.6.11 Confidential RX report

Format : See Fig. 4-5-12.

Purpose : To inform the operator about a stored confidential message in the memory.

4.6.12 Power OFF report

Format : See Fig. 4-5-11.

Purpose : To indicate AC power failure and recovery and in case of destruction of accumulated picture data in Memory. The information printed on the Power OFF report is not printed out on the Activity report.

Method : The report will be automatically printed out when the AC power is restored.

4.6.13 Call back message

Format : See Fig. 4-5-13. (Call back message)

Purpose : To send a prepared message to destination.

4.7 Restrictions by the Printer

4.7.1 Printing time

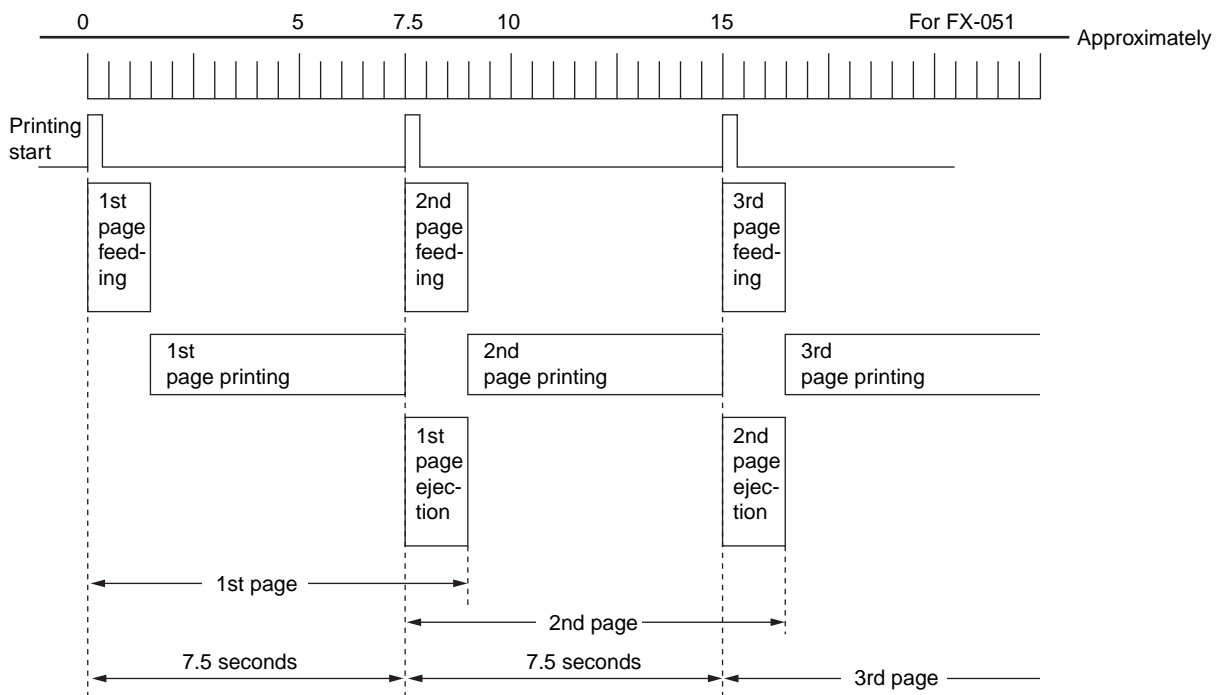

8 pages of A4-size paper per minute

As illustrated above, it takes about 7.5 seconds to print on a page of A4-size paper by the printer used in FX-051. While the printing time is fixed, the communication time varies considerably depending on the complexity of the document image. To match the printing time to the communication time, FX-051 starts printing after receiving the image data for a page.

FX-051 prevents memory overflow by controlling the communication time by the following method.

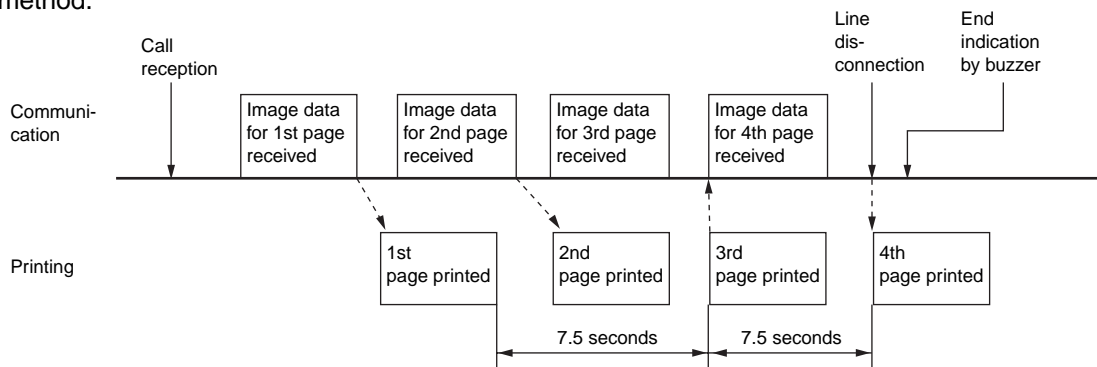

4.7.2 Printing area and image scaling

4.7.2.1 Variable (reduction) printing

FX-051 uses cut-sheet papers of A4, letter, and legal sizes.

FX-051 (US), for example, reads a document at 8 dots/mm x 7.7 lines/mm and sends it to remote TX-051 (US).

On the other hand, FX-051 (US) at receiving side receives the document, then converts the horizontal resolution from 8 dots/mm to 300 dots/inch and the vertical resolution from 7.7 lines/mm to 784 lines/inch using image smoothing process. And also 784 to 1076 lines/inch (variable resolution) is available for vertical printing.

No.	Inapplicable Standard	Standard Specification	FX-051 specification
1	CCITT T4.2.1 CEPT 5.1.4 18R53 7.2.1	Vertical scanning resolution The vertical scanning resolution should be 3.85 lines/mm \pm 1 % for 7.7 lines/mm \pm 1 %	The original image is reduced by 73 % to 100 %. (Except EX-Fine Copy mode)
2	CCITT T4.2.2 CEPT 5.1.1 18R53 7.3.1	Horizontal scanning resolution The length of a horizontal scanning line should be 215 mm \pm 1 % for 1728 white-band-black picture elements	203.2 mm \pm 1 % User Function No.27 (Width Reduction) ON: The original image is reduced by 95% The detail is shown as below: (1) COPY a. STD copy • A4 size paper : 97.9% • Except A4 size paper : 94.5% b. FINE/EX. FINE/PHOTO copy • A4 size paper : 97.5% • Except A4 size paper : 95.0% (2) Received data • 8pel/mm : 94.1% • 300DPI : 92.6%
3	CEPT 5.1.5 18R53 7.6.1	When A4-size papers are used, the first received line must be printed in the position of 0 mm to 4 mm from the top of the paper.	0.6 mm to 8.1 mm

Since the available printing area of the printer is smaller than the paper size, document contents may be missed on both sides of the paper, or a document image having the same length as the printing paper may be split into separate pages in printing. To prevent these, FX-051 automatically adjust itself to the proper reduction ratio within the following range.

73 to 100% (US: Letter paper)

78 to 100% (INT'L: A4 paper)

Note: The difference of the range depends on memory size and paper size.

4.7.3 Operation on alarm occurrence during printing

If a power failure or a printer alarm (including paper run-out alarm) occurs during printing of a received image, the image data already received and stored in the memory is regarded as no-paper received data. After the recovery from the failure, printing of the received image data automatically starts with the interrupted page, for FX-051 cannot reproduce the data for power failure.

4.7.4 Heater control

The temperature of the toner fixing heater is lowered in the standby state to reduce power consumption and heat generation. The heater control operation is shown below.

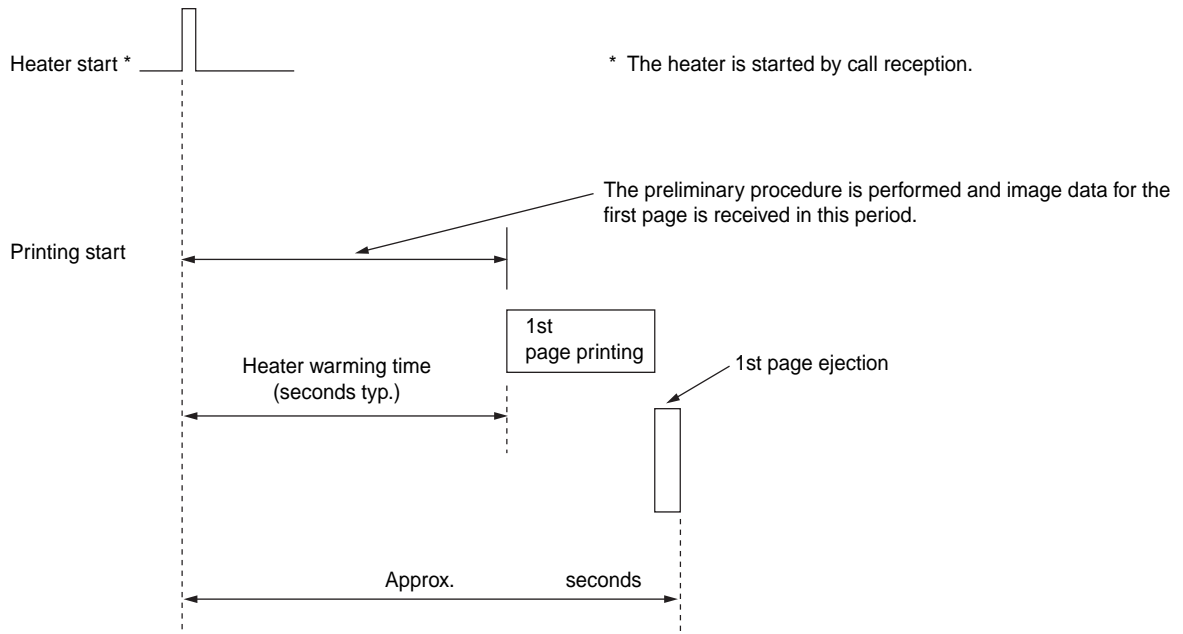

- The printer is normally placed in the standby. If a call is received in this state, the heater is started; however, it takes a typically of 20 seconds for start printing. (This does not make longer the transmission time for document images such as ITU No. 1 sample document because, when a call is received the heater turned to ON, and printing of the first page starts after the preliminary procedure is performed and received image data.)

4.7.5 Warming up of the printer

The printer starts the warm-up sequence to warm the toner fixing heater immediately after the power is turned on.

4.8 Other Functions

4.8.1 Language

Selection of 2 languages shown on LCD and printed on reports is available to the user. Language selection is available for destination.

Default : Refer to Table 4-6.

4.8.2 Incoming Ringer

Bell signal is generated by software for several countries (Holland, Belgium, New Zealand etc.) of INT'L version because ring circuit is not installed for the these countries.

Therefore, the machine must make a bell signal and generate the bell sound through a speaker.

Function : Machine will decide to enable or disable this function using NCU selfcheck function automatically.
2400 Hz/16 Hz bell sound is generated by detecting ring signal timing.

4.8.3 CML-ON timing

Function : To meet various countries requirements, CML-ON timing is selectable from 100 ms to 1900 ms in 100 ms step.

Default : To meet various countries requirements.

4.8.4 Real time dialing

Function : Real time dialing condition is selectable to meet various countries requirements.

TYPE 1 : Real time dialing is available at OFF-HOOK.

TYPE 2 : Real time dialing is available at both OFF-HOOK and press HOOK key.

OFF : Real time dialing is not available.

Default : To meet various countries requirements.

4.8.5 Ring duration time

Function : To meet various countries requirements.
Ring duration time is selectable from 100 ms to 990 ms in 10 ms steps.

4.8.6 PC printer mode

Machine works as 300 DPI printer of PC and also works as Quasi-600 DPI (300 x 1200 DPI) by using attached printer driver and application software which are provided by OKIDATA. For details, please refer to appendix "MFP product specification".

4.8.7 Hyper power save mode (This wording is tentative)

To decrease the machine's power consumption, machine supplies power only for Control Panel circuit and a part of NCU board circuit in standby mode.

Refer to Fig.4-4-20

Machine shows *POWER SAVE MODE PRESS "START" during power save mode.

Main power turned on conditions:

- 1) When Power switch is turned on.
- 2) When Start key is pressed on standby condition (all other key operations are ignored without key touch tone)
- 3) When ring signal from out side line is detected.
- 4) When Off Hook (hand set) is detected.
- 5) When PC1 (Document) is detected for TX or COPY.

Main power turn OFF conditions:

Main power is turned off automatically when the main power off timer (180 seconds) is activated and after which machine becomes real standby mode.

Real standby mode does not allow following conditions:

- 1) When power save mode setting is OFF by user.
- 2) When operation is activated such as FAX TX/RX, local copy, report printing, during key operation, PC interface mode, warming up, maintenance mode.
- 3) Hook up condition
- 4) Alarm condition
- 5) When image data is stored in memory (memory reception, confidential reception, memory transmission)
- 6) Delayed TX mode or waiting for redial
- 7) When manual recording paper feed is detected.

Refer to Fig. 4-4-20.

4.8.8 V34 (33.6/22.8KBPS) MODEM

V34 MODEM is not available.

4.8.9 FAX forwarding

This function is not available.

4.8.10 Cleaning Page mode

To remove residual impurities from printing surfaces or to reduce problems such as repeating marks, blotching, and shading.

Operation:

To generate a cleaning page on the FX048 series, press the SELECT FUNCTION key once then press OT10 key and NO key twice. LCD display shows PRINTER CLEANING, then press YES key and PRINTER CLEANING EXECUTING is displayed. Machine will return to stand by mode after the cleaning procedure. Refer to Fig. 4-3-24 and Fig. 4-3-27.

4.8.11 Image in MCF

To enable or disable the message in MCF setting.

This is printed at the bottom of the message confirmation report and can help operator to inform which document transmit

User can set to off the IMAGE IN MCF when user does not want to disclose the sending data to other people.

4.8.12 Distinctive Ring

Distinctive ringing is a service offered by telephone carriers that allow you to have several different numbers on one line, each with its own distinctive ring.

In this way, when you get an incoming call, you can identify what number is being called by the ring pattern.

(Your local telephone carrier can provide you with more information about this service. This service is usually offered as a monthly charge to your normal phone bill).

By this setting, your fax machine has a distinctive ringing function that allows you to register one additional distinctive ring pattern.

Then, you can change or cancel the distinctive ring setting anytime.

Learning the ring pattern for automatic answering is available. Default setting is OFF.

4.8.13 Error Criterion Value

To select the scatter error (error criterion) ratio to determine the RTN response at the time of reception to meet the PTT approval.

This is error decision value for the reception in non-ECM mode.

Machine will respond RTN instead of MCF for the post command.

Refer to Table 4-7.

4.8.14 DIS BIT 32

To select on/off to apply to PTT approval.

To improve compatibility between this machine and other company's machines. Refer to Fig.4-3-4-2/3 and Table 4-6-1/2.

Reception of extra fine, 14.4K bps and SEP/SUB function are not available for the other company's machines when this setting is OFF.

4.8.15 T1(TX) and T1 (RX) Timer Value

T1(TX) timer name is changed from T1 T.O.

Refer to Fig.4-3-4-2/3 and Table 4-7.

T1 (RX) timer is reception side.

This setting is added to apply to PTT approval from this series.

Refer to Fig.4-3-4-2/3 and Table 4-7.

4.8.16 T2 Timer Value

T2 timer value means that EOL interval timer.

This setting is added to apply to PTT approval from this series.

Refer to Fig.4-3-4-2/3 and Table 4-7.

4.8.17 TAD I/F

Machine will detect DTMF from distant station and turn to auto-reception mode even if the machine is under TAD recording mode.

Refer to Fig.4-4-3 and Fig.4-4-12.

4.8.18 Parallel Pick Up

Refer to Fig.4-3-18-2/3.

When user has connected external telephone line to this machine and number for REMOTE RECEIVE is entered, then this function is available.

Remote reception (Operator can change if recognized as fax called station) is available from external telephone for FX-051.

Tentative information:Parallele telephone connection is available for this function if the PTT allows it.

4.8.19 Oki High Speed Protocol for 14.4K

To improve transmission time for 14.4Kbps rate.

4.8.20 Error report ON/OFF

To enable or disable the automatic print out of a message confirmation report upon a communication error.

In single location transmission, the MCF report is an error report when function No.01 MCF.(SINGLE-LOCATION) is ON.

In other words, single location transmission of function No.01 includes No.03.

Then No.03 is ON during multi-location transmissions, an error report is printed out for each individual communication error.

An error report which is different from No.02 is printed out for each single location.

4.9 New Functions and changed operations

4.9.1 300DPI function

For FAX communication

For Local copy and PC scan in horizontal resolution

For Printer

4.9.1.1 TX mode

When EXTRA FINE mode is selected, the machine will transmit in the following resolution.

[Transmit resolution]	[Remote RX machine's ability]
300 x 300 DPI	300 DPI and EX. FINE are available
8 dots/mm x 15.4 lines/mm	300 DPI is not available, EX. FINE is available
8 dots/mm x 7.7 lines/mm	300 DPI and EX.FINE are not available

In case the machine has no learning function data (not memorize the resolution ability data of remote machine), the machine will be activated in FINE even if the EXTRA FINE mode is selected.

In case the memorized learning data and remote machine's ability are not matched, the TX machine will convert the scanned data to the remote machine's ability and send it without error.

4.9.1.2 RX mode

In reception mode, TX side machine will automatically fit the data to receive preferably and print it out.

4.9.1.3 COPY mode

When the operator selectes EXTRA FINE, the machine will make copy in 300 DPI x 15.4 lines/mm resolution.

In case the operator selectes FINE, the machine will scan in 300 DPI x 7.7 lines/mm resolution.

In case the operator selectes STD, the machine will scan in 200 DPI x 3.85 line/mm resolution.

4.9.1.4 PC scanner mode

Machine works as 300 DPI scanner of PC by using attached scanner driver and application software which are provided by OKIDATA.

For details, please refer to appendix "MFP product specification".

4.9.2 TX preparation and dual access

For the patterns of Dual Access and the description of the Dual Access, refer to Table 4-5 Dual Access Combination Table and Fig. 4-4-16 TX Preparation and Dual Access.

Reception is available during printing from the memory reception.

Reception is available during scanning the document into the memory.

Memory reception is available during printing from memory reception.

Copy is available during memory TX.

Memory RX is available during copy.

4.9.3 TR Latch Current

This switch purpose is the same as PN232 printer for FX-051.

To add adjustable function for transfer roller.

4.10 Point of difference for FX-048

4.10.1 Deleting BROADCAST/FEEDER selection

4.10.2 Instant Dialling

Starting the reading of documents upon call origination after assigning the destination.

Shortening the time up to the reading finished by starting the reading upon call origination.

(Refer to 4-20 Document reading timing)

Reading timing of conventional machines (FX-048 series) was shown as follows:

When FEEDER setting: Starting the reading after shifting to Phase C

When MEMORY setting: Starting call origination after all the documents are read in the memory

4.10.3 MEMORY FILES REPORT added

Printing the list of received but not printed yet documents and waiting documents for transmission stored in the memory. (Refer to Fig. 4-5-4)

4.10.4 RESTRICTED ACCESS function added

Restricted Access limits accessible users by setting a password beforehand. Inputting the password then enables the user's access to the machine (FAX terminal).

(Refer to Fig. 4-3-1, Fig. 4-3-24, 4.4.7.8)

4.10.5 PC Loading added

PC Loading automatically rewrites the program stored in the machine by using PC. This function is only for serviceman. (Refer to Fig. 4-3-2)

4.10.6 Personal BOX

This function can set BOX No. (1 to 8) as Confidential reception/Bulletin Polling assigning.
(Refer to 4.4.7.6, Fig. 4-3-22)

4.10.7 BULLETIN POLLING

A kind of polling transmission.

Bulletin polling enables polling transmission many times until deleting the documents stored in the memory. (Refer to Fig. 4-3-11, Fig. 4-3-22)

4.10.8 Displaying 4-figure Christian era

4-figure Christian era is LCD displayed and printed in the Report.

4.10.9 CONTINUOUS TONE

By this function, the warning tone sounds at the time of end of reception, and sounding of warning tone is continued till operator presses STOP key or the machine performs some operation. (Refer to 4.4.7.4, Fig. 4-3-18)

4.10.10 Memory Password

Registering the password required (4-Digit numerals) for outputting the data received by Memory Only Reception mode or change from Memory Only Reception Mode. (Refer to 4.4.7.7, Fig. 4-3-23, Fig. 4-4-3-3/3)

4.11 Reference for wordings between this series and current machines

Modified wording LCD and reports from previous machines

(User functions)

PRINT COF. RX MSG.	-->	PRINT PERSONAL BOX	Fig. 4-3-22
DELETE MAIL BOX	-->	DELETE PERSONAL BOX	Fig. 4-3-22
PC PRINTER	-->	PRINTING FROM PC	Fig. 4-4-18
PC SCANNER	-->	SCANNING TO PC	Fig. 4-4-18

(Technical functions)

CPU PROG1 PROG2	-->	CPU PROG
-----------------	-----	----------

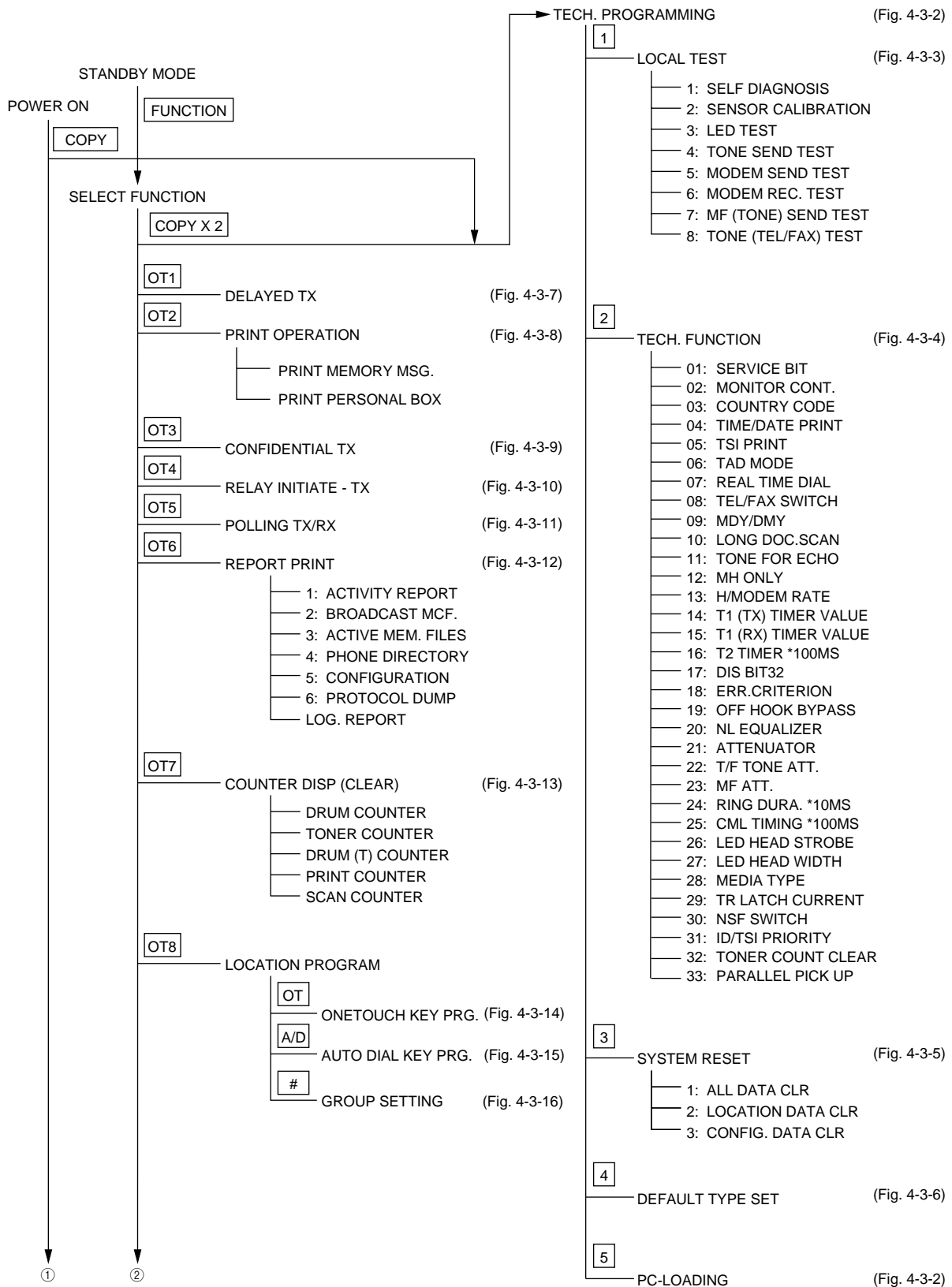

Fig. 4-1-1/2 General Key Operation

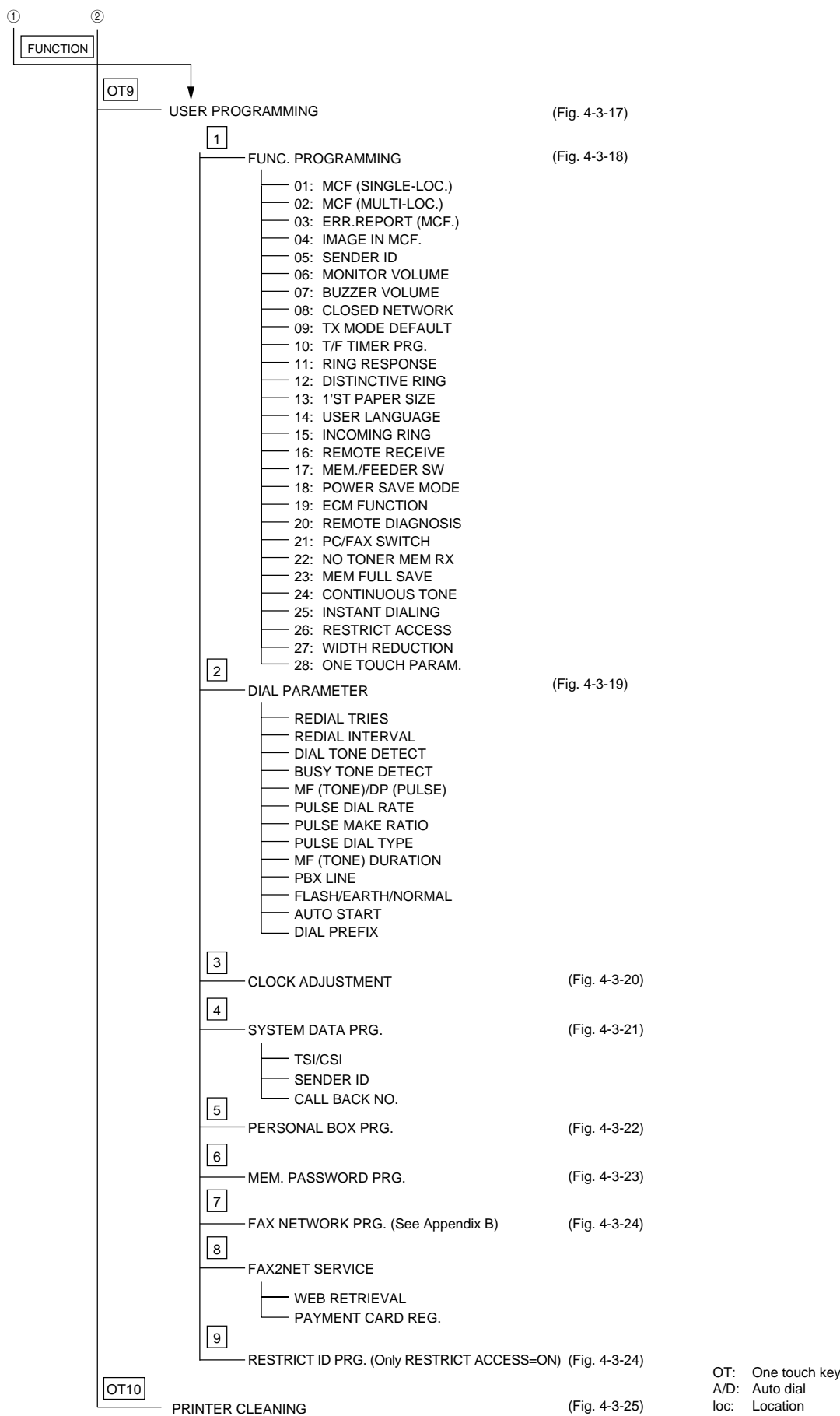

Fig. 4-1-2/2 General Key Operation

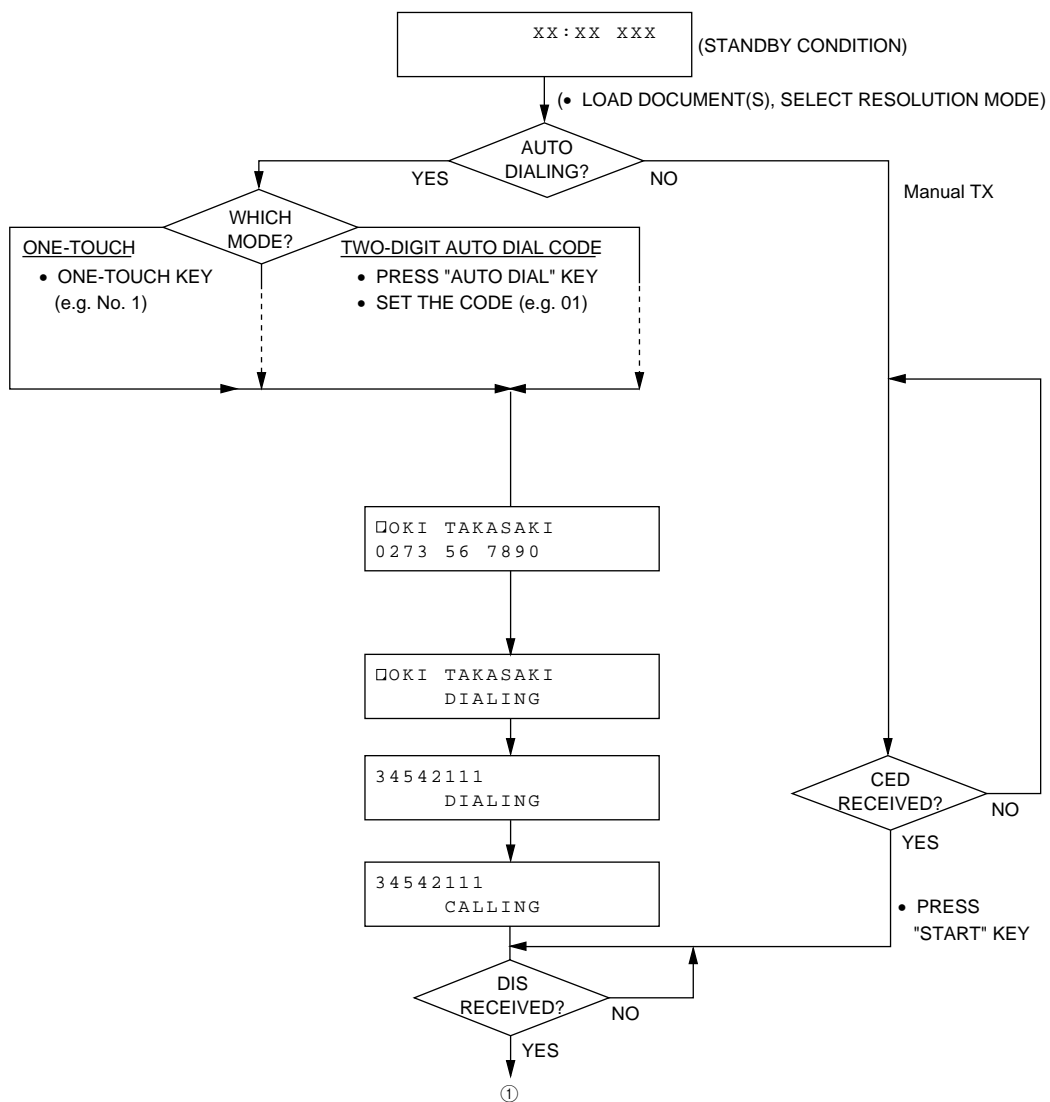

Fig. 4-1-1-1/2 Typical Transmission

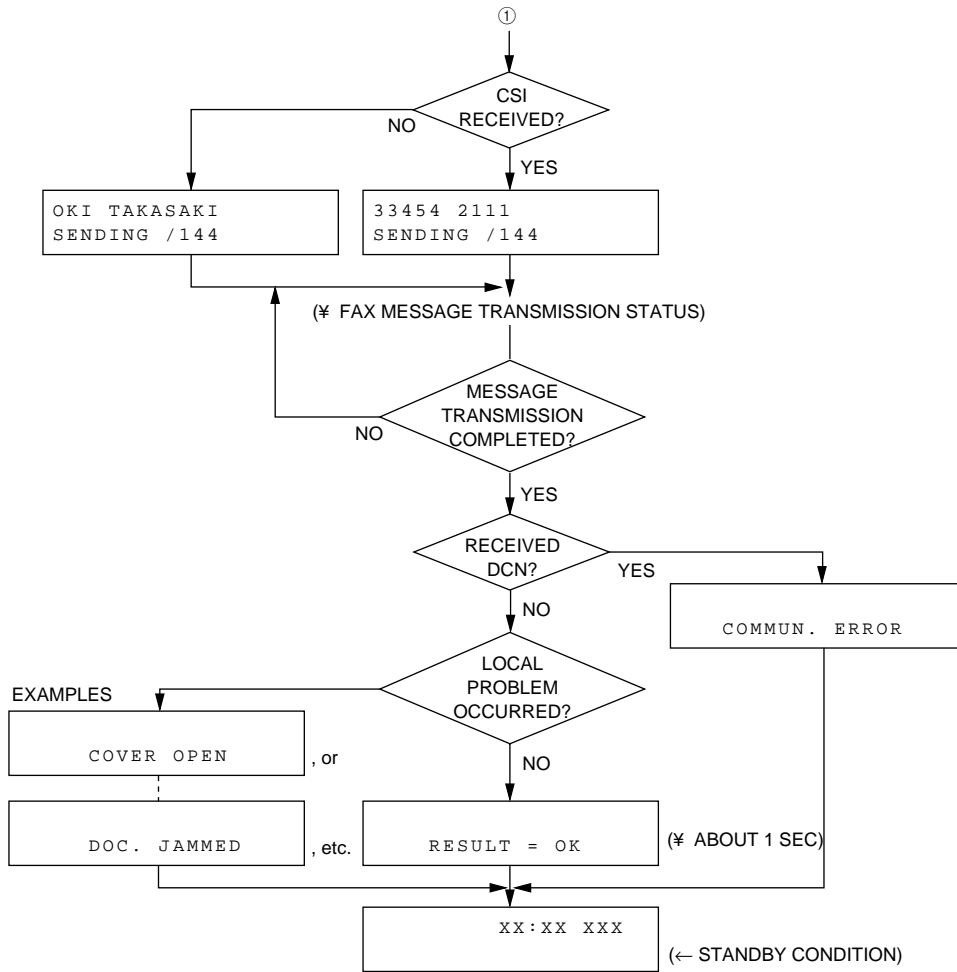

Fig. 4-1-1-2/2 Typical Transmission (continued)

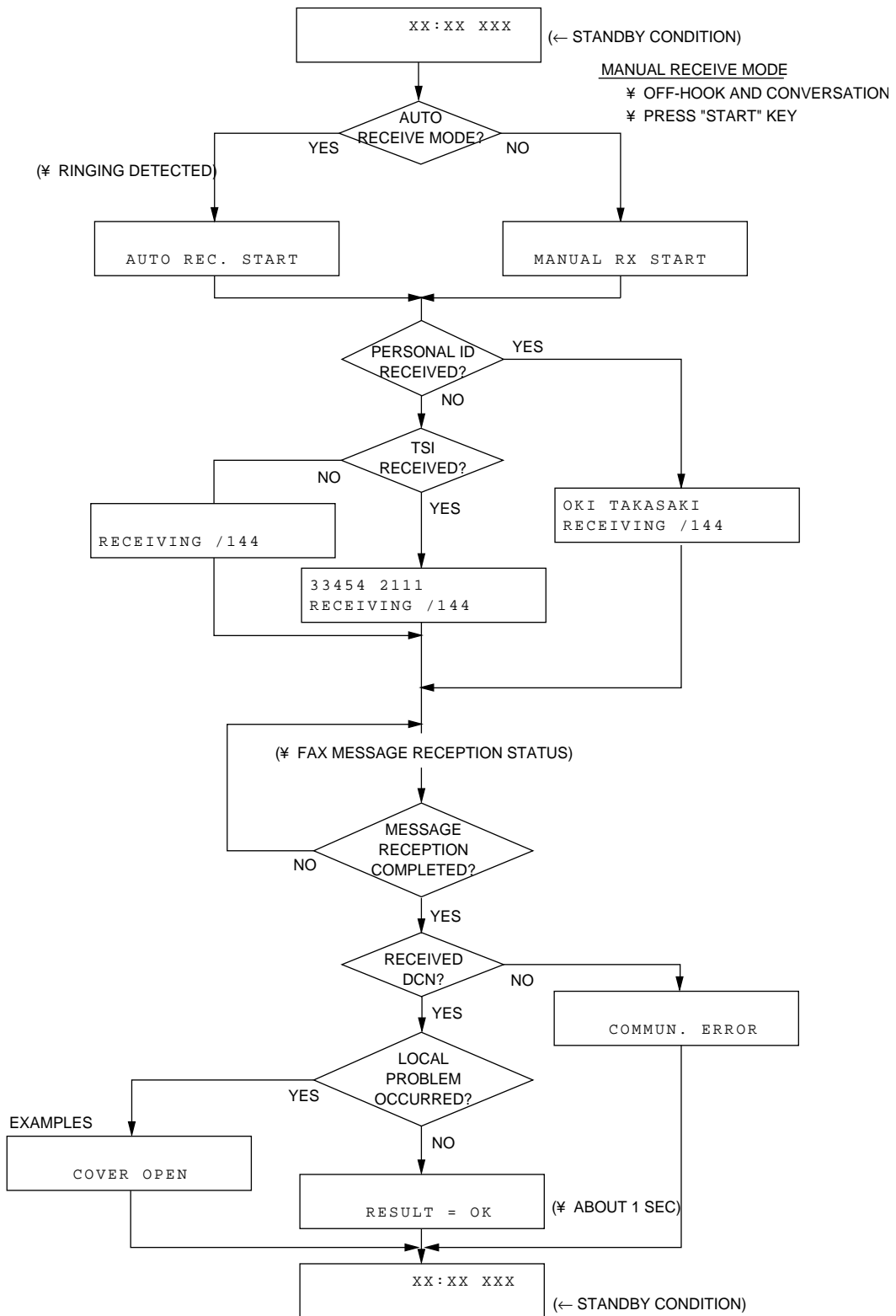
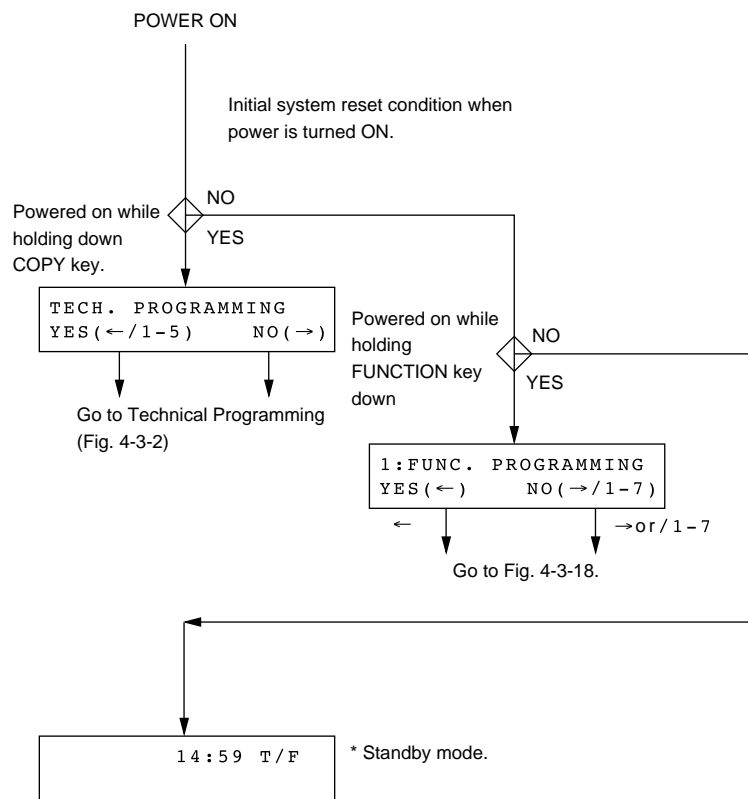

Fig. 4-1-2 Typical Reception



* Note: T/F, FAX etc., are the last setting before power is turned OFF.

Fig. 4-2-1 Power on Operation

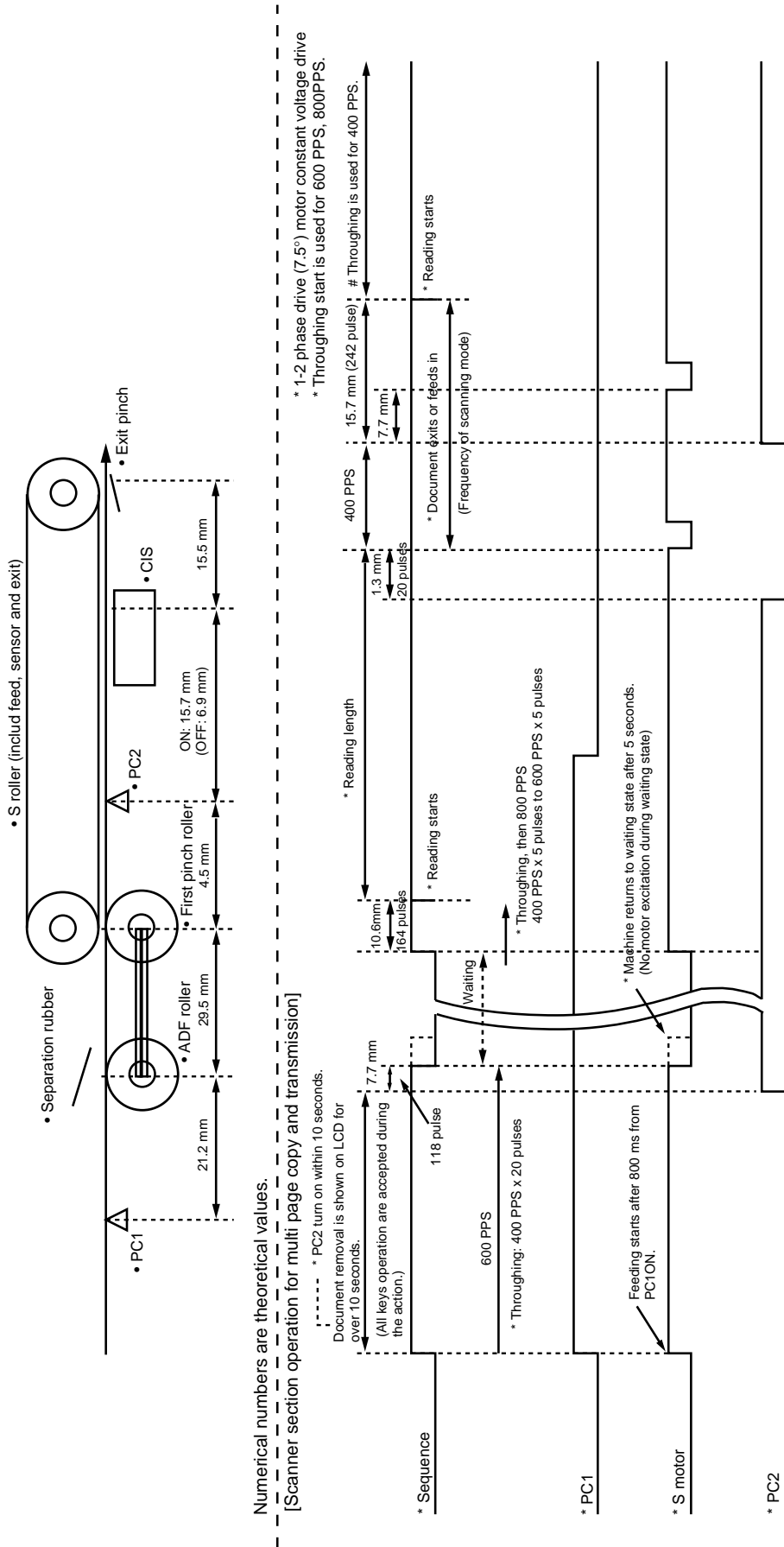
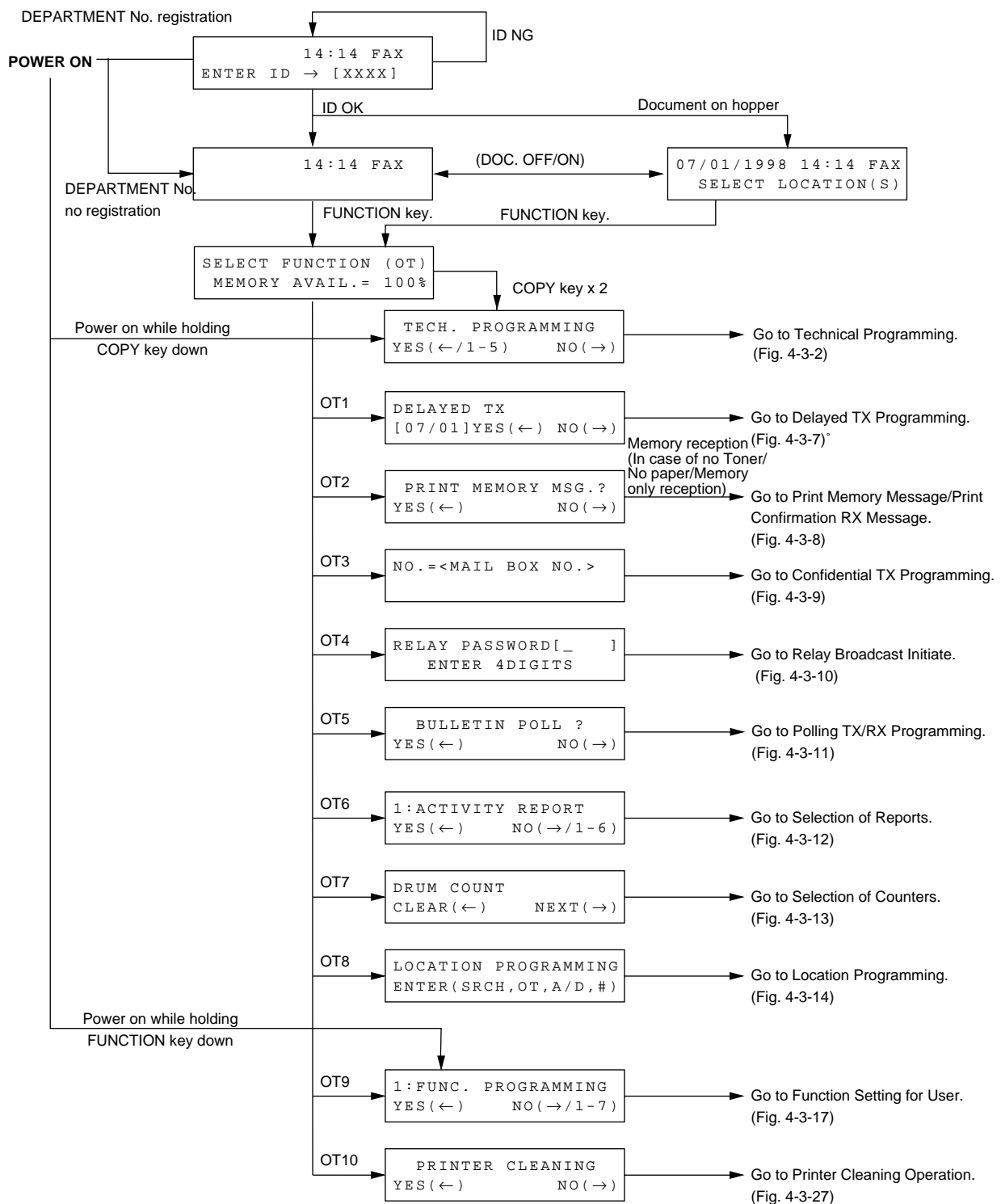

Fig. 4-2-2-2/2 FX-051 Mechanical Control Sequence (Multi Page)

Setting table of S-motor current value

Mode		Initial start	Restart
Prefeed	Pulse speed Current value	600 PPS 428 mA	----- -----
STD (3.85)	Pulse speed Current value	800 PPS 300 mA	800 PPS 428 mA
FINE (7.7)	Pulse speed Current value	800PPS 300 mA	800PPS 268 mA
EX. FINE (15.4)	Pulse speed Current value	400 PPS 268 mA	400 PPS 268 mA
Holding	Current value	184 mA	-----

* This table shows the values set provisionally.



Note: OT2, OT6, 7, 8, 9, 10 are invalid during PC printing.

Fig. 4-3-1 One Touch Key Operation

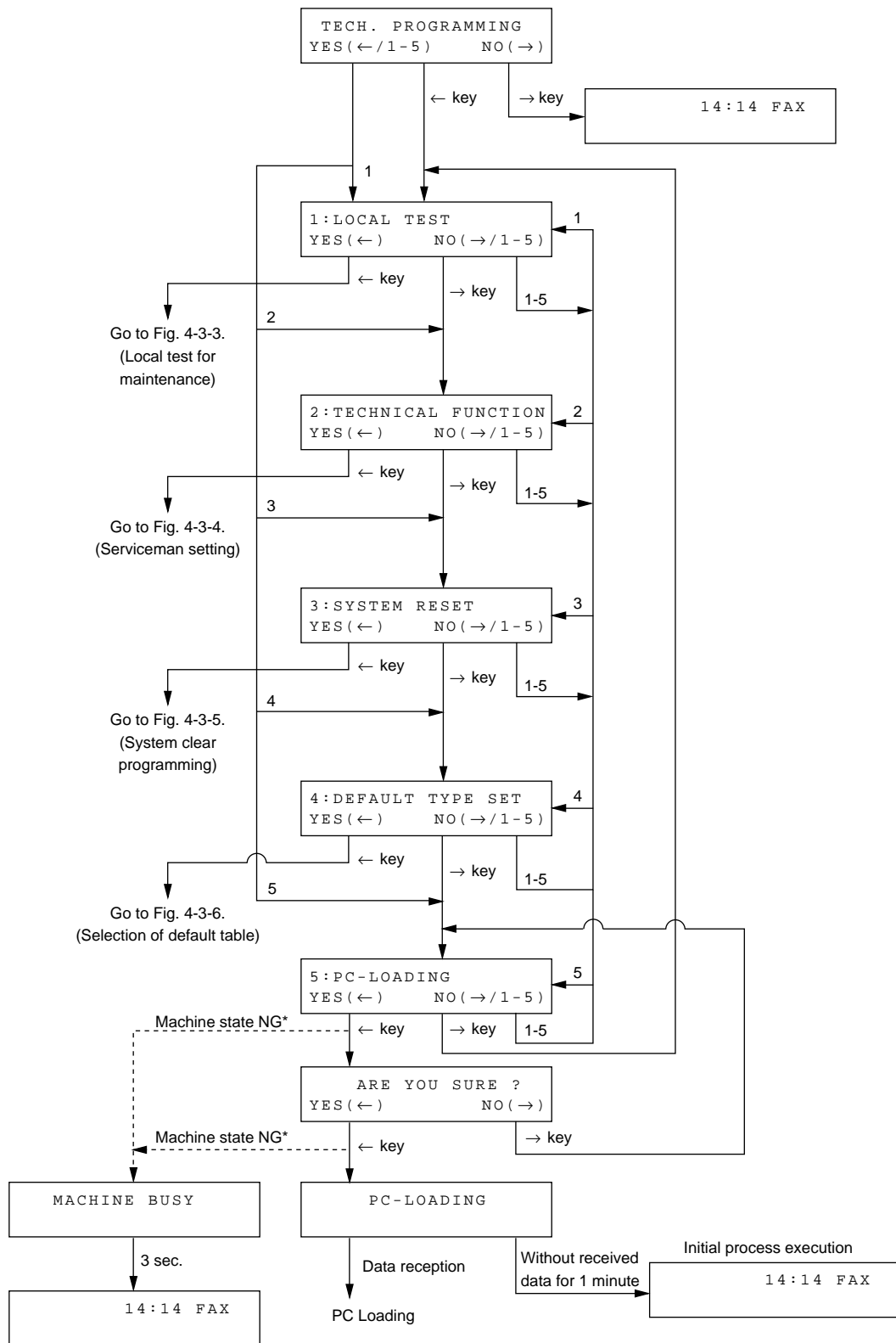

Go (Return) to standby state

*: Memory data, Redial waiting, Transmit Preparation, Machine alarm, and OFF HOOK bypass the operation as geared by dash lines and return to the standby state.

Fig. 4-3-2 Technical Programming

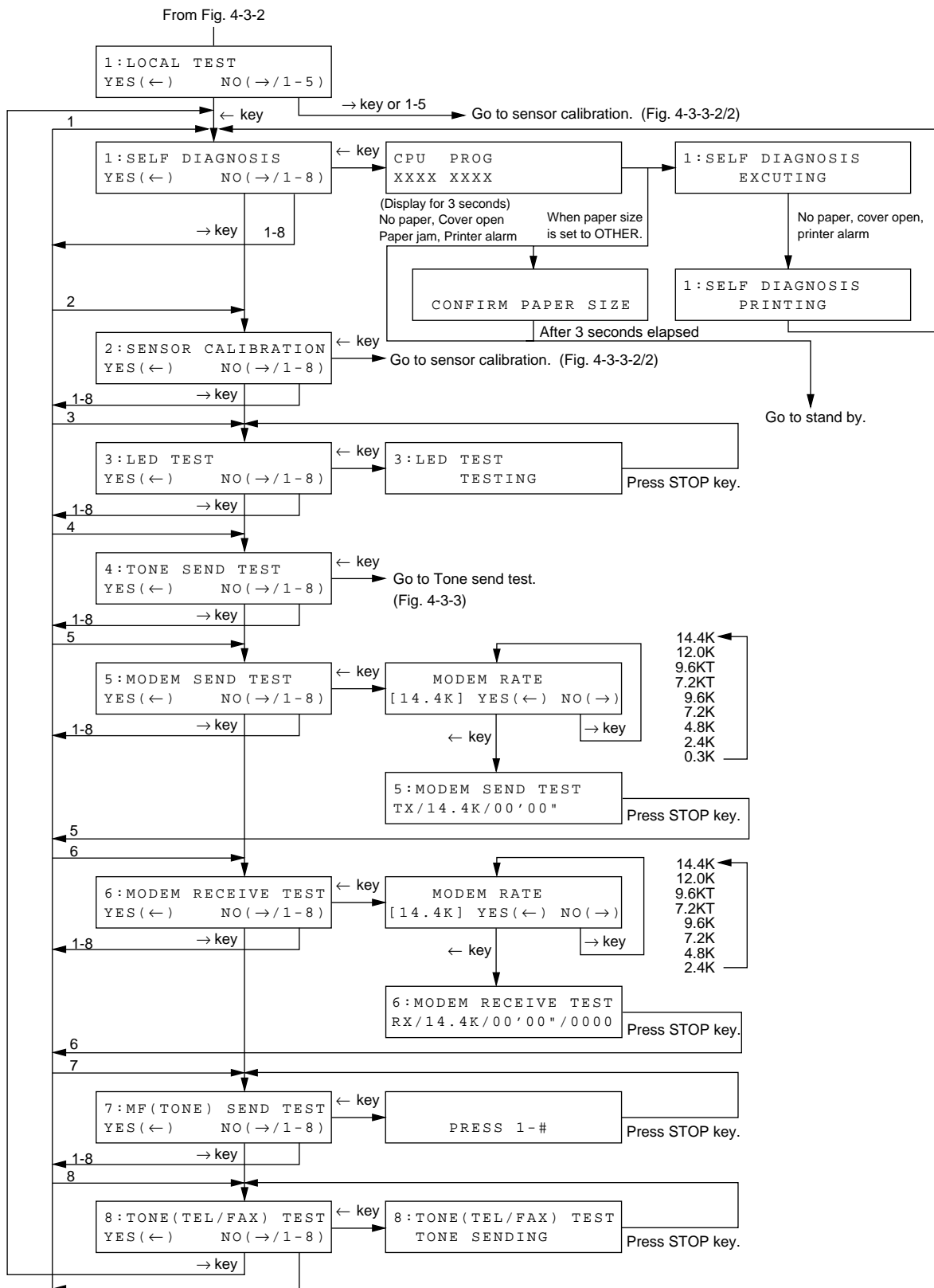

Fig. 4-3-3-1/3 Local Test

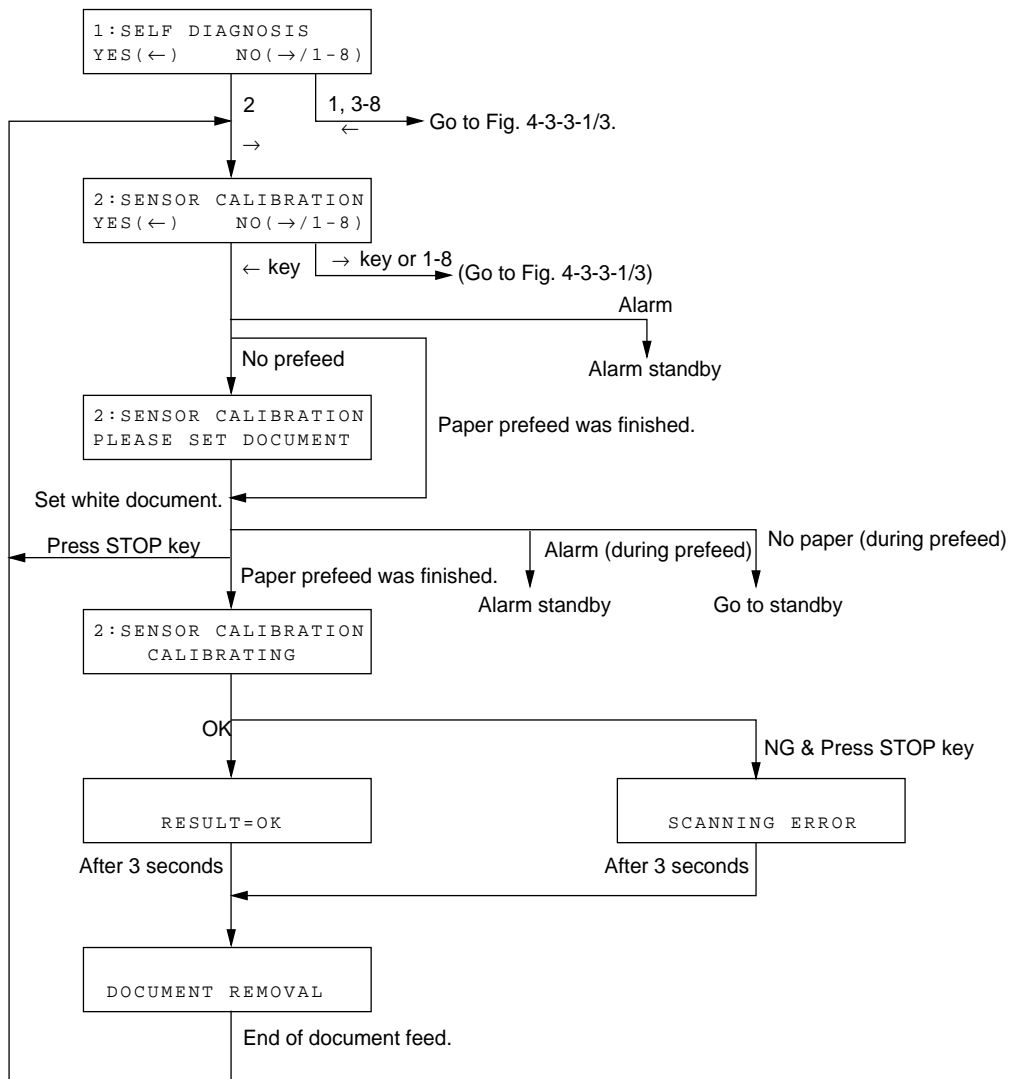
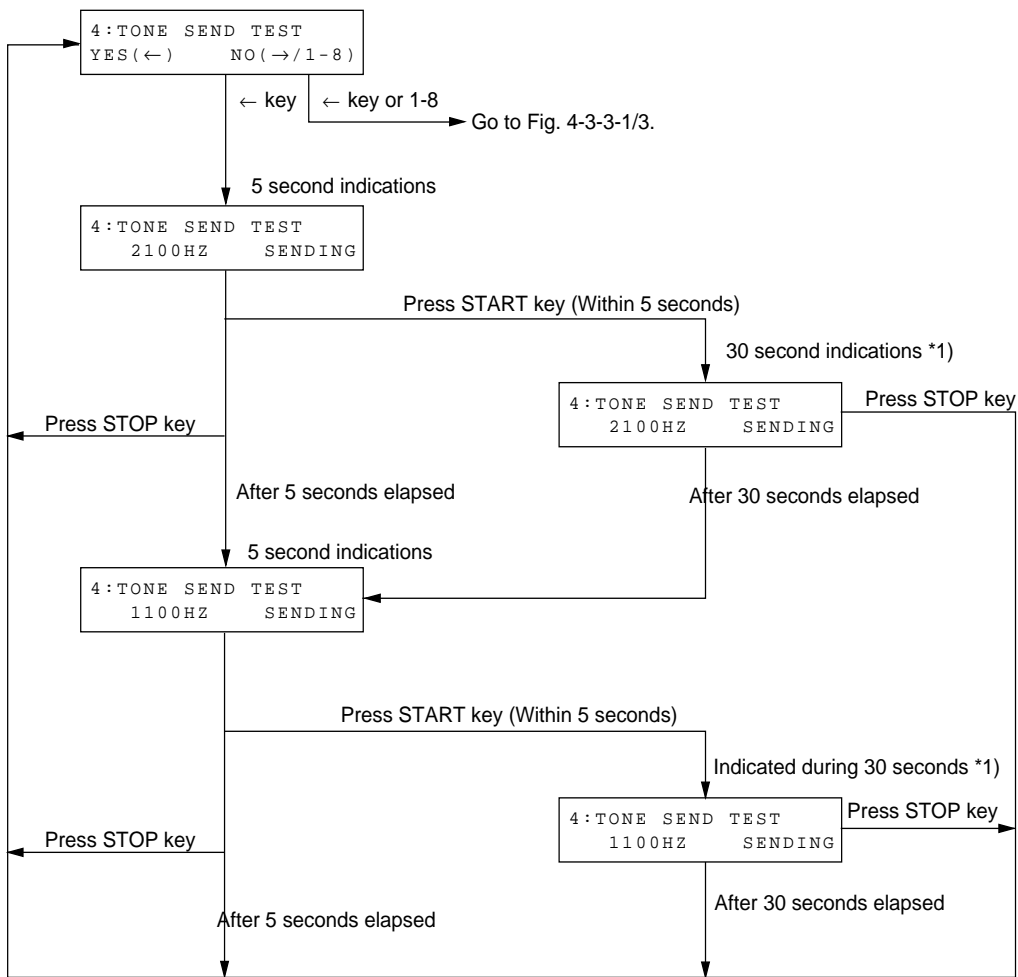

Fig. 4-3-3-2/3 Local Test (Sensor calibration)



*1) The LCD indication is further displayed more 30 seconds by pressing the START key.

Fig. 4-3-3-3/3 Tone Send Test

From Fig. 4-3-2 Technical Programming

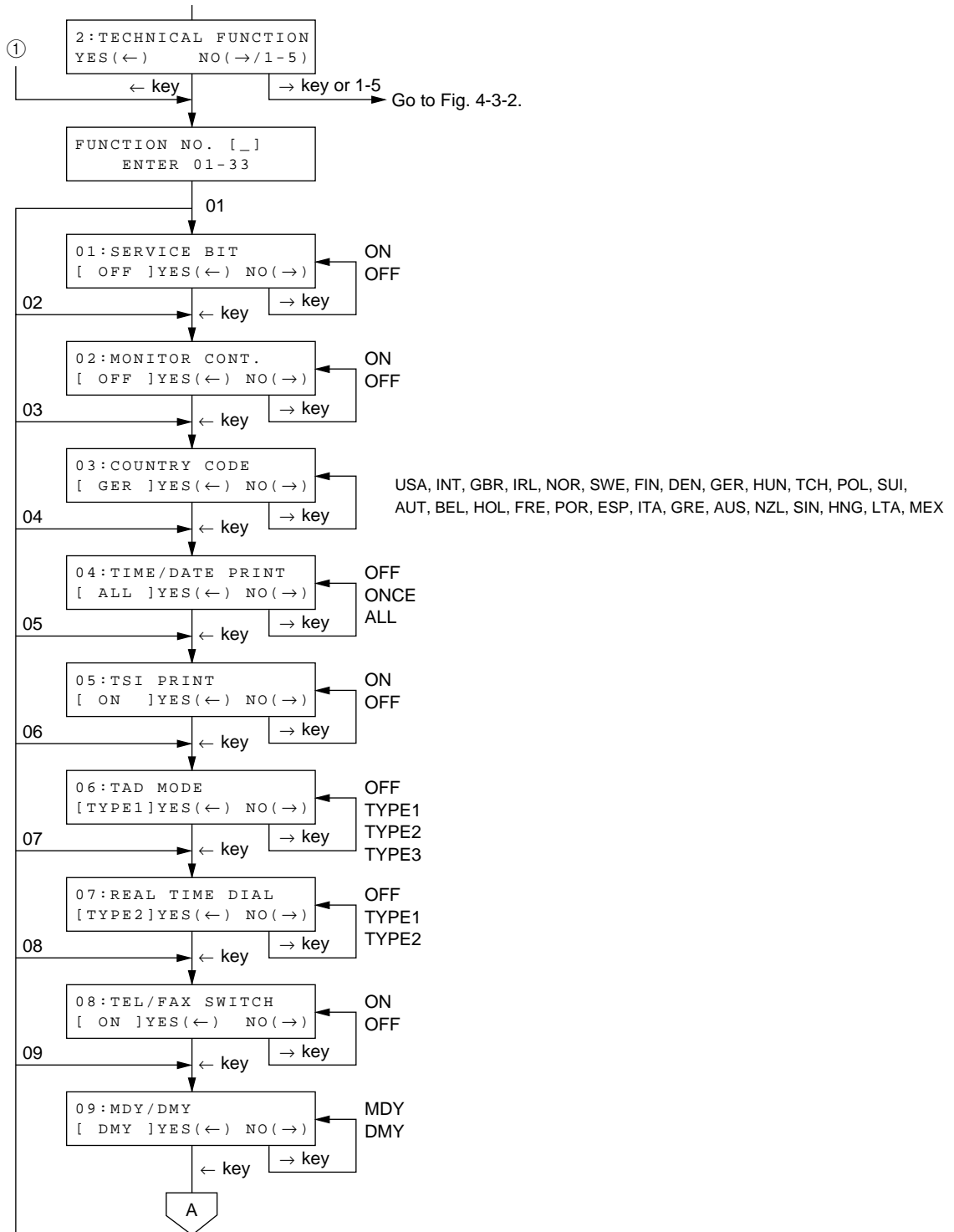

Fig. 4-3-4-1/3 Technical Function Programming

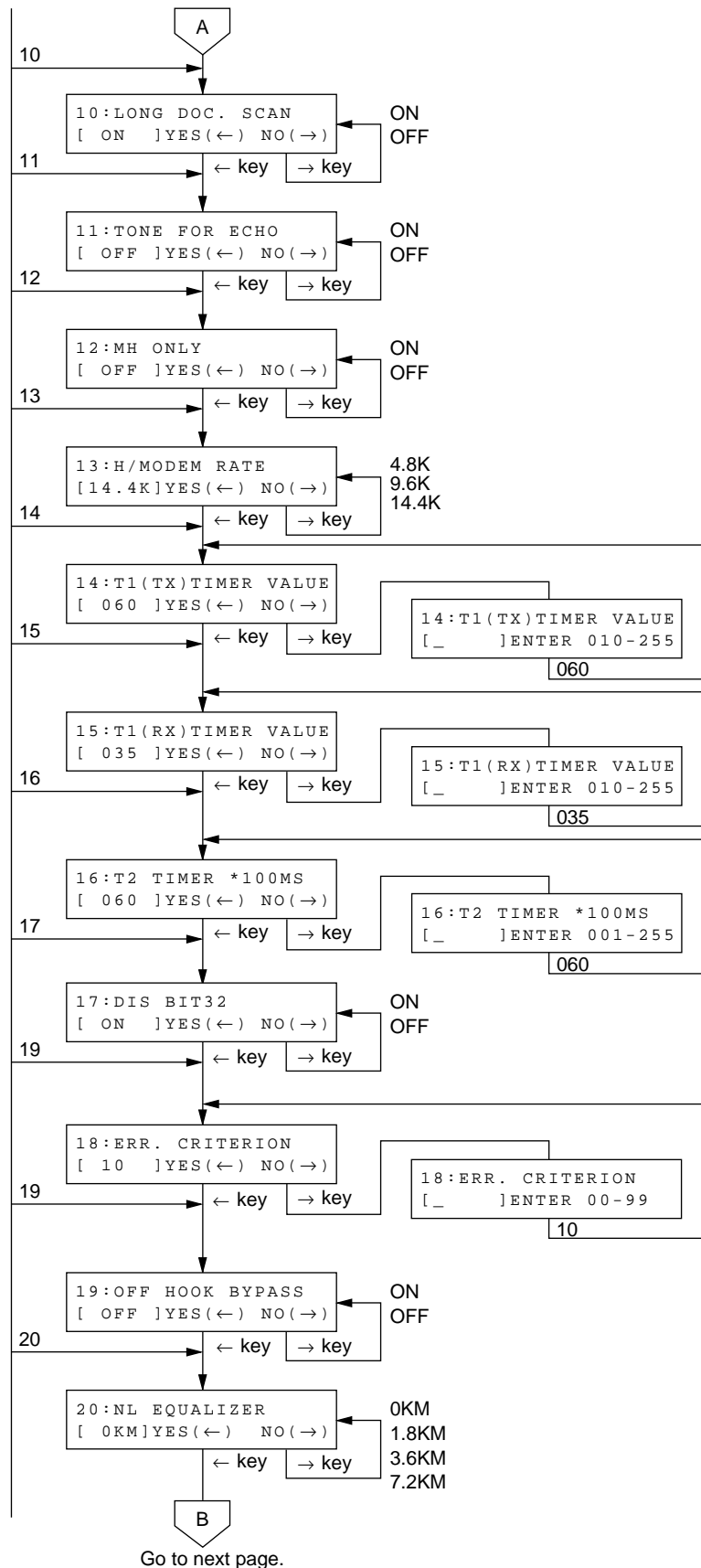
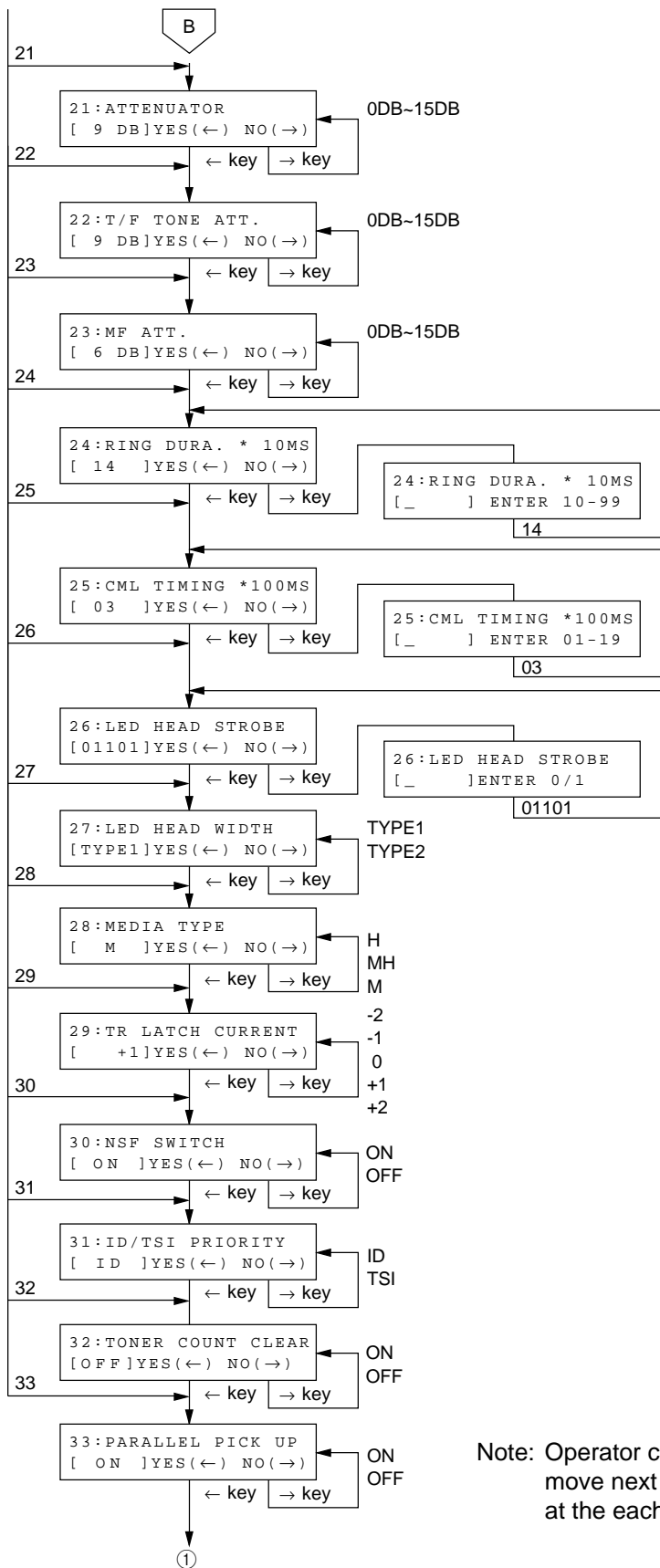

Fig. 4-3-4-2/3 Technical Function Programming



Note: Operator cannot use numeric key to move next setting or jump other setting at the each setting.

Fig. 4-3-4-3/3 Technical Function Programming

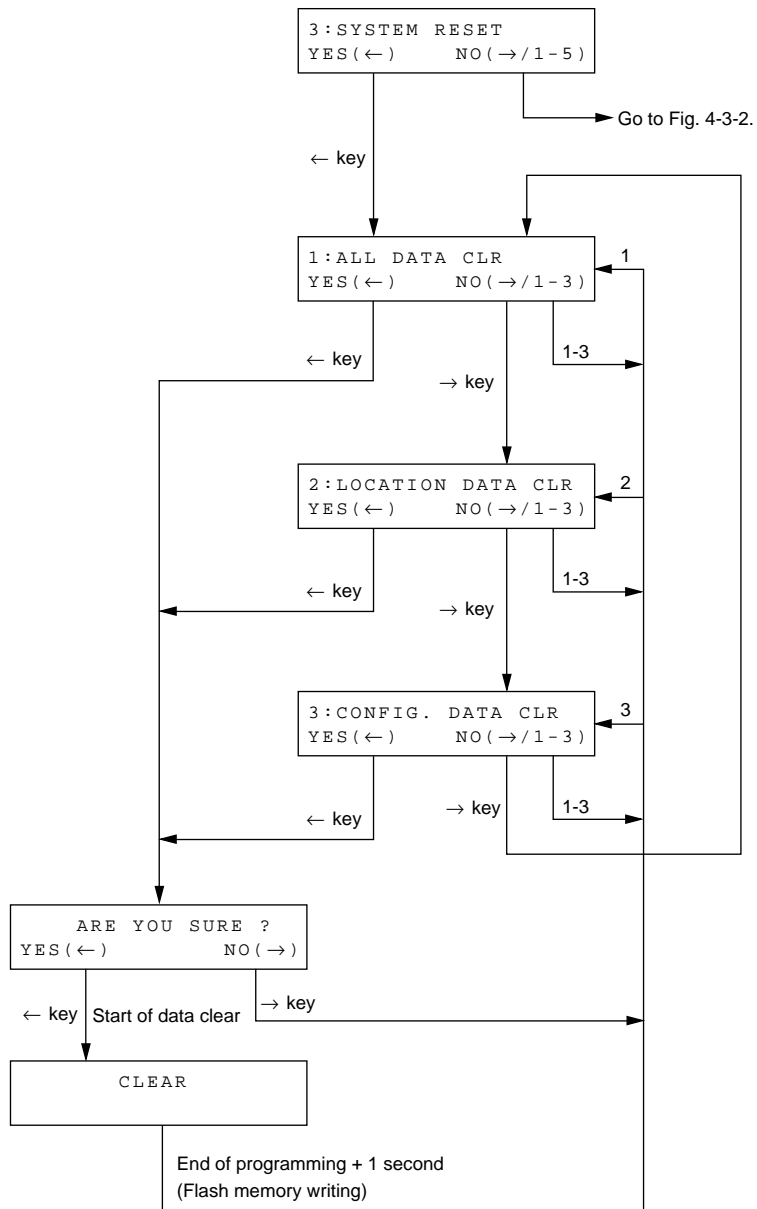
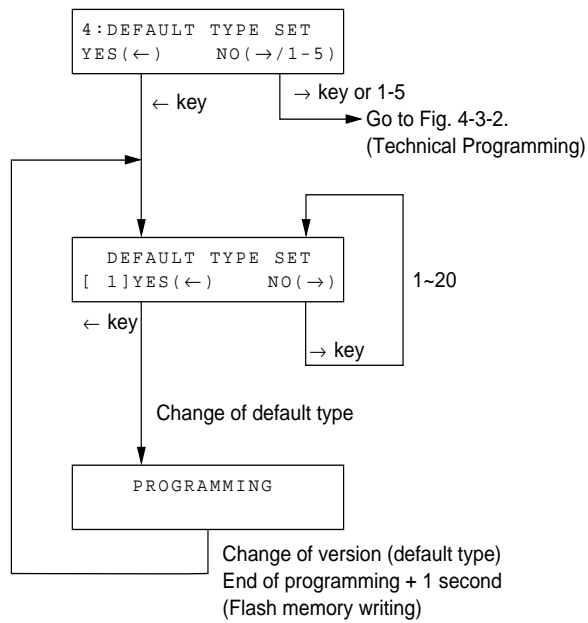

Fig. 4-3-5 System Reset



Note: Even if serviceman makes all data clear by using system reset, the default type is not changed.

Fig. 4-3-6 Default Type Setting

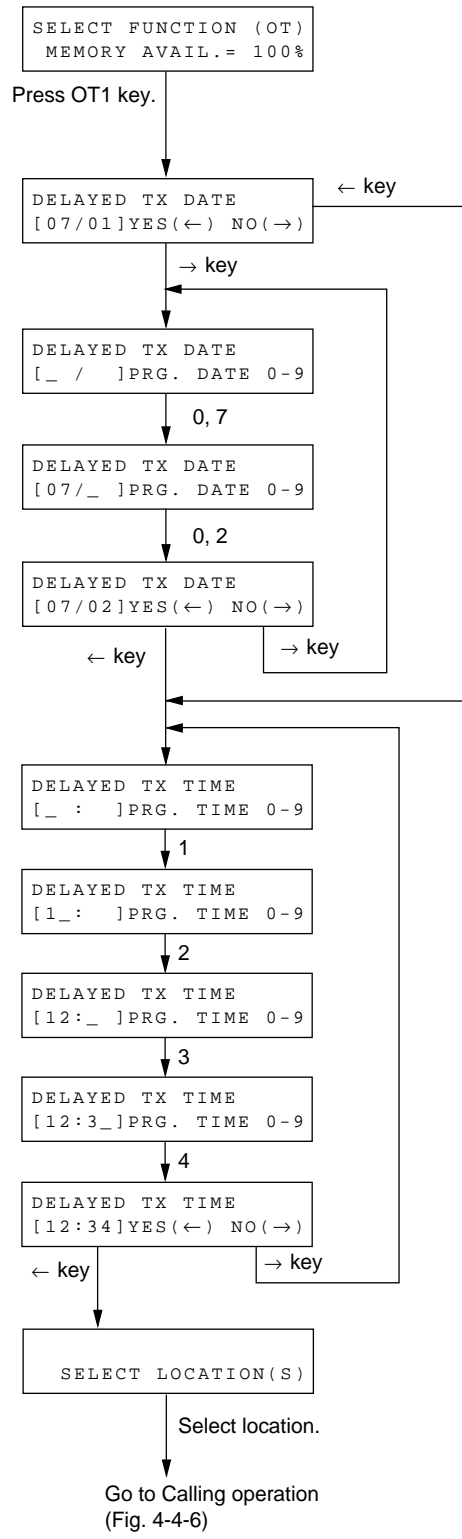

Fig. 4-3-7 Delayed TX

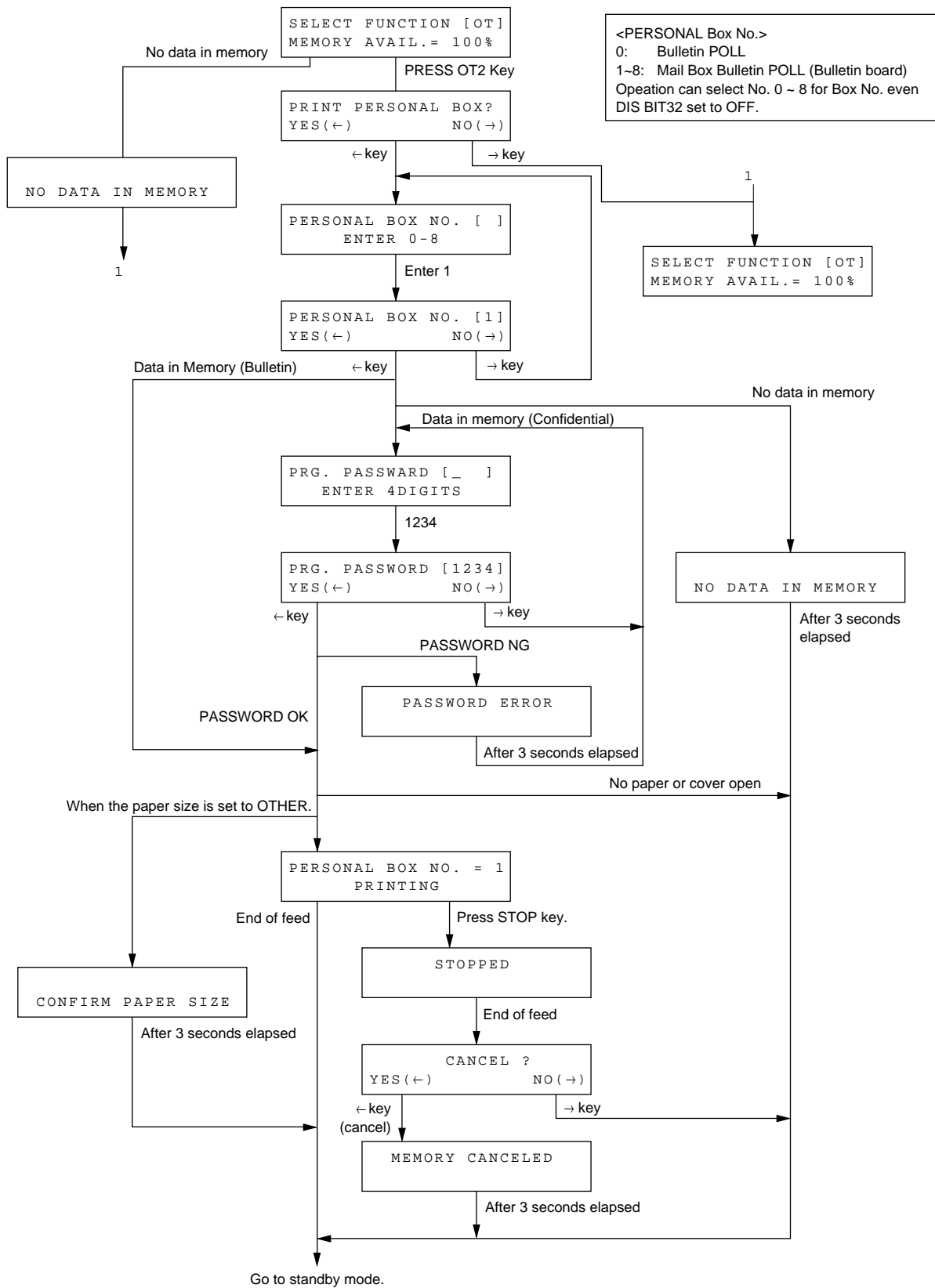

Fig. 4-3-8-1/2 Personal Box Print Out

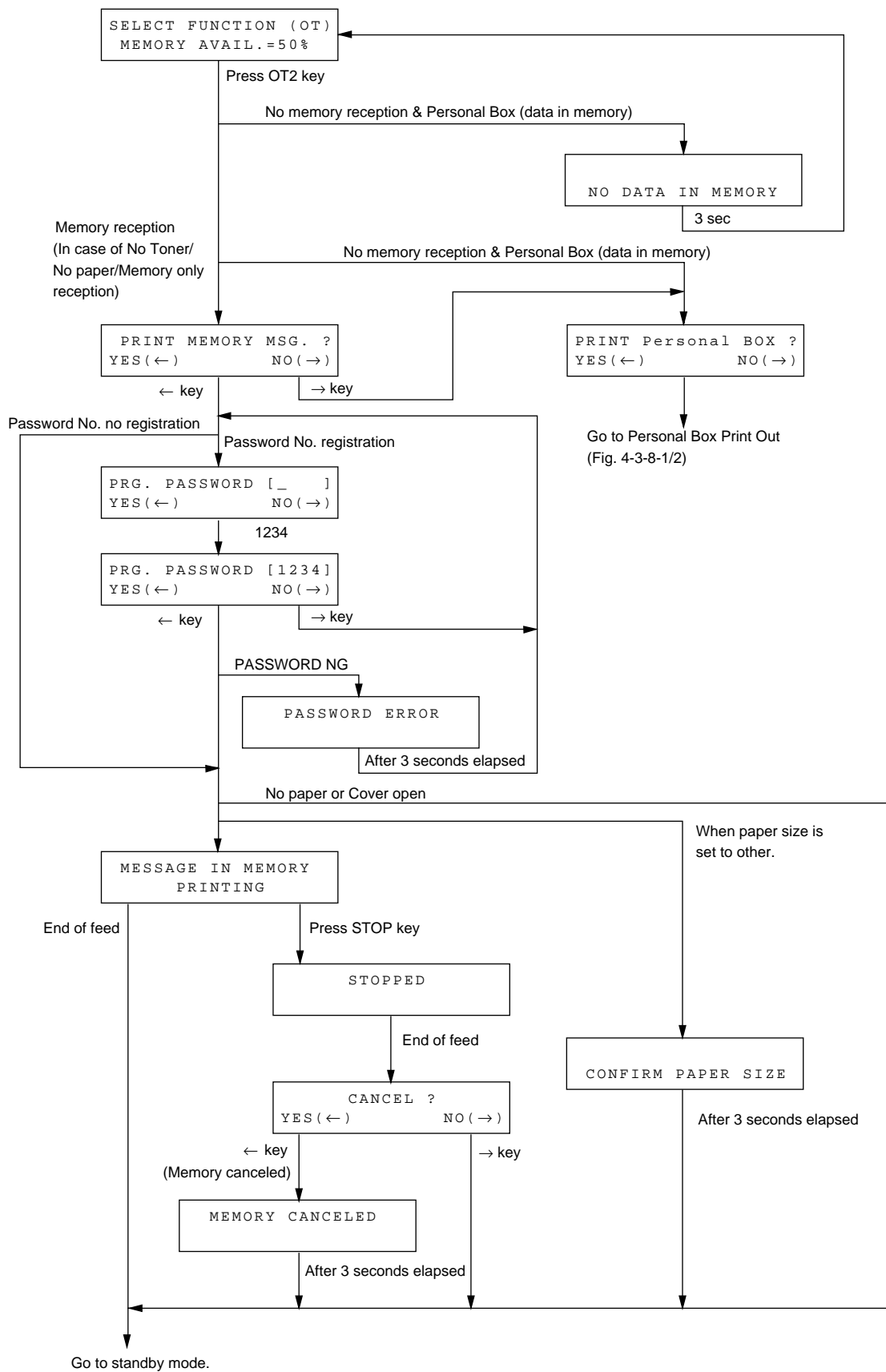

Fig. 4-3-8-2/2 Memory Message Print Out

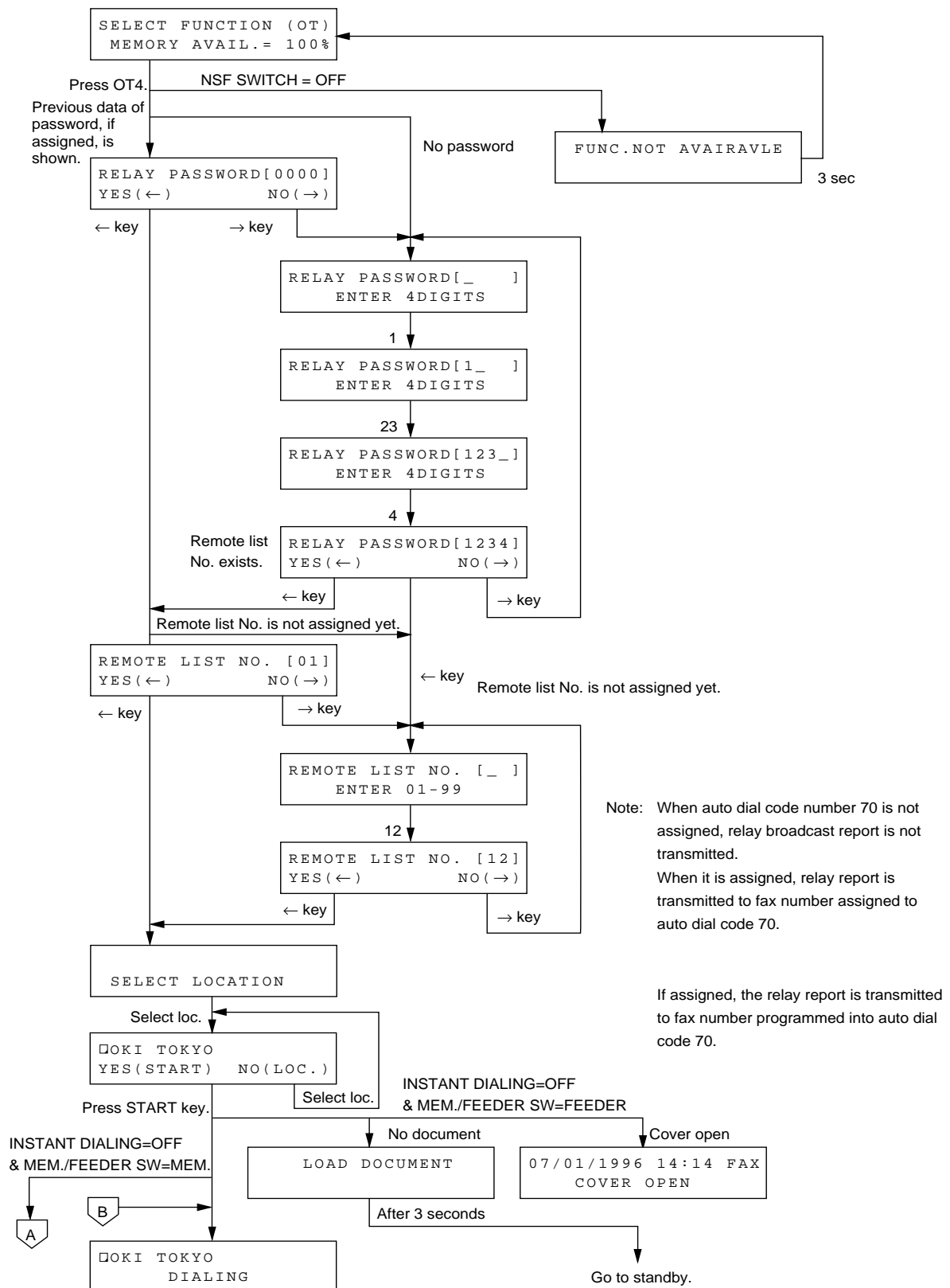
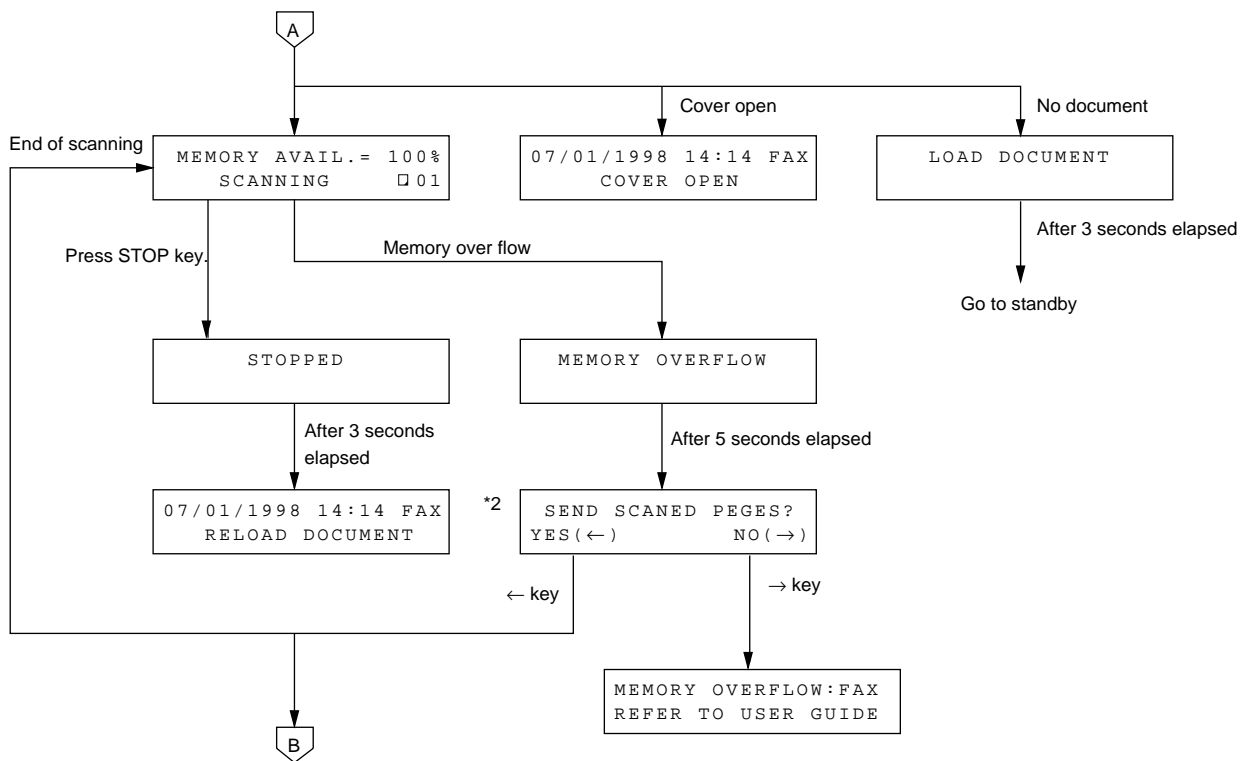

Fig. 4-3-10-1/2 Relay Broadcast Initiate



*2) Shifting automatically to the following processing according to MEM FULL SAVE setting after 59 seconds timeout.

Fig. 4-3-10-2/2 Relay Broadcast Initiate

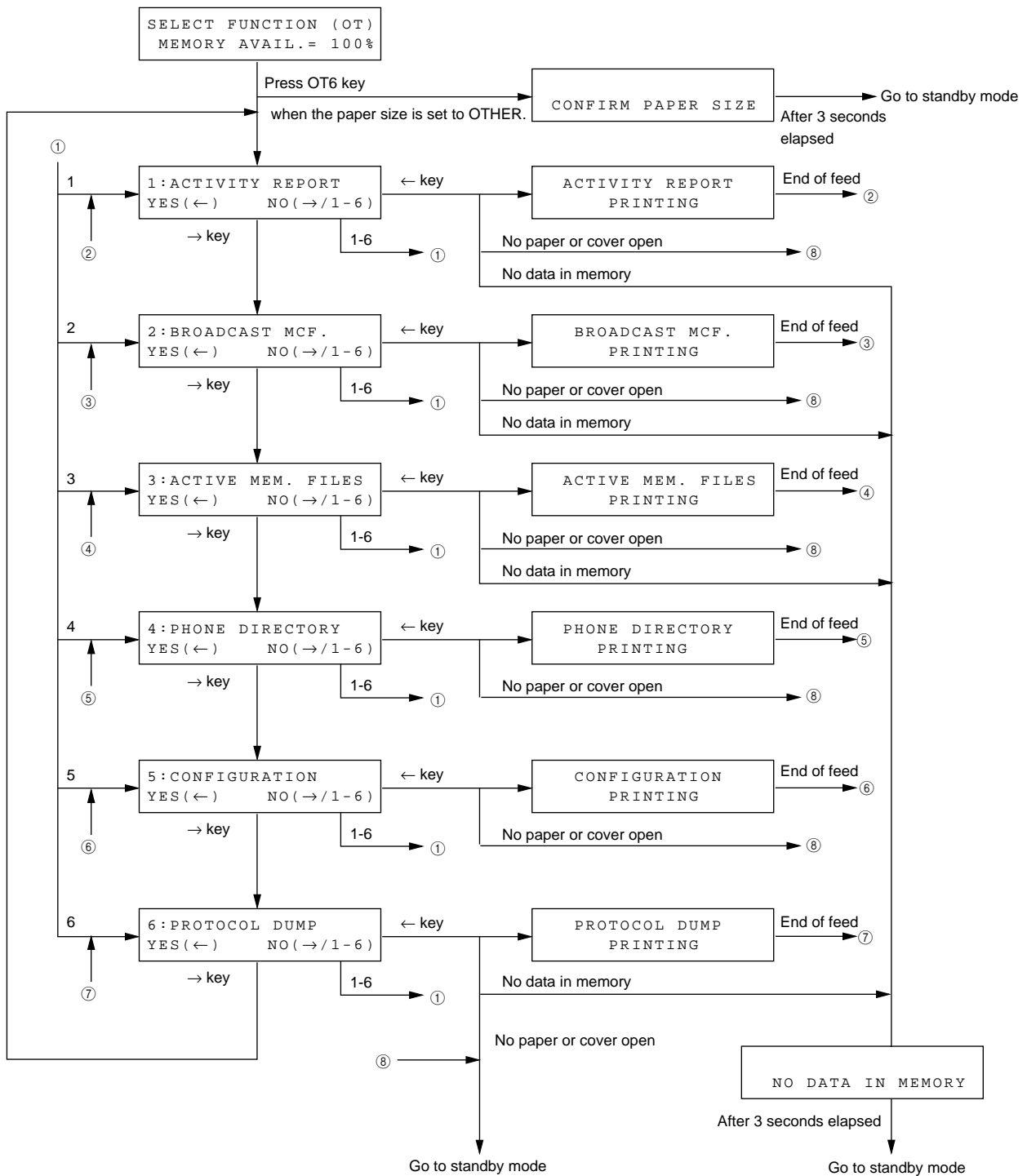

Fig. 4-3-12-1/2 Report Print (In case of Service bit = OFF)

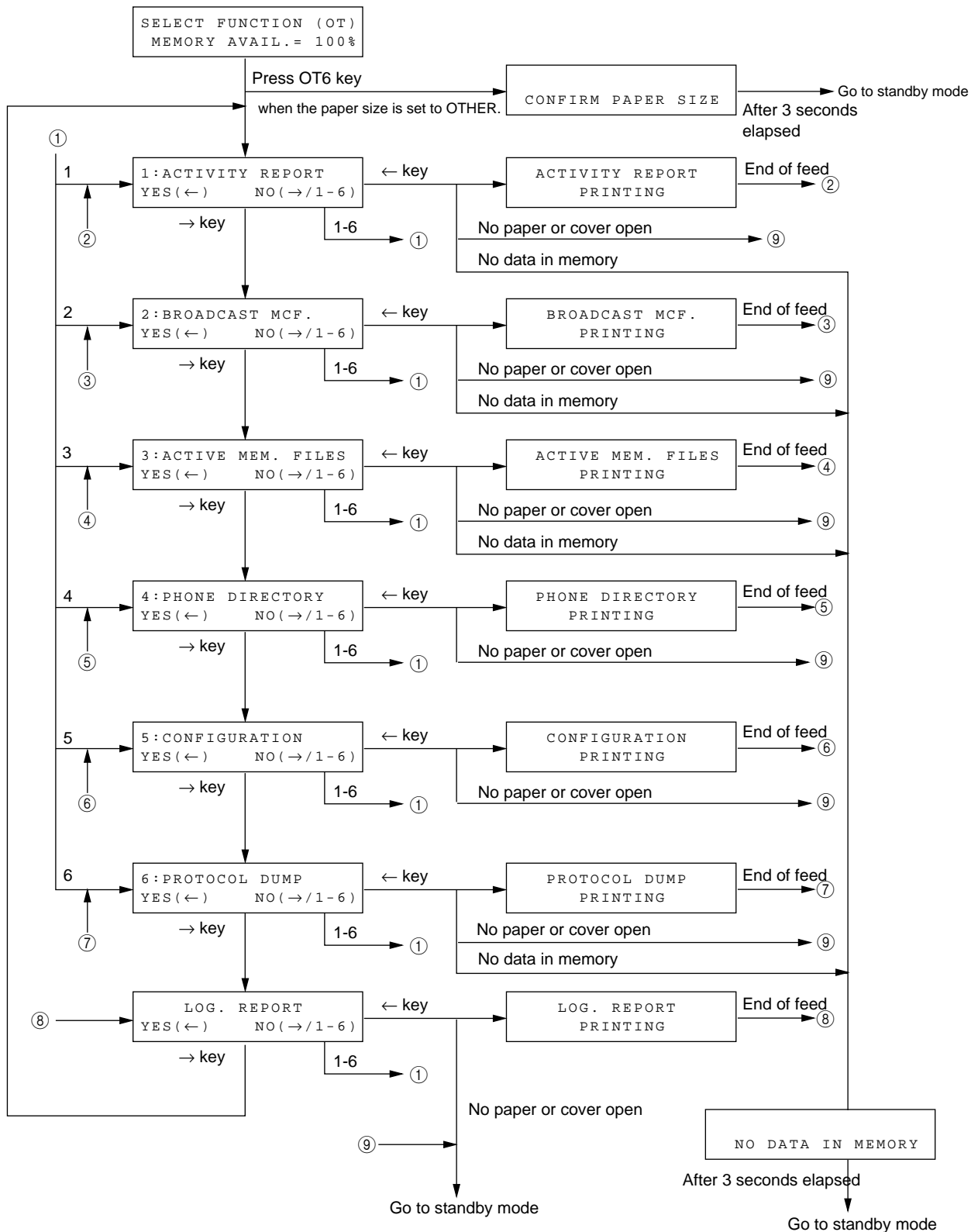
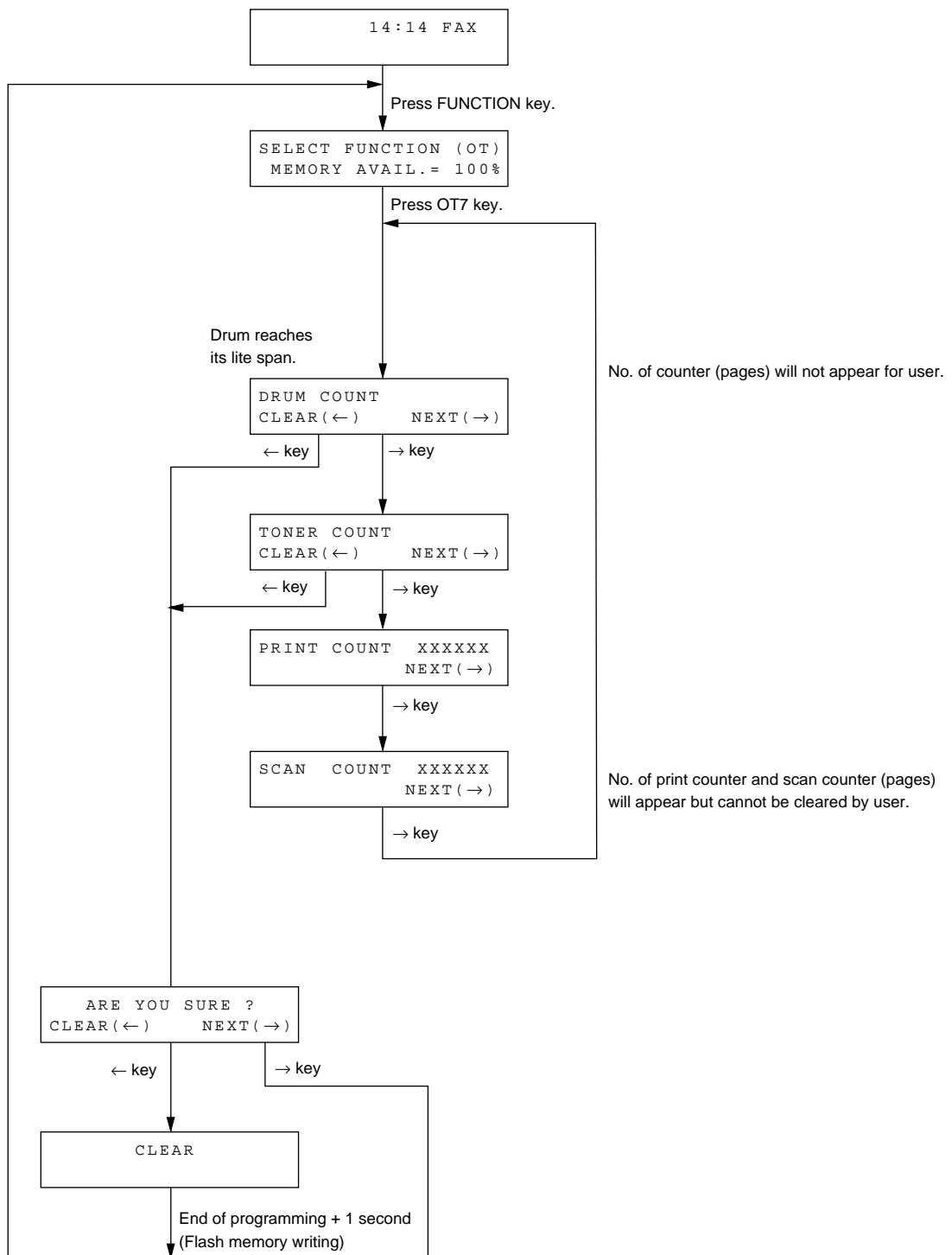

Fig. 4-3-12-2/2 Report Print (In case of Service bit = ON)



Clear Operation: User can clear only DRUM counter.
When the drum has reached its life span, LCD shows REPLACE I/D UNIT. After having cleared the drum counter, warning message will be disappeared.

Fig. 4-3-13-1/3 Counter Display/Clear (In case of Service bit = OFF&TOWER COUNT CLEAR=ON)

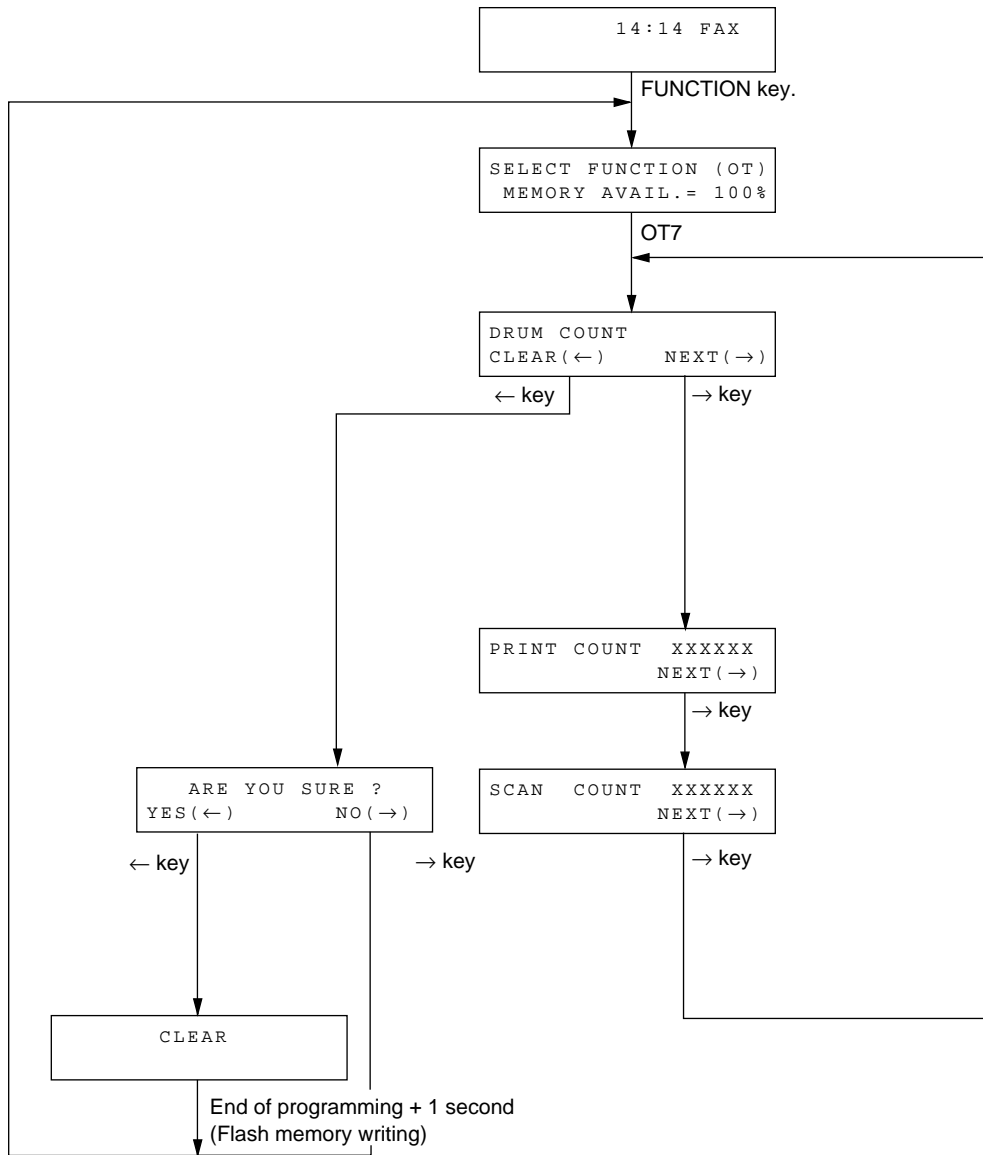

Fig. 4-3-13-2/3 Counter Display/Clear (In case of service bit = OFF and Toner Counter Clear = OFF)

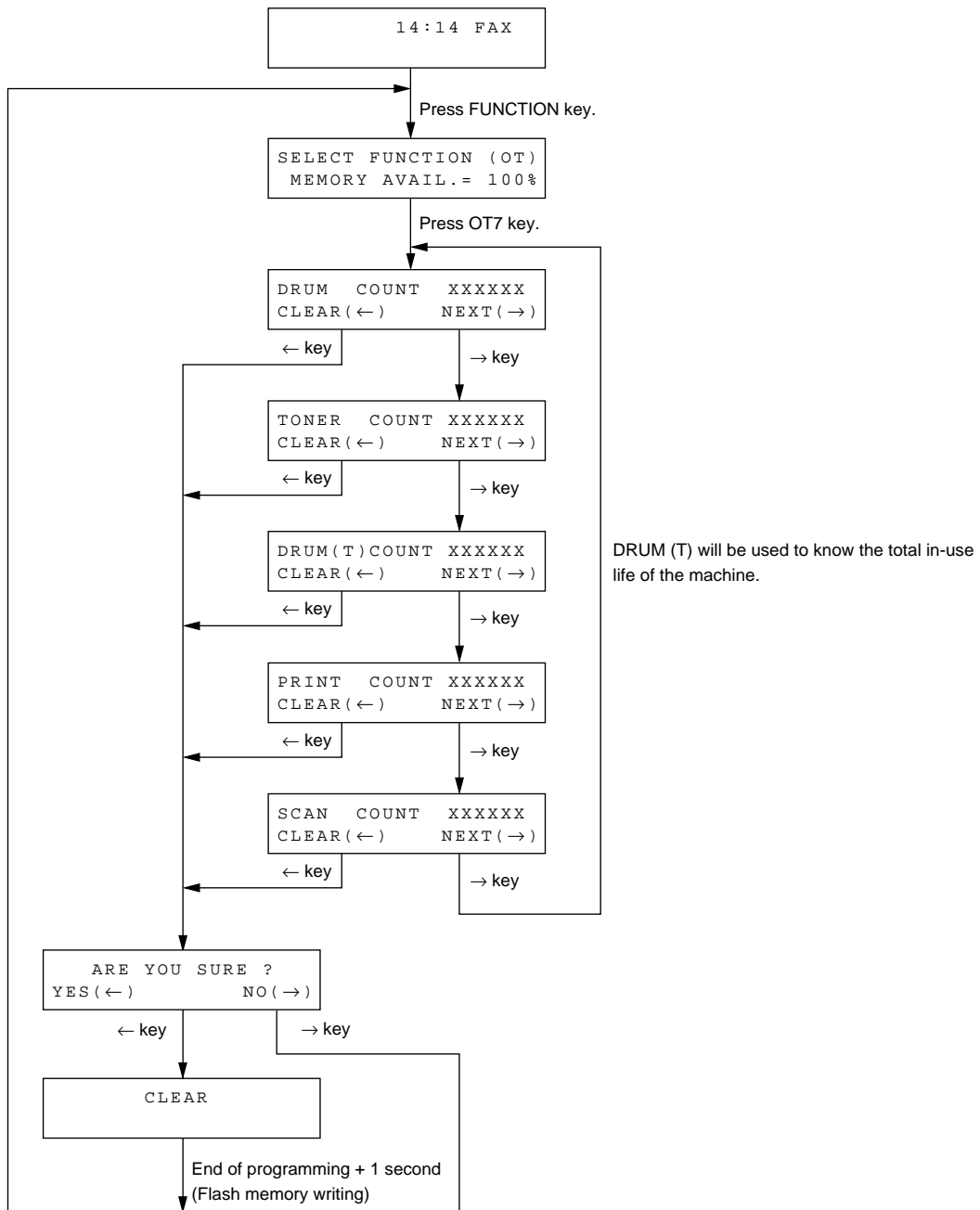

Fig. 4-3-13-3/3 Counter Display/Clear (In case of Service bit = ON)

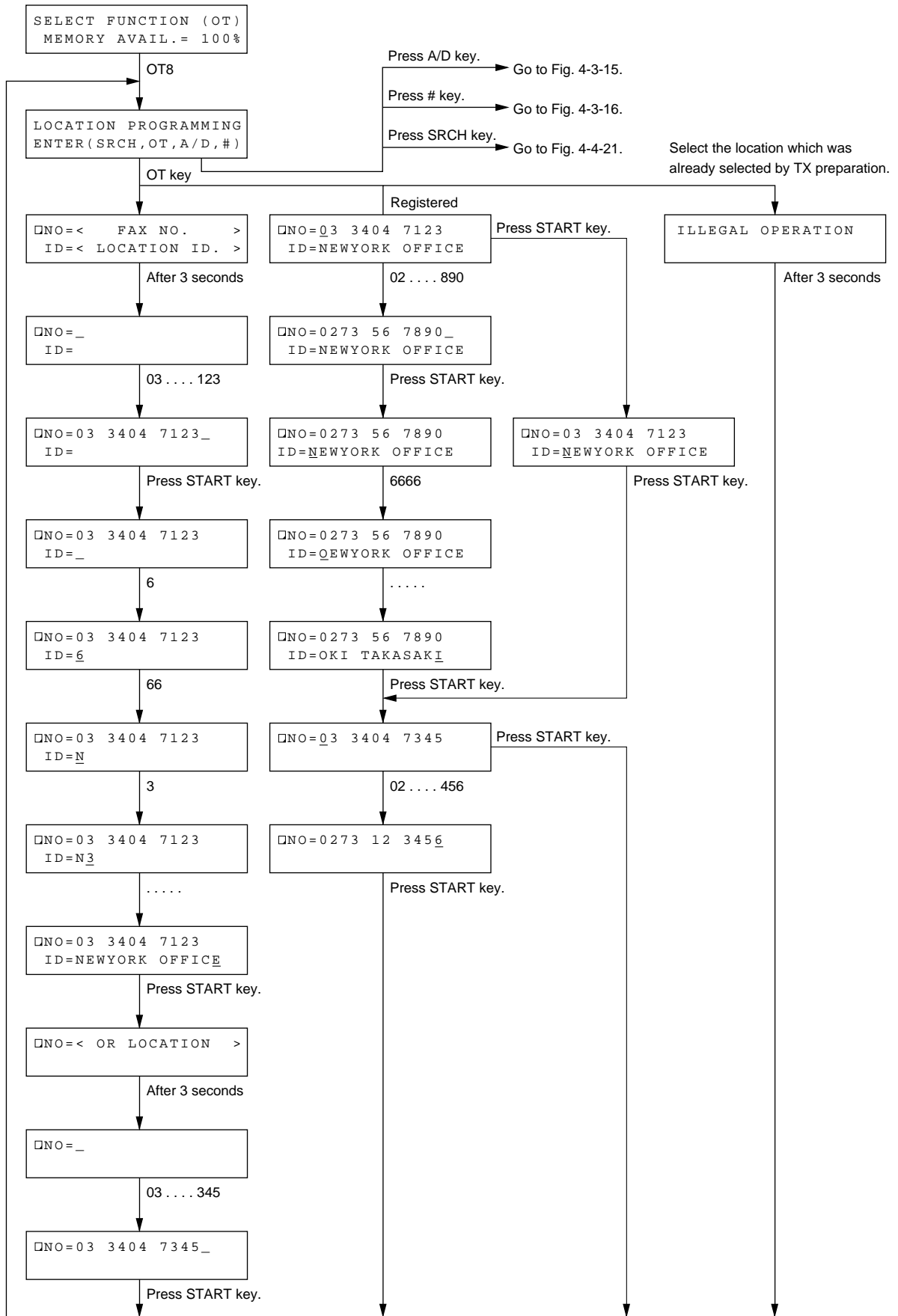

Fig. 4-3-14 One Touch Programming

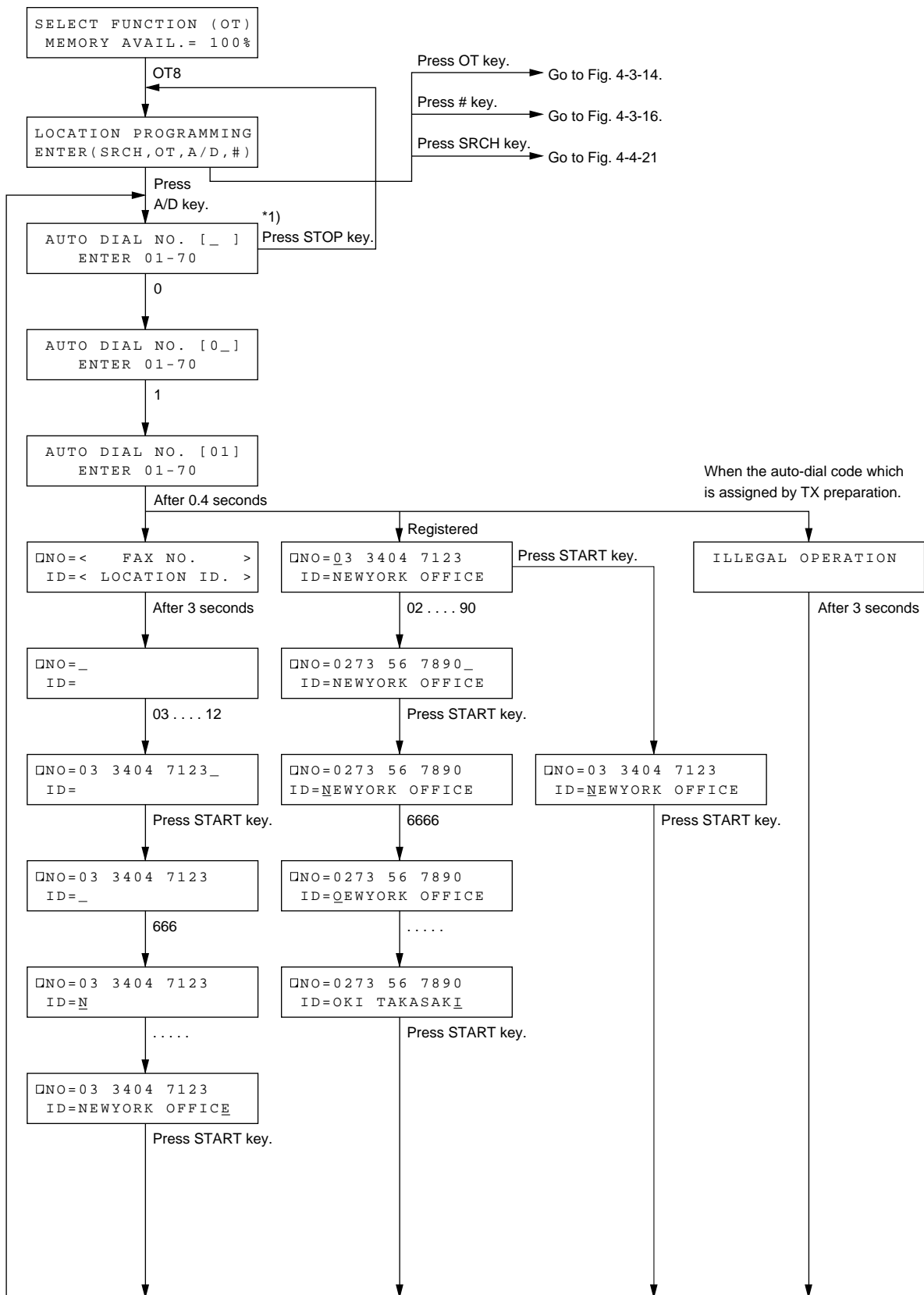

Fig. 4-3-15 Auto-dial Programming

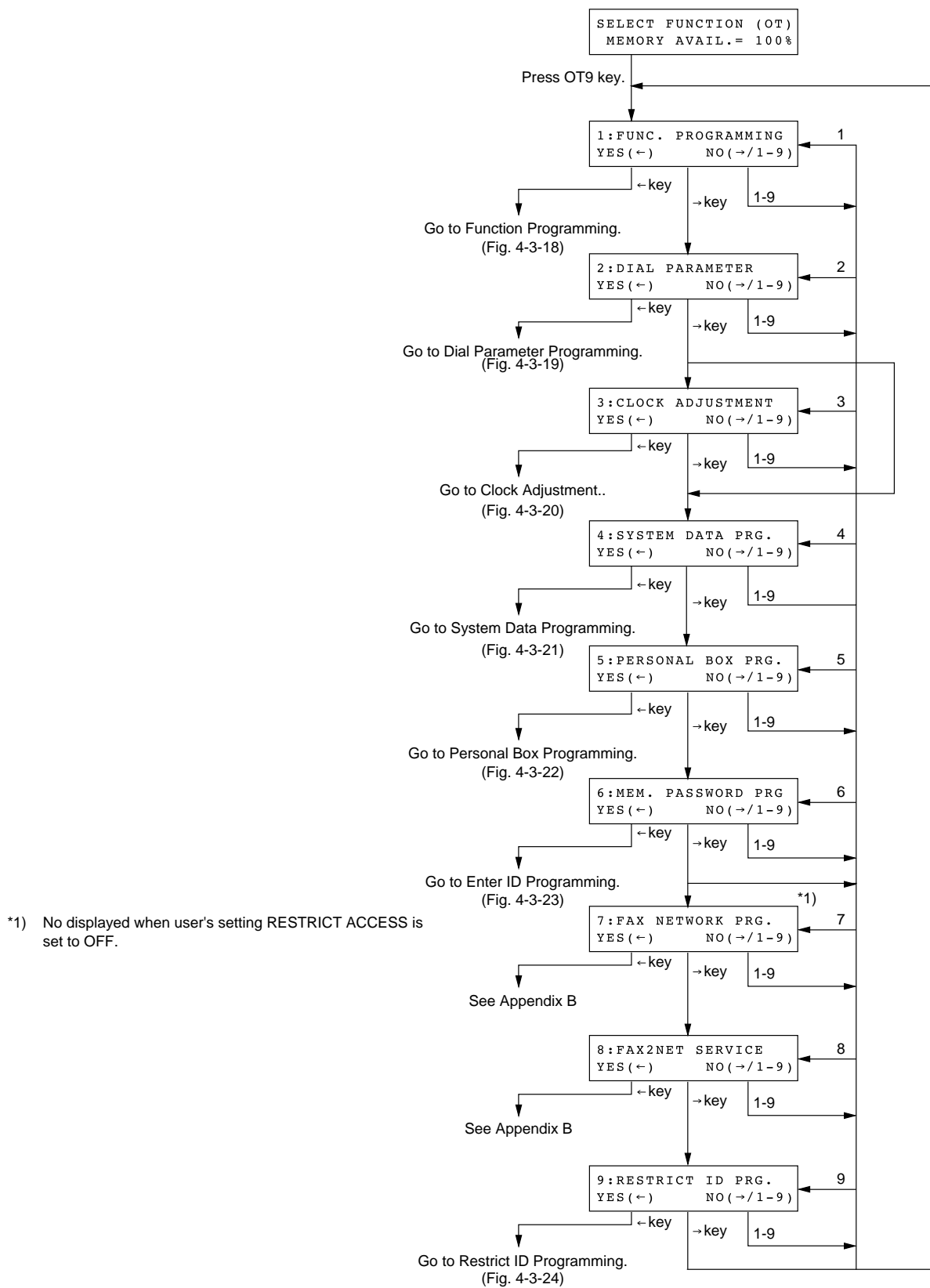

Fig. 4-3-17 User Function Programming

Function Programming

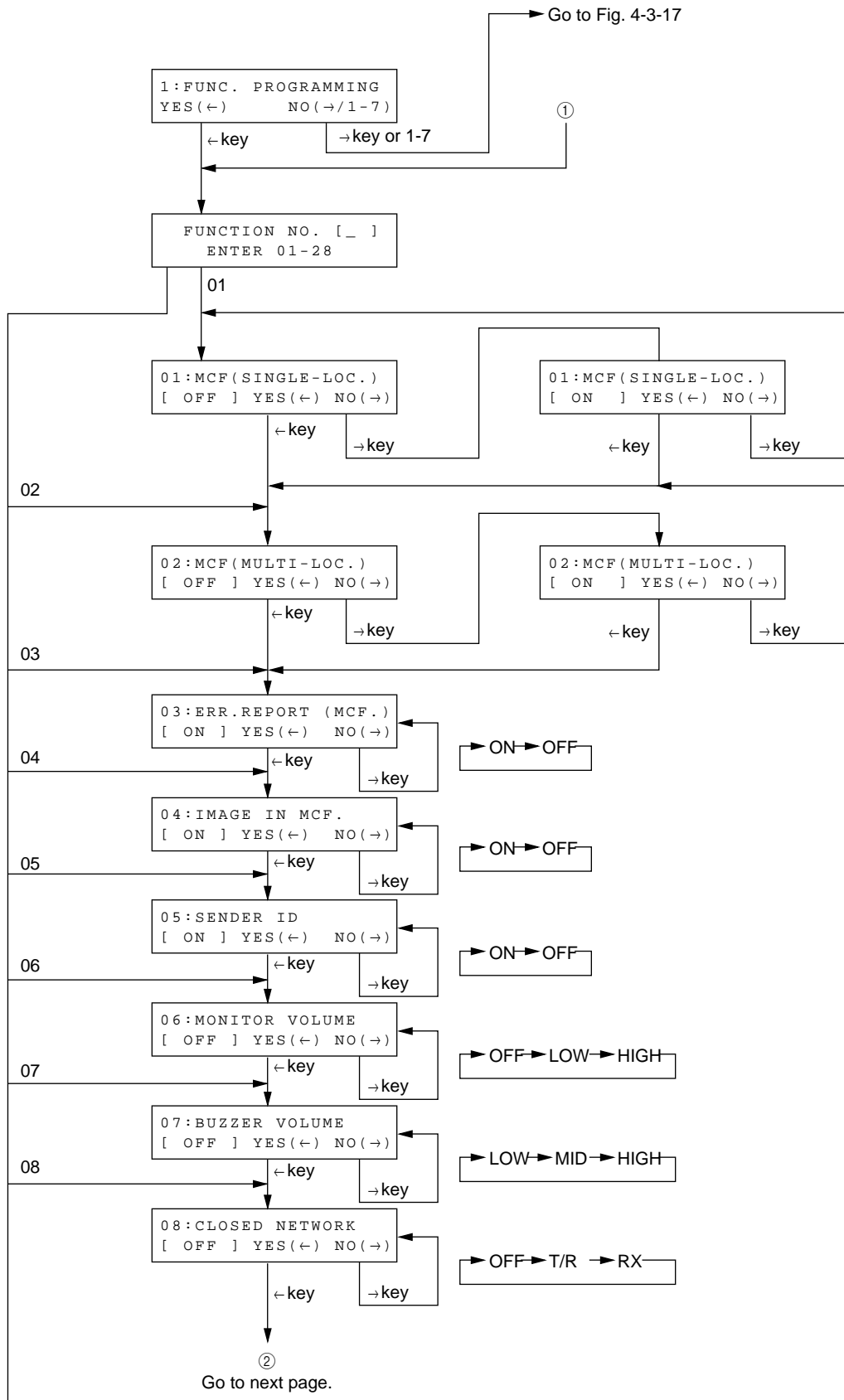

Fig. 4-3-18-1/4 Function Programming

Function Programming

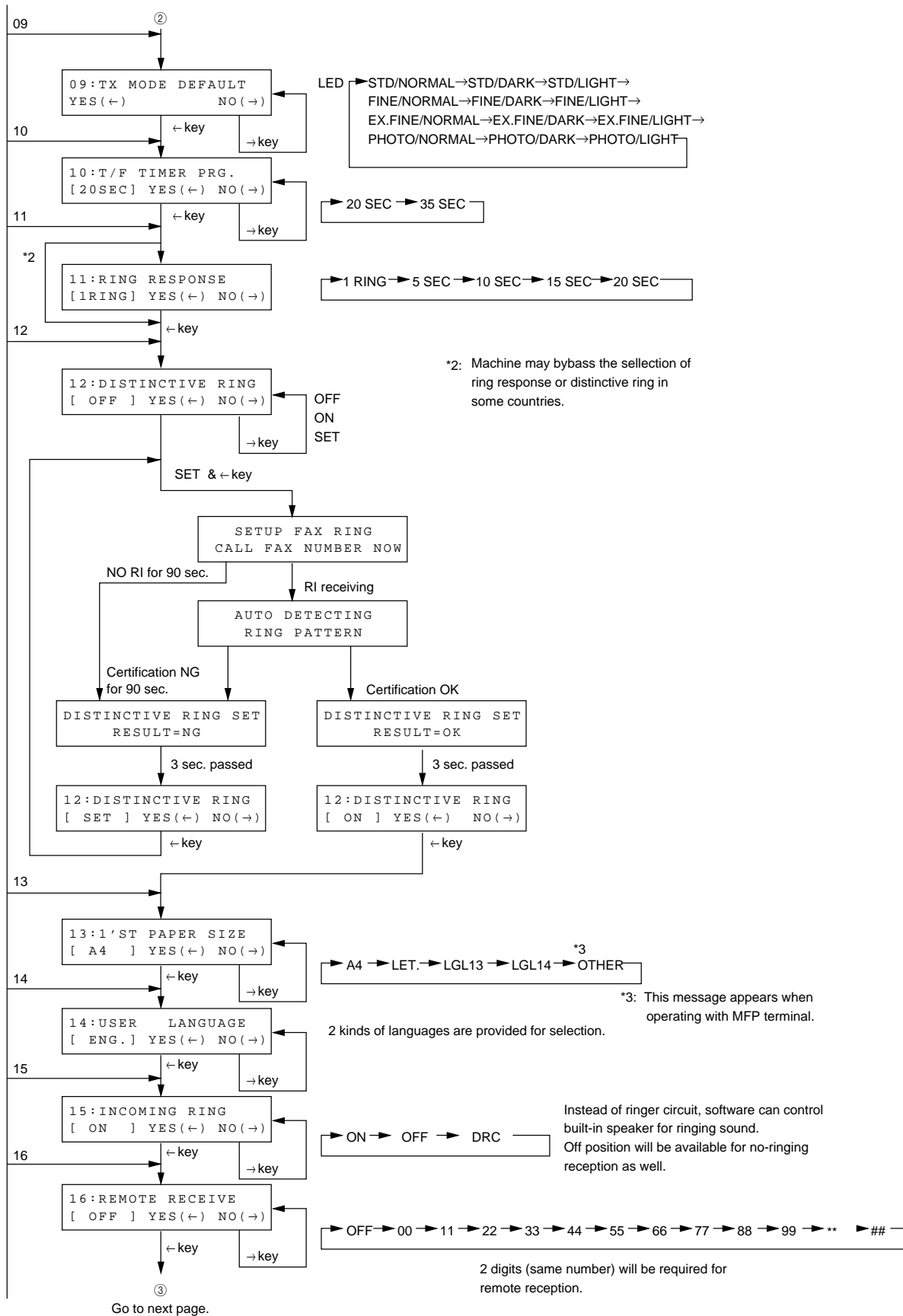

Fig. 4-3-18-2/4 Function Programming

Function Programming

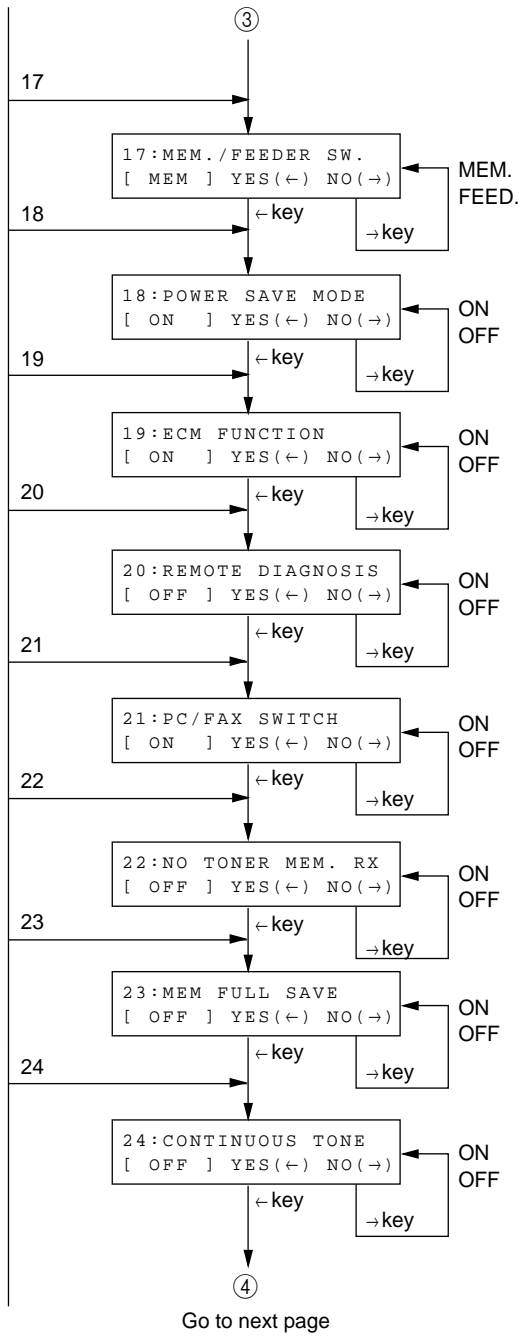
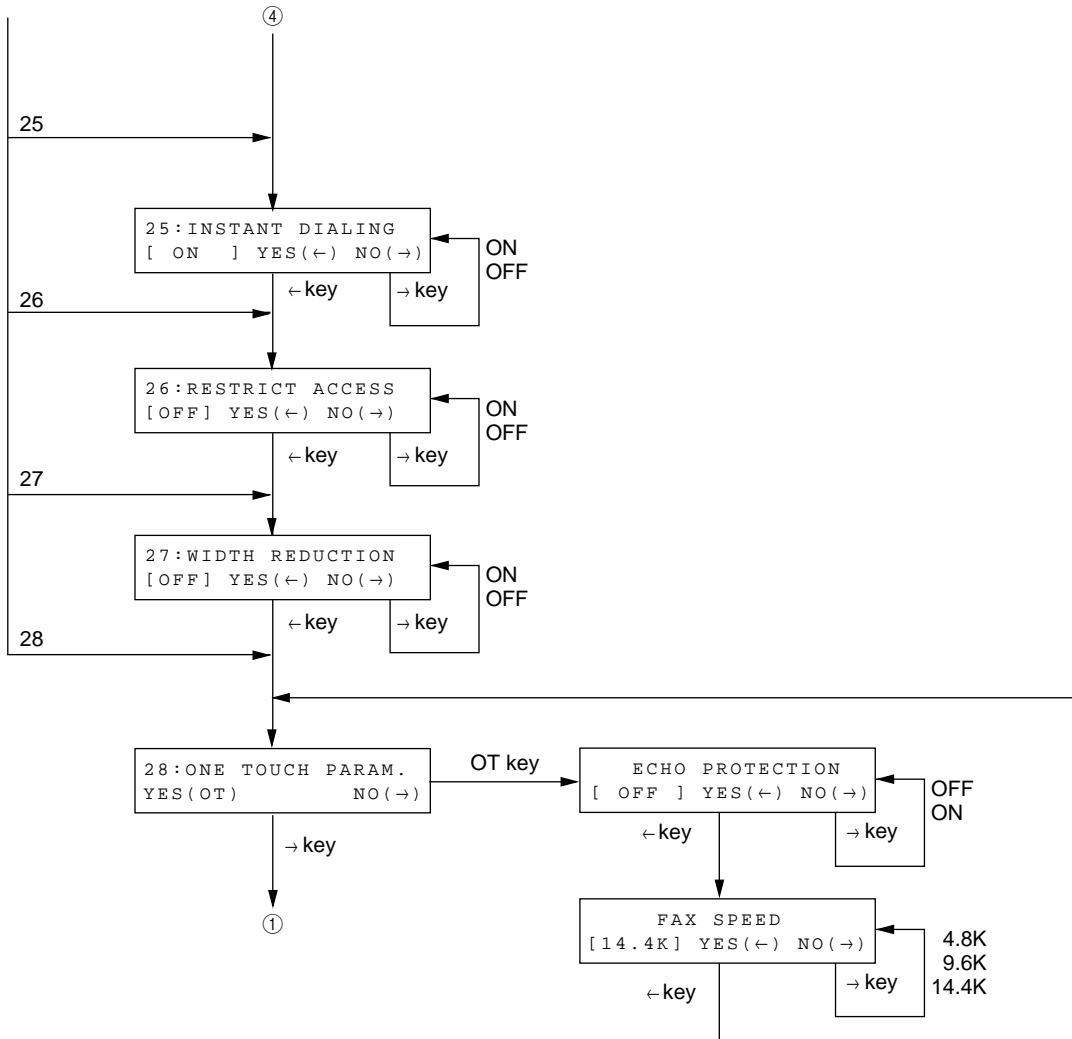

Fig. 4-3-18-3/4 Function Programming

Function Programming



Note) The machine makes the numeric key setting other than 01 to 26 invalid. In each of setting status indication, the machine does not allow the shift to the next setting by pressing numeric keys.

Fig. 4-3-18-4/4 Function Programming

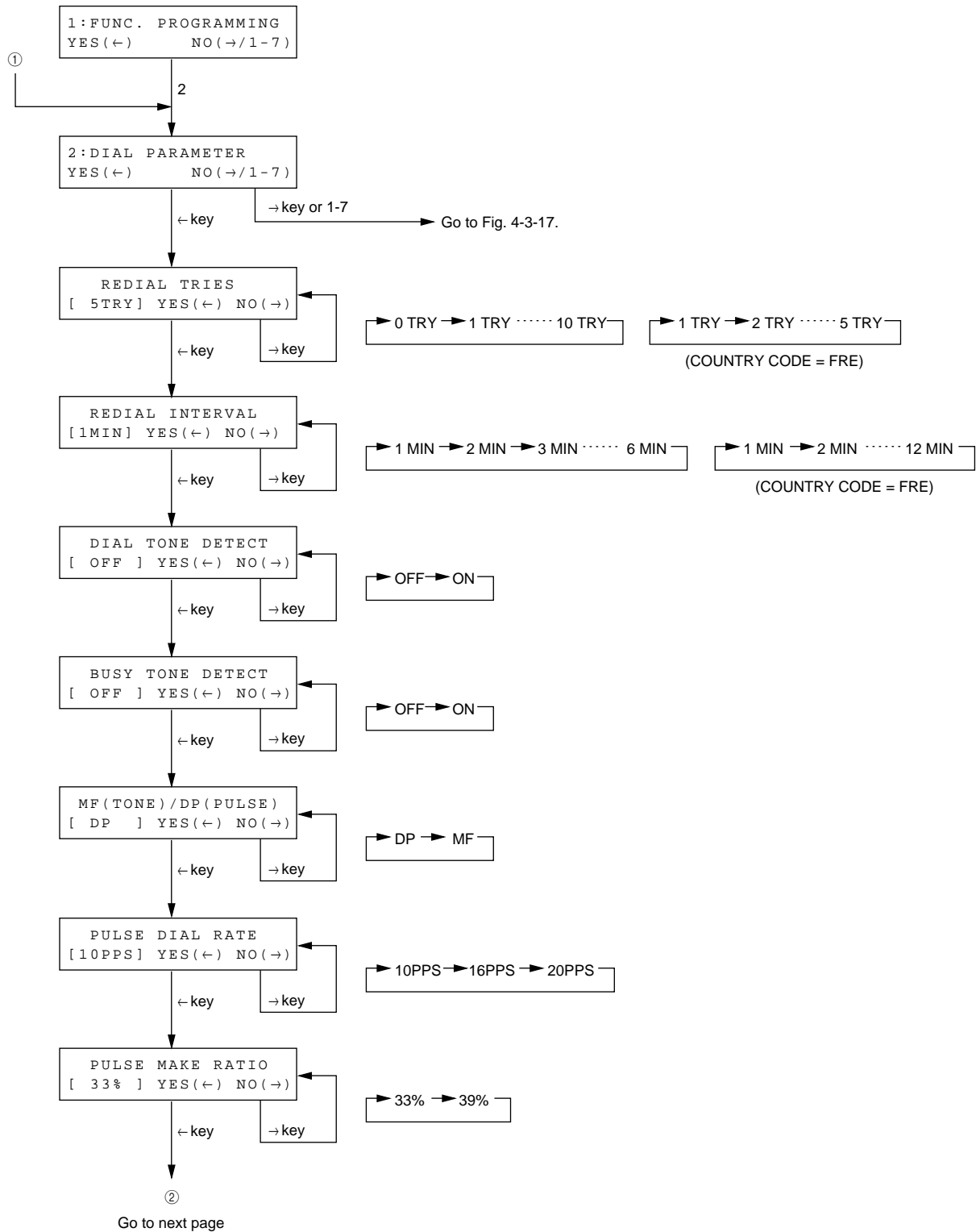

Fig. 4-3-19-1/4 Dial Parameters

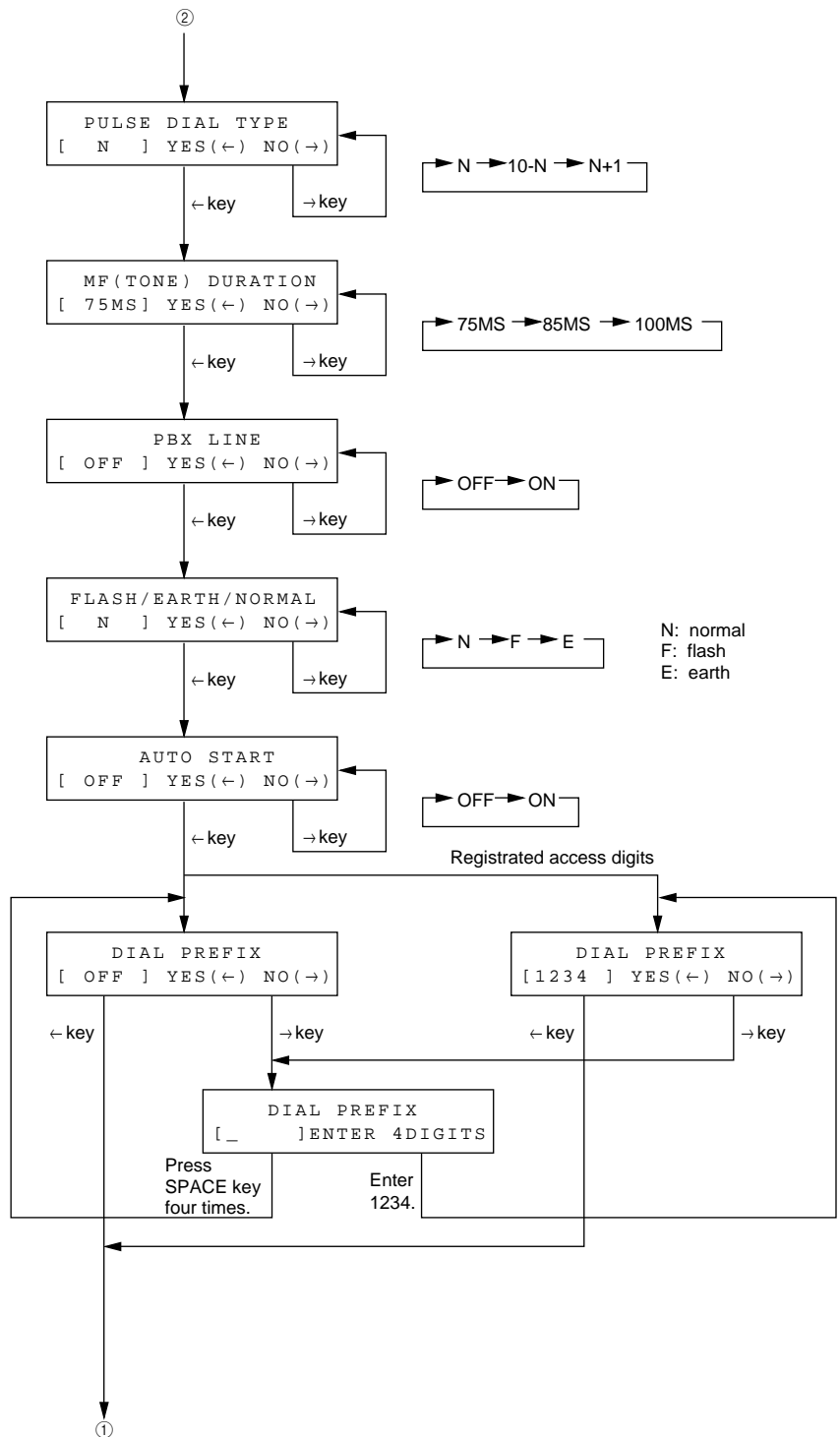

Fig. 4-3-19-2/4 Dial Parameters

Comparison List for all Versions

COUNTRY CODE	USA	INT	GBR	IRL	NOR	SWE	FIN	DEN	GER	HUN	TCH	POL	SUI	AUT	BEL
CLOCK ADJUSTMENT	★	★	★	★	★	★	★	★	★	★	★	★	★	★	★
TSI PROG.	★	★	★	★	★	★	★	★	★	★	★	★	★	★	★
SENDER ID	★	★	★	★	★	★	★	★	★	★	★	★	★	★	★
FORWARDING NO. PRG.	★	★	★	★	★	★	★	★	★	★	★	★	★	★	★
REDIAL TRIES	★	★			★	★	★		★	★	★	★	★	★	
REDIAL INTERVAL	★	★			★	★	★		★	★	★	★	★	★	★
DIAL TONE DETECT	★														
BUSY TONE DETECT	★								★				★	★	
MF/DP	★	★	★	★			★	★	★	★	★	★	★	★	★
PULSE DIAL RATE															
PULSE MAKE RATIO															
PULSE DIAL TYPE															
MF DURATION															
PBX LINE	★	★	★	★	★	★	★	★	★	★	★	★	★	★	★
PBX TYPE					★				★				★	★	
AUTO START	★	★	★	★	★	★	★	★	★	★	★	★	★	★	★
DIAL PREFIX	★	★	★	★	★	★	★	★	★	★	★	★	★	★	★

★ marked items setting are available by user.
 Blanked item's setting are available by serviceman (LCD shows the blanked parameter when the service bit=ON)
 CLOCK ADJUSTMENT is related to xparae and REDIAL TIMES ~ DIAL PREFIX are related to xparad.

Note: The contents of tables are subject to change by the requests of OEM companies and customers without notice.

Fig. 4-3-19-3/4 Dial Parameters (1)

Comparison List for all Versions

COUNTRY CODE	HOL	FRE	POR	ESP	ITA	GRE	AUS	NZL	SIN	HNG	LTA	MEX
CLOCK ADJUSTMENT	★	★	★	★	★	★	★	★	★	★	★	★
TSI PROG.	★	★	★	★	★	★	★	★	★	★	★	★
SENDER ID	★	★	★	★	★	★	★	★	★	★	★	★
FORWARDING NO. PRG.	★	★	★	★	★	★	★	★	★	★	★	★
REDIAL TRIES	★				★						★	★
REDIAL INTERVAL	★				★						★	★
DIAL TONE DETECT		★									★	★
BUSY TONE DETECT		★									★	★
MF/DP		★	★	★	★	★	★	★	★	★	★	★
PULSE DIAL RATE												
PULSE MAKE RATIO												
PULSE DIAL TYPE												
MF DURATION												
PBX LINE	★	★	★	★	★						★	★
PBX TYPE		★			★							
AUTO START	★	★	★	★	★	★	★	★	★	★	★	★
DIAL PREFIX	★	★	★	★	★	★	★	★	★	★	★	★

★ marked items setting are available by user.
 Blanked item's setting are available by serviceman (LCD shows the blanked parameter when the service bit=ON)
 CLOCK ADJUSTMENT is related to xparae and REDIAL TIMES ~ DIAL PREFIX are related to xparad.

Note: The contents of tables are subject to change by the requests of OEM companies and customers without notice.

Fig. 4-3-19-4/4 Dial Parameters (2)

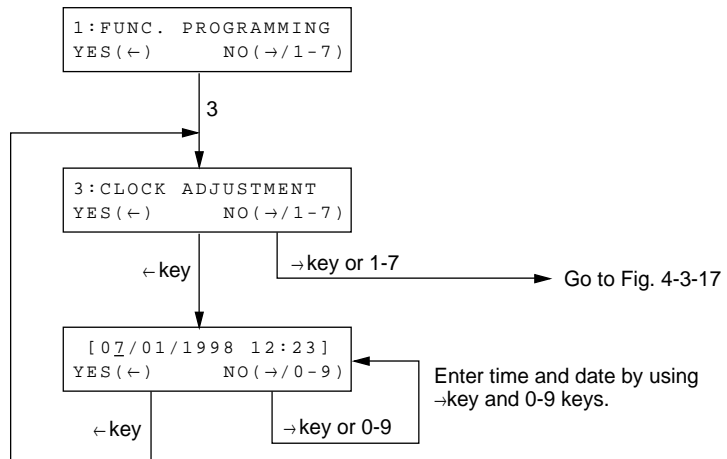

Fig. 4-3-20 Clock Adjustment

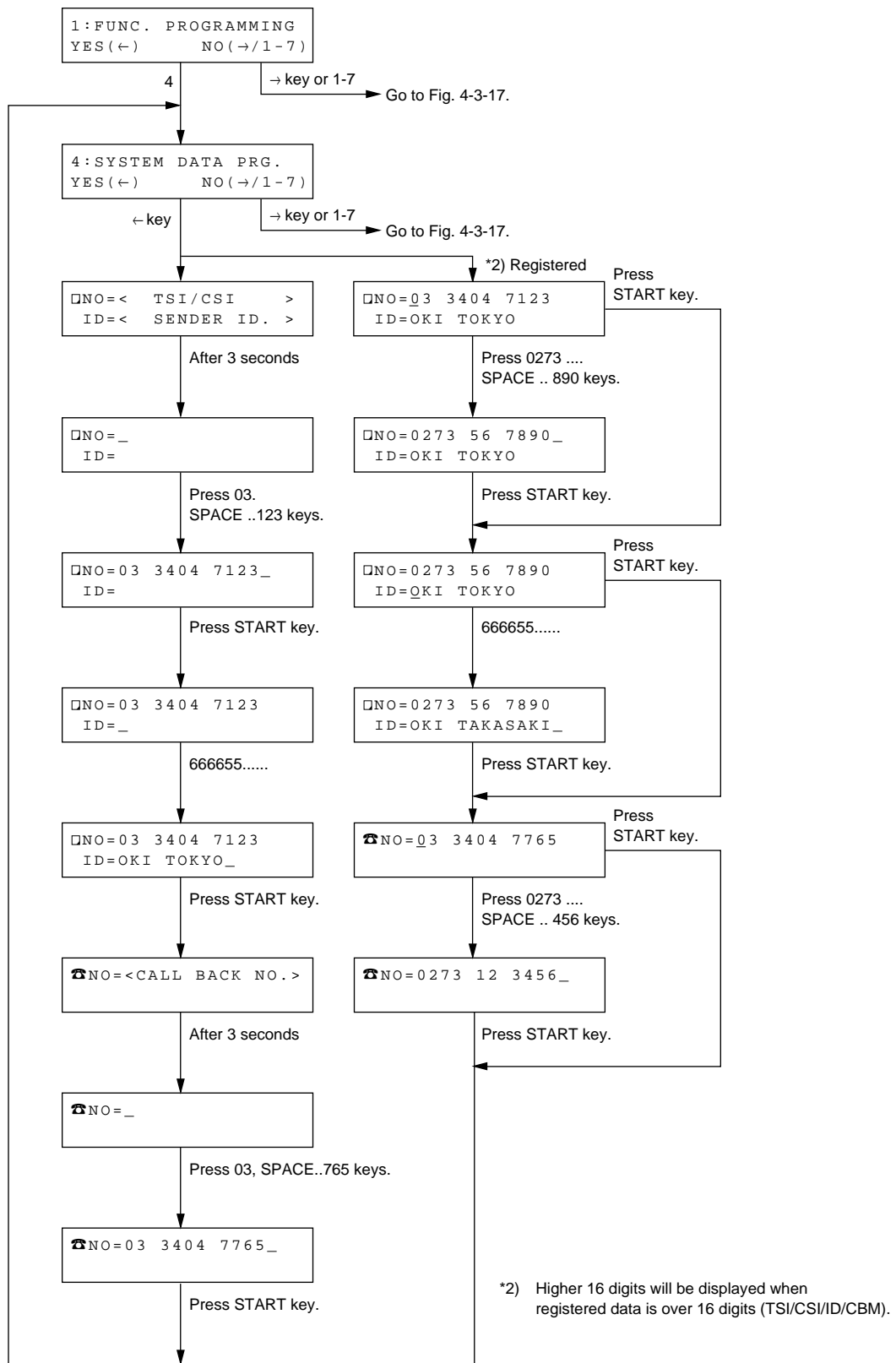
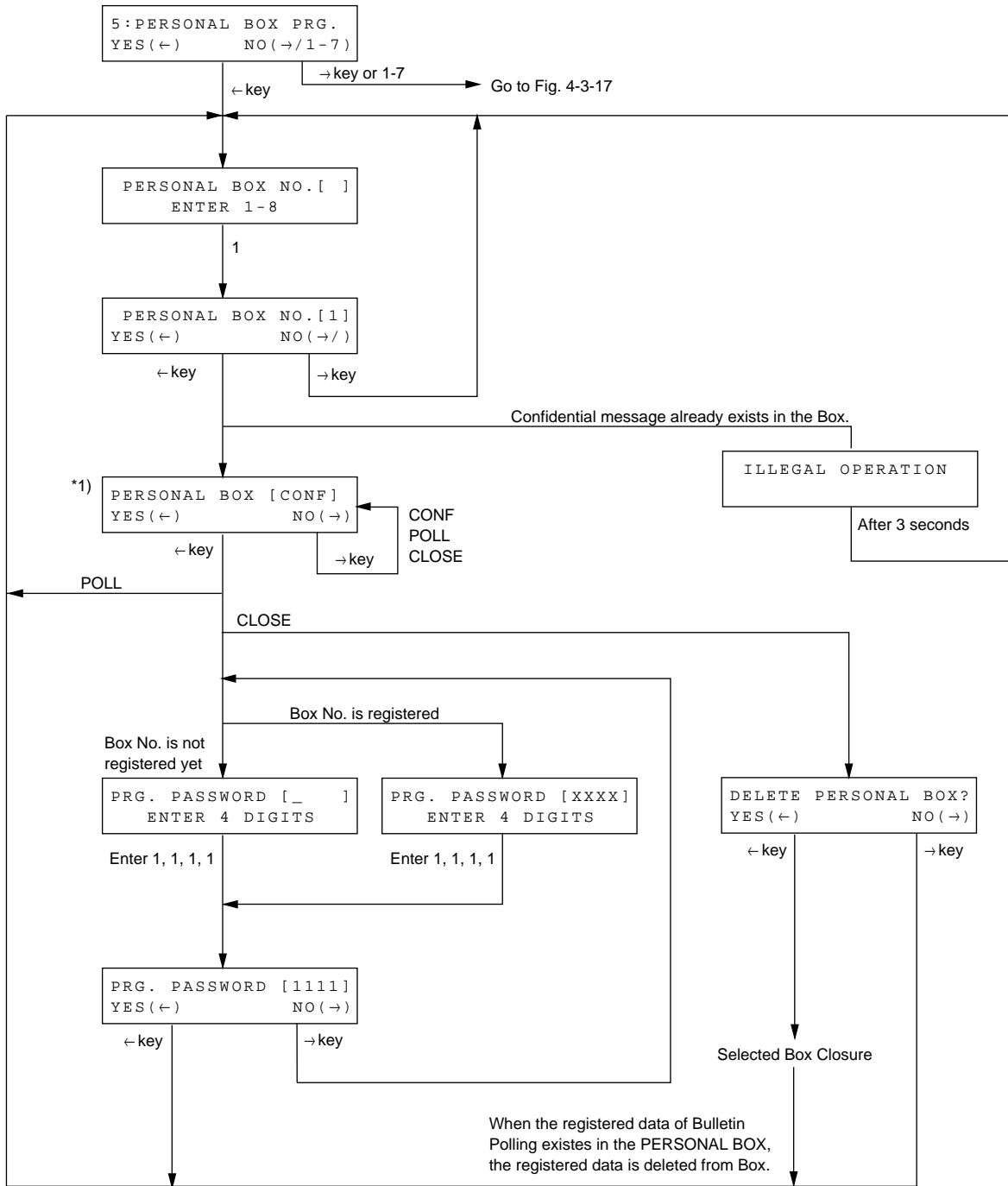

Fig. 4-3-21 System Data Programming



- *1 - Initial display when Box NO. is not opened.:
[CLOSE]; CONF/POLL/CLOSE are selectable.
- Displayed when BOX No. is opened for Bulletin POLL.:
[POLL]; POLL/CLOSE are selectable.
- Displayed when BOX No. is opened for Confidential.:
[CONF]; CONF/CLOSE are selectable.

Fig. 4-3-22 PERSONAL Box Programming

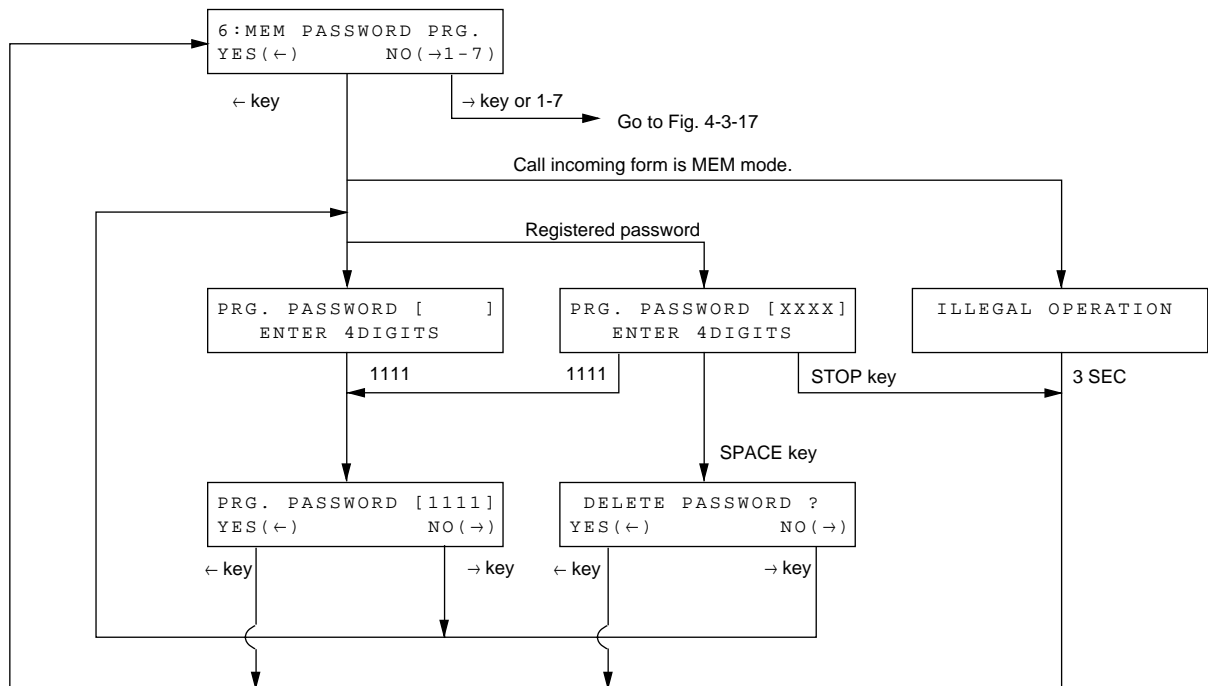
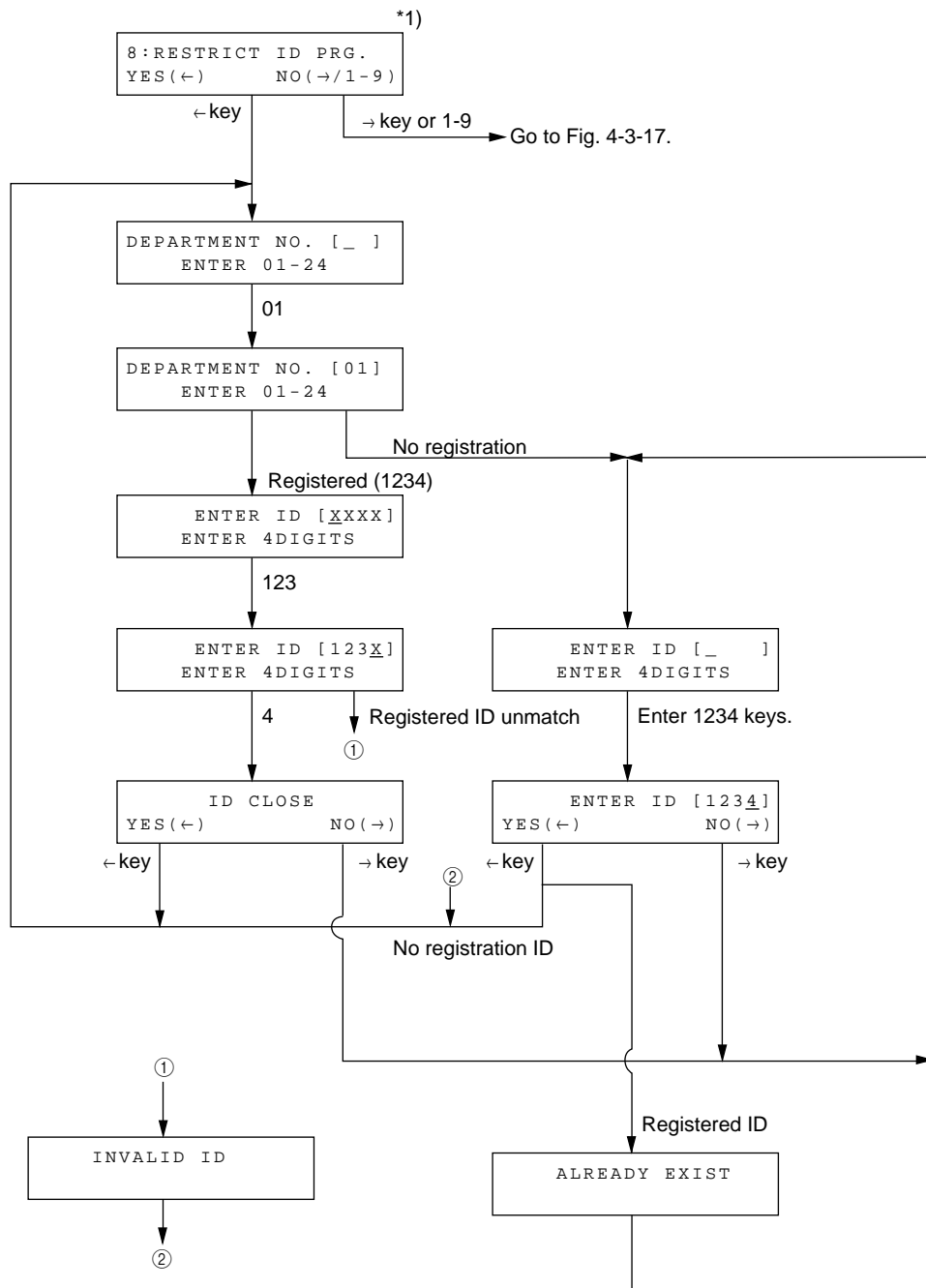

Fig. 4-3-23 Memory Password Programming



*1) Displayed when user's setting RESTRICT ACCESS is set to ON.

Fig. 4-3-24 Restrict ID Programming

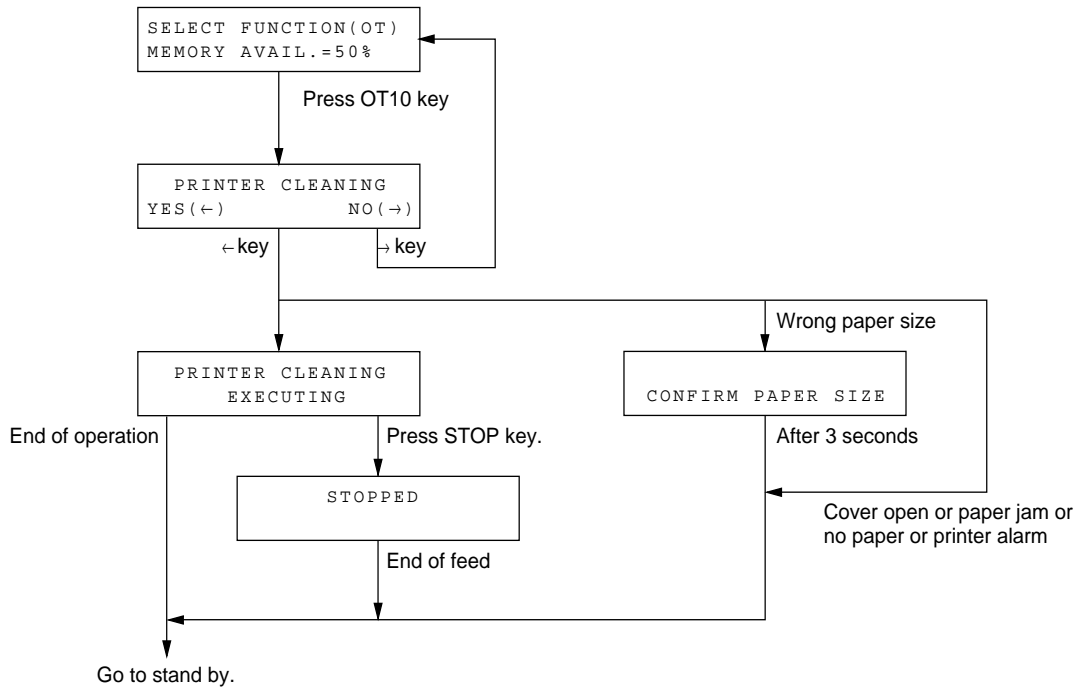

Fig. 4-3-25 Printer Cleaning Operation

4-4-3 AUTO REC Key Operation (When MEM.PASSWORD is not registered.)

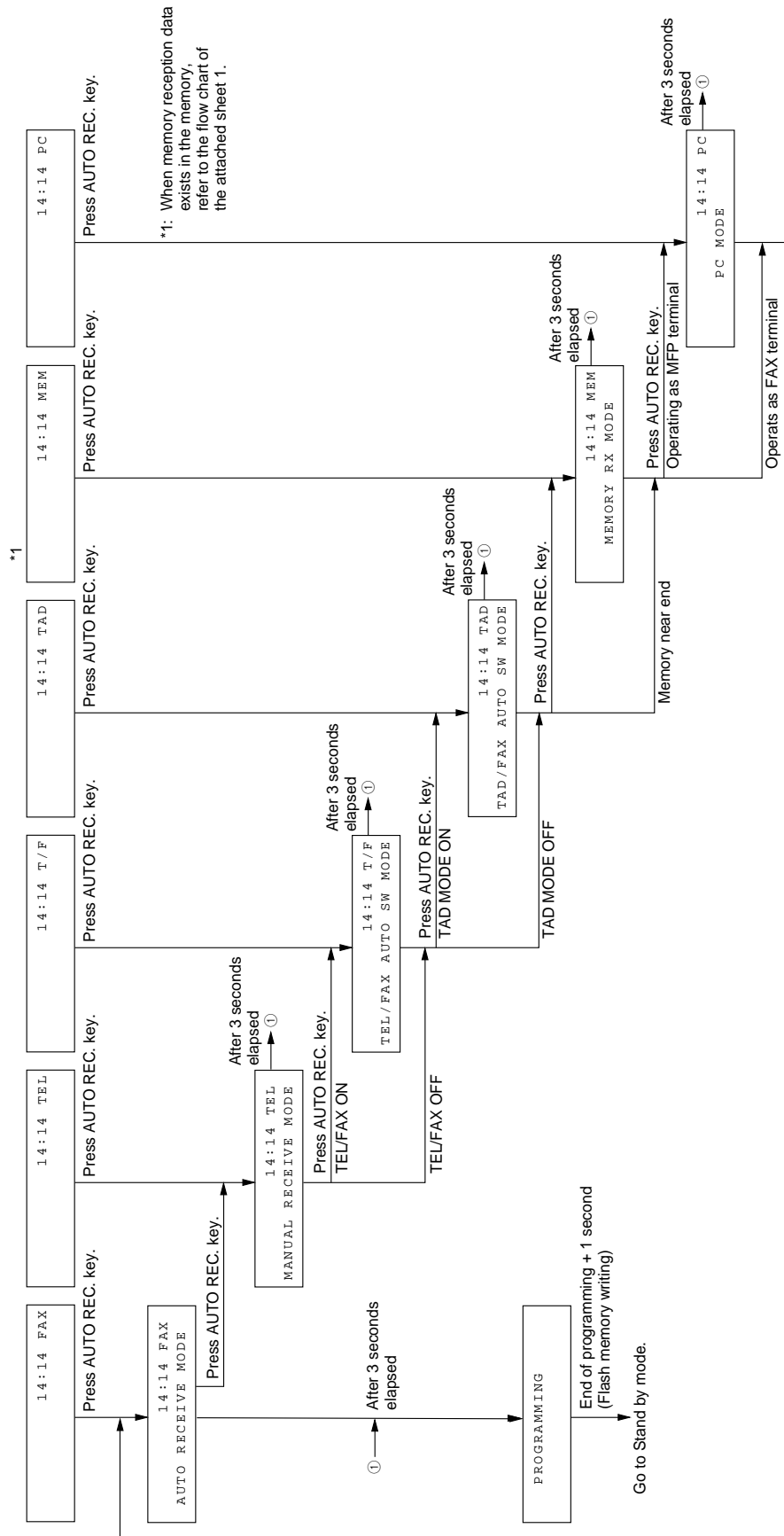
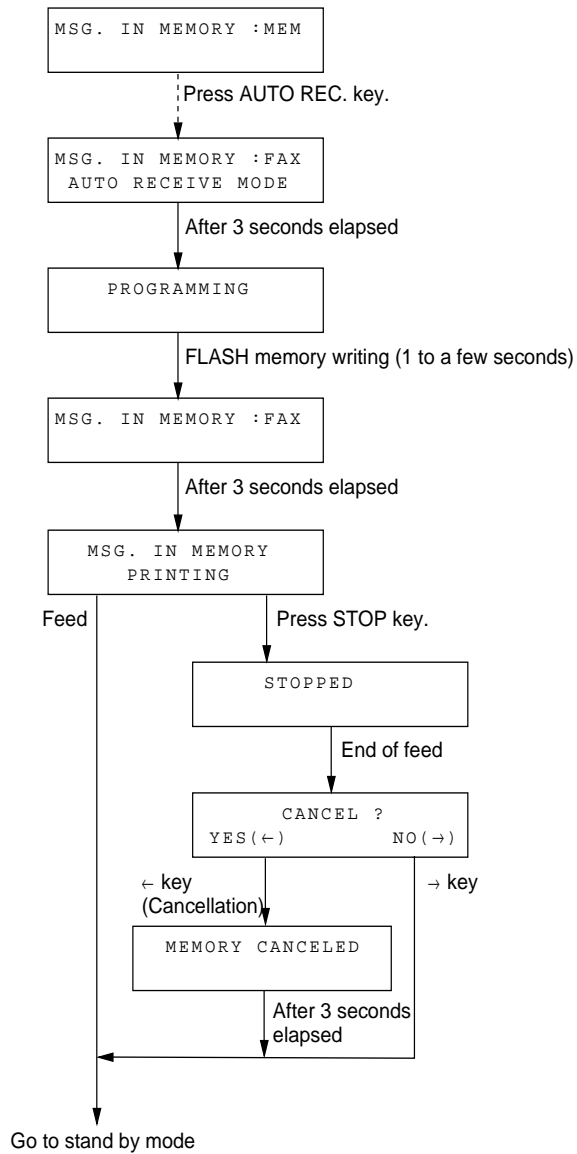

Fig. 4-4-3-1/3 AUTO REC Key Operation (When MEM.PASSWORD is not registered.)

Attached sheet 1



- The machine enables the manual printout of MSG. IN MEMORY data by using print operation (F key + OT2).

Fig. 4-4-3-2/3 AUTO REC Key Operation (Attached sheet 1)

4-4-3 AUTO REC Key Operation (When MEM.PASSWORD is registered.)

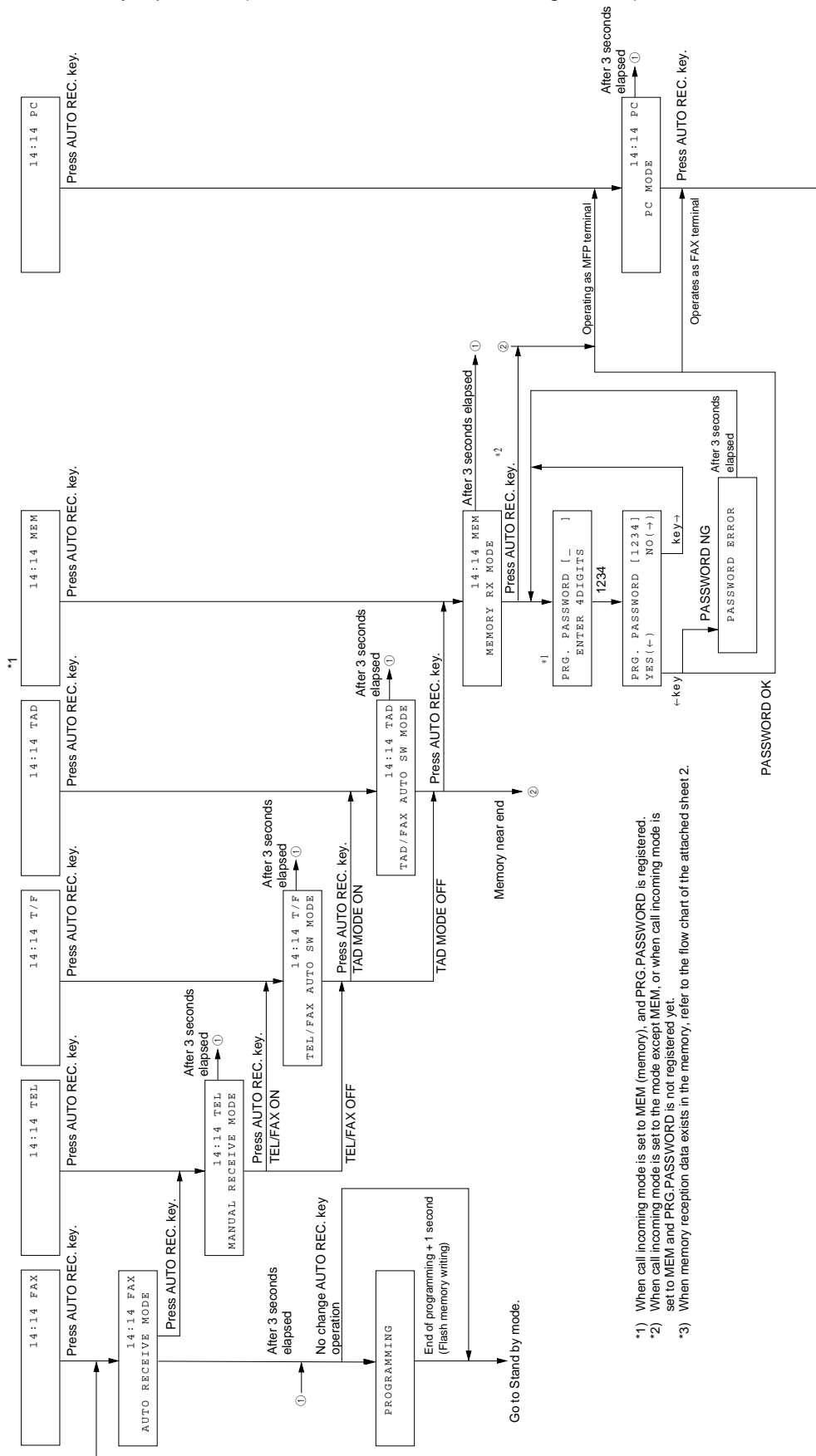

Fig. 4-4-3-3/3 AUTO REC Key Operation (When MEM.PASSWORD is registered.)

Attached sheet 2

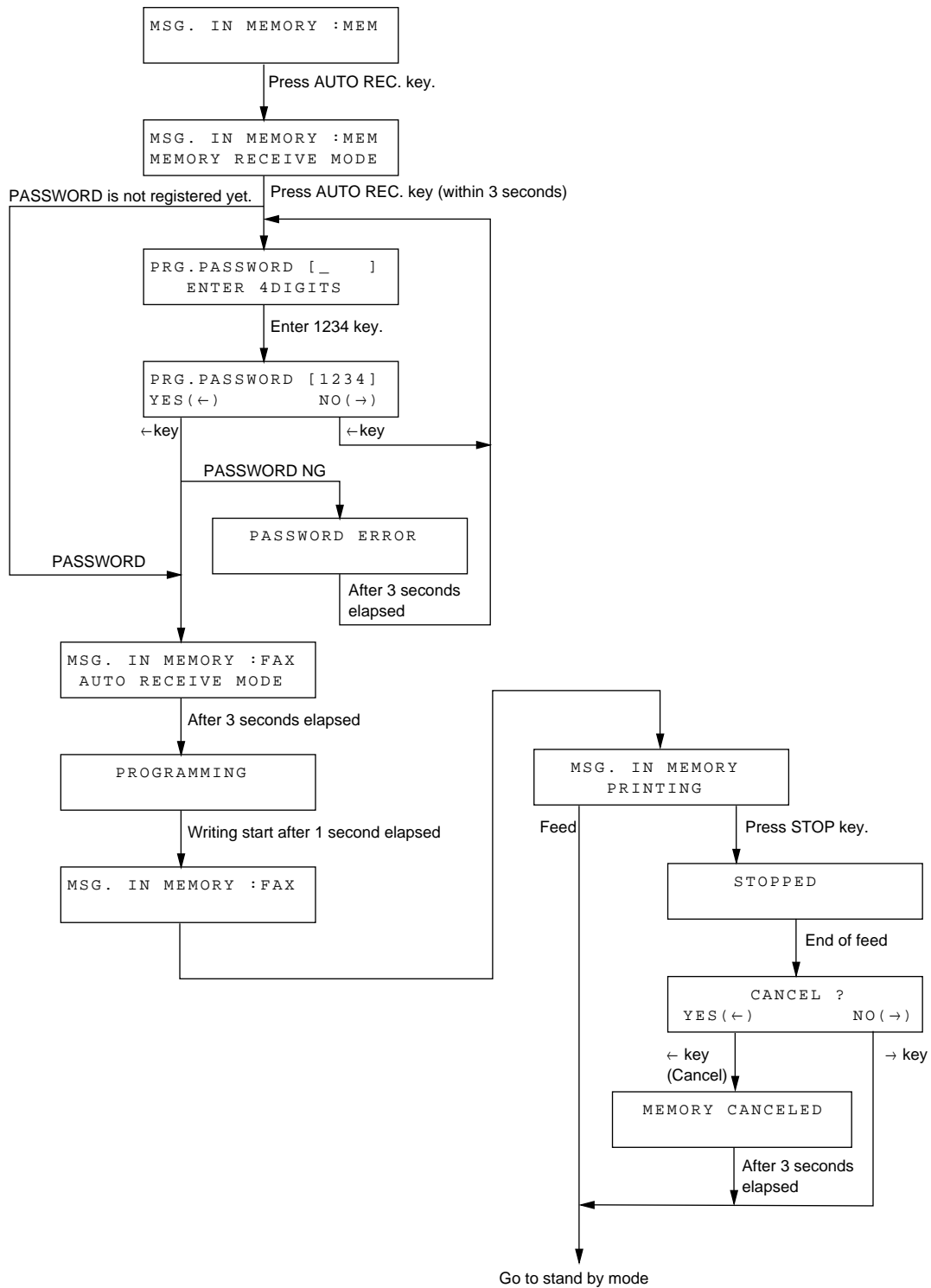

Fig. 4-4-3-2/2 AUTO REC Key Operation (Attached sheet 2)

4-4-4. Transmit Resolution and Type of Original

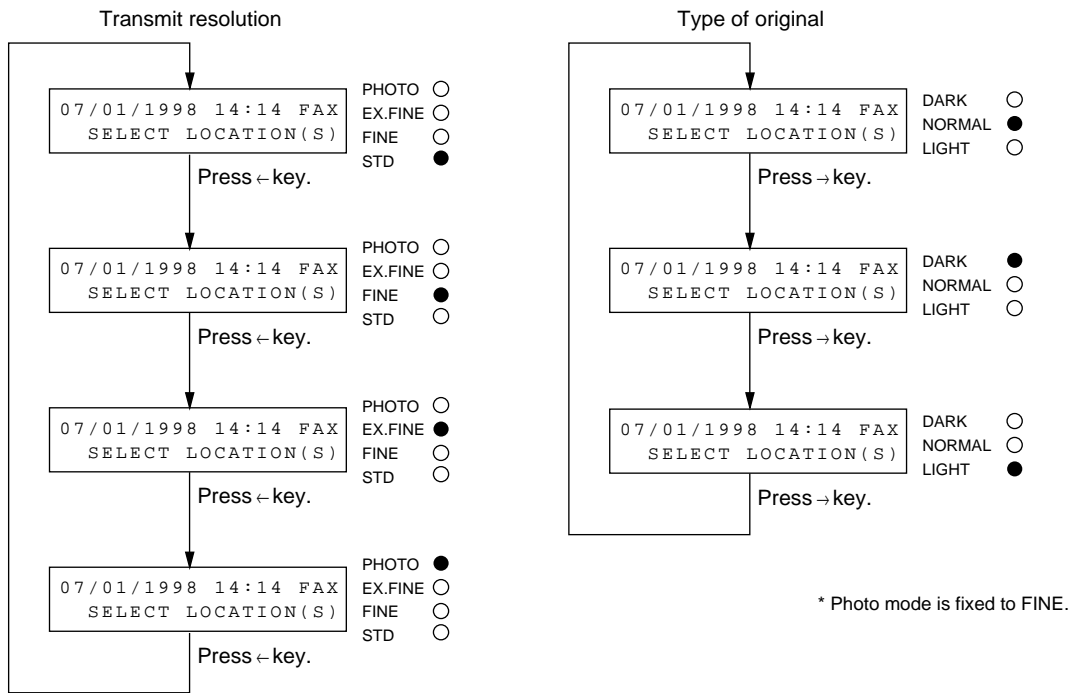

Fig. 4-4-4 Transmit Resolution and Type of Original

LCD Indication During Transmission

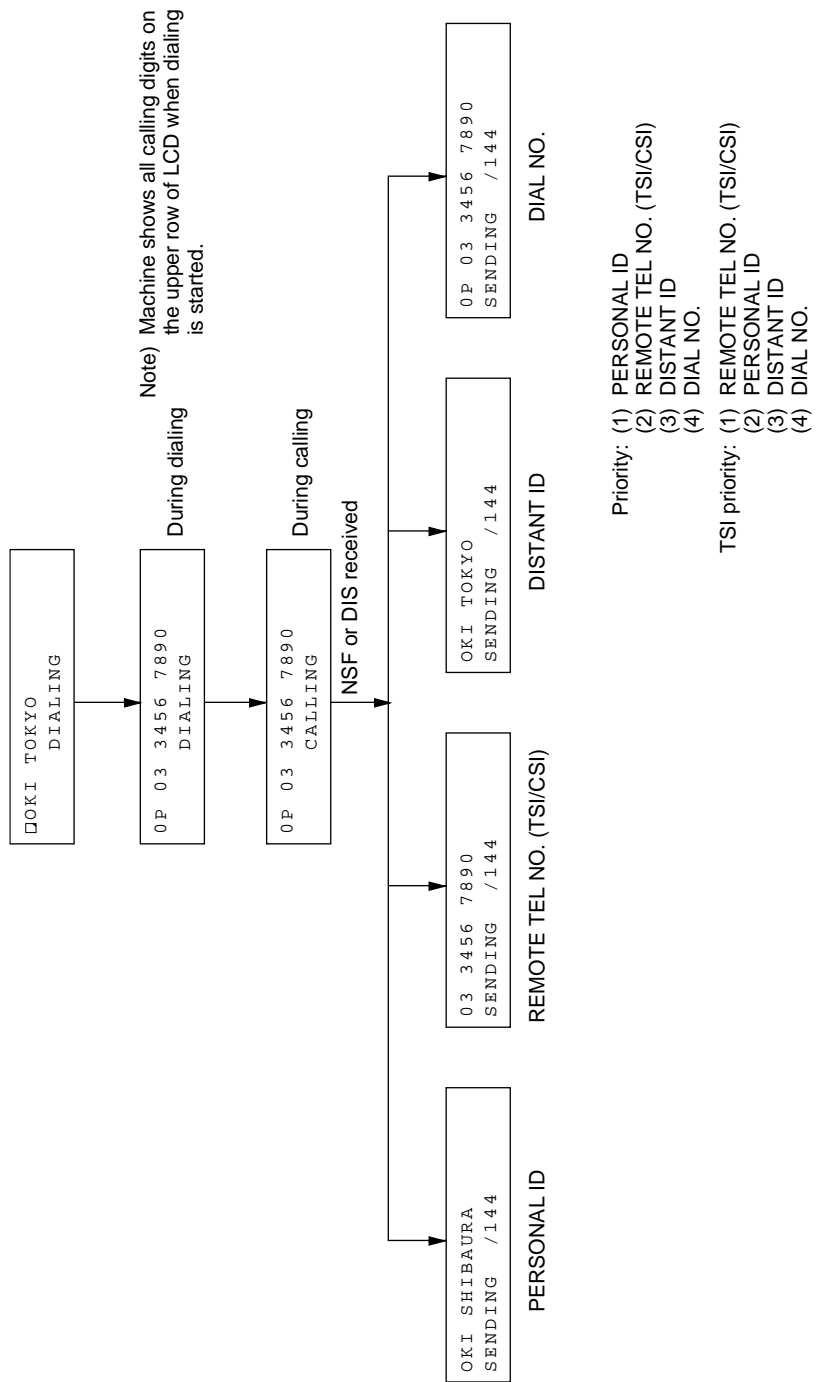
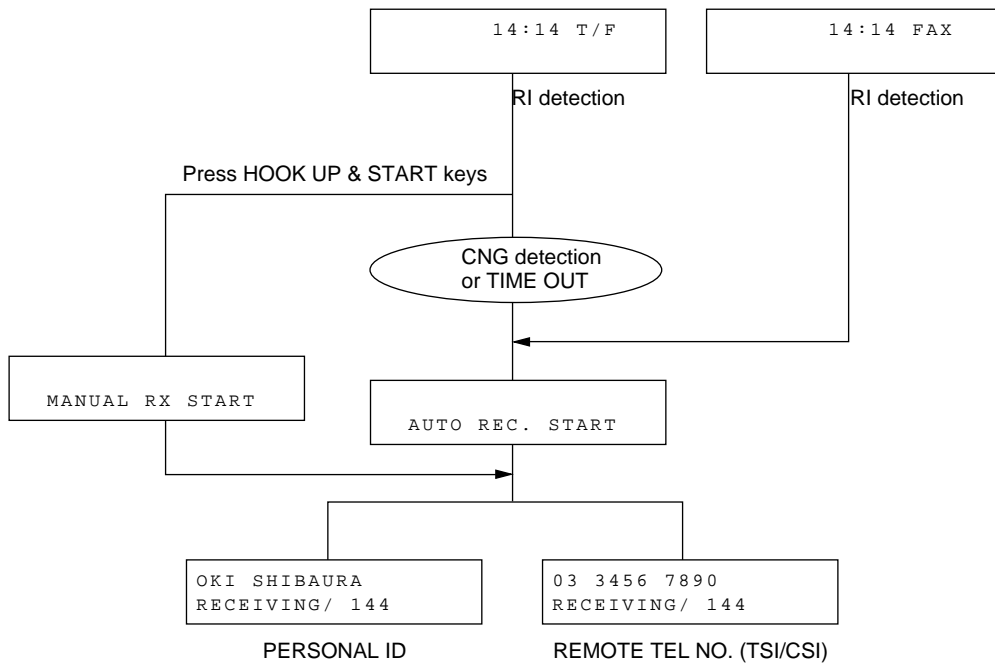

Fig. 4-4-5-1/3 LCD Message During Communication (TX)



Note) If characters of TSI/CSI are alphabets or others which are possible to display, machine shows it on the LCD. If the code is impossible to display, it is replaced by space.

Fig. 4-4-5-2/3 LCD Message During Commuincation (RX)

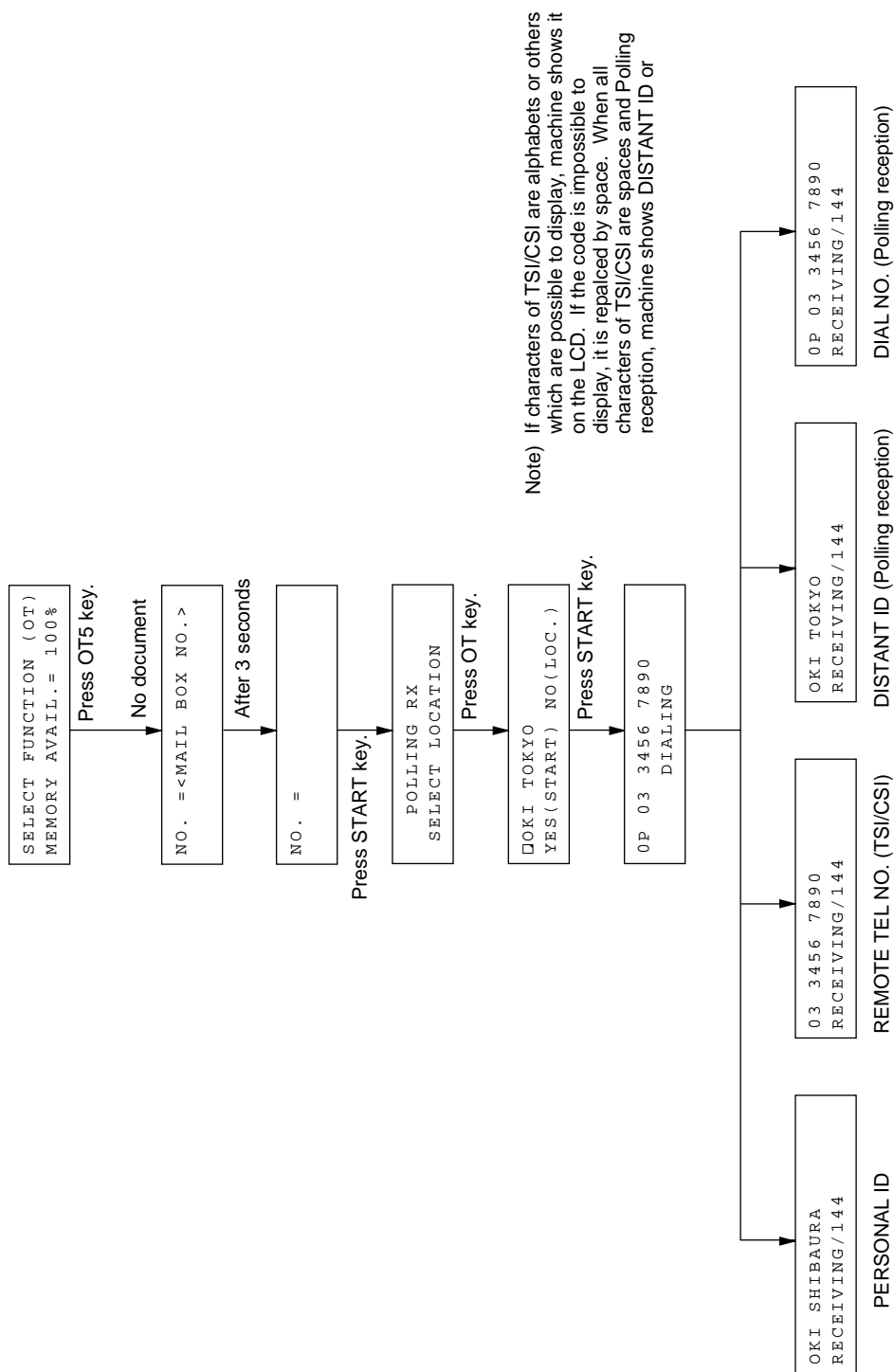

Fig. 4-4-5-3/3 LCD Message During Commuincation (Poll. RX)

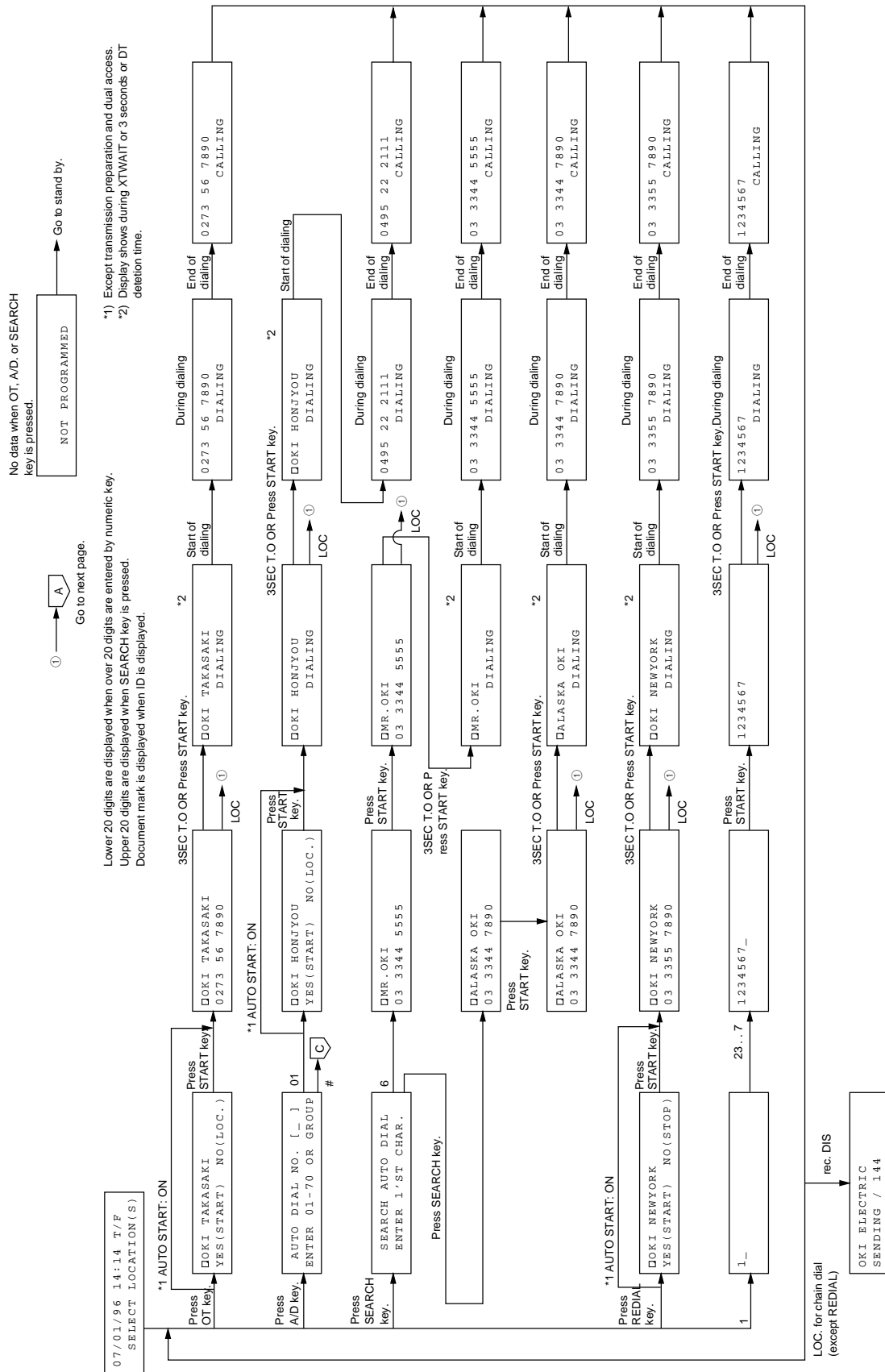

Fig. 4-4-6-1/5 Calling Operation (FAX)

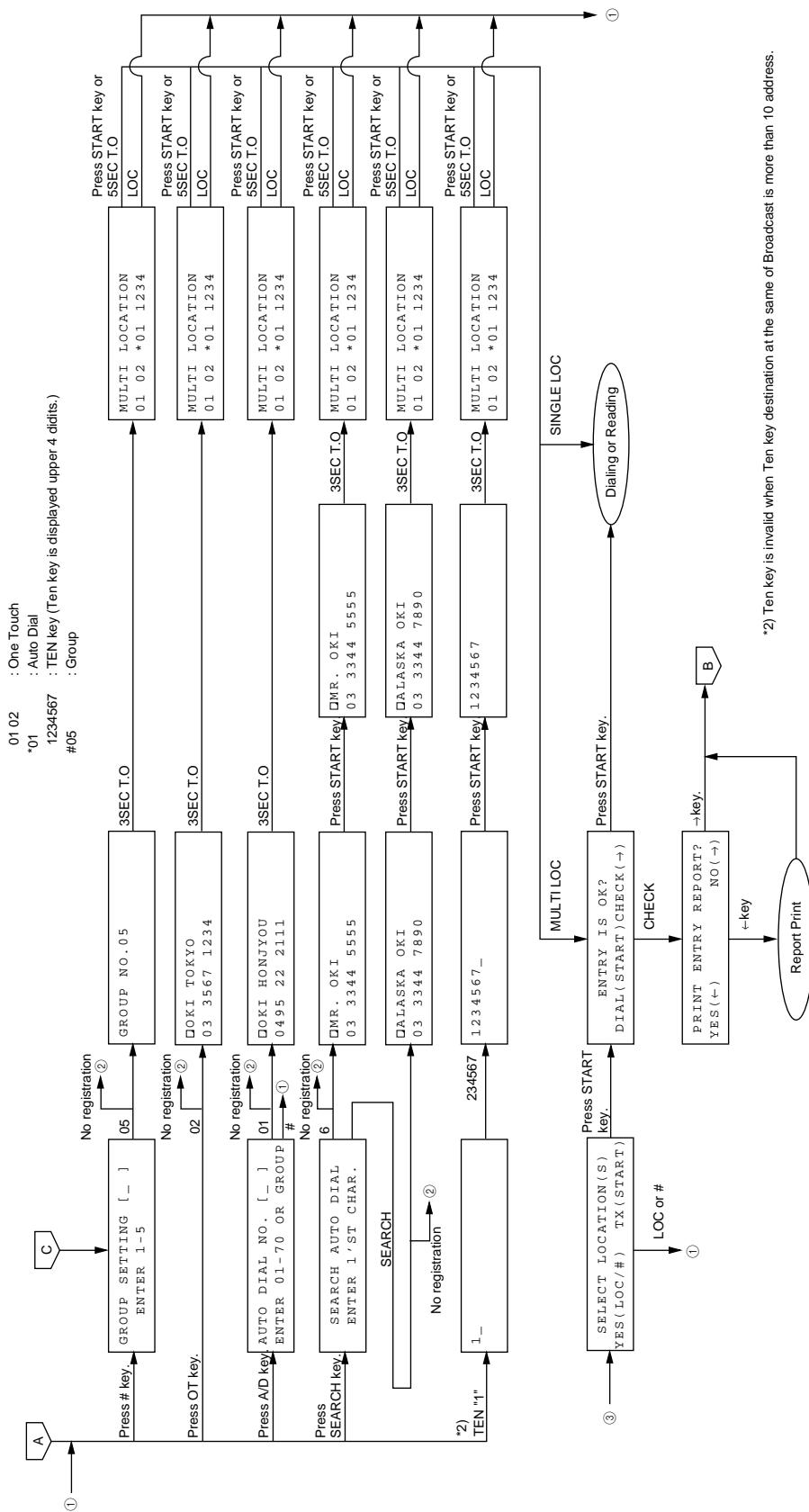

Fig. 4-4-6-2/5 Calling Operation (FAX)

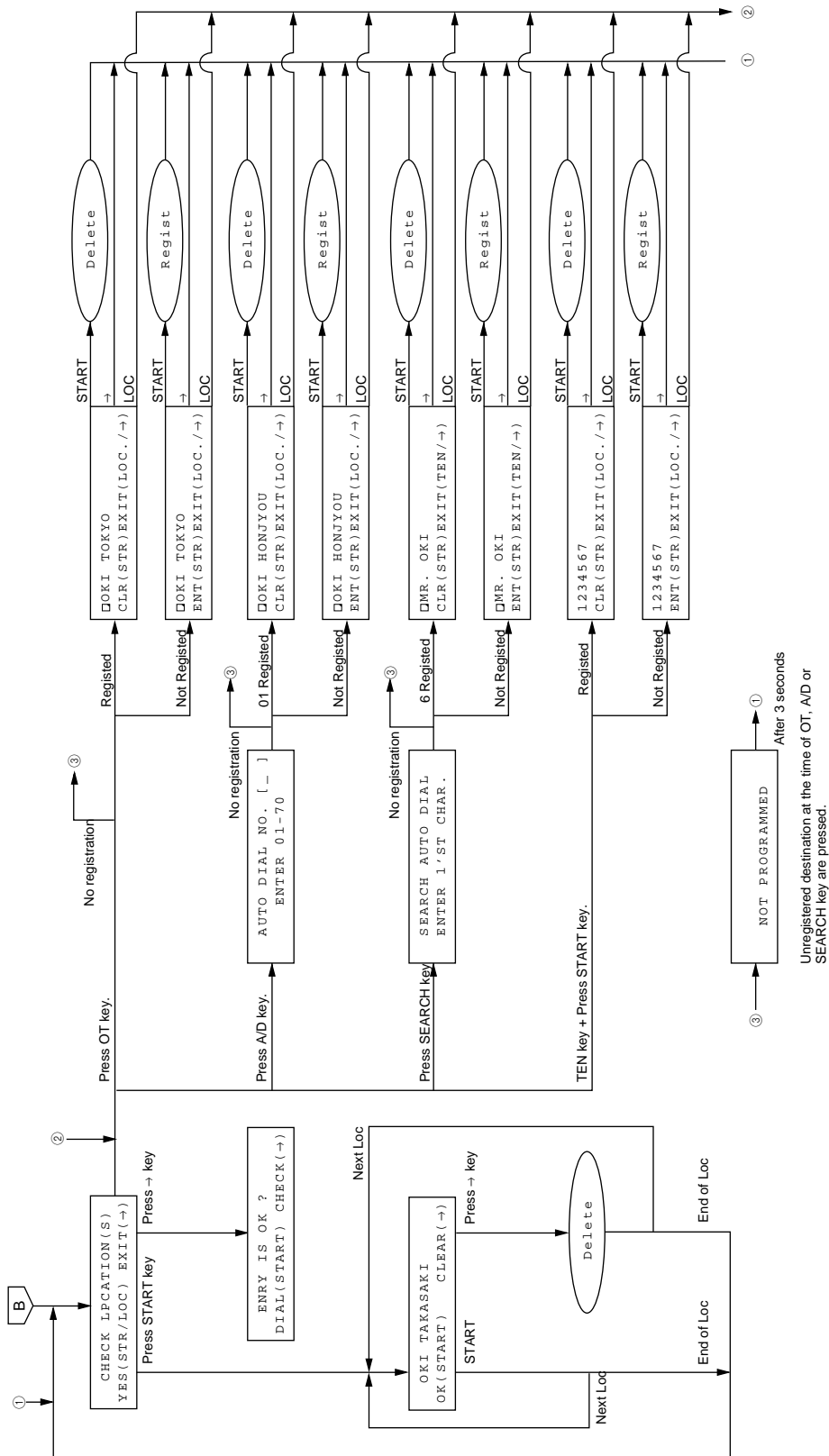

Fig. 4-4-6-3/5 Calling Operation (FAX)

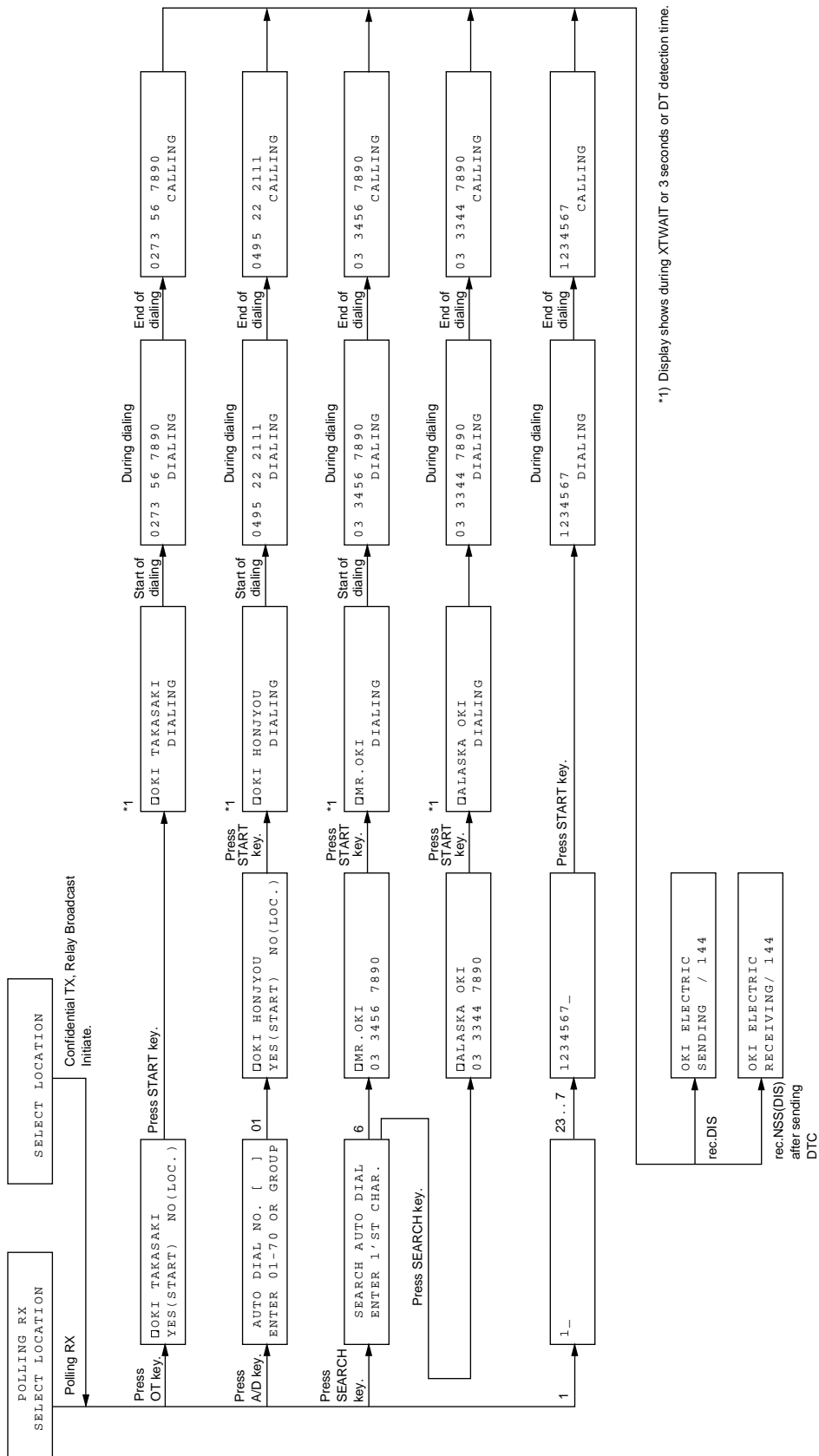
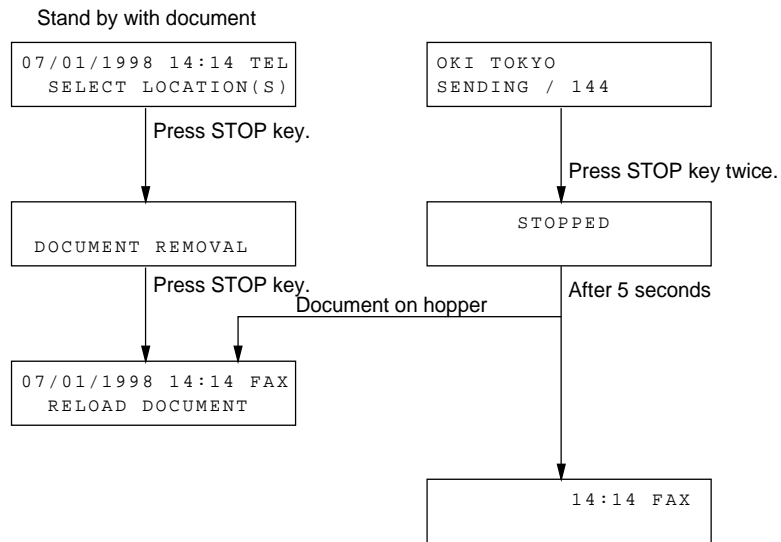

Fig. 4-4-6-4/5 Calling Operation (FAX)



Note: STOP key operation is invalid during RX mode, data clear and prefeeding.

Fig. 4-4-8 Stop Operation

Voice request from local station

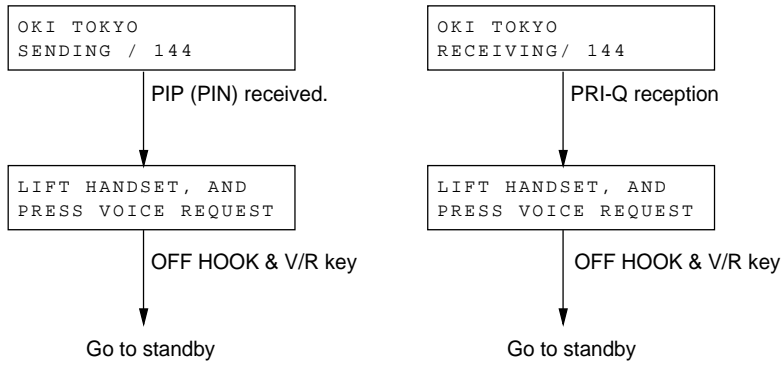

Voice request to local station

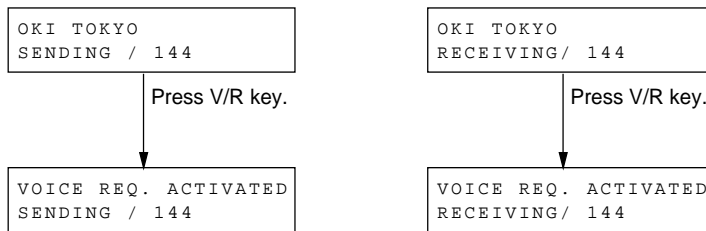

Stop key pressing during memory transmission

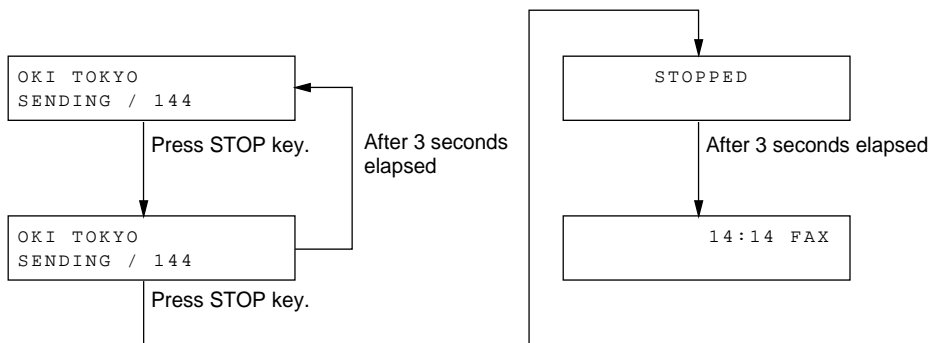

Fig. 4-4-9 Voice Request

No paper

NO PAPER : FAX
CHECK PAPER OR PATH

Paper JAM

PAPER OUT/JAM : FAX
CHECK PAPER OR PATH

No toner *1

TONER LOW : FAX
REPLACE TONER CART.

No toner *2

14:14 FAX
REPLACE TONER CART.

Option (2nd tray)

PRINTER ALARM 2:TEL
REFER TO USER GUIDE

Fan alarm

PRINTER ALARM 3:TEL
REFER TO USER GUIDE

Fuser error

PRINTER ALARM 4:TEL
REFER TO USER GUIDE

Pre-feed error

07/25/1998 14:14 FAX
RELOAD DOCUMENT

ADF error (jam)

DOCUMENT JAM : FAX
CONFIRM AND "STOP"

Cover open

14:14 FAX
COVER OPEN

Memory error (except programming area)

MEMORY ERROR : FAX

Image drum alarm

14:14 FAX
CHANGE DRUM SOON

Warning msg. to replace ID unit because of its life.

Drum (T) counter <30 and no ID

ERROR77

Wrong paper size

CONFIRM PAPER SIZE

Substitution RX in memory *3

MSG.IN MEMORY:FAX
REPLACE TONER CART.

Confidential RX in memory

MSG.IN MEMORY:FAX

Memory reception in memory

MSG.IN MEMORY:MEM

*1: No toner memory RX is ON.

*2: No toner memory RX is OFF.

*3: Alarm factor is shown in low column.

Fig. 4-4-10 Alarm State and Receive into Memory

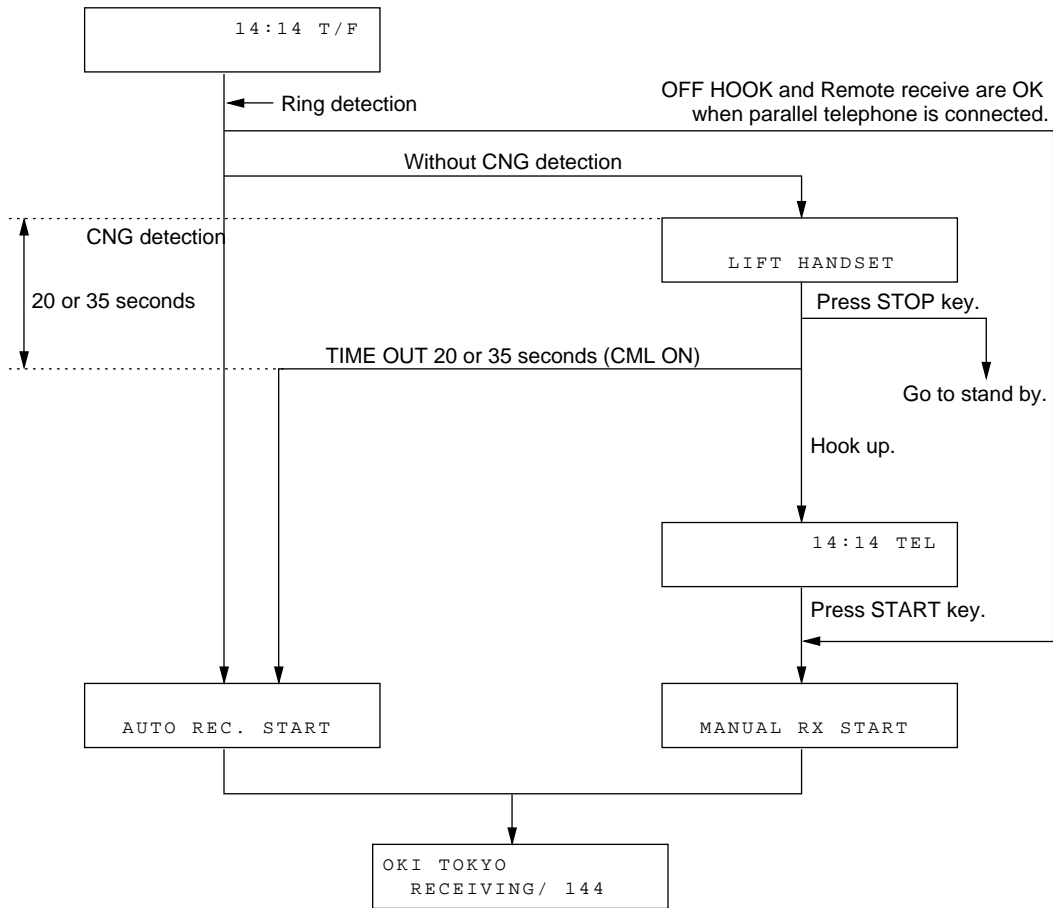

Fig. 4-4-11 TEL/FAX AUTO SW Reception

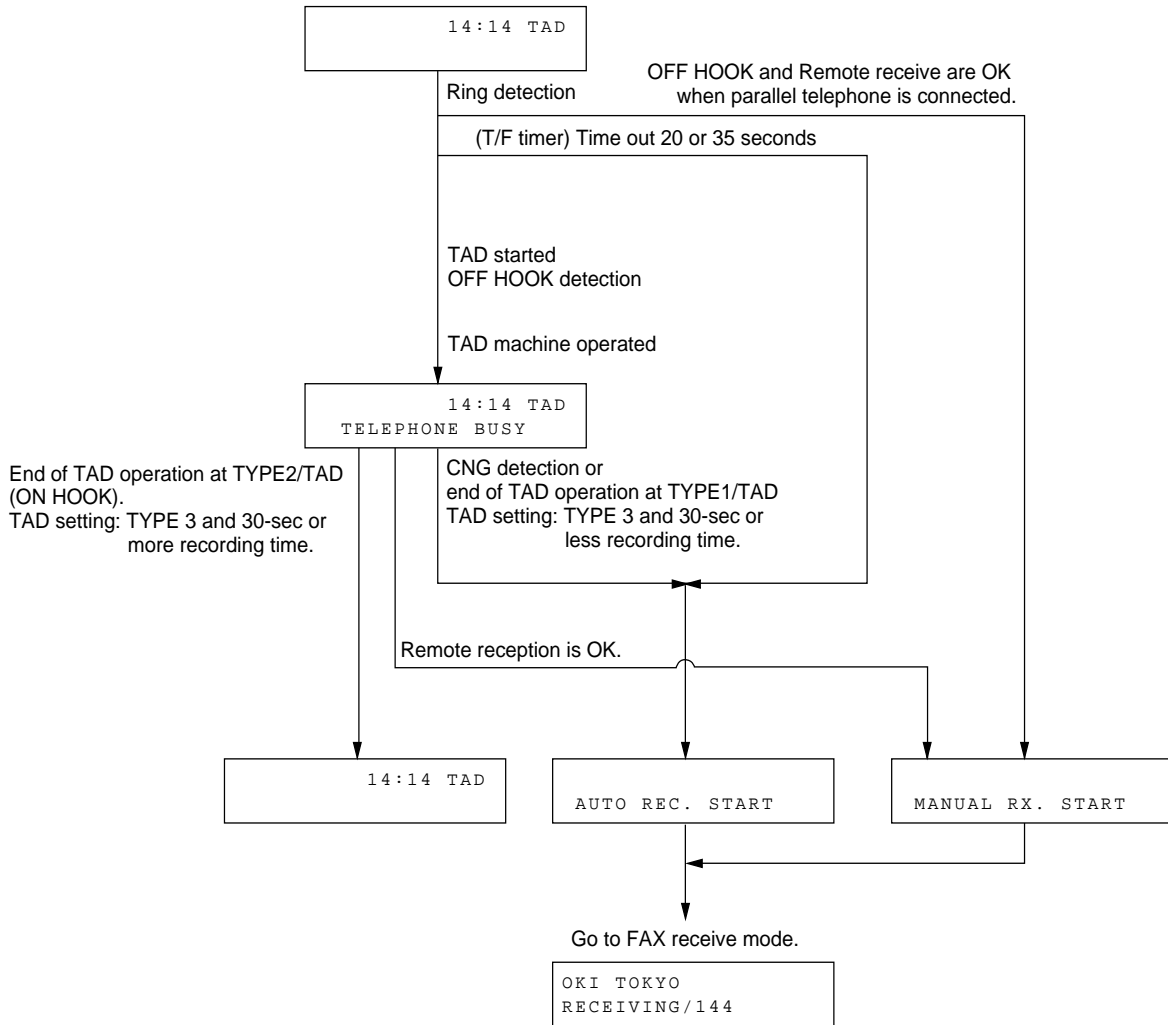
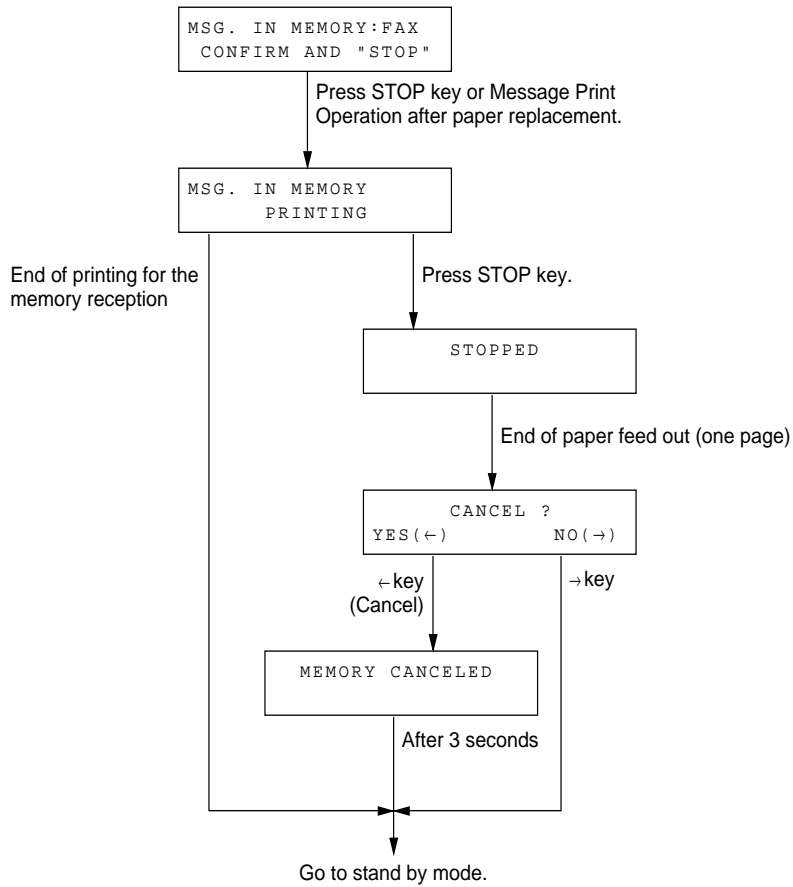

Fig. 4-4-12 TAD Interface



* In case of low toner, print out of memory reception is executed after paper replacement and "NO TONER MEM.RX=OFF".

In case of toner is OK, print out of memory reception is executed after paper replacement.

Fig. 4-4-13 Print Out from Memory by Replace Paper

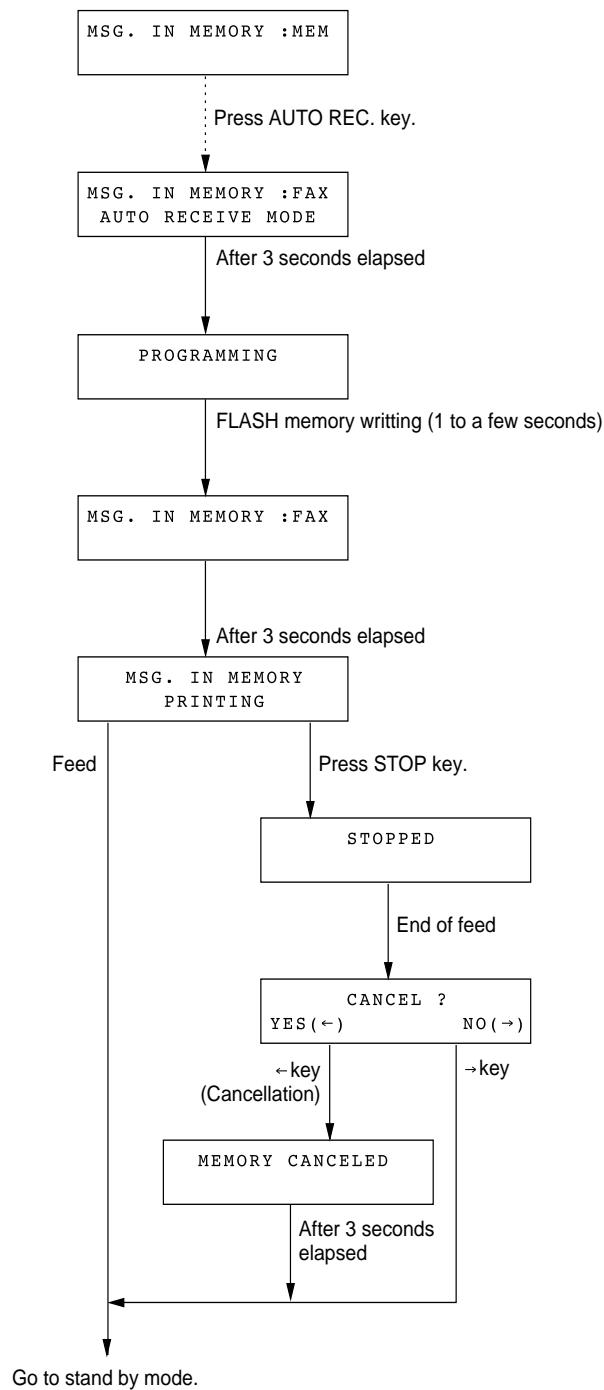

The machine enables the manual printout of MSG. IN MEMORY data by using print operation (F key + OT2).

**Fig. 4-4-14-1/2 Print Out from Memory (Memory Only Reception)
(When MEM. PASSWORD is not registered.)**

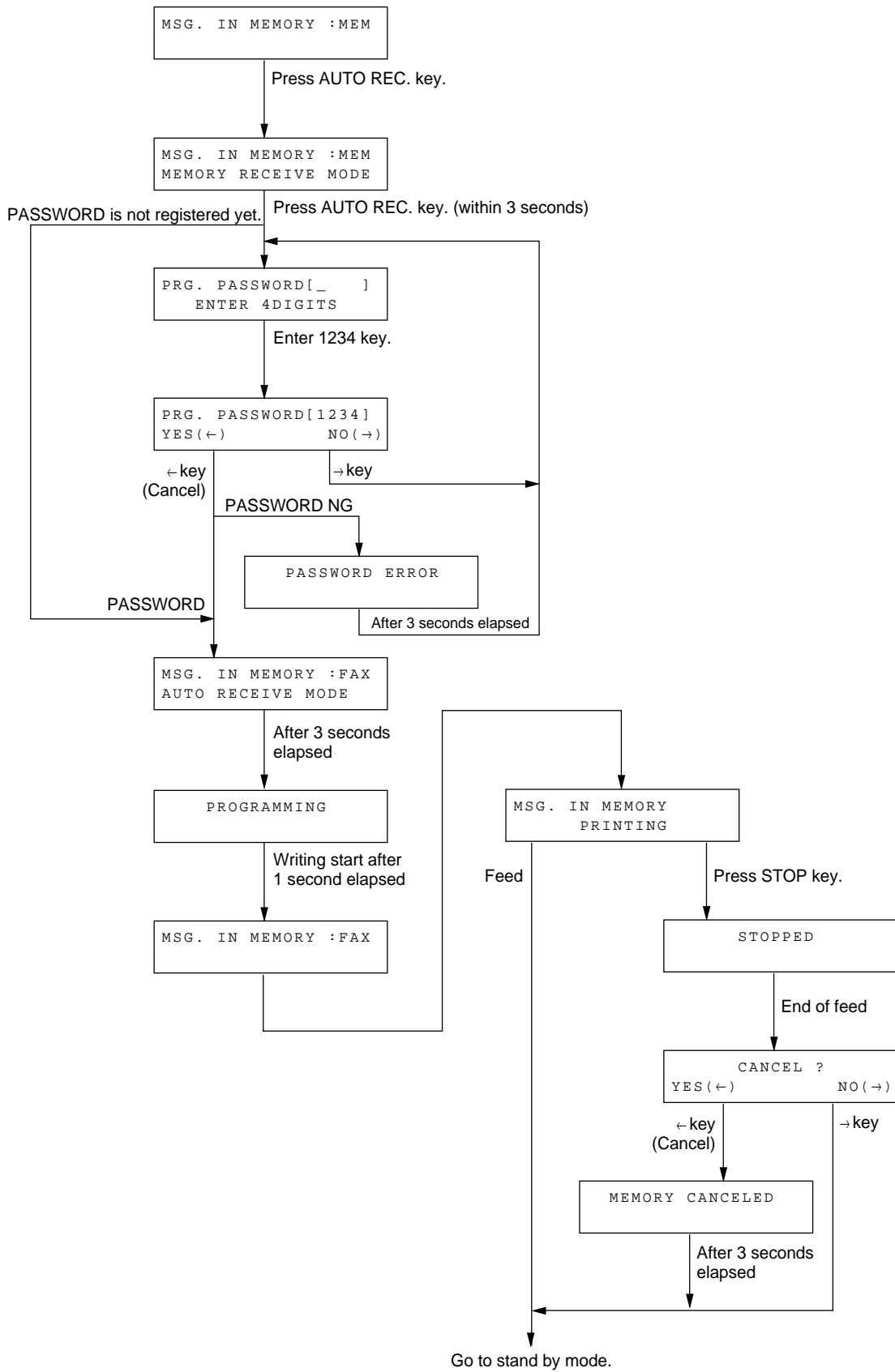

**Fig. 4-4-14-2/2 Print Out from Memory (Memory Only Reception)
(When MEM. PASSWORD is registered.)**

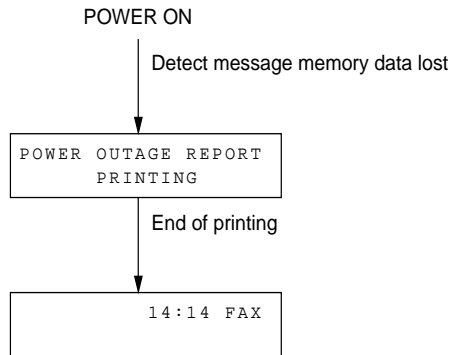

Fig. 4-4-15 Power OFF Report

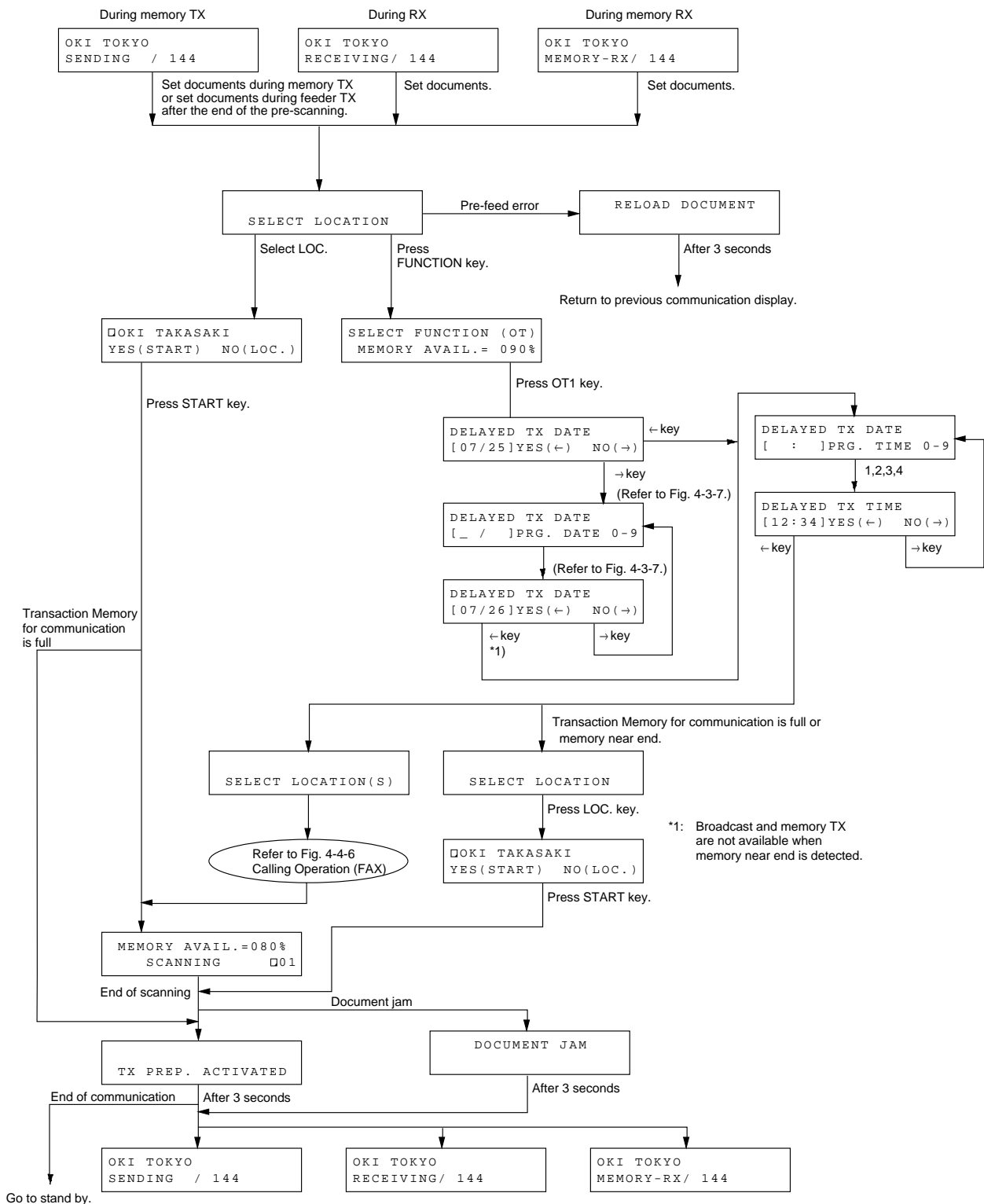
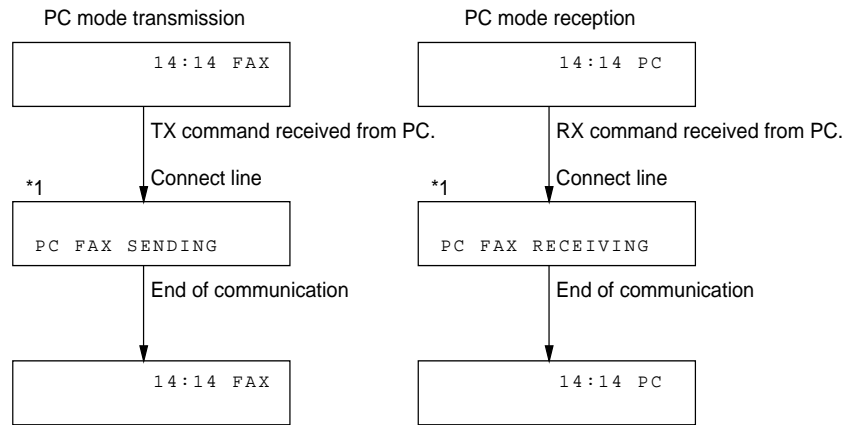

Fig. 4-4-16 TX Preparation and Dual Access



*1: Page numbers for the remote station are not displayed.

Fig. 4-4-17 PC Mode Transmission and Reception

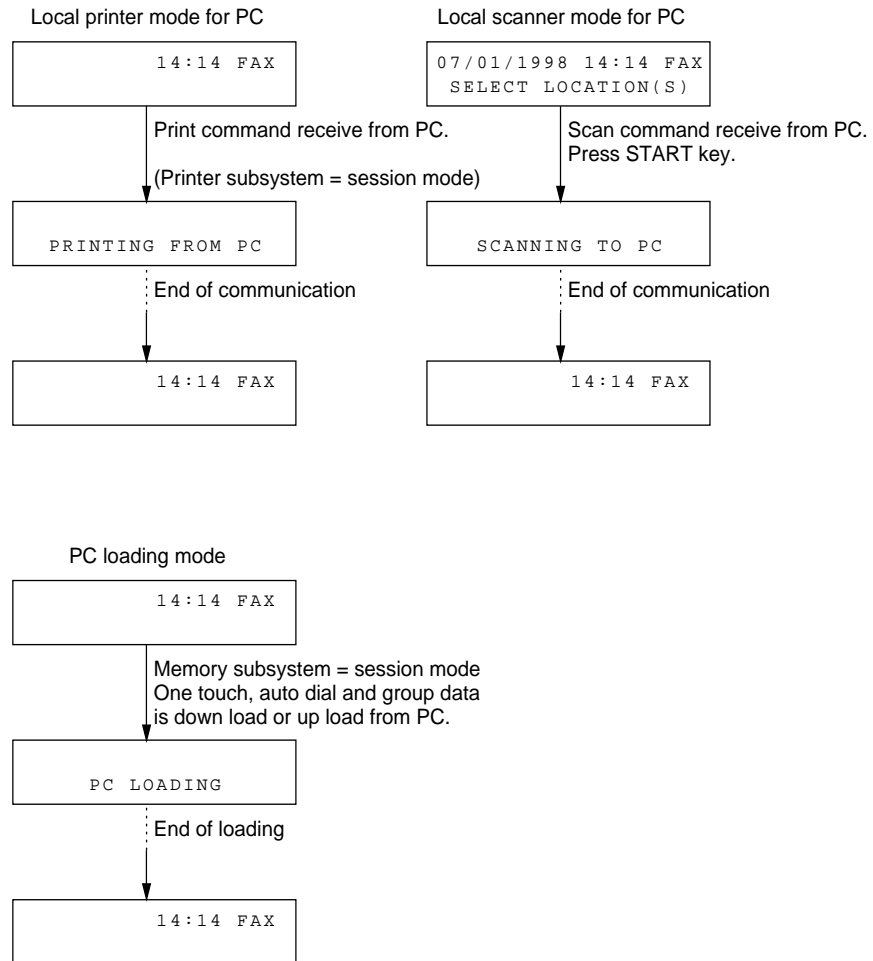
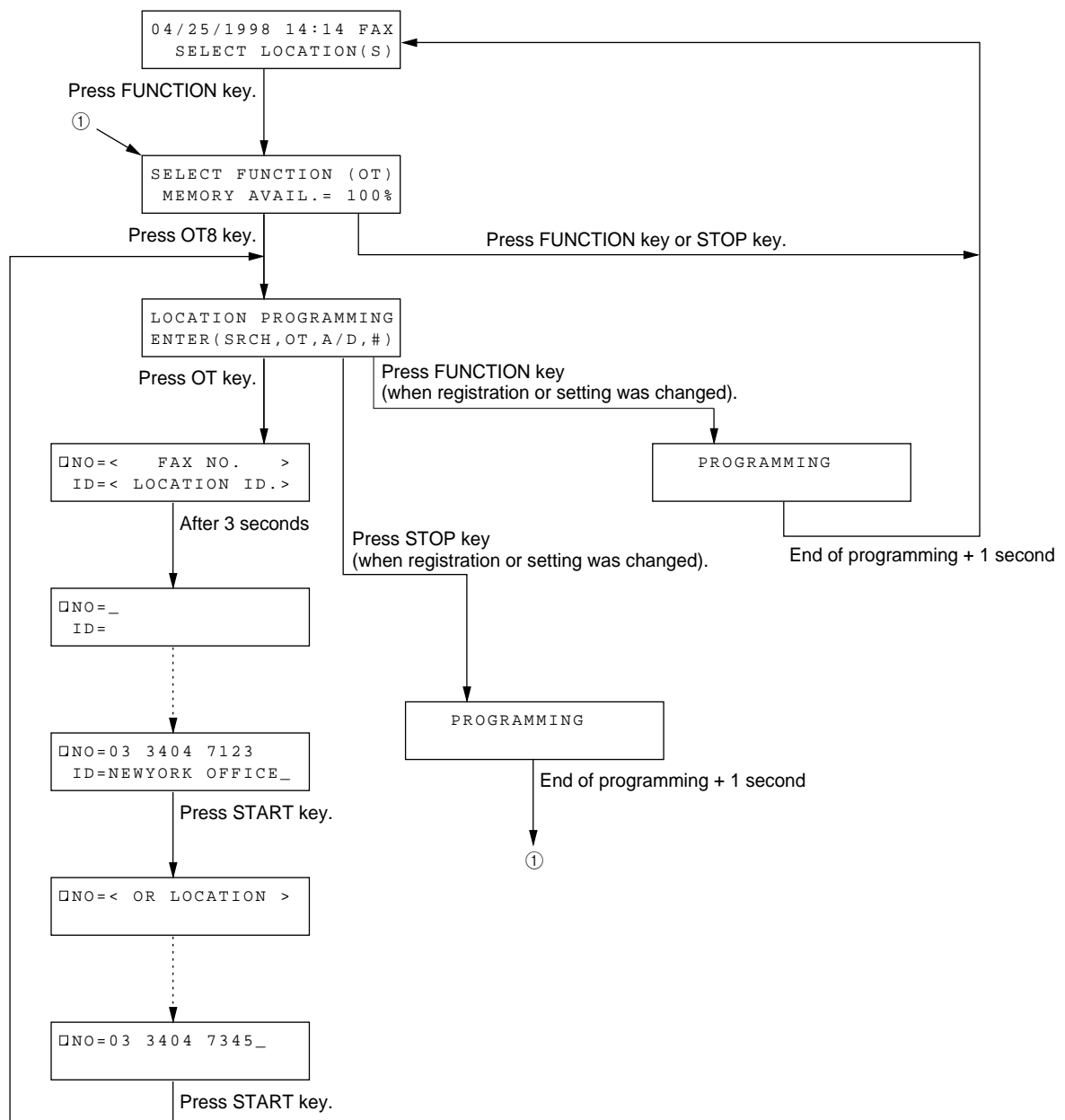

Fig. 4-4-18 Local Printer and Scanner Operations for PC Mode



Write Operation of Flash Memory

- 1) Write operation of flash memory is executed for location registration, user programming, service-man setting when the data is entered or changed.
 - When the FUNCTION key or STOP key is pressed to return to stand by state, flash memory is written when message PROGRAMMING is shown on LCD.
- 2) Write operation of flash memory is executed at the time of system reset (data reset, change of version) or counter reset

Fig. 4-4-19 Flash Memory Write Operation

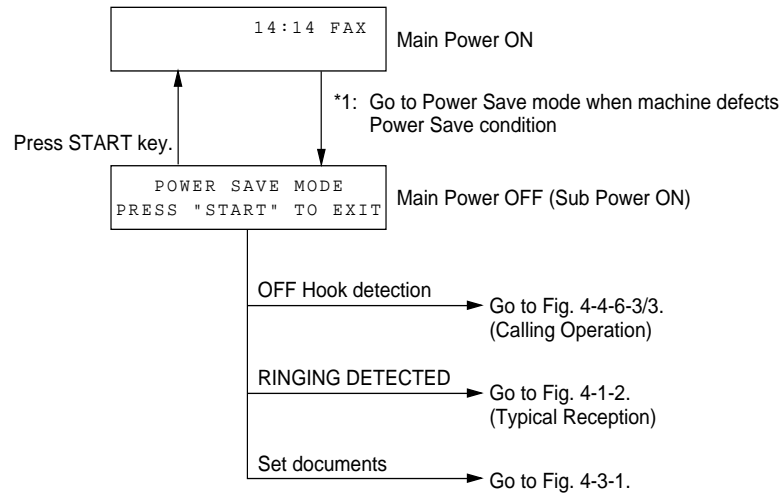

*1) Machine automatically move to Power Save Mode when following conditions are all satisfied.

- (1) Power Save Mode = ON (User setting)
- (2) Stand by condition without document and alarm
- (3) No image data in memory
- (4) On Hook
- (5) Machine detects power off timer (180 seconds) after above (1) to (4) condition are all established.

Fig. 4-4-20 Power Save Mode

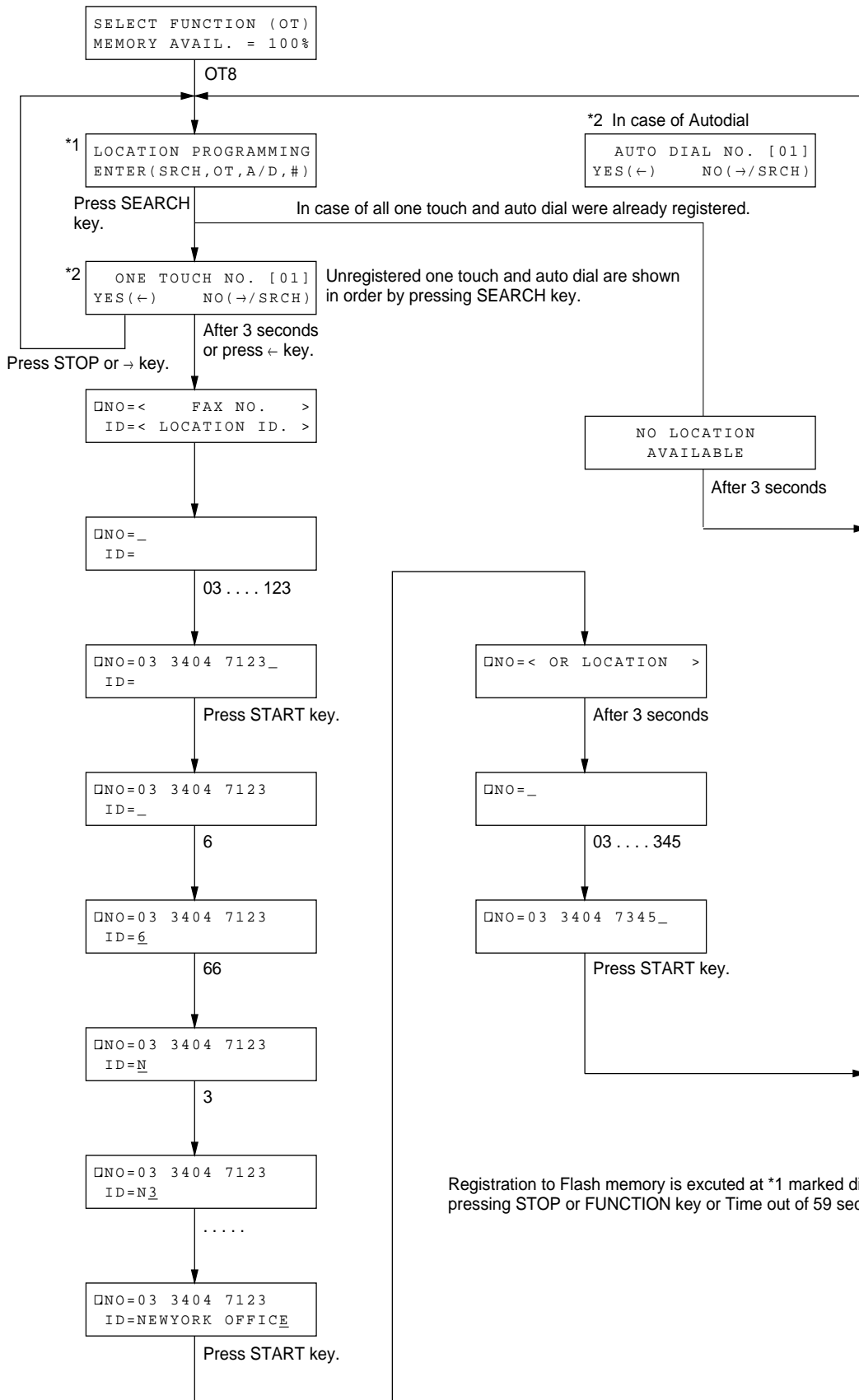
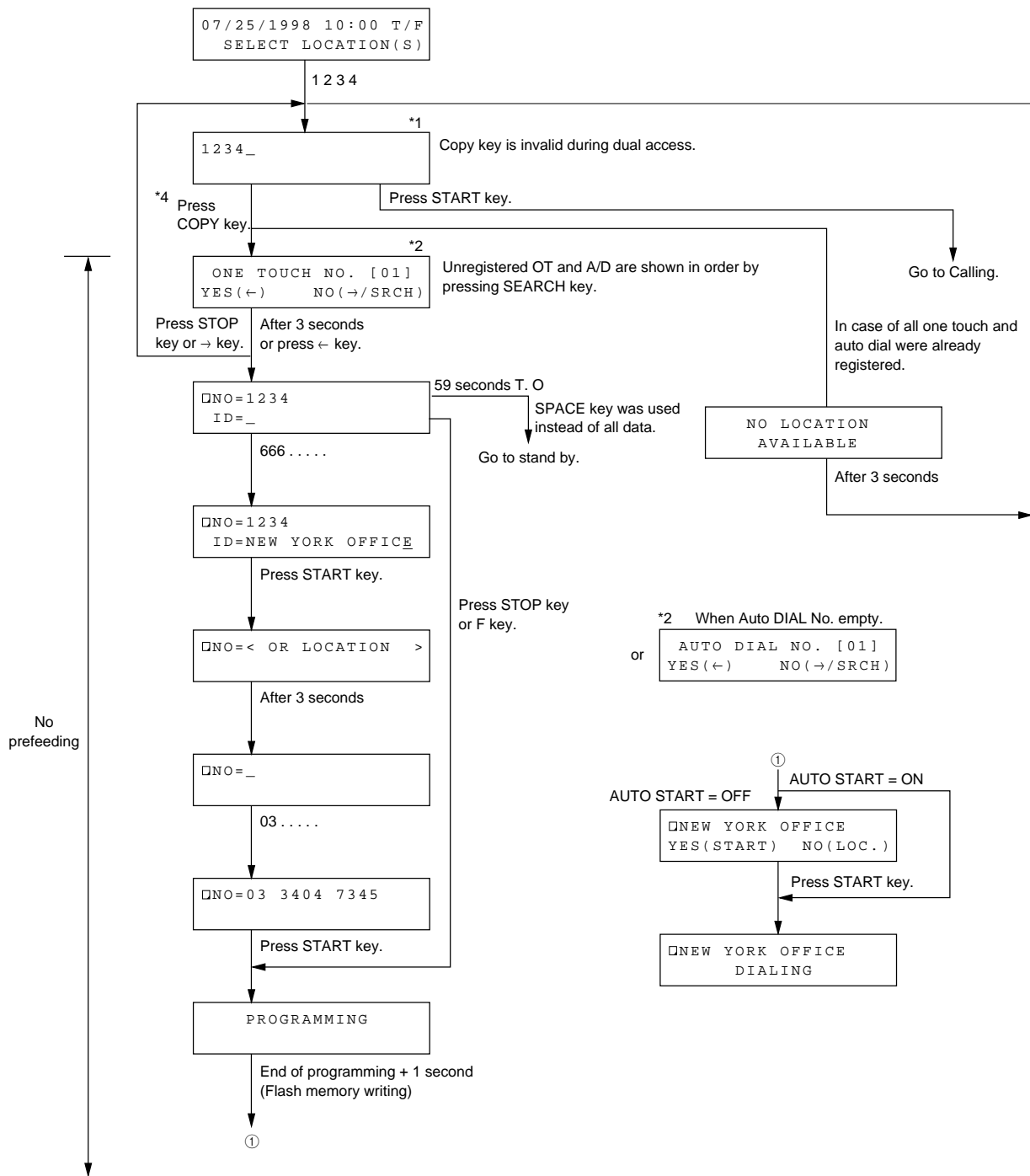

Fig. 4-4-21-1/2 Location Programming (OT/Auto Dial)



*1: Copy key is invalid when FUNCTION communication. (Delay TX/Broadcast TX/ Confidential/Polling RX etc.)
Also Copy Key is invalid when numeric key number are entered more than 32 digits.

Fig. 4-4-21-2/2 Location Programming (OT/Auto Dial) during Normal Dial Operation

In case of the following locations were registered in One-touch keys

OT1: TEL number is 03 3940 6000 and ID is OKIFAX SERVICE.
 OT2: TEL number is *313045# and ID is BOX NO.
 OT3: TEL number is 0002# and ID is PASSWORD NO.

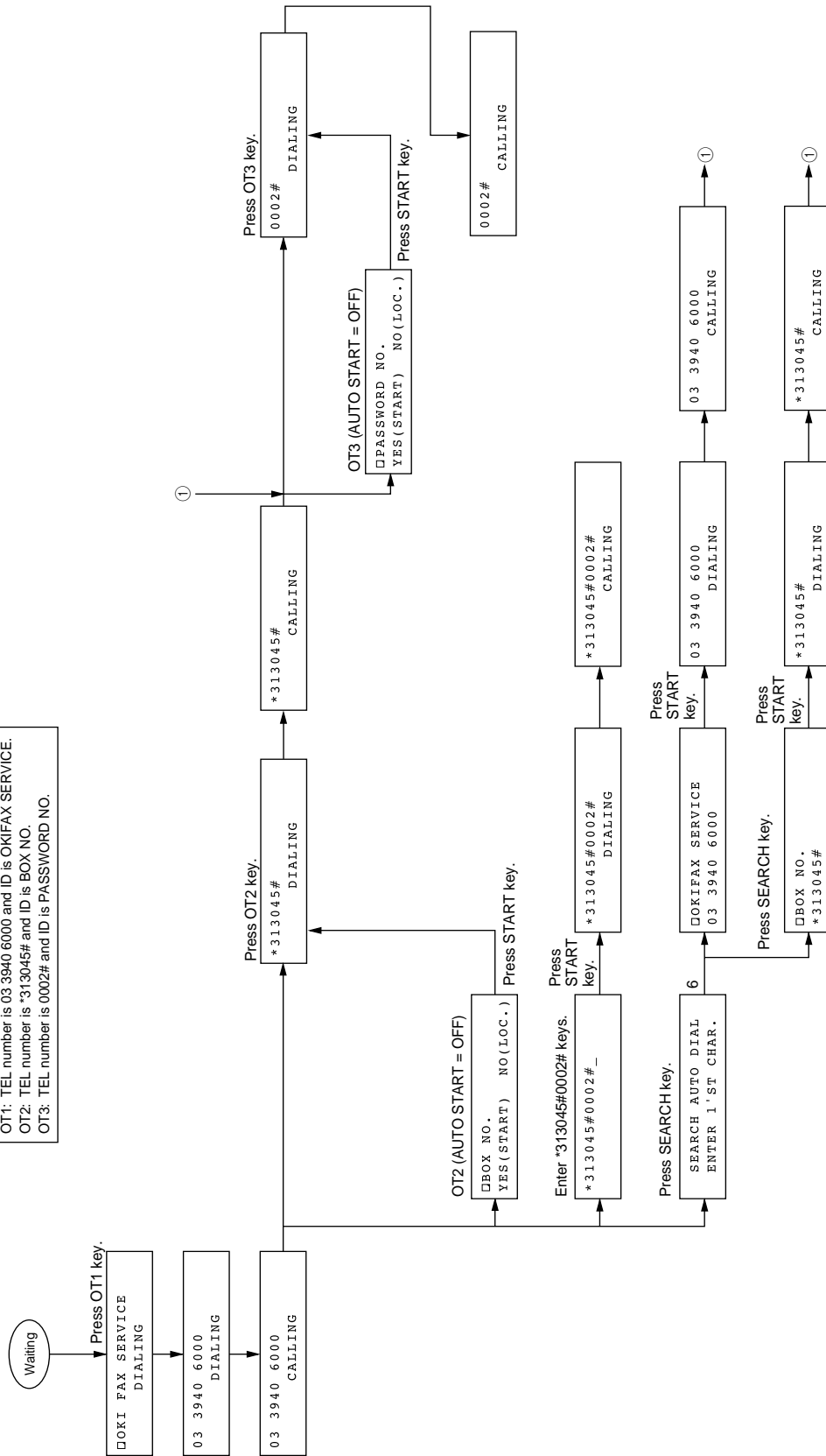

*Note: Same operation is executed when + character is added to the last digits of the TEL number which is selected the one-touch or auto dial keys.

Fig. 4-4-22-2/2 Chain Dial (After Dialing)

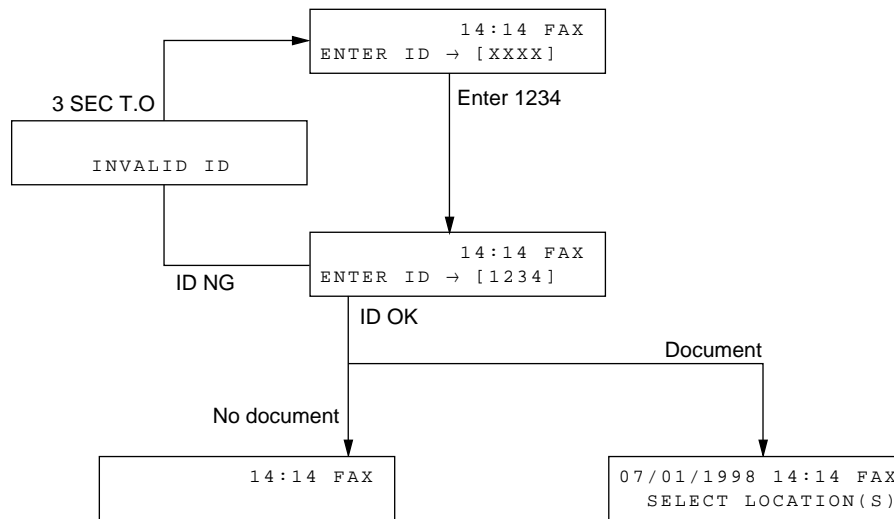

Fig. 4-4-23 RESTRICT ACCESS

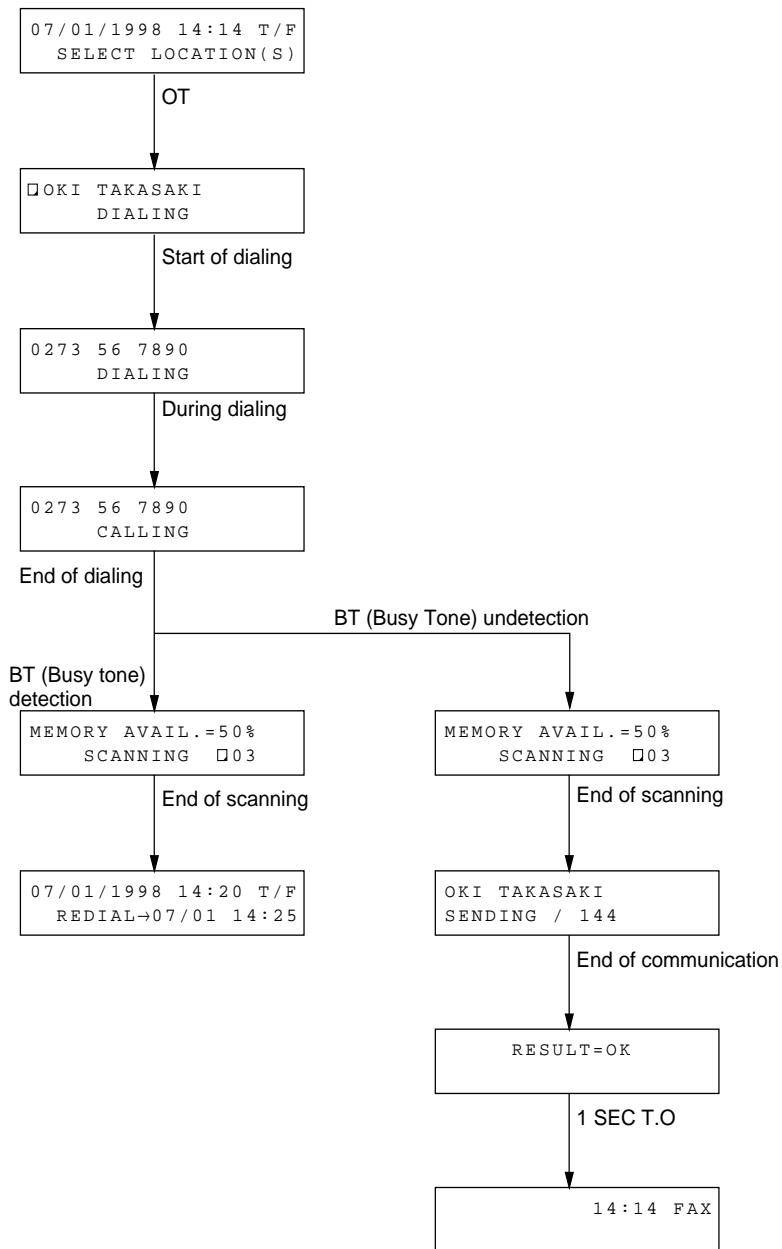

Fig. 4-4-24 Instant Dialing Operation

MESSAGE CONFIRMATION

07/01/1998 08:05
ID=OKI

DATE	S,R-TIME	DISTANT STATION ID	MODE	PAGES	RESULT
07/01	00'20"	OKI FAX	CALLING	02	OK 0000

Fig. 4-5-1 Message Confirmation Report (MCF)

MESSAGE CONFIRMATION

07/01/1998 17:05
ID=OKI

DATE	S,R-TIME	DISTANT STATION ID	MODE	PAGES	RESULT	
07/01	00'20"		B.C.	01	COMP.	60A0

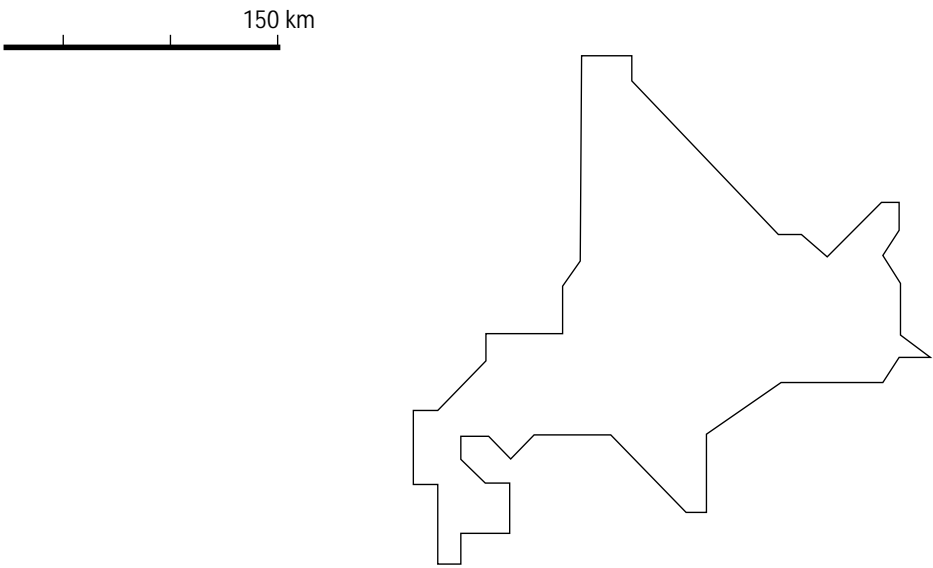

Fig. 4-5-2 IMAGE in MCF with Memory TX

ACTIVITY REPORT

07/01/1998 17:05
ID=OKI

TOTAL	TIME	CALLING=08:22'	CALLED=17:30'				
DATE	TIME	S,R-TIME	DISTANT STATION ID	MODE	PAGES	RESULT	
06/29	10:00	01'20"	OKI FAX	CALLING	02	OK	0000
06/29	10:10	01'00"	0485 88 3385	CALLING	00	STOP	9080
06/29	10:30	00'20"	ODS TAKASAKI	CALLING	00	NO	90C1
06/29	12:05	01'20"	OKI FAX	CALLING	03	OK	0000
06/29	13:00	00'20"	03 5476 4300	CALLING	01	OK	0000
06/29	15:40	03'25"	ODS TAKASAKI	CONF=02	03	OK	0000 *1
06/29	19:00	00'00"	OKI FAX		01	OK	0000 *2
06/30	10:10	02'00"	OKI SHIBAURA	CALLED	05	NO	908E
06/30	10:22	00'12"	0495 22 5400	CALLING	00	STOP	9080
06/30	10:50	01'20"	0495 22 5400	CALLED	03	NO	9090
06/30	12:05	00'20"	OKI FAX	CALLING	01	STOP	9080
06/30	15:00	01'30"		CALLED	03	OK	0000 *3
06/30	15:30	00'20"		CALLING	01	OK	0000
06/30	17:05	05'20"		B.C.		COMP.	60A0 *4
06/30	19:04	00'20"	03 5476 4300	CALLING	00	STOP	9080
07/01	09:00	01'11"		CALLING	02	OK	0000
07/01	10:20	00'20"	03 5476 4300	CALLING	02	STOP	9080
07/01	10:35	02'23"		CONF=03	02	OK	0000 *1
07/01	10:50	00'20"	ODS TAKASAKI	CALLED	01	OK	0000
07/01	11:03	00'00"	OKI FAX	CALLING	00	STOP	9080
07/01	13:00	00'24"	03 5476 4300		01	NO	9082 *5
07/01	16:00	01'20"	027 324 2117	POLL=01	01	OK	0000 *6
07/01	16:10	00'40"	ODS	POLLED	01	OK	0000 *7

*1: Confidential reception
 *2: Manual TX
 *3: Memory reception
 *4: Broadcast TX
 *5: Manual reception
 *6: Bulletin TX wait state
 *7: Memory/Feeder polling TX wait state

Fig. 4-5-3 Activity Report

ACTIVE MEMORY FILES

07/01/1998 17:05
ID=ODC

RECEPTION	ENTRIES	PAGES
	05	20

PERSONAL BOX	BOX NO.	MODE	ENTRIES	PAGES
	01	CONF	03	20
	02	CONF	01	02
	05	POLL	01	05

POLLING TX/RX	DATE	TIME	DISTANT STATION ID	MODE	PAGES
	03/19	12:05	OKI	POLLED	03
				POLLING	

TRANSMISSION	DATE	TIME	DIDTANT STATION ID	MODE	PAGES
	03/20	20:00	OKI DATA SYSTEMS	CALLING	03
	03/19	12:03	0273242117	CALLING	01
	03/19	19:00	ODC TAKASAKI	CALLING	02

Fig. 4-5-4 Active Memory Files

CONFIGURATION

07/01/1998 17:05
ID=OKI

FUNCTION LIST

01:MCF (SINGLE-LOC.) ON	02:MCF (MULTI-LOC.) ON	03:ERR.REPORT (MCF) ON
04:IMAGE IN MCF ON	05:SENDER ID. ON	06:MONITOR VOLUME LOW
07:BUZZER VOLUME MIDDLE	08:CLOSED NETWORK OFF	09:TX MODE DEFAULT FINE/NORMAL
10:T/F TIMER PRG. 35SEC	11:RING RESPONSE 1RING	12:DISTINCTIVE RING OFF
13:1 ST PAPER SIZE A4	14:USER LANGUAGE ENGLISH	15:INCOMING RING ON
16:REMOTE RECEIVE OFF	17:MEM./FEEDER SWITCH MEMORY	18:POWER SAVE MODE ON
19:ECM FUNCTION ON	20:REMOTE DIAGNOSIS OFF	21:PC/FAX SWITCH ON
22:NO TONER MEM.RX OFF	23:MEM.FULL SAVE OFF	24:CONTINUOUS TONE OFF
25:INSTANT DIALING ON	26:RESTRICT ACCESS OFF	27:WIDTH REDUCTION OFF

TEL NO. = 12345678901234567890
CALL BACK NO. = 12345678901234567890

REDIAL TRIES	3TRY	REDIAL INTERVAL	3MIN
DIAL TONE DETECT	OFF	BUSY TONE DETECT	ON
MF(TONE)/DP(PULSE)	MF	PULSE DIAL RATE	10PPS
PALUSE MAKE RATIO	39%	PULSE DIAL TYPE	NORMAL
MF (TONE) DURATION	100MS	PBX LINE	OFF
PBX TYPE	NORMAL	AUTO START	ON
DIAL PREFIX	OFF		

Fig. 4-5-5 Configuration Report (User)

CONFIGURATION

07/01/1998 17:05
ID=OKI

FUNCTION LIST

01:SERVICE BIT ON	02:MONITOR CONT. OFF	03:COUNTRY CODE USA
04:TIME/DATE PRINT OFF	05:TSI PRINT ON	06:TAD MODE TYPE2
07:REAL TIME DIAL TYPE2	08:TEL/FAX SWITCH ON	09:MDY/DMY. MDY
10:LONG DOC. SCAN OFF	11:TONE FOR ECHO OFF	12:MH ONLY OFF
13:H/MODEM RATE 14.4K	14:T1 (TX) TIMER VALUE 059	15:T1 (RX) TIMER VALUE 035
16:T2 TIMER VALUE 060	17:DIS BIT32 ON	18:ERR. CRITERION VALUE 10
19:OFF HOOK BYPASS OFF	20:NL EQUALIZER 0kM	21:ATTENUATOR 10DB
22:T/F TONE ATT. 10DB	23:MF ATT. 6DB	24:RING DURA. * 10MS 12
25:CML TIMING * 100MS 03	26:LED HEAD STROBE 10100	27:LED HEAD WIDTH TYPE1
28:MEDIA TYPE MEDIUM	29:TR LATCH CURRENT +1	30:NSF SWITCH ON
31:ID/TSI PRIORITY ID	32:TONER COUNT CLEAR OFF	33:PARALLEL PICK UP ON

Fig. 4-5-6 Service Default Report (Configuration Report: Service bit=ON)

TELEPHONE DIRECTORY P1

07/01/1998 17:05
ID=OKI

	LOCATION ID		TEL NO.	PRM. ECHO	RETE
ONE TOUCH					
1	OT1 OKI OFFICE	<input type="checkbox"/>	0001 123 123 123	(ON)	(14.4)
		OR <input type="checkbox"/>	0101 111 222 333		
2	OT2 OKI LABORATORY	<input type="checkbox"/>	0002 456 456 456	(OFF)	(14.4)
		OR <input type="checkbox"/>	0102 444 555 666		
3	OT3 ODC TAKASAKI	<input type="checkbox"/>	0003 789 789 789	(ON)	(14.4)
		OR <input type="checkbox"/>	0103 777 888 999		
4	OT4 ODC QA/QC LAB.	<input type="checkbox"/>	0004 1234 5678 90123	(ON)	(14.4)
		OR <input type="checkbox"/>	0104		
5	OT5	<input type="checkbox"/>	0005	(ON)	(14.4)
		OR <input type="checkbox"/>	0105		
6	OT6	<input type="checkbox"/>	0006	(ON)	(14.4)
		OR <input type="checkbox"/>	0106		
7	OT7	<input type="checkbox"/>	0007	(ON)	(14.4)
		OR <input type="checkbox"/>	0107		
8	OT8	<input type="checkbox"/>	0008	(ON)	(14.4)
		OR <input type="checkbox"/>	0108		
9	OT9	<input type="checkbox"/>	0009	(ON)	(14.4)
		OR <input type="checkbox"/>	0109		
10	OT10	<input type="checkbox"/>	0010	(ON)	(14.4)
		OR <input type="checkbox"/>	0110		
AUTO DIAL					
01	AD01	<input type="checkbox"/>	1001		
02	AD02	<input type="checkbox"/>	1002		
03	AD03	<input type="checkbox"/>	1003		
04	AD04	<input type="checkbox"/>	1004		
05	AD05	<input type="checkbox"/>	1005		
06	AD06	<input type="checkbox"/>	1006		
07	AD07 ODC TAKASAKI	<input type="checkbox"/>	1007 0273 28 1234		
08	AD08	<input type="checkbox"/>	1008		
09	AD09	<input type="checkbox"/>	1009		
10	AD10	<input type="checkbox"/>	1010		
11	AD11	<input type="checkbox"/>	1011		
12	AD12	<input type="checkbox"/>	1012		
13	AD13	<input type="checkbox"/>	1013		
14	AD14	<input type="checkbox"/>	1014		
15	AD15	<input type="checkbox"/>	1015		
16	AD16	<input type="checkbox"/>	1016		
17	AD17	<input type="checkbox"/>	1017		
18	AD18	<input type="checkbox"/>	1018		
19	AD19	<input type="checkbox"/>	1019		
20	AD20	<input type="checkbox"/>	1020		
21	AD21	<input type="checkbox"/>	1021		
22	AD22	<input type="checkbox"/>	1022		
23	AD23	<input type="checkbox"/>	1023		
24	AD24	<input type="checkbox"/>	1024		
25	AD25	<input type="checkbox"/>	1025		
26	AD26	<input type="checkbox"/>	1026		
27	AD27	<input type="checkbox"/>	1027		
28	AD28	<input type="checkbox"/>	1028		
29	AD29	<input type="checkbox"/>	1029		
30	AD30	<input type="checkbox"/>	1030		
31	AD31	<input type="checkbox"/>	1031		
32	AD32	<input type="checkbox"/>	1032		
33	AD33	<input type="checkbox"/>	1033		
34	AD34	<input type="checkbox"/>	1034		
35	AD35	<input type="checkbox"/>	1035		
36	AD36	<input type="checkbox"/>	1036		
37	AD37	<input type="checkbox"/>	1037		
38	AD38	<input type="checkbox"/>	1038		
39	AD39	<input type="checkbox"/>	1039		
40	AD40	<input type="checkbox"/>	1040		
41	AD41	<input type="checkbox"/>	1041		
42	AD42	<input type="checkbox"/>	1042		
43	AD43	<input type="checkbox"/>	1043		
44	AD44	<input type="checkbox"/>	1044		
45	AD45	<input type="checkbox"/>	1045		

Fig. 4-5-7-1 Telephone Directory (1/3)

TELEPHONE DIRECTORY P2

07/01/1998 17:05
ID=OKI

AUTO DIAL	LOCATION ID	TEL NO.
	45 AD45	☐ 1045
	46 AD46	☐ 1046
	47 AD47	☐ 1047
	48 AD48	☐ 1048
	49 AD49	☐ 1049
	50 AD50	☐ 1050
	51 AD51	☐ 1051
	52 AD52	☐ 1052
	53 AD53	☐ 1053
	54 AD54	☐ 1054
	55 AD55	☐ 1055
	56 AD56	☐ 1056
	57 AD57	☐ 1057
	58 AD58	☐ 1058
	59 AD59	☐ 1059
	60 AD60	☐ 1060
	61 AD61	☐ 1061
	62 AD62	☐ 1062
	63 AD63	☐ 1063
	64 AD64	☐ 1064
	65 AD65	☐ 1065
	66 AD66	☐ 1066
	67 AD67	☐ 1067
	68 AD68	☐ 1068
	69 AD69	☐ 1069
	70 AD70	☐ 1070

Fig. 4-5-7-2 Telephone Directory (2/3)

TELEPHONE DIRECTORY P3

07/01/1998 17:05
ID=OKI

GROUP_NUMBER_=#1_#2_#3_#4_#5

#1_ONE_TOUCH

1 2 3 4 5 6 7 8 9 10

AUTO DIAL

01 02 03 04 05 06 07

26 27 28 29 30 31 32

#2_ONE_TOUCH

AUTO DIAL

#3_ONE_TOUCH

AUTO DIAL

#4_ONE_TOUCH

AUTO DIAL

#5_ONE_TOUCH

AUTO DIAL

Fig. 4-5-7-3 Telephone Directory (3/3)

BROADCAST ENTRY REPORT

07/01/1998 17:05
ID=OKI

LOCATION ID	LOCATION ID	LOCATION ID
ONE TOUCH		
1 = OT1	2 = OT2	3 = OT3
4 = OT4	5 = OT5	6 = OT6
7 = OT7	8 = OT8	9 = OT9
10 = OT10		
AUTO DIAL		
01 = AD1	02 = AD2	03 = AD3
04 = AD4	05 = AD5	06 = AD6
07 = AD7	08 = AD8	09 = AD9
10 = AD10	11 = AD11	12 = AD12
13 = AD13	14 = AD14	15 = AD15
16 = AD16	17 = AD17	18 = AD18
19 = AD19	20 = AD20	21 = AD21
22 = AD22	23 = AD23	24 = AD24
25 = AD25	26 = AD26	27 = AD27
28 = AD28	29 = AD29	30 = AD30
31 = 31	32 = 32	33 = 33
34 = 34	35 = 35	36 = 36
37 = 37	38 = 38	39 = 39
40 = 40	41 = 41	42 = 42
43 = 43	44 = 44	45 = 45
46 = 46	47 = 47	48 = 48
49 = 49	50 = 50	51 = 51
52 = 52	53 = 53	54 = 54
55 = 55	56 = 56	57 = 57
58 = 58	59 = 59	60 = 60
61 = 61	62 = 62	63 = 63
64 = 64	65 = 65	66 = 66
67 = 67	68 = 68	69 = 69
70 = 70		
KEYPAD *1		
1234		
2345		
3456		
4567		

*1 MAX.10 Locations

Fig. 4-5-9 Broadcast Entry Report

BROADCAST CONFIRMATION REPORT

07/01/1998 17:05
ID=OKI

PAGES = 01
START TIME = 07/01 17:02
TOTAL TIME = 00:02'30"

	LOCATION ID	PAGES	RESULT	LOCATION ID	PAGES	RESULT
ONE TOUCH						
	1 = HEAD OFFICE	01	OK	2 = OT2	01	OK
	3 = OT3	01	OK	4 = OT4	01	OK
	5 = OT5	01	OK			
AUTO DIAL						
	01 = AD1	01	OK	02 = AD2	01	OK
	03 = AD3	01	OK	04 = GERMAN	01	OK
	05 = AD5	01	OK			
KEYPAD						
	1234	01	OK			
	3456	01	OK			
	5678	01	OK			

Fig. 4-5-10 Broadcast Confirmation Report

POWER OUTAGE REPORT

07/01/1998 17:05
ID=OKI

DATE	TIME	S,R-TIME	DISTANT STATION ID	MODE	PAGES	RESULT	
06/30	10:10		0485-88-3385			LOST	9080
06/30	10:30		ODS TAKASAKI		03	LOST	0000
06/30	12:05	01'20"	OKI FAX	CONF=01	03	LOST	0000
06/30	13:00	00'20"	03-5476-4300	CALLED	01	LOST	0000
06/30	10:50	01'20"	0495-22-5400	CALLED	03	LOST	0000
06/30	15:00			B.C.	01	LOST	

Note: Memory receipt only is printed on the mode in the report as called.

Fig. 4-5-11 POWER OUTAGE REPORT

CONFIDENTIAL RX REPORT

07/01/1998 17:05
ID=OKI

DATE	TIME	S,R-TIME	DISTANT STATION ID	MODE	PAGES	RESULT	
07/01	00:20	00'00"	OKI FAX	CONF=01	02	OK	0000

Fig. 4-5-12 Confidential RX Report

07/01/1998

09:24

OKI SHIBAURA → OKI HONJO

NO.002

PLEASE CALL BACK

OKI SHIBAURA

☎03 5476 1234

Fig. 4-5-13 Call Back Message

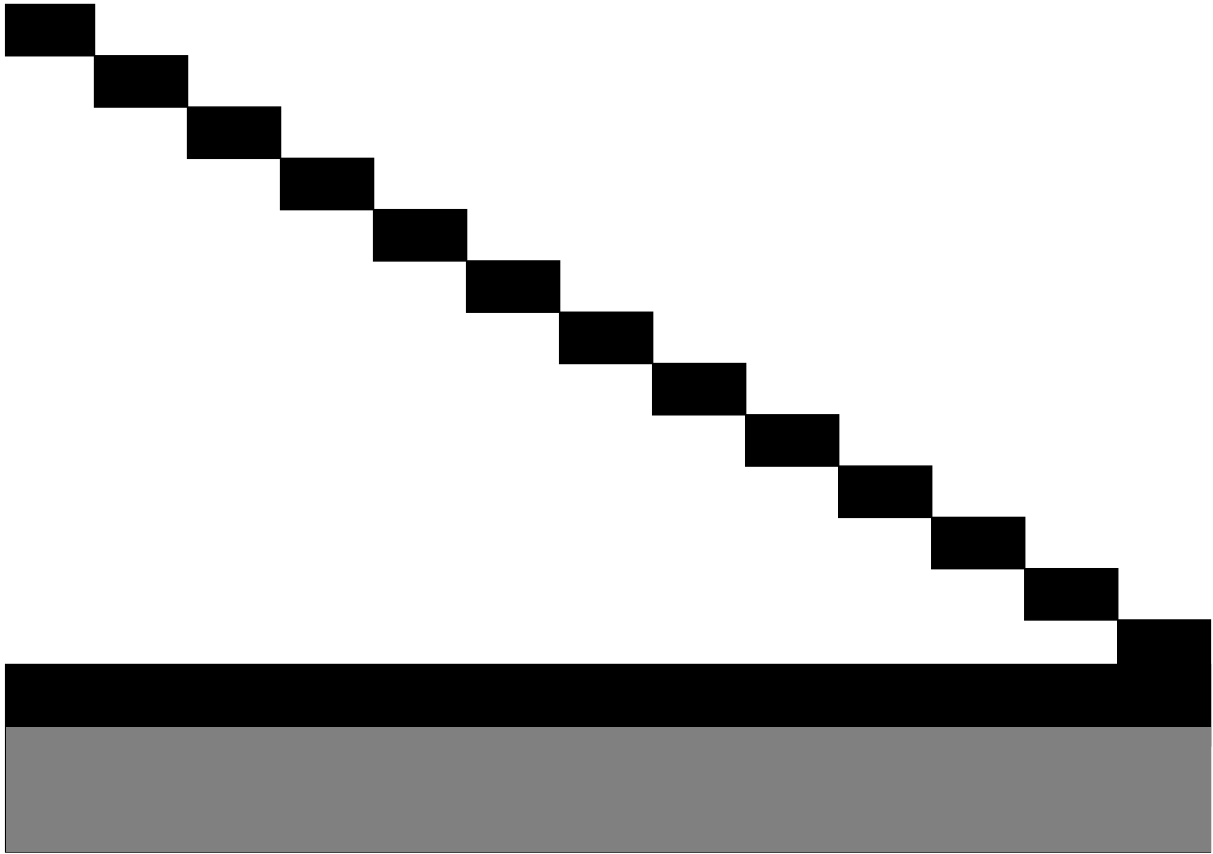

```
CPU-ROM  VERSION  AA00
          HASH     OK   DACD
CPU-RAM   VERSION  OK
PROGRAM  VERSION  AA00
          HASH     OK   3142

LANGUAGE  VERSION  LL10
          HASH     OK   3F06
DEFAULT  VERSION  DD10
          HASH     OK   A683
*1 RAM1   VERSION  2.5M OK
*2 RAM2   VERSION  OK
DEFAULT  TYPE     01   07/01/1998 10:30
```

*1 marked item is shown for condition of all RAM except EXCEED RAM.
*2 marked item is shown to SRAM for EXCEED.

Fig. 4-5-14 Self Diagonosis

Transmission (Except Polling TX)

	Single Loc. TX	Broadcast TX	Delayed TX	Confidential TX	Relay Broadcast Initiate	Manual TX	Chain Dialing	Automatic Alternate Selecting Call	Closed User Group	Page Retransmit	Redial if Communication Error in Memory TX	Sender ID	Voice Request (Initiate)	Voice Request (Reception)	Call Back Message	Broadcast Entry Report	MCF (Single)	MCF (Error)	MCF (Multi)	MCF (with Image)	
Feeder TX	○	×	○	○	○	○	○	○	○	×	×	○	○	○	○	○	○	○	○	○	×
Instant Dialing	○	×	×	○	○	×	○	○	○	○	○	○	×	×	○	○	○	○	×	×	×
Memory TX	○	○	○	○	○	×	○	○	○	○	○	○	×	×	○	○	○	○	○	○	○
Single Loc. TX	○	×	○	○	○	○	○	○	○	○	○	○	○	○	○	○	○	○	○	○	○
Broadcast TX	○	○	○	×	×	×	×	×	○	○	○	○	×	×	○	○	○	○	○	○	○
Delayed TX	○	○	○	×	×	×	×	×	○	○	○	○	×	×	○	○	○	○	○	○	○
Confidential TX	○	○	○	○	×	×	×	×	○	○	○	○	×	×	○	○	○	○	○	○	○
Relay Broadcast Initiate	○	○	○	○	×	×	×	×	○	○	○	○	×	×	○	○	○	○	○	○	○
Manual TX	○	○	○	○	○	○	○	○	○	○	○	○	○	○	○	○	○	○	○	○	○
Chain Dialing	○	○	○	○	○	○	○	×	○	○	○	○	○	○	○	○	○	○	○	○	○
Automatic Alternate Selecting Call	○	○	○	○	○	○	○	○	○	○	○	○	○	○	○	○	○	○	○	○	○
Closed User Group	○	○	○	○	○	○	○	○	○	○	○	○	○	○	○	○	○	○	○	○	○
Page Retransmit	○	○	○	○	○	○	○	○	○	○	○	○	○	○	○	○	○	○	○	○	○
Redial if Communication Error in Memory TX	○	○	○	○	○	○	○	○	○	○	○	○	○	○	○	○	○	○	○	○	○
Sender ID	○	○	○	○	○	○	○	○	○	○	○	○	○	○	○	○	○	○	○	○	○
Voice Request (Initiate)	○	○	○	○	○	○	○	○	○	○	○	○	○	○	○	○	○	○	○	○	○
Voice Request (Reception)	○	○	○	○	○	○	○	○	○	○	○	○	○	○	○	○	○	○	○	○	○
Call Back Message	○	○	○	○	○	○	○	○	○	○	○	○	○	○	○	○	○	○	○	○	○
Broadcast Entry Report	○	○	○	○	○	○	○	○	○	○	○	○	○	○	○	○	○	○	○	○	○
MCF (Single)	○	○	○	○	○	○	○	○	○	○	○	○	○	○	○	○	○	○	○	○	○
MCF (Error)	○	○	○	○	○	○	○	○	○	○	○	○	○	○	○	○	○	○	○	○	○

○ : Combination Possible
 × : Combination Impossible

*1 Only previous call origination
 *2 Depending on the conditions of image memory capacity.
 *3 TSI/CSI and Personal ID are impossible.
 *4 When memory full does not occur during reading.

Table 4-1 Multiple Function Combinations for Transmissions

Communication Mode		Functions	Automatic Alternate Selecting Call	Closed Network	Sender ID *4	Page Retransmit	Voice Request (Initiate)	Stop	Voice Request (Reception)	TX Preparation	Call Back Message	Redial if Communication Error in Memory TX		
TX	Feeder	Manual Calling	X	○	○	X	○	○	○	X *1	○	X		
		Automatic Call Origination	Confidential Initiate	X	○	X	X	○	○	X	X *1	X	X	
			Relay Broadcast Initiate	X	○	○ *2	X	X	○	○	X *1	X	X	
			Delayed	○	○	○	X	○	○	○	X *1	○	X	
	Auto Reception	Polled	X	○	○	X	X	○	X	X *1	X	X		
	Memory	Automatic Call Origination	Single	○	○	○	○ *3	X	○	X	○	X	○	
			Delayed	○	○	○ *2	○ *3	X	○	X	○	X	○	
		Single	Broadcast	○	○	○	○ *3	X	○	X	○	X	○	
			Delayed	○	○	○ *2	○ *3	X	○	○	X	○	○	
	Instant dialing (single)	Poll	X	○	○	X	○	○	○	X	○	X	X	
○			○	○	○ *6	X	○	○	X	X *1	X	○ *5		
RX	Memory	Functions	Automatic Alternate Selecting Call	Closed Network	TSI/ TIME/DATE Printing	In-between Memory Reception	Voice Request (Initiate)	Stop	Voice Request (Reception)	TX Preparation				
			Manual/ Automatic	Confidential	○	○	X	X	X	X	○			
				Memory Only Reception	○	○	○	X	X	X	X	○		
				Initial Memory Reception	○	○	○	X	X	X	X	○		
	Paper	Automatic Call Origination	X	○	○	○	○	○	X	○	○			
			Polling	○	○	○	○	○	X	X	○	○		

Table 4-4 Function Combinations during Communications

*1: It is possible after the end of scanning.
 *2: Remote locations are not displayed.
 *3: In case of Non-ECM mode.
 *4: Session number is available.
 *5: Depending on the conditions of memory available.
 *6: TSI/CSI and Personal ID are not displayed.

		PC1 ON				
		Reception	Prefeed	Remote input display	Preparation TX	Scanning to Memory
1'st		2'nd				
ON HOOK	Standby	○	○	○	○	○
	During FAX Calling	×	○	×	×	○
Call Reception	During RING RESPONSE	×	○	○	○	○
	During detection of TEL/FAX	×	○	×	×	×
	During TAD detection	×	○	×	×	×
	1st Phase B	×	○	○	○	○
Feeder TX	Calling ~ Transmission	×	×	×	×	○
	Transmission after scanning	×	○	○	○	○
Memory TX	During Scanning	○	×	×	×	○
	Dialling and Calling	×	○	○	○	○
	During TX	×	○	○	○	○
Polling RX	Dialling and Calling	×	○	○	○	○
Memory RX		×	○	○	○	○
Paper RX	Reception and print	×	○	○	○	○
	Residual Print Processing	○	○	○	○	○
	Memory reception	×	○	○	○	○
During voice request is initiated.		×	○	×	×	×
During copy		○	○	×	×	×
During automatic printing of received messages		○	○	○	○	○
During automatic printing of reports		○	○	○	○	○
During operation		×	○	×	×	×

* Operation during communication is not determined yet.

Table 4-5 Preparation TX as Dual Access

No.	User Setting Items	Setting Selection	1	2	3	4	5	6	7	8	9	10	11	12	13
			ODA	LTA	E-INT	E-GER	E-FRE	0-AUS	0-NZL	0-SIN	0-HNG	L-AG	IRL	DEN	SWE
1	MCF (single-loc.)	ON/OFF	OFF	OFF	OFF	ON	OFF	OFF	ON	OFF	OFF	OFF	OFF	ON	OFF
2	MCF (multi-loc.)	ON/OFF	ON	ON	OFF	ON	OFF	OFF	ON	OFF	OFF	OFF	OFF	ON	ON
3	ERR.REPORT (MCF.)	ON/OFF	ON	ON	OFF	ON	OFF	ON	ON	ON	OFF	OFF	OFF	ON	ON
4	IMAGE IN MCF.	ON/OFF	ON	ON	ON	ON	ON	ON	ON	ON	ON	ON	ON	ON	ON
5	SENDER ID	ON/OFF	ON	ON	ON	ON	ON	ON	ON	ON	ON	ON	ON	ON	ON
6	MONITOR VOLUME	OFF/LOW/HIGH	LOW	LOW	LOW	LOW	LOW	LOW	LOW	LOW	LOW	LOW	LOW	LOW	LOW
7	BUZZER VOLUME	LOW/MID/HIGH	MID	MID	MID	MID	MID	MID	MID	MID	MID	MID	MID	MID	MID
8	CLOSED NETWORK	OFF/T/R / RX	OFF	OFF	OFF	OFF	OFF	OFF	OFF	OFF	OFF	OFF	OFF	OFF	OFF
9	TX MODE DEFAULT	STD/FINE/EX-FINE/PHOTO NORMAL/DARK/LIGHT	STD	STD	STD	STD	FINE	STD	STD	STD	STD	STD	STD	STD	STD
10	T/F TIMER PRG.	20 sec/35 sec	35	20	20	35	20	35	35	35	35	35	20	20	20
11	RING RESPONSE	1 ring/5 sec/10 sec/15 sec/20 sec	1 ring	1 ring	1 ring	1 ring	1 ring	1 ring	1 ring	1 ring	1 ring	1 ring	1 ring	1 ring	1 ring
12	DISTINCTIVE RING	OFF/ON/SET	OFF	OFF	OFF	OFF	OFF	OFF	OFF	OFF	OFF	OFF	OFF	OFF	OFF
13	1'ST PAPER SIZE	A4/LET./LGL13/LGL14/OTHER	LET	LET	A4	A4	A4	A4	A4	A4	A4	LET	A4	A4	A4
14	USER LANGUAGE	LNG1/LNG2	LNG1	LNG1	LNG1	LNG2	LNG2	LNG1	LNG1	LNG1	LNG1	LNG1	LNG1	LNG2	LNG2
15	INCOMING RING	OFF/ON/DRC	ON	OFF	ON	ON	ON	ON	ON	ON	ON	OFF	OFF	OFF	ON
16	REMOTE RECEIVE	OFF/00/11/22/33/...../88/99/**/##	OFF	OFF	OFF	OFF	OFF	OFF	**	OFF	OFF	OFF	OFF	**	11
17	MEM./FEED SWITCH	MEMORY/FEEDER	FEED	MEM.	MEM.	MEM.	MEM.	MEM.	MEM.	MEM.	MEM.	MEM.	MEM.	MEM.	MEM.
18	POWER SAVE MODE	ON/OFF	OFF	OFF	ON	ON	OFF	OFF	OFF	OFF	OFF	OFF	OFF	OFF	OFF
19	ECM FUNCTION	ON/OFF	ON	ON	ON	ON	ON	ON	ON	ON	ON	ON	ON	ON	ON
20	REMOTE DIAGNOSIS	ON/OFF	OFF	OFF	OFF	OFF	OFF	ON	ON	OFF	OFF	OFF	OFF	OFF	ON
21	PC/FAX SWITCH	ON/OFF	ON	OFF	OFF	OFF	OFF	OFF	OFF	OFF	OFF	OFF	OFF	OFF	OFF
22	NO TONER MEM. RX	ON/OFF	OFF	OFF	ON	OFF	OFF	OFF	OFF	ON	OFF	OFF	OFF	OFF	ON
23	MEM. FULL SAVE	ON/OFF	OFF	OFF	OFF	OFF	OFF	OFF	OFF	OFF	OFF	OFF	OFF	OFF	OFF
24	CONTINUOUS TONE	ON/OFF	OFF	OFF	OFF	OFF	OFF	OFF	OFF	OFF	OFF	ON	OFF	OFF	OFF
25	INSTANT DIALING	ON/OFF	ON	ON	ON	ON	ON	ON	ON	ON	ON	ON	ON	ON	ON
26	RESTRICT ACCESS	ON/OFF	OFF	OFF	OFF	OFF	OFF	OFF	OFF	OFF	OFF	OFF	OFF	OFF	OFF
27	WIDTH REDUCTION	ON/OFF	OFF	OFF	OFF	OFF	OFF	OFF	OFF	OFF	OFF	OFF	OFF	OFF	OFF
28	ONE TOUCH PARAM.	ON/OFF (ECHO & ignore 1st DIS)	OFF	OFF	OFF	OFF	OFF	OFF	OFF	OFF	OFF	OFF	OFF	OFF	OFF

Note: Item numbers will be skipped when the respective bits of XPARA in PTT parameters are off and also the service bit=OFF.
All of the numbers 1-27 of user setting are controllable to skip or not by the XPARA setting.
The contents of tables are subject to change by the requests of OEM companies and customers without notice.cd

Table 4-6-1/2 User Default Setting

No.	User Setting Items	Setting Selection	14 NOR	15 SUI	16 AUT	17 HOL	18 ITA	19 ESP	20 Spare	(21) Factory
1	MCF (single-loc.)	ON/OFF	ON	ON	ON	OFF	OFF	OFF	OFF	OFF
2	MCF (multi-loc.)	ON/OFF	OFF	ON	ON	ON	ON	OFF	OFF	OFF
3	ERR.REPORT (MCF.)	ON/OFF	ON	ON	ON	OFF	OFF	ON	OFF	OFF
4	IMAGE IN MCF.	ON/OFF	ON	ON	ON	ON	ON	ON	ON	ON
5	SENDER ID	ON/OFF	ON	ON	ON	ON	ON	ON	ON	ON
6	MONITOR VOLUME	OFF/LOW/HIGH	OFF	LOW	LOW	LOW	HIGH	HIGH	LOW	HIGH
7	BUZZER VOLUME	LOW/MID/HIGH	MID	MID	MID	MID	HIGH	MID	MID	HIGH
8	CLOSED NETWORK	OFF/T/R / RX	OFF	OFF	OFF	OFF	OFF	OFF	OFF	OFF
9	TX MODE DEFAULT	STD/FINE/EX-FINE/PHOTO NORMAL/DARK/LIGHT	STD NOR	STD NOR	STD NOR	STD NOR	STD NOR	STD NOR	STD NOR	STD NOR
10	T/F TIMER PRG.	20 sec/35 sec	35	35	35	20	35	35	20	35
11	RING RESPONSE	1 ring/5 sec/10 sec/15 sec/20 sec	1 ring	5 sec	1 ring	1 ring	1 ring	1 ring	1 ring	1 ring
12	DISTINCTIVE RING	OFF/ON/SET	OFF	OFF	OFF	OFF	OFF	OFF	OFF	OFF
13	1ST PAPER SIZE	A4/LET./LGL13/LGL14/OTHER	A4	A4	A4	A4	A4	A4	A4	LET
14	USER LANGUAGE	LNG1/LNG2	LNG2	LNG2	LNG2	LNG2	LNG2	LNG2	LNG1	LNG1
15	INCOMING RING	OFF/ON/DRC	ON	ON	ON	ON	ON	ON	ON	ON
16	REMOTE RECEIVE	OFF/00/11/22/33/...../88/99/**/##	OFF	OFF	OFF	OFF	OFF	OFF	OFF	OFF
17	MEM./FEED SWITCH	MEMORY/FEEDER	MEM.	MEM.	MEM.	MEM.	MEM.	MEM.	MEM.	FEED
18	POWER SAVE MODE	ON/OFF	OFF	ON	ON	ON	OFF	OFF	OFF	OFF
19	ECM FUNCTION	ON/OFF	ON	ON	ON	ON	ON	ON	ON	ON
20	REMOTE DIAGNOSIS	ON/OFF	OFF	OFF	OFF	OFF	OFF	OFF	OFF	ON
21	PC/FAX SWITCH	ON/OFF	OFF	OFF	OFF	OFF	OFF	OFF	OFF	OFF
22	NO TONER MEM. RX	ON/OFF	ON	OFF	OFF	OFF	ON	OFF	OFF	OFF
23	MEM. FULL SAVE	ON/OFF	OFF	OFF	OFF	OFF	OFF	OFF	OFF	OFF
24	CONTINUOUS TONE	ON/OFF	OFF	OFF	OFF	OFF	OFF	OFF	OFF	OFF
25	INSTANT DIALING	ON/OFF	ON	ON	ON	ON	ON	ON	ON	ON
26	RESTRICT ACCESS	ON/OFF	OFF	OFF	OFF	OFF	OFF	OFF	OFF	OFF
27	WIDTH REDUCTION	ON/OFF	OFF	OFF	OFF	OFF	OFF	OFF	OFF	OFF
28	ONE TOUCH PARAM.	ON/OFF (ECHO & ignore 1st DIS)	OFF	OFF	OFF	OFF	OFF	OFF	OFF	OFF

Note: Item numbers will be skipped when the respective bits of XPARAM in PTT parameters are off and also the service bit=OFF.
All of the numbers 1-27 of user setting are controllable to skip or not by the XPARAM setting.
The contents of tables are subject to change by the requests of OEM companies and customers without notice.

Table 4-6-2/2 User Default Setting

No.	Technical Setting Items	Setting Selection	1 ODA	2 LTA	3 E-INT	4 GER	5 E-FRE	6 O-AUS	7 O-NZL	8 O-SIN	9 O-HNG	10 L-AG	11 IRL	12 DEN	13 SWE	Note
1	SERVICE BIT	ON/OFF	OFF	ON	OFF	OFF	OFF	OFF	OFF	ONCE	OFF	OFF	OFF	OFF	OFF	
2	MONITOR CONT.	ON/OFF	OFF	OFF	OFF	OFF	OFF	OFF	OFF	OFF	OFF	OFF	OFF	OFF	OFF	
3	COUNTRY CODE	USA INT'L GBR IRL NOR SWE FIN DEN GER HUN TCH POL SUI AUT BEL HOL FRE POR ESP ITA GRE AUS NZL SIN HNG, LTA, MEX	USA	LTA	GBR	GER	FRE	AUS	NZL	SIN	HNG	USA	IRL	DEN	SWE	
4	TIME/DATE PRINT	0: OFF/1: ONCE/2: ALL	OFF	OFF	OFF	ALL	OFF	OFF	ALL	ONCE	OFF	OFF	OFF	ONCE	ONCE	
5	TSI PRINT	ON/OFF	ON	ON	ON	ON	ON	ON	ON	ON	ON	ON	ON	ON	ON	
6	TAD MODE	0: OFF/1: TYPE1/2: TYPE2/3: TYPE3	TYPE2	TYPE2	OFF	TYPE1	TYPE1	OFF	TYPE1	OFF	OFF	TYPE2	OFF	TYPE2	TYPE2	
7	REAL TIME DIAL	0: OFF/1: TYPE1/2: TYPE2	TYPE2	TYPE2	TYPE2	TYPE2	TYPE2	TYPE2	TYPE2	TYPE2	TYPE2	TYPE2	TYPE2	TYPE2	TYPE2	By PTT Parameter
8	TELFAX SW	ON/OFF	ON	ON	ON	ON	ON	ON	ON	ON	ON	ON	ON	ON	ON	
9	MDY/DMY	0: MDY/1: DMY	MDY	MDY	DMY	DMY	DMY	DMY	DMY	DMY	DMY	MDY	DMY	MDY	MDY	
10	LONG DOC. SCAN	ON/OFF	OFF	OFF	OFF	ON	ON	OFF	OFF	OFF	OFF	OFF	ON	OFF	OFF	
11	TO NE FOR ECHO	ON/OFF	OFF	OFF	OFF	OFF	OFF	OFF	OFF	OFF	OFF	OFF	OFF	OFF	OFF	
12	MH ONLY	ON/OFF	OFF	OFF	OFF	OFF	OFF	OFF	OFF	OFF	OFF	OFF	OFF	OFF	OFF	
13	HIMODEM RATE	14.4K/9.6K/4.8K	14.4K	14.4K	14.4K	14.4K	14.4K	14.4K	14.4K	14.4K	14.4K	14.4K	14.4K	14.4K	14.4K	
14	T1(TX) TIMER VALUE	010 - 255 sec	59	59	60	60	140	30	40	60	30	59	60	60	60	By PTT Parameter
15	T1(RX) TIMER VALUE	010 - 255 sec	35	35	35	35	35	35	35	35	35	35	35	35	35	
16	T2 TIMER VALUE	001 - 255 (100ms - 25.5 sec)	130	130	130	60	51	130	130	130	130	130	130	130	130	Base Timer=100ms
17	DIS BIT 32	ON/OFF	ON	ON	ON	ON	ON	ON	ON	ON	ON	ON	ON	ON	ON	
18	ERR. CRITERION	0 - 99	10	10	10	10	10	10	10	10	10	10	10	10	10	
19	OFF HOOK BYPASS	ON/OFF	OFF	OFF	OFF	OFF	OFF	OFF	OFF	OFF	OFF	OFF	OFF	OFF	OFF	
20	NL EQUALIZER	0km/ 1.8km/3.6km/7.2km	0km	0km	0km	0km	0km	0km	0km	0km	0km	0km	0km	0km	0km	
21	ATTENUATOR	0 - 15dB	10dB	10dB	11dB	9dB	10dB	11dB	11dB	11dB	11dB	10dB	11dB	10dB	11dB	
22	T/F TONE ATT	0 - 15dB	10dB	10dB	9dB	7dB	11dB	9dB	9dB	9dB	9dB	10dB	9dB	10dB	9dB	
23	MF. ATT	0 - 15dB	3dB	8dB	6dB	7dB	5dB	5dB	6dB	5dB	8dB	3dB	5dB	8dB	8dB	
24	RING DURA. *10MS	10 - 99 (*10 ms)	12	12	14	14	60	12	14	14	14	12	14	12	14	
25	CML TIMING *100MS	1 - 19 (*100 ms)	3	3	3	3	15	3	12	12	12	3	3	3	1	
26	HEAD STROBE	00000 - 11111	10100	10100	10100	10100	10100	10100	10100	10100	10100	10100	10100	10100	10100	
27	HEAD WIDTH	TYPE1/TYP2	TYPE1	TYPE1	TYPE1	TYPE1	TYPE1	TYPE1	TYPE1	TYPE1	TYPE1	TYPE1	TYPE1	TYPE1	TYPE1	
28	MEDIA TYPE	M/MH/H	M	M	M	M	M	M	M	M	M	M	M	M	M	
29	TR LATCH CURRENT	-2/-1/0/+1/+2	0	0	0	0	0	0	0	0	0	0	0	0	0	
30	NSF SWITCH	ON/OFF	ON	ON	ON	ON	ON	ON	ON	ON	ON	ON	ON	ON	ON	
31	ID/TSI PRIORITY	ID/TSI	ID	ID	ID	TSI	ID	ID	ID	ID	ID	ID	ID	ID	ID	
32	TONE COUNT CLEAR	ON/OFF	OFF	OFF	OFF	OFF	OFF	OFF	OFF	OFF	OFF	OFF	OFF	OFF	OFF	
33	PARALLEL PICK UP	ON/OFF	ON	ON	ON	OFF	ON	ON	OFF	ON	ON	ON	ON	ON	ON	

Note: E-XXX=OEL-XXX, O-XXX=OKI-XXX, L-XXX=LANIER-XXX

The contents of tables are subject to change by the requests of OEM companies and customers without notice.

Table 4-7-1/2 Technical Default Setting

No.	Technical Setting Items	Setting Selection	14 NOR	15 SUI	16 AUT	17 HOL	18 ITA	19 ESP	20 Spare	21 Factory	Note
1	SERVICE BIT	ON/OFF	OFF	OFF	OFF	OFF	OFF	OFF	OFF	ON	
2	MONITOR CONT.	ON/OFF	OFF	OFF	OFF	OFF	OFF	OFF	OFF	ON	
3	COUNTRY CODE	USA INTL GBR IRL NOR SWE FIN DEN GER HUN TCH POL SUI AUT BEL HOL FRE POR ESP ITA GRE AUS NZL SIN HNG, LTA, MEX	NOR	SUI	AUT	HOL	ITA	ESP	USA	INTL	
4	TIME/DATE PRINT	0: OFF/1: ONCE/2: ALL	OFF	ALL	ALL	ONCE	ALL	ONCE	OFF	ONCE	
5	TSI PRINT	ON/OFF	ON	ON	ON	ON	ON	ON	ON	ON	
6	TAD MODE	0: OFF/1: TYPE1/2: TYPE2/3: TYPE3	OFF	TYP1	TYP1	TYP1	OFF	TYP2	TYP2	OFF	
7	REAL TIME DIAL	0: OFF/1: TYPE1/2: TYPE2	TYP2	TYP2	TYP2	TYP2	TYP2	TYP2	TYP2	TYP2	By PTT Parameter
8	TEL/FAX SW	ON/OFF	ON	ON	ON	ON	ON	ON	ON	ON	
9	MDY/DMY	0: MDY/1: DMY	DMY	DMY	DMY	DMY	DMY	DMY	MDY	MDY	
10	LONG DOC. SCAN	ON/OFF	OFF	ON	ON	OFF	OFF	OFF	OFF	OFF	
11	TOPE FOR ECHO	ON/OFF	OFF	OFF	OFF	OFF	OFF	OFF	OFF	OFF	
12	MH ONLY	ON/OFF	OFF	OFF	OFF	OFF	OFF	OFF	OFF	OFF	
13	HIMODEM RATE	14.4K/9.6K/4.8K	14.4K	14.4K	14.4K	14.4K	14.4K	14.4K	14.4K	14.4K	
14	T1(TX) TIMER VALUE	010 - 255 sec	60	60	60	60	40	45	59	60	By PTT Parameter
15	T1(RX) TIMER VALUE	010 - 255 sec	35	35	35	35	35	35	35	35	
16	T2 TIMER VALUE	001 - 255 (100ms - 25.5 sec)	130	130	130	60	60	130	130	130	Base Timer=100ms
17	DIS BIT 32	ON/OFF	ON	ON	ON	ON	ON	ON	ON	ON	
18	ERR. CRITERION	0 - 99	10	10	10	10	10	10	10	10	
19	OFF HOOK BYPASS	ON/OFF	OFF	OFF	OFF	OFF	OFF	OFF	OFF	ON	
20	NL EQUILIZER	0km/1.8km/3.6km/7.2km	0km	0km	0km	0km	0km	0km	0km	0km	
21	ATTENUATOR	0 - 15dB	10dB	9dB	9dB	11dB	8dB	11dB	10dB	10dB	
22	T/F TONE ATT	0 - 15dB	9dB	7dB	7dB	10dB	12dB	10dB	10dB	10dB	
23	MF ATT	0 - 15dB	8dB	1dB	4dB	8dB	4dB	5dB	3dB	8dB	
24	RING DURA. *10MS	10 - 99 (*10 ms)	14	14	11	14	14	14	10	12	
25	CML TIMING *100MS	1 - 19 (*100 ms)	3	3	3	11	3	3	3	3	
26	HEAD STROBE	00000 - 11111	10100	10100	10100	10100	10100	10100	10100	10100	
27	HEAD WIDTH	TYPE1/TYPE2	TYPE1	TYPE1	TYPE1	TYPE1	TYPE1	TYPE1	TYPE1	TYPE1	
28	MEDIA TYPE	MM/HH	M	M	M	M	M	M	M	M	
29	TR LATCH CURRENT	-2/-10/+1/+2	0	0	0	0	0	0	0	0	
30	NSF SWITCH	ON/OFF	ON	ON	ON	ON	ON	ON	ON	ON	
31	ID/TSI PRIORITY	ID/TSI	ID	TSI	TSI	ID	ID	ID	ID	ID	
32	TONER COUNT CLEAR	ON/OFF	OFF	OFF	OFF	OFF	OFF	OFF	OFF	OFF	
33	PARALLEL PICK UP	ON/OFF	ON	OFF	OFF	OFF	ON	OFF	ON	ON	

Note: E-XXX=OEL-XXX, O-XXX=OKI-XXX, L-XXX=LANIER-XXX
The contents of tables are subject to change by the requests of OEM companies and customers without notice.

Table 4-7-2/2 Technical Default Setting

No.	User Setting Items	Setting Selection	COUNTRY CODE																												
			1 USA	2 INT'L	3 GBR	4 IRL	5 NOR	6 SWE	7 FIN	8 DEN	9 GER	10 HUN	11 TCH	12 POL	13 SUI	14 AUT	15 BEL	16 HOL	17 FRE	18 POR	19 ESP	20 ITA	21 GRE	22 AUS	23 NZL	24 SIN	25 HNG	26 LTA	27 MEX		
1	REDIAL TRIES	0 - 10 TRIES	3	3	2	2	5	10	3	5	10	2	2	10	10	3	2	2	2	2	2	2	2	2	2	2	2	2	2	3	
2	REDIAL INTERVAL	1 - 6 min	3	3	3	3	2	3	1	3	1	3	3	1	1	3	3	3	6	3	3	3	3	3	3	3	3	3	3	3	
3	DIAL TONE DETECT	ON/OFF	OFF	ON	ON	ON	ON	ON	ON	ON	ON	ON	ON	ON	ON	ON	ON	ON	ON	OFF	OFF	ON	ON	ON	ON	ON	ON	ON	OFF	OFF	
4	BUSY TONE DETECT	ON/OFF	ON	ON	OFF	ON	ON	ON	ON	ON	OFF	ON	ON	ON	ON	ON	ON	ON	ON	ON	ON	ON	ON	ON	ON	ON	ON	ON	ON	ON	
5	MF (TONE)/DP (PULSE)	DP/MF	MF	MF	MF	MF	MF	MF	MF	MF	DP	MF	DP	MF	DP	MF	MF	MF	MF	DP	MF	MF	MF	MF	MF	MF	MF	MF	MF	MF	
6	PULSE DIAL RATE	10 PPS/16 PPS/ 20 PPS	10	10	10	10	10	10	10	10	10	10	10	10	10	10	10	10	10	10	10	10	10	10	10	10	10	10	10	10	
7	PULSE MAKE RATIO	33%/39%	39%	39%	33%	33%	33%	39%	39%	39%	33%	39%	33%	39%	39%	33%	39%	39%	33%	33%	33%	39%	39%	33%	33%	33%	33%	33%	39%	39%	
8	PULSE DIAL TYPE	N/0-N/N+1	N	N	N	N	N	N	N	N	N	N	N	N	N	N	N	N	N	N	N	N	N	N	N	N	N	N	N	N	
9	MF (TONE) DURATION	75 ms/85 ms/100 ms	100	85	85	85	75	85	100	100	100	100	100	85	85	85	100	100	75	85	85	85	100	85	85	85	85	85	100	100	
10	PBX LINE	ON/OFF	OFF	OFF	OFF	OFF	OFF	OFF	OFF	OFF	OFF	OFF	OFF	OFF	OFF	OFF	OFF	OFF	OFF	OFF	OFF	OFF	OFF	OFF	OFF	OFF	OFF	OFF	OFF	OFF	
11	FLASH/EARTH/NORMAL	NORMAL/FLASH/ EARTH	N	N	N	N	N	N	N	N	N	N	N	N	N	N	N	N	N	FLASH	N	N	N	N	N	N	N	N	N	N	N
12	AUTO START	ON/OFF	ON	OFF	OFF	OFF	ON	ON	ON	ON	ON	OFF	OFF	ON	ON	OFF	OFF	OFF	OFF	ON	ON	ON	OFF	ON	ON	ON	ON	ON	ON	ON	ON
13	DIAL PREFIX	OFF/(max. 4 digits)	OFF	OFF	OFF	OFF	OFF	OFF	OFF	OFF	OFF	OFF	OFF	0...	0...	OFF	OFF	OFF	OFF	OFF	OFF	OFF	OFF	OFF	OFF	OFF	OFF	OFF	OFF	OFF	

Note: User settings are possible for items without mesh.

The contents of tables are subject to change by the requests of OEM companies and customers without notice.

Table 4-8 Default Setting of Dial Parameters

Model. Description ID for Plug & Play

No.	Close Setting Items	Setting Selection	1 ODA	2 ATT	3 E-INT	4 GER	5 E-FRE	6 0-AUS	7 0-NZL	8 0-SIN	9 0-HNG	10 L-AG	11 IRL	12 DEN	13 SWE	Note
1	Plug & Play ID Default	00/01/02/03/04	00	00	01	01	01	04	04	04	04	02	01	01	01	
			14 NOR	15 SUI	16 AUT	17 HOL	18 ITA	19 ESP	20 Spare	(21) Factory						
			01	01	01	01	01	01	00	00						

00 - ODA, 01 - OEL, 02 - Lanier, 03 - Telenor, 04 - OKI

Table 4-9 Plug & Play ID

5. DOCUMENT INPUT

5.1 Document Width

The automatic feeder will operate with the following widths:

Minimum 148 mm (ISO A5)

Maximum 216 mm (NA Letter)

5.2 Effective Reading Width

The effective reading width is listed in Table 5-1.

Table 5-1

Document Width	Communication mode/paper width	Copy size	Effective reading width
NA Letter (216 mm) US/CANADA	G3/A4	Letter	215 mm for TX 203.2 mm for local copy*
ISO A4 (210 mm) INT'L	G3/A4	A4	208 mm for TX 203.2 mm for local copy*

Note local copy: Printable reading width in local copy mode

*: Same printable reading width as TX is available in local copy mode when "width reduction" is set to on.

5.3 Transmitter Scanning Method

A 2592-bit Direct Contact Image sensor will be used to scan the document.

5.4 Transmit Document Length

The automatic document feeder will feed multiple sheets having a width and length not less than 128 mm.

The document to be transmitted will be limited to a length not greater than 356 mm (14 inches); however, the machine will also be capable of being set to 1500 mm.

5.5 Scanning Resolution

(1) Horizontal resolution

- 300 dots per inch in horizontal line.

(2) Vertical resolution

- 300 dots per inch, 15.4, 7.7, and 3.85 lines per millimeter in vertical direction.
(switch-selectable)

5.6 Automatic Document Feeder Capacity

The feeder will have the capacity to set and feed 20 documents sheets of new standard 20 pound bond Letter/A4 size paper and 15 document sheets of other size paper. The U.S. rating for paper weights will apply. (Refer to 5.8.1 for Base Weight.)

5.7 Contrast Control

The Light and Dark contrasts (low contrast) will be automatically enhanced to improve image quality.

Slice level shifting has 3 levels of switch selection on operation panel.

5.8 Input Document Characteristics

The machine will function with the following types of documents:

5.8.1 Base Weight

The machine will properly feed 20 document sheets of new standard 16 - 20 pound Letter /A4 size paper, and 15 documents of letter/A4-size with a base weight from 21 pounds to 28 pounds. The base weight is defined as the weight of 500 sheets of paper having rectangular dimensions of 431.8 mm (17 inches) by 558.8 mm (22 inches). A single sheet of 32 pounds base weight can be used.

5.8.2 Thickness

The machine will automatically feed 20 document sheets of letter/A4 size, each having a cross-sectional measurement between front and back surfaces ranging from 0.08 to 0.13 mm. A single sheet of from 0.06 to 0.15 mm can be fed.

Note: For reference purposes, Sections 5.8.1 and 5.8.2 are based on common bond paper. And printed paper by itself is available.

5.8.3 Opacity

The machine will properly reproduce documents which allow less than 40% of the scanner source light to pass through them.

5.8.4 Shape

The feeding mechanism requires that input documents be rectangular in shape. The registration of triangular, circular and wavy-edge documents cannot be guaranteed.

5.8.5 Document Condition

Slightly worn documents, such as those resulting from "normal office handling" will be accepted by the feeder without the use of a carrier. "Normal office handling" is defined to include staple holes, letter folds and minor corner folds, but excludes wrinkled copies.

5.9 Document Damage

The document will not be marked, wrinkled or torn as a result of being sent through the feeder or scanner.

5.10 Document Jam Detection

Transmission will stop and a line disconnection will occur when the end of the document is not detected within 356 mm after scanning begins (except if unlimited). A jam will also be declared if the document does not reach the scanning position within about 10 seconds after the start of a document feed, which will be fed automatically immediately after the document is set on the ADF.

Note: When a jam is detected during message transmission, the machine will stop, but its receiving capability will remain valid.

5.11 Feeder Reliability

Jam occurrence and misfeeds in the automatic document feeder will be less than one in 500 operations for all documents and conditions specified in Section 5.7 "Input Document Characteristics" except oily documents and printed paper by itself.

For oily documents and printed paper by itself, it will be met in Figure 5-1.

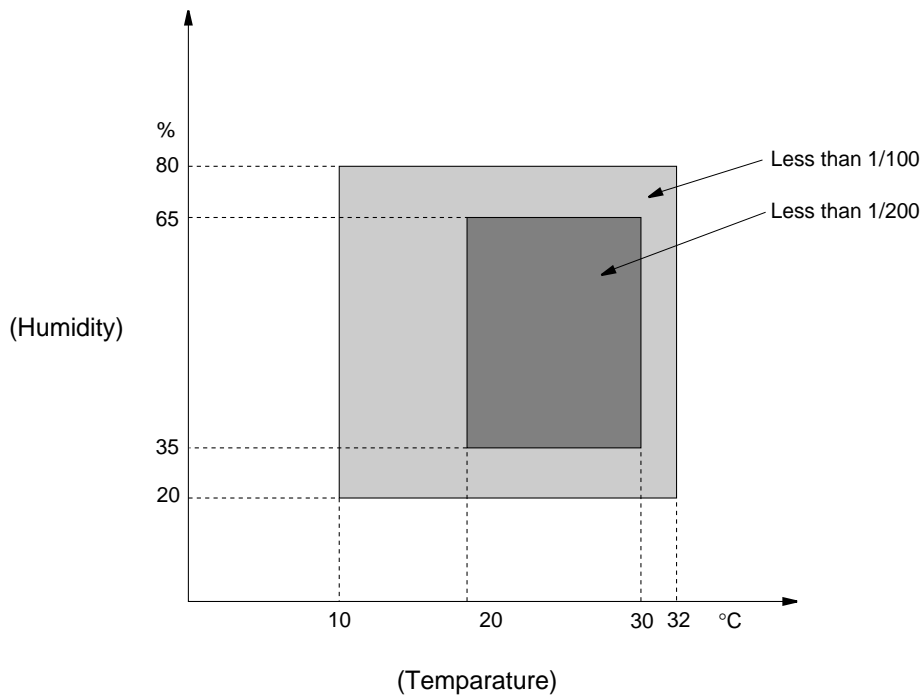

Figure 5-1

5.12 Document Jam Removal

A means will be provided for the operator to manually release the feed mechanism to aid in clearing a jam.

The operator will be able to clear 95% of all paper jams without tools or disassembly. The maximum number of operator-uncorrectable jams will be one in 10,000 of documents fed.

5.13 Document Skew

When documents are loaded correctly, there will be a maximum of 1 mm skew over any advance of 100 mm. The occurrence of skew exceeding 1 mm any advance of 100 mm shall be 0.5% or less. (Except printed paper by itself)

Due to the document skew, the extra-scanning area of background at the bottom 1-3 mm copy page will be less than 1 mm in length.

The occurrence of the extra scanning area of background more than 1 mm in length shall be 0.5 % or less. (Grand total of any kind of document.)

5.14 Document Stacking

Documents up to 297 mm in length, which meet the basic weight and thickness specification, will exit on the stacker, and documents of letter or A4-size will stack in sequence.

The documents will be placed on the feeder face down.

The first sheet will be fed into the feeder first and will exit on the stacker with printing side down.

5.15 Feeder Separation Rubber Useful Life

The separation rubber will not require replacement for at least 30,000 document feeds, providing documents and conditions meet the specifications in Section 5.8 "Input Document Characteristics".

6. DOCUMENT OUTPUT

6.1 Receive Printing Method

Electro-photographic recording method using a LED (light emitting diode) array as the light source.

6.2 Effective Recording Width

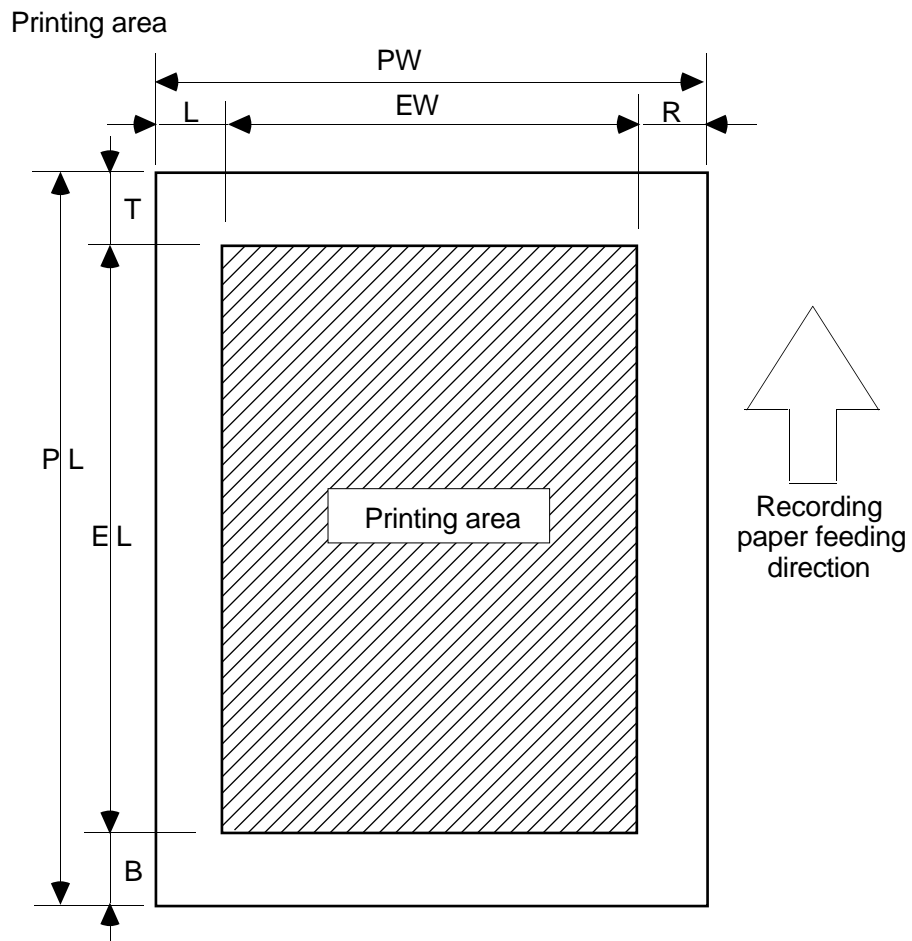

Table A

Printable area

	Letter Size		A4 Size		14 inch Legal Size		13 inch Legal Size	
	inch	mm	inch	mm	inch	mm	inch	mm
PL	11	279.4	11.7	297	14	355.6	13	330.2
PW	8.5	216	8.27	210	8.5	216	8.5	216
EL	10.76	273.4	11.46	291	13.76	349.6	12.76	324.2
EW	8.0	203.2	8.0	203.2	8.0	203.2	8.0	203.2
T	0.12	3	0.12	3	0.12	3	0.12	3
B	0.12	3	0.12	3	0.12	3	0.12	3
L	0.25	6.35	0.13	3.4	0.25	6.35	0.25	6.35
R	0.25	6.35	0.13	3.4	0.25	6.35	0.25	6.35

Guaranteed printing area

	Letter Size		A4 Size		14 inch Legal Size		13 inch Legal Size	
	inch	mm	inch	mm	inch	mm	inch	mm
PL	11	279.4	11.7	297	14	355.6	13	330.2
PW	8.5	216	8.27	210	8.5	216	8.5	216
EL	10.5	266.7	11.2	284.3	13.5	342.9	12.5	317.5
EW	8.0	203.2	7.77	197.3	8.0	203.2	8.0	203.2
T	0.25	6.35	0.25	6.35	0.25	6.35	0.25	6.35
B	0.25	6.35	0.25	6.35	0.25	6.35	0.25	6.35
L	0.25	6.35	0.25	6.35	0.25	6.35	0.25	6.35
R	0.25	6.35	0.25	6.35	0.25	6.35	0.25	6.35

Note: The printable area means the area allowing actual printing at the time of receiving. The guaranteed printing area means the area where the printing quality is guaranteed.

This table does not include vertical and horizontal addressing error (± 3 mm) of recording paper

6.3 Recording Paper

The approved paper for this machine will be Xerox 4200 type or equivalent. A fundamental technical specification will be provided to Customer by OKI to allow qualification of alternative sources.

6.3.1 Recording Paper

The automatic feeder will operate with the following sizes.

A4	:	(210 mm x 297 mm)
LETTER	:	(8.5 inch x 11 inch)
LEGAL	:	(8.5 inch x 14 inch)
LEGAL	:	(8.5 inch x 13 inch)

6.3.2 Automatic Recording Paper Feeder Capacity

The 1st cassette feeder will have the maximum capacity to store and feed 100 recording paper sheets of Letter/A4 Legal size. Paper sheets of new standard 20-pound copy bond Letter/A4/Legal size paper (Xerox 4200). The U.S. rating for paper weights will apply. (Refer to 6.4.1 for Base Weight.)

6.4 Input Recording Paper Characteristics

The machine will function with the following types of paper.

6.4.1 Base Weight

The machine will properly feed paper of A4, Letter and Legal size paper with a base weight from 16 pounds to 24 pounds. The base weight is defined as the weight of 500 sheets of paper having rectangular dimensions of 431.8 mm (17 inches) by 558.8 mm (22 inches).

6.4.2 Thickness

The machine will automatically feed Recording Paper of A4, Letter and Legal size, each having a cross-sectional measurement between front and back surfaces ranging from 0.08 mm to 0.12 mm.

Note: For reference purposes, sections 6.4.1 and 6.4.2 are based on common bond paper.

6.4.3 Shape

The feeding mechanism requires that Recording Paper be rectangular in shape. The registration of triangular, circular and wavy-edge Recording Paper cannot be guaranteed.

6.4.4 Recording Paper Condition

Only new paper is available.

6.5 Recording Paper Jam Detection

Paper jam will occur when the top of the paper is not detected by the first sensor within about 7 seconds (plan) after feeding begins.

A jam will also occur when printing time is over the limit, and each (A4/Letter/Legal) feeding length (time) is over the limit of about 45 mm.

6.6 Feeder Reliability

1st cassette:

Jam occurrence in the automatic feeder will be less than one in 1500 operations for all Recording Paper and conditions specified in Section 6.4 "Input Recording Paper Characteristics".

Misfeeds will be less than one in 500 operations.

2nd cassette:

Not available.

6.7 Recording Paper Jam Removal

A means will be provided for the operator to manually release the feed mechanism to aid in clearing a jam.

The operator will be able to clear 95% of all paper jams without tools or disassembly. The maximum number of operator-uncorrectable jams will be one in 10,000 recording paper fed.

6.8 Recording Paper Skewing

The maximum allowable skew of the recording paper is ± 1 mm over any advance of 100 mm.

6.9 Copy Density

The density of a black image printed on plain paper will be greater than 1.2 O.D.* regardless of uniformity in all printing areas. The density of the white background (unprinted area) will be no greater than 0.2 O.D. unit. All density measurements will be referred to a McBeth RD914 Densitometer.

* : 1.2 O.D. is guaranteed within the range shown in Figure 8-1.

**Note: O.D. of 1.2 or more (at 10 cm position after the test pattern print started).
Measured 30 min. after the test pattern print started.*

6.10 Copy Uniformity

Printed copies will exhibit a uniform density of printed and background areas, within a variation of 25% units from edge to edge of a single copy and within a variation of 30% units from one copy to the next.

6.11 Copy Stacking

The machine will discharge printed copies and stack them without jamming providing the paper sizes are A4, Letter and Legal.

Copies will be stacked in the order in which they are printed without operator intervention and the stacking mechanism will have a capacity of * 30 copies maximum.

The printed copies will be discharged on the stacker with printed face up.

** Note: 1) Using the recommended paper.*

6.12 Toner Cartridge/Image Drum unit useful life

6.12.1 Toner Cartridge

Useful life of Toner Cartridge is as below.

1,875 pages/4% duty

(Duty means the ratio of black area in the white area)

Note 1: The first toner cartridge installed a new image drum unit will have a decreased yield because the image drum unit itself has to be filled.

Note 2: 1,875 pages will be specified as an average of 5 cartridge's usage

6.12.2 Image Drum unit

Useful life of Image drum is as below.

4,500 pages/1 page per job.

8,000 pages/3 pages per job.

10,000 pages/Continuous print

7. COMMUNICATION

7.1 Transmission Line

The machine will reliably communicate with distant stations over voice-level telephone line.

7.2 Telephone Line Connection

The machine will be connected to the telephone line via a Network Control Unit (NCU). One RJ-11 connector will be provided to connect the line.

The machine will control the switching between the external telephone and the telephone line to permit the user to use the optional handset or telephone for voice communication.

7.2.1 International NCU

The NCU will be designed and constructed to meet worldwide PTT requirements.

Modular connectors will be provided for connection to the telephone and telephone line, depending upon each PTT requirement.

7.3 Communication Mode

The machine will operate as a half-duplex facsimile transceiver. Transmit and receive operations cannot take place at the same time.

7.4 Modem Operation

The high-speed modem will conform to ITU-T standard V29 for 9600/7200 bps (bits per second) operation and to ITU-T standard V27 ter. for 4800/2400 bps operation, and to ITU-T standard V.17, V.33 for 14400/12000 bps operation.

The low-speed (300 bps) modem will conform to ITU-T standard V21 channel 2 or equivalent.

7.4.1 Transmission Mode

The machine is designed to change the message transmitting speed in accordance with the following fall-back plan, which is shown in the table 7-1.

Table 7-1

Fall-Back Rank	Protocol	Transmission Speed (bps)	No. of Training	RTN received
1st	ITU-T V.17 (V.33)	14400	1	1
2nd	ITU-T V.17 (V.33)	12000	1	1
3rd	ITU-T V.17 (V.29)	9600	1	1
4th	ITU-T V.17 (V.29)	7200	1	1
5th	ITU-T V.27 ter.	4800	2	1
6th	ITU-T V.27 ter.	2400	2	1

7.4.2 Signal Level

The send will be -10.5 dBm for the US/Canada versions, -10dBm for the INT'L version and will be -11.5 dBm for the GER version, as a PTT requirement. None of the versions will provide an adjustable attenuator, but the sending level can be programmed by keypad control.

The receive modem will function with an incoming signal in the range of zero to -40 dBm or -6 to -43 dBm.

7.5 Protocol and Data Transmission

The unit will conform to the following protocol and data transmission procedures:

Group 3 - ITU-T recommendations T.30 and T.4

OKI Special Protocol

High-Speed Protocol - the T.30 handshaking procedure will be conducted at messagetransmission speed instead of 300 baud, during TX multi-page and multi-document transmissions.

Note: This feature disable when you set 9.6k to the H/Modem Rate (technical setting No. 13).

7.6 Data Compression

The machine will use the Modified Huffman (MH), Modified Read (MR) and Modified Modified Read (MMR) redundancy-reduction coding schemes.

7.7 Minimum Scan Line Time

The minimum scan line time for communication is shown below.

FX-051 \ Remote FAX	Compatible OKI Machine	G3
TX	0 ms	0 ms
RX	0 ms	* 10/5 ms

* 10 ms : 3.85 ℓ /mm
5 ms : 7.7 ℓ /15.4 ℓ /mm

7.8 Compatibility

All versions will be compatible with machines conforming to the ITU-T recommendations for Group 3.

7.9 Ring Detect Sensitivity

The Ring Detect Sensitivity will meet the each PTT Requirement.

8. ENVIRONMENTAL REQUIREMENTS

8.1 Power

8.1.1 AC Voltage Range

The machine will operate within A/B, as shown in Table 8-1. Operation within the ranges listed will be on a continuous basis.

Table 8-1 Voltage Range

Voltage Range	Nominal Value (Volts)	Minimum Value (Volts)	Maximum Value (Volts)
A: U.S./CANADA	120	102	127
B: INT'L	230	198	*250

Note: The power supply will actually work at 264 volts, but the maximum value shows 250 volts according to PTT regulation.

8.1.2 Frequency Range

The machine will operate on AC power having a frequency in the range of 49 to 61 Hertz.

8.1.3 Transients

The machine will operate without error under the following conditions:

Dropouts: 10 msec (Period: 1 sec)

Noise: [without error]

500 V (Pulse width: 100 ns/800 ns, Rising time: 1 ns)

[without memory loss]

1000 V (Pulse width: 100 ns/800 ns, Rising time: 1 ns)

8.1.4 Power Consumption

The machine will not exceed the maximum values shown in Tables 8-2 and 8-2a.

8.1.4.1 US/CANADA Versions

Table 8-2 Power Consumption

Mode	Typical Power (W)	Max. Power (W)
Transmit	16	18
Receive	104	115
Copy W	141	157
Standby	5.4	6.1

8.1.4.2 INT'L Versions

Table 8-2 a Power Consumption

Mode	Typical Power (W)	Max. Power (W)
Transmit	18	20
Receive	102	112
Copy W	143	157
Standby	6.5 (0.35)	7.7 (0.46)

(): Power save mode = ON * Chart: ITU-T No. 1

8.1.5 Rush Current

15 times nominal current or 30A for 1/2 cycle
8 times nominal current or 15A for 3 cycle
(Nominal current: copy mode)

8.2 Overheat Protection

The heater in the fuser unit is controlled by the thermister and temperature control circuit.

A built-in thermostat in the fuser unit prevents the heater from being overheated in the event of failures in the thermister temperature control circuit, etc.

The thermostat does not reset after cooling down.

8.3 Humidity

The machine will operate as specified at relative humidities in the range of 20 percent to 80 percent (non-condensing). Operation outside this range will be subject to the limitations shown in Figure 8-1.

8.4 Temperature

The machine will operate as specified in the temperature range of 10 Celsius to 32 Celsius. Operation outside this range will be subject to the limitations shown in Figure 8-1.

8.5 Shock

The unpackaged machine will withstand 60 G's of shock for 2 ± 2 ms on its vertical axis. Test methods will be in accordance with ASTM-D-3332-77.

8.6 Vibration

The un-packaged machine will withstand 1/2 G vibration from 2 to 200 Hz for one hour. Sweeptime will be 1/2 octave per minute.

Test methods will be in accordance with ASTM-D-3580-77T.

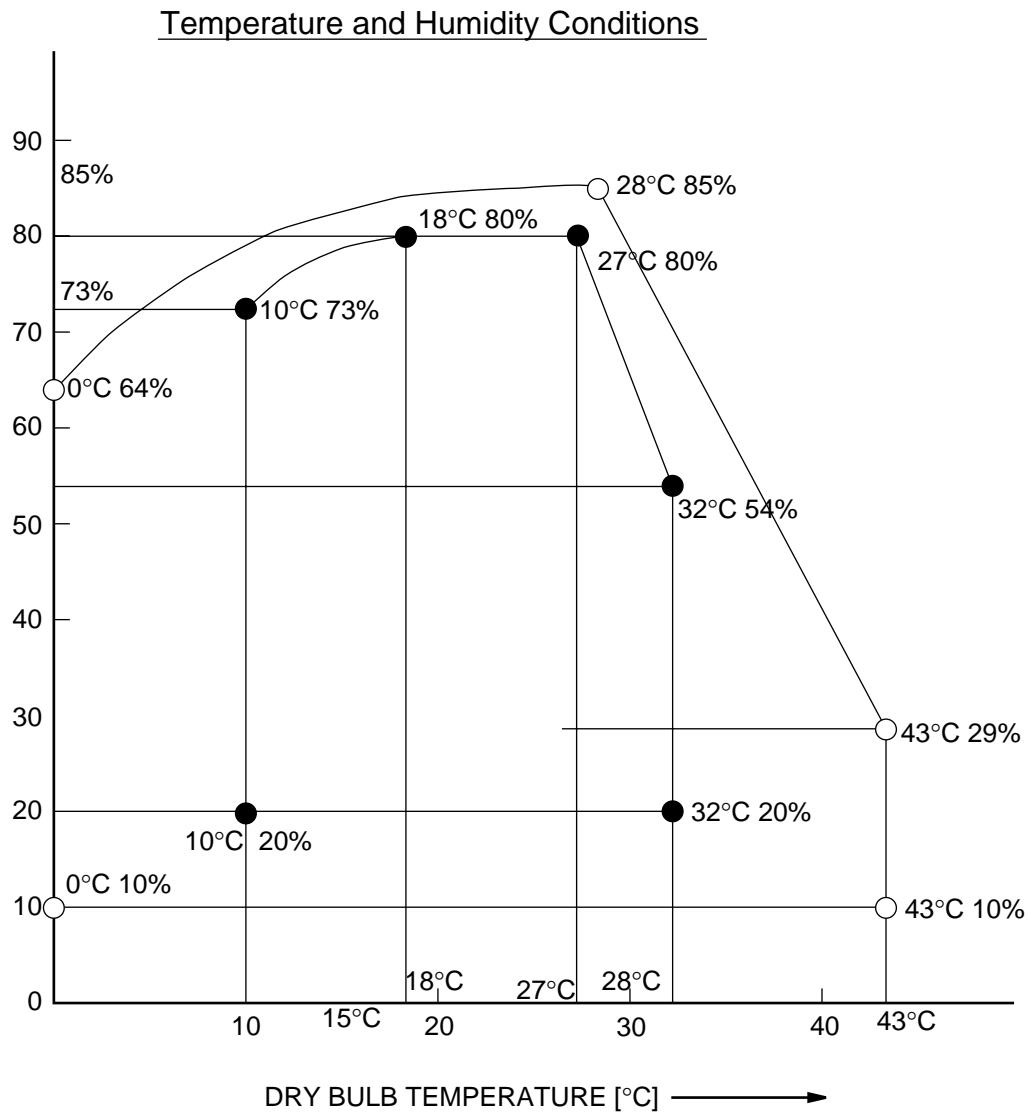

Area enclosed by lines with ● : Range where printing is guaranteed.
 Area enclosed by lines with ○ : Range for storage without power supply.

(Note) The curve connecting 28°C, 85% and 0°C, 64% is the condensation curve.

Figure 8-1

8.7 Static Electricity

Electrostatic Discharge Immunity will meet as follows.

Applicable Standard: EN50082-1/1992
Test method: IEC801-2/1984

8.8 Acoustic Noise

Acoustic noise emitted by the machine will not exceed 55 dBA at 1 meter under any conditions.

8.9 Radiation

Radio frequency interference and electromagnetic conduction will meet as follows.

FX-051 APPLICABLE EMI STANDARDS

- | | |
|-----------------------------------------------------|---------------------------|
| (A) ODA (U.S./CANADA) | FCC part 15 (Class B) |
| (B) OEL-INT (Italy, Denmark, Norway)
(Australia) | CENELEC EN55022 (Class B) |
| (C) GER (Germany, Switzerland, Austria) | Ditto |
| (D) UKF (U.K, France) | Ditto |
| (E) OKI-INT (Out of Europe) | CISPR Publ. 22 (Class B) |

8.10 Spurious Noise Level

The spurious noise level will meet the each PTT requirement.

8.11 Electrical Noise

Electrical noise while in idle status will meet the each PTT requirement.

8.12 Storage Conditions

The machine will not be affected by long-term storage under the following conditions:

Relative humidity: 10 to 90 percent non-condensing
Temperature: -10 to +50 degrees Celsius

9. SERVICEABILITY

9.1 Fault Isolation

9.1.1 Field problems will be diagnosed by replacement of circuit boards and mechanical components, with the aid of local diagnosis.

9.1.2 Problem diagnosis will be accomplished by the use of a standard 20 K ohm/volt volt-ohm meter (VOM).

9.1.3 Cables or special tools will be designed by OKI if required for field service.

9.2 Adjustments

All adjustments will be defined including procedures, unique test charts, and special tools. A recommendation on field and shop adjustments will be provided.

9.3 Assembly/Disassembly

A field service technician will not have to use a soldering iron to remove any replaceable sub-assembly.

9.4 Connector Designation

No label will be provided for identification of plugs because adequate measures against mis-insertion of plugs are taken in the system by; (1) different number of connector pins, (2) different connector pin pitch, and (3) connector cable not in reach.

10. OVERALL PERFORMANCE

10.1 Mean Time Between Failures (MTBF)

The MTBF for the overall machine will exceed (3,000) hours of actual operation. The MTBF will be measurable at a confidence level of 95 percent under controlled laboratory conditions.

The MTBF will be based on 50 percent transmit and 50 percent receive activity.

10.2 Standardization

The machine will meet all specifications established by the 1996 version of ITU-T recommendation, as follows:

- Recommendation T.4 - Group 3
- Recommendation T.30 - Procedures

10.3 Image Transmission Time

The time required to send a "ITU-T No. 1 Test Chart" from the machine to another Group 3 facsimile machine or between FX-051 machines, will not exceed the values listed in Table 10-1.

Table 10-1

		FX-051	
G3 Basic	Procedure Time	Initial	12.0 sec.(V17/29)
		Intermediate	2.5 sec.(V17/29)
		Final	4.0 sec.(V17/29)
	Image Time	14400 Standard	8.0 sec.
		Fine	11.0 sec.

Note: The above table shows the values under the following conditions:

- Sender ID: ON
- Speed protocol: OFF
- Feeder TX mode

* In the case of auto answer. Measured from the time of Answer.

In the case of another chart being applied, the above specified times will not be applied.

10.4 Copy Resolution

The resolution of the received copy will be as follows:

Scanning: 200* dots/inch x 3.85 lines/mm or 300 dots/inch x 7.7 lines/mm or 15.4 lines/mm

* : Convert from 300 to 200

Printing: 300 dots/inch x 784 lines/inch

Note : The image smoothing process is used for printing.

Resolution will be measured by transmitting a IIEEJ No. 2 Test Chart or equivalent between two machines and measuring the resolution of bar patterns.

10.5 Readability

Test Chart: IIEEJ No. 2 chart.

1. Readability (pattern 7)

(Ex.) At No. 3 in pattern 7, more than six should be read from eight of the received copies in standard mode.

At No. 4 in the same as above, more than six should be read from the received copy in fine mode.

2. Readability (pattern 15 characters)

(Ex.) The characters on the received copy of 10.5 points should be readable at more than 28 characters in FINE mode.

The received copy should be generated by the same model as TX.

3. Tapered Lines (horizontal)

(a) Black tapered line on a white background:

(Ex.) The black line should be printed less than 0.1.

(b) White tapered line on a black background:

(Ex.) The white line should be distinguished less than 0.2.

4. Tapered Lines (vertical)

(a) Black tapered line on a white background:

(Ex.) The black line should be printed less than 0.2.

(b) White tapered line on a black background:

(Ex.) The white line should be distinguished less than 0.3.

Note: Final agreement should be made after QA meeting between Customer and OKI (to determine the criteria etc.).

11. AGENCY LISTING/SAFETY REQUIREMENTS

The machine will meet the agency listing requirements as set forth in the AGREEMENT to which this Specification is attached. This includes, but is not limited to, the following.

- A. UL, FCC, OSHA in the U.S.
- B. CSA, IC in Canada
- C. VDE, IEC, BABT, CEPT, CISPR, Applicable PTT's regulation(s)

12. SHIPPING CONDITIONS

12.1 Vibration

The packaged product is tested by the vibration test of project 1A in the pre-shipment test of N.S.T.A.

12.2 Drop Test

The packaged product will be tested by the drop test of project 1A in the pre-shipment test of N.S.T.A.

12.3 Static Compression

The packaged product will withstand a load equal to a 14-foot stacking height with pallet(s) height in defined as the optional test of the N.S.T.A.

Note: The packaged product shall comply with the N.S.T.A's requirements but may not put the N.S.T.A's mark on the carton box.

13. APPLICABLE DOCUMENTS

13.1 ASTM-D3332-77

ASTM: American Society for Testing and Materials

Standard test methods for mechanical-shock fragility of products, using shock machines. Specification dated January 1978.

13.2 FCC Part 15, Class B

Federal Communications Commission, U.S.A.

Radio Frequency Devices — Part 15

13.3 NSTA

National Safe Transit Association Test Procedures for Packaged Products

13.4 UL 1950

Underwriters Laboratory, U.S.A.

Standard for Safety, Information Processing and Business Equipment

13.5 CSA STD C22.2 No. 950

Canadian Standards Association, Canada Information Processing and Business Equipment

13.6 IEC Publication 950

International Electrotechnical Commission, IEC Standard Safety of information technology equipment including electrical business equipment

13.7 EN60950

Safety of information technology equipment, including electrical business equipment.

13.8 FCC Part 68, Subpart D

Federal Communications Commission, U.S.A.

Connection of Terminal Equipment to the Telephone Network - Part 68 Conditions for Registration — Subpart D

13.9 IC CS-03 Issue 7

Industrie, Canada

Standard for Terminal Equipment, and Connection Arrangements Systems, Network Protection Devices

13.10 Occupational Safety and Health Act (OSHA)

Congressional Legislation of the United States dated 1970.

13.11 ITU-T Recommendations

International Telecommunications Union - Telecommunication Standardization Sector (ITU-T). The 1996 version of ITU-T Recommendations T.4 and T.30 only approved by the accelerated approval procedure (Resolution No.1).

13.12 No.2 IIEEJ (The institute of image electronics engineer of Japan)

13.13 VDE 0878

Prufstelle des verbandes Deutscher Electrotechniker (VDE) Radio interference suppression of telecommunication systems and apparatus, General Specifications

13.14 BS6305 and relevant regulations

British Standards Institution, U.K.

BS6305 - General requirements for apparatus for connection to the British Telecommunications public switched telephone network

13.15 EMC Directive 89/336/EEC (CE-mark)

EN 50081-1/1992: Electromagnetic compatibility - Generic emission standard
Part 1: Residential, commercial and light industry

EN 50082-1/1992: Electromagnetic compatibility - Generic immunity standard
Part 1: Residential, commercial and light industry

13.16 Unique International Requirement for Line Connection

13.16.1 DTS (Der Telefax Standard)

13.17 Requirement for options

13.17.1 MFP software (PC interface)
User option (INT'L)
Standard (ODA)

14. MACHINE PACKAGING AND CONFIGURATIONS

14.1 Shipping Carton Marking

OKI will use a Customer-provided printing layout for the production of the shipping carton used for each machine. OKI will forward the shipping carton size requirements to Customer, when they are known. Customer will prepare and send to OKI the printing layout. Generally, shipping cartons have:

- A. Four printed panels
- B. One color of ink printed
- C. Less than 50% ink coverage

OKI will properly mark each shipping carton with the enclosed machine model and serial number.

14.2 General Configurations

The Vender agrees to configure machines to satisfy OEM user's marketing plan. There may be multiple models of the machine, each model having unique items installed. Models will be configured to include the following items:

- A. Serial/Model tag with unique model number for a particular area or market.
- B. Language-oriented materials installed on each machine, including operator control panel overlay, instructional decals, warning decals, service decals, and other decals as required.
- C. Any hardware and/or software change that is required for a particular model to make it compatible with a market or a country requirement.

14.3 Machine Models

Following machine models will form the basis for the configurations distributed worldwide by

- A. Model ODA (120V) - Designed to meet the requirements for the U.S. Canada.
- B. Model OEL - Designed to meet the requirements of Europe except GER/UKF.
- C. Model GER - Designed to meet the requirements of BZT. Austria/Switzerland Group
- D. Model UKF - Designed to meet the requirements of United Kingdom/France.
- E. Model ODA (230V) - Designed to meet the requirements of Latin/South America.
- F. Model OKI-INT - Designed to meet the requirements out of Europe. (Australia, New Zealand, Singapore etc.)

14.4 Package Contents

Refer to Table 14-1.

FX-051 Packing Contents (Tentative)

Package Contents	FX-051								
	OKI/ODA Brand						OEM Brand		
	ODA		OEL			OKI	TN		
Part Name	N.A.	L.A.	European Countries			Other countries	GER		
			INT	GER	UKF	INT			
Packaged contents in OUK									
Facsimile unit	1	1	1	1	1	1	1		
I/D unit	1	1	1	1	1	1	1		
Document stacker	1	1	1	1	1	1	1		
Carrier sheet				1			1		
Toner cartridge			1	1	1	1	1		
AC power cord (GER)				1			1		
AC power cord (Australia)						1			
AC power cord *			1		1				
TEL/LINE cable (*US)	1	1							
TEL/LINE cable (FTZ)							1		
TEL/LINE cable (each countries)			* 1	1	* 1				
Dust cover (TM-6-DCI)				1			1		
User's guide						1	1		
User's guide **			1	1	1				
One touch sheet				5			5		
Packaged contents in ODA									
Toner cartridge	1	1							
User's guide	1	1							
AC power cord (UL/CSA)	1	1							
MFP Software (Jet Suite)	1	1							

*: Part type is selected by destination countries

**: Part is packed or not by destination countries

Table 14-1 Package Contents

OKI

People to People Technology

Oki Data Corporation
Tokyo, Japan

APPENDIX A

MFP Function

for FX-051

August, 1999

Table of Contents

1.	INTRODUCTION	A-1
1.1	SUMMARY	A-1
1.2	Host PC Function	A-3
1.2.1	PC PRINTER Function	A-3
1.2.1.1	Printer Block	A-4
1.2.2	PC SCANNER Function	A-6
1.2.2.1	Scanning Block	A-7
1.2.3	PC FaxModem Function	A-10
1.2.4	PC MEMORY	A-12
2.	CONCURRENT OPERATION	A-14
2.1	STANDALONE & HOST PC	A-14
2.2	HOST PC & STANDALONE	A-14
2.3	HOST PC & HOST PC	A-14
2.4	Driver & Application MENU	A-16
2.5	Paper Size, Printable Area	A-17
3.	BI-DIRECTIONAL PARALLEL INTERFACE	A-20

1. INTRODUCTION

1.1 SUMMARY

By installing the MFP software (Jet Suite), the following MFP (Multi-Function Peripheral) function can be realized.

Example:

- PC Printer function (300/Q600 dpi) 8 PPM (at NA Letter)
- PC Scanner function 300 dpi
- PC FaxModem function (TIA/EIA Class 1)
- PC Memory function
- PC Multiplex function Enable

Interface between Fax machine and Host PC consists of three layer structure as detailed below, Each sub-system can be operated at the same time by adopting a Oki-MFPI protocol in both Fax machine and Host PC.

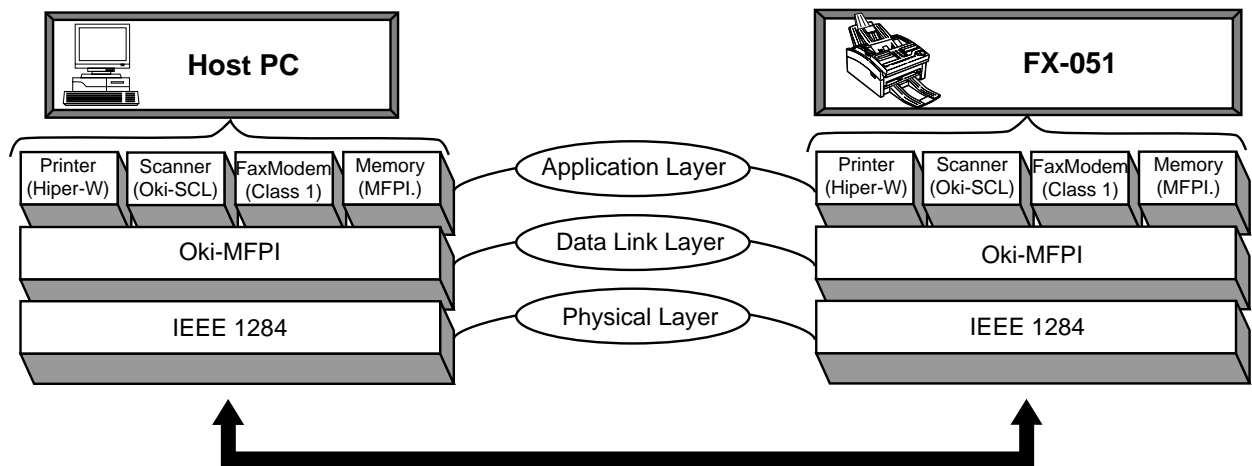

(Fig. 1)

- a) Application layer:
Performs a function control of each sub-system at the Host PC and Fax machine.
- b) Data-Link layer:
Performs a protocol control at the Host PC and Oki-MFPI
(Packetize/Unpacketize, flow control, Transfers command/data between each sub-system)
- c) Physical layer:
Has a bi-directional interface control circuit which conforms to IEEE1284.
Standard mode: Compatible, Nibble
Oki special mode: MCE (Mode Change Express)

Following devices are as sub-system:

- 1) Printer (HIPER-W: Host based Image PrintER for Windows)
Encodes a raster image data in Host PC and transfers a data with HIPER-W.
- 2) Scanner (Oki-SCL: Oki-Scanner Control Language)
Transfers an image data of document scanned in Fax machine to the Host PC with Oki-SCL command.
- 3) FaxModem (TIA/EIA Class 1)
Send/receive a Class 1 command between Host PC and Fax machine .
- 4) Memory (MFPL: Multi-Function Peripheral Language)
By using MFPL command, it is possible to display on screen of Host PC for condition of Fax machine and performs the initial registration of the telephone number used in Fax machine.

1.2 Host PC Function

1.2.1 PC PRINTER Function

- 1) Performs a coding compression of a raster image data in Host PC, and by using Hiper-W command (ORIPL), encoded data is transferred to Fax machine at high-speed (MCE mode) and printed as decompressed decoded data in sub-system side of the machine (printer).

Compression mode: ACC32

- 2) By using Hiper-W command (OPEL), it is possible to read a status of the machine (printer) and establish an environment setting.

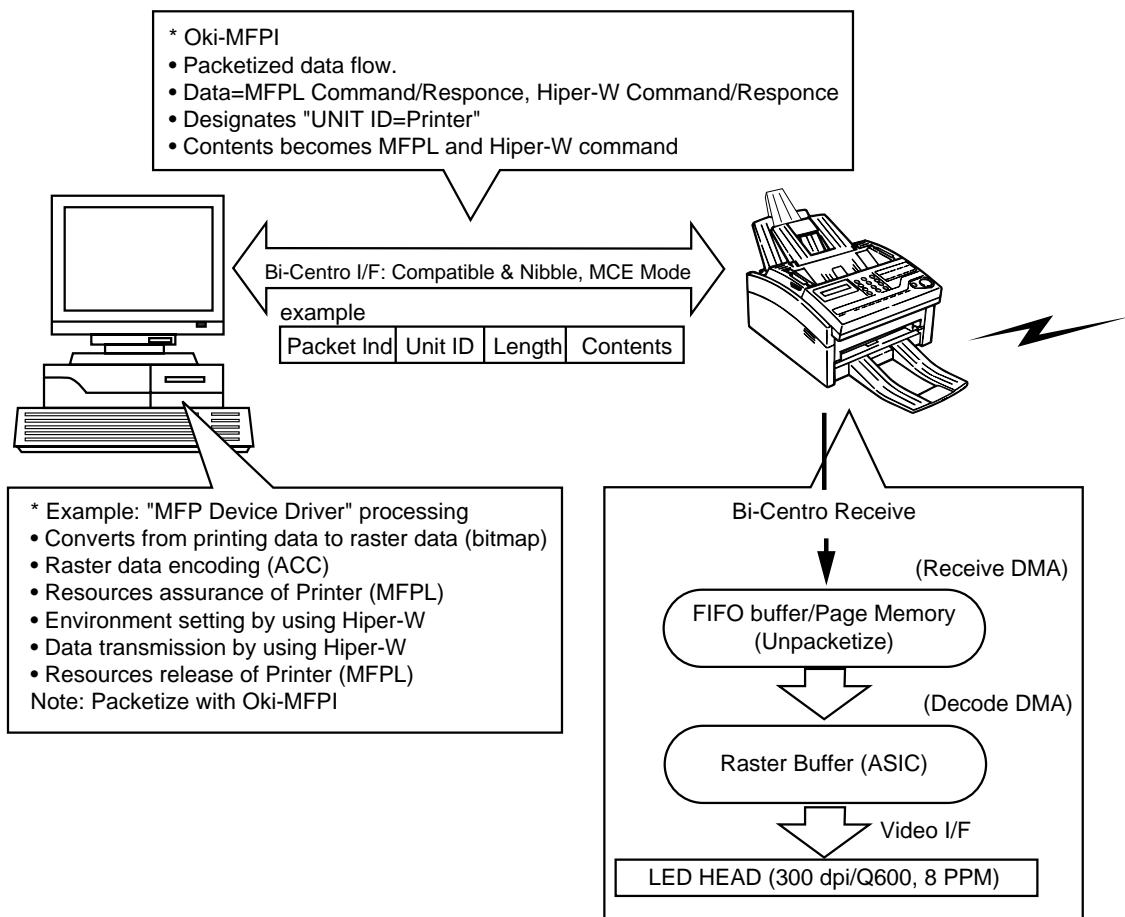

(Fig. 2)

1.2.1.1 Printer Block

No.	Item	Specification
1	PC printer	Option (Standard for ODA version)
2	Main functions	1) Resolution: 300 dpi, Quasi-600 dpi 2) Smoothing OST-EX (Quasi-600 dpi) 3) Paper feed - Insert: 100 sheets/1st tray 1 sheet for manual feed 4) Paper feed - Eject: Face up, 30 sheets 5) Paper feed - Insert (option): None 6) 1st Tray - Paper size: Letter/A4/Legal 13"/Legal 14" 7) Medium support: Manual feed for Envelope*1 8) Manual-Paper Size: Letter/A4/Legal 13"/Legal 14"/ Executive/A5/JIS B5/A6/ Monarch/COM-10/DL/C5/ 9) Paper weight: 16 - 24 lb 10) Paper size setting: Software OPE panel 11) Paper end detector: Not equipped 12) Toner low detector: Equipped 13) Cover open detector: Equipped 14) Fusing temperature abnormal: Protection equipped 15) Paper width detector: Not equipped 16) Ejection full detector: Not equipped

Note. *1: Available with below condition.

1) With reforming the envelope as culling upward.

2) Paper-Jam occurrence will be less than one in 20 operations.

1) Printable Area/Guaranteed Printing Area

- a) Guaranteed printing area is respectively an inside 0.25 inch (6 mm) from the upper/lower ends and left-right both ends for recording paper.
- b) Physical printable area of practical can be printed as below:
 - 50 dots = 0.17 inch (4.3 mm) from the upper ends for recording paper
 - 50 dots = 0.17 inch (4.3 mm) from the lower ends for recording paper
 - 50 dots = 0.17 inch (4.3 mm) without relationship to the recording paper for left-right both ends except Letter/Legal 13/Legal 14 (75 dot=0.25 inch)
- c) Since practical printing area is definition by each emulation, Refer to "Printer Sub-system Command" for details.
- d) Refer to "2.5" as for printing area by HIPER-W emulation.

Recording Paper	Paper Size	Guaranteed Printing Area
Letter	8.50" x 11.0"	8.00" x 10.5"
Legal 13	8.50" x 13.0"	8.00" x 12.5"
Legal 14	8.50" x 14.0"	8.00" x 13.5"
Executive	7.25" x 10.5"	6.75" x 10.0"
Monarch Envelope	3.87" x 7.50"	3.37" x 7.00"
COM-10 Envelope	4.12" x 9.50"	3.62" x 9.00"
DL Envelope	4.33" x 8.66"	3.83" x 8.16"
C5 Envelope	6.38" x 9.01"	5.88" x 8.51"
A4	8.27" x 11.69"	7.77" x 11.19"
A5	5.83" x 8.27"	5.33" x 7.77"
B5 (JIS)	7.16" x 10.12"	6.66" x 9.62"
A6	4.13" x 5.83"	3.63" x 5.33"

* B5 of DIN standard is not supported. B5 is only JIS standard.

1.2.2 PC SCANNER Function

- 1) Transfers an image data of document scanned in Fax machine to the Host PC by using Oki-SCL command.
- 2) Twain Driver of Host PC transfers the read data to the Scanner Application of OCR (Optical Character Recognition) and Image Editor etc.,.

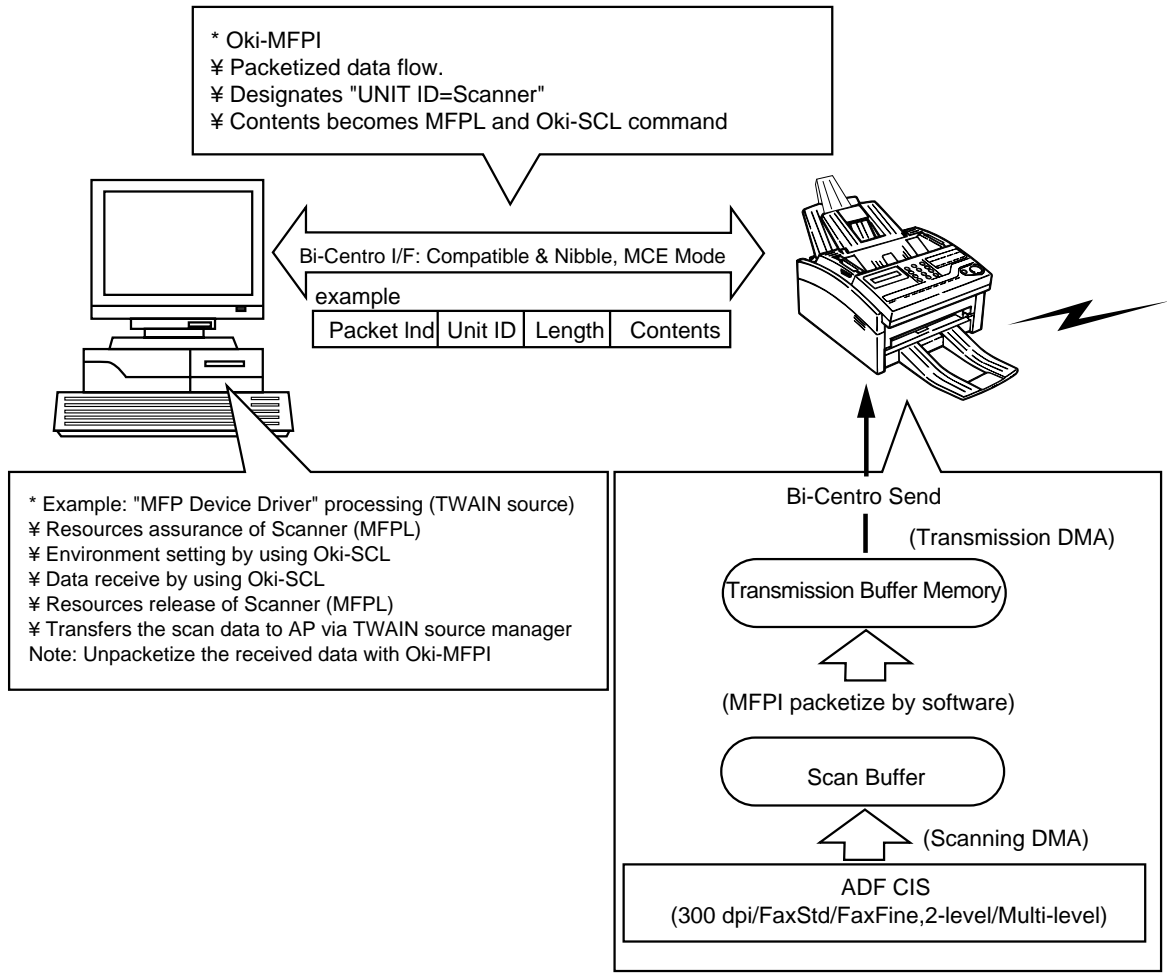

(Fig. 3)

1.2.2.1 Scanning Block

No.	Item	Specification
1	Scanning area	Horizontal scanning: 216 mm (Max.) Vertical scanning: 355.6 mm (Max.)
2	Main functions	1) Scanning mode: Line Art/Dither/4,6 bit Multi-level (16, 64 Level Gray scale) 2) Sensor: CIS 300 dpi 3) Scanning resolution: Horizontal x Vertical scanning 8 dot/mm x 3.85/7.7/15.4 line/mm 75 dpi x 75 dpi (multi level only) 300 x 300 dpi/15.4 lines/mm 4) Zoom: 1 to 100% 5) Black and white reverse: Not provided 6) Mirror image output: Not provided 7) Density: -1 (Light) - +1 (Dark) 8) Contrast: -1 (Min.) - +1 (Max.) Dither/Multi-level mode 9) Document guide: Center aligning 10) Dither pattern: Fixed 11) Scanning speed: TBD 12) Coding compression: TIFF like (2 level only) 13) Scanning window setting: Vertical axis only

1) ADF (auto document feeder) Block

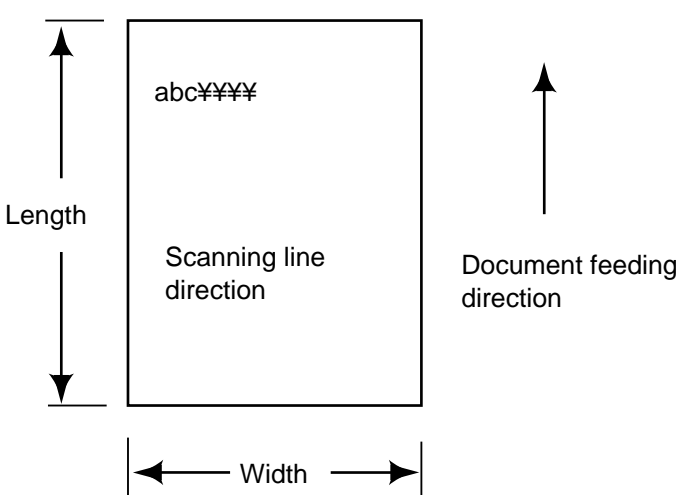
No.	Item	Specification
1	Used document size	<p>Document width: Min.; 148 mm (A5 width) Max.; 216 mm (Letter width)</p> <p>Document length: Min.; 100 mm Max.; 355.6 mm (Legal length)</p> <p><i>Note:</i> When the document is less than 148mm (width) and 100mm (length), the document must be used with a carrier sheet.</p>
2	Scanning direction	 <p>The diagram illustrates the scanning and feeding directions for a document. A rectangular document is shown with the text 'abc' on the left side and 'YYYY' on the right side. A vertical double-headed arrow to the left of the document is labeled 'Length'. A horizontal double-headed arrow below the document is labeled 'Width'. To the right of the document, a vertical arrow points upwards and is labeled 'Document feeding direction'.</p>

2) Reading Area

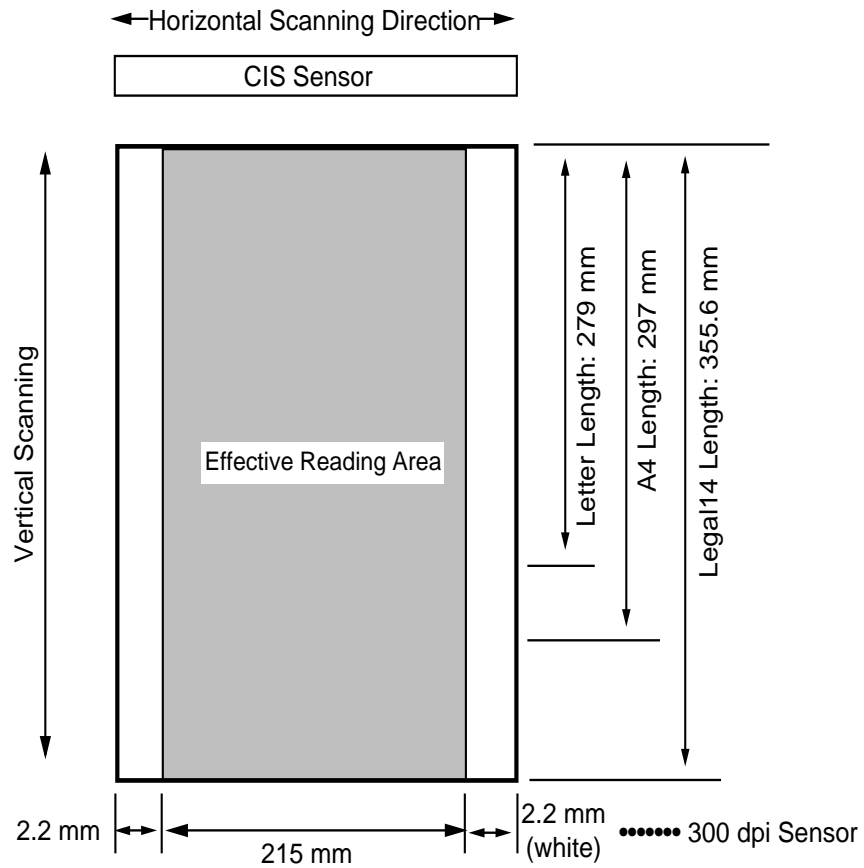

3) Reading Size

Scanning direction	Reading width	Remarks
Horizontal scanning direction	17 ^{*2} (reduction ratio:1%) to 2592 ^{*3} (reduction ratio: 100%) picture elements	
Vertical scanning direction	1 to 5477 line	*1

*1: Designates with 1/15.4 mm unit.

*2: 8 dot/mm

*3: 300 dpi

1.2.3 PC FaxModem Function

- 1) Transmission function of PC FaxModem transfers an image data to the remote Fax machine by using Class 1 command (EIA/TIA-578) when transmission image data is prepared by Host PC.
- 2) Class 1 receiving detects ringing from the remote Fax machine and informs ringing detection to the Host PC, and then, Fax machine receives an image data from the remote Fax machine and transfers received image data to the Host PC by using Class 1 command (EIA/TIA-578).
- 3) Maximum transmission speed:14.4 kbps
 - a) PC FaxModem transmission (Class 1)

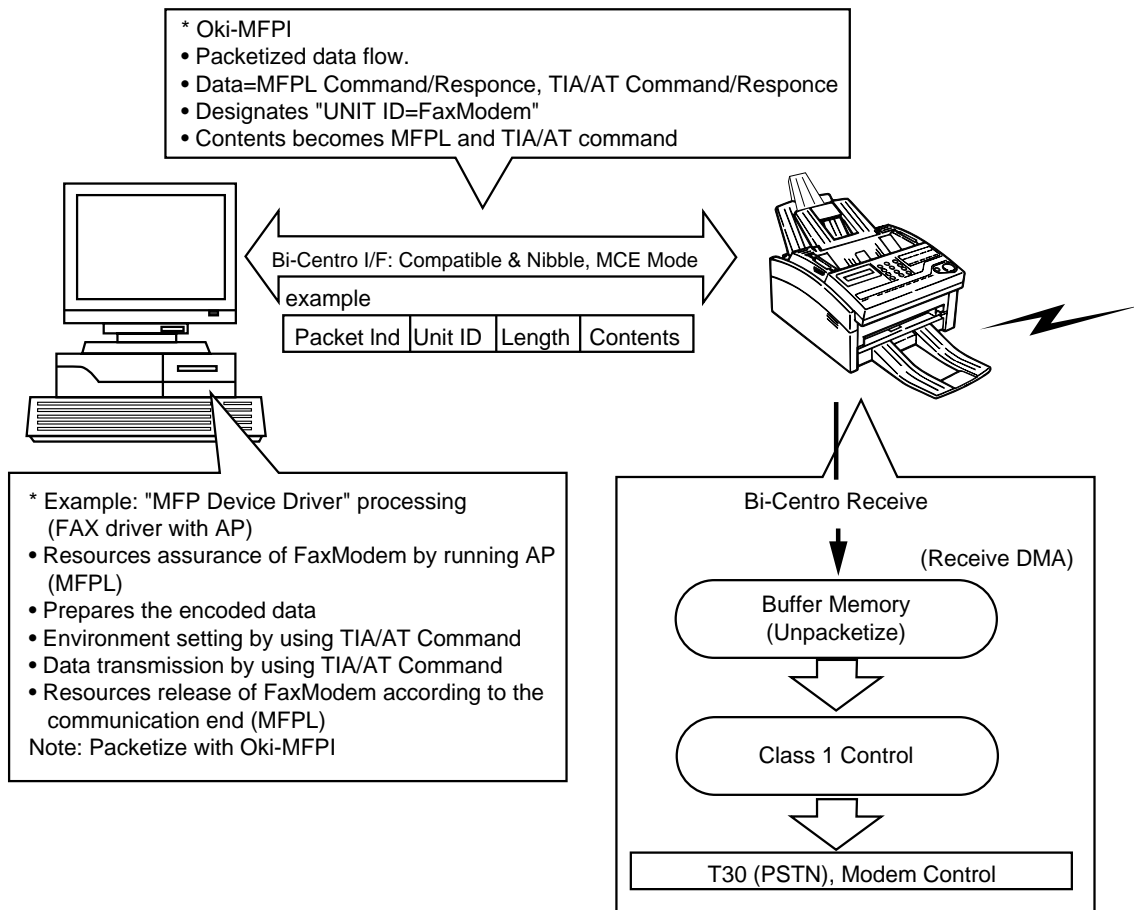

(Fig. 4)

b) PC FaxModem receiving (Class 1)

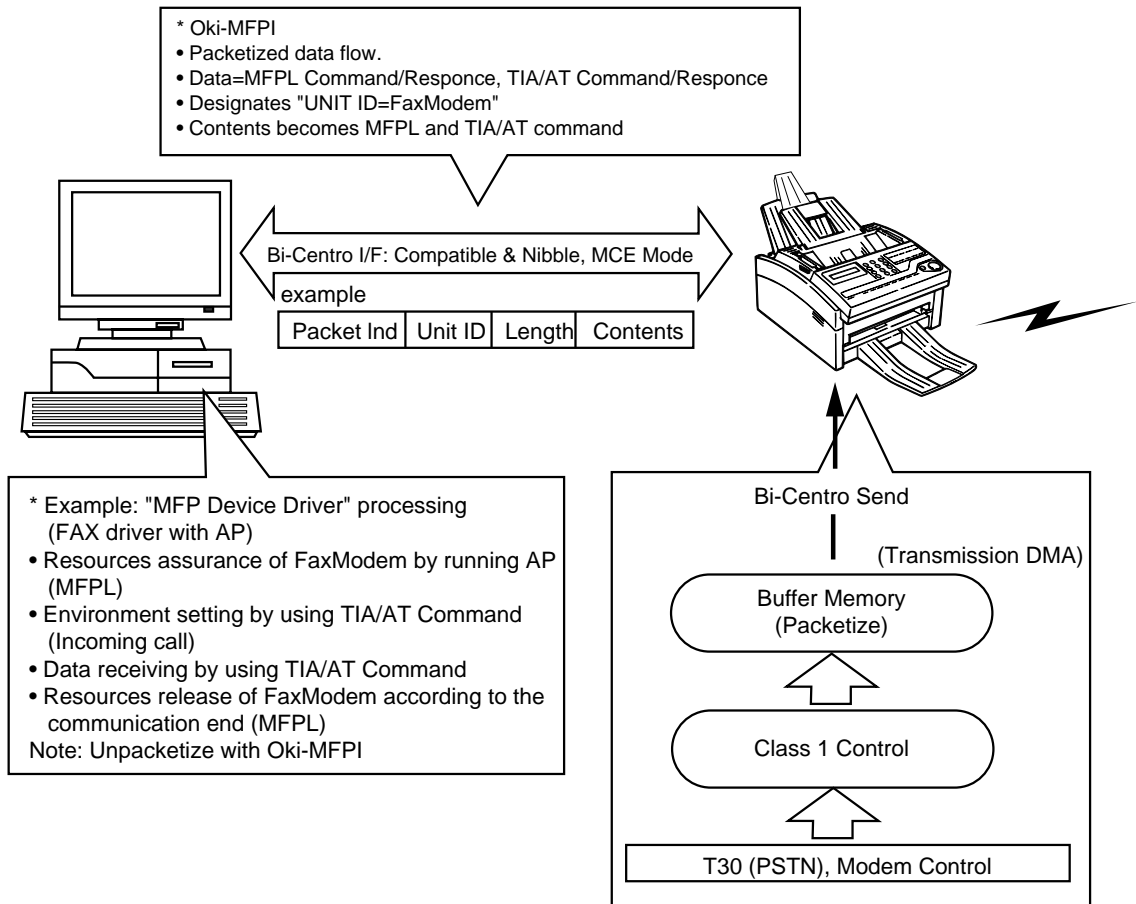

(Fig. 5)

1.2.4 PC MEMORY

- 1) It is possible to perform reading of status for Fax machine and up-load/down-load of dialing data for telephone number initial registration by using MFPL command (OPEN).

- a) PC Memory Read (Status reading/Dialing data reading)

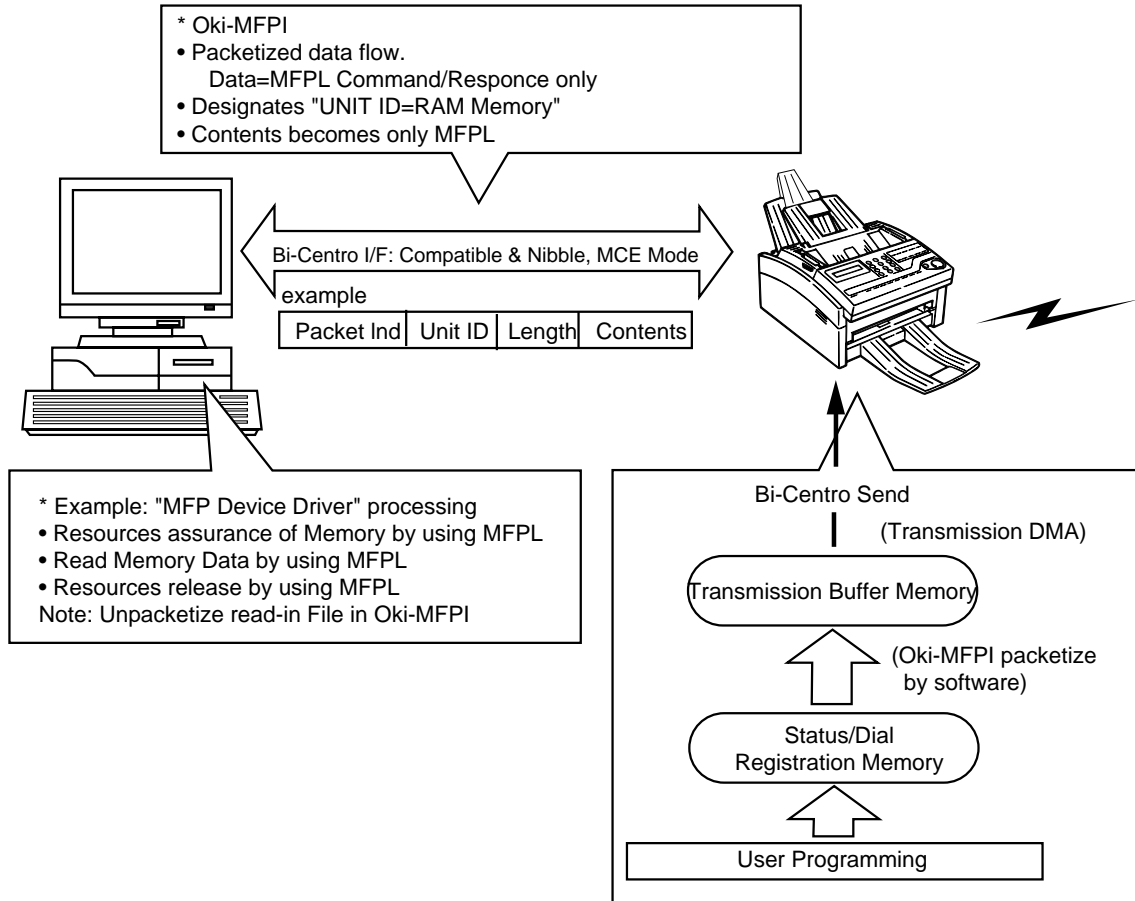

(Fig. 6)

b) PC Memory Write (Dialing data registration)

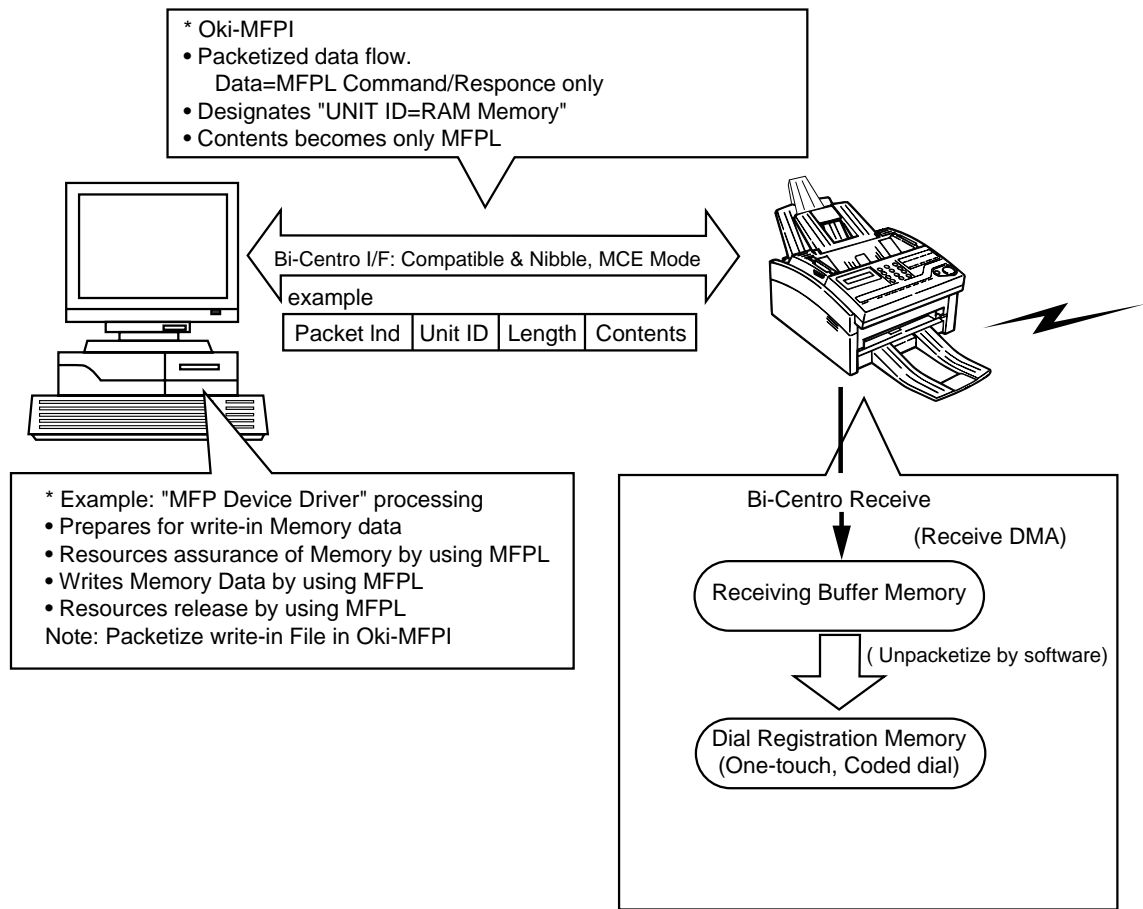

(Fig. 7)

2. CONCURRENT OPERATION

Concurrent operation for the Fax machine can be classified the following combinations:

2.1 STANDALONE & HOST PC

A part of MFP function for the simultaneous operation is possible during the Fax operation.

2.2 HOST PC & STANDALONE

A part of Fax machine function for the simultaneous operation is possible during the MFP function operation.

2.3 HOST PC & HOST PC

A part of other MFP functions for the simultaneous operation are possible during a part of MFP function operates.

Note 1: For detail of concurrent operation (dual access), see table of page 15.

Combination table of DUAL ACCESS and MULTI-TASKING capability

* Basic designing conception in "DUAL ACCESS and MULTI-TASKING"

- Performance for FAX machine (DUAL ACCESS)
 - Machine accepts to operator who handles the documents.
 - Machine accepts to automatic receiving.
- Performance for MFP machine. (MULTI-TASKING)
 - Operator can use to printer machine except busy of printer resouse.

1st Act.		2nd Act.		Stand-Alone						PC			
				Send		Receive		Local		Scanner	Printer	Class1-TX	Class1-RX
		Feeder	Memory	Paper	Memory	Mem. Scan	Print *	Copy					
Stand-Alone	Send	Feeder					△ *2	○	△ *2	×	○		
		Memory					○	○	○	×	○		
	Rec.	Paper					○			×			
		Memory					○	○	×	×	○		
	Mem. Scan		×	○	○		○				○	×	×
	Print *	○ *1	×		○	○				×		×	×
	Copy		×		○					×		×	×
PC	Scanner		×	×	×		×				×	×	×
	Printer	○	○		○	○			×		×	×	×
	Class1-TX					×	×	×			×		
	Class1-RX					×	×	×			×		
Remarks	Printer * ----- Printing of substitutional received data, several reports. ○ / Possible combination. × / Impossible combination Oblique / Impossible combination because of double assigned resource.												

*1: TX reserve on feeder.

*2: Available to copy after scanning.

GROUP	ITEM	COMMENT	FX-051 (INT'L)	FX-051 (ODA)
Drivers	Printer Driver	Hiper-W	Opt*	Std
	Scanner Driver	TWAIN compatible.	Opt*	Std
	FAX Modem Driver	CLASS1 compatible	Opt*	Std
	Oki-MFPI Driver	This driver has follow operations mainly <ul style="list-style-type: none"> • Packet operations on Oki-MFPI • IEEE1284 (Bi-Centro) 	Opt*	Std
Applications	Installer	Installing Drivers and Applications (except for PCFAX APP and OCR APP)	Opt*	Std
	Copy APP	This APP reads image data with Scanners subsystem (TWAIN), and printers it with Printer subsystem (Hiper-W). 2up/4up copy enabled.	Opt*	Std
	Setup APP	Enable to change the data of One Touch & Auto Dial from the HOST.	Opt*	Std
	Status Monitor APP	Display the status of MFP-function.	Opt*	Std
	PCFAX APP (including Viewer)	CLASS1	Opt*	Std

(*) Optional Bi-Centro Board with these "Opt" softwares (this optional package means "MFP Package")

2.5 Paper Size, Printable Area

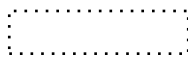
-  : Guaranteed Printing Area
-  : Printable Area (ORIPL Emulation)

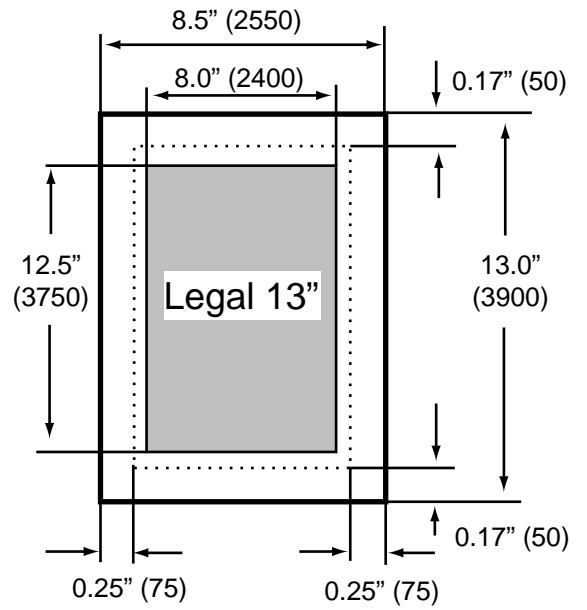
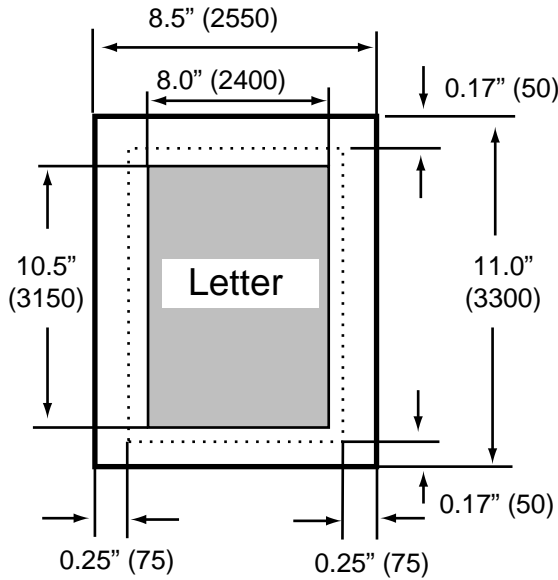

:

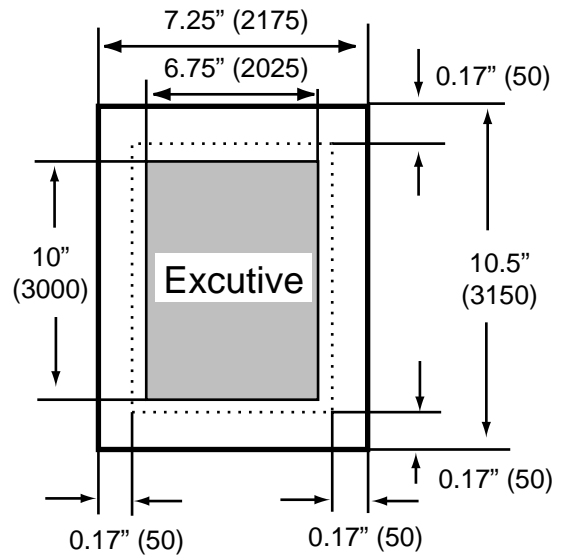
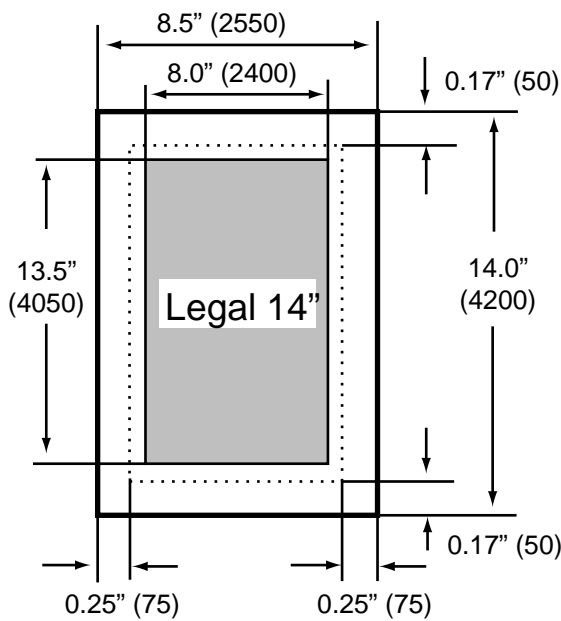

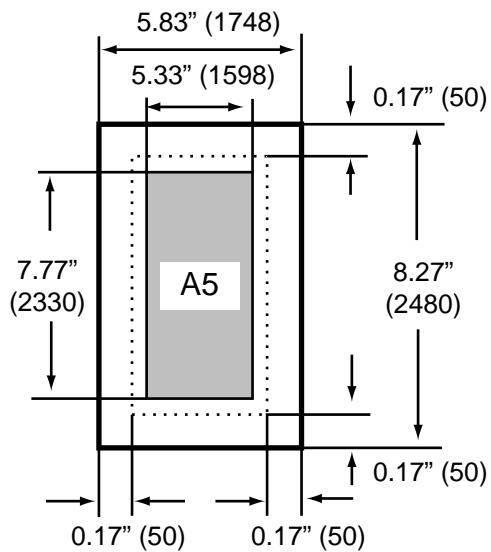
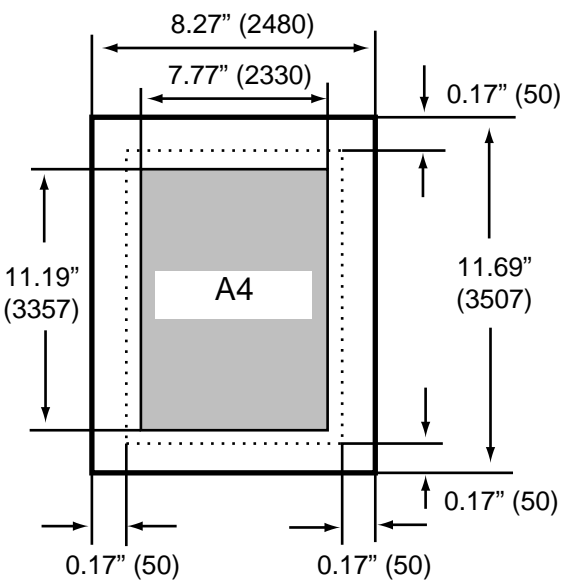
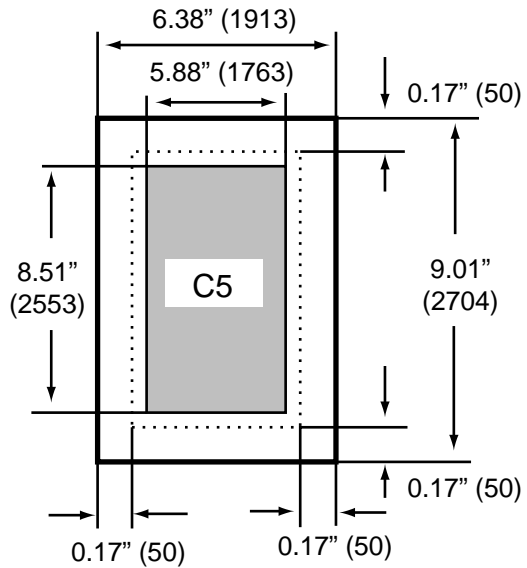
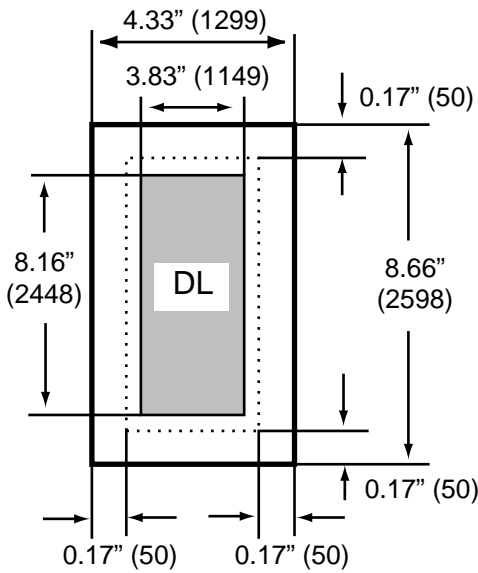
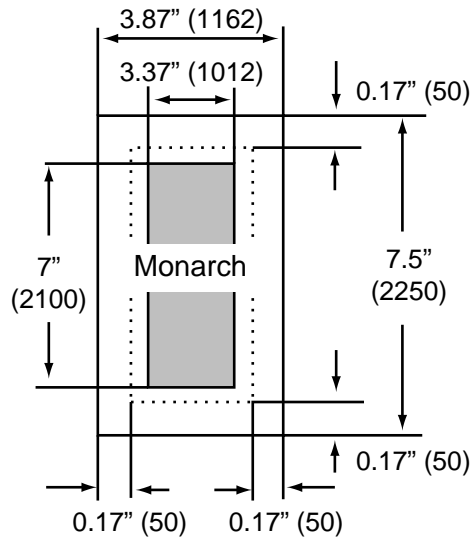
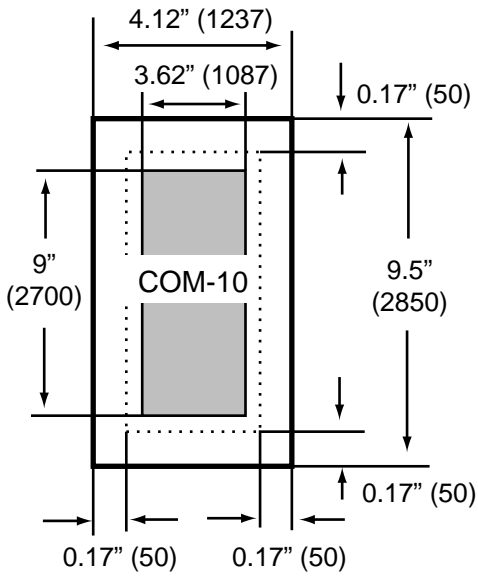

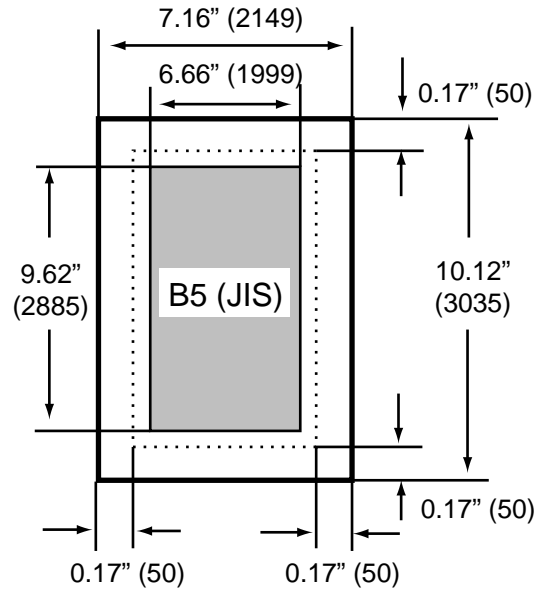
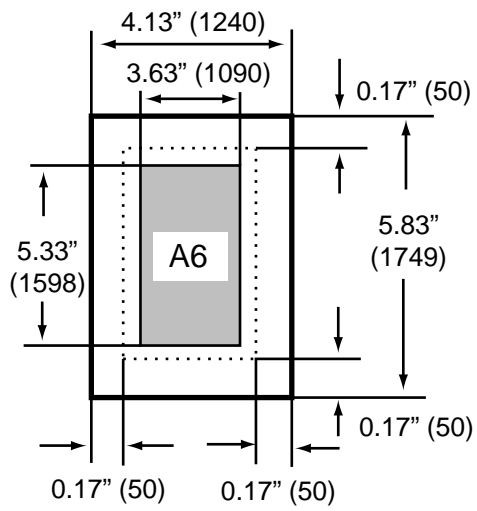

3. Bi-directional Parallel Interface

IEEE 1284-B interface is used.

1) Connector

- Printer side: 36-pin receptacle
- Cable side: 36-pin plug

2) Cable

- IEEE Std 1284-1994 compliant cable is recommended for noise prevention.
- Cable length: 6 ft (1.8m) max.

3) Connector pin arrangement

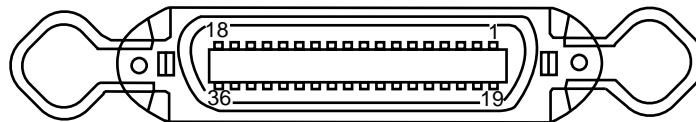

4) Signal level

- Low: 0V to +0.8V
- High: +2.4V to 5.0V

5) Modes

IEEE 1284

- Compatible mode
- Nibble mode

6) Data bit length

8 bits

7) Interface circuit

a) Receiving circuit

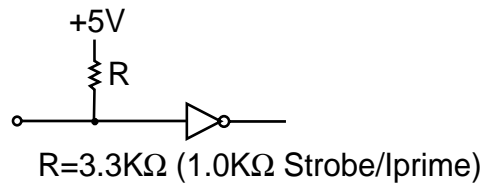

b) Sending circuit

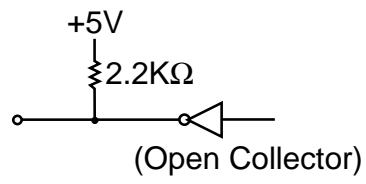

8) Table of parallel I/F signals

Pin No.	Signal Name	Signal Direction	Logic	Compatible	Nibble	Functions
1	Data Strobe	→ Printer	Negative	nStrobe	Host Clk	Data strobe
2 - 9	Data Bit n	↔ Printer	Positive		Data 1(LSB) - 8 (MSB)	Data line from/to host
10	Acknowledge	Printer →	Negative	nAck	PtrClk	Completion of reception or function
11	Busy	Printer →	Positive	Busy	PtrBusy	Data reception not possible
12	Paper End	Printer →	Positive	PError	AckDataReq	No paper
13	Select	Printer →	Positive	Select	Xflag	On-line
14	Auto Feed	→ Printer	Negative	nAutoFd	HostBusy	Mode switch request
15	-	-	-		Not defined	Not used
16	0V	-	-		Logic Gnd	Signal ground
17	Chassis Ground	-	-		Chassis Gnd	Frame ground
18	5V	Printer →	-		Peripheral Logic High	Power supply (max. 50mA) (option)
19	0V	-	-		Signal Ground (nStrobe)	Signal ground
20 - 27	0V	-	-		Signal Ground (Data 1 - 8)	Signal ground
28	0V	-	-		Signal Ground (PError,Select, nAck)	Signal ground
29	0V	-	-		Signal Ground (Busy, nFault)	Signal ground
30	0V	-	-		Signal Ground (nAutoFd, nSelectIn, nInit)	Signal ground
31	Input Prime	→ Printer	Negative	nInit	nInit	Initialize
32	Fault	Printer →	Negative	nFault	nDataAvail	Error occurrence, On-line
33	0V	-	-		Not Defined	Signal ground
34	-	-	-		Not Defined	Not used
35	-	Printer →	-		Not Defined	Fixed to logic "1"
36	Select In	→ Printer	Negative	nSelectIn	1284 Active	Mode switch request

OKI

People to People Technology

Oki Data Corporation
Tokyo, Japan

APPENDIX B

FAX2NET Product Specification

for FX-051

September, 1999

Contents

1. Outline	B-1
2. FAX2NET Services	B-1
2.1 Service Types	B-1
3. Setup Items	B-2
3.1 Registration Information	B-2
3.1.1 FAX Network Registration	B-2
3.2 Destination Registration	B-3
3.2.1 E-Mail Address Registration	B-3
3.2.2 WEB URL Registration	B-3
3.2.3 Group Registration	B-3
3.3 Menus	B-4
3.3.1 User Program	B-4
3.3.2 Location Program	B-4
3.4 Characters Allocated to UNIQUE Keys	B-4
3.5 Characters Allocated to One-Touch Keys	B-5
3.6 Entering Lowercase Characters	B-5
4. Functions	B-7
4.1 Single Destination Sending	B-7
4.1.1 International Call	B-7
4.1.1.1 Alarm	B-7
4.1.2 E-Mail Address	B-8
4.2 Broadcasting	B-8
4.2.1 Destination Specification	B-8
4.2.2 Sending Operation	B-8
4.3 WEB Printing	B-8
4.3.1 Requests	B-8
4.3.1.1 Alarms	B-9
4.3.2 Reception	B-9
4.4 Confidential and Relay Sending	B-9
4.5 PBX Setting	B-10
4.6 Polling Reception	B-10
4.7 Other Restrictions	B-10

5. Procedure	B-11
5.1 Telephone Number	B-11
5.2 E-Mail Address	B-12
5.3 WEB Address	B-13
5.4 Character Conversion Table	B-14
5.5 Check Sum	B-15
6. Operation	B-16
7. Reports	B-30
7.1 Message Confirmation Report	B-30
7.2 Telephone Directory Report	B-30
7.3 Lowercase Character Description Support	B-31
7.3.1 Location ID	B-31
7.3.2 Distant Station ID	B-31
7.4 Communication Mode Column Description	B-31
7.5 Service Code Description	B-31
8. Service Codes	B-32

1. Outline

This specifications describes the addition and modification caused to mount functions using FAX2NET service (that is a facsimile service via internet) in the FX-051.

2. FAX2NET Services

2.1 Service Types

The FAX2NET service is a facsimile communication service using the FAX2NET-supplied internet. The FAX2NET server distributed in each country transfers facsimile data via the internet. A user facsimile can use internet functions by communicating with the neighboring FAX2NET server.

Of the FAX2NET-supplied functions, the following five functions are mounted in the FX-051

(1) FAX over IP

Route: FAX(A) -> FAX2NET server (P) -> FAX2NET server (Q) -> FAX(B)

A general telephone line is connected between the FAX(A) and server and between the server (Q) and FAX(B). Servers (P) and (Q) are connected via internet.

The FAX(A), that is connected to server (P) via a telephone line, reports information, e.g., remote-subscriber's facsimile number and user account, to the server using DTMF tone. The FAX(A) then sends facsimile data using a normal T.30 protocol. Server (P) searches for a server (server (Q)) nearest the received remote-subscriber's facsimile number (FAX(B)) and sends facsimile data via internet. Server (P) that received facsimile data sends it to the FAX(B) through a telephone line. Communication between server (Q) and FAX(B) is performed by normal facsimile sending.

(2) FAX to E-mail

Route: FAX(A) -> FAX2NET server(P) -> Internet mail server (Q) -> PC(B)

A general telephone line is connected between the FAX(A) and server (P) and between the server (Q) and FAX(B). Servers (P) and (Q) are connected via internet.

The FAX(A), that is connected to server (P) via a telephone line, reports information, e.g., remote-E-mail address and user account, to the server using DTMF tone. The FAX(A) then sends facsimile data using a normal T.30 protocol. Server (P) searches for a server (server (Q)) nearest the received remote-E-mail address (PC(B)) and sends facsimile data via internet. Server (P) that received facsimile data sends an E-mail to the remote address as an attached file of the mail. The PC(B) receives the E-mail attached to the facsimile data via mail server (Q).

(3) Virtual E-mail

Route: PC(A) -> FAX2NET server (P) -> FAX(B)

The FAX(B) is allocated to a virtual E-mail address by the FAX2NET server. An E-mail issued from the PC(A) is converted to facsimile data by the FAX2NET server (P). The FAX2NET server (P) then sends the facsimile data to the FAX(B) using the T.30 protocol.

The FAX(B) only performs the normal G3 facsimile receiving operation; so, the user need not prepare a special protocol.

(4) Web retrieval

Request route: FAX(A) -> FAX2NET server (P)

Receiving route: Web server (W) -> FAX2NET server (P) -> FAX(A)

Web server (W) and server (P) are connected via internet. The FAX(A) and server (P), and the server (P) and FAX(A) are connected through a general telephone line.

The FAX(A) reports a Web URL to be fetched to server (P) and disconnects the line once. FAX2NET server (P) converts a specified Web page to facsimile data, issues a call to the FAX(A), and sends the data to the FAX(A) with the T.30 protocol.

A special protocol is not used in a Web page receiving route. This is a normal G3 facsimile reception for the FAX(A).

(5) Payment Card Registration

Request route: FAX(A) -> FAX2NET server (P)

FAX(A) reports the payment card number to the FAX2NET server (P) using DTMF tone.

Continuously, FAX2NET server sends the registered result image report to the FAX(P) as the facsimile image data by the normal T.30 protocol.

3. Setup Items

3.1 Registration information

The following items are added to the already registered items.

3.1.1 Facsimile Network Registration

(1) FAX2NET server telephone number

Telephone number of the FAX2NET server to be used. Max. 32 digits. At setting of PBX, this number must be registered, including DIAL PREFIX for PBX-> PTT switching.

(2) Account number

ID particular to a terminal registered in the FAX2NET service. The user must fetch this number individually from FAX2NET.

Account Number (10-digit maximum) + PIN Number (4-digit maximum)

(3) International telephone prefix

Number required to decide whether the FAX2NET service should be started. When the prefix of the destination telephone number matches a registered number, a call is issued to the FAX2NET server. If DIAL PREFIX is specified for the PBX, a number following a dial prefix (and hyphen, blank or pause) is compared with the international telephone prefix.

Max. 10 digits

When an E-mail address/Web URL is included in a communication destination not communicated, the server telephone number and account number cannot be deleted.

(Illegal operation)

If either the server telephone number or account number is deleted, another one is also deleted.

3.2 Destination Registration

3.2.1 E-mail Address Registration

An E-mail address can be registered in up to 10 portions fitting to on-touch keys 1 to 10.

Each address must be composed of up to 64 characters: uppercase letters, lowercase letters, digits, and symbols. For details on the applicable characters, see Section 5.4.

The user can begin E-mail address registration by selecting E-mail registration in the one-touch destination registration. For details on operation, see Operations.

Whether an entered character string is appropriate is not checked.

Each E-mail address is internally stored in a separate area from a general one-touch registration telephone number storage area.

When an E-mail address is registered, the one-touch parameter is initialized.

3.2.2 WEB URL Registration

WEB URL can be registered in 10 portions fitting to one-touch keys 1 to 10.

Each address must be composed of up to 64 characters: uppercase letters, lowercase letters, digits, and symbols. For details on the applicable characters, see Section 5.4.

The user can begin URL registration by selecting URL registration in destination registration.

In this case, the user need not prefix http://.

For details, see Operations.

Whether an entered character string is appropriate for Web URL is not checked.

When Web URL is registered, the one-touch parameter is initialized.

3.2.3 Group registration

To register a group destination, an abbreviated dial can be mixed with O.T. in which an E-mail address is registered and one in which other general telephone number is registered.

However, a group destination cannot be registered, including an O.T. key in which Web URL is registered. If an attempt is made to add Web URL to a group, message "NOT PROGRAMMED" appears.

When an account number is not registered, O.T. in which an E-mail address is registered cannot be specified for group destination.

When an account number is not registered, if a group including an E-mail address in a group is selected as a destination, the E-mail address is deleted from the group registration. When no group destination remains as a result of the deletion, if the group is specified at selection of a communication destination, message "NOT PROGRAMMED" appears.

3.3 Menus

For details on the menus, see Operations.

3.3.1 User Program

Add item "FAX2NET Server Registration" to No. 8.

Under "FAX2NET server registration," specify a FAX2NET server telephone number, FAX2NET account number, and international telephone prefix.

3.3.2 Location Program

When "registration in one-touch key" is selected, if an account number is already registered, branches appear so that the user can select whether a telephone number E-mail address or Web URL is to be registered.

If telephone number registration is selected, the screen changes to the conventional one-touch key registration screen.

If E-mail address or Web URL registration is selected, the screen changes to a new E-mail address registration or Web URL registration screens.

After an E-mail address or Web URL is registered, if an account number is deleted, the user can select only the telephone number registration screen for one-touch registration. In this case, the E-mail address or Web URL is stored internally. If an account number is registered again, the stored E-mail address or Web URL becomes valid.

While no account number is registered, if a new telephone number is registered, the E-mail address or Web URL is deleted.

When both a telephone number and E-mail address or Web URL are registered in one O.T. using RMCS (an account number is already registered), the E-mail address or Web URL has priority.

3.4 Characters Allocated to UNIQUE Keys

The following five kinds of special characters are newly assigned to UNIQUE keys to help the user enter an E-mail address and Web URL:

At mark : @

Under score : _

Tilde : ~ (Since this system does not support "~," "1" is displayed on the LCD instead.)

Back slash : \

Percent: :%

Double quotation: "

3.5 Characters Allocated to One-Touch Keys

The following characters can be used on each character entry screen by allocating them to one-touch keys 1 to 6. The CAPS function is allocated to one-touch key 7; so, it is valid at entry of an E-mail address and Web URL. See Fig.3 FX-051 control panel.

O.T. No.1	:	.	
O.T. No.2	:	_	
O.T. No.3	:	~	(Since this system does not support "~," "~" is displayed on the LCD instead.)
O.T. No.4	:	"	
O.T. No.5	:	/	
O.T. No.6	:	@	
O.T. No.7	:	CAPS	

3.6 Entering Lowercase Letters

Lowercase letters can be entered on the Web address and E-mail address entry screens. CAPS ON <=> CAPS OFF toggle switching is enabled by pressing O.T. 7. The default is CAPS OFF (lowercase letters enabled) is set on the E-mail address entry and Web URL entry screens.

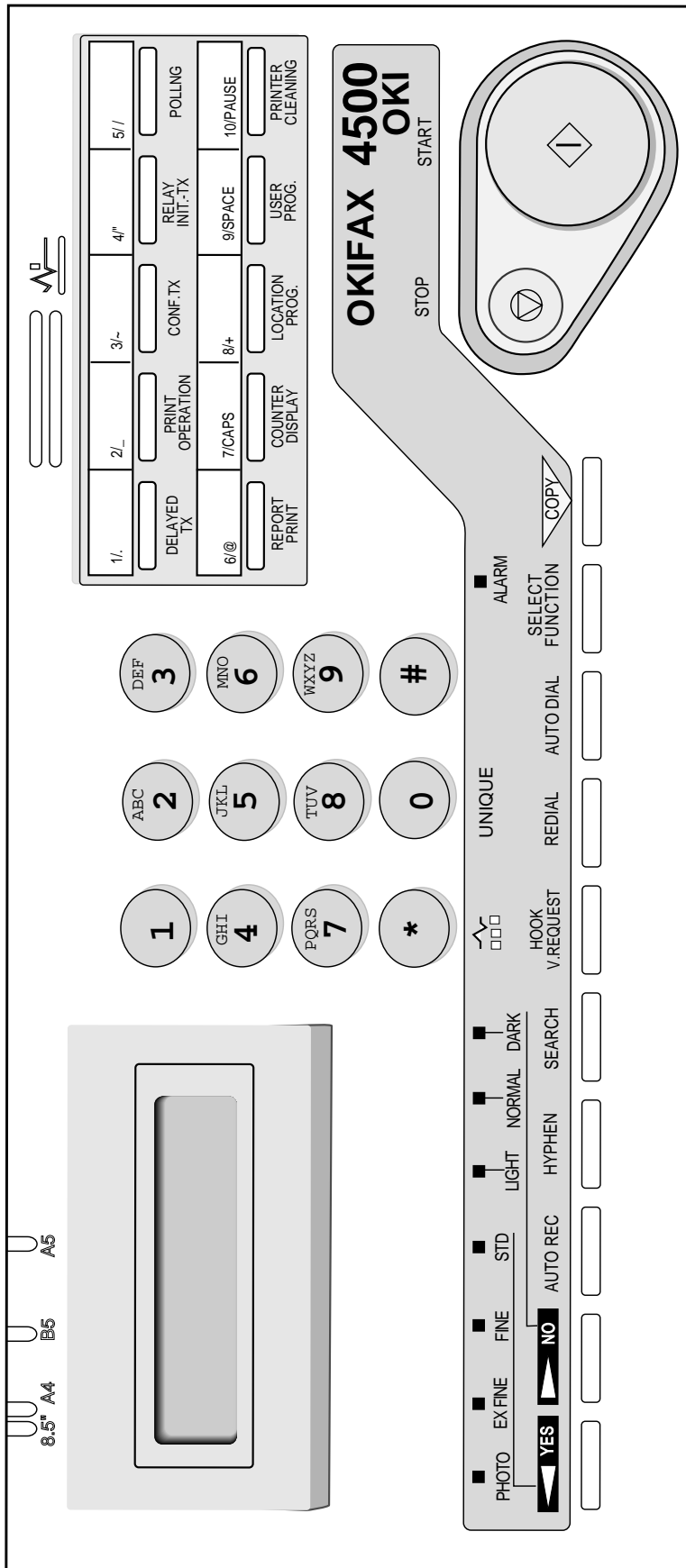

Fig 3 FX-051 Control Panel

4. Functions

4.1 Single Destination Sending

4.1.1 International Call

This function checks a destination telephone number prior to dialing and determines whether the FAX2NET function is to be used.

When the FAX2NET server telephone number, account number, or international telephone prefix is not registered, a call is issued to a destination telephone number as normal G3 facsimile sending.

If a dial prefix is set, it is first compared with the prefix of the destination telephone number. When the dial prefix matches the prefix of the destination telephone number, a part excluding the dial prefix and subsequent hyphen, blank, or pause from the destination telephone number is compared with an international telephone prefix.

When an international prefix matches the prefix of a destination telephone number, a call is issued to a number registered as a FAX2NET server telephone number.

The result of communication with the FAX2NET server is described in the Activity report.

Whether a target call arrives at the last destination cannot be recognized from FX051. The user must confirm the communication result on the FAX2NET Web page.

4.1.1.1 Alarms

When a destination telephone number consists of only a dial prefix and international telephone prefix, a sending destination telephone number is missing. This is assumed to be a calling error with service code 909D without calling operation.

When the FAX2NET server returns no reply or is busy, the fax waits for redialing according to redial setting in the same way as normal sending.

If DTMF tone "D" is sent instead of DTMF tone "B," information cannot be set in the FAX2NET server. The fax then cuts off the line, displays an alarm message on the LCD, lights on the alarm LED lamp, and sounds alarm. In this case, do not redial because registration information about the FAX2NET server may be incorrect. The service code is 14D0.

When the TA time lapsed after calling to the FAX2NET server was completed, if DTMF tone "A" is not sent from the FAX2NET server, the fax cuts off the line and enters the redial wait state. (Handled as the destination no-reply state.)

When the TB time lapsed after the sending of a sending destination number, etc. ended with a DTMF tone, if DTMF tone "B" or "D" is not returned from the FAX2NET server, the fax cuts off the line and enters the redial wait state. (Handled as the destination no-reply state.)

When the TC time lapsed (T0 timeout set value) after DTMF tone "B" was received, if the T.30 protocol does not begin from the FAX2NET server, the fax cuts off the line and enters the redial wait state. (Handled as T0 timeout.)

When communication terminates abnormally for other reason until the fax enters the T.30 protocol from a response (line pull-out, stop by STOP key, or document pull-out, etc.), the communication is handled like normal one.

After the fax enters the T.30 protocol, if an alarm occurs, the fax performs the same alarm operation as for the normal G3 communication.

4.1.2 E-mail Address

When a one-touch key in which an E-mail address is registered is used as a destination, a call is issued to a FAX2NET server telephone number.

If a FAX2NET server telephone number, account number is registered, an E-mail address is not accepted as a destination.

While the fax is in the redial wait or delayed TX wait state, the FAX2NET server registration cannot be deleted. ("ILLEGAL OPERATION")

Alarm processing is the same as for international telephone number.

The result of communication with the FAX2NET server is described in the Activity report.

Whether a target mail arrives at the last destination cannot be recognized from the FX051.

The user must therefore confirm the communication result on a FAX2NET Web page.

The head of an E-mail address can be defined up to 20 digits as a destination in the sender ID column. In the same way, the head of an E-mail address can be defined up to 20 digits as a destination to the Activity report.

4.2 Broadcasting

4.2.1 Destination Specification

As a broadcasting destination, a general destination number can be mixed together with a telephone number or E-mail address including an international telephone prefix. Broadcasting can be specified only with international call or E-mail address.

The method of specifying an E-mail address as a broadcasting destination is the same as of the normal method using the O.T. key.

When information about the FAX2NET server is not registered, no E-mail address can be specified as a broadcasting destination. The broadcasting destination cannot include a one-touch key in which Web URL is registered.

4.2.2 Sending Operation

For broadcasting, a call is issued to destinations one by one.

Even if a broadcasting destination includes multiple international telephone numbers and E-mail addresses, a call is issued to FAX2NET server destinations one by one. In this case, multiple destinations cannot be reported to the FAX2NET server.

The communication with the FAX2NET server for each destination is the same as of a single-destination sending.

The FX051 assumes that the sending to the destination is completed after the sending to the FAX2NET server ends. At printing of a broadcasting end report, therefore, data may not arrive at the remote facsimile.

4.3 Web Printing

4.3.1 Requests

Web printing begins by selecting a one-touch key in which Web URL is registered as a destination. If information about a Web address or FAX2NET server is not registered, Web retrieval is invalid.

To prepare for Web printing, first convert a character string registered as a Web address according to the conversion table shown in Section 5.4.

When a Web printing request is issued, it is only described in the Activity report without facsimile communication.

For details on the Web address report to the FAX2NET server, see the chapter 7.

4.3.1.1 Alarms

When the FAX2NET server returns no reply or is busy, redial is handled as normal redial. After the FAX2NET server replies, a communication error due to TA or TB timeout is handled like the single destination sending.

If DTMF tone "D" is returned instead of DTMF tone "B" after a Web address is reported, the system performs the same operation as of the detection of the DTMF tone "D" for single-destination sending.

4.3.2 Reception

When fetching a requested home page, the FAX2NET server facsimile-sends its data to the request source. This is performed in normal G3 communication mode.

The maximum time from a Web printing request to an incoming call from the FAX2NET server is not defined. If the FAX2NET server fails the fetch of a requested Web page, it is not reported to the request source facsimile.

4.4 Payment Card Registration

If the Payment Card PRG. is selected from User Programming, the screen changes to the Card Number input screen.

Enter the Card Number only with digits (max 16 digits). (However, the number can be entered up to 20 digits.)

A call is issued to the FAX2NET server after the Card Number is entered, and Account ID, "#8930", Card Number and Check sum are sent to the FAX2NET server using DTMF tone.

The fax shifts to the T-30 protocol after receiving the tone "B" from the FAX2NET server, and since the registered result report is sent from the FAX2NET server, the fax message is received by means of the same methods as polling reception. but the Card Number is not preserved.

The Payment Card Number is entered in the Activity Report but Message Confirmation Report is not entered.

If DTMF tone "D" is returned from the FAX2NET server, the fax displays an alarm message.

When the FAX2NET server returns no replay and in case of the interruption of power supply, the fax does not redial.

4.5 Non FAX2NET Dialing

In case the user does not desire the facsimile transmission via the FAX2NET server, the user can cancel dialing to the FAX2NET server by specifying "+" prior to dialing of the international telephone prefix.

4.6 Confidential and Relay Sending

The FAX2NET function is not used for confidential and relay sending. A call is issued to a general line according to a specified number. An E-mail address cannot be specified for a sending destination.

4.7 PBX Setting

- (1) When PBX setting is ON and DIAL PREFIX is not set, no call is issued to the FAX2NET server. To use the FAX2NET function at PBX=ON, DIAL PREFIX must be set.
- (2) When PBX setting is ON and Flash or Earth is set, if the head is a hyphen, the FAX2NET function is valid regardless of whether DIAL PREFIX is set. (The data succeeding the hyphen is compared with the international telephone prefix.)

4.8 Polling Reception

At polling reception, no call is issued to the FAX2NET server.

4.9 Other Restrictions

The following restrictions are provided for the FAX2NET function:

- (1) PC FAX mode
At sending in PC FAX mode, the FAX2NET function is invalid. Before calling, whether there is an international telephone prefix is not checked.
- (2) Destination search function
An E-mail address is not retrieved to search for a destination using the search key.

(3) Telephone number registration application on PC

The application or driver group for MFP function is not changed from FX051; therefore, the following item is limited:

The telephone number registration application on PC cannot register an E-mail address in a one-touch key or change the contents for each one-touch key. The column of a one-touch key in which an E-mail address is registered is not registered from the telephone number application on PC.

When an attempt is made to register a new telephone number in a one-touch key in which an E-mail address is already registered on the telephone number application, the telephone number is newly registered, and the E-mail address remains internally.

(4) RMCS

The user cannot reference, enter, or change the FAX2NET server registration function using RMCS.

The user cannot also register an E-mail address in a one-touch key or change the contents of the one-touch key using RMCS. The column of the one-touch key in which an E-mail address is registered is not registered on the RMCS screen.

When an attempt is made to register a new telephone number in a one-touch key in which an E-mail address is already registered on RMCS, the telephone number is newly registered, and the E-mail address remains internally.

5. Procedure

This section explains a protocol required to report a sending destination or requested Web page address from the FX051 to the FAX2NET server.

5.1 Telephone Number

The figure below shows a procedure when the sending destination is a telephone number.

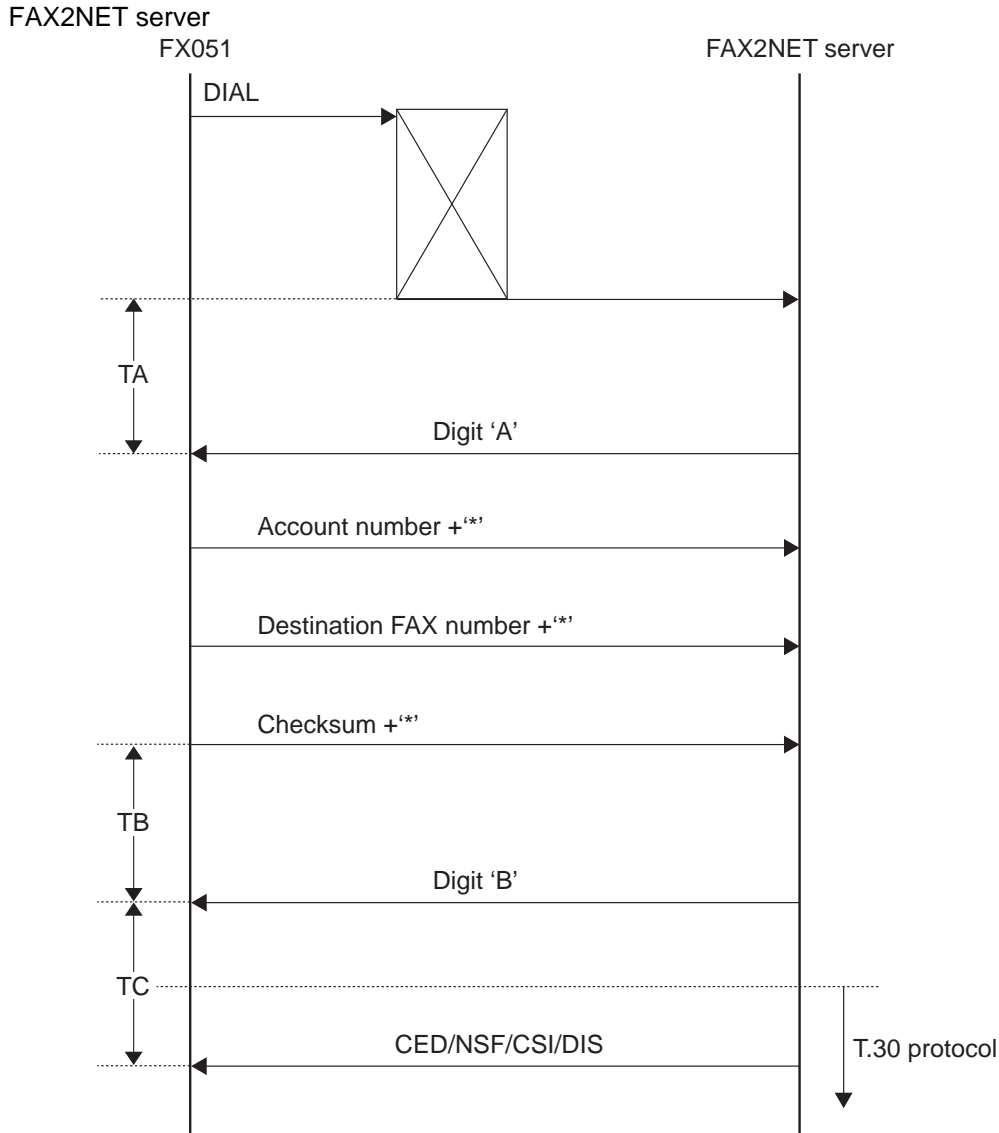

- TA < 10 sec.; TB < 6 sec. TC < T0 timer set value. At TA or TB timeout, the service code is 14D0.
- The length of each DTMF tone is 300 ± 25 ms. The time between digits is 100ms min. and 5 sec. max.
- The Account number, destination facsimile number, and check sum are delimited by DTMF tone "*" .
- For details on check sum, see Section 5.5.
- When the FAX2NET server issues digit "D" instead of digit "B," the request is rejected. In this case, disconnect the line smoothly.
- After digit "B," CNG need not be issued from the facsimile.

5.2 E-mail Address

The figure below shows a procedure when the sending destination is an E-mail address.
FAX2NET server

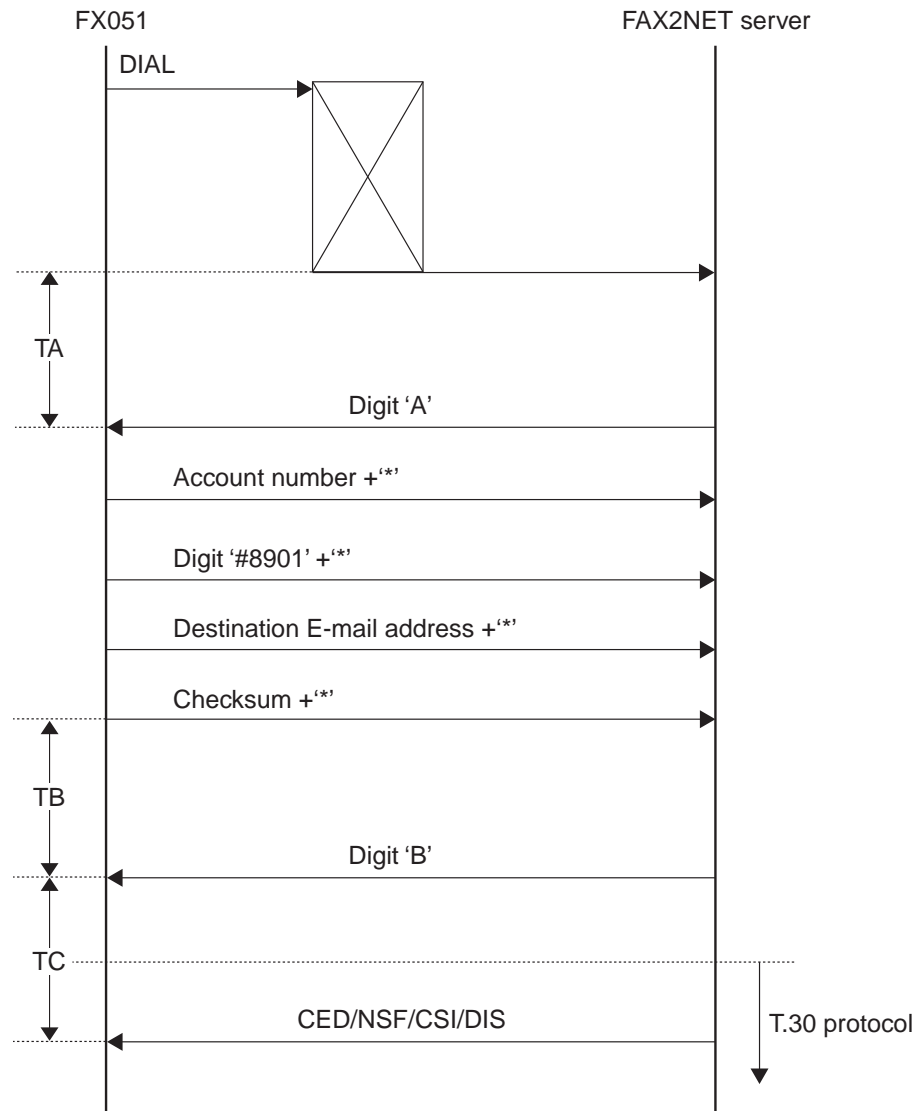

- TA < 10 sec.; TB < 6 sec. TC < T0 timer set value. At TA or TB timeout, the service code is 14D0.
- The length of each DTMF tone is 300 ± 25 ms. The time between digits is 100ms min. and 5 sec. max.
- The Account number, destination facsimile number, and check sum are delimited by DTMF tone “*.”
- The system adds DTMF tone “#8901” before the E-mail address and assumes that a DTMF tone group succeeding “#8901” is obtained by converting an E-mail address
- For details on check sum, see Section 5.5.
- When the FAX2NET server issues digit “D” instead of digit “B,” the request is rejected. In this case, disconnect the line smoothly.
- After digit “B,” CNG need not be issued from the facsimile.

5.3 Web Address

The figure below shows a procedure for requesting a Web page.
FAX2NET server

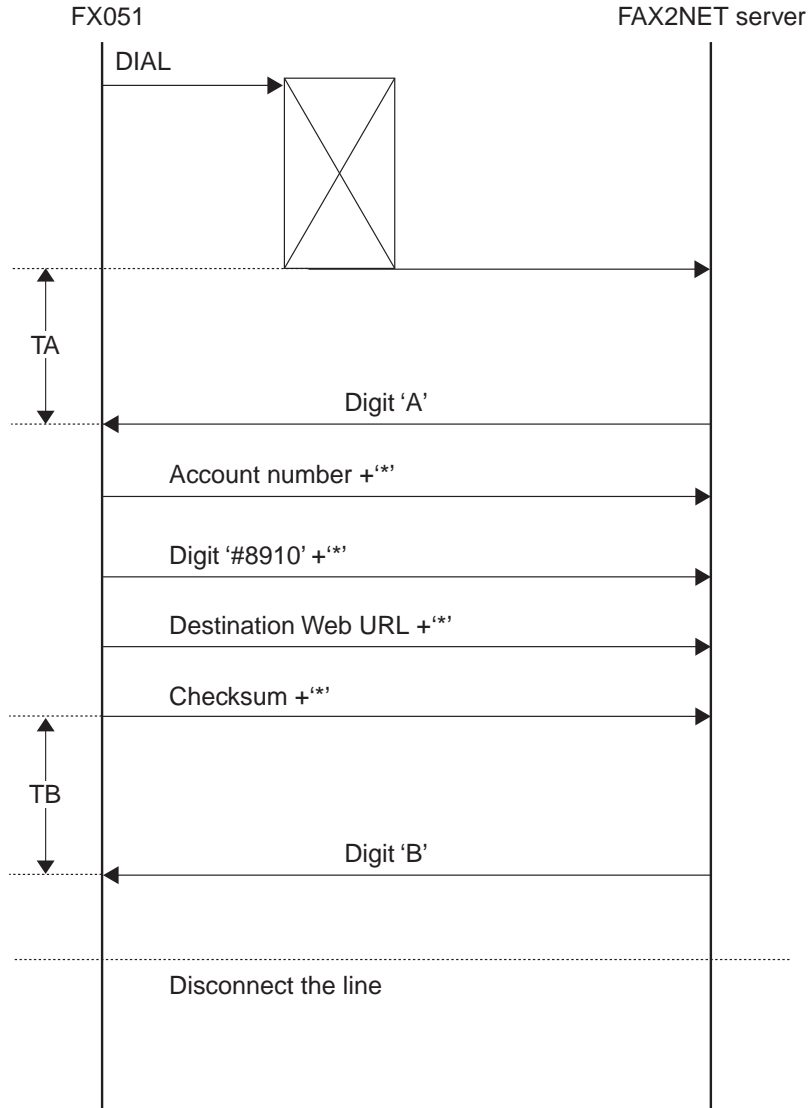

- TA < 10 sec.; TB < 6 sec. set value. At TA or TB timeout, the service code is 14D0.
- The length of each DTMF tone is 300 ± 25ms. The time between digits is 100ms min. and 5 sec. max.
- The Account number, Web URL, and check sum are delimited by DTMF tone "*" .
- The system adds DTMF tone "#8901" before the Web address and assumes that a DTMF tone group succeeding "#8901" is obtained by converting a Web address
- For details on check sum, see Section 5.5.
- When the FAX2NET server issues digit "D" instead of digit "B," the request is rejected. In this case, disconnect the line smoothly.

5.4 Payment Card Registration

The figure below shows a procedure for Payment Card Registration.

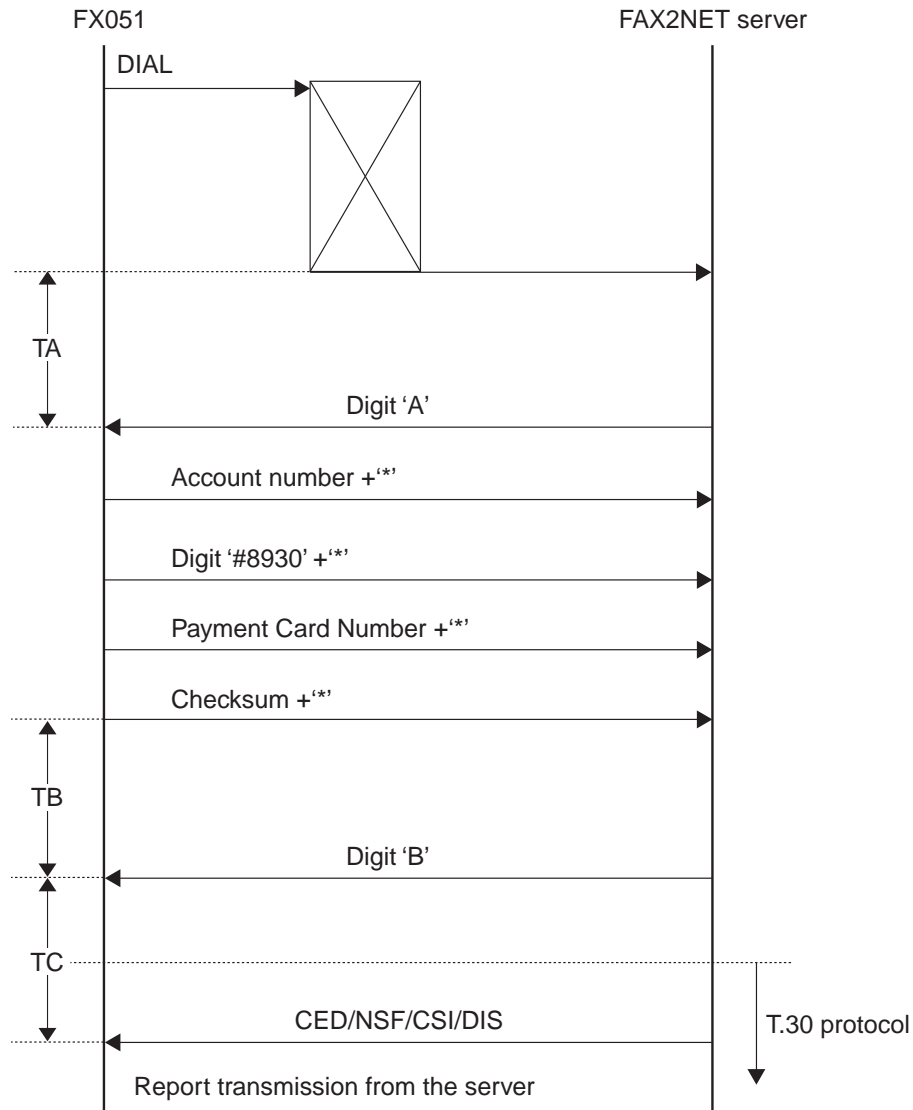

- TA < 10sec. TB < 6sec. set value. At TA or TB timeout, the server code is 14D0.
- The length of each DTMF tone is 300 ± 25ms. The time between digits is 100ms min. and 5sec. max.
- The Account Number, Card Number, and Check sum are delimited by DTMF tone "*".
- The fax adds DTMF tone "#8930" before the Web address and assumes that DTMF tone group succeeding "#8930" is obtained a Card Number.
- For the detail on Check sum, see Section 5.5.
- When the FAX2NET server issues digit "D" instead of digit "B", the request is rejected, in this case, disconnect the line smoothly.

5.5 Character Conversion Table

To report each E-mail address and Web address with a DTMF tone, digits, uppercase letters, lowercase letters, and symbols composing an address must be converted to a character string that can be expressed with DTMF tones. Each character must be expressed with a combination of two or three DTMF tones.

The character conversion table is as follows.

Table 1 DTMF tone conversion table for E-mail and Web addresses

	00	10	20	30	40	50	60	70	80	90
0	Space	*	4	>	H	R	\	f	p	z
1	!	+	5	?	I	S]	g	q	{
2	"	,	6	@	J	T	^	h	r	
3	#	-	7	A	K	U	_	i	s	}
4	\$.	8	B	L	V	'	j	t	~
5	%	/	9	C	M	W	a	k	u	
6	&	0	:	D	N	X	b	l	v	
7	'	1	;	E	O	Y	c	m	w	
8	(2	<	F	P	Z	d	n	x	,
9)	3	=	G	Q	[e	o	y	<i>f</i>

		C10	C20	C30	C40	C50	C60	C70	C80	
0			È	Ò	Ü		ř	ú		
1			É	Ó			ñ	û		
2		À	Ê	Ë		è	ò	ü		
3		Á	Ë	Ï		é	ó	ý		
4		Â	Ì	Ö	à	ê	ô			
5		Ã	Í		á	ë	õ	ÿ		
6		Ä	Î		â	ì	ö			
7		Å	Ï	Ù	ã	í				
8				Ú	ä	î				
9			Ñ	Û	å	ï	ù		EURO	

* The hatched letters cannot be entered under the FX051.

* ß, Æ, Ø, æ, å and ø cannot be entered because they are omitted in this conversion table.

5.6 Check Sum

The check sum is obtained by converting the transmitted DTMF tone string (Account No. + Control data field) values to character string according to ASCII code table 1 and adding them.

In this case, the asterisk "*" between the account number and control data field is excluded.

Example:

"12345" + '*' + "#8912" + "C236789" + '*' + Check sum + '*'

Check sum calculation is as follows:

49 (for 1) + 50 (for 2) + 51 (for 3) + 52 (for 4) + 53 (for 5) +
35 (for #) + 56 (for 8) + 57 (for 9) + 49 (for 1) + 50 (for 2) +
67 (for C) + 50 (for 2) + 51 (for 3) + 54 (for 6) + 55 (for 7) + 56 (for 8) + 57 (for 9)
= 943

"0943" is transmitted as the check sum.

6. Operation

6.1 Function Selection Transition (1/2)

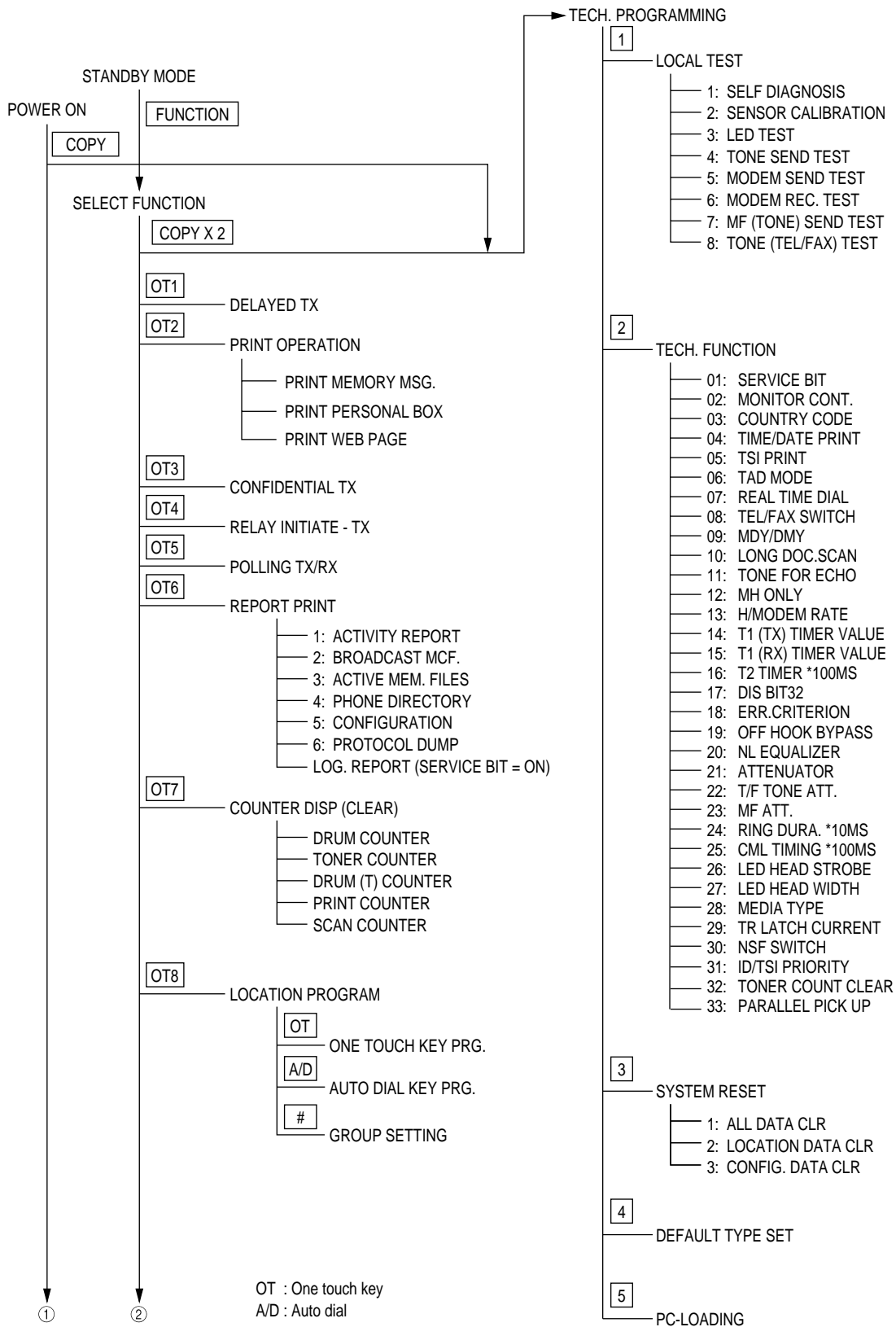

Function Selection Transition (2/2)

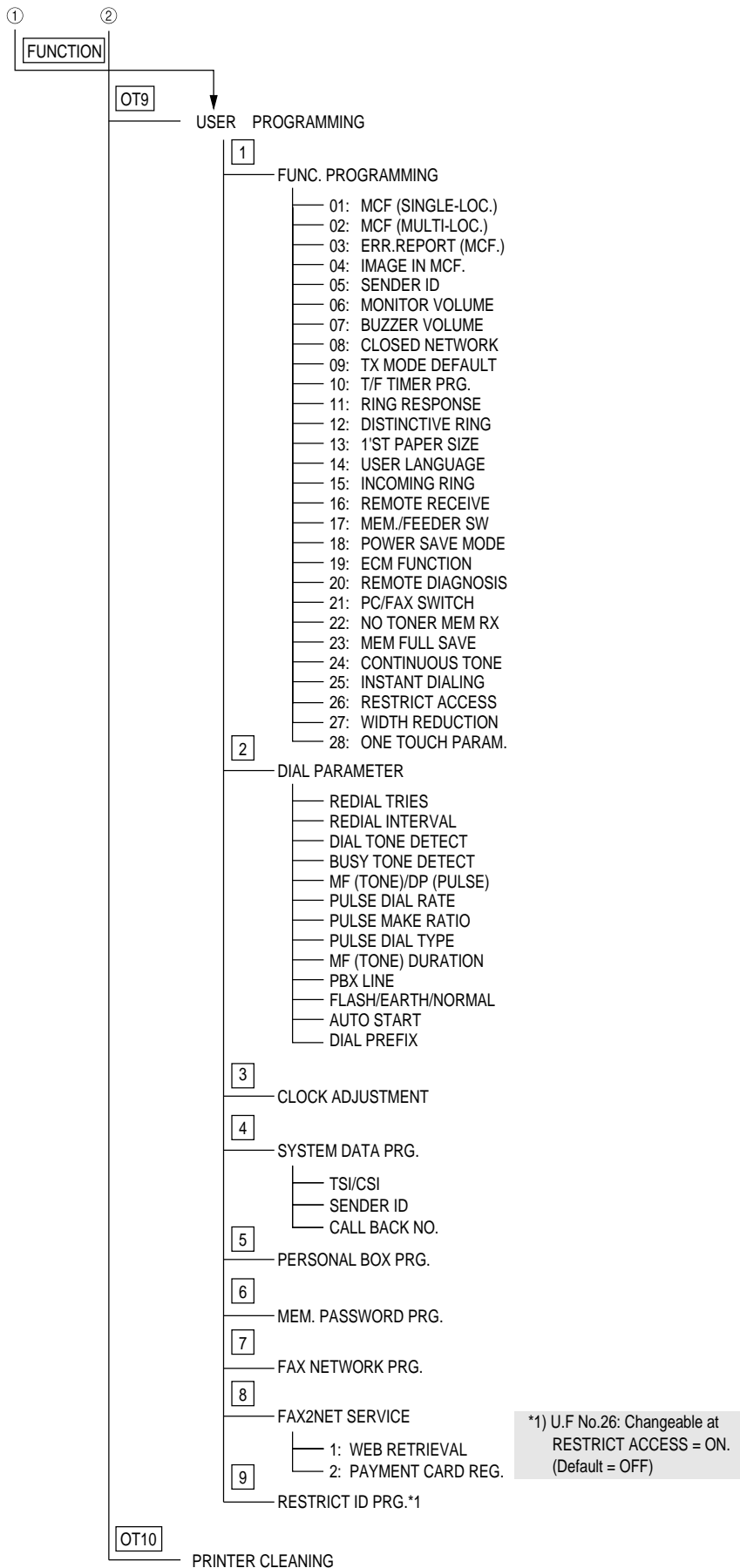

6.2 One-Touch Dial Registration Transition

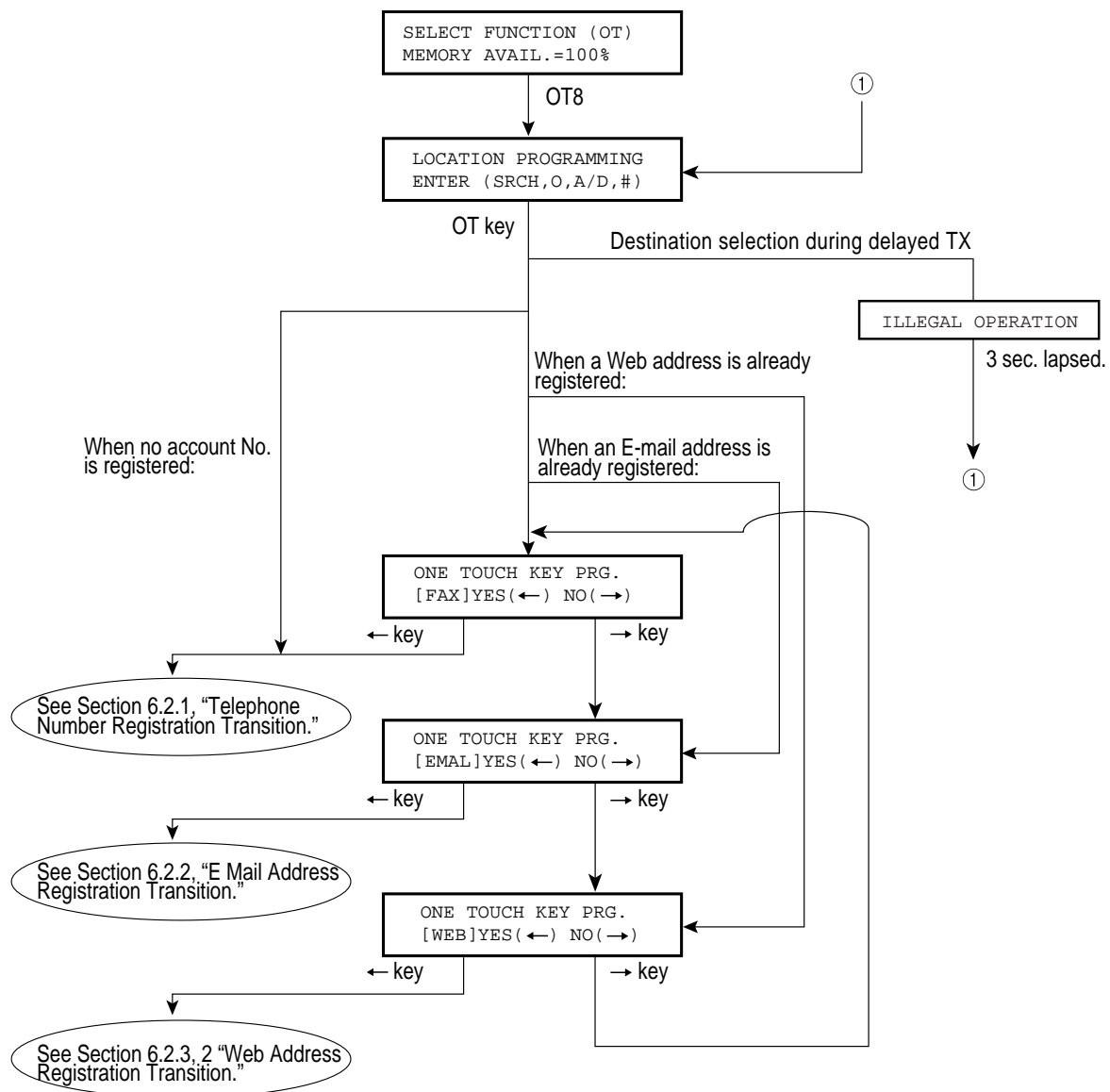

6.2.2 E-mail Address Registration Transition

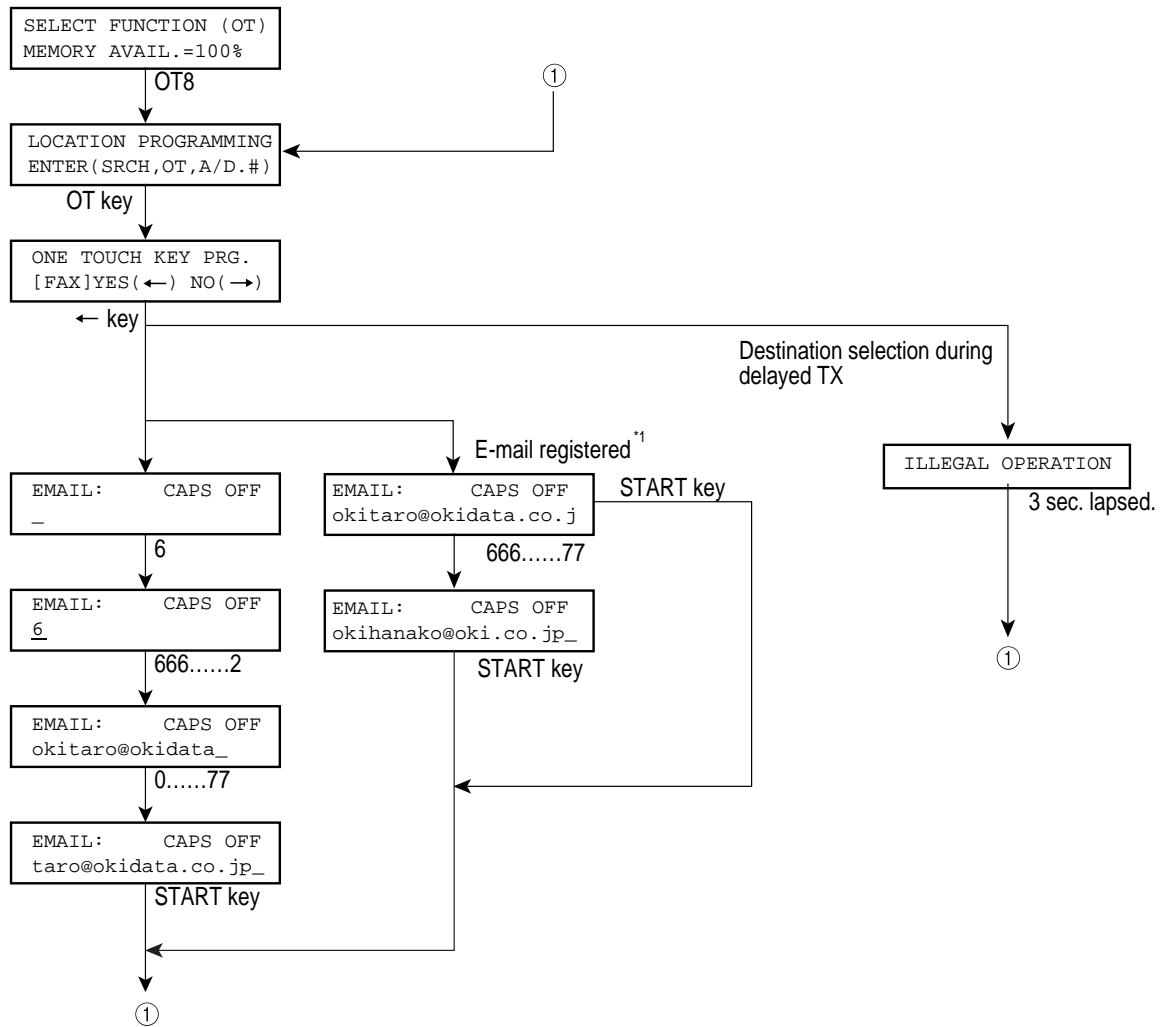

*1) CAPS MODE must be set to OFF at start of registration.

Note 1) If an E-mail is doubly registered in a one-touch key in which a telephone number or Web address is already registered, the telephone number or Web address is deleted.

6.2.3 Web Address Registration Transition

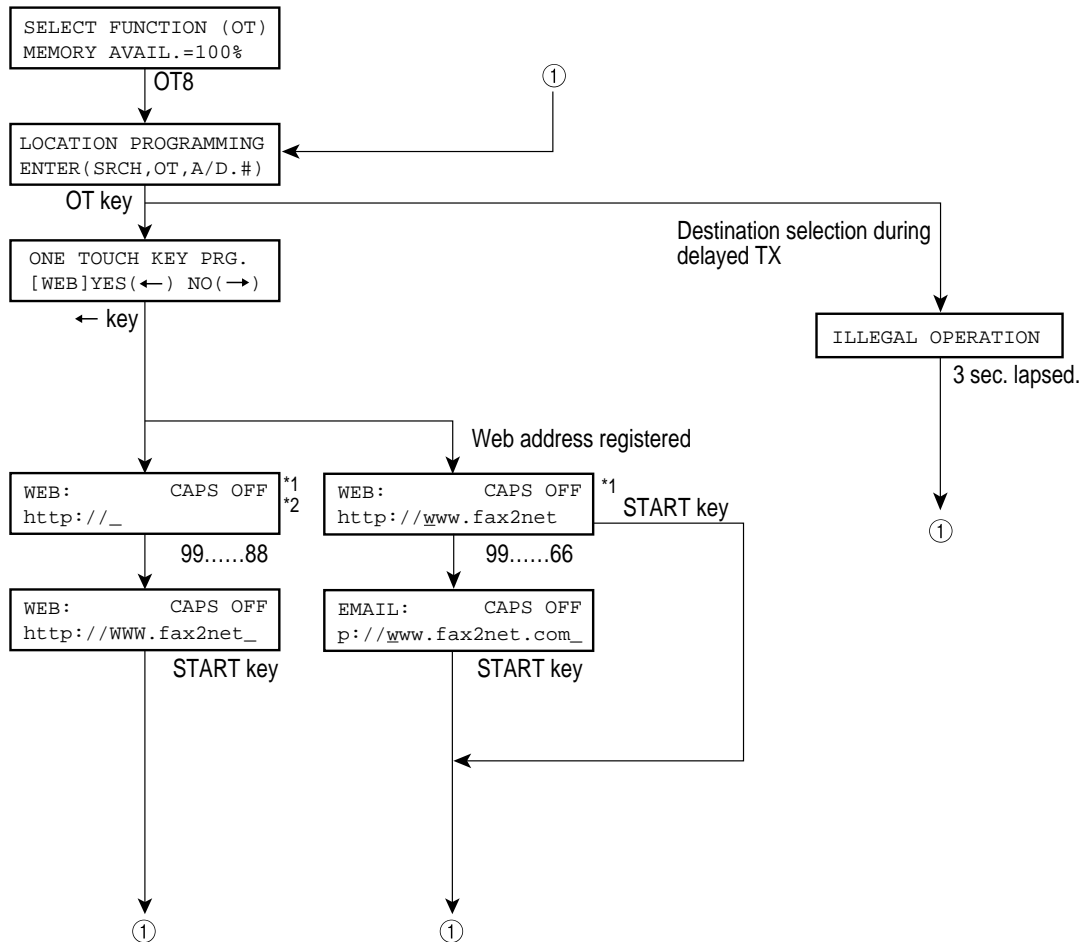

*1) CAPS MODE must be set to OFF at start of registration.

*2) "http://" cannot be edited. Up to 64 characters can be registered, excluding those characters.

Note 1) If a Web address is doubly registered in a one-touch key in which a telephone number or E-mail address is already registered, the telephone number or E-mail address is deleted.

Note 2) A one-touch key in which only a web address is registered cannot be registered as a group.

Note 3) When a Web address is registered in a one-touch key registered as a group, the one-touch key is deleted from the group destination.

6.3. Destination Registration Space Display/Registration Transition

6.3.1 One-Touch/Abbreviated Dial Registration Transition

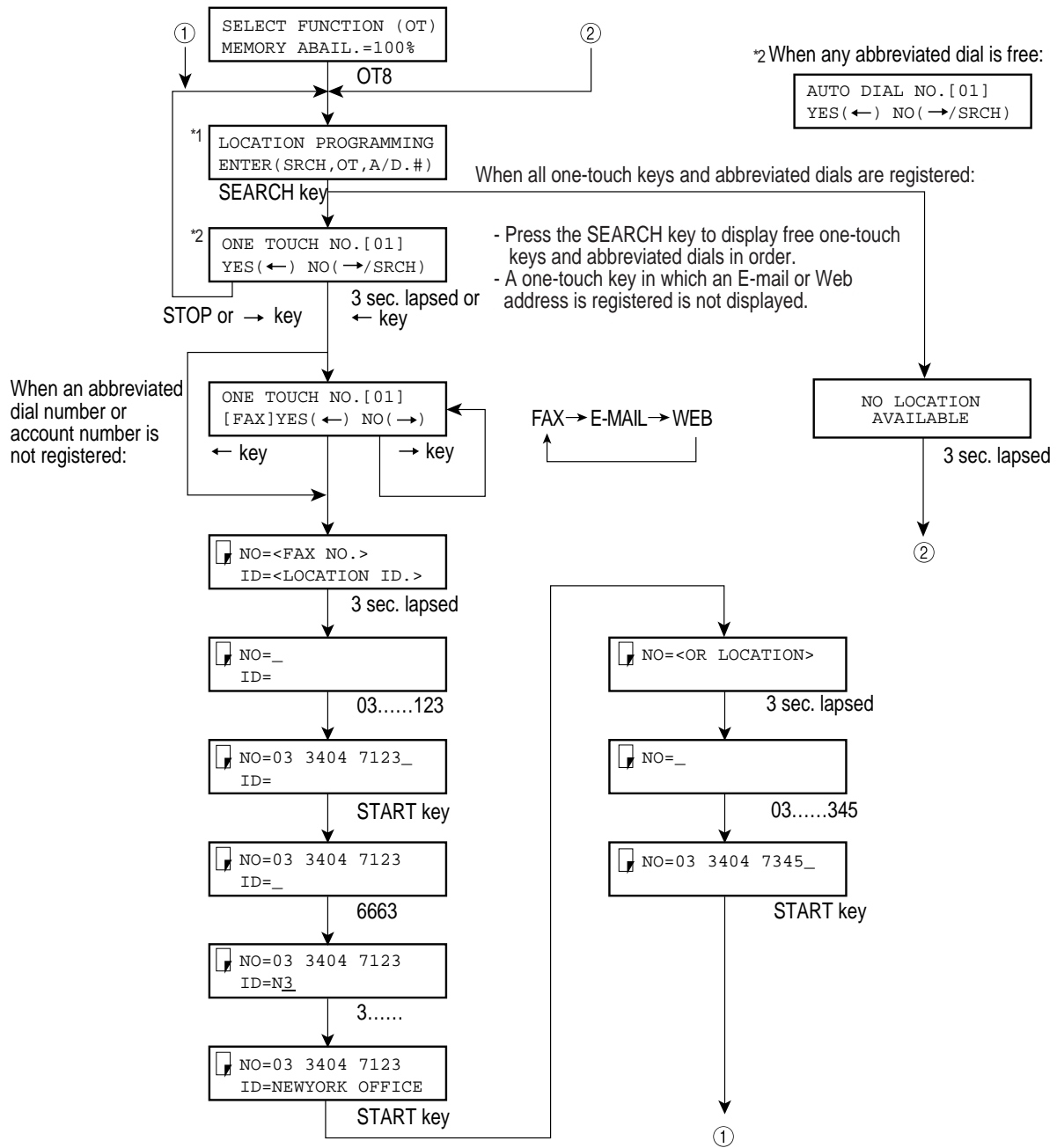

To write to flash, press the STOP or FUNCTION key on the screen shown by *1, or wait until 59-sec. timeout occurs.

6.3.2 Ten Key Stack Calling Transition

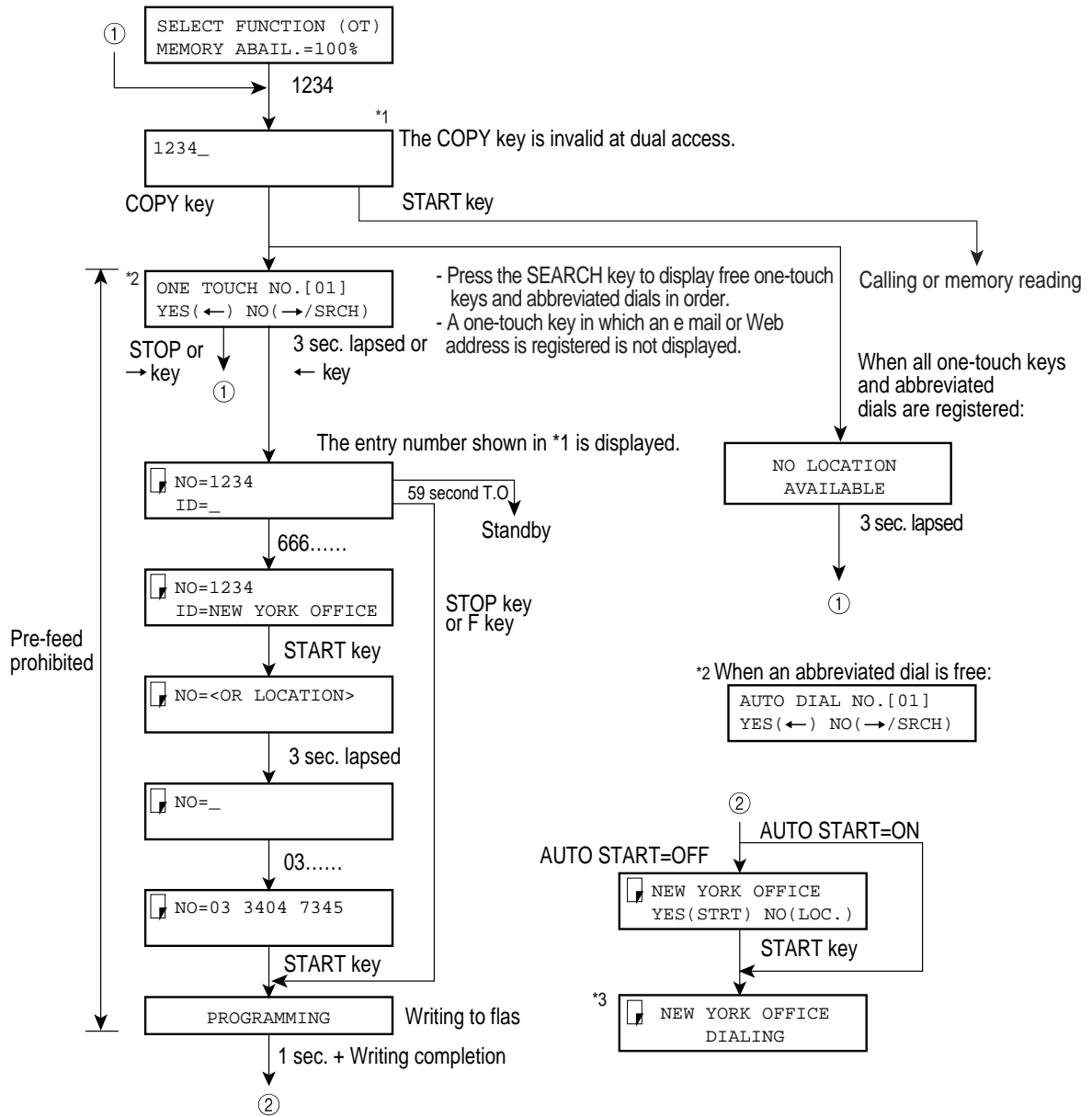

*1) For function communication, the COPY key is invalid. (delayed transmission, broadcasting, confidential, relay, polling reception, etc.)
 When the number of entered digits exceeds 32, the COPY key is invalid.

6.4 CAPS Key Function

The CAPS key assigns OT7.

E-mail address registration example

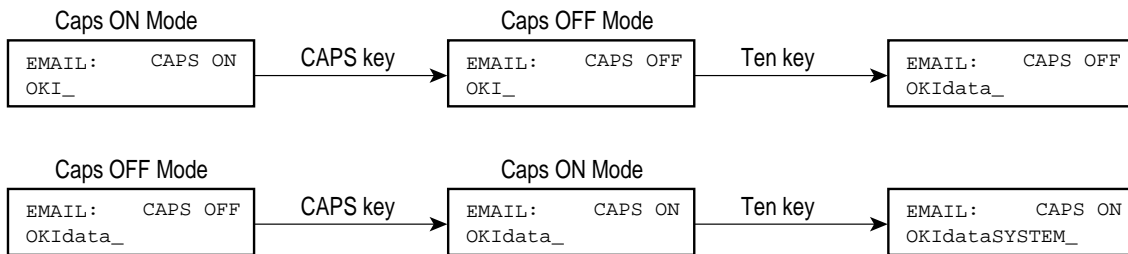

- ① At entry of an E-mail address or Web address, the uppercase ⇔ lowercase letter entry switching is enabled.
- ② CAPS can be switched to OFF during CAPS = ON.

6.5. User Setting Transition

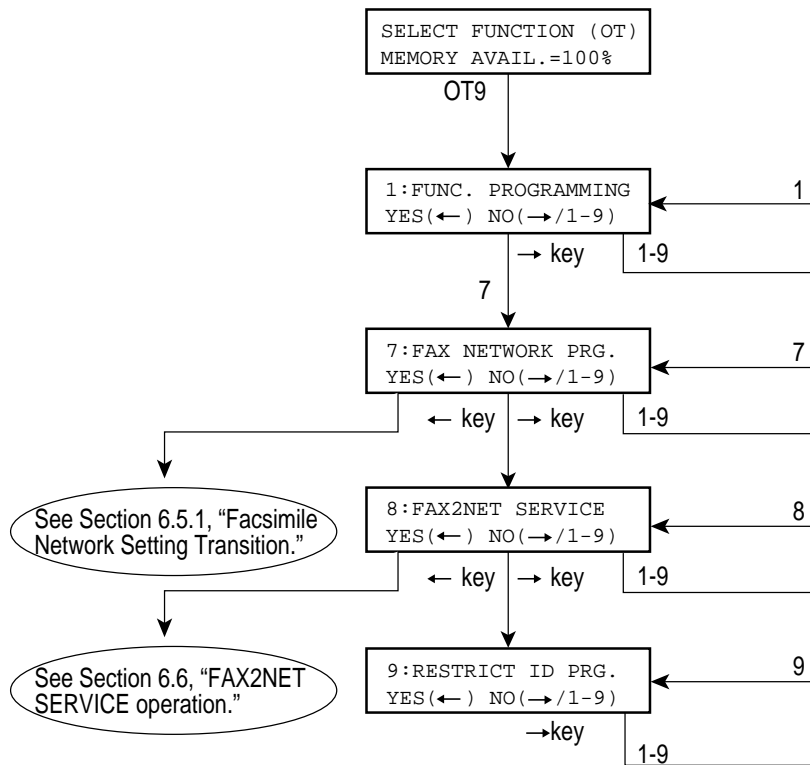

User setting 26: RESTRICT ACCESS = ON

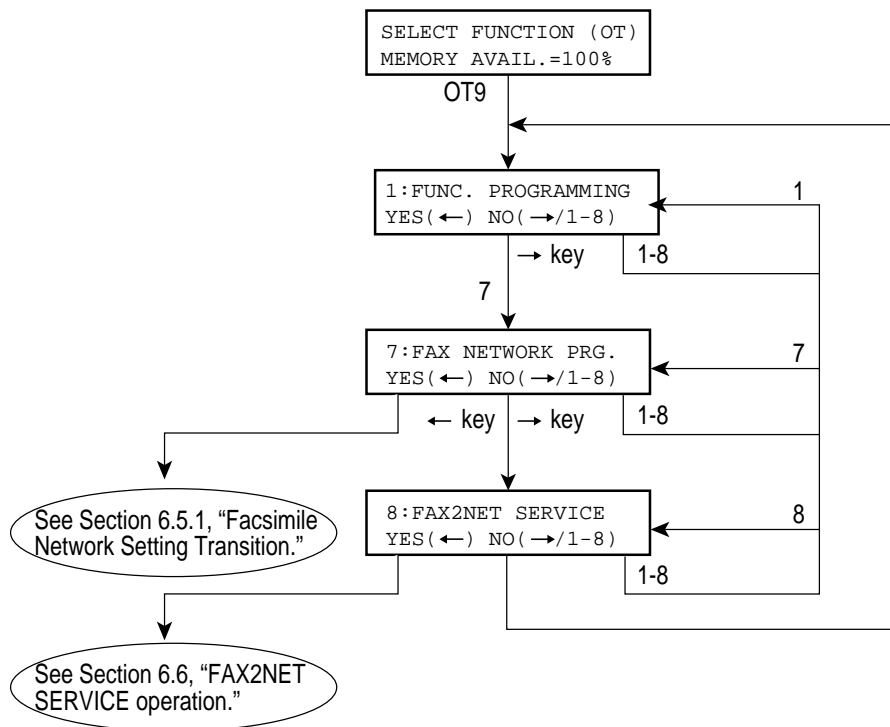

User setting 26: RESTRICT ACCESS = OFF

6.5.1 Facsimile Network Setting Transition

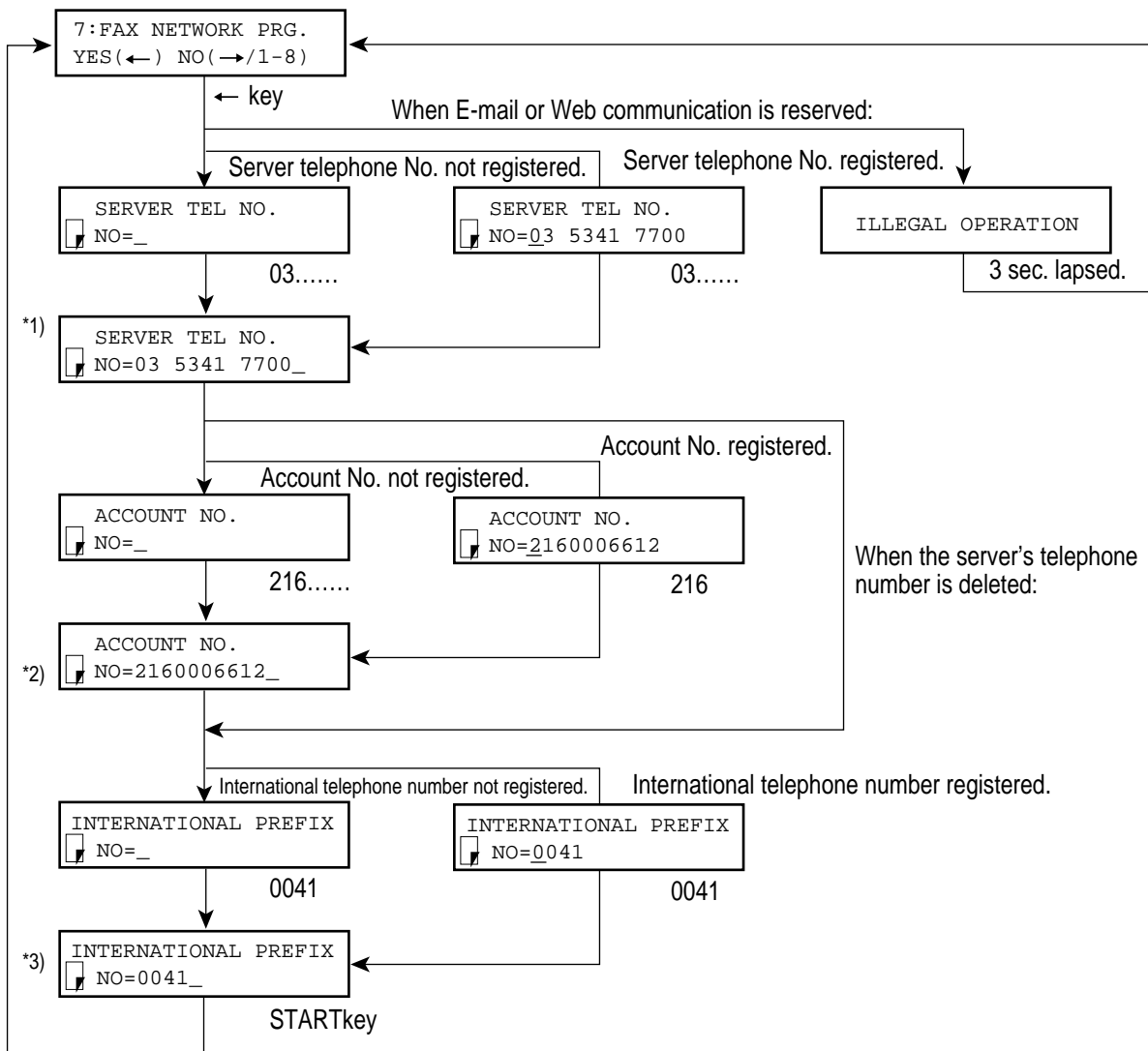

- *1) Press the space key to delete the character and press the START key; the account number is deleted.
- *2) Press the space key to delete the character and press the START key; the server's telephone number is deleted.
The server's telephone number and account number are set by pressing the START key. (The server's telephone and account numbers must be registered.)
- *3) Press the START key to suppress spaces for registration.
- Note: If no server's telephone number is registered, an account number cannot be registered.

6.6 FAX2NET SERVICE

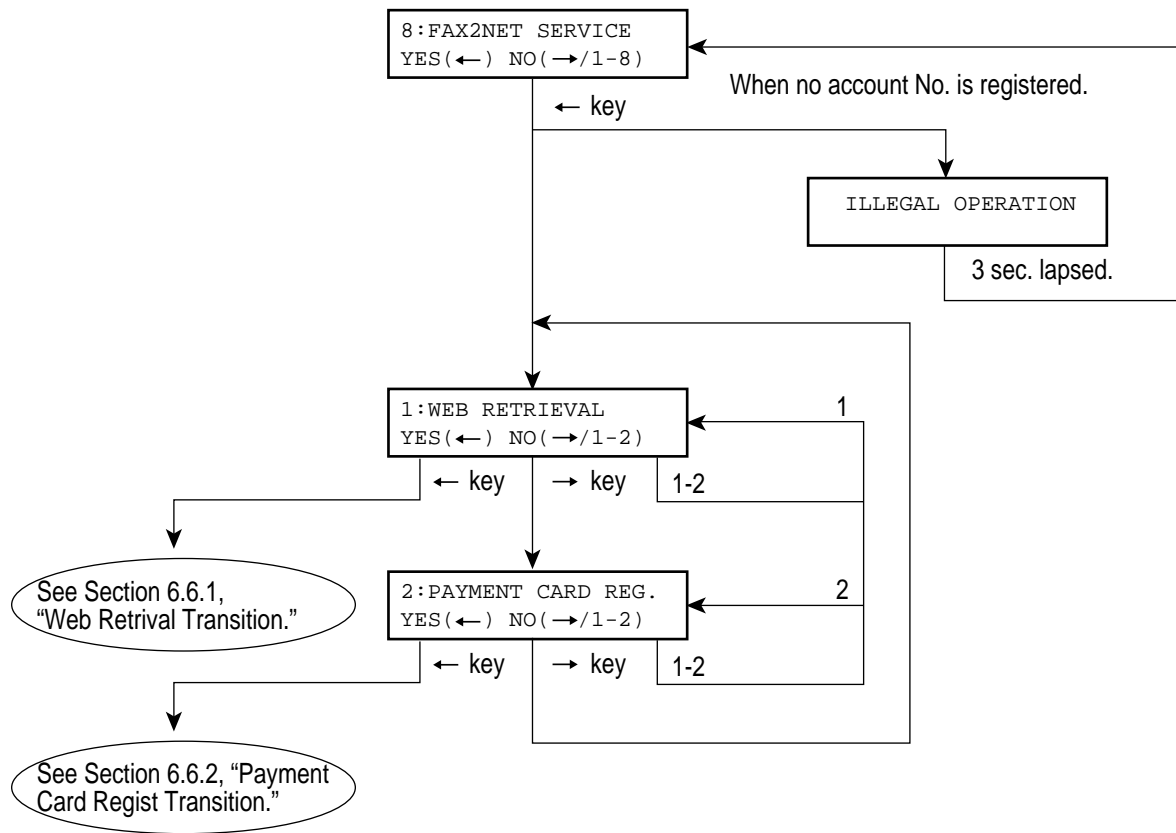

6.6.1 WEB Retrieval Transition

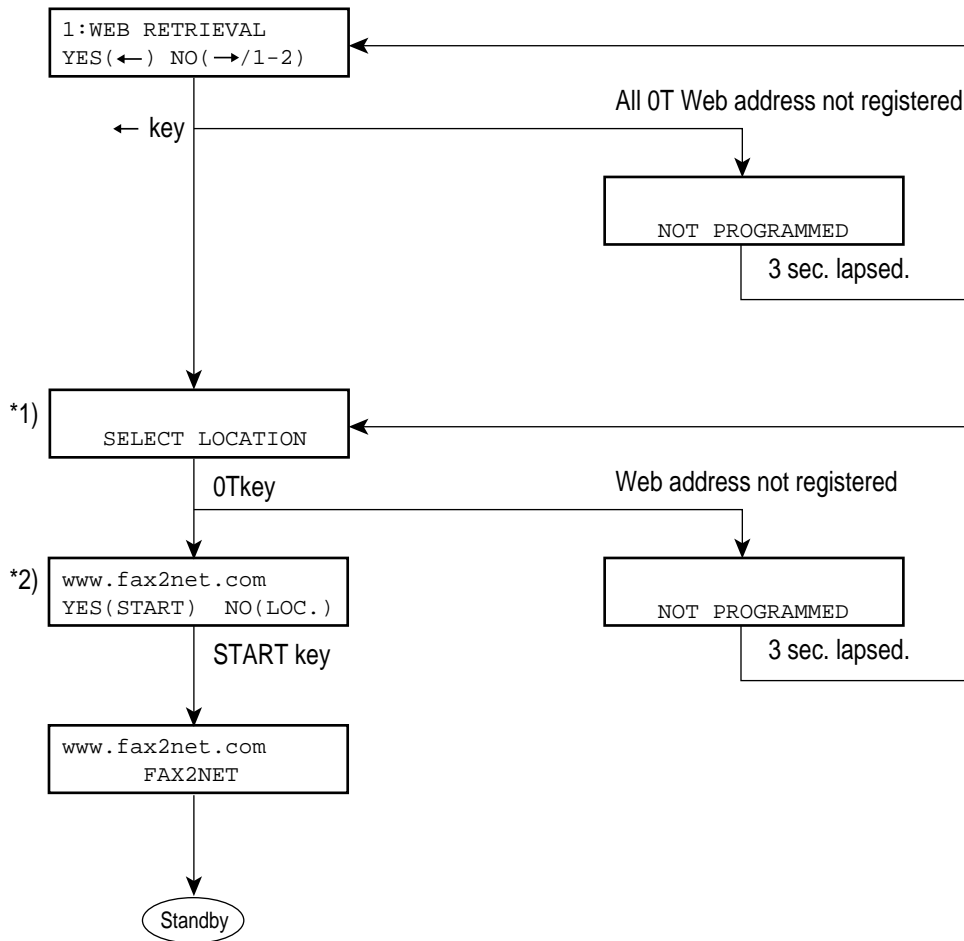

*1) One-touch keys 1 to 10 only can be selected.
 *2) Web addresses are displayed from the top on the upper row. The broadcasting is inhibited.

6.6.2 PAYMENT CARD REGIST

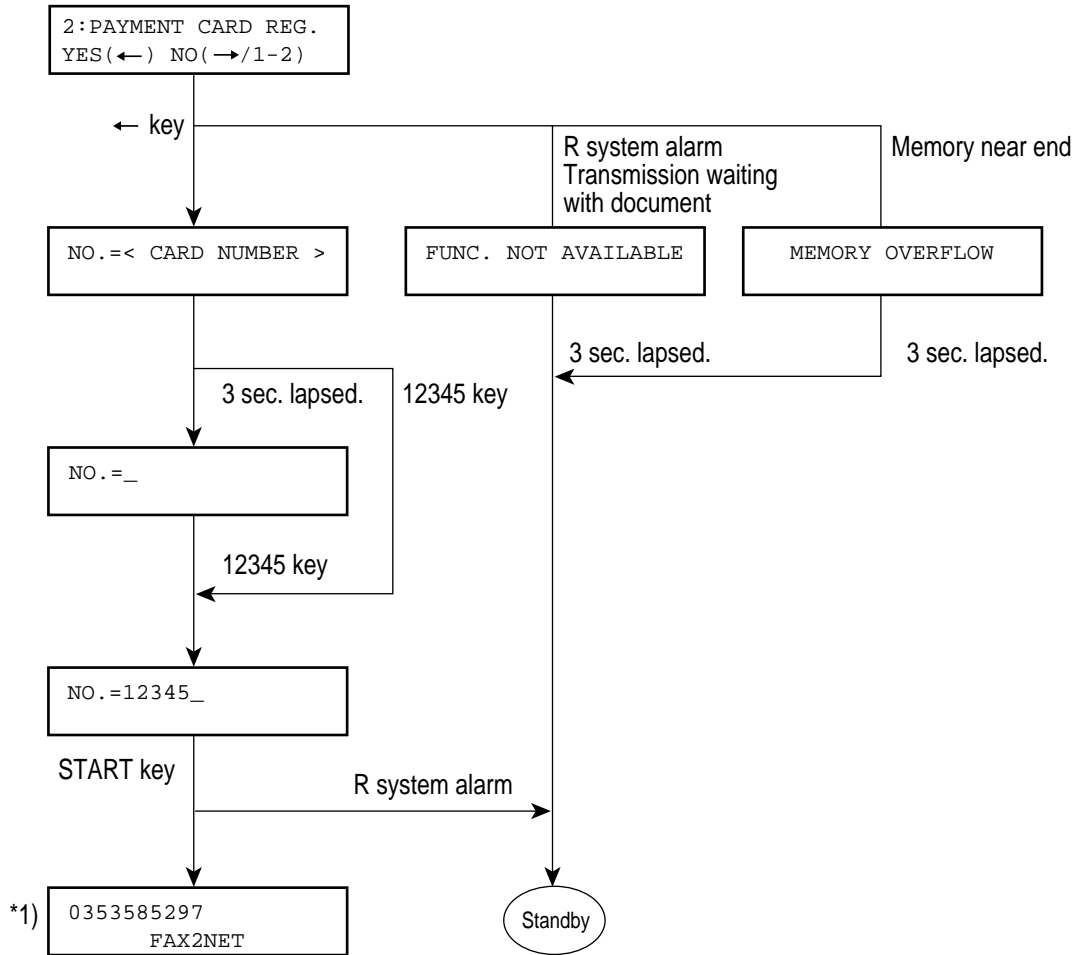

*1) Server Tel No. is displayed from the top on the upper row.

6.7. Operation Rules

6.7.1 Outline of Operation

(1) Selecting OT in which an E-mail address is registered

- 1) When OT is selected at confidential sending, relay request sending, polling reception, or tune dial before calling, message "ILLEGAL OPERATION" is displayed, and OT cannot be selected. At real-time calling, message "ILLEGAL OPERATION" is also displayed, and OT cannot be selected.
- 2) When no account number is registered, if a single destination, broadcasting destination, or group destination is registered, OT cannot be selected.
- 3) When an account number is deleted, if it is already registered as a group, it is deleted from the group destination.
- 4) When the START key is pressed after a selected destination is displayed, if there is no document, message "LOAD DOCUMENT" is displayed.

(2) Selecting OT in which a Web address is registered

Apply (1), 1) and 2).

(3) An E-mail and Web addresses cannot be searched by the search function.

(4) Valid keys at registration of various information

Item	Valid key	Max.number of digits
Web address	Ten keys 0 to 9, *, #, hyphen, OT1 to OT10	64
E-mail address	Ten keys 0 to 9, *, #, hyphen, OT1 to OT10	64
Server telephone No.	Ten keys 0 to 9, *, #, hyphen, OT8, OT9, OT10	32
Account No.	Ten keys 0 to 9, OT9	16
International telephone No.	Ten keys 0 to 9, OT9	10
Payment card No.	Ten keys 0 to 9, OT9	20

(5) Character allocation to one-touch keys

- OT1 : .
- OT2 : _
- OT3 : ~
- OT4 : "
- OT5 : /
- OT6 : @
- OT7 : CAPS
- OT8 : +
- OT9 : Space
- OT10: P (Pause)

- (6) Ten key character display sequence at registration of E-mail or Web address
- | | |
|-----------|---------------------------------------------------------------------------------------------|
| Ten key 1 | 1 |
| Ten key 2 | 2 -> A -> B -> C |
| Ten key 3 | 3 -> D -> E -> F |
| Ten key 4 | 4 -> G -> H -> I |
| Ten key 5 | 5 -> J -> K -> L |
| Ten key 6 | 6 -> M -> N -> O |
| Ten key 7 | 7 -> P -> Q -> R -> S |
| Ten key 8 | 8 -> T -> U -> V |
| Ten key 9 | 9 -> W -> X -> Y -> Z |
| Ten key 0 | 0 -> 1 Symbol -> 2 Umlaut character -> Norway character->Symbol
(Note 1, Note 2, Note 3) |
| Ten key * | * |
| Ten key # | # |

Note 1) 0 -> Umlaut character -> Norway character -> Symbol at NATIONAL CODE = GER

Note 2) The Umlaut character, Norway character, and “ . ” cannot be selected at registration of an E-mail or Web address.

Note 3) Based on the symbol display sequence (. _ ” / @ \ % ! # & ' () * — : ; = ? ·).
* Symbols @, \, ”, _ , ~, and % cannot be specified at registration of an ID.

- (7) A server telephone number, account number, international telephone number, and E-mail or Web address can be initialized with ALL DATA CLR, LOCATION DATA CLR, or DEFAULT TYPE SEST.

1 Symbols (! # & ' () * + , — . / : ; = ? @ \ ” _ ~ % ·)

2 Umlaut characters (ä ß ñ ö ü)

3 Norway characters (Æ Å Ø æ å ø)

7. Report

7.1 Configuration Report

The following items are added unconditionally. (For details on the number of registered digits and types for each item, see Operation.)

25:INSTANT DIALING	26:RESTRICT ACCESS	27:WIDTH REDUCTION	
ON	OFF	OFF	
TEL NO.	=	12345678901234567890	
CALL BACK NO.	=	12345678901234567890	
RERVER TEL NO.	=	12345678901234567890123456789012	
ACCOUNT NO.	=	1234567890123456	
INTERNATIONAL PREFIX	=	1234567890	
REDIAL TRIES	3TRY	REDIAL INTERVAL	3MIN
DIAL TONE DETECT	OFF	BUSY TONE DETECT	ON

Addition of new item

7.2 Telephone Directory List Report

Describe an E-mail address and Web URL at a one-touch definition portion. The E-mail address and Web URL must also be described in lowercase letters.

URL must be described with http://.

(For details on the number of registered digits and types for each item, see Operation.)

ONE TOUCH	LOCATION ID	27:WIDTH REDUCTION	PRM ECHO RATE
	OFF	OFF	(OFF) (14.4)
1	ABCDEFGHIJKLMNO <input type="checkbox"/>	12345678901234567890123456789012	
	OR <input type="checkbox"/>		
2	abcdefghijklmnopqrstuvwxy.....@ABCDEFGHIJKL.....co.jp		Describe max. 64 digits on one line.
3	s-ishika@okidata.co.jp		When an E-mail address is registered:
4	http://iboodt78.taka.okidata.co.jp/odsnews		When Web URL is registered:
5	ODS TAKASAKI <input type="checkbox"/>	0273242116	
	OR <input type="checkbox"/>		

7.3 Lowercase Letter Description Support

7.3.1 Location ID

A character string including lowercase letters and symbols can be described in the Location ID column of the following reports:

- Telephone directory report (Total number of registered digits)
- Broadcasting entry report (First 20 digits)
- Broadcasting confirmation report (First 20 digits)

7.3.2 Distant Station ID

A character string (first 20 characters) including lowercase letters and symbols can be described in the Distant Station ID column of the following reports:

- Activity report
- Power outage report
- Message confirmation report
- Active memory files
- Protocol dump

7.4 Description of Communication Mode Column

Describe information about the FAX2NET service communication in the MODE column of the following reports:

- Activity report
- Power outage report
- Message confirmation report
- Active memory files
- Protocol dump

<Contents of MODE column>

FAX over IP (International call)	FNET
FAX to E-MAIL (E-mail)	FNET
Web retrieval (Web print request)	WEB
Broadcast including FAX over IP or FAX to E-MAIL .	B.C.
Payment card registration	P-CARD

7.5 Service Code Description

Add service codes 909D and 14D0 to the following reports:

- Activity report
- Power outage report
- Message confirmation report
- Protocol dump

8. Service Codes

The following service codes are assigned for the FAX2NET functions:

- 909D

A telephone number to be called was composed of only a dial prefix and international telephone prefix (and hyphen), and a sending destination telephone number to be transmitted to the FAX2NET server was not found.

- 14D0

The FAX2NET server returned DTMF tone "D" that meant "no good."

Free Manuals Download Website

<http://myh66.com>

<http://usermanuals.us>

<http://www.somanuals.com>

<http://www.4manuals.cc>

<http://www.manual-lib.com>

<http://www.404manual.com>

<http://www.luxmanual.com>

<http://aubethermostatmanual.com>

Golf course search by state

<http://golfingnear.com>

Email search by domain

<http://emailbydomain.com>

Auto manuals search

<http://auto.somanuals.com>

TV manuals search

<http://tv.somanuals.com>