

OKI

VoIP-TA

Oki Voice Over IP Telephony Adapter



User's Guide

Version 1.2

Oki Electric Industry Co., Ltd.

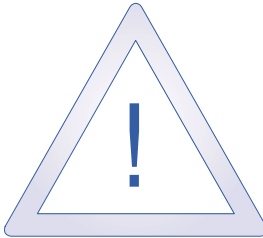

Safety Warning!

This document contains information regarding the safe use of the Oki VoIP-TA unit. Carefully observe and comply with all safety precautions.

© 1999-2000, Oki Electric Industry Co., Ltd. All rights reserved.

The VoIP-TA Internet Telephony Adapter and the Maintenance Console Software are products of Oki Electric Industry Co. Ltd.

The right to reproduce this manual and/or the Maintenance Console Software is restricted by the Copyright Act.

No part of this document may be copied, reproduced, stored on a retrieval system, or transmitted in any form or by any means, electronic, mechanical, photocopying, recording, or otherwise, in whole or in part, without the written permission of Oki Electric Industry Co. Ltd.

Information in this document is subject to change without notice.

The contents of this document and the Maintenance Console Software have been prepared with the utmost care. However, if you notice an irregularity, please contact an authorized sales agent.

Oki Electric Industry Co. Ltd., assumes no responsibility with regard to consequences resulting from the use of the Maintenance Console Software and/or the contents and interpretation of the information contained in this manual.

Ethernet is a registered trademark of Xerox Corporation.

MS-DOS and Windows are registered trademarks of Microsoft Corporation.

Other companies and product names mentioned in this manual may be the trademarks or the registered trademarks of their respective companies. Oki Electric Industry Co. Ltd., neither endorses or recommends third-party products mentioned herein nor assumes responsibility with regard to the use or performance of these products.

Contents

Important Safety Instructions	iv
Introduction	vi
I Outline	1
The VoIP-TA	1
Features	1
Front panel	2
LEDs	2
Back panel	3
Connectors	3
II Installation	5
Connections	5
Cautions	7
III Placing Calls	8
Via an IP network	8
General operation	8
Services	9
Third party incoming call during another call	9
End-to-end service using DTMF signaling	10
Call transfer during a telephone Call	10
Absent service	12
Details of services	13
Using both a PSTN line and the IP network	13
Using the IP network only	16
IV Troubleshooting	17
V Specifications	18
Important Equipment Information	19
Warranty and Service	20

Important Safety Instructions

When handling or using the VoIP-TA unit, the following safety precautions should be observed to prevent injury and/or damage to the unit. Use of this equipment in a manner other than that specified in this and other VoIP-TA documents will void the product warranty and may result in damage, serious injury or death.

WARNING Incorrect use by neglecting the following instructions may cause fire, electric shock, unit failure, resulting in damage, serious injury or death.



- Do not connect a commercial power supply circuit, analogue, digital (ISDN) or PBX digital telephone line to the LAN or PC port.
- Do not use with power supply voltages other than those specified.
- Do not insert or drop metal objects into any of the openings.
- Do not disassemble or modify this product in any way.
- Do not place any vases, cups, cosmetics, chemicals, pots or any other containers containing liquids or small metal objects, near the product. Spillages into the product may cause fire, electric shock or unit failure.
- Do not try to connect or disconnect the power plug with wet hands.
- Insert the power plug fully and securely into the power outlet. To avoid electric shock, do not use a plug that exposes the terminals when inserted.
- Avoid star connections as fire or overheating may result.
- Do not put heavy objects on the AC adapter cord or expose it to excessive heat.
- Do not pull the cord or allow it to overheat as it may be damaged and could cause fire or electric shock.
- If lightning strikes a neighboring area, stop operating the product by disconnecting the AC plug (by grasping the power plug, not the cord) from the power supply outlet.
- Always ground the product properly.

- Do not use AC adapters other than those specified or supplied.
- If liquid enters the unit, immediately disconnect the power plug (by grasping the power plug, not the cord) from the power outlet and contact an authorized sales agent or service provider. Continued use may result in fire or electric shock.
- If smoke or fumes are emitted from the unit, immediately disconnect the AC plug (by grasping the power plug, not the cord). When smoke emissions cease, contact a sales agent or service office for repair. Continued use may cause fire, electric shock or unit failure.
- Use only authorized sales agents or service offices for internal inspection or repair.

CAUTION Incorrect use by neglecting the following instructions may cause fire, electric shock, unit failure resulting in injury or damage.



- Avoid oily, humid or dusty locations, such as on a kitchen table or near a humidifier.
- Do not place the unit on unstable or inclined surfaces as the unit may fall.
- Avoid locations exposed to direct sunlight or moisture as internal overheating may occur causing fire or unit failure.
- Wipe away with a dry cloth any water droplets that may be on the surface of the unit. Water intrusion may cause fire or unit failure.
- Do not cover up the vent holes of the VoIP-TA. If covered, internal overheating may result causing fire or unit failure.
- Do not unplug the AC power plug by pulling on the cord. Always grasp the plug portion when disconnecting the AC power plug.
- Disconnect the AC power cord and other connectors when moving the VoIP-TA.
- For safety, disconnect the AC plug from the power supply outlet (by grasping the power plug, not the cord) before starting maintenance.

Introduction

Welcome to the world of Oki Internet telephony...

The Oki voice over IP (Internet Protocol) telephony adapter, VoIP-TA, is a self-contained H.323 version 2 compliant communications device that allows organizations to route both voice and facsimile communications over any TCP/IP network.

The VoIP-TA is designed to provide a service that is virtually indistinguishable from that of conventional telephone and facsimile services.

Use this guide to familiarize yourself with the VoIP-TA. Should you need to handle the equipment, pay special attention to the procedures and safety precautions contained in this guide.

The VoIP-TA

The VoIP-TA is a one-channel Internet telephony adapter that provides Internet telephony services conforming to industry standard H.323 version 2 specifications. It can be connected to a conventional analogue telephone or G3 facsimile machine.

Once installed, VoIP-TA units use the Internet Protocol (IP) network to bridge the distance between units at a fraction of the cost associated with conventional telephony methods.

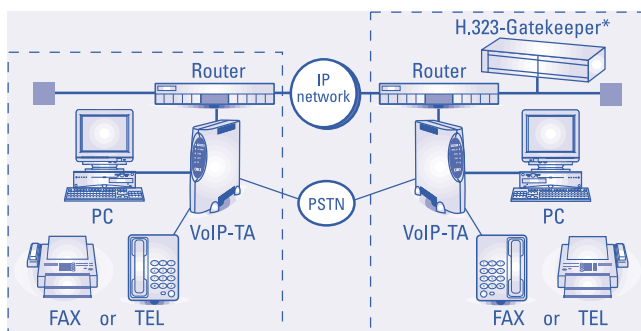

* Gatekeeper is necessary when more than 100 IP addresses are to be used.

Features

- Compact size and one-channel Internet telephony adapter.
- Automatic telephone routing by specified telephone numbers.
- Smooth and natural telephone calls by optimizing the voice buffer.
- Supports Dynamic Host Configuration Protocol (DHCP manual allocation) for local IP addresses.
- Conforms to the ITU-T recommended H.323 version 2 specifications.
- Supplies real-time Internet facsimile communication.
- Uses high quality voice compression technology.

Note The Public Switched Telephone Network (PSTN) is supported by VoIP-TA version 1.2 and later. The version number is clearly marked on the bottom of the unit. Please contact your network manager or authorized sales agent or service office if in doubt, to avoid incorrect use.

Front panel

LEDs

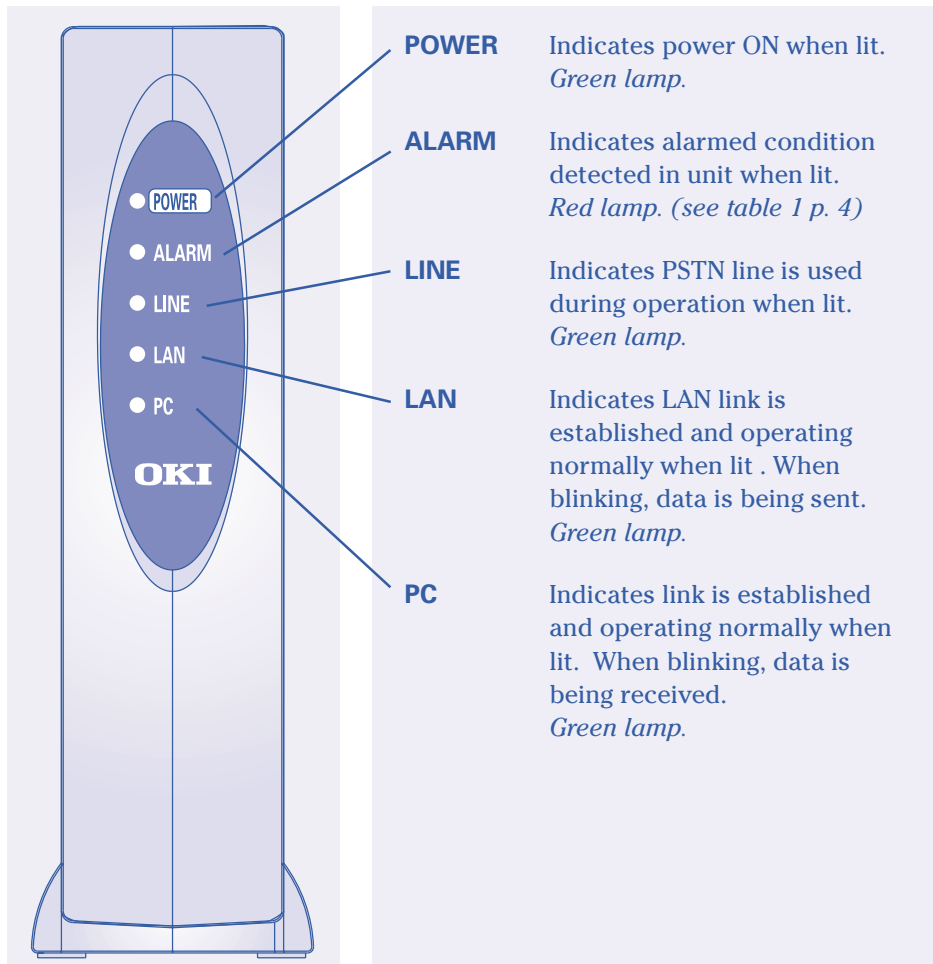

Back panel

Connectors

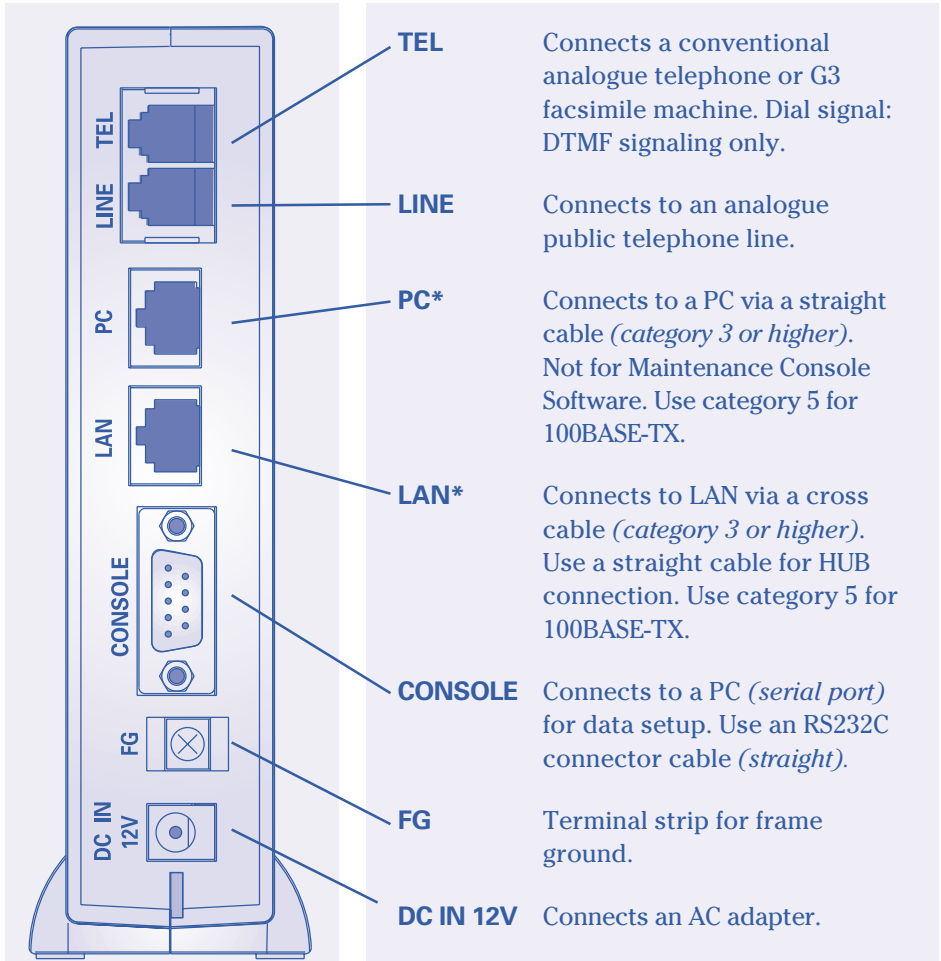

* The communication performances of the LAN and PC ports are always the same and VoIP-TA conforms to the lower of the two. When either the PC or LAN port is 10 BASE-T, both ports are set to 10 BASE-T communication. If a PC is connected to the PC port during a call, the call may be interrupted for approximately one second. Please avoid such usage.

Table 1

Mode	ALARM-LED	LINE-LED	Status
Initialization	Blinks (1 sec. intervals)	OFF	<p>With Gatekeeper: The system will wait for LAN link to be established while Gatekeeper registers the VoIP-TA.</p> <p>Without Gatekeeper: The system will wait for a LAN link to be established.</p>
Operation	OFF	OFF	Standby
	OFF	ON	The telephone line is busy.
	OFF	Blinks (1 sec. intervals)	<p>When using both IP and PSTN: The PSTN is on hold during VoIP calls.</p> <p>When using IP network only: The absent service is setting up.</p>
	Blinks (0.5 sec. intervals)	OFF	The handset is off the hook and the howler tone has already stopped.
Setup	Blinks (0.2 sec. intervals)	Blinks (0.2 sec. intervals)	Normal operation is not available in the <i>Setup</i> mode.
Installation	Blinks (0.2 sec. intervals)	Blinks (1 sec. intervals)	Normal operation is not available in the <i>Install</i> mode. The LED lamp may blink irregularly during the program installation.

Place the main unit in a vertical position as placing it horizontally could shorten the life of the unit.

Connections

The following illustration shows where equipment should be connected to the ports at the rear of the VoIP-TA unit.

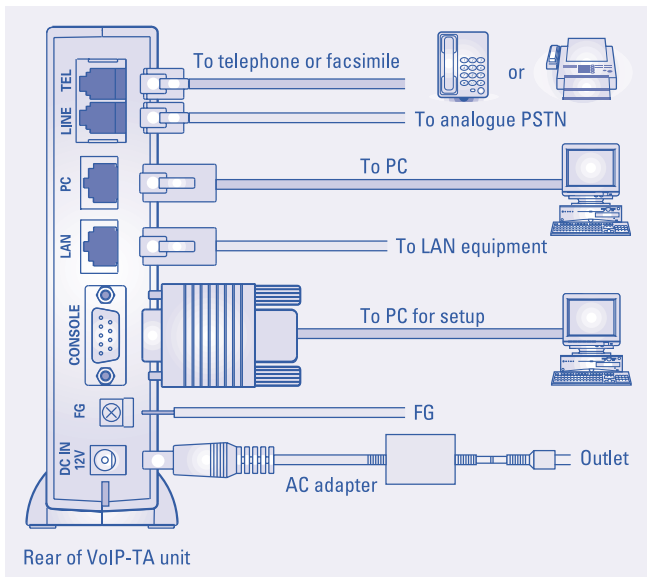

Analogue telephone or G3 facsimile equipment

Connect an analogue telephone or G3 facsimile machine to the *TEL* connector of the VoIP-TA unit via a telephone cord.

To make facsimile connections, the other end terminal equipment should be compliant with the ITU-T T.38 standard.

Analogue PSTN

Connect an analogue PSTN line to the *LINE* port at the rear of the VoIP-TA unit via a telephone cord.

Personal computer (PC)

Connect a PC connector to the *PC* port at the back of the VoIP-TA unit using an unshielded twisted pair (UTP) straight cable (*categories 3 to 5*). If both a PC and LAN are to use 100BASE-TX communications, use category 5 [max. 100m].

Note It is recommended that only one PC is connected to avoid voice deterioration.

LAN

Connect the LAN connector to the *LAN* port at the back of the VoIP-TA unit via a cross cable (*UTP categories 3 to 5*). If connecting to a hub, use a straight cable.

If the LAN is connected by 100BASE-TX and the PC is connected by 100BASE-TX, or if the PC is not connected, use a category 5 cable [max. 100 m].

CONSOLE (*setting up the VoIP-TA with a PC*)

Connect the PC for setup on the VoIP-TA by using the serial cable RS-232C (*9 pin – 9 pin straight*) to the *CONSOLE* port.

FG (*grounding*)

After connecting the frame ground (FG) cable to the *FG* port at the back of the VoIP-TA unit, connect the other end to a ground terminal in the house or ground it separately.

Power source

Connect the supplied AC adapter to the *DC IN 12V* port at the back of the VoIP-TA unit. Connect the attached AC adapter to a power outlet.

Cautions

During installation

- All cables used to connect the equipment must be accessories of the equipment or suitable to fit the equipment.
- Make sure the AC power plug is disconnected from the power outlet when connecting the FG cable to the unit.
- When an exchange machine, such as PBX or EKTS is connected to the TEL port of VoIP-TA, the sound quality may deteriorate. Only one exchange machine should therefore be relayed between the VoIP-TA unit and telephones.
- Interference noise may occur during telephone calls in areas that receive strong radio waves, such as near a broadcasting station or CB radio transmission. If calls are affected in this way, consult your network manager, an authorized sales agent or service office.
- Do not install the VoIP-TA unit near equipment that generates magnetism or radio waves such as TV sets, radios, radio machines, microwave ovens, or inverter-type fluorescent lamps, as this may cause the unit to malfunction.

During use

- Do not subject the unit to strong impact, such as dropping the unit.
- Do not force cables to connect or disconnect as this may result in faults. The connector and port should join with reasonable ease.
- When cleaning the exterior of the VoIP-TA, turn it off and disconnect the unit (by pulling the power plug, not the cord), wipe it with a water damp cloth and wipe it dry with a soft dry cloth. Do not use volatile thinner, alcohol or a silicon cleaner under any circumstances as it may result in damage, discoloration or deformation.

Via an IP network

Placing and receiving calls with the VoIP-TA unit are usually quite simple and performed in the same way as conventional telephone networks. In some cases however, the phone numbers to be used, may differ slightly from the ones you used previously.

General operation

Outgoing calls

Use a telephone that generates a Dual Tone Multiple Frequency (DTMF) signal. Pick up the handset and dial a remote party's telephone number.

Incoming call response

An incoming tone will be emitted from the telephone.

Disconnection

A telephone call can be disconnected by hanging up the handset onto the telephone receiver.

Services

Third party incoming call during another call

You can respond to a third party's incoming call while you are on another call.

- A second party telephone call.
- If a third party calls, a notification tone is sent to your telephone.
- You may speak to a third party by hooking.

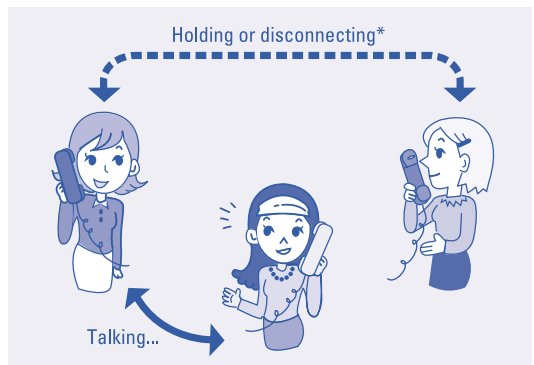
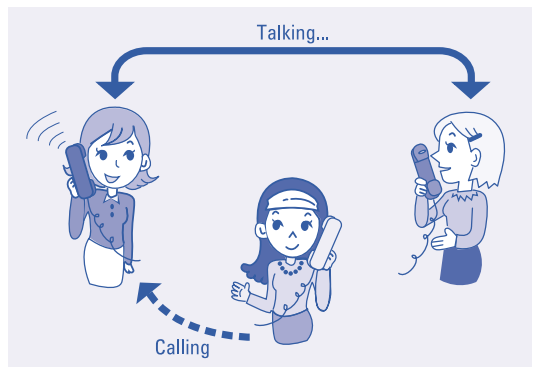
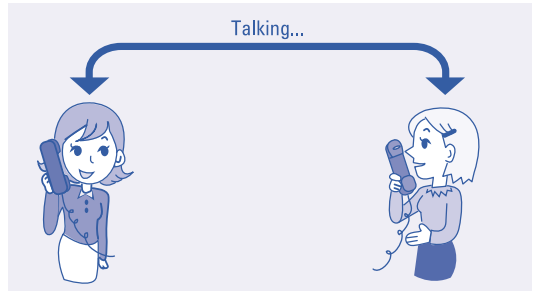

* The operation varies depending on the data settings. See Details of Services p. 13

End-to-end service using DTMF signaling

DTMF signaling can be used via the IP network for answering machines, etc. This service is unavailable when the facsimile transmission, via the VoIP line, is set in the data setup. For details of the data setup, please contact your network manager.

- Making a telephone call

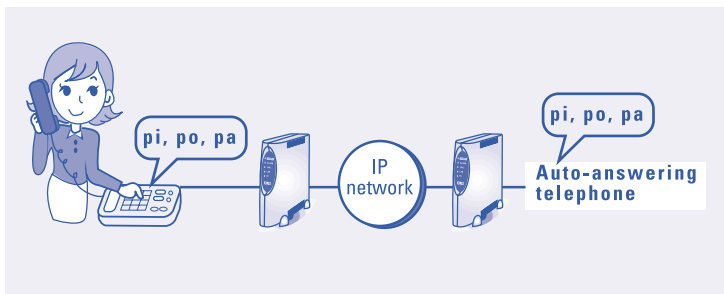

Call transfer during a telephone call

You can transfer a call during a telephone call. This service is unavailable when the PSTN is set in the data settings. For details of the data setup, please contact your network manager.

- During a telephone call



- Put the other party on hold by hooking, and dial a transfer destination number.

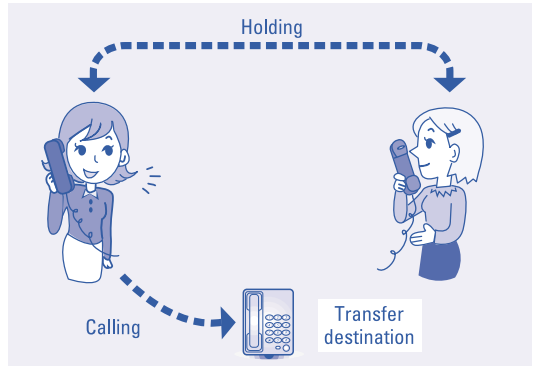

- You may then speak to the party at the transfer destination.

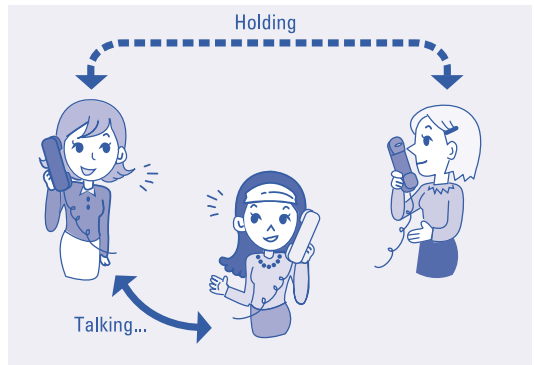

- When you hang up the handset again the call will be automatically transferred to the destination.

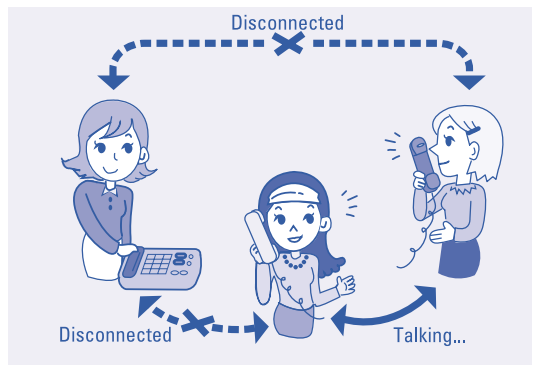

Absent service

If the *absent service* is registered, an incoming call is transferred to a registered destination. The transferred call will not be transferred any further.

This service is inapplicable when a PSTN is set in the data setup. For details of data setup, please contact your network manager.

How to register the absent service

Pick up the handset, dial “***11” and the “destination number to be transferred” and hang up the handset. When the service is set, the *LINE-LED* lamp will blink.

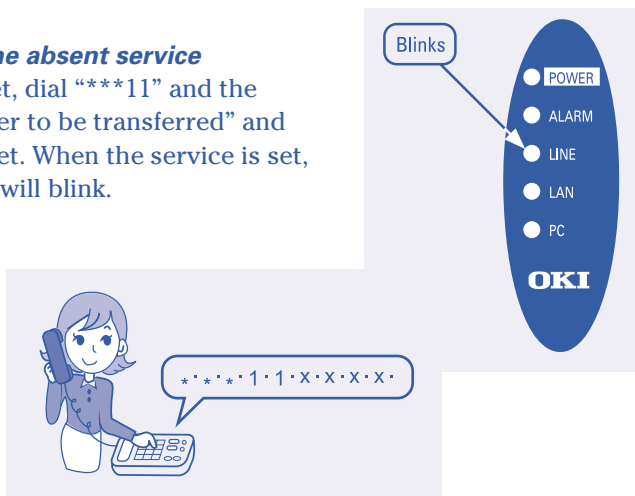

How to cancel the absent service

Pick up the handset, dial “***12,” and hang up the handset. When the service is cancelled, the *LINE-LED* lamp will go off.

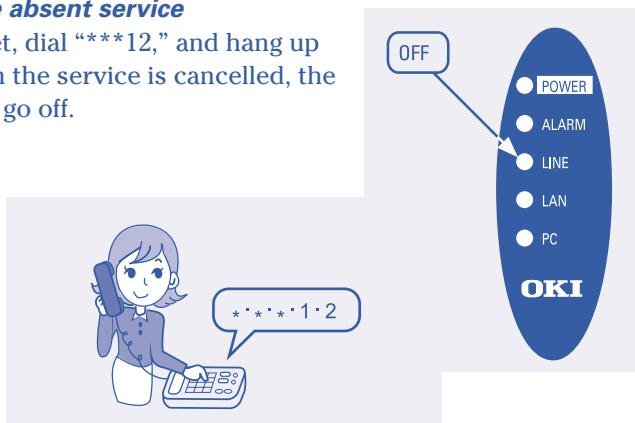

Details of services

There are two ways to use the VoIP-TA unit; using both a PSTN line and the IP network or using only the IP network. These services are determined by the data setup.

Using both a PSTN line and the IP network

Line selection

The selection of a PSTN line or IP network is specified by the first digit of the phone number set by the Maintenance Console Software. Please follow the instructions provided by your network manager.

Third party incoming call during another call

For PSTN line receiving services using hookflash (hooking) from regional telephone service company.

- Response to incoming calls from a PSTN line during a telephone call using the IP network.

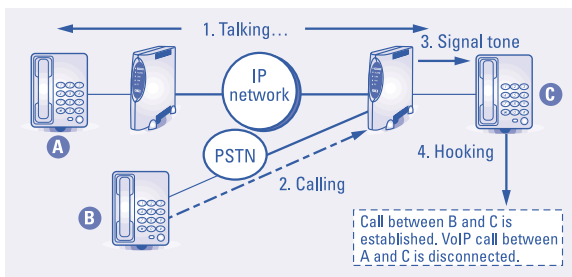

- Response to an incoming call from the IP network during a telephone call using a PSTN line.

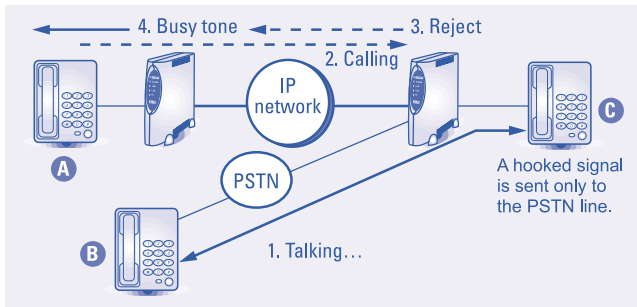

- Incoming operation from the IP network during a telephone call using the IP network.

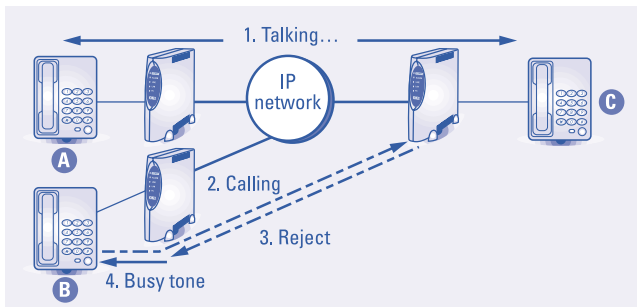

For PSTN line not receiving services using hookflash (hooking).

- Response to an incoming call from a PSTN line during a telephone call using the IP network.

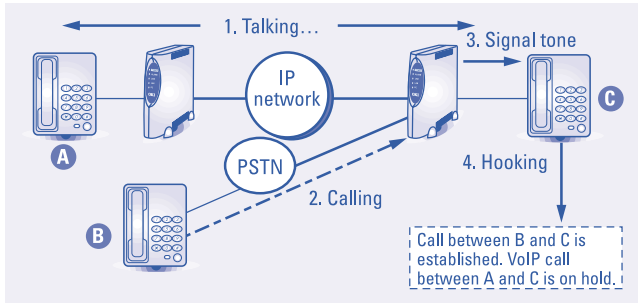

- Response to an incoming call from the IP network during a telephone call using a PSTN line.

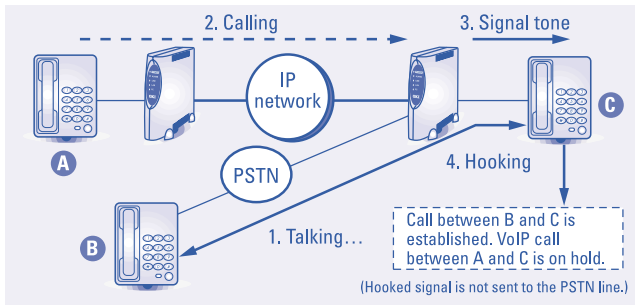

- Incoming operation from the IP network during a telephone call using the IP network.

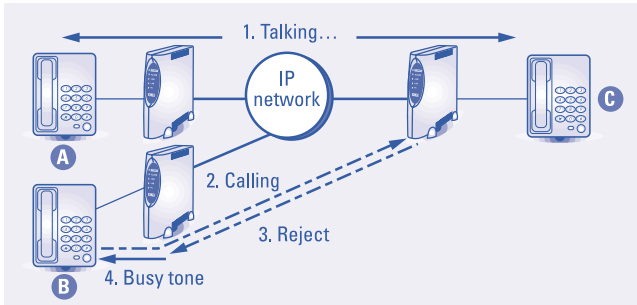

Using the IP network only

Incoming call during an existing telephone call.

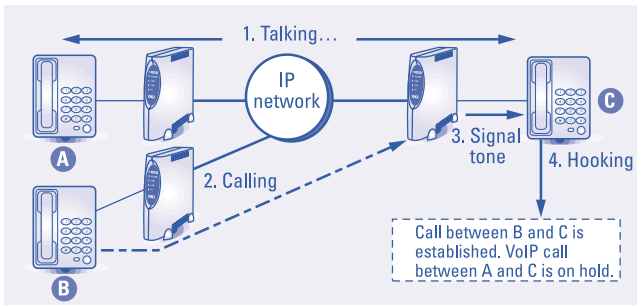

IV

Troubleshooting

If you encounter irregularities with the equipment, please check the following list before making inquiries to authorized sales agents or service offices.

Symptom	Items to check
Unit does not operate.	<ul style="list-style-type: none">• Is the power turned on? Check the <i>POWER</i> lamp to see if it is lit.• Is the power plug inserted into the port correctly?• Is the AC power adapter connected to the power outlet correctly?
The <i>ALARM</i> lamp continues to blink. The unit does not operate.	<ul style="list-style-type: none">• Is the <i>LAN</i> port link established?
No calls can be made.	<ul style="list-style-type: none">• Is the <i>POWER</i> lamp ON and the <i>ALARM</i> lamp OFF?• Is the unit properly connected to the corresponding port?• Is the <i>LAN</i> port link established? Check the <i>LAN</i> lamp to see if it is lit.• Is the dial signal of the telephone set correctly? (<i>TEL</i> port: DTMF signal. Telephone lines vary depending upon the contract with your regional telephone company.)
No calls are received.	<ul style="list-style-type: none">• Is the <i>POWER</i> lamp ON and the <i>ALARM</i> lamp OFF?• Are all the connectors properly connected to the correct ports?• Is the <i>LAN</i> port link established? Check the <i>LAN</i> lamp to see if it is lit.• Is the ringer of the telephone in the ON position?
FAX communication is not available.	<ul style="list-style-type: none">• Is the <i>POWER</i> lamp ON and the <i>ALARM</i> lamp OFF?• Is the facsimile mode a G3?

Dimensions	Approx. 47 (W) x 185 (D) x 155 (H) [mm]
Weight	Approx. 0.42 [kg]
Power dissipation	9 [W] or less
Temperature range	0° C to 40° C

<i>TEL</i> port	Interface	Conventional analogue telephone line
	Selection signal	DTMF signal
	FAX transmission speed	14,400 bps 12,000 bps 9,600 bps 7,200 bps 4,800 bps 2,400 bps
	Number of connectable ports	Only one
<i>LAN</i> port	Interface	10BASE-T/100BASE-TX
<i>PC</i> port	Interface	10BASE-T/100BASE-TX
<i>LINE</i> port	Interface	Conventional analogue PSTN
	Selection signal	DTMF signal
<i>CONSOLE</i> port	Interface	RS232C (19,200 bps)
Call control system	Protocol	TCP/IP
	Procedure	ITU-T recommended H.323 Version 2
Voice real-time transfer system	Protocol	UDP/IP
	Real-time procedure	RTP/RTCP
Voice control	Voice codec protocol	G.711 (μ -law, A-law), G.729A and G.723.1
FAX	Protocol	TCP/IP, UDP/IP
	Real-time procedure	T.38
Data setting	Interface	Local: RS232C Remote: LAN
Number of Tel. No. digits	Max. 32	

Important Equipment Information

The following information relates to the VoIP-TA compliance with radio interference requirements of various countries in which this equipment is sold.

EU Model

VoIP-TA conforms to the following directives:

- Low Voltage Directive: 73/23/EEC
- EMC Directive: 89/336/EEC
- R&TTE Directive: 1999/5/EC (Annex II)

Compliance with these directives implies conformity to the following European norms:

Safety: EN60950: 1992+A1+A2+A3+A4+A11

EMC: EN55024: 1998

EN55022: 1998

EN 61000-3-2: 1995+A1+A2

EN 61000-3-3: 1995

R&TTE: TBR21: 1998

ETSI EG 201 121: v1.1.2

Warranty and Service

Our authorized sales agents or service office will respond to your inquiries and services in a prompt and courteous manner.

Warranty period

In the event of a problem occurring during the warranty period, all necessary repairs and replacements will be done free of charge except in the following circumstances:

- Failure or damage that occurred because the equipment was dropped or handled roughly.
- Failure or damage due to fire, earthquake, storm or flood, lightning or other extraordinary natural event.
- Damage due to moisture or salt intrusion, environmental pollution, or the application of abnormal voltage.
- Failure or damage due to improper operation of the equipment, maintenance, repair, or modification by unauthorized service staff or agents.

Following the warranty period

The cost of replacement parts will be charged after expiry of the warranty period.

Please contact the authorized sales agents or service offices for inquiries regarding service.

Oki Service Offices

Your Local Dealer

Oki Electric Industry Co., Ltd.

Head Office

10-3 Shibaura 4-chome,
Minato-ku, Tokyo 108-8551
JAPAN
Tel: +81-3-5445-6346/6353
Fax: +81-3-5445-6363/6364
URL: <http://www.oki.co.jp>

London Office

Central House, Balfour Road
Hounslow, Middlesex TW3 1HY
U.K.
Tel: +44-208-219-2110
Fax: +44-208-219-2205

Sydney Office

63-85 Victoria Street
Alexandria, NSW 2015,
Australia
Tel: +61-2-9310-5711
Fax: +61-2-9310-4611
URL: <http://www.oki.com.au>

Oki Network Technologies

1101 Cadillac Court
Milpitas, CA 95035
U.S.A.
Tel: +1-408-935-3331
Fax: +1-408-935-3337
URL: <http://www.okint.com>

OKI

Oki Electric Industry Co., Ltd.

3PP3507-4104P002

Free Manuals Download Website

<http://myh66.com>

<http://usermanuals.us>

<http://www.somanuals.com>

<http://www.4manuals.cc>

<http://www.manual-lib.com>

<http://www.404manual.com>

<http://www.luxmanual.com>

<http://aubethermostatmanual.com>

Golf course search by state

<http://golfingnear.com>

Email search by domain

<http://emailbydomain.com>

Auto manuals search

<http://auto.somanuals.com>

TV manuals search

<http://tv.somanuals.com>