

ML 3390/3391

English

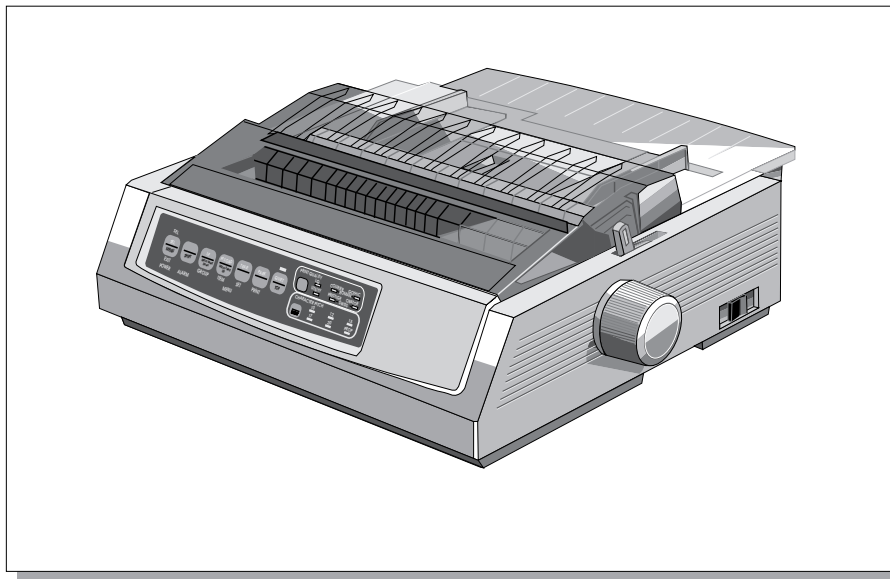

Every effort has been made to ensure that the information in this document is complete, accurate, and up-to-date. Oki assumes no responsibility for the results of errors beyond its control. Oki also cannot guarantee that changes in software and equipment made by other manufacturers and referred to in this guide will not affect the applicability of the information in it. Mention of software products manufactured by other companies does not necessarily constitute endorsement by Oki.

© 1995 by Oki. All rights reserved.

First edition January 1996.

Written and produced by the Documentation Department.

Oki and Microline are registered trademarks of Oki Electric Industry Company, Ltd.

Energy Star is a trademark of the United States Environmental Protection Agency.

Epson is a registered trademark of Epson America, Inc.

IBM is a registered trademark of International Business Machines Corp.

Energy Star



As an Energy Star Partner, Oki has determined that this product meets the Energy Star guidelines for energy efficiency.

Safety

Your printer has been carefully designed to give you years of safe, reliable performance. As with all electrical equipment, there are a few basic precautions you should take to avoid hurting yourself or damaging the printer:

- Read the setup and operating instructions carefully. Be sure to save them for future reference.
- Read and follow all warning and instruction labels on the printer itself.
- Unplug the printer before you clean it. Use only a damp cloth; do not use liquid or aerosol cleaners.
- Place your printer on a firm, solid surface. If you put it on something unsteady, it might fall and be damaged; if you place it on a soft surface, such as a rug, sofa, or bed, the vents may be blocked, causing it to overheat.
- To protect your printer from overheating, make sure no openings on the printer are blocked. Do not put the printer on or near a heat source, such as a radiator or heat register. If you put the printer in any kind of enclosure, make sure it is well ventilated.
- The printhead can get quite hot when it has been printing for a length of time. Do not touch the printhead until it has had a chance to cool off.
- Do not use your printer near water, or spill liquid of any kind into it.
- Be certain that your power source matches the rating listed on the back of the printer. If you are not sure, check with your dealer or with your local power company.
- Your printer has a earthed, 3-pin plug as a safety feature, and it will only fit into a earthed outlet. If you can not plug it in, chances are that you have an older, non-earthed outlet; contact an electrician to have it replaced with a earthed outlet. Do *not* use an adapter to defeat the earthing.
- The outlet into which you plug your printer must remain easily accessible at all times.
- To avoid damaging the power cable, do not put anything on it or place it where it will be walked on. If the cable becomes damaged or frayed, replace it immediately.
- If you are using an extension cable or power strip with the printer, make sure that the total of the amperes required by all the equipment on the extension is less than the extension's

rating. Generally, the total ratings of all equipment plugged into any one power line should not exceed 13 amperes. Do not exceed this unless you know that the power line your equipment is plugged into has a rating above 13 amperes.

- Do not poke anything into the ventilation slots on the sides of the printer; you could get a shock or cause a fire.
- Aside from the routine maintenance described in the manuals, don't try to service the printer yourself; opening the cover may expose you to shocks or other hazards. Do not make any adjustments other than those outlined in the manual, you might cause damage requiring extensive repair work.
- If anything happens that indicates that your printer is not working properly or has been damaged, unplug it immediately and contact your Oki dealer for service. These are some of the things to look for:
 - The power cable or plug is frayed or damaged.
 - Liquid has been spilled into the housing, or the printer has been exposed to water.
 - The printer has been dropped or its cabinet has been damaged.
 - The printer doesn't function normally when you are following the operating instructions.

Contents

Safety	i	Print Mode: Control Panel Keys	12
Maintenance	1	Selecting the Print Quality and Font	13
Replacing the Ribbon Cartridge	1	Selecting the Character Pitch	14
Clearing Paper Jams	2	Menu Mode: Control Panel	14
Rear-Feed Jams	2	Entering and Exiting the Menu Mode	15
Correcting Repetitive Rear-Feed Jams	4	Resetting the Menu	15
Single-Sheet Jams	6	Printing the Menu Settings	15
Cleaning the Housing	7	Summary of Menu Settings	16
Troubleshooting	8	Explanations of Menu Items	19
Using Your Printer	11	Paper Park Feature	22
Print Mode: Indicator Lights	11	Specifications	23
		Index	27

Maintenance

Replacing the Ribbon Cartridge

Note: For the best results, use genuine Oki ribbons.

1. Make sure the printer is turned OFF.
2. Centre the printhead (❶).

Caution! The printhead may be HOT!

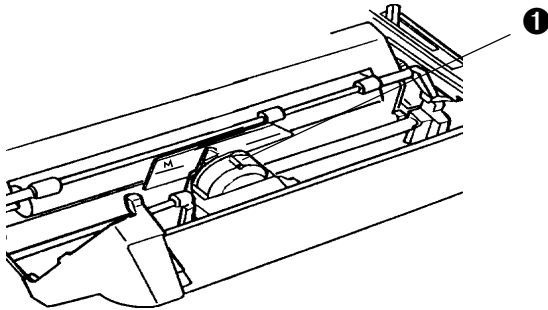

3. Remove and discard the used ribbon cartridge.

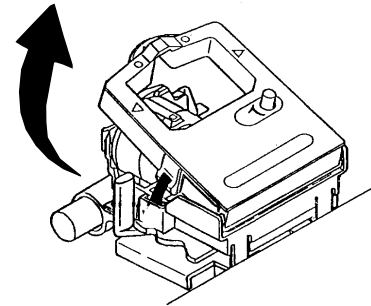

4. Unpack the new ribbon cartridge.

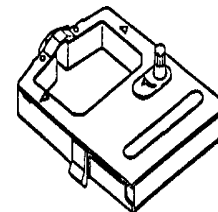

5. Install the new ribbon cartridge.

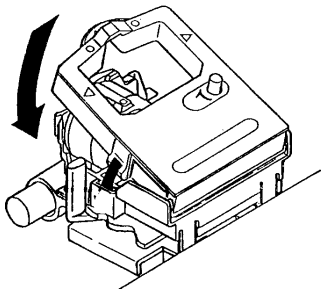

6. Turn the knob (1) in the direction of the arrow to take up any ribbon slack.

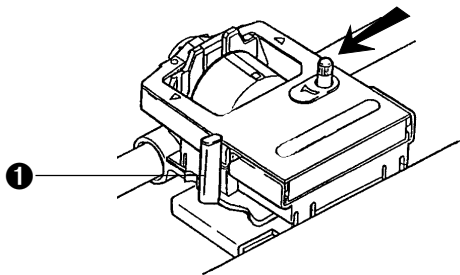

Clearing Paper Jams

Rear-Feed Jams

1. Turn the printer OFF and use the platen knob to back the paper all the way out.

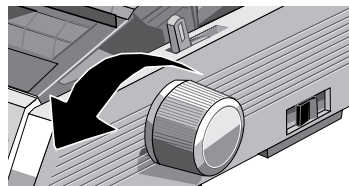

2. Open the access cover, and remove the pull-up roller assembly.

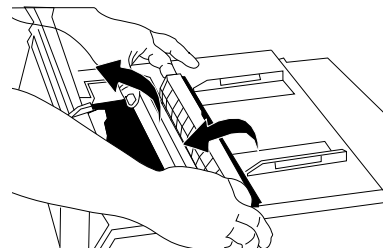

3. Remove any torn pieces of paper.
4. Replace the pull-up roller assembly, and close the access cover.

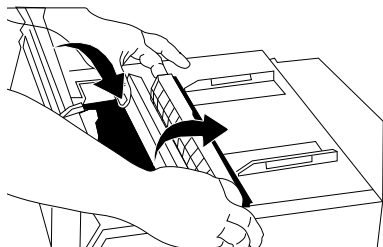

5. Reload paper.

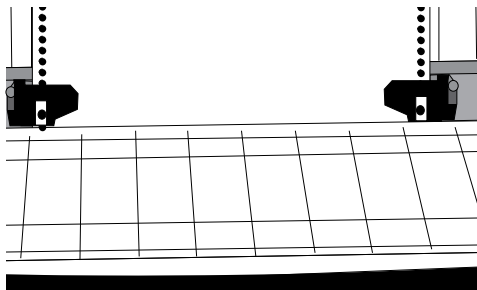

6. Turn the printer on.

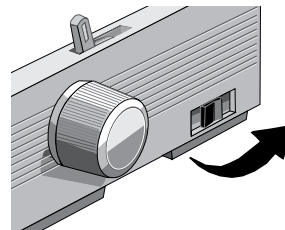

7. Press **FF/LOAD**.



Correcting Repetitive Rear-Feed Jams

If the paper keeps jamming, you probably have bits of paper stuck in the paper path.

1. Perform steps 1 through 3 under “Rear-Feed Jams.”
2. Grasp the paper separator (❶), lift it slightly, pull back on it, then swing it forward.

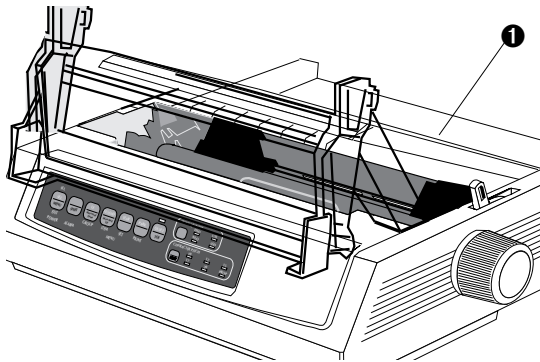

3. Fold some continuous-form paper over three times to make a page four sheets thick, load it on the tractors and close the covers.

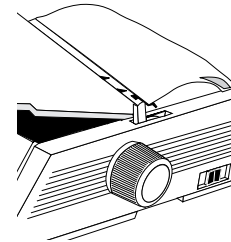

4. Swing the paper separator over, and use the platen knob to draw the quadruple-thick page around the platen: this brings out any jammed bits of paper.

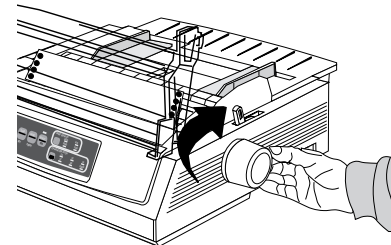

5. Remove the paper pieces, and use the platen knob to back the paper out.
7. Replace the pull-up roller assembly, and close the access cover.

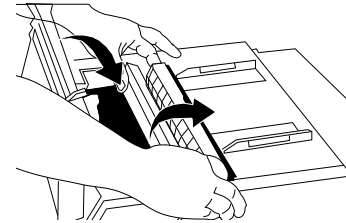
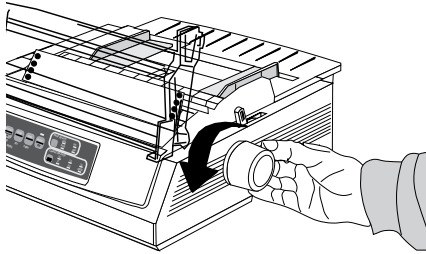

6. Swing the paper separator over, reload regular paper, and lower the paper separator back into place.

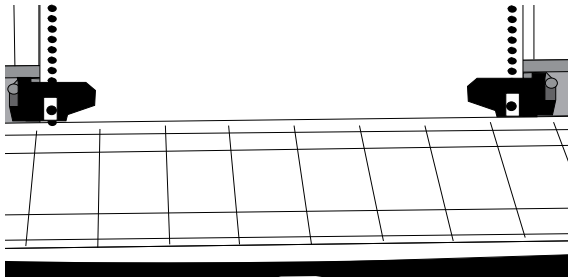

8. Turn the printer on.

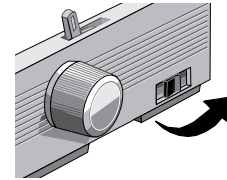

9. Press **FF/LOAD**.



Single-Sheet Jams

1. Turn the printer off.
2. Use the platen knob to back the jammed paper out.

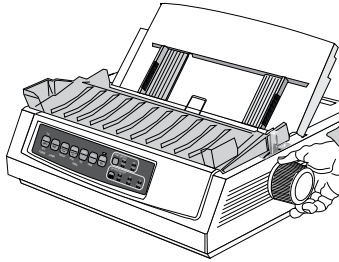

4. Remove any torn pieces from around the carriage.
5. Reinstall the pull-up roller assembly, and close the access cover.

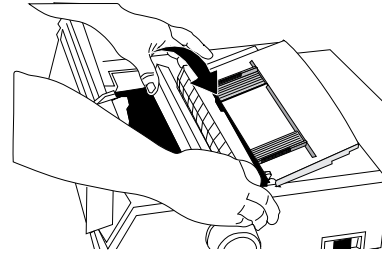

3. Open the access cover and remove the pull-up roller assembly.

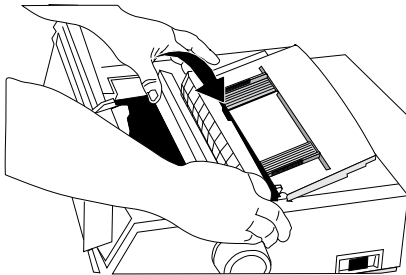

6. Turn the printer on, and reload paper.

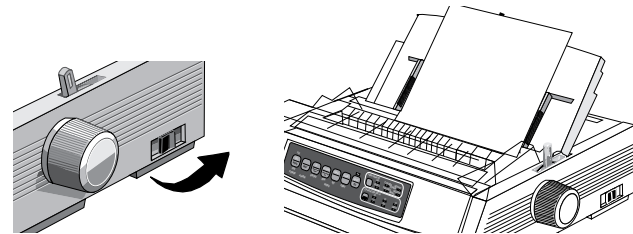

Cleaning the Housing

You should clean the printer every six months (or after about 300 hours of operation).

Note: Never use solvents or strong detergents on the cabinet: they could damage the housing.

1. Turn the printer off, and remove any paper from the path.
2. Open the access cover, remove the pull-up roller assembly.

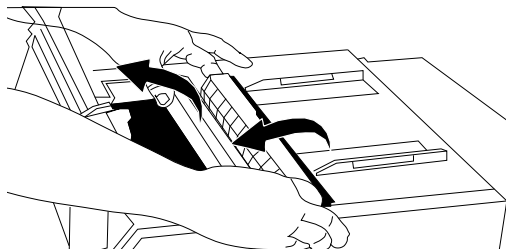

4. Reinstall the pull-up roller assembly, and close the access cover.

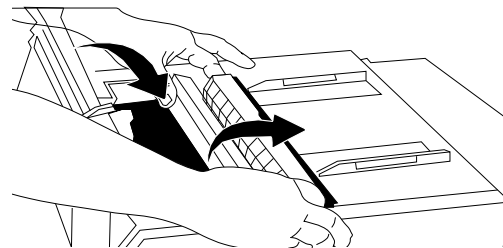

3. Use a clean, dry cloth to dust around the carriage shaft and platen. Remove any loose pieces of paper.

Troubleshooting

Problem: *Nothing happens when I turn on the printer.*

Solution: Check the power cable connection the outlet and to your printer. If you are using a power strip, make sure it is turned on, and that the fuse has not blown nor the circuit breaker tripped.

Problem: *The printer does not print when data is sent.*

- Solutions:**
- (1) Is the SEL light on? If not, press the SEL key.
 - (2) Check that the interface cable is securely connected to both the computer and the printer.
 - (3) If you have the optional serial interface board installed, check to be sure that it is firmly seated in the printer.

Problem: *I'm getting strange symbols, incorrect fonts, etc., when I try to print a document.*

- Solution:**
- (1) Check to be sure that the printer driver you have selected in your software matches the printer emulation. (Press SHIFT and SEL keys, then press GROUP key: this will print a line showing the emulation you have selected.)
 - (2) If you have embedded any printer commands in your software, check to be sure that you entered them correctly.

Problem: *I've installed a new ribbon and the printing is smeared and streaked.*

Solution: The ribbon shield is either loose or missing. Remove the ribbon cartridge and check the clear plastic ribbon shield: if it's loose, secure it in place, if it is missing, find it and reinstall it.

Problem: *The ALARM light is on and the Character Pitch 15 light is flashing.*

Solution: This indicates a paper jam. Press the SEL key and correct the paper jam situation (see “Clearing Paper Jams” in this manual).

Problem: *The ALARM light is on and the Character Pitch 10 light is flashing.*

Solution: This indicates that the paper lever is set at the wrong position for the paper you are trying to use: move it to the proper setting.

Problem: *The ALARM light is blinking.*

Solution: Try turning the printer off and then back on again. If the light still blinks, call for service.

Problem: *The printer needs paper, but the ALARM light is not on and I can't load the paper.*

Solution: Press and release the SEL key, then hold the SHIFT key and press the RESET (CHARACTER PITCH) key: this resets the printer.

Problem: *My word processor files don't print the way I have the menu and front panel set.*

Solution: Before sending a file to the printer, many word processors send either an “initialization string” or an I-Prime signal to the printer.

The initialization string contains codes that override the panel and menu settings. To change your printer to ignore the reset code, enter the Menu Mode, go down to the Set-Up group and change the setting for Reset Inhibit to Yes (see “Changing the Menu Settings” in this manual).

The I-Prime signal will automatically override any front panel settings you have made. To eliminate this problem, enter the Menu Mode, go down to the Parallel Interface group and change the setting for I Prime to Invalid (see “Changing the Menu Settings” in this manual).

Problem: *The Print Quality and Character Pitch keys on the front panel won't work.*

Solution: The Operator Panel Function in the printer menu can be used to disable these buttons. If the printer is part of a customized system or if it is used by a number of people, the system manager may have used this option to make sure the printer is always set properly.

Problem: *Continuous-form paper is sticking to the paper separator.*

Solution: In cold dry weather, static charges can build up and make the paper cling to the paper separator. Try moving the paper guides together so that the paper rests on the guides rather than on the separator.

Problem: *Ink smears on paper.*

Solution: This may be caused by excessive printhead travel from the centring position when printing narrow columns. Set Centring Position to MODE 1. On ML3391 also try MODE 2. (See Menu Mode).

Using Your Printer

Print Mode: Indicator Lights

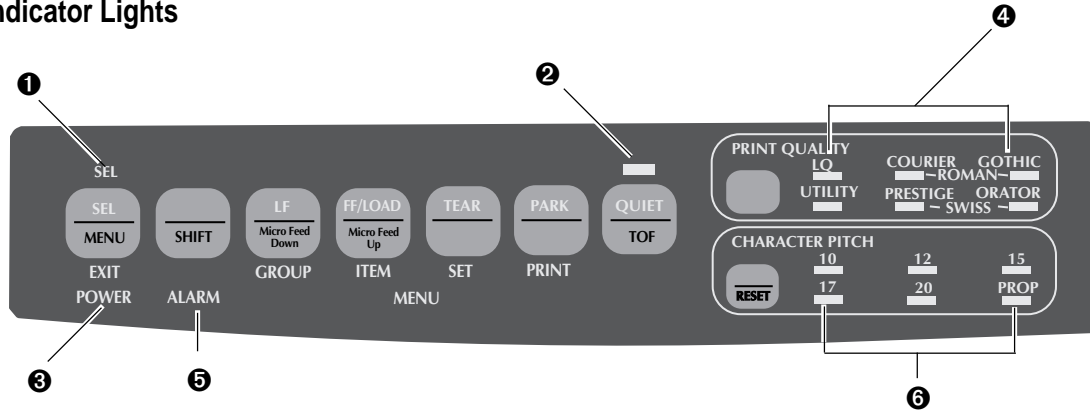

❶ SEL Glows = printer selected, ready to receive data
Flashes = printer in Print Suppress Mode
Not lit = printer deselected (can't receive data)

❷ QUIET Glows = printer in Quiet state.

❸ POWER Glows = printer turned on.

❹ PRINT QUALITY Indicate print quality and font selected.

❺ ALARM ... Glows = error condition exists:

- *out of paper* if no other lights are blinking
- *paper jam* if 15 cpi light is also blinking
- *paper lever is set to wrong position* if 10 cpi light is also blinking.

Blinks = error condition. Turn printer off, then on; if the light still flashes, contact your service dealer.

❻ 10/12/15/17/20/PROP Indicate character pitch selected.

Print Mode: Control Panel Keys

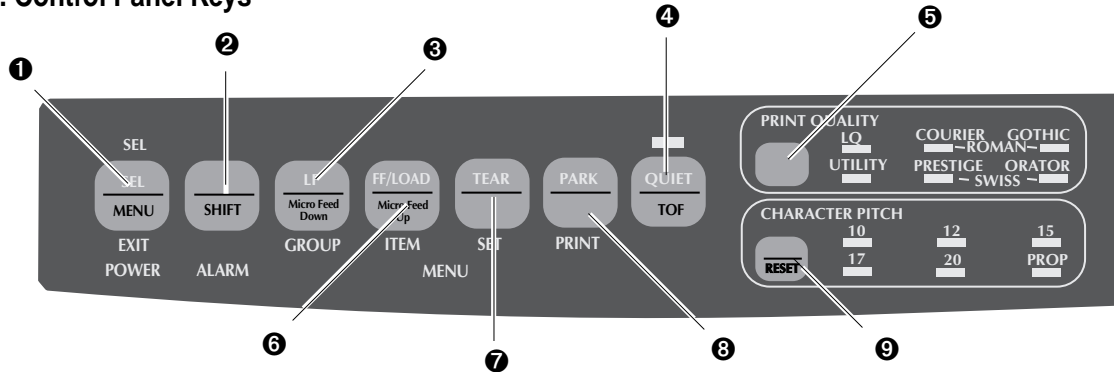

- 1 SEL** Selects/deselects printer. When held on power up, engages the Menu Mode.
- 2 SHIFT** Press and hold while pressing another switch to engage the alternate function for that switch (e.g. “Micro Feed Down” for the LF key).
- 3 LF** Moves paper up one line: press and hold for repetitive line feeds. When held on power up, activates the Font Test.
- 4 QUIET** Turns Quiet Mode on and off. When held on power up, activates the Rolling ASCII Test.
- 5 PRINT QUALITY** Selects the print quality and font.
- 6 FF/LOAD** Loads/ejects single sheet of paper; moves continuous-form paper to print position.
- 7 TEAR** Moves continuous-form paper up for tear-off or back down for printing.
- 8 PARK** Retracts continuous-form paper from the path.
- 9 CHARACTER PITCH** Selects the character pitch. Used with the SHIFT key to reset the printer.

Selecting the Print Quality and Font

Important! Front panel settings for print quality and character pitch can be overridden by software commands. The lights will always reflect the printer's state.

When Letter Quality is engaged, the lights indicate which font is selected:



Press **PRINT QUALITY** to select:

LQ: Letter Quality

- Highest quality, slowest speed
- Seven fonts
- Recommended for correspondence

UTILITY:

- Medium quality, medium speed
- Gothic font only
- Recommended for internal documents and high-volume data.

*Note: To select High Speed Draft mode, set the Print Quality to **UTILITY** and the Character Pitch to 15.*

- **Courier:** LQ and Courier lights on
- **Gothic:** LQ and Gothic lights on
- **Orator:** LQ and Orator lights on
- **Prestige:** LQ and Prestige lights on
- **Roman:** LQ, Courier and Gothic lights on
- **Swiss:** LQ, Orator and Prestige lights on
- **Swiss Bold:** LQ light on

Selecting the Character Pitch

Press **CHARACTER PITCH** to select the width of characters in characters per inch:

10 cpi

- Recommended for standard text.

12 cpi

- Yields more text per page.
- Recommended for standard text.

15 cpi

- In HSD mode, yields fastest printing.
- Recommended for large volumes of data.

17.1 cpi, 20 cpi

- Smallest print
- Recommended for spreadsheets.

PROP

- Proportional spacing
- Recommended for documents where you want a more polished appearance.
- Not available for High Speed Draft.

Menu Mode: Control Panel

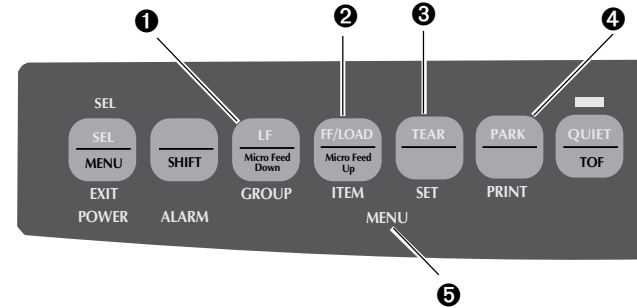

- 1 GROUP key** ..Prints the next Group in the Menu. With the SHIFT key, prints the previous Group.
- 2 ITEM key** Prints the next Item in the Group. With the SHIFT key, prints the previous Item in the Group.
- 3 SET key** Prints the next Setting for an Item. With the SHIFT key, prints the previous Setting for an Item.
- 4 PRINT key** ... Prints a copy of all the Menu settings. With the SHIFT key, prints the current settings for the Group selected.
- 5 MENU light** ..Glows when the printer is in the Menu Mode.

Entering and Exiting the Menu Mode

To enter or exit the Menu Mode, hold **SHIFT** while pressing **SEL**.

Resetting the Menu

To reset the Menu to the standard settings:

1. Turn the printer off.
2. Press **SEL** + **LF** while turning the printer on.

Printing the Menu Settings

1. Make sure paper is loaded in the printer.
2. Enter the Menu Mode (**SHIFT** + **SEL**).
3. Press **PRINT** (PARK).

*Note: To print out a listing of the settings for all menu items, regardless of the emulation selected or the accessories installed, enter the Menu Mode, then press **SHIFT** + **PRINT QUALITY**.*

Changing the Menu Settings

1. Press **SHIFT** + **SEL** to enter the Menu Mode.
2. Use the **GROUP**, **ITEM** and **SET** keys to make your changes:
 - ▶ Press **GROUP** successively until the Group you wish to change appears in the first column.
 - ▶ Press **ITEM** until the Item you wish to change appears in the second column.
 - ▶ Press **SET** until the setting you want appears in the third column.
3. Press **SHIFT** + **SEL** to exit the Menu Mode and save your settings.

Important! If you turn the printer off without first exiting the Menu Mode, the changes you have made will be lost.

Summary of Menu Settings

The table below shows the items which may appear in the menu. Settings which are engaged at the factory (defaults) are set in ***bold italic***. Some groups or entries will only appear when a specific emulation is engaged, as noted.

<i>Group</i>	<i>Item</i>	<i>Setting</i>
Printer Control	Emulation Mode	<i>EPSON LQ</i> , IBM PPR, IBM AGM
Font	Print Mode	<i>LQ Courier</i> , LQ Roman, LQ Swiss, LQ Swiss Bold, LQ Orator, LQ Gothic, LQ Prestige, Utility
	Pitch	<i>10 cpi</i> , 12 cpi, 15 cpi, 17.1 cpi, 20 cpi
	Proportional Spacing	<i>No</i> , Yes
	Style	<i>Normal</i> , Italics
	Size	<i>Single</i> , Double
Symbol Sets	Character Set	Set I, <i>Set II</i>
	Language Set	<i>ASCII</i> , French, German, British, Danish I, Swedish I, Italian, Spanish I, Japanese, Norwegian, Danish II, Spanish II, Latin American, French Canadian, Dutch, Swedish II, Swedish III, Swedish IV, Turkish, Swiss I, Swiss II, Publisher
	Zero Character	Slashed, <i>Unslashed</i>
	Code Page	<i>USA</i> , Serbo Croatian II, Canada French, ECMA-94, Multilingual, Windows East Europe, Portugal, Windows Greek, Norway, Latin 5 (Windows Turkey), Baltic 774, Windows Cyrillic, East Europe Latin II-852, Cyrillic I-855, Hungarian CWI, Turkey 857, Ukrainian, Cyrillic II-866, ISO Latin 6, Greek_869, Hebrew NC (862), Kamenicky (MJK), Hebrew OC, Greek_437, Windows Hebrew, Greek_437 CYPRUS, Windows Baltic, Turkey, Bulgarian, Polska Mazovia, Greek_928, ISO Latin 2, Serbo Croatian I
	Slashed Letter O	<i>No</i> , Yes

<i>Group</i>	<i>Item</i>	<i>Settings</i>
Rear Feed	Line Spacing Form Tear-Off Skip Over Perforation Page Width (ML 3391 only) Page Length	6 LPI , 8 LPI Off , 500 mS, 1 sec, 2 sec No , Yes 13.6" , 8" 11", 11-2/3", 12" , 14", 17", 3", 3.5", 4", 5.5", 6", 7", 8", 8.5"
Bottom Feed	Line Spacing Form Tear-Off Skip Over Perforation Page Width (ML 3391 only) Page Length	6 LPI , 8 LPI Off , 500 mS, 1 sec, 2 sec No , Yes 13.6" , 8" 11", 11-2/3", 12" , 14", 17", 3", 3.5", 4", 5.5", 6", 7", 8", 8.5"
Top Feed	Line Spacing Bottom Margin Page Width (ML 3391 only) Page Length Wait Time Page Length Control	6 LPI , 8 LPI Valid , Invalid 13.6" , 8" 11", 11-2/3" , 12", 14", 16.57", 3", 3.5", 4", 5.5", 6", 7", 8", 8.5" 500 mS, 1 sec , 2 sec by MENU Setting , by Actual Page Length
Set-Up	Graphics Receive Buffer Size Paper Out Override Print Registration	Bidirectional, Unidirectional 23K, 1 Line, 8K No , Yes 0.25 mm Right, 0.20 mm Right, 0.15 mm Right, 0.10 mm Right, 0.05 mm Right, 0 , 0.05 mm Left, 0.10 mm Left, 0.15 mm Left, 0.20 mm Left, 0.25 mm Left

<i>Group</i>	<i>Item</i>	<i>Settings</i>
Set-Up (continued)	Operator Panel Function	Full Operation , Limited Operation
	Reset Inhibit	No , Yes
	Print Suppress Effective	Yes , No
	Auto LF	No , Yes
	Auto CR*	No , Yes
	SI Select Pitch (10 cpi)*	17.1 cpi , 15 cpi
	SI Select Pitch (12 cpi)*	20 cpi, 12 cpi
	Time Out Print	Valid , Invalid
	Auto Select	No , Yes
	Graphics Speed	Low , High
	Centring Position	DEFAULT , MODE1, MODE2**
Parallel I/F	I-Prime	Buffer Print , Invalid, Buffer Clear
	Pin 18	+5V, Open
	Auto Feed XT***	Invalid , Valid

* Appears only when the IBM emulation is selected.

** ML3391 only.

*** Applies only when the Epson emulation is selected.

Explanations of Menu Items

Auto CR (IBM). If you want the printer to automatically add a carriage return when a Line Feed is received at the end of a line, change the setting to Yes.

Auto LF. If your printout is consistently double spaced, select No; if it overprints, select Yes.

Auto Feed XT (Epson). If your system uses pin 14 of the parallel interface to control automatic line feed, change the setting to Valid.

Auto Select. If you always use the same Top of Form position, change the setting to Yes.

Bottom Margin. Change to Invalid if you want the printer to ignore the bottom margin setting. *Caution! This can cause loss of data and damage the printhead.*

Centring Position. Choose DEFAULT, Mode 1 or Mode 2.

Character Set. Choose IBM Set I or IBM Set II.

Code Page. Choose the Code Page character set you wish to use.

Emulation Mode. Choose the printer emulation.

Form Tear-Off. Choose 500 mS, 1 sec, or 2 sec to turn the Form Tear-Off feature on and to set the time interval for the printer to wait before advancing the paper.

Graphics. Change to bidirectional graphics for faster printing; optimise the registration using the Print Registration menu item.

I-Prime. Determines what the printer will do when it receives the I-Prime signal from the host: Buffer Print prints out the buffer contents before resetting; Buffer Clear dumps the buffer contents immediately. Invalid causes the printer to ignore the I-Prime signal.

Language Set. Replaces certain standard symbols with special characters used in foreign languages.

Line Spacing. Change to 8 lpi to get more lines on a page.

Operator Panel Function. Change to Limited Operation to deactivate the PRINT QUALITY and CHARACTER PITCH buttons. This prevents these from being changed via the control panel when several people are using the printer.

Page Length. Set this to match the length of the paper you are using.

Page Length Control. Change the setting to “by Actual Page Length” if you wish to print on single-sheet pages. When “by Actual Page Length” is selected, the printer will print no closer than 1" from the edge of the paper. When “by Menu Setting” is selected, the printer will print to the length you have chosen.

Page Width (ML 3391 only). Change to 8" to print on letter-size paper.

Paper Out Override. Senses when less than 1" (25 mm) of paper remains, and stops printing. Change to Yes to override the sensor. *Caution! This can cause loss of data and damage the printhead!*

Pin 18. Sets the signal on pin 18 to +5 volts or to open.

Pitch. Choose the character width, in character per inch (cpi).

Print Mode. Choose the quality and font for printing.

Print Registration. Change the setting as required to obtain the best registration for bidirectional printing.

Print Suppress Effective. If your system uses the DC1 and DC3 codes for something other than the print suppress mode, change the setting to No.

Proportional Spacing. Change the setting to Yes to engage proportional spacing of characters.

Receive Buffer Size. Sets the amount of memory for holding received data. Choosing 1 Line will tie up your computer while printing, but the printer stops much sooner if you abort the job.

Reset Inhibit. Select Yes to prevent your software from resetting your printer's settings.

SI Select Pitch, 10 cpi (IBM). Sets the pitch to be engaged when the printer control panel is set for 10 cpi and the SI command is received.

SI Select Pitch, 12 cpi (IBM). Sets the pitch to be engaged when the printer control panel is set for 12 cpi and the SI command is received.

Size. Change to Double for double width and height printing.

Skip Over Perforation. Change to Yes if you want the printer to go to the next page when it comes within 1" (25 mm) of the bottom of the page. Keep it set to No if your software has its own page formatting controls.

Slashed Letter O. If set to Yes, capital and lower case slashed O (Ø and ø) will appear at locations 9Bh and 9Dh respectively in USA code page. If set to No, the characters “ç” and “ÿ” will appear at these locations.

Style. Change to italics if you want the printed characters to be slanted.

Time Out Print. If your software spends a long time processing between portions of data it feeds to the printer, change the setting to Invalid to keep your printer from inadvertently dumping the received data while it is waiting for more.

Wait Time. Sets the amount of time the printer will wait for more data before moving to the form tear-off position.

Zero Character. If you do not want the printer to use a slash to distinguish the number zero from the capital letter O, change the setting to Unslashed.

Using the Printer's Features

Tear Feature

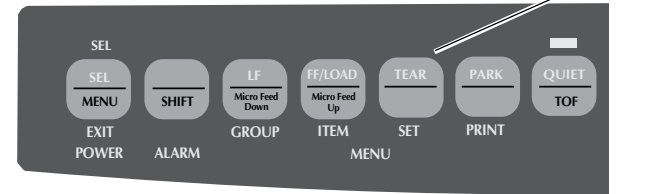

Use this feature to advance continuous-form paper up to the tear position by simply pressing **TEAR** (❶).

Note: The Tear Feature can not be used when the optional pull tractor is engaged.

Forms Tear-Off Feature

Important! Never engage Forms Tear-Off when printing on labels!

The Forms Tear-Off feature automatically moves continuous-form paper up to the tear position after the interval you select, then moves it back down again for printing when the printer receives more data.

This feature is normally turned off. To activate it:

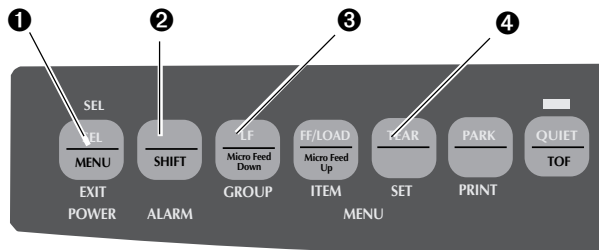

1. Press **SHIFT** (②) + **SEL** (①).
2. Press **GROUP** (③) until one of the following lines appears, depending on which paper feed you are using:

REAR FEED	Form Tear-Off	OFF
BOTTOM FEED	Form Tear-OFF	OFF

3. Press **SET** (④) consecutively until the time interval you wish to select appears in the third column.
4. Press **SHIFT** (②) + **SEL** (①) to exit Menu Mode and save the setting.

Note: Some programs pause occasionally while sending data. If the pause is too long, the paper will advance to the tear-off position until more data is received. This extra paper movement can cause uneven print registration in graphics. If you have this problem, use the menu to turn off this feature.

Paper Park Feature

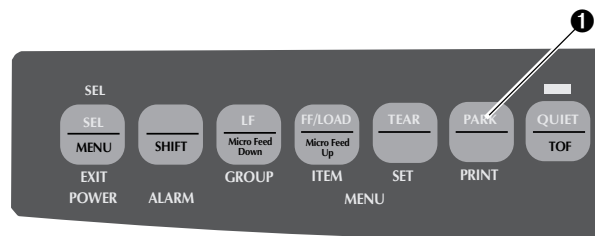

To retract rear-feed paper from the paper path, press **PARK** (①).

Specifications

Print Method Impact dot matrix

Printhead 24 pins, 0.20 mm diameter, thermal protection

Print Speed

<i>Mode</i>	<i>Pitch, Characters per Inch</i>	<i>Speed, Characters per Second</i>
High Speed Draft	15 cpi	390 cps
Utility	10 cpi 12 cpi 17.1 cpi 20 cpi	260 cps 312 cps 223 cps 260 cps
Letter Quality	10 cpi 12 cpi 15 cpi 17.1 cpi 20 cpi	87 cps 104 cps 130 cps 149 cps 174 cps

Characters per Line (CPL)

<i>Setting</i>	<i>ML 3390</i>	<i>ML 3391</i>
10 cpi	80 cpl	136 cpl
12 cpi	96 cpl	163 cpl
15 cpi	120 cpl	204 cpl
17.1 cpi	137 cpl	233 cpl
20 cpi	160 cpl	272 cpl

Emulations Epson LQ, IBM Proprinter, IBM AGM co-resident

Interface Standard: Centronics parallel
Optional: RS-232C serial

Graphics Resolution 360 x 360 dpi maximum

Receive Buffer Size 23K

DLL RAM 15K maximum (Epson emulation only)

Print Modes

<i>Mode</i>	<i>Character Pitch</i>
Letter Quality	10, 12, 15, 17.1, or 20 cpi, or Proportional
Utility	10, 12, 17.1 or 20 cpi, or Proportional
High Speed Draft	15 cpi

Bar Codes Code 39, UPC A, UPC E, EAN 8, EAN 13, Interleaved 2 of 5, Code 128, Postnet

Scalable Fonts Courier, Roman and Swiss, sizes 8 to 64 points

Resident Fonts

<i>Mode/Font</i>	<i>Size</i>
LQ Courier	10 cpi, 12 cpi, Superscript/subscript
LQ Roman	10 cpi, 12 cpi, Superscript/subscript
LQ Swiss	10 cpi, 12 cpi, Superscript/subscript
LQ Prestige	10, cpi, 12 cpi
LQ Orator	10, cpi, 12 cpi
LQ Letter Gothic	10 cpi, 12 cpi
LQ Swiss Bold	10, cpi, 12 cpi
Utility Gothic	10, cpi, 12 cpi, Superscript/subscript
HSD Gothic	15 cpi

Reliability

<i>Parameter</i>	<i>Reliability</i>
Mean Time Between Failures (MTBF)	10,000 hours at 25% duty cycle and 35% page density
Mean Time to Repair (MTTR)	15 minutes
Printhead Life	200 million characters average in 10 cpi draft mode at 25% duty and 35% page density
Ribbon Life (on average, 10 cpi utility)	2 million characters

Paper Width

Minimum: 3"
 Maximum, ML 3390: 10"
 Maximum, ML 3391: 16"

Paper Weight

45 to 90 g/m² (12 to 24 lb.)

Paper Thickness

Rear Feed: 0.36mm (0.014") max.
 Bottom Feed: 0.44mm (0.017") max.

Paper Specifications

<i>Paper Type</i>	<i>Feed</i>	<i>Weight</i>	<i>Width Range*</i>
Cut sheets	Top Only	58 - 90 g/m ² (14-24 lb.)	ML3390: 182.9 - 215.9mm (7.2" - 8.5") ML3391: 182.9 - 363.2mm (7.2 to 14.3")
Single-part continuous forms	Rear, Bottom	45 - 90 g/m ² (12-24 lb.)	ML3390: 76.2 - 254mm (3-10") ML3391: 76.2 - 406.4mm (3-16")
Carbonless continuous forms	Rear, Bottom	34 - 41 g/m ² (9-11 lb.)	ML3390: 76.2 - 254mm (3-10") ML3391: 76.2 - 406.4mm (3-16")
Interleaf continuous forms	Rear, Bottom	38 - 45 g/m ² (10-12 lb.) Carbon 34g/m ² (9 lb.)	ML3390: 76.2 - 254mm (3-10") ML3391: 76.2 - 406.4mm (3-16")
Labels	Bottom Only		ML3390: 76.2 - 254mm (3-10") ML3391: 76.2 - 406.4mm (3-16")

Paper Specifications *(continued)*

<i>Paper Type</i>	<i>Feed</i>	<i>Weight</i>	<i>Width Range*</i>
Envelopes, single feed	Top Only	90 g/m ² max. (24 lb.)	165.1 - 241.3mm (6.5" to 9.5")
Envelopes, continuous feed, non-overlap	Bottom Only	90 g/m ² max. (24 lb.)	165.1 - 241.3mm (6.5" to 9.5")
Card stock	Bottom Only	178 g/m ² max. (48 lb.)	N.A.
Transparencies	Top Only	—	215.9 - 279.4mm (8.5" x 11")

Dimensions (W x D x H)

ML 3390: 15.7 x 13.6 x 4.6 inches
(398 x 345 x 116 mm)

ML 3391: 16.9 x 13.6 x 4.6 inches
(430 x 345 x 116 mm)

Weight

ML 3390: TBD
ML 3391: TBD

Environmental Requirements

<i>Parameter</i>	<i>Range</i>
Operating Temperature	5 to 40°C
Storage Temperature	-10 to +50°C)
Operating Humidity	20 to 80% RH (max. wet bulb temp. 30°C)
Storage Humidity	5 to 95% RH (max. wet bulb temp. 40°C)

Electrical Requirements 230/240 volts ac (+10%, -14%),
50/60 Hz (±2%)

This product complies with the requirements of the Council Directive 89/336/EEC on the approximation of the laws of the member states relating to electromagnetic compatibility.

Specifications subject to change without notice.

Index

- A**
- Alarm light
 - troubleshooting 9
 - Auto
 - CR menu setting 19
 - feed XT menu setting ... 19
 - LF menu setting 19
 - select menu setting 19
- B**
- Bar codes 24
 - Bottom margin menu
 - setting 19
- C**
- Card stock specifications .. 26
 - Centring position menu setting
 - 19
 - Character pitch 14
 - Characters per line 23
 - Character set menu
 - setting 19
 - Code page menu setting 19
- Continuous-form paper**
- jams, clearing 2-5
 - specifications 24
- Control panel** 11-14
- Cut sheet specifications** 25
- D**
- Defaults, menu 116-18
 - resetting 15
 - Decollator menu
 - setting 19
 - Dimensions 25
 - DLL RAM 23
- E**
- Electrical requirements 26
 - Emulation mode menu
 - setting 19
 - Emulations 23
 - Envelope specifications 26
 - Environmental
 - requirements 26
- F**
- Factory settings, menu . 16-18
 - Fonts 13, 24
 - Form tear-off feature 21
 - menu setting 19
 - Front panel 11-14
- G**
- Graphics menu setting 19
 - Graphics resolution 23
- H**
- High speed draft 13, 24
 - Housing, cleaning 7
 - Humidity requirements 26
- I**
- Indicator lights 11, 13, 14
 - Interface 23
 - I-Prime menu setting 19
- J**
- Jams, paper 2-6
- K**
- Keys
 - menu mode 14
 - print mode 12
- L**
- Label specifications 25
 - Language set menu
 - setting 19
 - Letter quality fonts 13, 24
 - Lights, control
 - panel 11, 13, 14
 - Line spacing menu
 - setting 19
- M**
- Maintenance 1-7
 - Menu
 - items 19-21
 - mode 14-14
 - settings 16-18

O			
Operator panel function			
menu setting	20		
P			
Page length menu setting ..	20		
Page length control menu			
setting	20		
Page width menu setting ...	20		
Panel, front	11-14		
Paper			
jams, clearing	2-6		
specifications	23		
Paper out override menu			
setting	20		
Paper park feature	22		
Pin 18 menu setting	20		
Pitch menu setting	20		
Print mode	11-14		
menu setting	20		
Print modes	24		
Print quality	13		
Print registration menu			
setting	20		
Print speed	23		
		Print suppress effective	
		menu setting	20
		Printhead specifications	23
		Problem solving	8-10
		Proportional spacing	
		menu setting	20
	R		
	Rear feed paper		
	jams	2-5	
	Receive buffer size	20, 23	
	Reliability	25	
	Repetitive paper jams	4-5	
	Reset inhibit menu		
	setting	20	
	Resident fonts	24	
	Ribbon replacement	1-2	
	S		
	Scalable fonts	24	
	SI select pitch menu		
	settings	20	
	Single sheet paper jams,		
	clearing	6	
	Size menu setting	20	
		Skip over perforation	
		menu setting	21
		Slashed letter 'O'	21
		Specifications	23-26
		Storage	
		humidity	26
		temperature	26
		Style menu setting	21
	T		
	Tear feature	21	
	Tear-off feature	21	
	Temperature		
	requirements	26	
	Time out print menu		
	setting	21	
	Transparency		
	specifications	26	
	Troubleshooting	8-10	
	U		
	Utility mode	13, 24	
	V		
	Voltage requirements	26	
	W		
	Wait time menu setting	21	
	Weight	26	
	Z		
	Zero character menu		
	setting	21	

Oki Systems Company

Oki Systems (UK) Limited

550 Dundee Road
Slough Trading Estate
Slough
Berks. SL1 4LE

Tel: 01753-819819
Fax: 01753-819899

Free Manuals Download Website

<http://myh66.com>

<http://usermanuals.us>

<http://www.somanuals.com>

<http://www.4manuals.cc>

<http://www.manual-lib.com>

<http://www.404manual.com>

<http://www.luxmanual.com>

<http://aubethermostatmanual.com>

Golf course search by state

<http://golfingnear.com>

Email search by domain

<http://emailbydomain.com>

Auto manuals search

<http://auto.somanuals.com>

TV manuals search

<http://tv.somanuals.com>