

ML 3320/3321

English

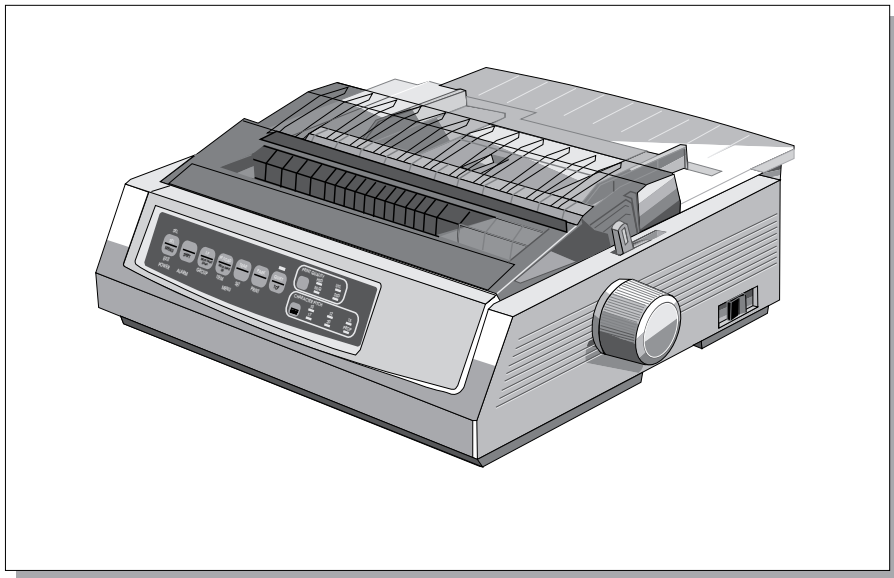

Every effort has been made to ensure that the information in this document is complete, accurate, and up-to-date. Oki assumes no responsibility for the results of errors beyond its control. Oki also cannot guarantee that changes in software and equipment made by other manufacturers and referred to in this guide will not affect the applicability of the information in it. Mention of software products manufactured by other companies does not necessarily constitute endorsement by Oki.

© 1996 by Oki. All rights reserved.

First edition March 1996.

Written and produced by the Documentation Department.

Oki and Microline are registered trademarks of Oki Electric Industry Company, Ltd.

Energy Star is a trademark of the United States Environmental Protection Agency.

Epson is a registered trademark of Epson America, Inc.

IBM is a registered trademark of International Business Machines Corp.

Energy Star



As an Energy Star Partner, Oki has determined that this product meets the Energy Star guidelines for energy efficiency.

Safety

Your Oki printer has been carefully designed to give you years of safe, reliable performance. As with all electrical equipment, there are a few basic precautions you should take to avoid hurting yourself or damaging the printer:

- Read the setup and operating instructions in this manual carefully. Be sure to save it for future reference.
- Read and follow all warning and instruction labels on the printer itself.
- Unplug the printer before you clean it. Use only a damp cloth; do not use liquid or aerosol cleaners.
- Place your printer on a firm, solid surface. If you put in on something unsteady, it might fall and be damaged; if you place it on a soft surface, such as a rug, sofa, or bed, the vents may be blocked, causing it to overheat.
- To protect your printer from overheating, make sure no openings on the printer are blocked. Do not put the printer on or near a heat source, such as a radiator or heat register. If you put the printer in any kind of enclosure, make sure it is well ventilated.
- The printhead can get quite hot when it has been printing for a length of time. Do not touch the printhead until it has had a chance to cool off.
- Do not use your printer near water, or spill liquid of any kind into it.
- Be certain that your power source matches the rating listed on the back of the printer. If you are not sure, check with your dealer or with your local power company.
- Your printer has an earthed, 3-pin plug as a safety feature, and it will only fit into an earthed outlet. If you can not plug it in, chances are that you have an older, non-earthed outlet; contact an electrician to have it replaced with an earthed outlet. Do *not* use an adapter to defeat the earthing.
- The outlet into which you plug your printer must remain easily accessible at all times.
- To avoid damaging the power cable, do not put anything on it or place it where it will be walked on. If the cable becomes damaged or frayed, replace it immediately.
- If you are using an extension cable or power strip with the printer, make sure that the total of the amperes required by all the equipment on the extension is less than the extension's rating. Generally, the total ratings of all equipment plugged into any one power line should not exceed 15 amperes. Don't exceed this unless you know that the power line your equipment is plugged into has a rating above 15 amperes.

- Do not poke anything into the ventilation slots on the sides of the printer; you could get a shock or cause a fire.
- Aside from the routine maintenance described in this handbook, do not try to service the printer yourself; opening the cover may expose you to shocks or other hazards. Do not make any adjustments other than those outlined in the handbook, you might cause damage requiring extensive repair work.
- If anything happens that indicates that your printer is not working properly or has been damaged, unplug it immediately and contact your dealer. These are some of the things to look for:
 - The power cable or plug is frayed or damaged.
 - Liquid has been spilled into the housing, or the printer has been exposed to water.
 - The printer has been dropped or its cabinet has been damaged.
 - The printer does not function normally when you are following the operating instructions.

Contents

Safety	i	Menu Mode: Control Panel	14
Maintenance	1	Entering and Exiting the Menu Mode	15
Replacing the Ribbon Cartridge	1	Resetting the Menu	15
Clearing Paper Jams	2	Printing the Menu Settings	15
Rear-Feed Jams	2	Changing the Menu Settings	15
Correcting Repetitive Rear-Feed Jams	4	Summary of Menu Settings	16
Single-Sheet Jams	6	Explanations of Menu Items	19
Cleaning the Housing	7	Using the Printer's Features	21
Troubleshooting	8	Tear Feature	21
Using Your Printer	11	Forms Tear-Off Feature	21
Print Mode: Indicator Lights	11	Paper Park Feature	22
Print Mode: Control Panel Keys	12	Specifications	23
Selecting the Print Quality	13	Index	26
Selecting the Character Pitch	14		

Maintenance

Replacing the Ribbon Cartridge

Note: For the best results, use genuine Oki ribbons.

1. Make sure the printer is turned OFF.
2. Centre the printhead (❶).

Caution! The printhead may be HOT!

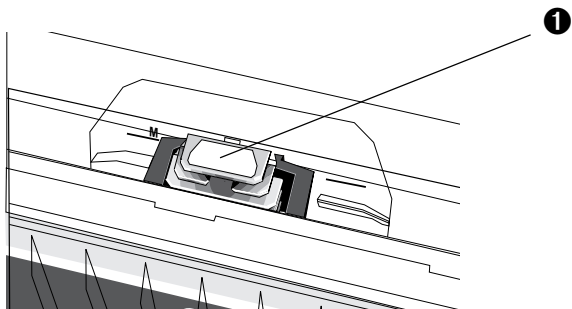

3. Remove and discard the used ribbon cartridge.

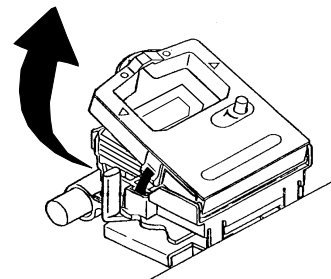

4. Unpack the new ribbon cartridge.

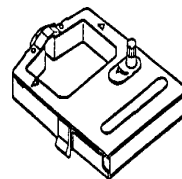

5. Install the new ribbon cartridge.

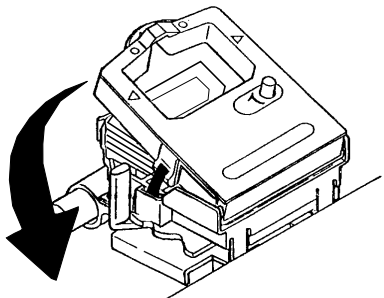

6. Turn the knob (1) in the direction of the arrow to take up any ribbon slack.

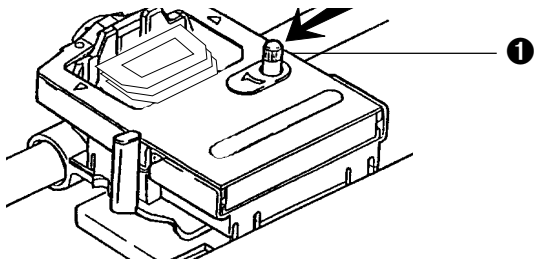

Clearing Paper Jams

Rear-Feed Jams

1. Turn the printer OFF and use the platen knob to back the paper all the way out.

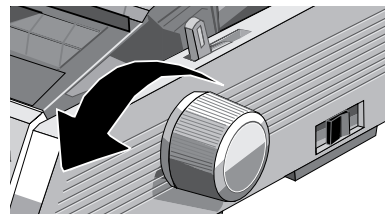

2. Open the access cover, and remove the pull-up roller assembly.



3. Remove any torn pieces of paper.
4. Replace the pull-up roller assembly, and close the access cover.

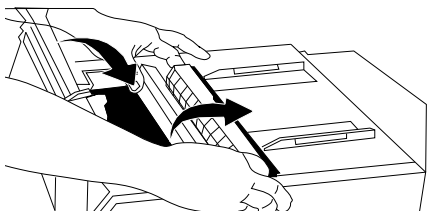

5. Reload paper.

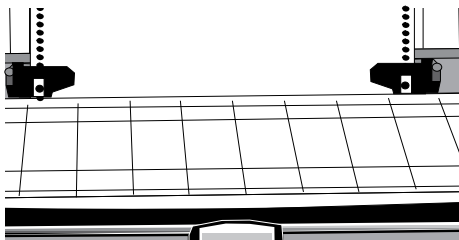

6. Turn the printer on.

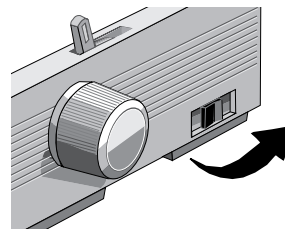

7. Press **FF/LOAD**.



Correcting Repetitive Rear-Feed Jams

If the paper keeps jamming, you probably have bits of paper stuck in the paper path.

1. Perform steps 1 through 3 under “Rear-Feed Jams.”
2. Grasp the paper separator (❶), lift it slightly, pull back on it, then swing it forward.

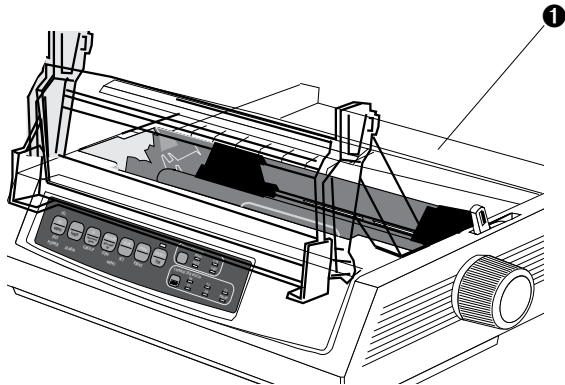

3. Fold some continuous-form paper over three times to make a page four sheets thick, load it on the tractors and close the covers.

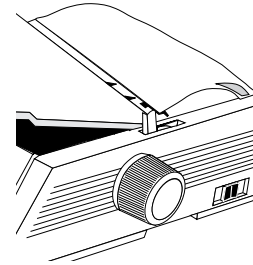

4. Swing the paper separator over, and use the platen knob to draw the quadruple-thick page around the platen: this brings out any jammed bits of paper.

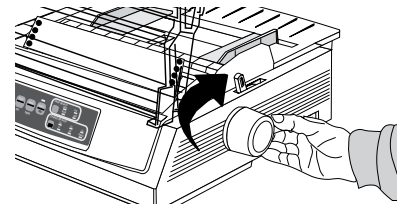

- Remove the paper pieces, and use the platen knob to back the paper out.
- Replace the pull-up roller assembly, and close the access cover.

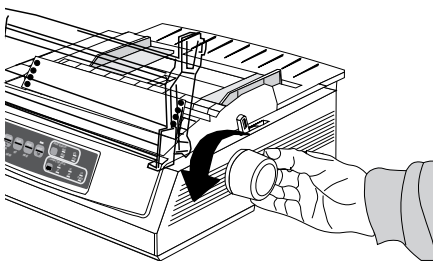

- Swing the paper separator over, reload regular paper, and lower the paper separator back into place.

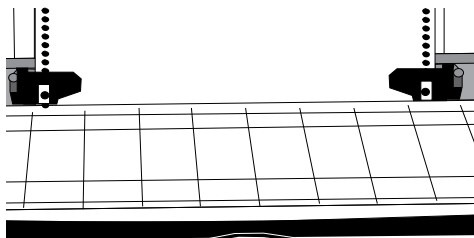

- Turn the printer on.

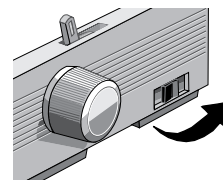
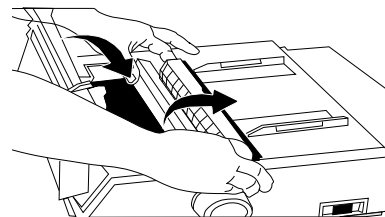

- Press **FF/LOAD**.



Single-Sheet Jams

1. Turn the printer off.
2. Use the platen knob to back the jammed paper out.

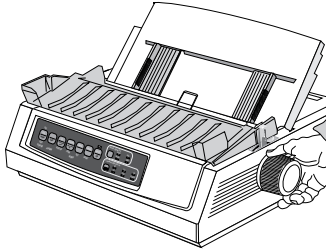

4. Remove any torn pieces from around the carriage.
5. Reinstall the pull-up roller assembly, and close the access cover.

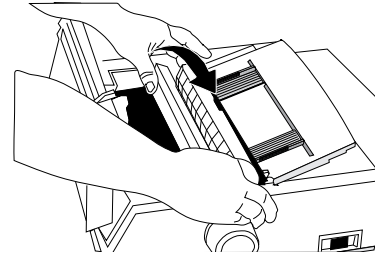

3. Open the access cover and remove the pull-up roller assembly.
6. Turn the printer on, and reload paper.

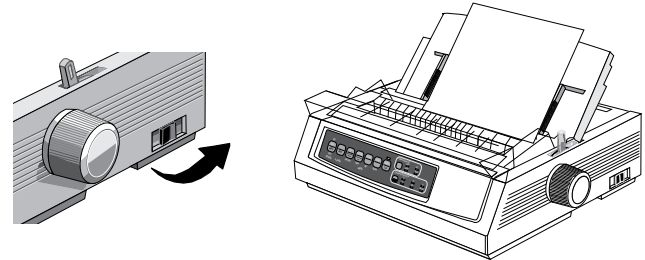
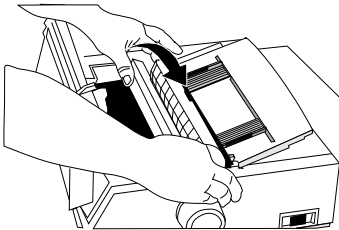

Cleaning the Housing

You should clean the printer every six months (or after about 300 hours of operation).

Note: *Never use solvents or strong detergents on the cabinet: they could damage the housing.*

1. Turn the printer off, and remove any paper from the path.
2. Open the access cover, remove the pull-up roller assembly.

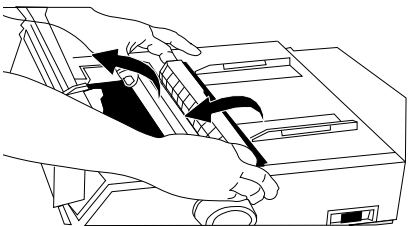

4. Reinstall the pull-up roller assembly, and close the access cover.

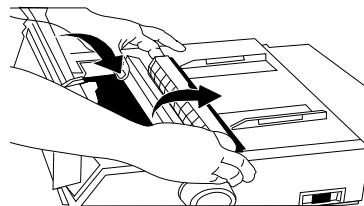

3. Use a clean, dry cloth to dust around the carriage shaft and platen. Remove any loose bits of paper.

Troubleshooting

Problem: *Nothing happens when I turn on the printer.*

Solution: Check the power cable connection and power outlet to your printer. If you are using a power strip, make sure it is turned on, and that the fuse has not blown nor the circuit breaker tripped.

Problem: *The printer does not print when data is sent.*

- Solutions:**
- (1) Is the SEL light on? If not, press the SEL key.
 - (2) Check that the interface cable is securely connected to both the printer and the computer.
 - (3) If you have the optional serial interface board installed, check to be sure that it is firmly seated in the printer.

Problem: *I'm getting strange symbols, incorrect fonts, etc., when I try to print a document.*

- Solution:**
- (1) Check to be sure that the printer driver you have selected in your software matches the printer emulation. (Press SHIFT and SEL keys, then press GROUP key: this will print a line showing the emulation you have selected.)
 - (2) If you have embedded any printer commands in your software, check to be sure that you entered them correctly.

Problem: *I've installed a new ribbon and the printing is smeared and streaked.*

Solution: The ribbon shield is either loose or missing. Remove the ribbon cartridge and check the clear plastic ribbon shield: if it's loose, secure it in place, if it is missing, find it and reinstall it.

Problem: *The ALARM light is on and the Character Pitch 15 light is flashing.*

Solution: This indicates a paper jam. Press the SEL key and correct the paper jam situation (see “Clearing Paper Jams” earlier in this manual).

Problem: *The ALARM light is on and the Character Pitch 10 light is flashing.*

Solution: This indicates that the paper lever is set at the wrong position for the paper you are trying to use: move it to the proper setting.

Problem: *The ALARM light is blinking.*

Solution: Try turning the printer off and then back on again. If the light still blinks, call for service.

Problem: *The printer needs paper, but the ALARM light is not on and I can't load the paper.*

Solution: Press and release the SEL key, then hold the SHIFT key and press the RESET (CHARACTER PITCH) key: this resets the printer.

Problem: *My word processor files don't print the way I have the menu and front panel set.*

Solution: Before sending a file to the printer, many word processors send either an “initialisation string” or an I-Prime signal to the printer. The initialisation string contains codes that override the panel and menu settings.

To change your printer to ignore the reset code, enter the Menu Mode, go down to the Set-Up group and change the setting for Reset Inhibit to Yes (see Menu Mode later in this manual).

The I-Prime signal will automatically override any front panel settings you have made. To eliminate this problem, enter the Menu Mode, go down to the Parallel Interface group and change the setting for I-Prime to Invalid (see Menu Mode later in this manual).

Problem: *The Print Quality and Character Pitch keys on the front panel won't work.*

Solution: The Operator Panel Function in the printer menu can be used to disable these buttons. If the printer is part of a customised system or if it is used by a number of people, the system manager may have used this option to make sure the printer is always set properly.

Problem: *Continuous-form paper is sticking to the paper separator.*

Solution: In cold dry weather, static charges can build up and make the paper cling to the paper separator. Try moving the paper guides together so that the paper rests on the guides rather than on the separator.

Problem: *Ink smears on paper.*

Solution: This may be caused by excessive printhead travel from the centring position when printing narrow columns. Set Centring Position to MODE 1. On ML3321 also try MODE 2. (See Menu Mode).

Using Your Printer

Print Mode: Indicator Lights

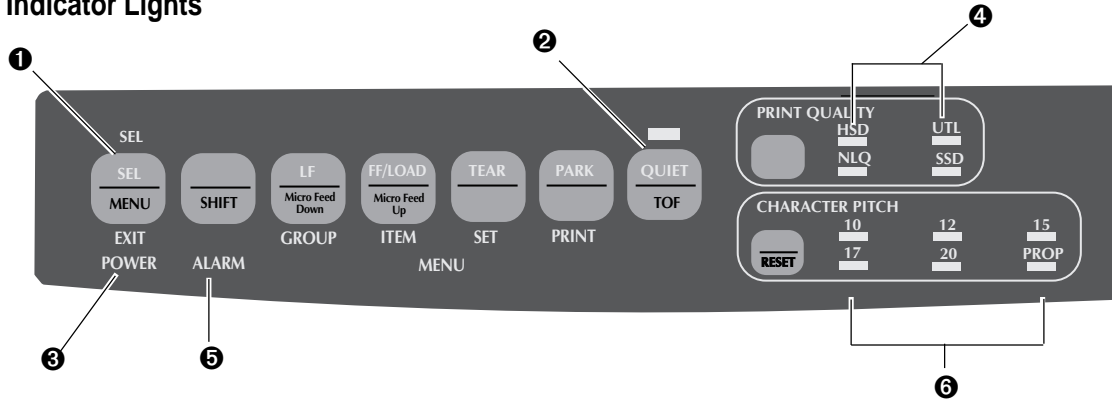

❶ SEL Glows = printer selected, ready to receive data
Flashes = printer in Print Suppress Mode
Not lit = printer deselected (can't receive data)

❷ QUIET Glows = printer in Quiet state.

❸ POWER Glows = printer turned on.

❹ PRINT QUALITY Indicates print quality selected.

❺ ALARM Glows = error condition exists:

- *out of paper* if no other lights are blinking
- *paper jam* if 15 cpi light is also blinking
- *paper lever is set to wrong position* if 10 cpi light is also blinking.

Blinks = error condition. Turn printer off, then on; if the light still flashes, contact your service dealer.

❻ 10/12/15/17/20/PROP Indicate character pitch selected.

Print Mode: Control Panel Keys

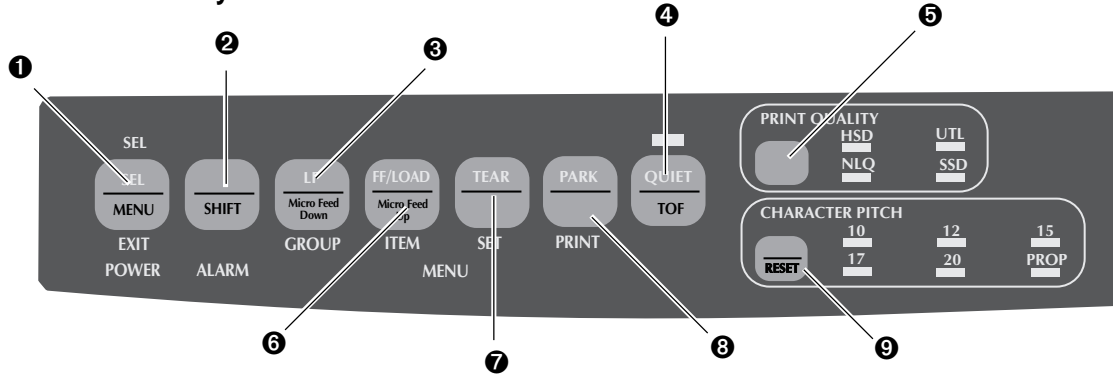

- 1 SEL** Selects/deselects printer. When held on power up, engages the Menu Mode.
- 2 SHIFT** Press and hold while pressing another switch to engage the alternate function for that switch (e.g. “Micro Feed Down” for the LF key).
- 3 LF** Moves paper up one line: press and hold for repetitive line feeds. When held on power up, activates the Font Test
- 4 QUIET** Turns Quiet Mode on and off. When held on power up, activates the Rolling ASCII Test.
- 5 PRINT QUALITY** Selects the print quality.
- 6 FF/LOAD** Loads/ejects single sheet of paper; moves continuous-form paper to print position.
- 7 TEAR** Moves continuous-form paper up for tear-off or back down for printing.
- 8 PARK** Retracts continuous-form paper from the path
- 9 CHARACTER PITCH** Selects the character pitch. Used with the SHIFT key to reset the printer.

Selecting the Print Quality

Important! Front panel settings for print quality and character pitch can be overridden by software commands. The lights will always reflect the printer's state.

Press **PRINT QUALITY** to select:

NLQ: Near Letter Quality

- Highest quality, slowest speed
- Courier or Gothic fonts
- Recommended for correspondence

UTL: Utility

- Medium quality, medium speed
- Gothic font only
- Recommended for internal documents and high-volume data.

HSD: High Speed Draft

- Lower quality, faster speed
- Gothic font only
- Recommended for preliminary drafts.

SSD: Super Speed Draft

- Lowest quality (12 cpi only), fastest speed
- Gothic font only
- Recommended for fastest output of preliminary drafts.

In order to use Super Speed Draft (SSD), you must enter the Menu Mode and make changes:

1. Press **SHIFT + SEL**.
2. Press **GROUP** twice.
3. Press **ITEM**.
4. Press **SET** until DRAFT appears as the setting for the Print Mode.
5. Press **ITEM**.
6. Press **SET** (SSD appears as the setting for the Draft Mode).
7. Press **SHIFT + SEL** key to exit the Menu Mode and save your changes.

Selecting the Character Pitch

Press **CHARACTER PITCH** to select the width of characters in characters per inch:

10 cpi

- Recommended for standard text
- Not available for SSD

12 cpi

- Recommended for standard text.
- Yields more text per page.

17.1 cpi, 20 cpi

- Smallest print
- Recommended for spreadsheets
- Not available for SSD.

PROP

- Proportional spacing
- Recommended for documents where you want a more polished appearance.
- Available only for NLQ.

Menu Mode: Control Panel

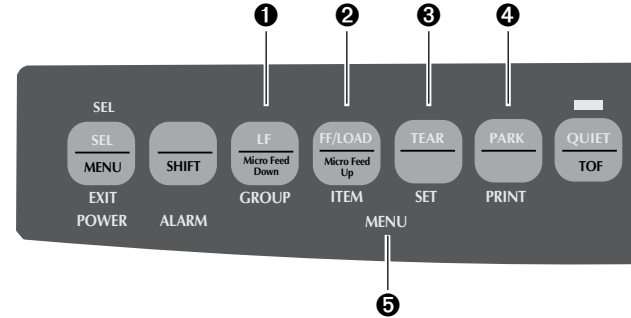

- ❶ **GROUP key** ... Prints the next Group in the Menu. With the SHIFT key, prints the previous Group.
- ❷ **ITEM key** Prints the next Item in the Group. With the SHIFT key, prints the previous Item in the Group.
- ❸ **SET key** Prints the next Setting for an Item. With the SHIFT key, prints the previous Setting for an Item.
- ❹ **PRINT key** Prints a copy of all the Menu settings. With the SHIFT key, prints the current settings for the Group selected.
- ❺ **MENU light** Glows when the printer is in the Menu Mode.

Entering and Exiting the Menu Mode

To enter or exit the Menu Mode, hold **SHIFT** while pressing **SEL**.

Resetting the Menu

To reset the Menu to the standard settings:

1. Turn the printer off.
2. Press **SEL** + **LF** while turning the printer on.

Printing the Menu Settings

1. Make sure paper is loaded in the printer.
2. Enter the Menu Mode (**SHIFT** + **SEL**).
3. Press **PRINT** (PARK).

*Note: To print out a listing of the settings for all menu items, regardless of the emulation selected or the accessories installed, enter the Menu Mode, then press **SHIFT** + **PRINT QUALITY**.*

Changing the Menu Settings

1. Press **SHIFT** + **SEL** to enter the Menu Mode.
2. Use the **GROUP**, **ITEM** and **SET** keys to make your changes:
 - Press **GROUP** successively until the Group you wish to change appears in the first column.
 - Press **ITEM** until the Item you wish to change appears in the second column.
 - Press **SET** until the setting you want appears in the third column.
3. Press **SHIFT** + **SEL** to exit the Menu Mode and save your settings.

Important! If you turn the printer off without first exiting the Menu Mode, the changes you have made will be lost.

Summary of Menu Settings

The table below shows the items which may appear in the menu. Settings which are engaged at the factory (defaults) are set in **bold italic**. Some groups or entries will only appear when a specific emulation is engaged, as noted.

<i>Group</i>	<i>Item</i>	<i>Setting</i>
Printer Control	Emulation Mode	IBM PPR , EPSON FX, ML
Font	Print Mode	Utility , NLQ Courier, NLQ Gothic, DRAFT
	Draft Mode	HSD , SSD
	Pitch	10 cpi , 12 cpi, 15 cpi, 17.1 cpi, 20 cpi
	Proportional Spacing	No , Yes
	Style	Normal , Italics
	Size	Single , Double
Symbol Sets	Character Set	Set I, Set II, Standard*, Line Graphics* , Block Graphics*
	Language Set	ASCII , French, German, British, Danish I, Swedish I, Swedish II, Swedish III, Swedish IV, Italian, Spanish I, Japanese, Norwegian, Danish II, Spanish II, Latin American, French Canadian, Dutch, TRS 80, Turkish, Swiss I, Swiss II, Publisher Slashed, Unslashed
	Zero Character	
	Code Page	USA , Serbo Croatic II, Canada French, ECMA-94, Multilingual, Windows East Europe, Portugal, Windows Greek, Norway, Latin 5 (Windows Turkey), Baltic 774, Windows Cyrillic, East Europe Latin II-852, Cyrillic I-855, Hungarian CWI, Turkey 857, Ukrainian, Cyrillic II-866, ISO Latin 6, Greek_869, Hebrew NC (862), Kamenicky (MJK), Hebrew OC, Greek_437, Windows Hebrew, Greek_437 CYPRUS, Windows Baltic, Turkey, Bulgarian, Polska Mazovia, Greek_928, ISO Latin 2, Serbo Croatic I
	Slashed Letter O	No , Yes

* *Appears only when the MICROLINE Standard emulation is selected.*

<i>Group</i>	<i>Item</i>	<i>Settings</i>
Rear Feed	Line Spacing Form Tear-Off Skip Over Perforation Page Width (ML3321 only) Page Length	6 LPI , 8 LPI Off , 500 mS, 1 sec, 2 sec No , Yes 13.6" , 8" 11", 11-2/3", 12" , 14", 17", 3", 3.5", 4", 5.5", 6", 7", 8", 8.5"
Bottom Feed	Line Spacing Form Tear-Off Skip Over Perforation Page Width (ML3321 only) Page Length	6 LPI , 8 LPI Off , 500 mS, 1 sec, 2 sec No , Yes 13.6" , 8" 11", 11-2/3", 12" , 14", 17", 3", 3.5", 4", 5.5", 6", 7", 8", 8.5"
Top Feed	Line Spacing Bottom Margin Page Width (ML3321 only) Page Length Wait Time Page Length Control	6 LPI , 8 LPI Valid , Invalid 13.6" , 8" 11", 11-2/3" , 12", 14", 16.57", 3", 3.5", 4", 5.5", 6", 7", 8", 8.5" 500 mS, 1 sec , 2 sec By MENU Setting, By Actual Page Length
Set-Up	Graphics 7 or 8 Bit Graphics* Receive Buffer Size Paper Out Override Print Registration 7 or 8 Bits Data Word*	Bidirectional , Unidirectional 8, 7 1 Line, 16K , 28K No , Yes 0.25 mm Right, 0.20 mm Right, 0.15 mm Right, 0.10 mm Right, 0.05 mm Right, 0 , 0.05 mm Left, 0.10 mm Left, 0.15 mm Left, 0.15 mm Left, 0.15 mm Left 8, 7

* Appears only when the MICROLINE Standard emulation is selected.

<i>Group</i>	<i>Item</i>	<i>Settings</i>
Set-Up <i>continued</i>	Operator Panel Function Reset Inhibit Print Suppress Effective Auto LF Auto CR ⁺ Print DEL Code* SI Select Pitch (10 cpi) ⁺ SI Select Pitch (12 cpi) ⁺ Time Out Print Auto Select Centring Position	Full Operation , Limited Operation No , Yes Yes , No No , Yes No , Yes No , Yes No , Yes 17.1 cpi , 15 cpi 20 cpi, 12 cpi Valid , Invalid No , Yes DEFAULT , MODE 1, MODE 2***
Parallel I/F	I-Prime Pin 18 Auto Feed XT**	Buffer Print , Invalid, Buffer Clear +5V, Open Invalid , Valid

* *Appears only when the MICROLINE Standard emulation is selected.*

+ *Appears only when the IBM emulation is selected.*

** *Applies only when the Epson emulation is selected.*

*** ML3321 only.

Explanations of Menu Items

7 or 8 Bits Data Word (ML). If your computer system uses seven bits to make up each unit of data, change this setting to 7.

7 or 8 Bit Graphics. Choose the graphics your system uses: 7 or 8 dots in each column printed.

Auto CR (IBM). If you want the printer to automatically add a carriage return when a Line Feed is received at the end of a line, change the setting to Yes.

Auto LF. If your printout is consistently double spaced, select No; if it overprints, select Yes.

Auto Feed XT (Epson). If your system uses pin 14 of the parallel interface to control automatic line feed, change the setting to Valid.

Auto Select. If you always use the same Top of Form position, change the setting to Yes.

Bottom Margin. Change to Invalid if you want the printer to ignore the bottom margin setting. *Caution! This can cause loss of data and damage the printhead.*

Centring Position. Choose DEFAULT, Mode 1 or Mode 2.

Character Set. Choose IBM Set I or IBM Set II.

Code Page. Choose the Code Page character set you wish to use: USA (IBM 437), Canada French (IBM 863), Multilingual (IBM 850), Portugal (IBM 860), Norway (IBM 865), BRASC II, or Abicomp.

Draft Mode. Change to SSD if you wish to use the Super Speed Draft mode of printing. *Note: Print Mode must be set to DRAFT for this setting to be effective.*

Emulation Mode. Choose the printer emulation.

Form Tear-Off. Choose 500 mS, 1 sec, or 2 sec to turn the Form Tear-Off feature on and to set the time interval for the printer to wait before advancing the paper.

Graphics. Change to bidirectional graphics for faster printing: optimise the registration using the Print Registration menu item.

I-Prime. Determines what the printer will do when it receives the I-Prime signal from the host: Buffer Print prints out the buffer contents before resetting; Buffer Clear dumps the buffer contents immediately. Invalid causes the printer to ignore the I-Prime signal.

Language Set. Replaces certain standard symbols with special characters used in foreign languages.

Line Spacing. Change to 8 lpi to print more lines on a page.

Operator Panel Function. Change to Limited Operation to deactivate the PRINT QUALITY and CHARACTER PITCH buttons. This prevents these from being changed via the control panel when multiple people are using the printer.

Page Length. Selects the length of the paper you are using.

Page Width (Model 3321 only). Change to 8" to print on letter-size paper.

Paper Out Override. Senses when less than 1" (25 mm) of paper remains, and stops printing. Change to Yes to override the sensor. *Caution! This can cause loss of data and damage the printhead!*

Pin 18. Sets the signal on pin 18 to +5 volts or to open.

Pitch. Choose the character width, in character per inch (cpi).

Print DEL Code (ML). Change to Yes if you wish to print the DEL code (decimal 27) as a solid box.

Print Mode. Choose the quality and speed of printing.

Print Registration. Change the setting as required to obtain the best registration for bidirectional printing.

Print Suppress Effective. If your system uses the DC1 and DC3 codes for something other than the print suppress mode, change the setting to No.

Proportional Spacing. Change the setting to Yes to engage proportional spacing of characters.

Receive Buffer Size. Selects the amount of memory devoted to holding received data. Choosing 1 Line will tie up your computer while printing, but if you abort the print job, the printer will stop much sooner.

Reset Inhibit. Select Yes to prevent your software from resetting your printer's settings.

SI Select Pitch, 10 cpi (IBM). Sets the pitch to be engaged when the printer control panel is set for 10 cpi and the SI command is received.

SI Select Pitch, 12 cpi (IBM). Sets the pitch to be engaged when the printer control panel is set for 12 cpi and the SI command is received.

Size. Change to Double for double width and height printing.

Skip Over Perforation. Change to Yes if you want the printer to go to the next page when it comes within 1" (25 mm) of the bottom of the page. Keep it set to No if your software has its own page formatting controls.

Slashed Letter O. If set to Yes, capital and lower case slashed O (Ø and ø) will appear at locations 9Bh and 9Dh respectively in USA code page. If set to No, the characters “ç” and “¥” will appear at these locations.

Style. Change to italics if you want the printed characters to be slanted.

Time Out Print. If your software spends a long time processing between portions of data it feeds to the printer, change the setting to Invalid to keep your printer from inadvertently dumping the received data while it is waiting for more.

Wait Time. Sets the amount of time the printer will wait for more data before moving to the form tear-off position.

Zero Character. If you do not want the printer to use a slash to distinguish the number zero from the capital letter O, change the setting to Unslashed.

Using the Printer's Features

Tear Feature

Use this feature to advance continuous-form paper up to the tear position by simply pressing **TEAR** (❶).

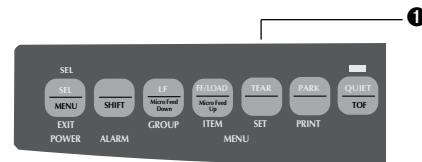

Note: *The Tear Feature can not be used when the optional pull tractor is engaged.*

Forms Tear-Off Feature

Important! *Never engage Forms Tear-Off when printing on labels!*

The Forms Tear-Off feature automatically moves continuous-form paper up to the tear position after the interval you select, then moves it back down again for printing when the printer receives more data.

This feature is normally turned off. To activate it:

1. Press **SHIFT** (②) + **SEL** (①).

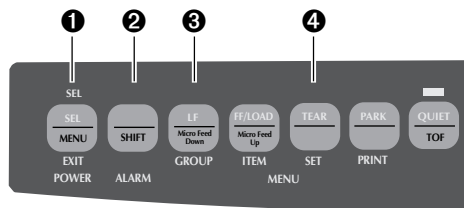

2. Press **GROUP** (③) until one of the following lines appears, depending on which paper feed you are using:

REAR FEED Form Tear-Off OFF
BOTTOM FEED Form Tear-Off OFF

3. Press **SET** (④) until the time interval you wish to select appears in the third column.
4. Press **SHIFT** (②) + **SEL** (①) to exit Menu Mode and save the setting.

Note: Some programs pause occasionally while sending data. If the pause is too long, the paper will advance to the tear-off position until more data is received. This extra paper movement can cause uneven print registration in graphics. If you have this problem, use the menu to turn off this feature.

Paper Park Feature

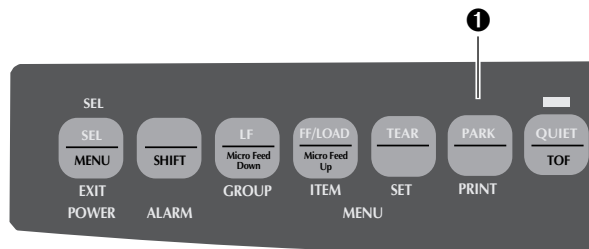

To retract rear-feed paper from the paper path, press **PARK** (①).

Specifications

Print Method Impact dot matrix

Printhead 9 pins, 0.34mm diameter, thermal protection

Print Speed

<i>Mode</i>	<i>Characters per second</i>
Super Speed Draft (SSD)	435 cps
High Speed Draft (HSD)	387 cps
Utility (UTL)	290 cps
Near Letter Quality (NLQ)	72.5 cps

Characters per Line (CPL)

<i>Setting</i>	<i>ML3320</i>	<i>ML3321</i>
10 cpi	80 cpl	136 cpl
12 cpi	96 cpl	163 cpl
15 cpi	120 cpl	204 cpl
17.1 cpi	137 cpl	233 cpl
20 cpi	160 cpl	272 cpl

Emulations Epson FX, IBM Proprinter III, and Oki Microline Standard co-resident

Interface Standard: Centronics parallel
Optional: RS-232C serial

Graphics Resolution

<i>Emulation</i>	<i>Maximum Resolution</i>
Epson/IBM	240 (H) x 216 (V) dpi
Oki ML Std.	288 (H) x 144 (V) dpi

Resident Fonts

<i>Print Quality</i>	<i>Available Fonts</i>
Near Letter Quality	Courier, Gothic
Utility	Gothic
High Speed Draft	Gothic
Super Speed Draft	Gothic

Bar Codes Code 39, UPC A, UPC E, EAN 8, EAN 13, Interleaved 2 of 5, Code 128, Postnet

Receive Buffer Size 28K

Reliability

<i>Parameter</i>	<i>Reliability</i>
Mean Time Between Failures (MTBF)	10,000 hours at 25% duty cycle and 35% page density
Mean Time to Repair (MTTR)	15 minutes
Printhead Life	200 million characters average in 10 cpi draft mode at 25% duty and 35% page density
Ribbon Life (on average, 10 cpi utility)	3 million characters

Paper Width Minimum: 76.2mm (3")
Maximum, ML3320: 254mm (10")
Maximum, ML3321: 406.4mm (16")

Paper Weight 45 to 90 g/m² (12 to 24 lb.)

Paper Thickness Rear Feed: 0.36mm (0.014") max.
Bottom Feed: 0.44mm (0.017") max.

Paper Specifications

<i>Paper Type</i>	<i>Feed</i>	<i>Weight</i>	<i>Width Range</i>
Cut sheets	Top Only	58 - 90 g/m ² (14 - 24 lb.)	ML3320: 182.9-215.9 (7.2" - 8.5") ML3321: 182.9 - 363.2mm (7.2 - 14.3")
Single-part continuous forms	Rear, Bottom	45 - 90 g/m ² (12-24 lb.)	ML3320: 76.2-254mm (3" - 10") ML3321: 76.2-406.4mm (3" - 16")
Carbonless continuous forms	Rear, Bottom	34 - 41 g/m ² (9 - 11 lb.)	ML3320: 76.2-254mm (3" - 10") ML3321: 76.2-406.4 (3" - 16")
Interleaf continuous forms	Rear, Bottom	Paper 38 - 45 g/m ² (10 - 12 lb.) Carbon 34 g/m ² (9 lb.)	ML3320: 76.2-254mm (76.2 - 254mm) ML3321: 76.2-406.4mm (3" - 16")
Labels	Bottom Only		ML3320: 3" - 10" (76.2 - 254mm) ML3321: 3" - 16" (76.2 - 406.4mm)

Paper Specifications *(continued)*

<i>Paper Type</i>	<i>Feed</i>	<i>Weight</i>	<i>Width Range</i>
Envelopes, single feed	Top Only	24 lb. max. (90 g/m ²)	165.1 - 241.3mm (6.5" - 9.5")
Envelopes, continuous feed, non-overlap	Bottom Only	24 lb. max. (90 g/m ²)	165.1 - 241.3mm (6.5" - 9.5")
Card stock	Bottom Only	120 lb. max. (178 g/m ²)	N.A.
Transparencies	Top Only	—	215.9 - 279.4mm (8.5" - 11")

Dimensions (W x D x H)

ML3320: 389 x 345 x 116 mm
 ML3321: 430 x 345 x 116 mm

Weight

ML3320: **7 Kg**
 ML3321: **9 Kg**

Environmental Requirements

<i>Parameter</i>	<i>Range</i>
Operating Temperature	41 to 104°F (5 to 40°C)
Storage Temperature	14 to 122°F (-10 to 50°C)
Operating Humidity	20 to 80% RH
Storage Humidity	5 to 95% RH

Electrical Requirements 240 volts ac (+10%, -14%),
 50/60 Hz (±2%)

This product complies with the requirements of the Council Directives 89/336/EEC and 73/23/EEC on the approximation of the laws of the member states relating to electromagnetic compatibility and low voltage.

Specifications subject to change without notice.

Index

A

- Auto
 - CR menu setting 18
 - feed XT menu setting ... 18
 - LF menu setting 18
 - select menu setting 18

B

- Bar codes 23
- Bottom margin menu
 - setting 17

C

- Card stock specifications .. 25
- Centring position menu
 - setting 18
- Character pitch 14
- Characters per line 23
- Character set menu
 - setting 16
- Code page menu setting 16

- Continuous-form paper
 - jams, clearing 2-4
 - specifications 24
- Control panel 11-14

D

- Defaults, menu 16-18
 - resetting 15
- Dimensions 25
- Draft mode menu setting .. 19

E

- Electrical requirements 25
- Emulation mode menu
 - setting 16
- Envelope specifications 25
- Environmental
 - requirements 25

F

- Factory settings, menu . 16-18
- Form tear-off feature 21
 - menu setting 19
- Front panel 11-14

G

- Graphics menu setting 17
- Graphics resolution 23

H

- Humidity requirements 25

I

- Indicator lights 11, 14
- Interface 23
- I-Prime menu setting 19

J

- Jams, paper 2-6

L

- Label specifications 24
- Language set menu
 - setting 16
- Lights, control panel ... 11, 14
- Line spacing menu setting 17

M

- Maintenance 1-7
- Menu mode 14-21

O

- Operator panel function
 - menu setting 20

P

- Page length menu setting .. 20
- Page width menu setting ... 20
- Panel, front 11-14
- Paper
 - jams, clearing 2-6
 - specifications 24
- Paper out override menu
 - setting 20

Paper park feature	22	R		T	
Pin 18 menu setting	20	Rear feed paper		Tear-off feature	21
Pitch menu setting	20	jams	2-5	Temperature requirements	25
Print DEL code menu		Receive buffer size	20, 23	Time out print menu	
setting	20	Reliability	24	setting	21
Print mode menu setting ...	20	Reset inhibit menu		Transparency	
Print quality	13	setting	20	specifications	25
Print registration menu		Resident fonts	23	Troubleshooting	8-10
setting	20	Ribbon replacement	1		
Print speed	23	S		W	
Print suppress effective		SI select pitch menu		Wait time menu setting	21
menu setting	20	settings	20	Weight	25
Printhead specifications ...	23	Single sheet paper jams,		Z	
Problem solving	8-10	clearing	6	Zero character menu	
Proportional spacing		Size menu setting	20	setting	21
menu setting	20	Skip over perforation			
		menu setting	21		
		Specifications	23-25		
		Style menu setting	21		

Oki Systems Company

Oki Systems (UK) Limited

550 Dundee Road
Slough Trading Estate
Slough
Berks. SL1 4LE

Tel: 01753-819819

Fax: 01753-819899

Free Manuals Download Website

<http://myh66.com>

<http://usermanuals.us>

<http://www.somanuals.com>

<http://www.4manuals.cc>

<http://www.manual-lib.com>

<http://www.404manual.com>

<http://www.luxmanual.com>

<http://aubethermostatmanual.com>

Golf course search by state

<http://golfingnear.com>

Email search by domain

<http://emailbydomain.com>

Auto manuals search

<http://auto.somanuals.com>

TV manuals search

<http://tv.somanuals.com>