

2 SERIES
LCD HDTVs

OLEVIA

242T FHD

247T FHD

252T FHD

255T FHD





Photo may vary from actual model.

**USER
MANUAL**

Table of Contents

Important Information	1
Important Safety Precautions	2
Introducing the OLEVIA TV	5
Accessories	7
TV Installation And Connection Guide	
Identifying Front Controls and Rear Panels	8
- Descriptions of Connector Types	10
- Turn the power on the TV	11
Installation	12
- Connecting to an Antenna or Video Equipment with Antenna Outlet	13
- Connecting to a Set-Top-Box with HDMI Cables	14
- Connecting to a Satellite Receiver or Cable Box with Component Connectors	15
- Connecting to a DVD Player with A/V or S Video Cables	16
- Connecting to a DVD Player with Component Cables	17
- Connecting to a DVD Player with HDMI Cables	18
- Connecting to a Satellite Receiver or Cable Box with A/V Cables	19
- Connecting to a VCR, PVR, or DV with A/V Cables	20
- Connecting to a Blue-Ray DVD Player or HD-Receiver with HDMI Cables and a PC with VGA Cables	21
- Connecting to a D-VHS with HDMI Cables	22
- Connecting to a D-VHS with Component Cables	23
- Connecting to an Audio Receiver	24
- Connecting to a Home Theater System or Earphone Set	25
- Instruction for Uploading New Firmware	26
Remote Control Guide	
Remote Function Keys & Description	27
Programming the Remote Control	28
Battery Installation	29
On Screen Display (OSD)	30
Introduction	30
Operating in the OSD	30
Initial Screen	31
PICTURE OSD Adjusting TV Picture Settings	32
- Description of Settings	32
- Selecting the Picture Mode	33
- Adjusting the Picture Quality	35
AUDIO OSD Adjusting Sound Quality	37
- Description of Settings	37
- Adjusting the Audio Settings	37
- MTS System for Stereo TV	38
SCREEN OSD Adjusting Screen Modes	39
- Description of Settings	39
- Changing the Screen Mode	39
- Selecting the Picture/Video Source	43
SETUP OSD Adjusting Personal TV Settings	44
- Description of Settings	44
- Searching the TV Channels	45
- Editing Channels	46
- Closed Caption Options	50
- Setting up Parental Control Password	51
- Activating the Parental Control Feature	51
- Resetting the Password	57
- Setting the Date and Time	58
- Setting the TV Timer	59
- Timeout Settings for OSD Menu	59
- TV OSD Languages	60
- Setting DPMS	60
- Setting LED Light	60
- Factory Default Option	60
- Displaying the Firmware Version	60
Specifications	61
Timing Mode for VGA and HDMI(PC)	63
Pixels Policy	64
Glossary	65

Important Information

	Caution Risk of electronic shock Do not open	
<p>To reduce the risk of electronic shock, do not remove cover (or back). No user-serviceable parts inside. Refer service to qualified Repair Technician or Repair Center.</p>		



Read the following context indicated by the following symbol to the left. It indicates important literature in operating the product.



Read the following context indicated by the following symbol to the left. It indicates a potential high voltage hazard that may compromise your safety.



Caution

Take caution when moving the product on a cart. Quick stops, excessive force, and uneven surfaces may cause the display unit and cart combination to overturn.

Caution

To prevent electric shock, match wide blade of plug to wide slot, fully insert.

Caution

This product satisfies FCC regulations when shielded cables and connectors are used to connect the unit to other equipment. Prevent electromagnetic interference from electrical appliances such as radios and televisions. Please use shielded cables and connectors for connections.

Warning

FCC Regulations state that any unauthorized changes or modifications to this equipment not expressly approved by the manufacturer could void the user's authority to operate this equipment.

Caution

Make sure that the cable system is grounded to provide protection against voltage surges and built up static charges.

Warning

THIS TELEVISION IS EXTREMELY HEAVY -- IMPROPER HANDLING AND INSTALLATION CAN RESULT IN INJURY TO PEOPLE AND PROPERTY DAMAGE TO THE STRUCTURE AND SURROUNDING PERSONAL PROPERTY! WALL MOUNTING OF THIS TELEVISION SHOULD ONLY BE ATTEMPTED BY A PROFESSIONAL -- ANY LIABILITY FOR PERSONAL INJURY OR PROPERTY DAMAGE CAUSED BY FAILED WALL MOUNTING ATTEMPTS WILL NOT BE ACCEPTED BY THE MANUFACTURER!

Important Safety Precautions

Cleaning

Remember to unplug the AC cord from the AC outlet before cleaning the display unit.

Then spray small amount original WINDEX window clearer (blue stuff), not Ammonia-added clearer, on cloth to clean the display.

Remember to use only soft cotton cloth such as an old 100% cotton T-shirt, not sponges brillo abrasive material, to clean the display.

No drips allowed.

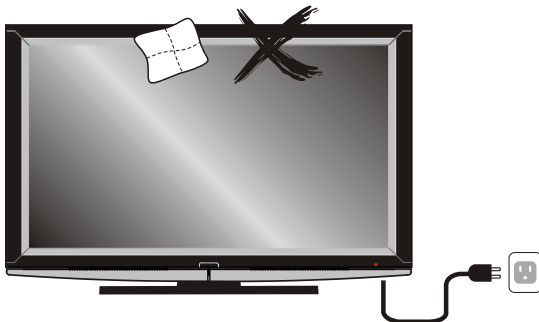

Stand

Do not place the display unit on an unstable place. The TV may fall resulting in serious personal injuries to nearby people as well as damage to the display unit.



Ventilation

Do not cover or block these vents and openings located on the top and back of the display. Inadequate ventilation may cause overheating and shorten the lifespan of the display.

Do not place in an enclosed area such as a built-in shelf, unless proper ventilation is provided or the manufacturer's instructions are followed. Keep the distance of 10cm minimum between the display unit and wall. Never install the display unit as indicated in the picture below.



Air circulation is blocked

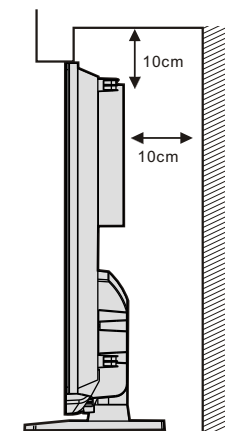

Air circulation is blocked

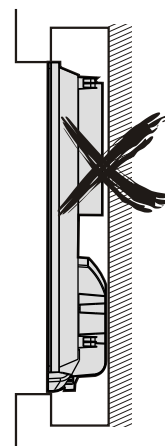

Never insert objects or spill liquid into the display unit

Never insert any object into the display unit through openings or spill liquid on the display unit. High voltage flows in the display unit, and inserting an object can cause electric shock and/or short internal parts.



Keep away from water and moisture

Do not place the display in areas where moisture is present or where the unit may get wet such as bathrooms, kitchen, pool area or in a wet basement.

Keep away from heat sources

Keep the display unit away from heat sources such as radiators, heaters, stoves and other heat-generating products.

The liquid crystal panel used in this product is made of glass

Do not hit the panel. Be careful to prevent from getting hurt by broken glass pieces in case the panel breaks.

Follow operating instructions

All operating instructions must be followed.

Servicing

Do not attempt to service the display unit yourself. Removing covers expose you to high voltage and other dangerous conditions. Request a qualified service technician to perform the service.

Precautions when transporting the display

Carrying the display requires two or more people.

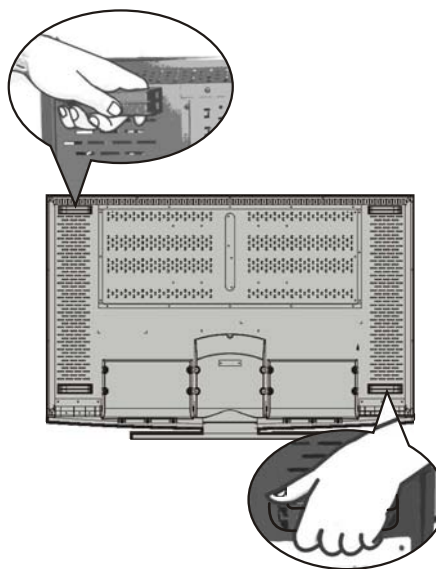

Attachments

Do not use attachments not recommended by the manufacturer. Use of inadequate attachments may result in accidents to nearby people or to the unit.

Power source

This product must operate on a power source specified on the specification label. If you are not sure of the type of power supply used in your home, consult your dealer or local power company. For units designed to operate on batteries or another power source, refer to the operating instructions.

AC cord protection

The AC cords must be routed properly to prevent people from stepping on them or objects from resting on them. Check the cords at the plugs and product.

Overloading

Do not overload AC outlets or extension cords. It may result in electric shock or start a fire.

Replacement parts

In case the display unit needs replacement parts, make sure that the service technician uses replacement parts specified by the manufacturer, or those with the same characteristics and performance as the original parts. Use of unauthorized parts can result in fire, electric shock and/or other danger.

Safety checks

Upon completion of service or maintenance, request the service technician to perform safety checks to ensure that the display unit is in proper operating condition.

Repair

When the display unit displays an abnormal condition, any noticeable abnormality in the display unit indicates that the display unit needs servicing. If any of the following conditions occurs, unplug the AC cord from the AC outlet, and request a qualified service person to perform repairs.

1. A liquid was spilled on the display unit or objects have fallen into the display unit.
2. The display unit has been exposed to rain or water.
3. The display unit has been dropped or damaged.

Environment

The display unit only operates within the temperature 0 °C to 40 °C. Operation outside of the recommended may cause damage to your product.

Warning



When installing or realigning an outside antenna system, extreme care should be taken to keep from touching such power lines or circuits. Contact with them could be fatal.

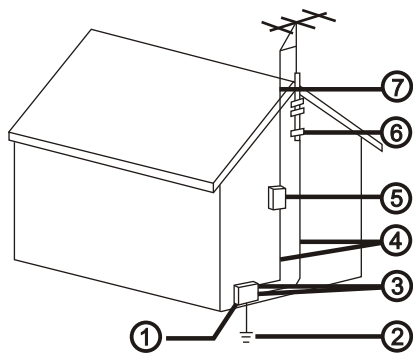

Antenna and satellite grounding

Reference	Grounding component
1	Electric service equipment
2	Power service grounding electrode system (NEC Art 250. Part H)
3	Ground clamps
4	Grounding conductors (NEC Section 810-21)
5	Antenna discharge unit (NEC Section 810-20)
6	Grounding clamp
7	Antenna lead-in wire

Prevent the display unit from falling

Please select the fit-sized screws and wire ropes to fasten the display unit on the wall to prevent it from falling immediately when the earthquake happens.

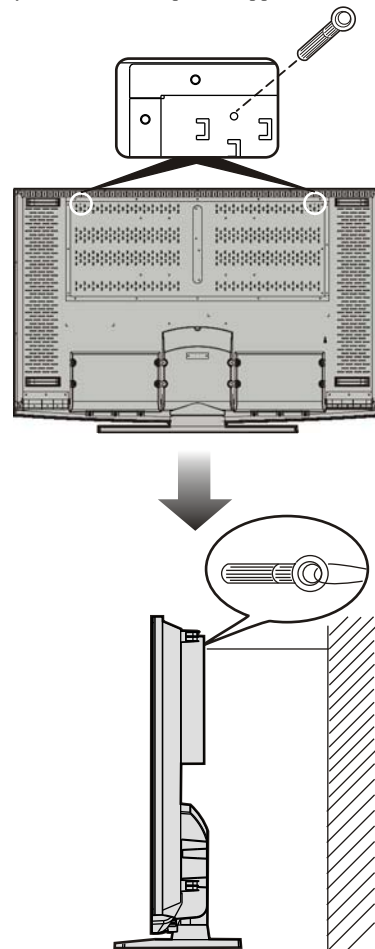



Introducing the OLEVIA TV

Welcome!

Thank you for purchasing a OLEVIA LCD HDTV.
This manual is to be used with the following model:

OLEVIA 2 Series

This manual is designed to help you through setting up and operating your LCD HDTV as quickly as possible. The model and serial numbers are on the back cover of your TV. Write these numbers in the space provided in this manual for your records. Please read all the safety and operating instructions carefully, and keep this manual for future reference.

Licensed Under U.S. Patent 4930160.

Owner's Record

The model and serial numbers are located at the rear of the display unit, or on the side of the media receiver unit on the cartons (white label). Record these numbers in the spaces provided below. And register your product at www.olevia.com. Refer to them whenever you call Syntax-Brilliant Corporation or local dealer regarding this product.

Model No. _____

Serial No. _____

OLEVIA LCD HDTV includes many features, you will enjoy throughout the usage of your TV. These highlighted features include:

Fully Integrated HDTV (High Definition TV):

HDTV delivers a stunning picture far beyond the quality of standard televisions. These programs offer crystal clear video with amazing detail played with enhanced audio quality of digital television programs. You can enjoy better sound and picture in movies, primetime TV shows, and other HD broadcasts in dynamic television settings through cable, satellite or even free broadcasts over the air.



HDMI (High Definition Multimedia Interface):

The next generation of DVI, HDMI provides the best interface between a DVD player and compatible products such as digital set top box for uncompressed digital audio/video connections. When matched with a OLEVIA TV, multi-channel digital audio signals, uncompressed DVI digital video and intercommunication between high multimedia interfaces are combined through a single interconnecting cable.



HDMI and the HDMI logo are trademarks or registered trademarks of HDMI Licensing, LLC.

Manufactured under license from Dolby Laboratories. Dolby and the double-D symbol are registered trademarks of Dolby Laboratories.



Olevia and the Olevia logo are trademarks or registered trademarks of Syntax-Brilliant Corporation in the United States and other countries. Corporate names, trademarks, registered trademarks, service marks, symbols, and logos stated herein are property of their respective companies.

Accessories

Supplied Accessories

Remote control & batteries (AAA x 2)



Power cord x 1



User manual x 1

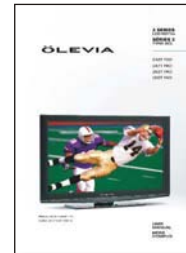

QSG x 1



Warranty Card x 1



These items are all you need to set up and operate the TV in its basic configuration.

Note: Most components (VCRs, DVD players, etc.) come with the necessary cables to connect them. If you want to set up a complex system, you may need to buy extra cables, connectors, etc. Be sure to have these on hand before you start to connect your system.

TV Installation and Connection Guide

Identifying Front and Rear Panels

Front Panel

For 242 / 247 Models

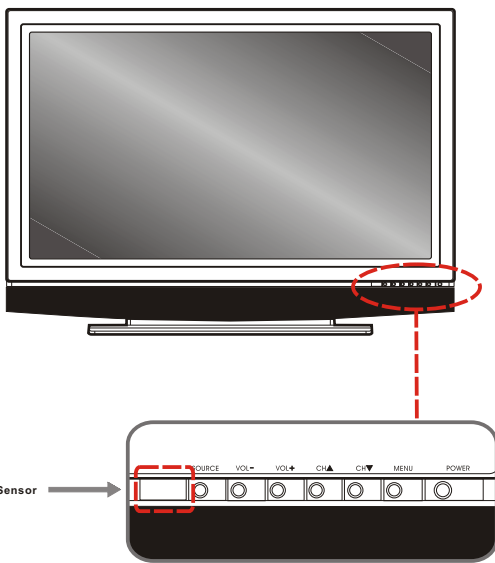

For 252 / 255 Models

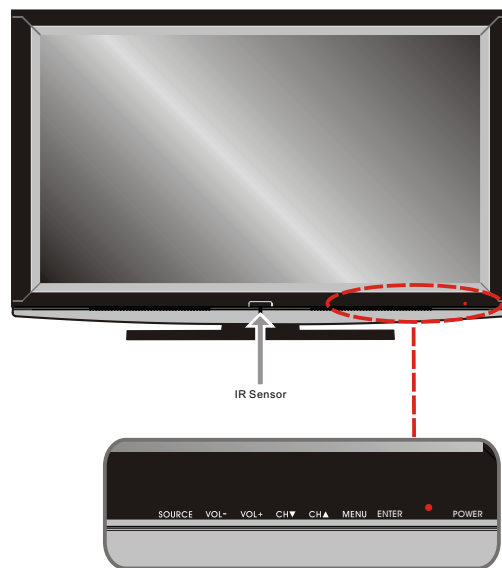

POWER Turns display on/off.

ENTER Press to enter to Sub-Menu, or select and confirm your setting.

MENU Displays the On Screen Display(OSD) menu. In OSD menu, press it to return to the previous screen or to exit.

CH▲ / CH▼ Adjusts Channel. In the OSD menu, both keys are used to navigate within menu.

VOL+/VOL- Adjusts Volume. In the OSD menu, both keys are used to navigate within menu. Vol+ is used to select the highlighted option.









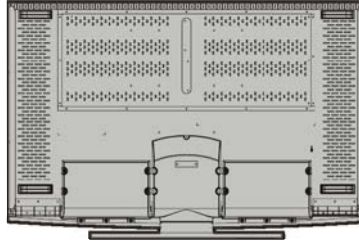

SOURCE Press to switch the input sources.

IR SENSOR Contains Infra-red light for digital data transmission by the remote control. Please point remote control at IR Sensor for function.

Identifying Front and Rear Panels





Rear Panel



1 Power Connections	
AC In 	The power cord connects here.
2 Computer / TV Signal Connections	
RF Terminal 	To receive signals from VHF / UHF antennas or a cable system (For TV Models Only)
Component 1/2 	(5 RCA jacks) Used to connect A/V equipment with component video outputs, such as a DVD player, Digital Satellite Receiver, or compatible Video Game System. NOTE: The component inputs have a superior quality of picture than the S-Video or AV (composite video) inputs.
Video 1/2 	AV (Composite Video: 3 RCA jacks): Used to connect a VCR, Super VHS (S-VHS), DVD player, or other video devices to the TV. OR S-Video : (1 DIN and 2 RCA jacks) Used to connect video devices to the TV. However, they have a better quality of picture than a composite video signal.
HDMI/DVI 	Used to connect digital video equipment with a HDMI/DVI output. NOTE: Preferred connection for HDMI/DVI Satellite or Set-Top-Box equipment.
VGA/Audio Input (PC) Port 	Used for analog RGB signals from a personal computer. VGA has one set of Audio R/L inputs. OR As a computer input with VGA to RCA Adapter.
Audio Input 	To send an AV receiver or other equipment's connected audio signals to the TV
Firmware Upgrade Port 	To allow firmware upgrades.
RS232C Port  RS232C Port	Used to control the TV with automation devices.
Earphone 	Used for audio output to earphone.
Coaxial/Optical 	To send the TV's connected digital audio signals to an AV receiver or other equipment, such as the amplifier

Descriptions of Connector Types

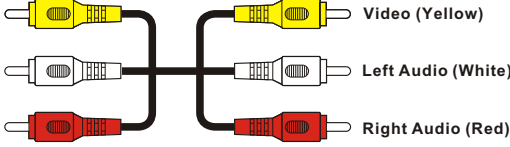
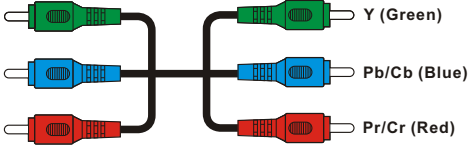
You may find it necessary to use some of the following cable types during setup.

<p><u>75-ohm Coaxial Cable</u></p> 	<p>For TV/cable connection</p>
<p><u>S-Video Cable</u></p> 	<p>Used for transferring video signal, which is split into two signals, brightness and color.</p> <p>Through this connection, you can view a better picture than AV (Composite Video) connection.</p>
<p><u>Audio/Video Cable</u></p>  <p>Video (Yellow)</p> <p>Left Audio (White)</p> <p>Right Audio (Red)</p>	<p>Used for transferring audio and video signal.</p> <p>This connection is the most commonly found on A/V equipment.</p>
<p><u>Component Cable</u></p>  <p>Y (Green)</p> <p>Pb/Cb (Blue)</p> <p>Pr/Cr (Red)</p>	<p>Used for transferring video signal, which is split into three signals, one brightness and two color.</p> <p>Through this connection, you can view a better high definition picture than S-Video or AV (Composite Video) connection.</p>
<p><u>HDMI Cable</u></p> 	<p>Used for transferring digital uncompressed video and audio signals to the TV.</p> <p>HDMI signal is purely digital and provides a crystal clear technology better than component, S-Video or Video connections. It is strongly recommended to use this connection if you have this function on your equipment.</p>

Turn the power on the TV

Please follow these steps to turn the power on to the TV.

- 1) Before connecting the **Power cord**, make sure all other connections are done first.
- 2) Connect the **Power Cord** from a **Wall Outlet** to the **Power IN Port** on the back of the TV as shown below.

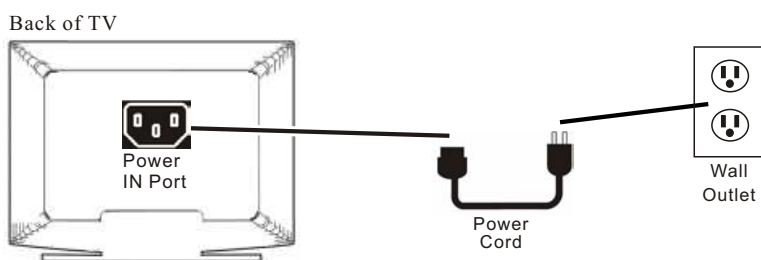

A red or blue light on the front of the TV may turn on. If so, then skip step 3 and step 4. If the light is NOT on, do Step 3.

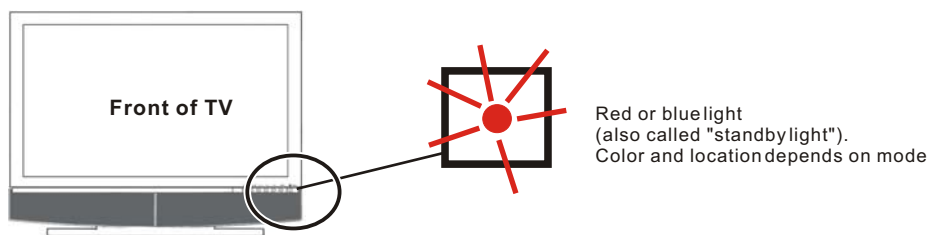

- 3) If a red or blue light on the front of the TV is **NOT** on, press the **Power Button** on the back of the TV as shown below. Now the light on the front turns on. In other words, the **Power Button** in the back must be on for the light in the front to turn on.

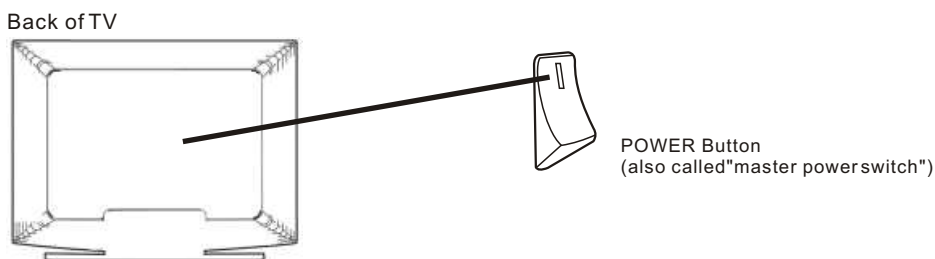

- 4) Press the **POWER Button** on the **front** of the TV as shown below or on the remote control. Wait about 10 seconds for something to appear on-screen. Your TV is on and the red or blue light on the front turns off automatically.

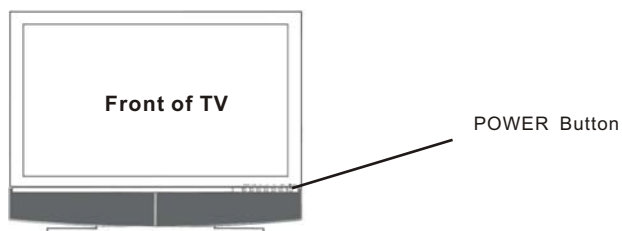

Installation

In the following pages, you will find directions on how to install your tv and choice of video equipment.

- **Connecting to an Antenna or Video Equipment with Antenna outlet**
- **Connecting to a Set-Top-Box with HDMI Cables (Preferred TV connection)**
- **Connecting to a Satellite Receiver or Cable Box with Component Connectors (Secondary Preferred after HDMI)**
- **Connecting to a DVD Player with A/V or S Video Cables**
- **Connecting to a DVD Player with Component Cables**
- **Connecting to a DVD Player with HDMI Cables**
- **Connecting to a Satellite Receiver or Cable Box with A/V Cables**
- **Connecting to a VCR, PVR, or DV with A/V Cables**
- **Connecting to a Blue-Ray DVD Player or HD-Receiver with HDMI Cables and a PC with VGA Cables**
- **Connecting to a D-VHS with HDMI Cables**
- **Connecting to a D-VHS with Component Cables**
- **Connecting to an Audio Receiver**
- **Connecting to a Home Theater System or Earphone Set**
- **Instruction for Uploading New Firmware**

Connecting to an Antenna or Video Equipment with Antenna outlet (For TV and DTV Source)

⚠ Disconnect all power sources before making any connection.

1. Connect a 75-ohm coaxial cable (or choice of Antenna Cable) from your cable or antenna to the TV's Antenna jack (RF Terminal).

For 242 / 247 / 252 / 255 TFHD Models

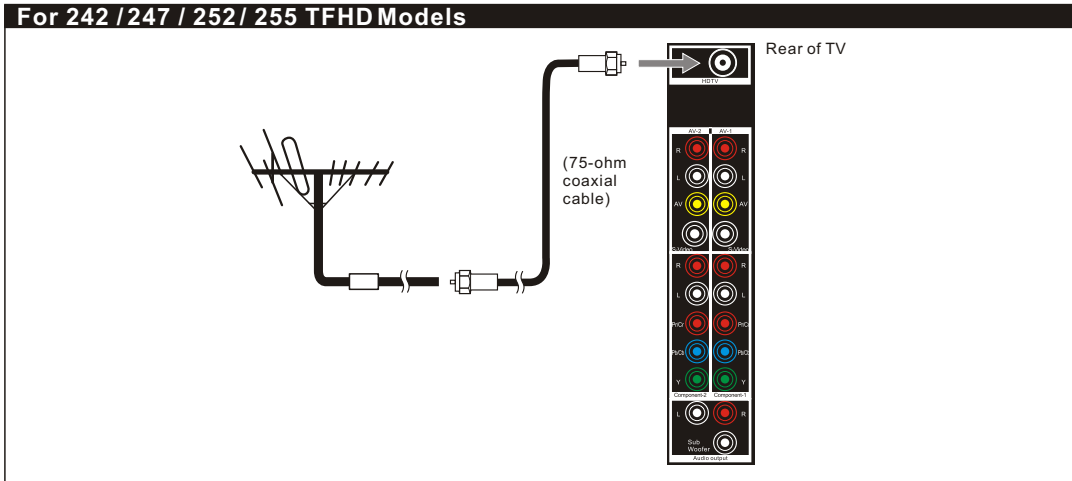

If connecting to Video Equipment with Antenna outlet

1. Connect a 75-ohm coaxial cable (or choice of Antenna Cable) from your cable or antenna to the Video Equipment's IN jack.
2. Connect another 75-ohm coaxial cable from the Video Equipment's OUT jacks to the TV's Antenna jacks (RF Terminal).

For 242 / 247 / 252 / 255 TFHD Models

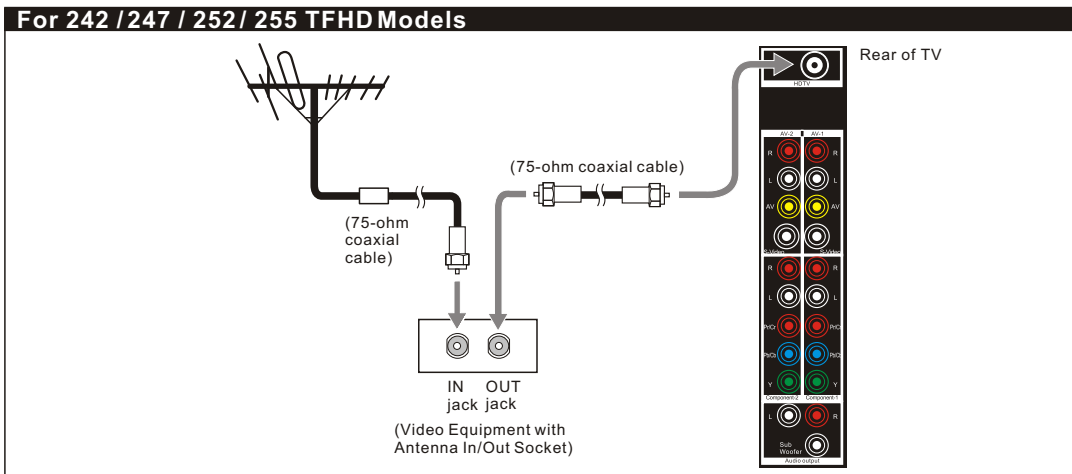

Connecting to a Set-Top-Box with HDMI Cables (Preferred TV connection)

⚠️ Disconnect all power sources before making any connection.

1. Connect a 75-ohm coaxial cable (or choice of Antenna Cable) from your cable or antenna to the Set-Top-Box's Antenna jack (RF Terminal).
2. Connect a HDMI cable from the Set-Top-Box's HDMI OUT jacks to the TV's HDMI IN jacks.

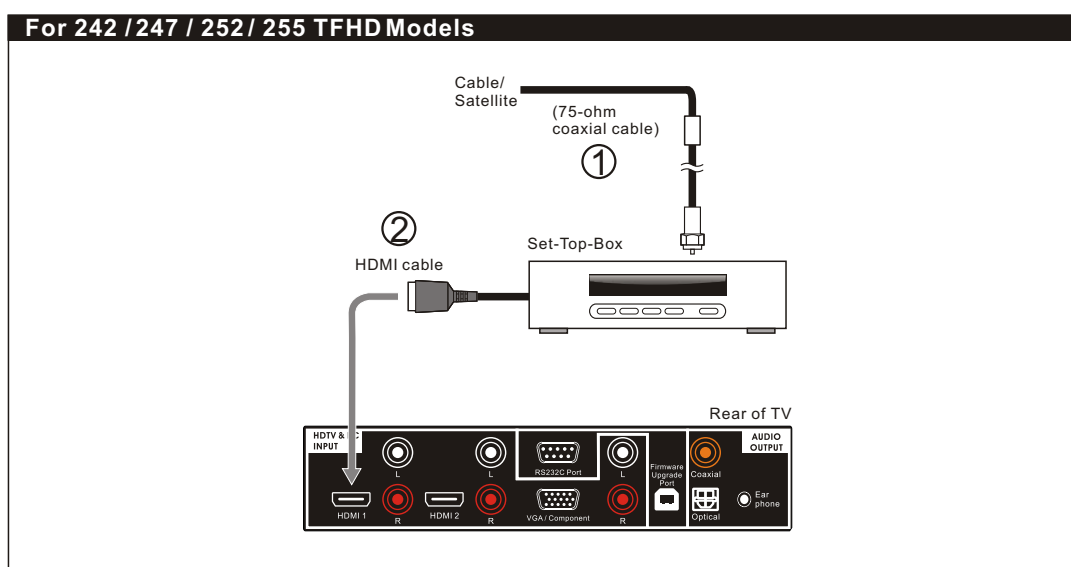

Note: HDCP is a copy protected digital connection that receives analog or digital video and audio signals from equipment with a HDMI output that features the HDCP function. HDMI allows the transfer of digital uncompressed data to the TV. This connection is superior when compared to the Component, S Video or AV (composite) connections.

Note: HDMI signal is purely digital and provides a better picture, it is better than component, S-Video or Video connections. It is strongly recommended to use this connection if you have this function on your equipment.

Connecting to a Satellite Receiver or Cable Box with Component Connectors (Secondary Preferred after HDMI)

⚠ Disconnect all power sources before making any connections.

Use this method of connection if your Satellite Receiver or Cable Box has component (Y, Pb, Pr) jacks.

1. Using a component video cable, connect the Satellite Receiver or Cable Boxes' Y, Pb and Pr jacks to the Y, Pb and Pr jacks on the TV.

Colors on Component Video connectors:

Y: Green

Pb (also identified as Cb, CB or B-Y): Blue

Pr (also identified as Cr, CR or R-Y): Red

Note: The Y, Pb and Pr jacks on your Satellite Receiver or Cable Box are sometimes labeled as Y, Cb and Cr, or B-Y and R-Y. If so, connect the cables to the matching colors.

2. Using an Audio cable, connect the Satellite Receiver or Cable Boxes' Audio OUT jacks to the TV's Audio in jacks.

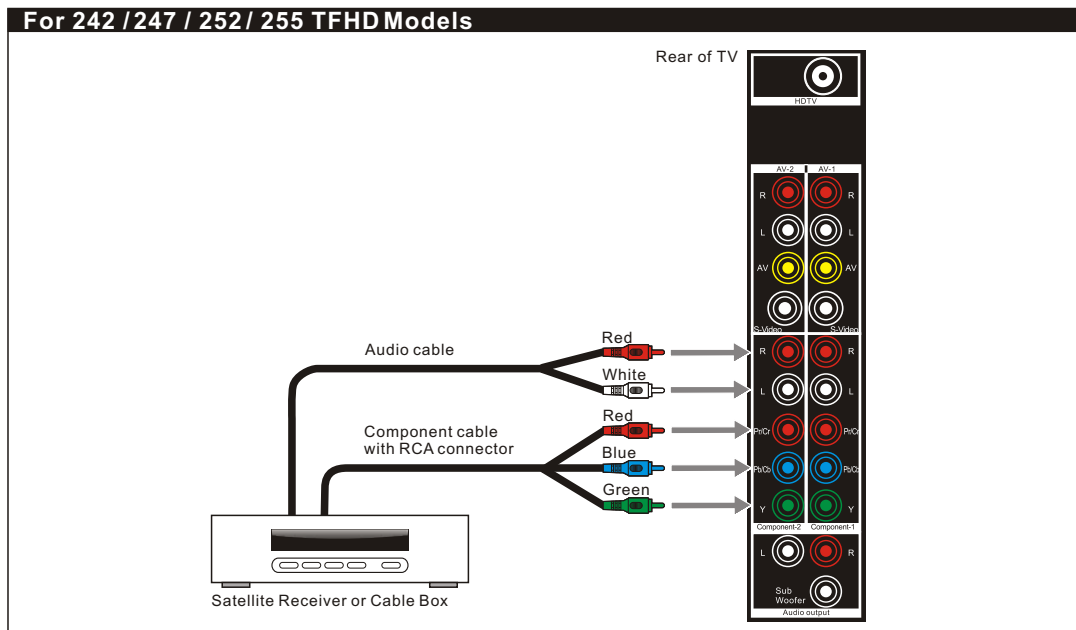

Note: The Y, Pb and Pr jacks do not provide audio, so audio cables must be connected to provide sound.

Note: The YPbPr connection provides the best quality of video signal compared to AV (composite) and S-Video connection.

Note: YPbPr is set at default to best perform with FHD 1080p content, set Input to "Interlace DVD" for best performance with regular 480i and 480p content.
(Menu - Picture - Mode - Input = "Interlace DVD")

Connecting to a DVD Player with A/V or S Video Cables

⚠ Disconnect all power sources before making any connections.

Use this method of connection if your DVD player does not have component (Y, Pb, Pr) jacks.

Note: If your DVD player has component video output connectors, for best picture quality, use the connection described for *Connecting to a DVD Player with Component Connectors*. (See page.17)

1. Using an A/V cable, connect the DVD player's Audio OUT jacks to the TV's Audio IN jacks.
2. Using an S-Video Cable, connect the DVD player's S Video OUT jack to the TV's S Video IN jack.

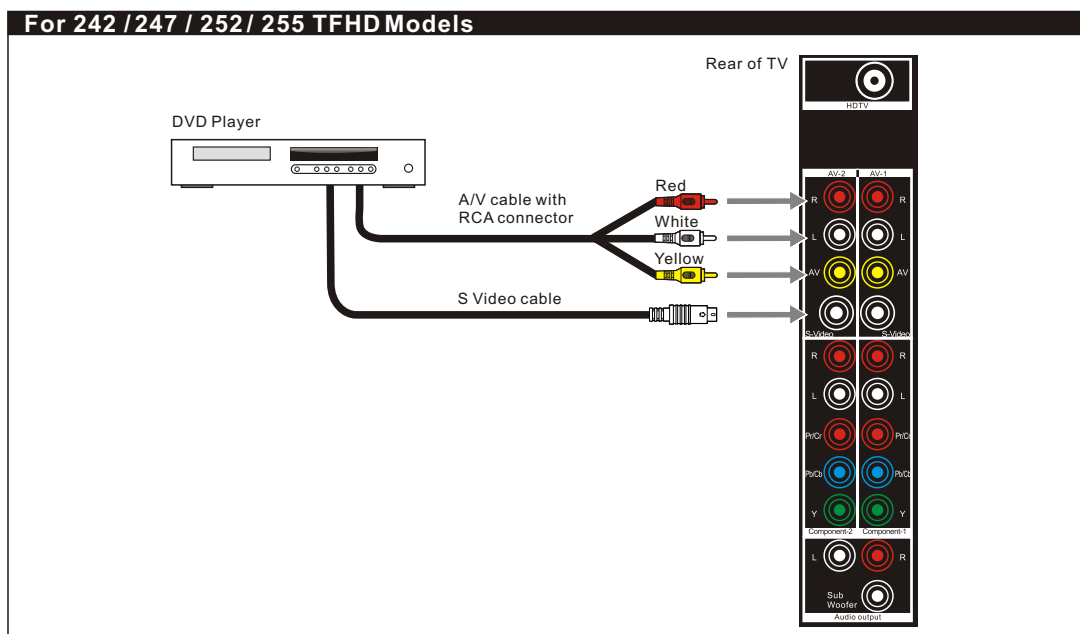

Note: When you connect video equipment to both the same Video and S-Video input jacks, the display will automatically select S-Video first.
To view Video signal, please disconnect the S-Video jack or turn off the Video signal on the video equipment.

S-Video is strongly recommended for use if your VCR or video equipment has the option.
S-Video input has better quality of picture than a composite Video signal.

Connecting to a DVD Player with Component Cables

⚠ Disconnect all power sources before making any connections.

Use this method of connection if your DVD Player has component (Y, Pb, Pr) jacks.

1. Using a component video cable, connect the DVD Player's Y, Pb and Pr jacks to the Y, Pb and Pr jacks on the TV.

Colors on Component Video connectors:

Y: Green

Pb (also identified as Cb, CB or B-Y): Blue

Pr (also identified as Cr, CR or R-Y): Red

Note: The Y, Pb and Pr jacks on your DVD player are sometimes labeled as Y, Cb and Cr, or B-Y and R-Y. If so, connect the cables to the matching colors.

2. Using an Audio cable, connect the DVD player's Audio OUT jacks to the TV's Audio in jacks.

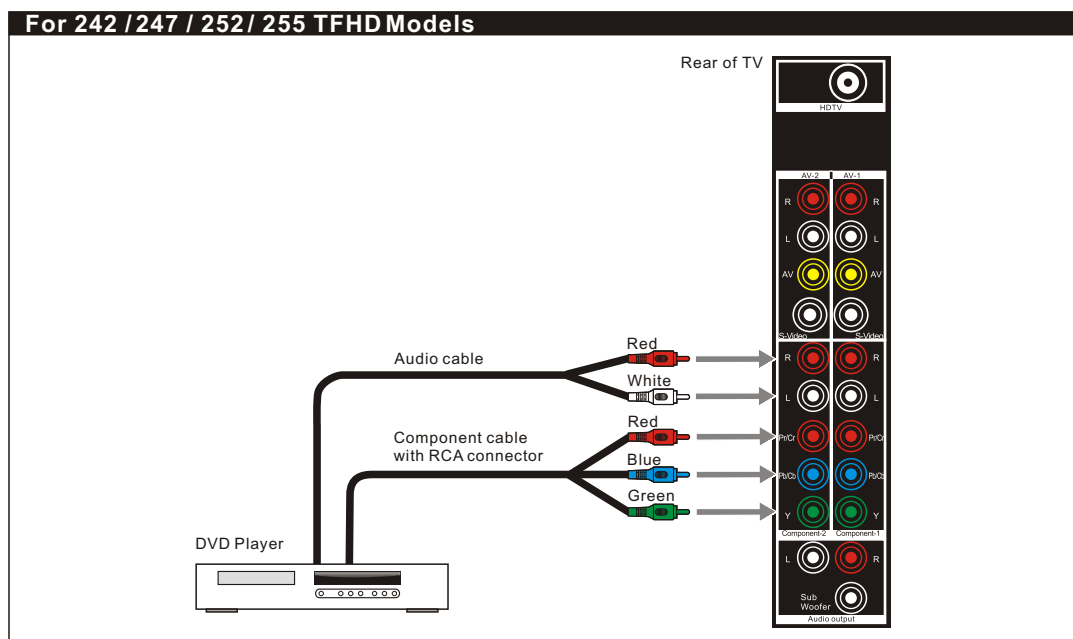

Note: The Y, Pb and Pr jacks do not provide audio, so audio cables must be connected to provide sound.

Note: The YPbPr connection provides the best quality of video signal compared to AV (Composite) and S-Video connection.

Note: YPbPr is set at default to best perform with FHD 1080p content, set Input to "Interlace DVD" for best performance with regular 480i and 480p content.
(Menu - Picture - Mode - Input = "Interlace DVD")

Connecting to a DVD Player with HDMI Cables

⚠ Disconnect all power sources before making any connections.

Use this method of connection if your DVD Player has HDMI jacks.

1. Using a HDMI cable, connect the DVD Player's HDMI output terminal to the TV's HDMI-HDCP input terminal.

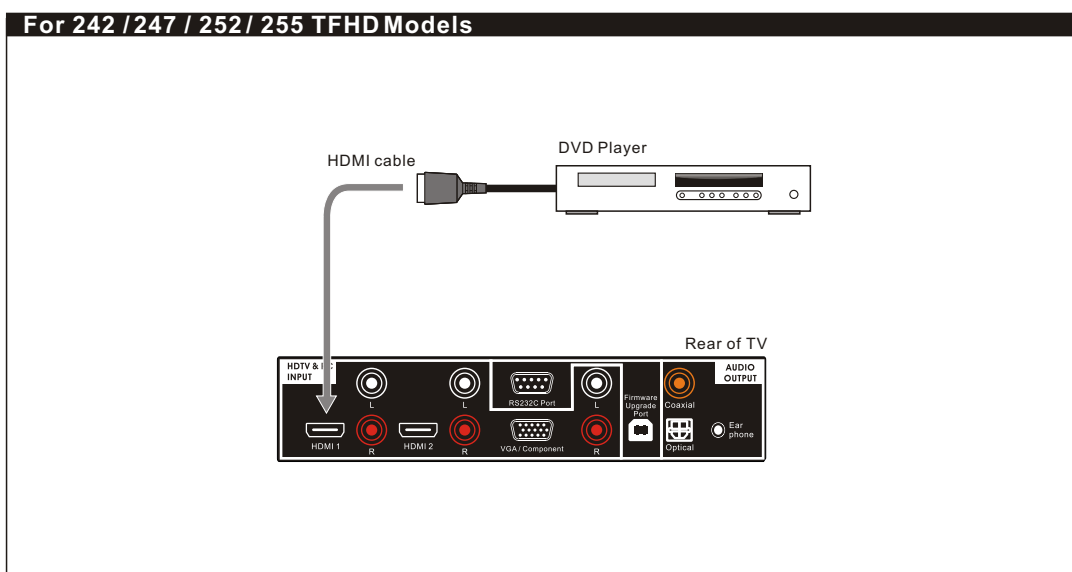

Note: HDCP is a copy protected digital connection that receives analog or digital video and audio signals from equipment with a HDMI output that features the HDCP function. HDMI allows the transfer of digital uncompressed data to the TV. This connection is superior when compared to the Component, S Video or AV (composite) connections.

Note: HDMI signal is purely digital and provides a better picture, it is better than component, S-Video or Video connections. It is strongly recommended to use this connection if you have this function on your equipment.

Connecting to a Satellite Receiver or Cable Box with A/V Connectors

⚠ Disconnect all power sources before making any connections.

1. Connect a 75-ohm coaxial cable from your Cable TV to the Satellite Receiver's or Cable Box's Ant (Antenna) jack.
2. Using Audio and S Video cables, connect the satellite receiver's Audio and S-Video OUT jacks to the TV Audio and S Video IN jacks.

For 242 / 247 / 252 / 255 TFHD Models

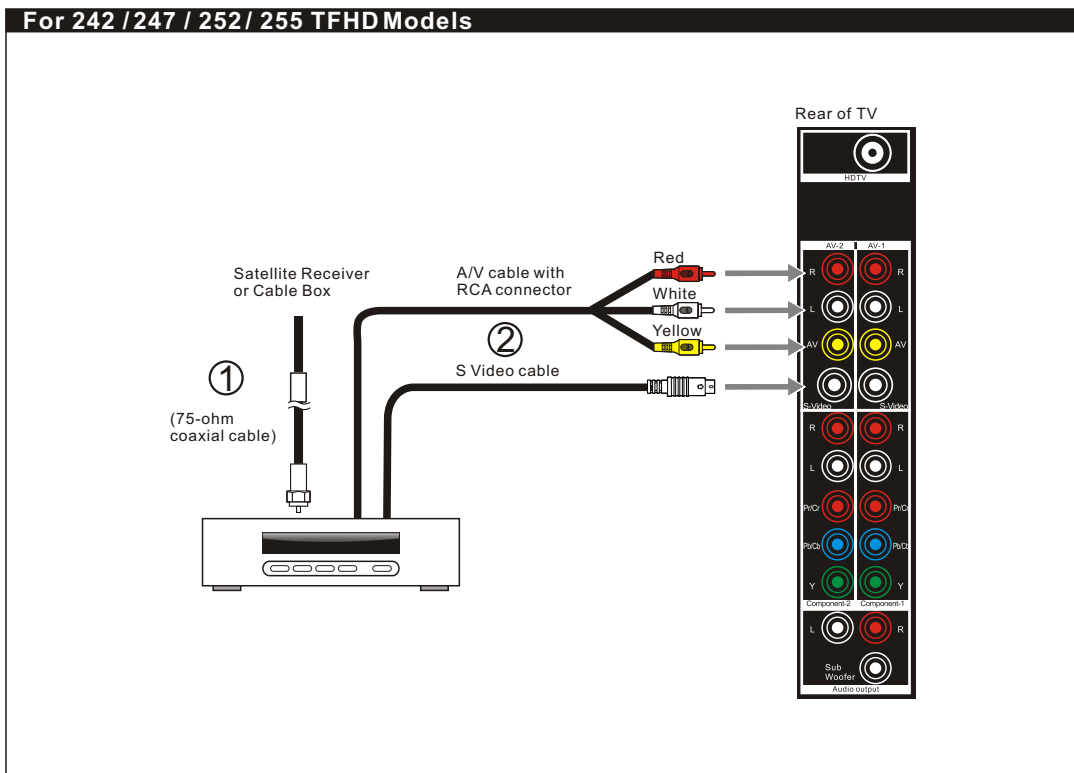

Note: When you connect video equipment to both the same Video and S-Video input jacks, display will automatically select S Video first.

To view S-Video signal, please disconnect Video jack or turn off the Video signal on the video equipment.

S-Video is strongly recommended for use if your VCR or video equipment has it because S-Video input has better quality of picture than a composite Video signal.

Connecting to a VCR, PVR, or DV with A/V Cables

⚠ Disconnect all power sources before making any connections.

1. Using A/V cable and S-Video cables, connect the video equipment's Audio and S-Video OUT jacks to the TV's Audio and S-Video In jacks.

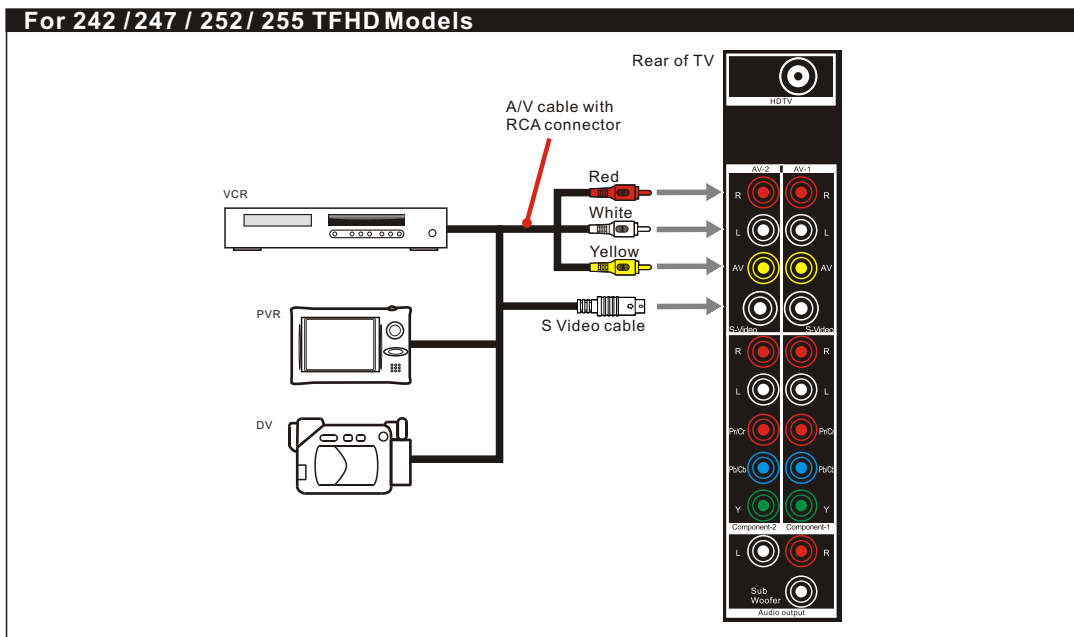

Connecting both Video IN and S-Video IN

Note: When you connect video equipment to both the same Video and S-Video input jacks, display will automatically select S-Video first.

To view Video signal, please disconnect the S-Video jack or turn off the S-Video signal on the video equipment.

S-Video is strongly recommended for use if your VCR or video equipment has it. S-Video input has a better quality of picture than a composite Video signal.

Connecting to a Blue-Ray DVD Player or HD-Receiver with HDMI Cables

⚠ Disconnect all power sources before making any connections.

1. Using a HDMI cable, connect the DVD's HDMI output terminal to the TV's HDMI-HDCP input terminal.

Note: HDCP is a copy protected digital connection that receives analog or digital video and audio signals from equipment with a HDMI output that features the HDCP function. HDMI allows the transfer of digital uncompressed data to the TV. This connection is superior when compared to the Component, S Video or AV (composite) connections.

Note: HDMI signal is purely digital and provides a better picture, it is better than component, S-Video or Video connections. It is strongly recommended to use this connection if you have this function on your equipment.

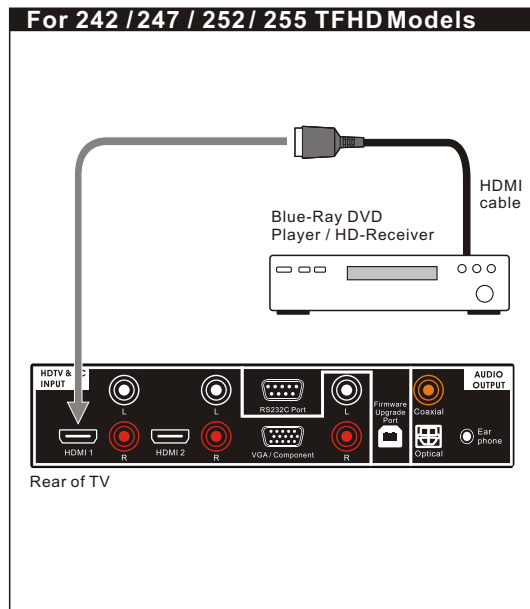

Connecting to a PC with VGA Connector

⚠ Disconnect all power sources before making any connections.

1. Using a D-Sub 15 pin cable, connect the VGA output terminal of the PC to the TV's VGA signal input terminal.
2. You may need to use a Stereo mini jack to Audio in connectors to receive audio.

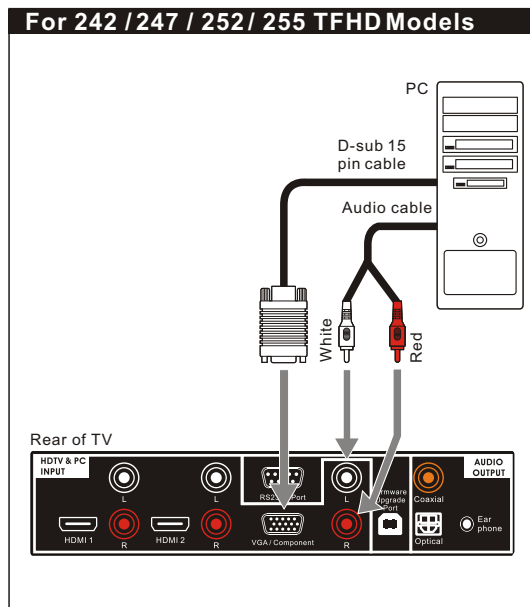

Connecting to a D-VHS with HDMI Cables

⚠ Disconnect all power sources before making any connections.

1. Connect a 75-ohm coaxial cable from your cable or antenna to the Set-Top-Box's Antenna jack.
2. Using Audio and S-Video (YPbPr, or HDMI is strongly recommended) cables, connect the Set-Top-Box's Audio and S-Video OUT jacks to the TV's Audio and S-Video IN jacks.
3. Connect an I-Link cable from the Set-Top-Box to the D-VHS equipment for video transmission and record.
4. Using a HDMI cable, connect the D-VHS's HDMI OUT jack to the TV's HDMI IN jacks for watching the recorded videos.

For 242 / 247 / 252 / 255 TFHD Models

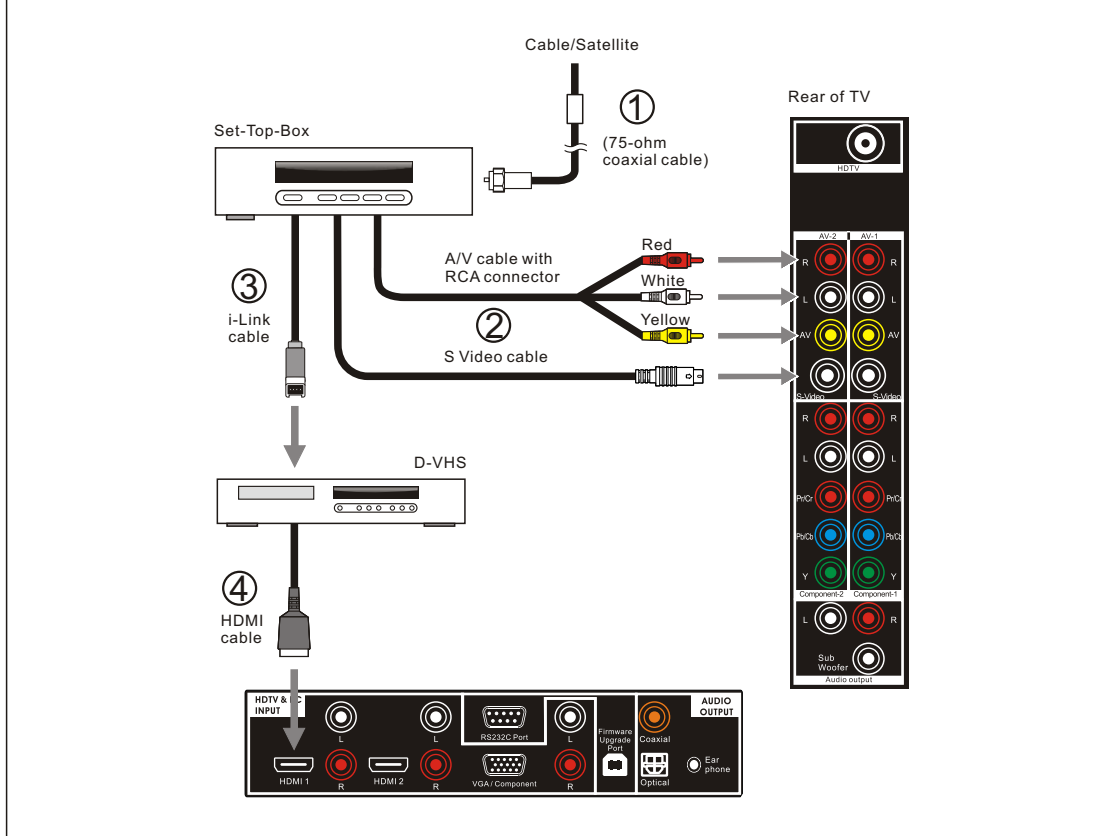

Note: HDCP is a copy protected digital connection that receives analog or digital video and audio signals from equipment with a HDMI output that features the HDCP function. HDMI allows the transfer of digital uncompressed data to the TV. This connection is superior when compared to the Component, S Video or AV (composite) connections.

Note: HDMI signal is purely digital and provides a better picture, it is better than component, S-Video or Video connections. It is strongly recommended to use this connection if you have this function on your equipment.

Connecting to a D-VHS with Component Cables

⚠ Disconnect all power sources before making any connections.

Use this method of connection if your D-VHS has component (Y, Pb, Pr) jacks.

1. Connect a 75-ohm coaxial cable from your cable or antenna to the Set-Top-Box's Antenna jack.
2. Using Audio and S-Video (YPbPr, or HDMI is strongly recommended) cables, connect the Set-Top-Box's Audio and S-Video OUT jacks to the TV's Audio and S-Video IN jacks.
3. Connect an I-Link cable from the Set-Top-Box to the D-VHS equipment for video transmission and record.
4. Using Audio and Component video cables, connect the D-VHS's Audio and Y, Pb and Pr OUT jacks to the TV's Audio and Y, Pb and Pr IN jacks for watching the recorded videos.

Colors on Component Video connectors:

Y: Green

Pb (also identified as Cb, CB or B-Y): Blue

Pr (also identified as Cr, CR or R-Y): Red

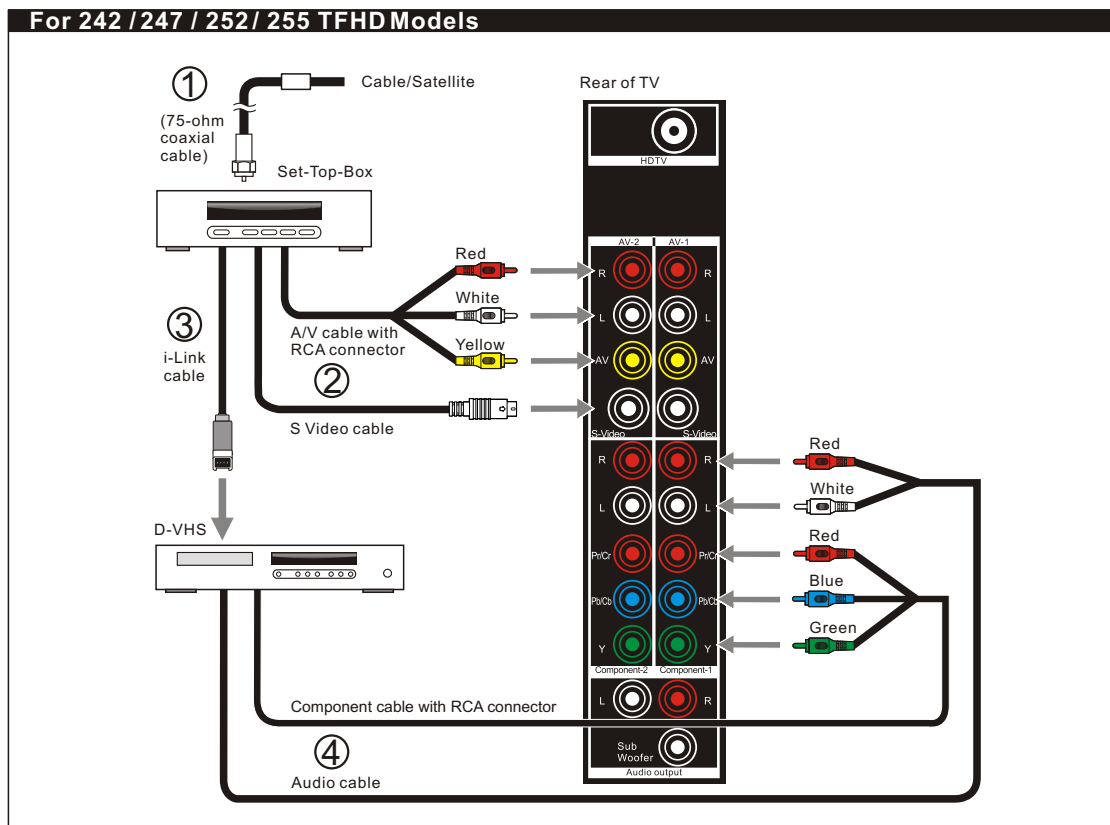

Note: The Y, Pb and Pr jacks do not provide audio, so audio cables must be connected to provide sound.

Note: The YPbPr connection provides the best quality of video signal compared to AV (Composite) and S-Video connection.

Note: YPbPr is set at default to best perform with FHD 1080p content, set Input to "Interlace DVD" for best performance with regular 480i and 480p content.
(Menu - Picture - Mode - Input = "Interlace DVD")

Connecting to an Audio Receiver

⚠ Disconnect all power sources before making any connections.

(For Analog Audio Source)

1. Using the R/L audio cable, connect the TV's audio OUT jack to the audio receiver's audio IN or AUX IN jacks.

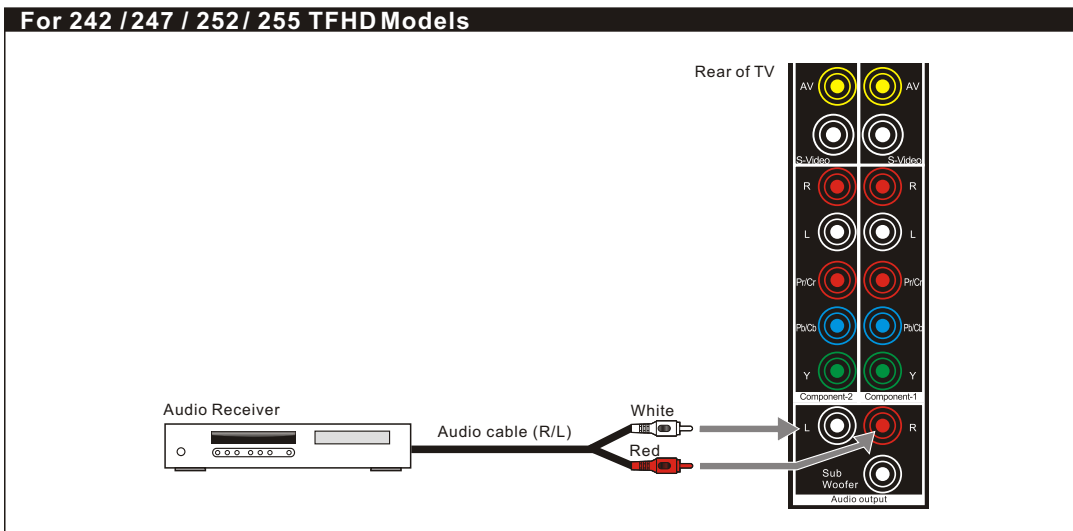

(For Digital Audio Source)

1. Using the Coaxial or Optical audio cable, connect the TV's audio OUT jack to the audio receiver's Coaxial or Optical IN jacks.

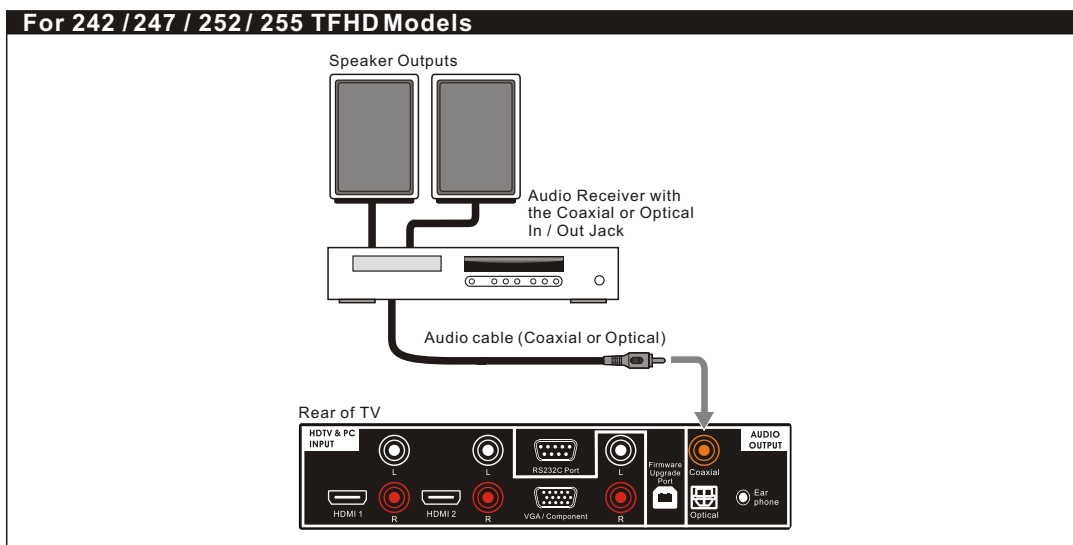

Note: Speakers must be amplified using an audio receiver such as a Home Theater System to amplify the audio from the TV.

Connecting to a Home Theater System or Earphone Set

⚠️ Disconnect all power sources before making any connections.

For 242 / 247 / 252 / 255 TFHD Models

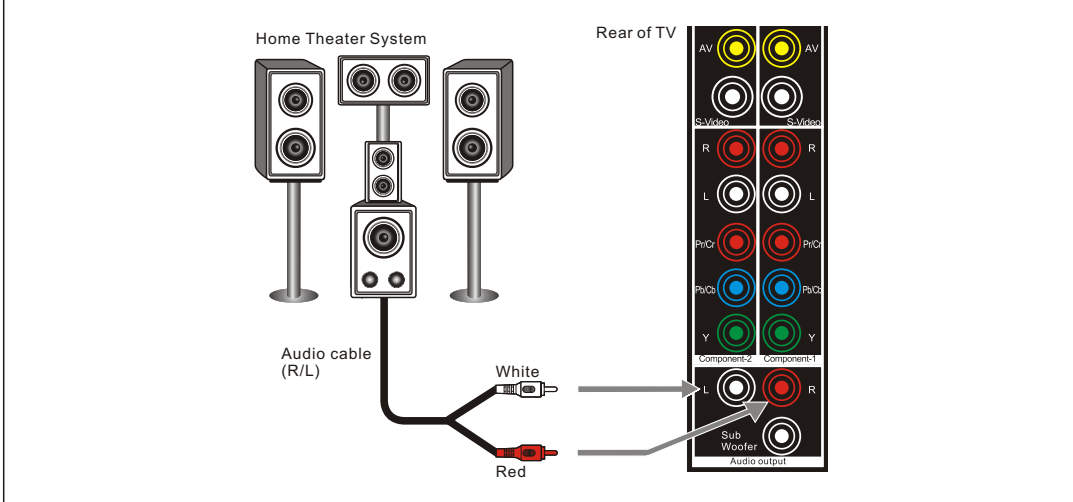

Note: When connecting an Audio output signal, an external Audio amplifier is necessary to amplify the signal for external speakers.

Note: If you connect a Home Theater Sound System, please disable the TV's speakers in the OSD by selecting off in audio section. Volume adjustment must be made on the Home Theater Receiver. By not disabling the TV's speakers it may cause the speakers or the TV itself damage.

For 242 / 247 / 252 / 255 TFHD Models

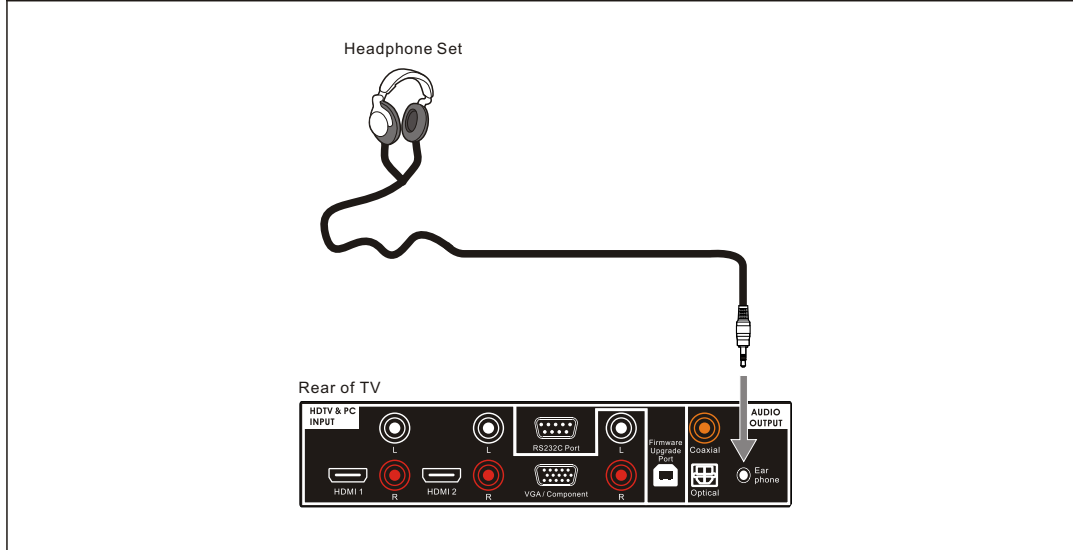

Note: When headphone is plugged in the speaker, it will turn into mute mode.

Instruction for Uploading New Firmware

1. Go to our website : www.olevia.com and register your TV.
2. Click FutureProof™ your TV. You will need the serial number of your Olevia TV and a USB flash drive.
3. Click on the instructions for your particular model of Olevia TV.

Remote Control Guide

Remote Function Keys & Description

- 1 SET** Press to activate the "Device Programming" function.
- 2 DEVICE BUTTONS** Press to select the equipment item you want to program or operate.
- 3 FREEZE** Press to freeze the picture. Press again to unfreeze the picture.
- 4 AUTO** Press to adjust screen position automatically when the screen image is not centered under VGA mode.
- 5 Other Buttons** They only can work when operating the other equipments such as DVD, or VCR device.
 1. **◀/▶ REVERSE/FAST FORWARD** Press to fast reverse/forward playback.
 2. **▶ PLAY** Press to begin a Disc play.
 3. **◀/▶ SKIP BACKWARD/FORWARD** Press to skip backward/forward the chapter, or track.
 4. **⏸ PAUSE** Press to pause a Disc play.
 5. **● Record** Press to record the chapter, or track.
 6. **■ STOP** Press to stop a Disc play.
- 6 GUIDE** Press to see the Channel Guide. *(Universal Device Only)*
- 7 DIRECTION BUTTONS:**
 1. **▲/▼** Press to select between four main sections or select the function item.
 2. **◀/▶** Press to enter to Sub-Menu, select the function item or adjust the value bar.
- 8 INFO** Press to see the current program name and relevant information.
- 9 LAST** Press to return the previous-channel.
- 10 VOL+ / VOL-** Press to adjust the volume.
- 11 NUMBER BUTTONS** Press to select channels on the display.
 1. **-** Press to select sub-channel.
 2. **ENTER** Press to confirm the channel number you enter on TV mode.
- 12 POWER** Press to turn display on/off.
- 13 LIGHTING** Press to switch the lighting mode between Dark, Medium, Bright Room.
- 14 AUDIO** Press to switch the TV Audio System between SAP, Mono or Stereo mode.
- 15 EXIT** Press to go back last OSD Menu or close OSD Menu. *(Universal Device Only)*
- 16 ENTER** Press to enter to Sub-Menu, or highlight and set up menu.
- 17 MENU** Press to activate or close the On Screen Display menu.
- 18 CH+ / CH-** Press to adjust channel up and channel down.
- 19 MUTE** Press to mute the sound.
- 20 HotKeys** Press to directly access certain Shortcut TV functions.
 1. **SOURCE** Press to switch the source input.
 2. **C.C.** Press to turn on/off the Closed Caption(CC) function.
 3. **FAVORITE** Press to select favorite channels. Can be preset in OSD Menu.
 4. **DISPLAY** Press to display the information of current channel number.
 5. **SLEEP** Press to automatically shut off the TV after a preset period of time has passed.
 6. **VIEW** Press to select and program Full Screen, PIP and Split Screen viewing options.
 7. **SWAP** Press to swap the positions of the source when in PIP or Split Screen modes.
 8. **ASPECT** Press to switch the aspect ratio between Aspect, Full, Panoramic, Zoom, 1:1 mode.

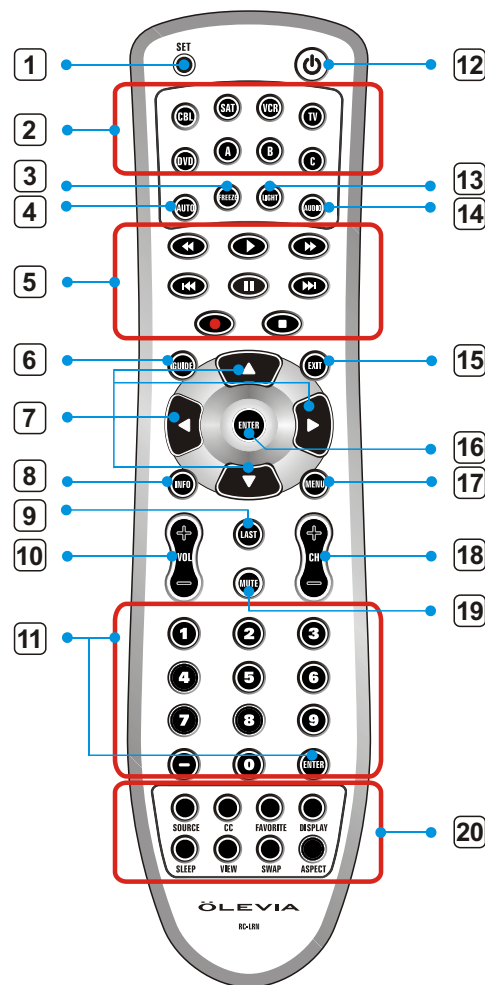

Programming the Remote Control

Programming A Device

If you have the other equipment you want to operate with the TV's remote control, do the following procedures to program the remote control.

1. Select the 5-digit code number for the equipment you want to operate from the lists on Page 69.
2. Press a device button (for example, DVD, SAT, or TV).
3. Press and hold the "SET" button until the LED indicator blinks twice.
4. Enter the 5-digit code number for your equipment by using the numeric buttons.

(Note: If there are more than one code on the list, try entering each code one by one until it is correct for the equipment.)

5. Aiming the TV's remote control at the equipment, such as STB, DVD, or VCR, and then press its "POWER" button.

(Note: If it responds, the programming is completed. If not, try the other code again following the steps above.)

Programming A Learned Key

This TV's remote control also includes a learning feature, so you can add functions that are unique to your home entertainment device, do the following procedures to program the remote control.

1. Press and hold the "SET" button until the LED indicator blinks twice.
2. Enter "9 7 5".
3. Press a device button (for example, DVD, or SAT) to assign a mode for learning.
4. Press this TV's remote control head-to-head from your original remote control.
5. On the TV's remote control, press a key where the learned function will be stored.
6. On the original remote control, press and hold a key to be learned until the LED indicator on the TV's remote control blinks twice.

(Note: For the details, please read its User's Guide carefully.)

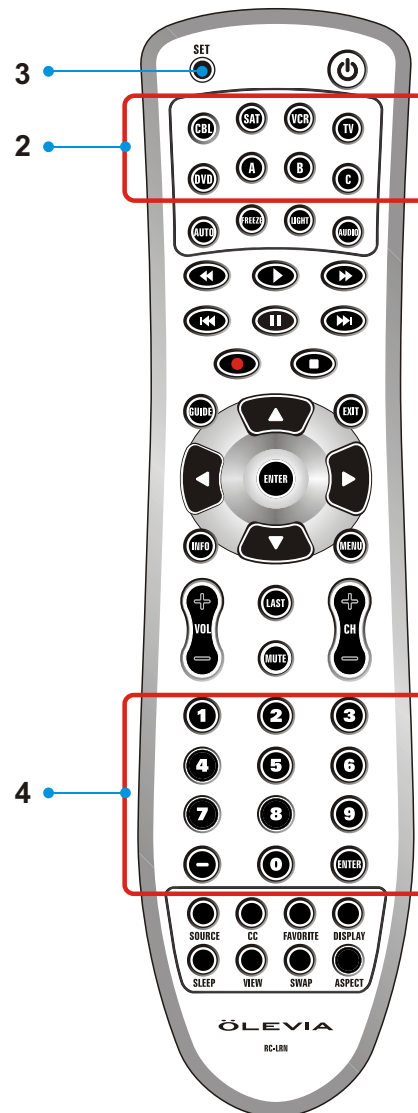

Notes : The factory default code for this TV product is 11610. To operate the other TV device, such as the Olevia LT Series models, please do the following :

1. To unlock the TV mode, press and hold the "SET" button until the LED indicator blinks twice.
2. Enter "982".
3. When the LED indicator blinks 4 times, enter the 5-digit code number, 11331, 11858, 11240, or 11144.

Battery Installation

1. Push the tab and pull it out as illustrated below.
2. Insert two size AAA batteries (supplied) by matching the (+) and (-) on the batteries into the remote control's battery department. *(Refer to Figure 1)*
3. Replace the cover back and make sure the cover "snaps" into the remote control. *(Refer to Figure 2)*

(Figure 1)

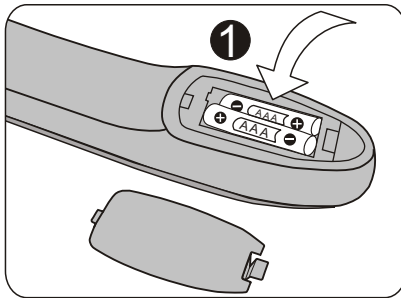

(Figure 2)

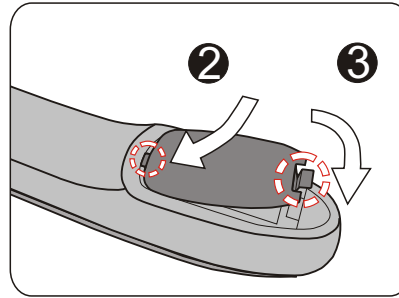

Note:

1. The display unit comes with two new AAA batteries as accessories.
However, due to uncontrollable causes, the electricity of the accessorized batteries may be partially or completely drained. We do not warrant the quality of the batteries in any case since many factors are considered. If replacement is needed, please purchase two AAA batteries.
2. Handle remote with care. Avoid dropping it, placing in direct sunlight, near a heater, high areas of humidity or getting it wet. If the remote gets wet, please wipe it dry immediately. In the event of the remote not working properly or is in operational, a replacement of remote control may be required.
3. If you do not use the remote control for a long period of time, please remove the batteries and store in a cool place to preserve battery life.
4. Do not mix new and used or with different types of batteries for operation.

On Screen Displays (OSD)



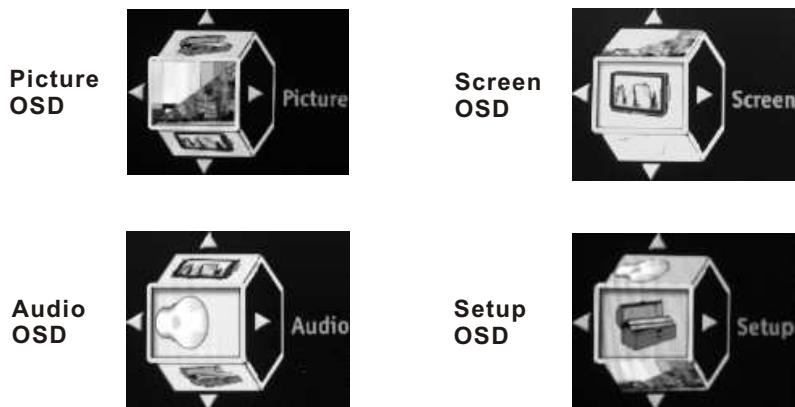

Introduction

After you have finished connecting your TV, you are now ready to choose and personalize your TV settings in the OSD (On Screen Display) menu.

There are four main sections in the OSD Menu:



Operating in the OSD

1. Press "  " button to enter OSD menu mode.
2. To select between four main sections, press the keys "▲" and "▼".
3. To enter to Sub-Menu, press the keys "◀", "▶" or "  ".
4. To select the function item, press the keys "▲", "▼", "◀", or "▶".
5. To adjust the value bar, press the keys "◀" and "▶".
6. To select and set up, press "  ".
7. To go back last OSD Menu or exit the OSD menu, press "  " again or without action for 12 seconds of inactivity.



Initial Screen

1. Selecting the OSD Language

The first time you power on the TV, there are three language formats available for the OSD Menu. You may select it by doing the following: English, Français, Español.

2. Selecting Input Source

After the Language selection, the Input Source Screen will appear for your selection.



2.1 Tuner1:

By selecting Tuner1 you must perform a channel scan by following the menu screens.

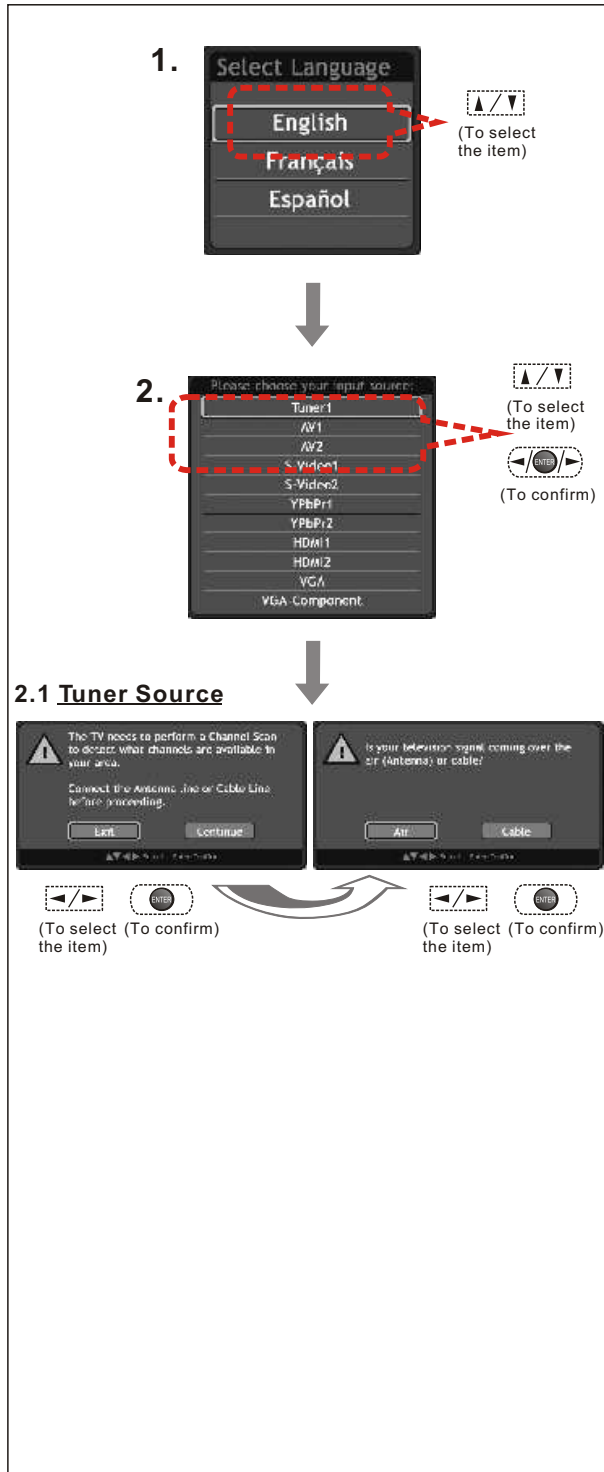

Picture OSD Adjusting TV Picture Settings

Description of Settings

Item	Adjustment	Function
Brightness		To adjust brightness contrast of the picture
Contrast		To adjust color contrast of the picture
Color temp		To adjust image color intensity
6500		
Native		To select the nature color tones of the picture
Color		To adjust the color intensity
Tint		To decrease or increase red or green tones of the picture
Sharpness		To adjust sharpness or softness of the picture
Noise Reduction	Low, Medium, High, Off	To reduce high frequency noise signal
Mode		
Lighting	Dark, Medium, Bright Room	To adjust darkness or lightness of the screen
Input	VCR, Interlaced DVD, Progressive DVD, Standard Def TV, High Def TV, User	To select the video input source with varied qualities
Power Up	Showroom, Home	To select the varied place where you operate this device
Idea		
Off		
White Peak Limiter		To limit the signal amplitude varying degree resulted in brightness over saturation
Black Level Extender		To extend "gray" to "black" color for a more accurate picture
Contrast Enhance		To enhance the contrast of the picture

Note : Your TV performs best at a Color Temperature of 6500. Follow the Four Steps to properly set your display Color Temperature to 6500.

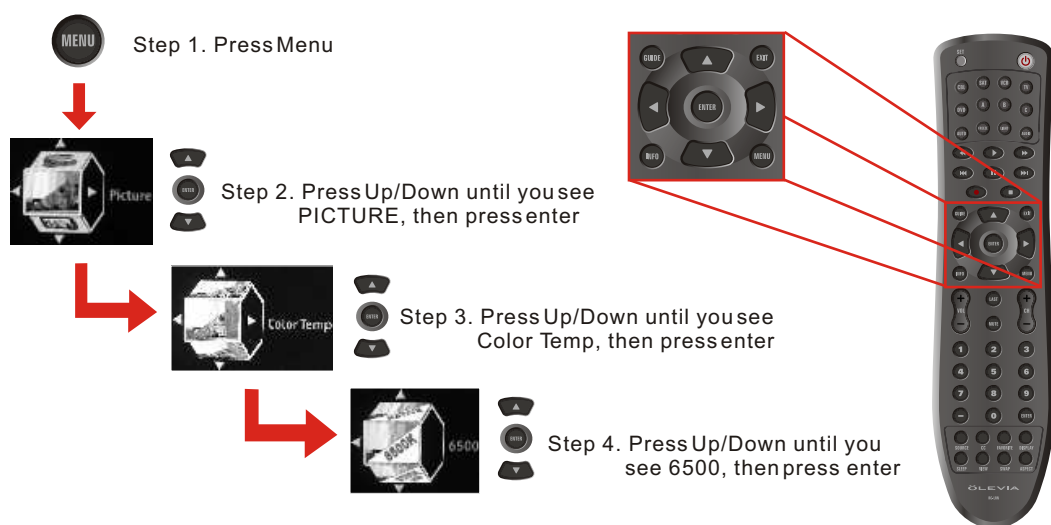

Selecting the Picture Mode

➤ Mode

In this "Mode" Index, you can select one of the picture modes which is suitable for the program you are watching.

Lighting :

To adjust darkness or lightness of the screen

- * **Dark Room** : To darken the screen
- * **Medium Room**
- * **Bright Room** : To brighten the screen

Input :

To select the video input source with varied qualities

- * **VCR**
- * **Interlaced DVD**
- * **Progressive DVD**
- * **Standard DefTV**
- * **High DefTV**
- * **User**

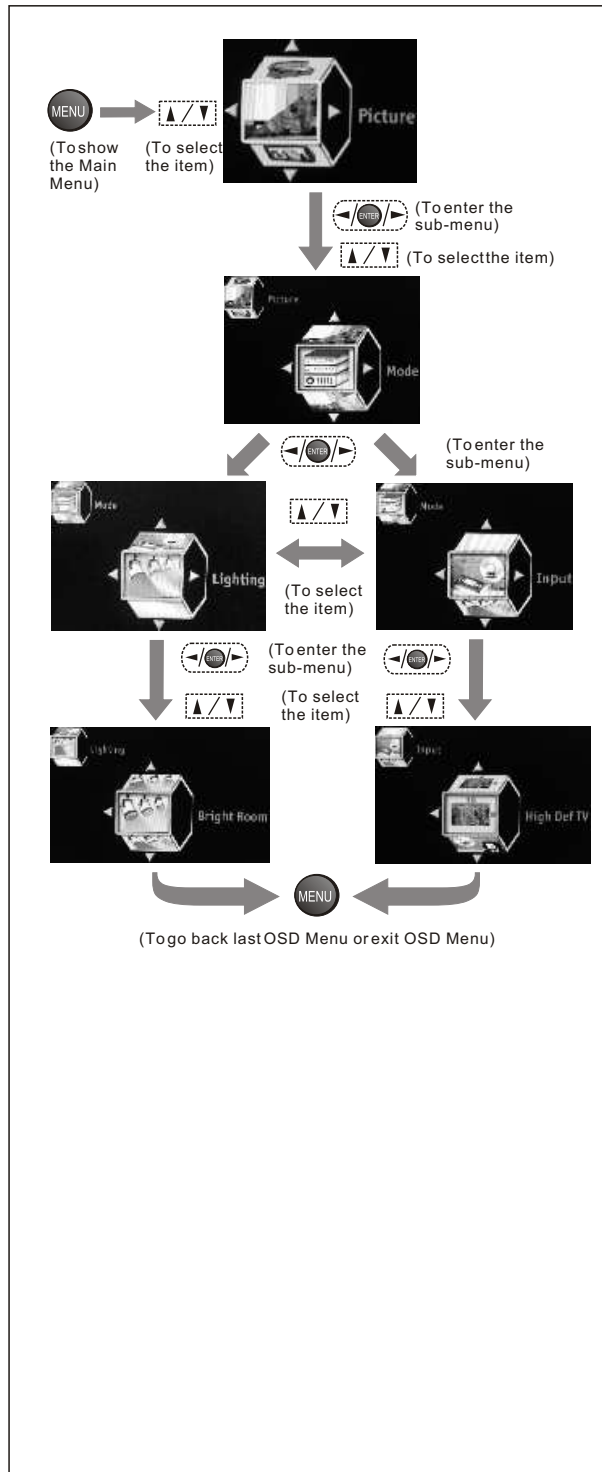

Power Up :

Selects the most appropriate setting for your TV. (Read carefully, modes effect TV performance.)

*** Showroom (Demo) :**

This mode is available for businesses that will use the TV to demonstrate in their stores. (Notes : This mode blocks most OSD settings.)

*** Home (Normal Use) :**

This mode provides the best settings to view the TV for regular use.

Disable Showroom Mode and Enable Home Mode

(Follow these 4 steps to activate Home Mode)



Step 1. Press **Menu** and Scroll up/down to "**Picture**" and press the "**Enter or Right Arrow key**".



Step 2. Scroll up/down to "**Mode**" and press "**Enter or Right Arrow key**".



Step 3. Scroll up/down to "**Power Up**" and press "**Enter or Right Arrow key**".



Step 4. Scroll up/down to "**Home**" and press "**Enter or Right Arrow key**" to activate **HOME MODE**.

Congratulations!
You are in Home Mode.

Adjusting the Video or Picture Quality

In this Setup Index, you can adjust the video and picture settings to suit your personal preferences.

- **Brightness**
To darken or brighten the picture
 - **Contrast**
To reduce (soften) or enhance (deepen) color contrast of the picture
 - **Color**
To decrease or increase color intensity of the picture
 - **Tint**
It allows you to decrease or increase red or green tones of the picture.
 - **Sharpness**
To soften or sharpen the picture
 - **Color Temp**
To customize the RGB settings
- 6500** (recommended)
- Native :**
To select the nature color tones of the picture

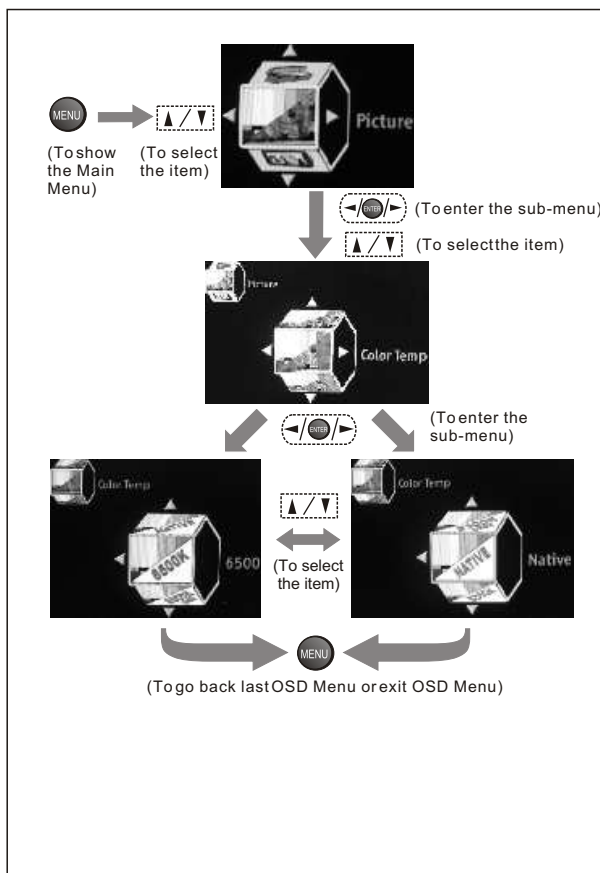
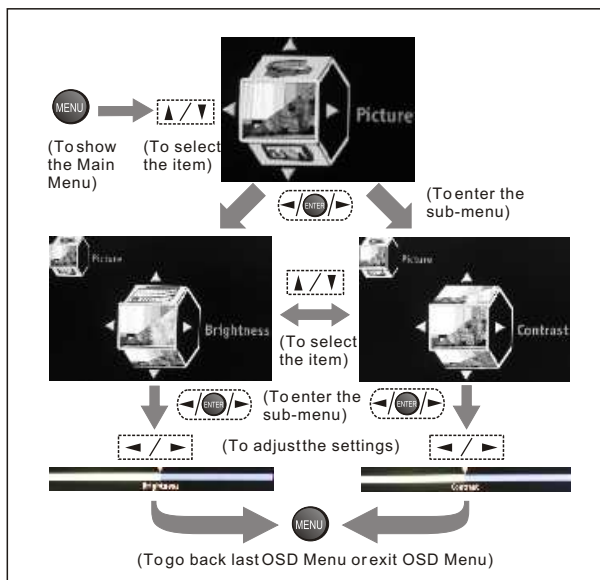

➤ Noise Reduction

Select Low/Medium/High to reduce noise.

Low : To reduce parts of noise(recommended)

Medium : To reduce half of noise

High : To reduce most of noise

Off : Dynamic Noise Reduction is disable.

➤ Idea

Off :
To disable this function(recommended)

White Peak Limiter :
Limits the signal amplitude varying degree resulted in brightness over saturation.

Black Level Extender :
Extends "grays" to black so a more accurate picture is produced with a wider contrast scale.

Contrast Enhance :
Enhances the contrast of the picture.

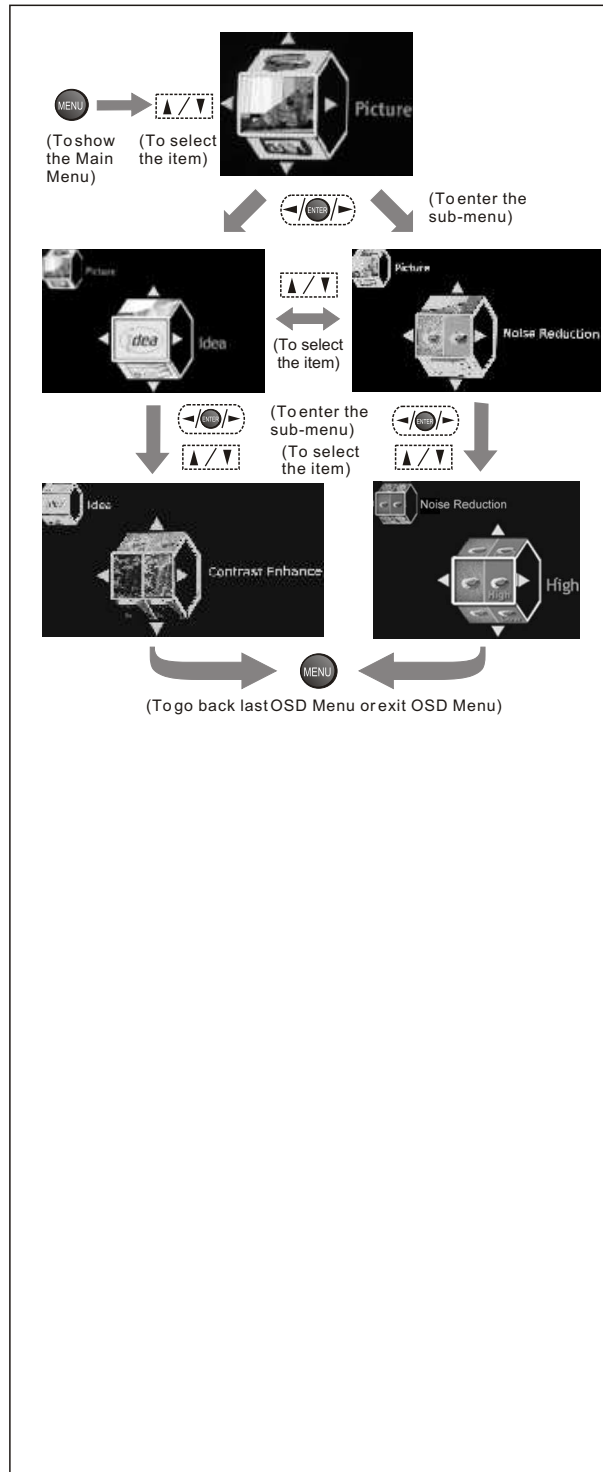

Audio OSD Adjusting Sound Quality

Description of Settings

Item	Adjustment	Function
Treble		It allows to adjust higher pitched sounds.
Bass		It allows to adjust lower pitched sounds.
Balance		It allows to adjust volume balance of the R/L speakers for the best stereo reproduction.
Language	English, Français, Español	There are three language formats available for program broadcasting.
MTS (Multi-channel Television Sound)	Mono, SAP, Stereo	It allows to select the sound reception of stereo, bilingual and mono programs between the TV Audio System.
Mute	On, Off	It allows to mute the sound.
Speaker	On, Off	It allows to turn On/Off the speakers of the TV when using a Receiver or Home Theater System.
iDIVA	Off, Rock, POP, Live, Classic, Soft, Concert, Living Room, Hall, Arena, Church	It allows to select the sound effect as occurred in an enclosed space of varying spaces.
Lip Sync		It allows to properly synchronize the audio and video.

Adjusting the Audio Settings

In this Setup Index, you can adjust the audio settings to suit your personal preferences.

- **Treble**
Decreases/Increases high pitch sounds.
- **Bass**
Decreases/Increases low pitch sounds.
- **Balance**
Adjusts volume to R/L speakers for the best stereo reproduction.
- **Language**
There are three language formats available for program broadcasting. You may select from: English, Español, Français. *(Digital TV Channel Only)*
- **Mute**
Mutes sounds.
- **Speaker**
Turns TV speakers On/Off when using Home Theater System.

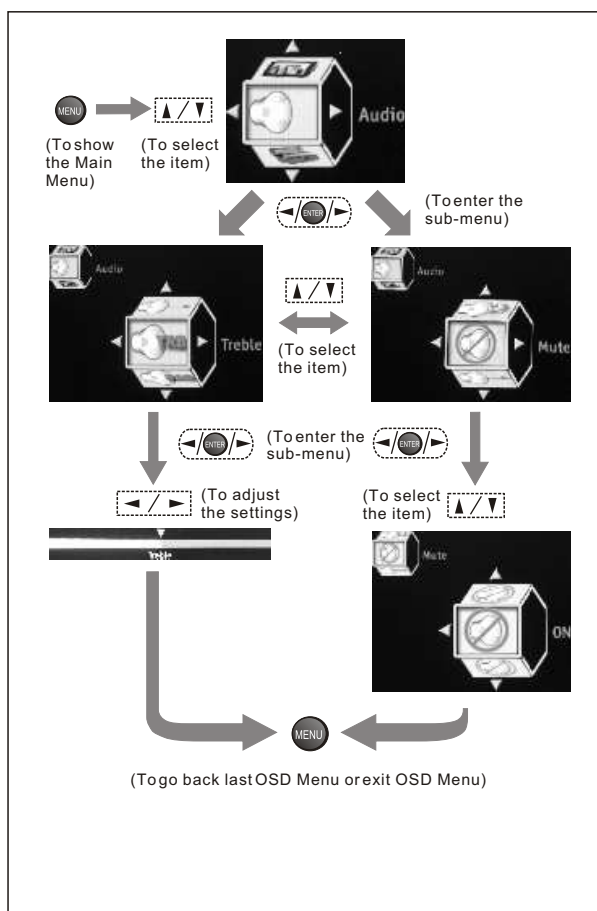

➤ **iDIVA**

It allows to select the sound effect as occurred in an enclosed space of varying spaces.

Off : To disable this function

Rock :

POP :

Live :

Classic :

Soft :

Concert :

Living Room :

Hall :

Arena :

Church :

➤ **Lip Sync**

When the sound and picture do not match and the sound is heard too early, use this setting to properly synchronize the audio and video.

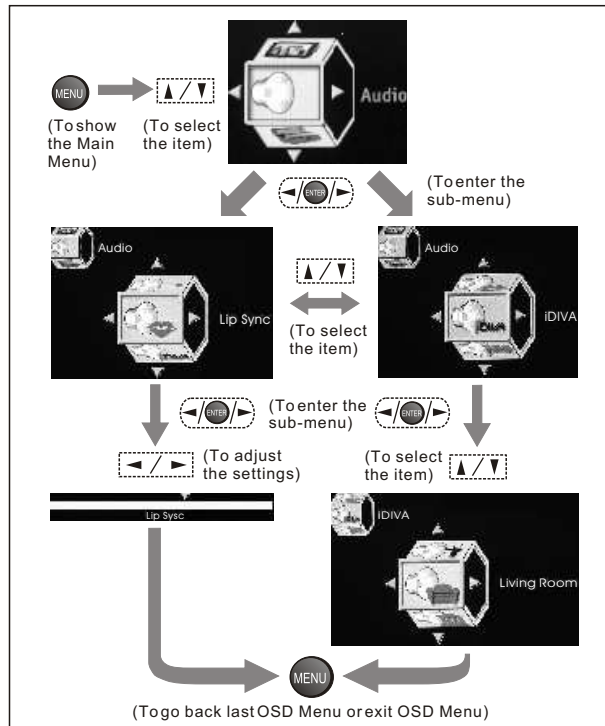

MTS System for Stereo TV

In this Setup Index, you can adjust the audio settings to suit your personal preferences.

➤ **MTS**

Toggles audio through Stereo, SAP and Mono.

Mono :

Selects Mono reception. (Uses to reduce noise during weak stereo broadcasts)

SAP :

Selects audio to Secondary Analog Program. (If no SAP signal is present, the TV remains in Stereo Mode)

Stereo :

Selects Stereo reception when viewing a program.

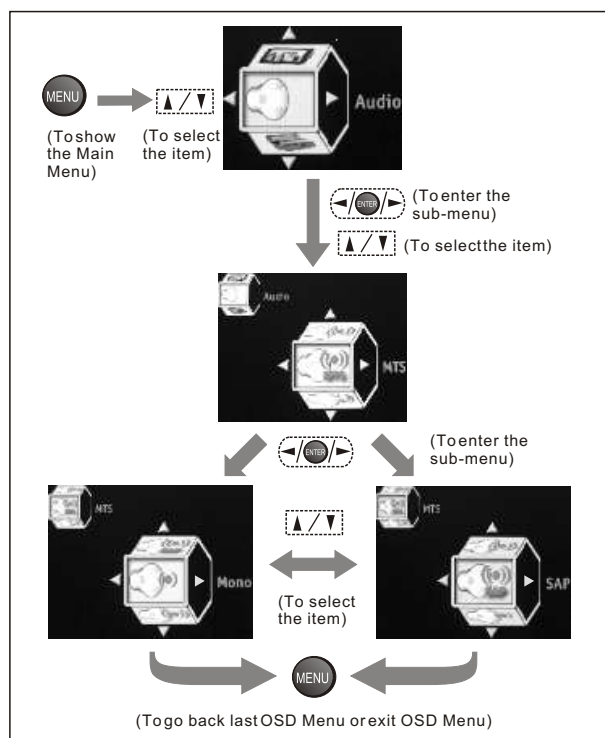

Screen OSD Adjusting Screen Modes

Description of Settings

Item	Adjustment	Function
Adjustment		
H.Position		It allows you to adjust the picture position horizontally.
V.Position		It allows you to adjust the picture position vertically.
Fine Tune		It allows you to enhance the picture quality.
Auto Sync		
Aspect Ratio	Aspect, Full Screen, Panoramic, Zoom 1, Zoom 2, 1:1 Mode	It allows you to select the aspect ratio of the picture you are watching.
Cropping	On, Off (Off, Minimum, Medium, Maximum)	Crops image and then enlarges it to fill the screen.
View	Full Screen, PIP, Split Screen	It allows you to select the view types of picture modes.
PIP Position	Low Right, Low Left, Upper Right, Upper Left	It allows you to change the position of Picture 2.
PIP Size	Small, Medium, Large	It allows you to change the size of Picture 2.
Swap		It allows you to switch the position of Picture1 and Picture2.
Main Picture Source	Tuner1, Composite1/2, S-Video1/2, Component1/2, HDMI1/2, VGA, VGA-Component	It allows you to select the main picture or video source you want to view.
Sub Picture Source	Tuner1, Composite1/2, S-Video1/2, Component1/2, HDMI1/2, VGA, VGA-Component	It allows you to select secondary picture or video source you want to view.

Changing the Screen Mode

In this Setup Index, you can adjust the screen settings to suit your personal preferences.

➤ Adjustment (Analog Source Only)

Adjusts the picture position and its quality.

H.Position :

Moves the picture left and right in the "Full Screen, Panoramic, and Zoom" modes.

V.Position :

Moves the picture up and down in the "Full Screen, Panoramic, and Zoom" modes.

Fine Tune:

Enhances picture quality by reducing horizontal flickering.

Auto Sync :

Adjust the image to its best position and automatically displays on the screen.
(VGA mode only)

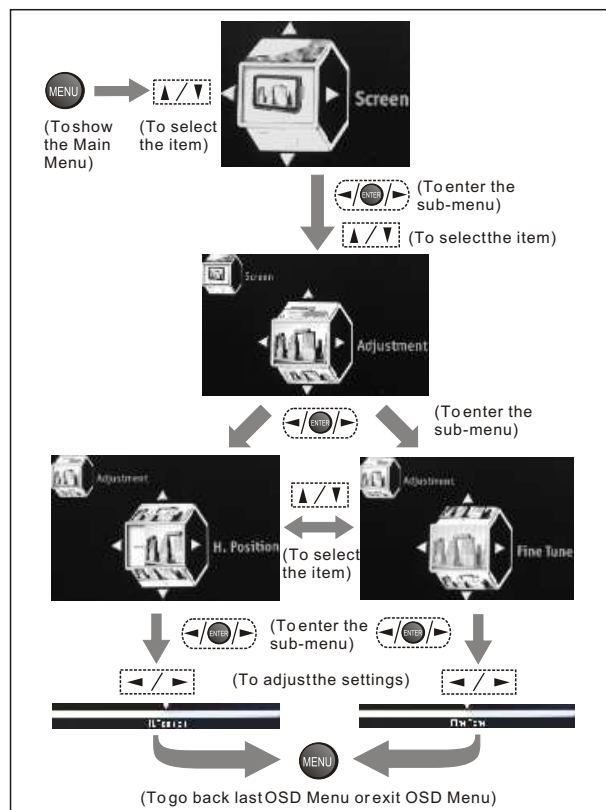

➤ Aspect Ratio

It allows you to select the aspect ratio of the picture you are watching.

Aspect :

Toggles picture between 16:9/ 4:3 aspect ratio.



Full Screen :

Enlarges a 4:3 picture to fill the 16:9 screen.



Panoramic :

Enlarges a picture from 4:3 to 16:9 by stretching it horizontally.



Zoom 1 :

Stretches the image both horizontally and vertically.



Zoom 2 :

Stretches the image both horizontally and vertically, which will lose part of the image on both ends.



1:1 Mode :

Returns the image to its original mode.

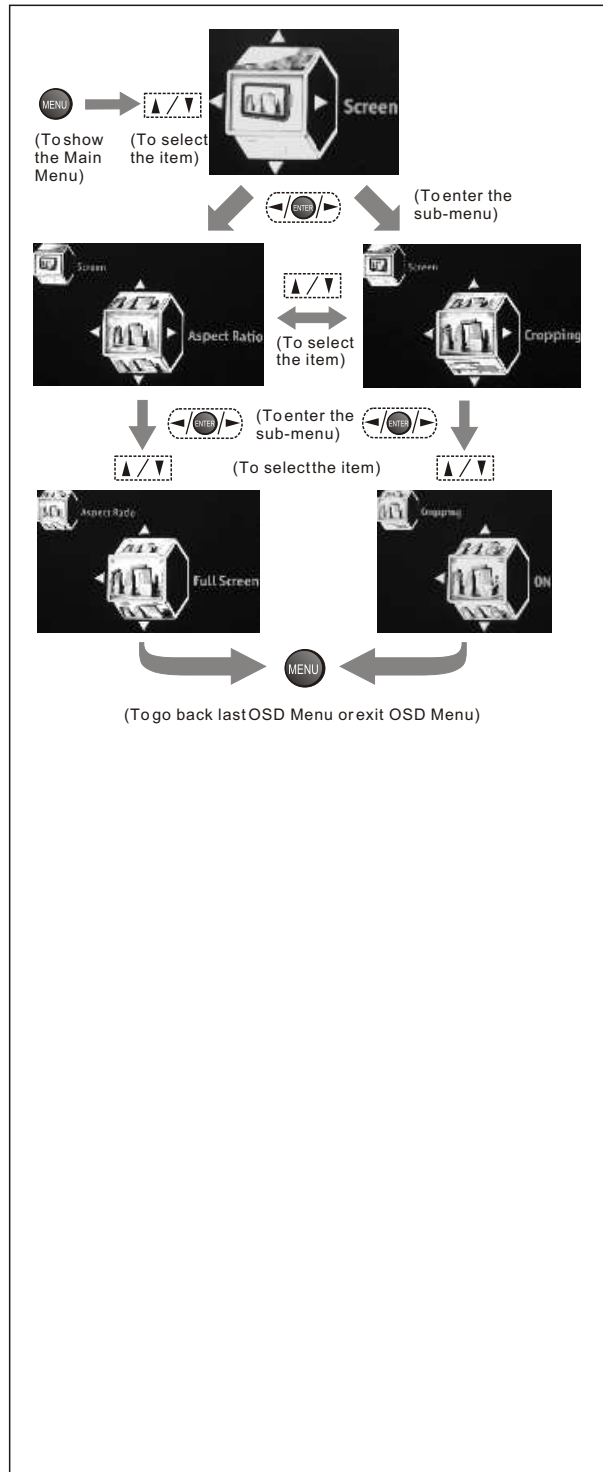
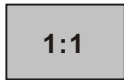

➤ **Cropping Method 1**

Crops 16 pixels on R/L edge of image, 8 lines on top/bottom edge of image, and then enlarges it to fill the screen.
(For all sources except Tuner source)

On : (recommended)
Off :

➤ **Cropping Method 2**

Crops image, and then enlarges it to fill the screen. (Tuner Source Only)

Off :

Minimum : To crop 16 pixels on the R/L edge of image, 8 lines on the top/bottom edge of image (recommended)

Medium : To crop 24 pixels on the R/L edge of image, 16 lines on the top/bottom edge of image

Maximum : To crop 32 pixels on the R/L edge of image, 24 lines on the top/bottom edge of image

(Note: This feature helps remove any noise visible under both vertical and horizontal edges of the image.)

➤ **View**

You can select three view types of picture modes that best suits the program you are watching. You can set a different view mode for each video mode for each input and store it manually.

Full Screen :

Enlarges the image to full the screen.

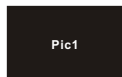

PIP :

Picture-in-Picture has a Main screen and small screen view. Connected to two input sources. PIP is available on selected models.

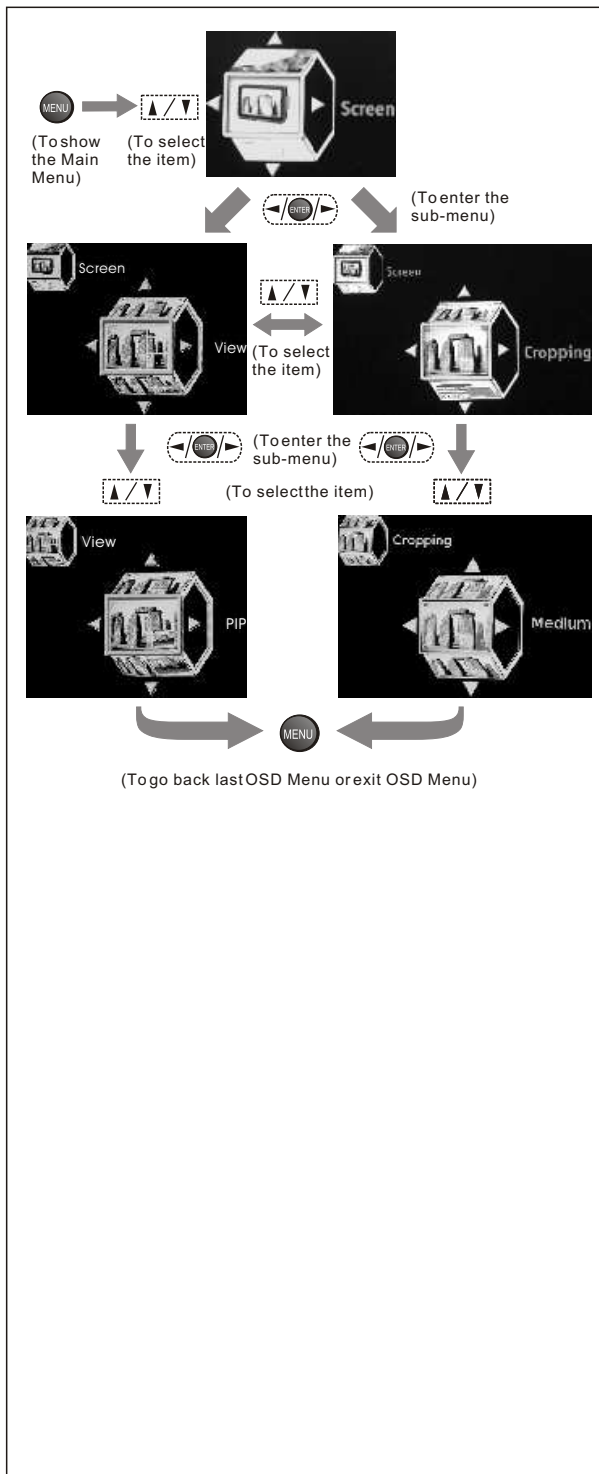
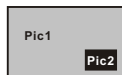

Split Screen :

Full Screen splits in two Views.



➤ **PIP Position**

Changes the position of Picture 2 (small screen view).

Low Right :



Low Left :



Upper Right :

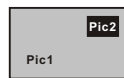

Upper Left :



➤ **PIP Size**

Changes the size of Picture 2 (small screen view).

Small :

Medium :

Large :

➤ **Swap**

Switches the position of Picture 1 and Picture 2.

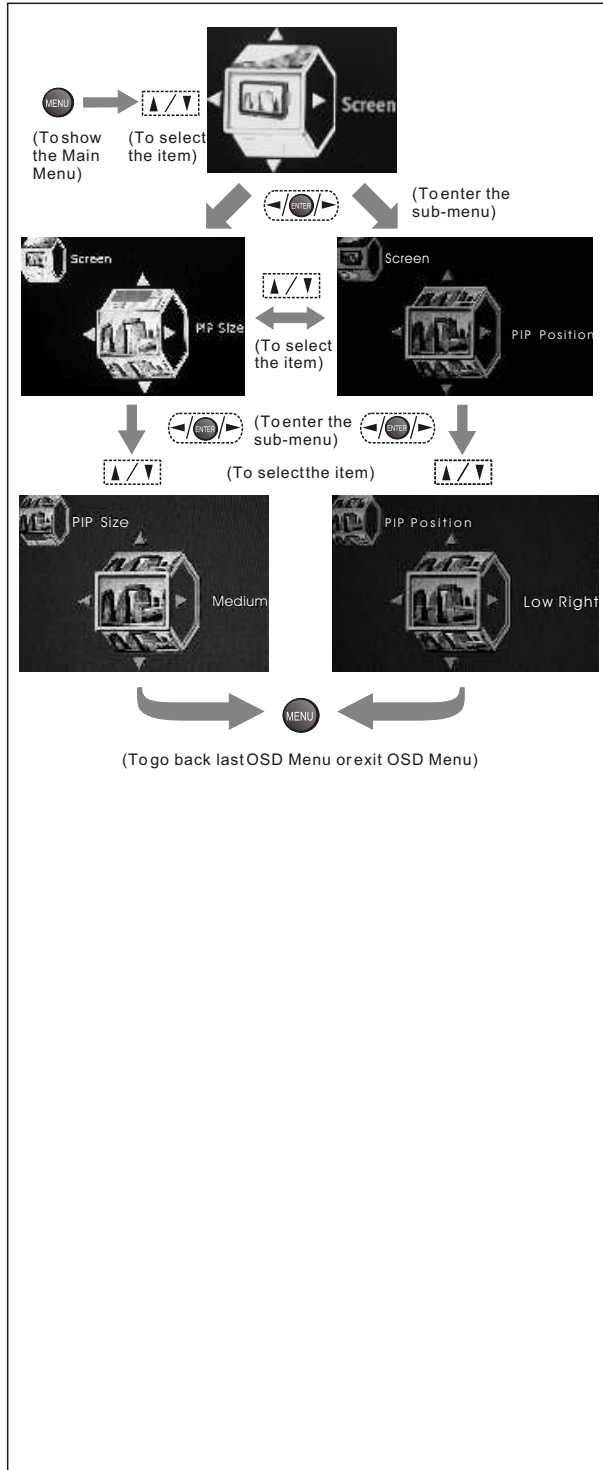

Selecting the Picture or Video Source

In this Setup Index, you can select the input source of the picture or video you want to view.

➤ Main Picture Source

It allows you to select and view the main picture or video source from optional video equipment connected to this unit by selecting the appropriate input source.

Tuner 1 :

Composite 1/2 :

S-Video 1/2 :

Component 1/2 :

HDMI 1/2 :

VGA :

VGA-Component :

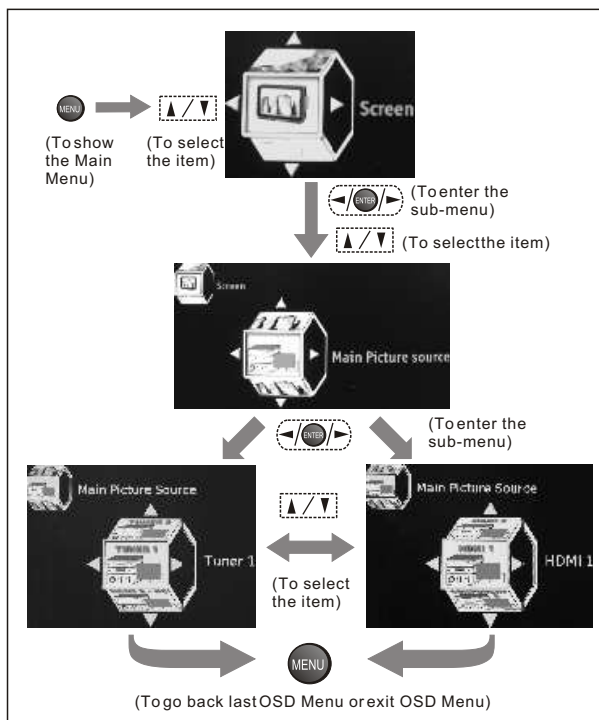

➤ Sub Picture Source (PIP)

It allows you to select and view the secondary picture or video source from optional video equipment connected to this unit by selecting the appropriate input source. *(In PIP and Split Mode Only)*

Tuner 1 :

Composite 1/2 :

S-Video 1/2 :

Component 1/2 :

HDMI 1/2 :

VGA :

VGA-Component :

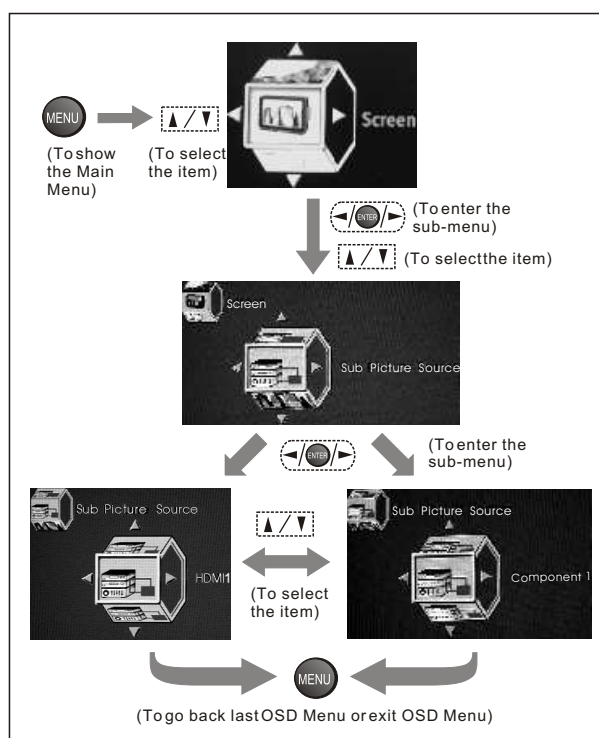

Setup OSD Adjusting Personal TV Settings

Description of Settings

Item	Adjustment	Function
TV		
Channel Setup	Favorite, Skip, Name	It allows you to set up Channel functions.
Auto Channel Search	Cable Standard, Air	It can auto scan the available channels of the TV or CATV.
Channel Add		It allows you to add channels to your favorite channel list.
Closed Caption		It allows you to select the Closed Caption type shown on the TV program.
Analog Type	CC1~4, T1~4	
Digital Type	Off, CS1~6	
Font	As Broadcaster, Stype1~7	
Size	As Broadcaster, Large, Medium, Small	
Font Color	Black, White, Green, Blue, Red, Cyan, Yellow, Magenta	
Background Color	Black, White, Green, Blue, Red, Cyan, Yellow, Magenta	
Parental Control		
Enter Password		
Rating	On, Off	
MPAA Rating	G, PG, PG-13, R/NC-17, X	
Block Unrating	On, Off	
TV Rating	TV-Y, TV-Y7, TV-Y7-FV, TV-G, TV-PG(V,S,L,D), TV-14(V,S,L,D), TV-MA (V,S,L)	
Canada English Rating		
Canada French Rating		
Channel Block		
Change Password		
Timers	Sleep	It can be set to turn on / off the TV automatically at the set time.
Date and Time		It allows you to set the information of "Date and Time".
Menu Timeout	10, 20, 30	It can be set to shut off the TV automatically after a preset period of time has passed.
Language	English, Français, Español	It allows you to set the OSD Menu language.
DPMS	On, Off	TV and Backlight will shut off automatically when no video source is detected when DPMS is active.
LED Settings	On, Off	It can be set to turn on / off the LED Light on the front panel of the TV.
Factory Settings		It can reset all parameters in OSD Menu Mode for all input sources.
Factory Settings by Input		It can reset all parameters in OSD Menu Mode for the source you select currently.
Firmware Version		You can see the firmware version here that installed in the HDTV unit.

Searching the TV Channels

In this Setup Index, you can pre-search all channels before watching the programs.

➤ Auto Channel Search

Will scan and preset all receivable channels automatically.

Cable :

Selects cable if using tuner as the input.

- * Auto
- * Standard
- * HRC
- * IRC

Air :

Selects air if using antenna.

(NOTE: The Auto Scan is set to scan cable TV channels by default. You cannot receive and set the cable TV channels and VHF/ UHF channels at the same time.)

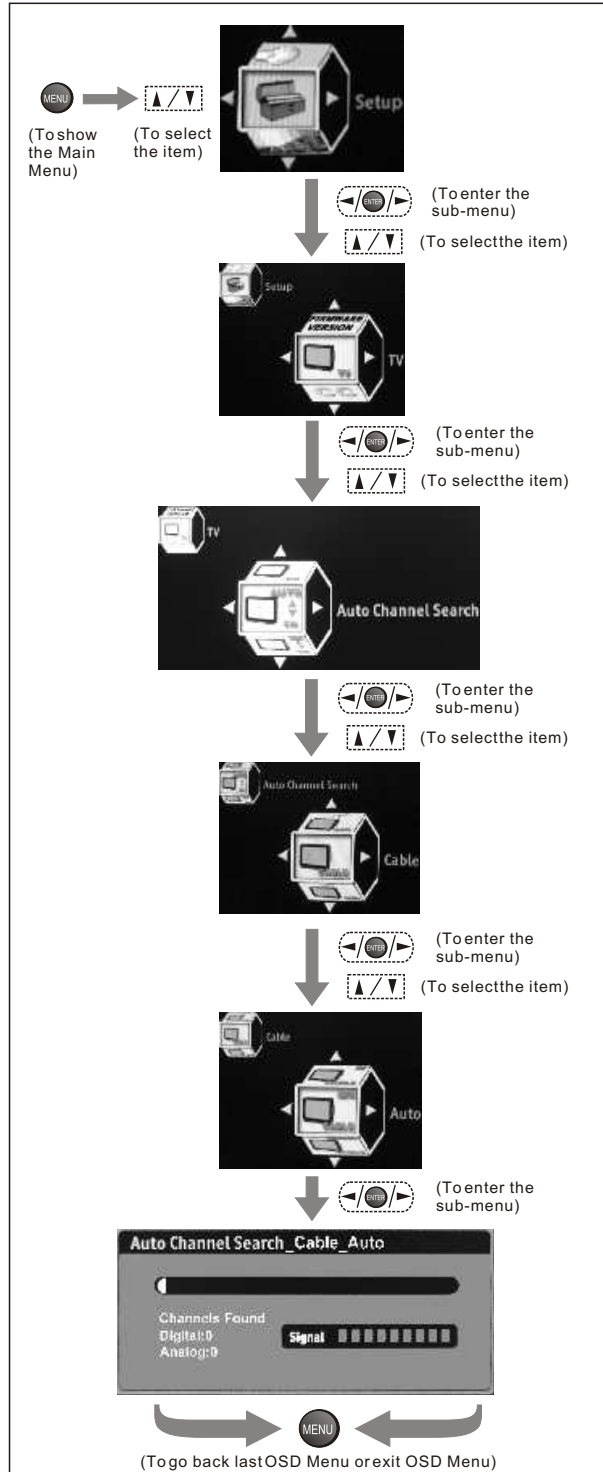

Editing Channels

In this Setup Index, you can edit channels to suit your personal preferences.

➤ Channel Setup

Will scan and preset all receivable channels automatically.

Favorite :

Selects and stores a list of favorite channels.

Browses through favorite channels by pressing Hotkey "FAVORITE".

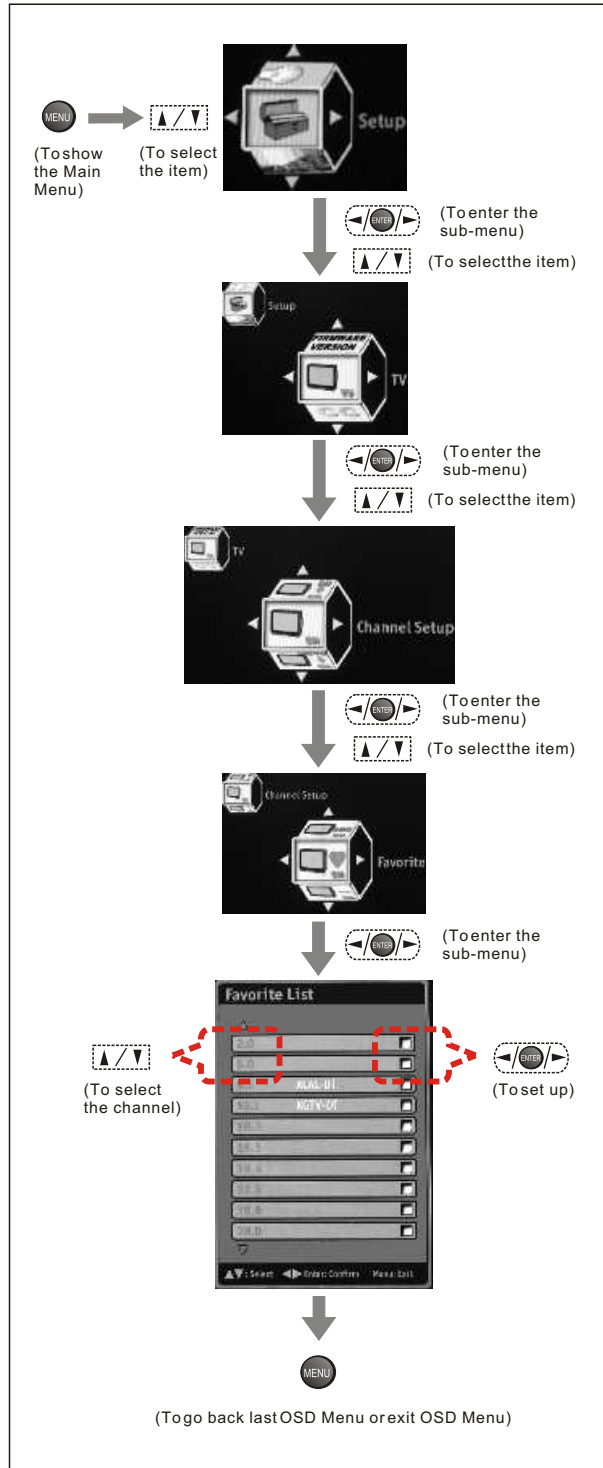

Skip :
Skips channels from viewing.

(NOTE: Once this function is set, the skipped channels will not be displayed after searching. If you wish to view later, enter the channel number by pressing the numeric keys on the remote control.)

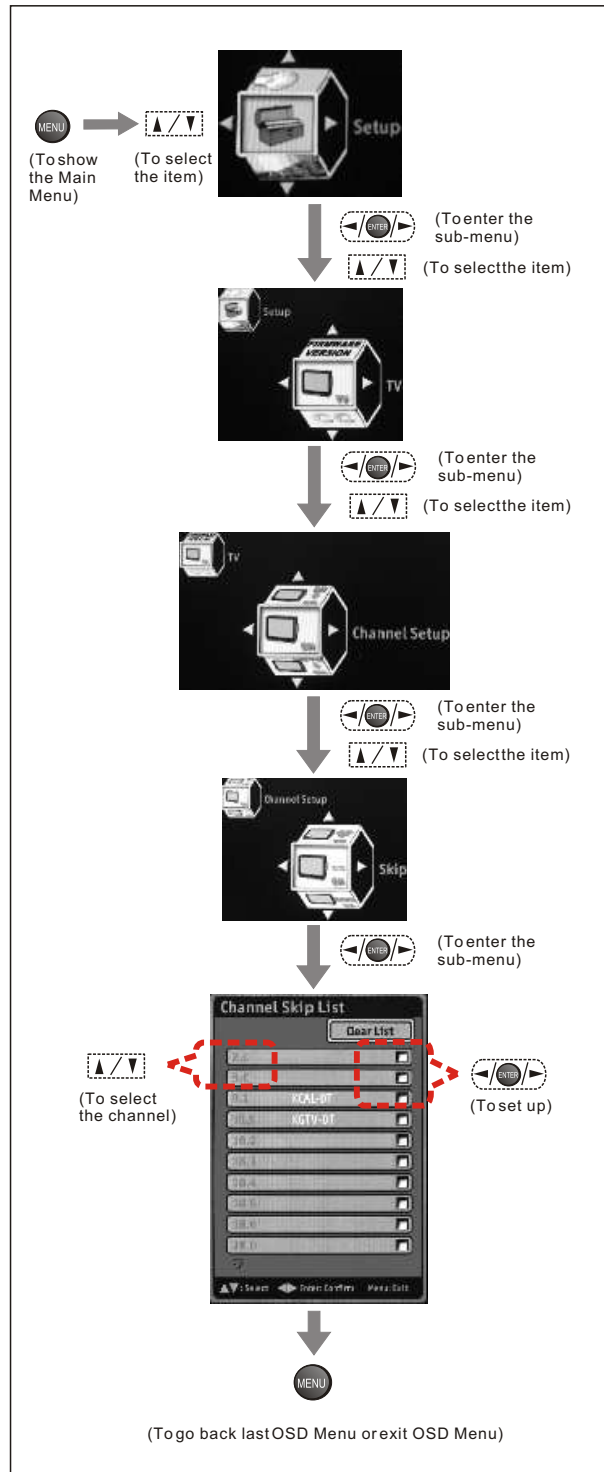

Name :

Creates a personal name for each channel.
(Analog TV Channel Only)

Name will appear in the upper-right corner of the screen.

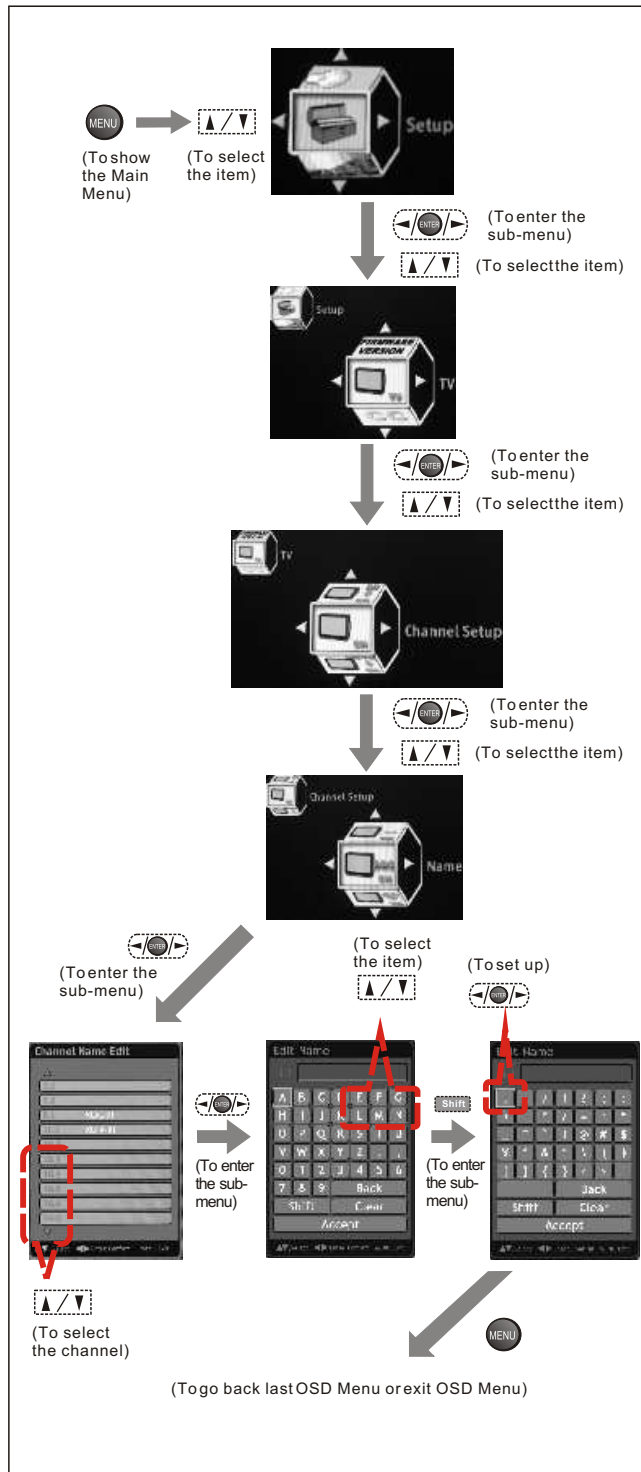

➤ **Channel Add :**

Adds channel currently on display to the FAVORITE channel list.

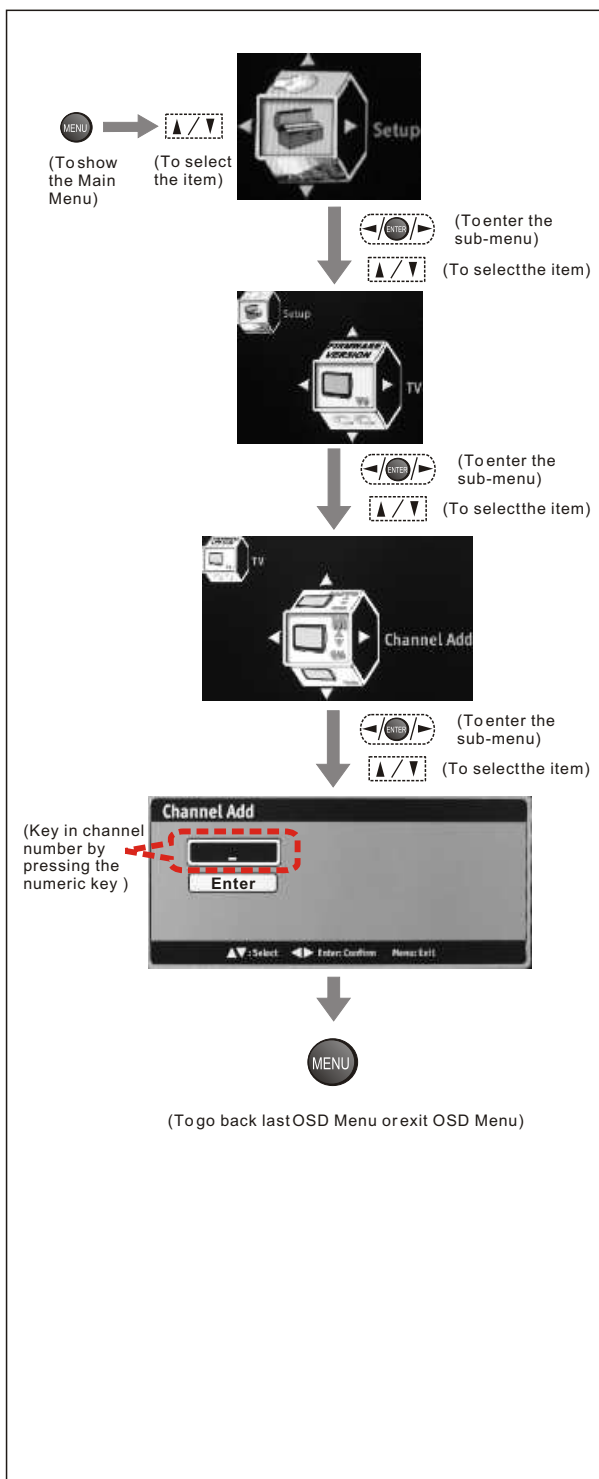

Closed Caption Options

Displays the audio portion of a television signal as text on the television screen.

➤ Analog Type

If there is Closed Caption data shown on the analog TV channel, you can select your preferred Closed Caption type by scrolling through CC1~4, T1~4.

CC1 : is used for most programs

CC2 : may be used for alternate languages

Text : is used for network and station information, such as channel guides, schedules, or bulletin board, for Closed Caption programs.

➤ Digital Type

Selects preferred Close Caption type by scrolling through CS1 - 6.

➤ Font

Selects preferred font by scrolling through As Broadcaster, Style 1-7. *(Digital TV Channel Only)*

➤ Size

Selects preferred font size by scrolling through As Broadcaster, Large, Medium, Small. *(Digital TV Channel Only)*

➤ Font Color

Selects preferred font color by scrolling through As Broadcaster, Black, White, Green, Blue, Red, Cyan, Yellow, Magenta. *(Digital TV Channel Only)*

➤ Background Color

Selects preferred background color by scrolling through As Broadcaster, Black, White, Green, Blue, Red, Cyan, Yellow, Magenta. *(Digital TV Channel Only)*

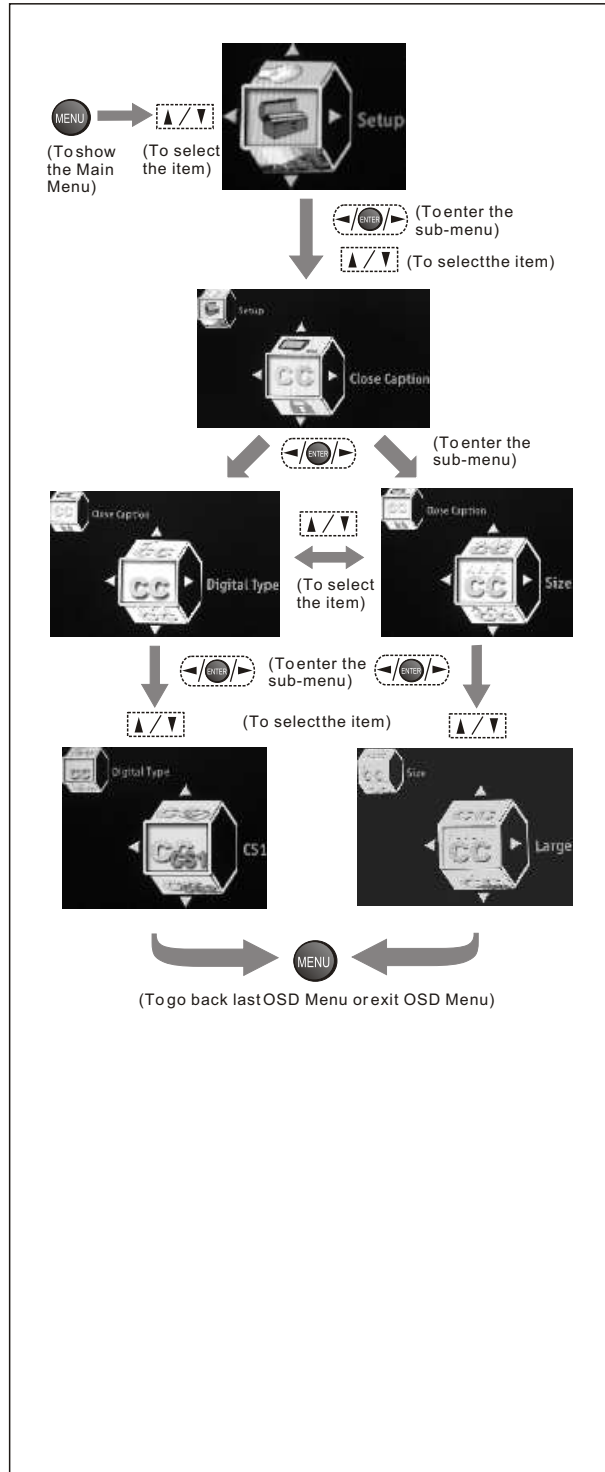

Setting up Parental Control Password

This function allows programs to be restricted and controlled by parents.

➤ Enter Password

Password is necessary to enter and re-enter the Parental Control Menu screen.

(NOTE: The Factory Default password is 999999 or 314159)

Activating the Parental Control Feature

Blocks programs based on programming rating system.

The TV Parental Control features by receiving the rating signal from your local broadcasting station or cable service provider.

➤ Rating

- * **On-** To activate rating function
- * **Off-** To disable all of rating functions

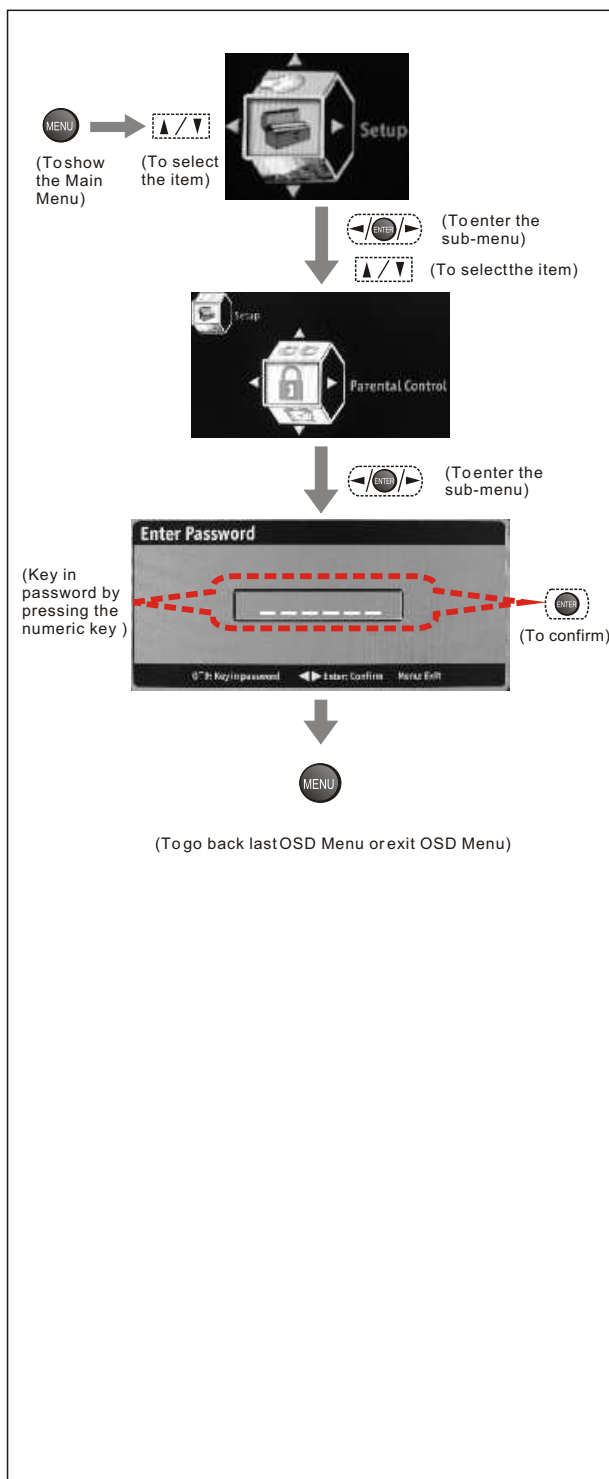

➤ **MPAA Rating**

Motion Picture Association of America provide movie ratings, including those shown on TV.

G : (General Audience) No restriction.

PG : (Parental guidance suggestion) Children under 13 should be accompanied by an adult.

PG-13 : (Parents strongly cautioned) Children under 13 should be accompanied by an adult.

R : (Restricted) Viewers should be 17 or older.

NC-17 : (Not classified) Viewers should be 17 or older.

X : (Adults only)

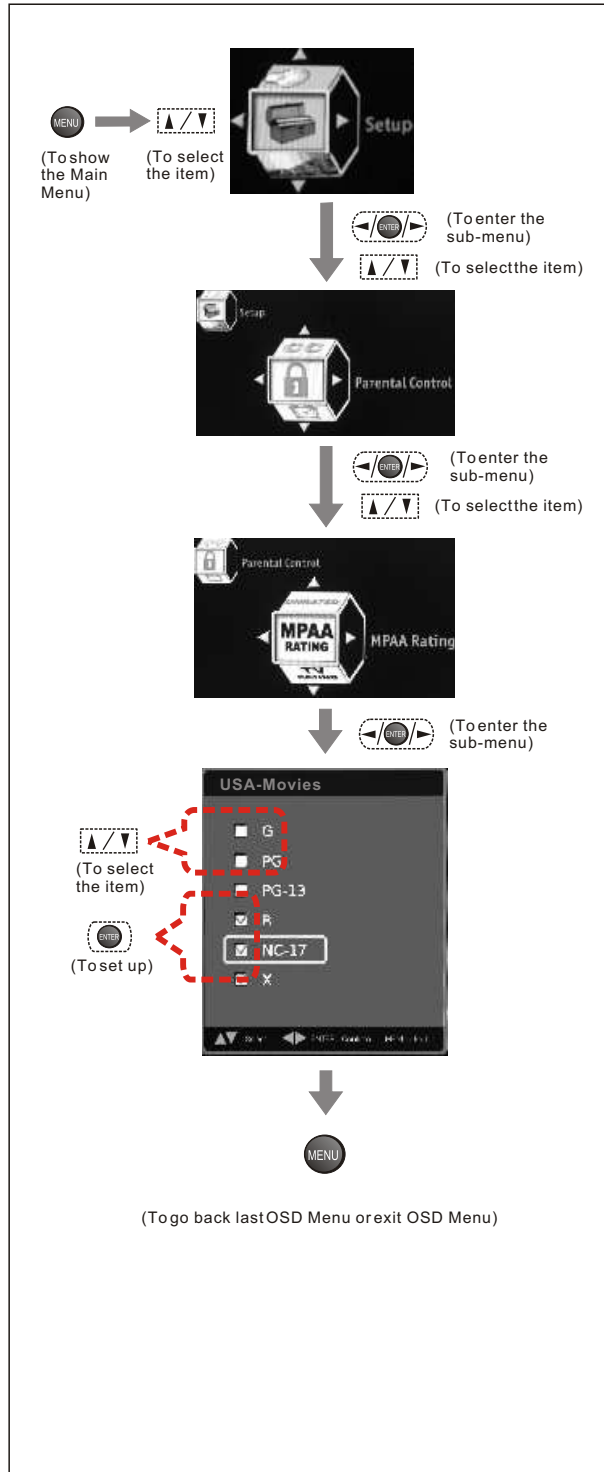

➤ **TV Rating**

U.S. TV ratings are for TV programs rated according to the U.S. Television Parental Guidelines.

TV-MA/V/S/L : (Mature audiences only)

TV-14/V/S/L/D : (Parents strongly cautioned)

TV-PG/V/S/L/D : (Parental guidance suggested)

TV-G : (General audience)

TV-Y7/FV : (Directed to children under 7 or older)

TV-Y : (All children)

(NOTE: When you block the lower rating, the higher age-based ratings are blocked automatically.)

➤ **Block Unrating**

You may select "On" for MPAA Unrated and TV Unrating. This allows you to block programs or movies that are broadcast without a rating.

To watch unrated channels, re-activate MPAA Unrated and TV Unrating to "Off".

(NOTE: The unrated option is available only when you have selected U.S.A. as your country/ region.)

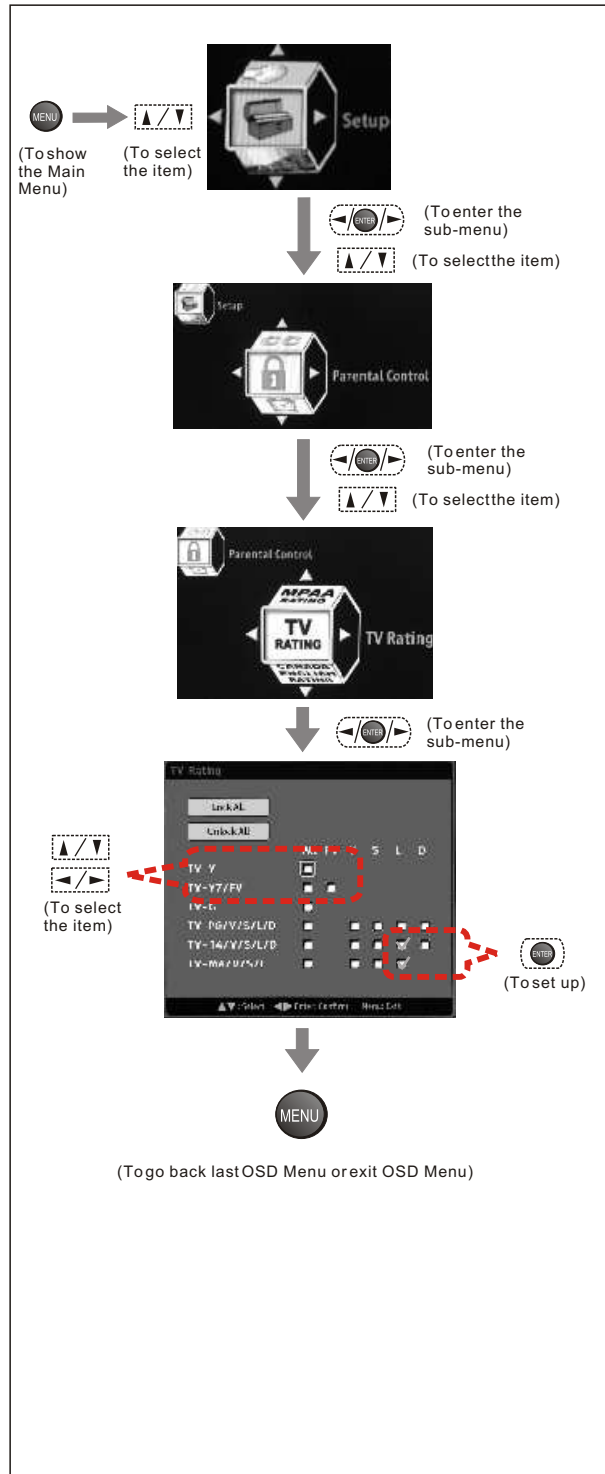

➤ Canada English Rating

It is available for TV programs in English broadcast in Canada.

E :

C : (Intended for children under 8)

C8+ : (Generally considered acceptable for children aged 8 and older to watch on their own)

G : (General Audience)

PG : (Parental Guidance) Parents may consider some content inappropriate for unsupervised viewing by children aged 8-13.

14+ : (Not suitable for viewers under the age of 14)

18+ : (Adult)

(NOTE: When you block the lower rating, the higher age-based ratings are blocked automatically.)

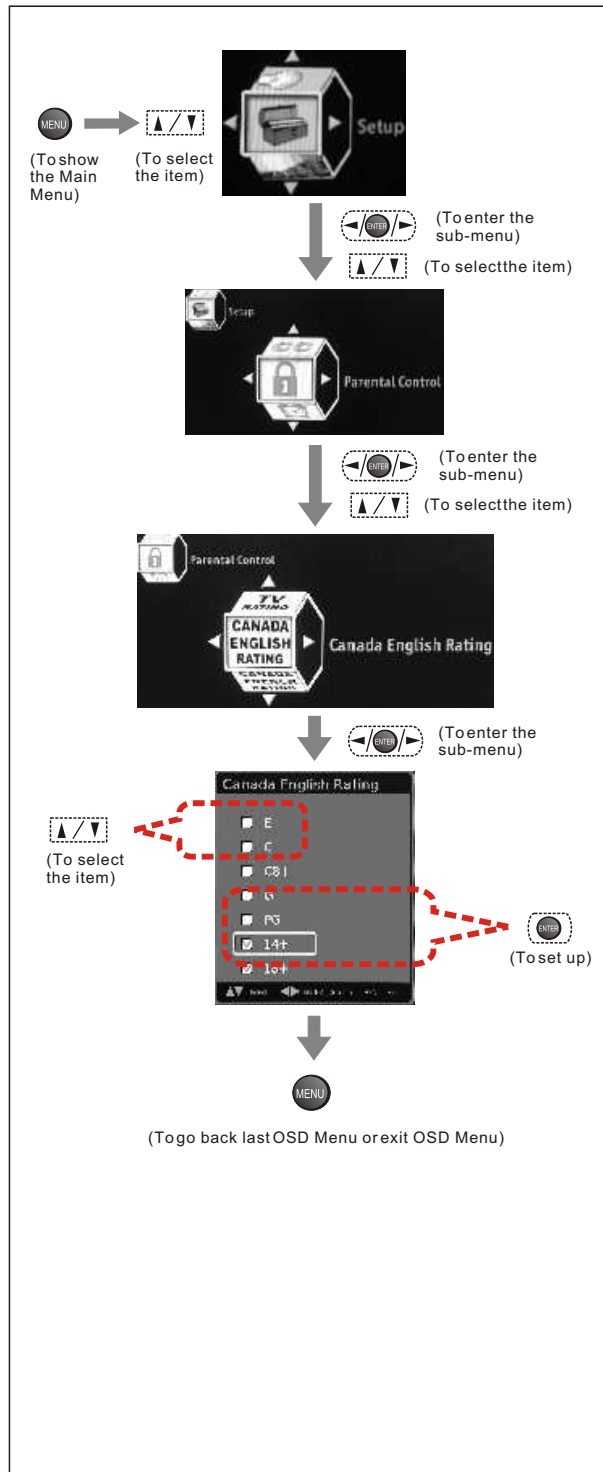

➤ Canada French Rating

It is available for TV programs in French broadcast in Canada.

E :

G : (General Audience)

8 ans+ : (8+ General--Not recommended for young children under the age of 8)

13 ans+ : (Not suitable for children under the age of 13)

16 ans+ : (Not suitable for children under the age of 16)

18 ans+ : (Restricted to adults)

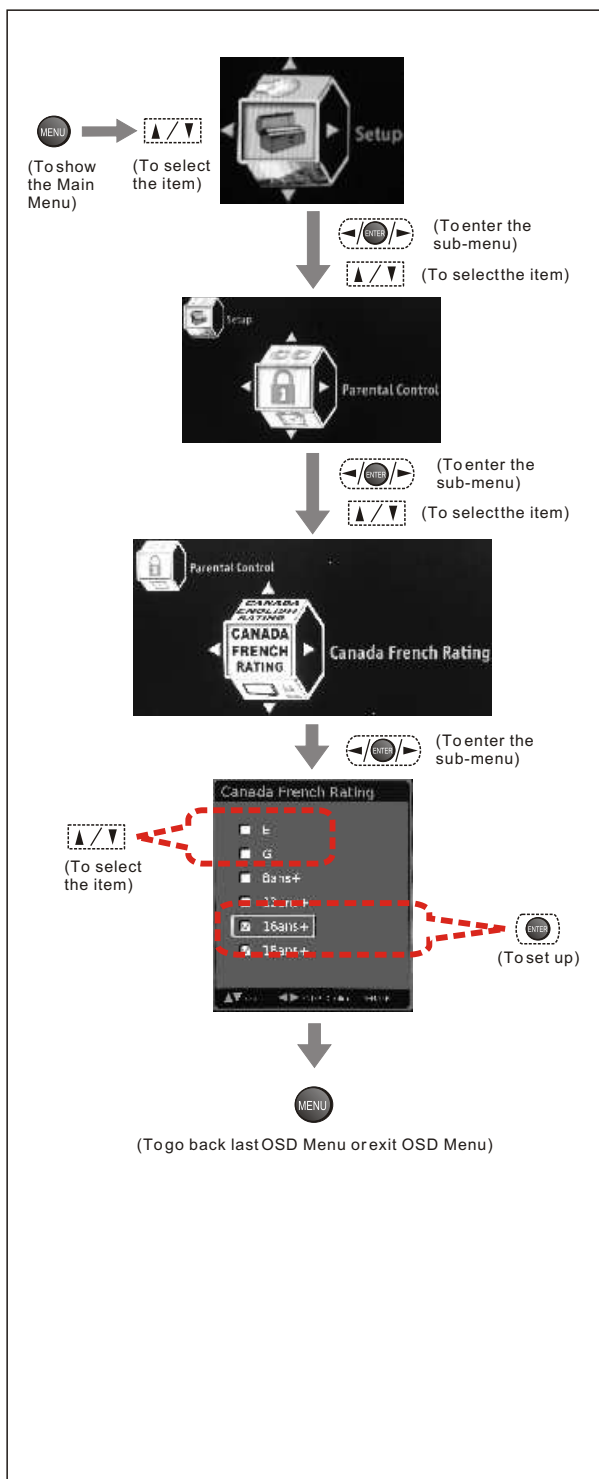

➤ Channel Block

In this Setup Index, you may select the blocked ratings to suit your personal preferences.

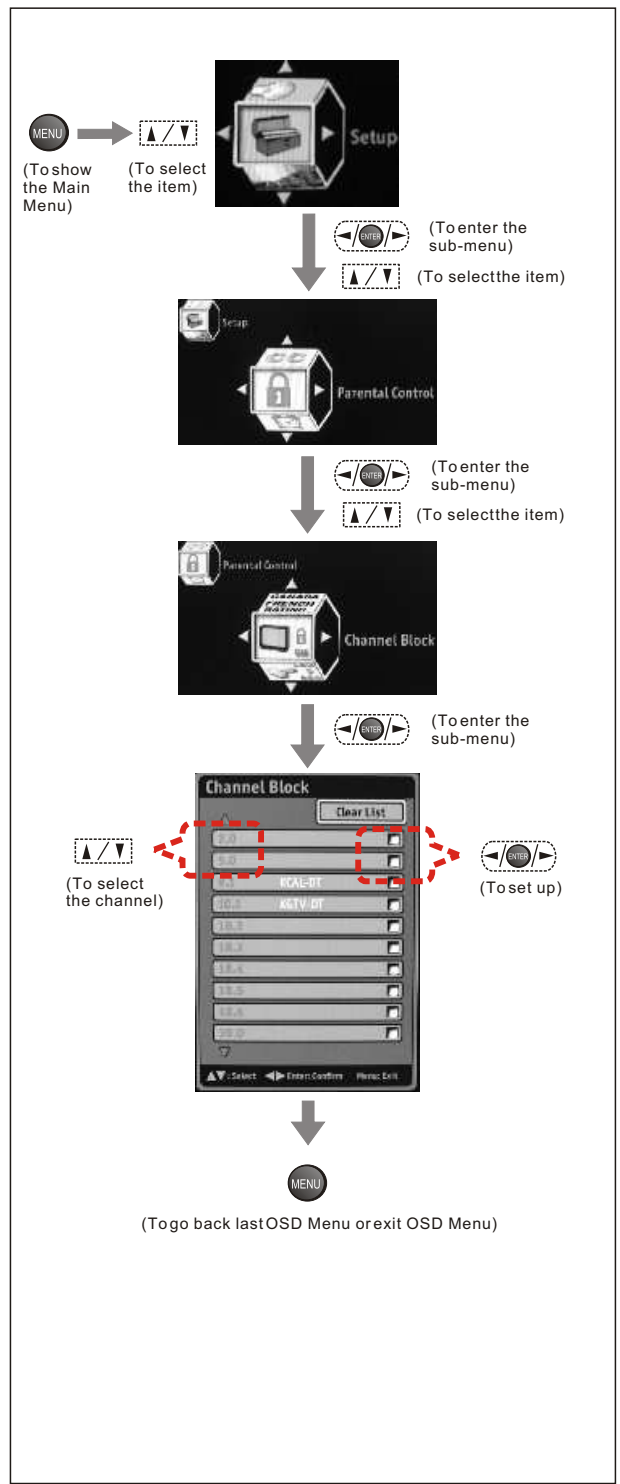

Resetting the Password

➤ Change Password

You may change to a new preferred password by pressing the numeric key within 6 numbers.

(NOTE: The Factory Default password is 999999 or 314159)

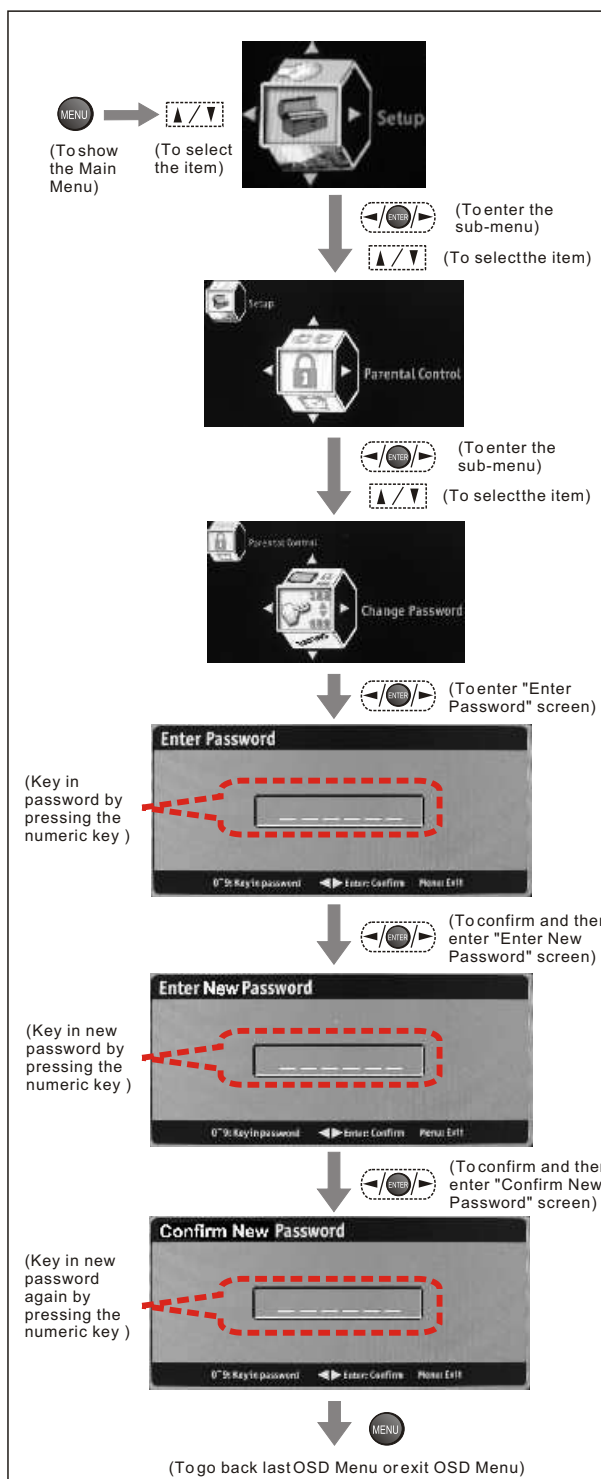

Setting the Date and Time

➤ Date and Time

In this Setup Index, you can setup the Date, Week, Time Zone, and Current Time on the TV.

Date :

Date is set automatically when NTSC source is used. (Manual adjustment is necessary however, if not used)

Day of Week :

It will be automatically displayed according to the Date setting.

Time Zone :

You can select available time zone where you live.

Current Time :

Time is set automatically when NTSC source is used. (Manual adjustment is necessary however, if not used)

Daylight Savings :

Option will be selected automatically based on settings above.

Auto Calibration :

Once activating this function, the information of "Date and Time" will be corrected automatically based on accurate time.

(NOTE: Once marking the "Auto Calibration" setting, all settings shown on the "Date and Time" screen will be invalid.)

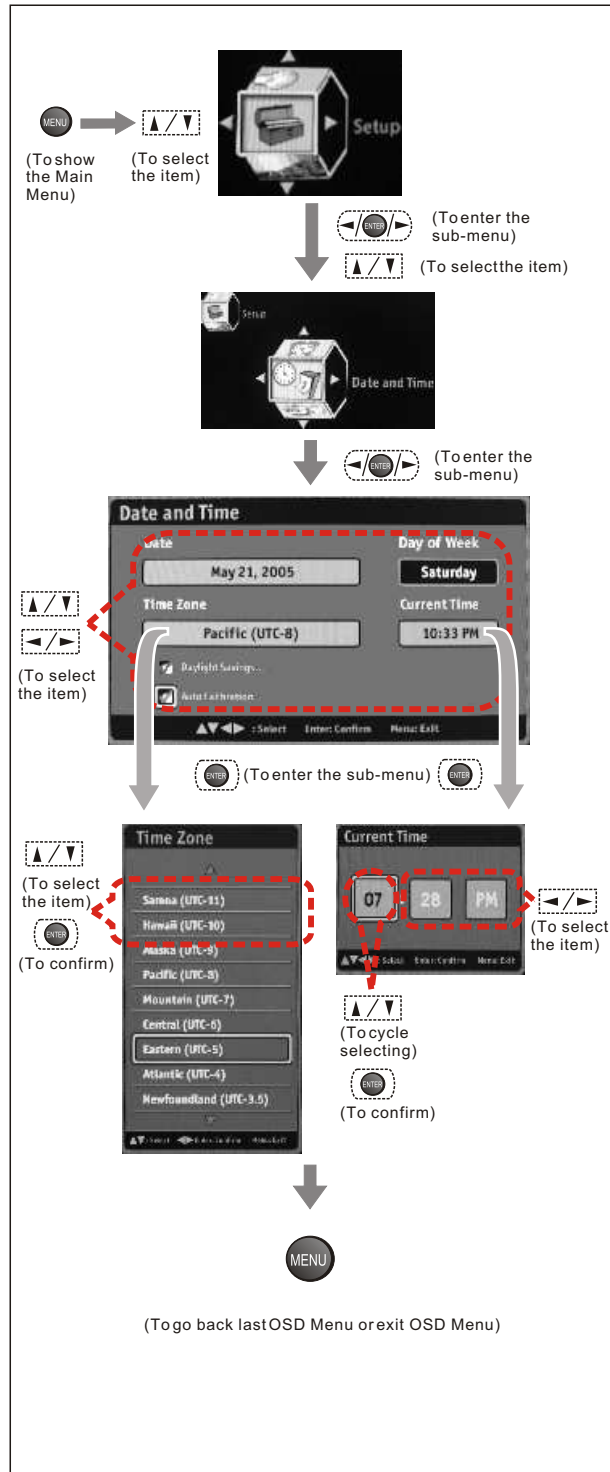

Setting the TV Timer

➤ Timers

In this Setup Index, you can setup the Sleep Time on the TV.

Sleep :

Shuts off TV after a preset period of time has passed by scrolling through 30, 60, 90, 120 minutes.

Timeout Settings for OSD Menu

➤ Menu Timeout

In this Setup Index, you can setup the OSD Menu display time before disappeared when no action is taken.

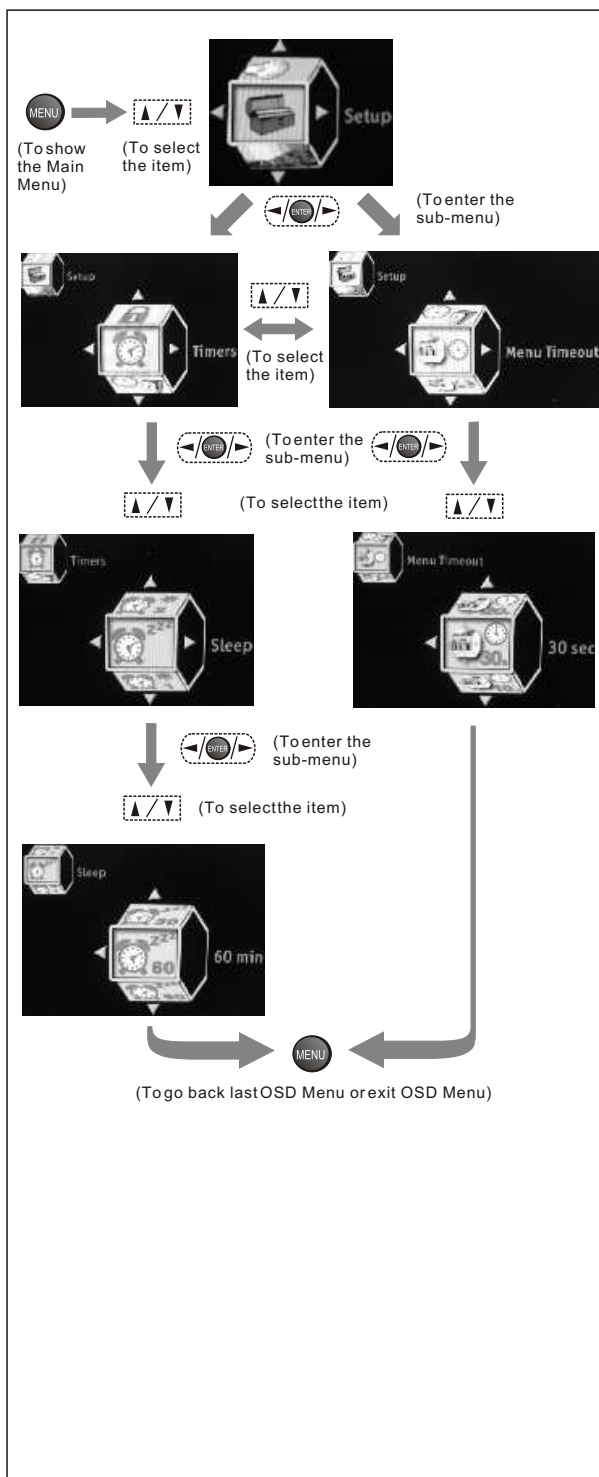

TV OSD Languages

➤ Languages

There are three language formats available for the OSD Menu. You may select it doing the following: English, Français, Español.

Setting DPMS

➤ DPMS

TV and Backlight will shut off automatically when no video source is detected when DPMS is active. (VGA Source Only)

- * **On-** To activate this function
- * **Off-** To disable this function

Setting LED Light

➤ LED Settings

It can be set to turn on / off the LED Light on the front panel of the TV when shutting off the TV.

- * **On-** To activate this function
- * **Off-** To disable this function

Factory Default Option

➤ Factory Settings

You can reset all OSD settings to original manufacture settings for all input sources.

➤ Factory Settings by Input

You can reset all OSD settings to original manufacture settings for the source you select currently.

Displaying the Firmware Version

➤ Firmware Version

You can see the firmware version here that installed in the HDTV unit.

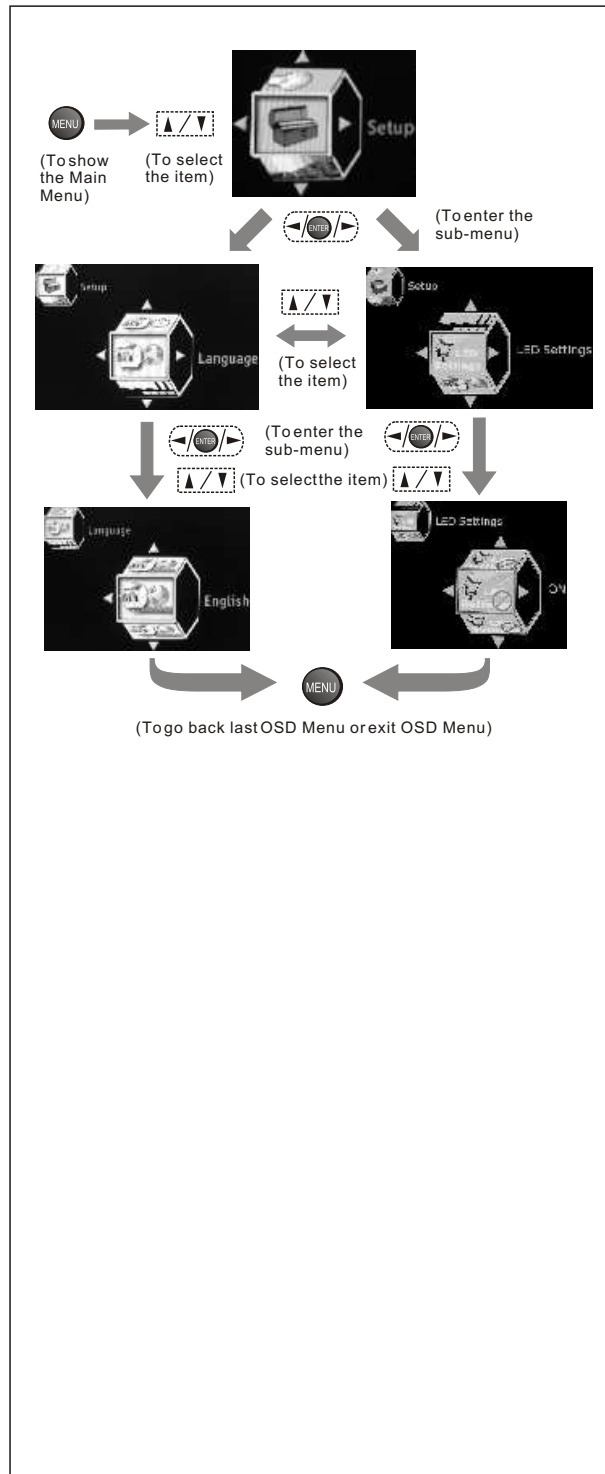

Specifications

TFT LCD Panel

Specifications				
Panel Size	42"	47"	52"	55"
Aspect Ratio	16:9	16:9	16:9	16:9
Pixels	1920 X 1080	1920 X 1080	1920 X 1080	1920 X 1080
Dynamic Contrast Ratio	1600:1	1000:1	1600:1	1500:1
H/V(View Angle)	176°(H) / 176°(V)	178°(H) / 178°(V)	176°(H) / 176°(V)	176°(H) / 176°(V)
Gray to Gray Response Time	6.5 ms	8 ms	6.5 ms	10 ms
Video/Graphic Processing				
PC Compatible Frequency	30~85 KHz(H) / 50~80Hz(V) Max. 1920x1080 @60Hz			
Video Compatibility	NTSC / ATSC			
DTV & HDTV Compatibility	480i, 480p, 720p, 1080i, 1080p			
Aspect Ratio Adjustment	1:1, Aspect, Full Screen, Panoramic, Zoom 1, Zoom 2			
3D Comb Filter	Y			
3 : 2 / 2 : 2 Pull Down	Y			
Digital Noise Reduction	Y			
Adjustable Color Temperature	Native, 6500			
De-interlacer	Y			
VGA Auto Frequency Correction	Y			
TV Auto Frequency Detection	Y			
Audio Processing				
Auto Sound Level Control	Y			
Output Watt	2 (15W + 15W)	2 (20W + 20W)	2 (25W + 25W)	2 (25W + 25W)
Sound Effect	MTS (Mono / Stereo / SAP)			
Input Terminals				
TV Tuner	Combo RF (NTSC/ ATSC) Tuner x1			
Video Input	Composite x2, S-Video x2, Y/Pb/Pr, Y/Cb/Cr x2, R/L x6			
HDTV & VIDEO Input	VGA/Component3 x1, HDMI x2, R/L x4			
Service Port	RS232C Port (D-sub 9 Pins) x1, Firmware Upgrade Port (B Type) x1			
Output Terminals				
Audio Output	Coaxial & Optical x1, R/L x1, SubWoofer x1, Earphonex1			

* NOTE : Product Specification is Subject to Change without Notice.

TFT LCD Panel

Others	42"	47"	52"	55"
Power (Voltage)	100~240 VAC / 50-60 Hz	100~240 VAC / 50-60 Hz	100~240 VAC / 50-60 Hz	100~240 VAC / 50-60 Hz
(Power Consumption)	271W	280W	325W	385W
Stand-by	< 1W	< 1W	< 1W	< 1W
Dimensions (W x D x H)	40.98 in x 11.42 in x 29.84 in	45.38 in x 11.42 in x 31.93 in	51.02 in x 12.8 in x 33.76 in	52.32 in x 16.74 in x 34.49 in
Carton Dimensions (W x D x H)	44.48 in x 12.87 in x 33.07 in	51.18 in x 14.57 in x 35.43 in	55.12 in x 14.88 in x 37.00 in	56.42 in x 20.39 in x 39.17 in
Weight w/o stand	52.92 lbs	71.66 lbs	110.25 lbs	144.43 lbs
Weight w/ stand	59.50 lbs	87.0975 lbs	132.3 lbs	187.425 lbs
Gross Weight	72.77 lbs	102.53 lbs	152.15 lbs	220.50 lbs

Dimensional Drawing

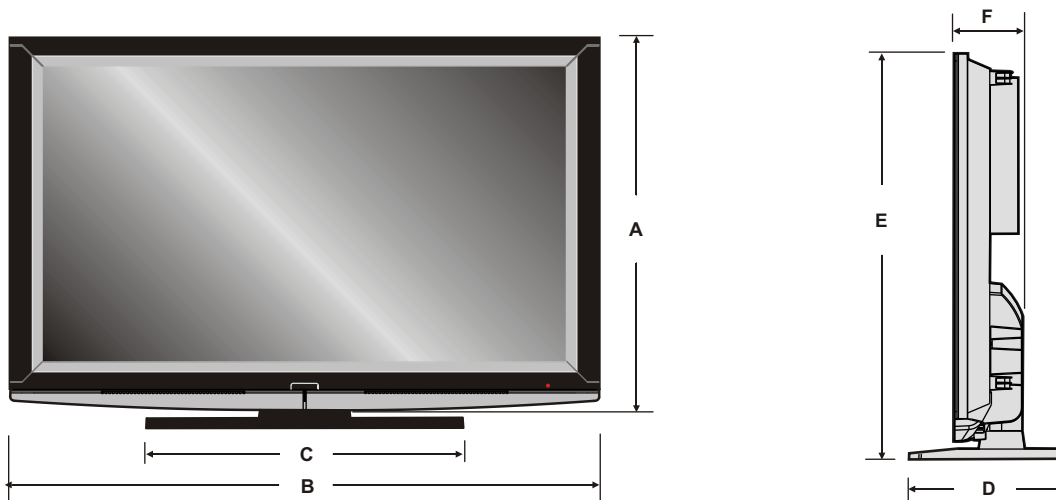

Model \ Size	A	B	C	D	E	F
42"	28.50 in	40.98 in	25.94 in	11.42 in	29.84 in	4.72 in
47"	30.99 in	45.38 in	25.17 in	11.42 in	31.93 in	5.52 in
52"	32.30 in	51.02 in	27.40 in	12.80 in	33.76 in	5.65 in
55"	33.11 in	52.31 in	35.43 in	16.73 in	34.49 in	6.63 in

Timing Mode for VGA and HDMI(PC)

Source	Resolution	Vertical frequency (Hz)
YPbPr	480p	59.94
	720p	60
	1080i	30
	1080p	60
VGA	640x480	60
		75
	800 x 600	60
		75
	1024 x 768	60
		75
	1280 x 768	60
	1360 x 768	60
	1920 x 1080	60
	HDMI(PC)	640 x 480
		75
800 x 600		60
1024 x 768		60
		75
1280 x 720		60
1280 x 768		60
1360 x 768		60
1920 x 1080		60

Pixels Policy

SyntaxBrilliant's D.O.A. Policy for LCD HDTVs for Defective Pixels on LCD Panels

(Applicable to the LCD HDTV sold within USA & Canada only)

SyntaxBrilliant LCD HDTVs are evaluated at a distance of approximately 50 centimeters (approximately 20 inches) between the LCD panel and the eyes of the user at a 90 degrees viewing angle. All LCD panels have been tested to ensure they comply with our factory standards. Our evaluation is based on the number of defective pixels and the distance between any two defective pixels. Bright dots are dots that appear bright and unchanged in size when a LCD HDTV screen displays under a black pattern; dark dots are dots that appear dark and unchanged in size when a LCD HDTV screen is displayed under pure red, green, or blue patterns ("defective pixels"). Adjacent dots are dots located directly next to each other.

Customers are required to check their LCD panel immediately after purchase. To identify defective pixels, the LCD panel should be examined under normal operating conditions as mentioned above, preferably in its native display resolution, and with a 90 degrees viewing angle.

A LCD HDTV will be considered dead on arrival (D.O.A.) with regards to defective pixels on the LCD panel when any one of the following criteria is met:

- A total of 7 defective pixels including both bright dots and dark dots are present (the typical 30" LCD Television screen has 1 million pixels), or
- 2 or more pairs of adjacent bright dots are present, or
- 3 adjacent bright dots are present, or
- 3 adjacent dark dots are present.

In view of customers' concerns about dead pixels, SyntaxBrilliant would like to address that defective pixels are not ultimately avoidable with the current LCD industry standard panel manufacturing processes. We always strive to improve our technology and minimize the chance of occurrence of defective pixels by applying strict screening processes in our factory production processes. However, SyntaxBrilliant cannot guarantee that a return unit to our customers will be 100% free of defective pixels.

For questions, please call our toll free service number in the USA at 888-Syntax-Brilliant-8.

"At Syntax-Brilliant Corporation, a satisfied customer is our most important focus."

Glossary

3:2 pull down - Process of converting 24 frames per second film to video by repeating one film frame as three fields, then the next film frame as two fields.

1	1	1	2	2	1	1	1	2	2
---	---	---	---	---	---	---	---	---	---

480I - 480 lines of display every 1/60 of a second; image is displayed by interlace scanning. See also Interlaced

480P - 480 lines of display every 1/60 of a second; image is displayed by progressive scanning. See also Progressive.

720P - 720 lines of display every 1/60 of a second; image is displayed by progressive scanning. See also Progressive.

1080I - 540 lines of display x 2 every 1/30 of a second; image is displayed by interlace scanning. See also Interlaced

16:9 - Aspect ratio under Hi Def. and theater movie formats. Also known as widescreen; see Aspect Ratio

4:3 - Aspect ratio under SDTV; see Aspect Ratio

Active Matrix TFT (Thin Film Transfer) - A type of display technology where the three primary colors are modulated. Results in better contrast ratios suitable for video.

Alarm - Feature on the Syntax-Brilliant Olevia models. Allows the unit to power on from the stand by mode.

Alarm Time - Time specified as to when the unit will power on. See Alarm.

Aspect Ratio - The ratio of an image according to the width and height of a picture.

ATSC - Advanced Television Systems Committee; international, non-profit organization that is committed to developing standards for digital television.

Reference: <http://www.atsc.org>

Bezel - Refers to the plastic or metal frame that acts like a shell around the LCD glass.

Backlight - Refers to the component, that lights up the LCD display.

Balance - Feature on the OSD for the Olevia models that adjust the left and right sound output from the speakers.

Background - Feature on the OSD for the Olevia models, which allows the user to change the OSD background, display to transparent or opaque.

Brightness - The measurement of color that is illuminated. Colors range from black to white.

CATV - Community Antenna Television (Cable Television)

Channel Favorite - Feature on the OSD for the Olevia models that allows the user to scroll through a defined list of channels that the user sets up.

Channel Edit - Feature on the OSD for the Olevia models that allows the user add or delete a channel.

Channel Source - Feature on the OSD for the Olevia models that lets the user select the source of their channels. Select TV for antennae or CATV for cable television.

Channel Auto Scan - Feature on the OSD for the Olevia models that when initiated, will determine which channels are available and which are not. If a desired channel is not accessible, you can add the channel in manually. See Channel Edit.

Channel Fine Tune - Feature on the OSD for the Olevia models that enables the user to tune the channel for better reception.

Chroma - (Chrominance) Refers to the color characteristics of a video signal.

CC - Closed Caption

- Color** - The term refers to the amount of color present. This varies between each user, as each person perceives colors differently.
- Color Temperature** - Feature on the OSD for the Olevia models that enables warm, normal or cool color settings. Warm emphasizes red, cool emphasizes blue, and normal doesn't emphasize any of the primary colors. This setting may affect each person individually depending on how color is perceived.
- Comb Filter** - A filtering system designed to removal unwanted artifacts by rejecting certain frequencies while permitting others.
- Component** - A three RCA type input that uses high quality cables (one for brightness, and two for color). Process increases bandwidth resulting in more color information to be carried to the TV producing a more accurate picture.
- Composite** - Also known as CVBS, Technology that permits the combination of color information and brightness under one wire. A single video signal that carries both brightness and color information are contained in a single wire.
- Contrast** - Difference in luminance between the white and black colors.
- CRT** - Cathode Ray Tube.
- DB15** - Also referred to as VGA; See VGA
- De-Interlace** - Process of converting an interlaced video signal.
- Display Area** - The perimeter of the LCD glass the image is displayed on. See Video Resolution
- Dual Link** - See Single Link; Supports a maximum bandwidth of 2 x 165 MHz (1920 x 1080 @ 60 Hz, 1280 x 1024 @ 85 Hz).
- DVI** - Digital Video Interface Describes the technology that is used to take full advantage of a signal when paired with a high-end video card and flat panel displays
- DVI-A** - Digital Video Hi-Resolution Analog
- DVI-D** - Digital Video Interface Digital; Cable is used for direct connection from one digital source to the TV; See DVI
- DVI-I** - Digital Video Interface Integrated; Cable that supports analog and digital signals; See DVI
- DTV** - Digital Television
- Factory Default** - Feature on the OSD for the Olevia models that resets all menu options to factory default.
- F-Connector** - The standard connector found on video equipments that coaxial cables connect to.
- Flat-Panel Display** - ultra thin displays, usually found in notebooks are now entering the TV appliances sector as new technology enables wider/larger screens.
- Frame** - A complete picture that includes both even and odd lines. 30 video frames are present in 1 second.
- Freeze** - The Freeze button on the Olevia remote control lets you stop the image on your TV. When you Freeze an image, you can write down what you see on-screen such as a telephone number, business address, or web site. You can also look at a frozen image of a golf swing. And you still hear the program running in the background. The frozen image stays on-screen indefinitely until you press Freeze again to go back to the program. Freeze also works with PIP.
- Gain** - Describes the amplification level of a particular signal.
- HDCP** - High bandwidth Digital Content Protection
- HDTV** - 1.High Definition Television 2. Designates as the unit having a built in ATSC tuner to decode High Definition signals (720P/1080I).
- HD-Ready** - A unit that supports the High Definition displays (720P/1080I) with the help of a Set-Top Box.
- Horizontal Resolution** - Refers to the number of vertical black and white lines defined along a horizontal line.
- IR** - Infrared
- Input** - term used in the On Screen Display

Interlaced - Images are the result of lines of data reassembled. Interlaced refers to the process of an image's odd lines reassembled from top to bottom taking about 1/60 of a second, before reassembling the even lines which results in a full picture. Antonym: Progressive

Language - Feature on the OSD for the Olevia models that enables the OSD to be read in different languages.

LCD - Liquid Crystal Display

LCoS - Liquid Crystal on Silicon

LED - Light Emitting Diode

Luminance - refers to the brightness of an image.

Lux - 1 Lux = 1 footcandle; measurement of brightness

Moire - A visual illusion in which a succession of parallel curved lines produces a pattern to the naked eye, but does not really exist. Otherwise known as the moire effect.

NCTA - National Cable Television Association

Noise reduction - Feature on the OSD for the Olevia models that enables channels from the tuner box to reduce noise displayed on the LCD unit.

NTSC - National Television systems Committee

OSD - On Screen Display; brought up by pressing the menu button on the TV or the Remote.

Over Scanning - An image displayed is larger than the display area

PAL - Phase Alternating Line

Parental Control - The ability to block access to specified content from an unsuitable audience.

PIP - Picture in Picture; feature that enables one source to be displayed on top of another source.

Pixel Resolution - Refers to the number of rows horizontal and vertical that produces the image.

PIP - Picture in Picture; Allows an image to be displayed in front of another image.

Plug and Play - Describes the hardware or software that is installed and does not require any configuration before using.

Progressive - An image or lines of data that is reassembled from top to bottom sequentially.

Antonym: Interlaced

RGB - Red, green & blue These primary colors provide the basis for many different colors.

Refresh Rate - Refers to the maximum number of frames that the monitor can display per second. Usually measured in hertz.

Saturation - The amount of a particular color present in an image.

SCART - An industry standard for interconnecting audio-video equipment developed by Peritel. Usually associated with PAL video equipment.

SDTV - Standard Definition Television usually in 480I/P format.

SECAM - Sequential Color with Memory or Sequential Couleur Avec Memoire

Set-Top-Box - box that is capable of receiving and decoding digital transmissions (i.e. High Definition Cable Box, Digital Cable box).

Sharpness - Tries to artificially enhance the edges of a picture.

Single Link - supports a maximum bandwidth of 165 MHz (1920 x 1080 @ 60 Hz, 1280 x 1024 @ 85 Hz).

Split screen - Feature that places two images side by side.

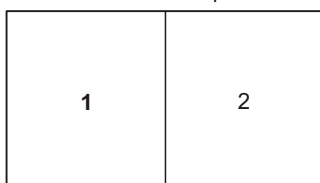

Swap - Button featured on the Olevia remote. Used in the POP3 or PIP12 views to swap the sub viewable boxes with the main viewable box.

Tint - Adjusts the whiteness level within the color. Similar to Hue.

Under-scanning - Term used where the image displayed is smaller than the display area.

Up convert - Process of converting a 480P/I signals to 720P or 1080I.

V-Chip - Chip that controls access to forbidden content specified by an adult.

VGA - 1. Video Graphics Array (DB15) 2.

Video Display - Refers to the display resolution

Video Resolution

Aspect Ratio 4:3		Aspect Ratio 16:9	
VGA	640 x 480	WXGA	1280 X 800
SVGA	800 x 600	SXGA	1280 X 1024
XGA	1024 x 768	WXGA+	1400 X 1050
QVGA	1280 x 960	WSXGA	1680 X 1050
SXGA+	1400 x 1050	WUXGA	1920 X 1200
UXGA	1600 x 1200	QSXGA	2560 X 2048
QXGA	2048 x 1536		
QSXGA+	2800 x 2100		
QUXGA	3200 x 2400		

Viewable Angle - Angle at which the screen is still viewable.

Widescreen - See 16:9

YCbCr - Used often with standard interlaced video equipment. See Component

YPbPr - Used often with progressive video equipment. See Component

ÖLEVIA

olevia.com

20480 EAST BUSINESS PARKWAY
CITY OF INDUSTRY, CA 91789
USA

MK0-UM00179G000
SKU#: MD0-UM2TFHD

© 2007 Syntax-Brilliant Corporation. All trademarks are property of their respective owners. Product specifications and designs are subject to change without notice.
Toutes les marques de commerces sont la propriété de leurs propriétaires respectifs. Les caractéristiques et la conception sont sujettes à changement sans préavis.

Free Manuals Download Website

<http://myh66.com>

<http://usermanuals.us>

<http://www.somanuals.com>

<http://www.4manuals.cc>

<http://www.manual-lib.com>

<http://www.404manual.com>

<http://www.luxmanual.com>

<http://aubethermostatmanual.com>

Golf course search by state

<http://golfingnear.com>

Email search by domain

<http://emailbydomain.com>

Auto manuals search

<http://auto.somanuals.com>

TV manuals search

<http://tv.somanuals.com>