

ÖLEVIA
By **SYNTAX**

User's Manual

LCD Multi-Media Display
LT32HVE / LT32HVM Series

ÖLEVIA
By **SYNTAX**

Syntax Groups Corporation © 2005 All Rights Reserved
www.syntaxgroups.com
For Customer Service Call 888-SYNTAX-8

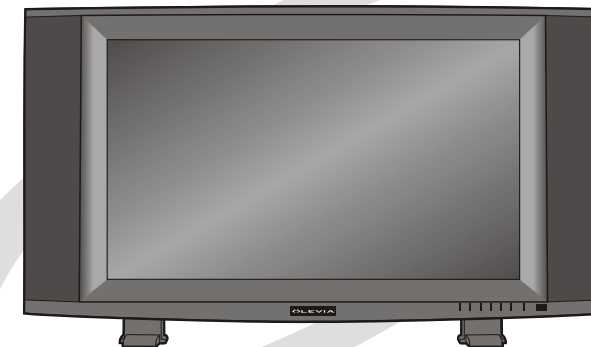

Table of Contents

Important Information	1
Important Safety Precautions	2
FCC Statement	5
Accessories	6
Installation And Connection Guide	
Identifying Front Controls and Rear Inputs	8
-Descriptions of Input Types	10
-Connecting the TV's Power	11
Installation	12
-Connecting to an Antenna or Video Equipment with Antenna outlet	13
-Connecting to a VCR	14
-Connecting to an Audio Receiver/Home Theater System	15
-Connecting to a DVD Player with A/V or S Video Cables	16
-Connecting to a DVD Player with Component Cables	17
-Connecting to a Satellite Receiver or Cable Box with A/V Cables	18
-Connecting to a Satellite Receiver or Cable Box With Component Connectors	19
-Connecting to a PC with VGA, and a DVD Player with DVI/HDCP Cables	20
-Other Connections	21
Remote Control Guide	
-Regular Buttons	22
-Hotkeys Tutorial	23
Adjusting the On Screen Display (OSD)	
Introduction	25
To Operate in the OSD	25
VIDEO Adjusting TV Picture Settings	26
- Adjusting Picture Quality	26
- Video Settings	26
- To Adjust Settings	29
- Auto Setting : Return to Default Factory Settings	29
AUDIO Adjusting Sound Quality	30
- OSD Audio Settings : Equalizer 1	31
- OSD Audio Settings : Equalizer 2	31
- MTS System for Stereo TV	32
MISCELLANEOUS Adjusting Personal TV Settings	33
- Description of Settings	33
- Setting the Channels	34
- Personal Channel Preferences : Favorites	34
- Personal Channel Preferences : Channel Skip/Lock	35
- Personal Channel Preferences : Channel Naming	36
- Setting up the TV Timer	37
- Watching with Closed Caption	38
- TV OSD Languages	39
- Using the Parental Control Feature	39
- Parental Control	40
- Activating the Parental Control Feature	40
- To Block Unrated Channels	42
- Setting up Parental Control Password	42
- Factory Default Option	44
SCREEN Adjusting Screen Modes	45
- Changing the Screen Mode	45
- Picture in Picture (PIP)	46
- PIP Mode	48
- Split Screen	49
- Split Screen Mode	50
Specifications	51
Timing Mode for VGA and DVI	53
Pixels Policy	55
Glossary	56

Important information



Caution
Risk of electronic shock
Do not open



To reduce the risk of electronic shock, do not remove cover (or back).
No user-serviceable parts inside.
Refer service to qualified Repair Technician or Repair Center.



Read the following context indicated by the following symbol to the left. It indicates important literature in operating the product.



Read the following context indicated by the following symbol to the left. It indicates a potential high voltage hazard that may compromise your safety.



Caution

Take caution when moving the product on a cart. Quick stops, excessive force, and uneven surfaces may cause the display unit and cart combination to overturn.

Caution

To prevent electric shock, match wide blade of plug to wide slot, fully insert.

Caution

This product satisfies FCC regulations when shielded cables and connectors are used to connect the unit to other equipment. Prevent electromagnetic interference from electrical appliances such as radios and televisions. Please use shielded cables and connectors for connections.

Warning

FCC Regulations state that any unauthorized changes or modifications to this equipment not expressly approved by the manufacturer could void the user's authority to operate this equipment.

Important safety precautions

Cleaning

Remember to unplug the AC cord from the AC outlet before cleaning the display unit. And do not use liquid cleaners or aerosol cleaners to clean the display.

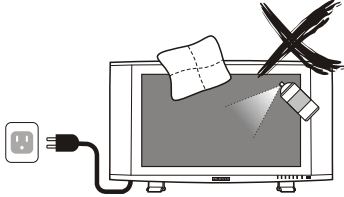

Stand

Do not place the display unit on an unstable place. The TV may fall resulting in serious personal injuries to nearby people as well as damage to the display unit.

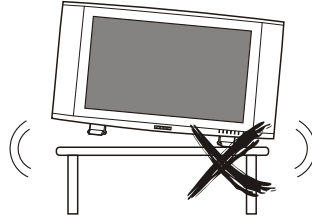

Ventilation

Do not cover or block these vents and openings located on the top and back of the display. Inadequate ventilation may cause overheating and shorten the lifespan of the display. Do not place in an enclosed area such as a built-in shelf, unless proper ventilation is provided or the manufacturer's instructions are followed. Keep the distance of 10cm minimum between the display unit and wall. Never install the display unit as indicated in the picture below.

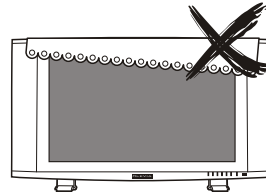

Air circulation is blocked



Air circulation is not blocked

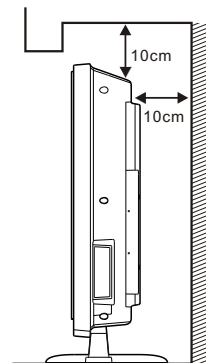

Never insert objects or spill liquid into the display unit

Never insert any object into the display unit through openings or spill liquid on the display unit. High voltage flows in the display unit, and inserting an object can cause electric shock and/or short internal parts.

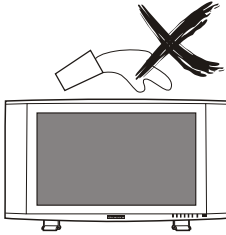

Keep away from water and moisture

Do not place the display in areas where moisture is present or where the unit may get wet such as bathrooms, kitchen, pool area or in a wet basement.

Keep away from heat sources

Keep the display unit away from heat sources such as radiators, heaters, stoves and other heat-generating products.

The liquid crystal panel used in this product is made of glass

Do not hit the panel. Be careful to prevent from getting hurt by broken glass pieces in case the panel breaks.

Follow operating instructions

All operating instructions must be followed.

Servicing

Do not attempt to service the display unit yourself. Removing covers expose you to high voltage and other dangerous conditions. Request a qualified service technician to perform the service.

Precautions when transporting the display

Carrying the display requires two or more people.

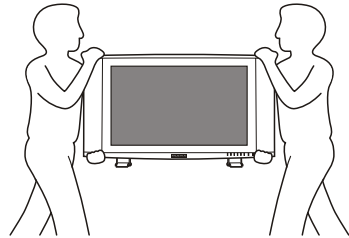

Attachments

Do not use attachments not recommended by the manufacturer. Use of inadequate attachments may result in accidents to nearby people or to the unit.

Power source

This product must operate on a power source specified on the specification label. If you are not sure of the type of power supply used in your home, consult your dealer or local power company. For units designed to operate on batteries or another power source, refer to the operating instructions.

AC cord protection

The AC cords must be routed properly to prevent people from stepping on them or objects from resting on them. Check the cords at the plugs and product.

Wall mounting

Be sure to install the display unit according to the method recommended by the manufacturer. Use only the mounting hardware recommended by the manufacturer.

Overloading

Do not overload AC outlets or extension cords. It may result in electric shock or start a fire.

Replacement parts

In case the display unit needs replacement parts, make sure that the service technician uses replacement parts specified by the manufacturer, or those with the same characteristics and performance as the original parts. Use of unauthorized parts can result in fire, electric shock and/or other danger.

Safety checks

Upon completion of service or maintenance, request the service technician to perform safety checks to ensure that the display unit is in proper operating condition.

Repair

When the display unit displays an abnormal condition, any noticeable abnormality in the display unit indicates that the display unit needs servicing. If any of the following conditions occurs, unplug the AC cord from the AC outlet, and request a qualified service person to perform repairs.

- 1.**A liquid was spilled on the display unit or objects have fallen into the display unit.
- 2.**The display unit has been exposed to rain or water.
- 3.**The display unit has been dropped or damaged.

Environment

The display unit only operates within the temperature 0°C to 40°C. Operation outside of the recommended may cause damage to your product.

FCC Statement

FCC notice

This equipment has been tested and found to comply with the limits for a Class B digital device, pursuant to part 15 of the FCC Rules. These limits are designed to provide reasonable protection against harmful interference in a residential installation. This equipment generates, uses and can radiate radio frequency energy and, if not installed and used in accordance with the instructions, may cause harmful interference to radio communications. However, there is no guarantee that interference will not occur in a particular installation. If this equipment does cause harmful interference to radio or television reception, which can be determined by turning the equipment off and on, the user is encouraged to try to correct the interference by one or more of the following measures:

- 1.Reorient or relocate the receiving antenna.
- 2.Increase the separation between the equipment and receiver.
- 3.Connect the equipment into an outlet on a circuit different from that to which the receiver is connected.
- 4.Consult the dealer or an experienced radio/TV technician for help.

Modifications not expressly approved by the manufacturer could void the user's authority to operated the equipment under FCC rules. This device complies with part 15 of the FCC Rules. Operation is subject to the following two conditions:

- 1.This device may not cause harmful interference.
- 2.This device must accept any interference received, including interference that may cause undesired operation.

For Canadian model

This Class B digital apparatus complies with Canadian ICES-003.

Approval



Accessories

Supplied accessories

Remote control & batteries (AAA x 2)



VGA cable (D-Sub 15 male) x 1



User manual booklet x 1

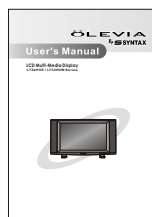

QSG x 1



Power cord x 1



Optional accessories

AV cable with RCA connector



S-video cable



DVI cable



Audio cable with RCA connector



Component cable with RCA connector



Audio cable with stereo mini jack

Use the proper cable for the device.



(Stereo mini jack cable)



(Stereo mini jack to RCA cable)

Wall mount set

Model# WM-20D

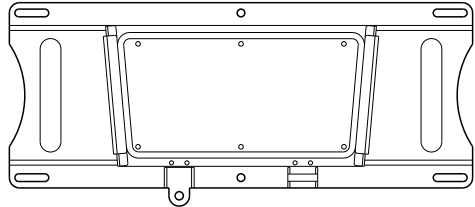

TV Installation and Connection Guide

Identifying Front and Rear Panels

Front Panel

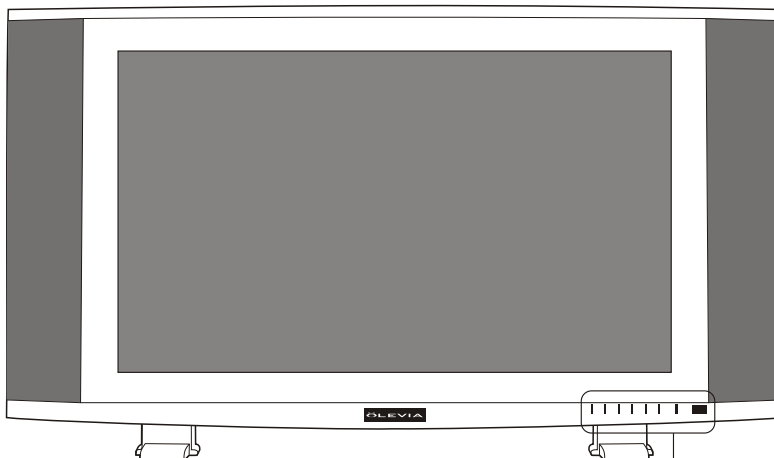

POWER Turns display on/off

MENU Displays the On Screen Display(OSD) menu. In OSD menu, press it to return to pre-phase

CH▲/CH▼ Adjusts Channel. In the OSD menu, both keys are used to navigate within menu.

VOL+/VOL- Adjusts volume. In OSD menu, both key are used to navigate within menu. Vol+ is used to select the highlighted option.

SOURCE Press to switch the input sources

IR SENSOR Contains Infra-red light for digital data transmission by the remote control. Please point remote control at IR Sensor for function.

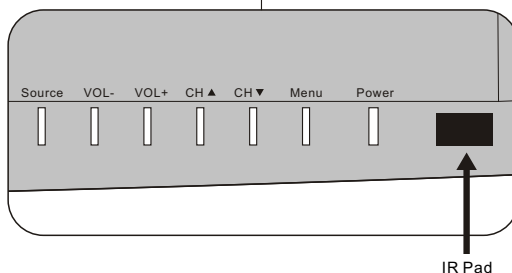

Identifying Front and Rear Connectors

Rear Panel

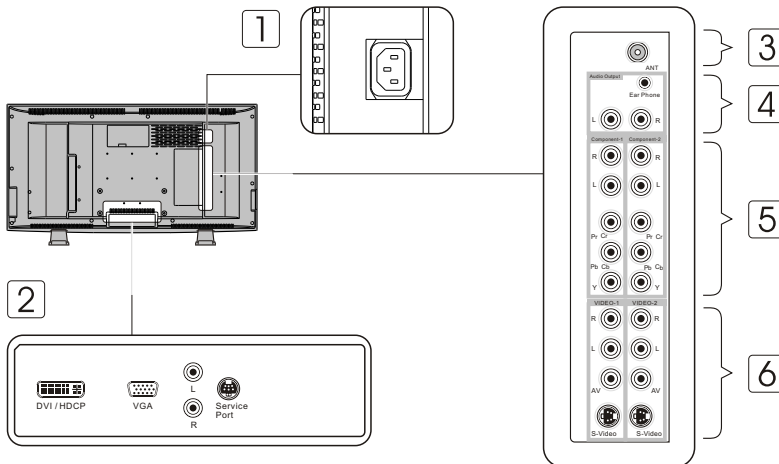

1 AC IN power cord connects here.

2 DVI/HDCP and VGA Port This display includes a DVI input that receives analog or digital video signals through the interface for the display of high quality digital video signals. The DVI port is HDCP (High Bandwidth Digital Content Protection) compliant and is fully compatible with video equipment that features the HDCP function. The VGA input can be used for analog RGB signals from a HD Receiver or personal computer. Resolutions supported are VGA, SVGA, XGA and WXGA. DVI and VGA share Audio L/R inputs.

Service Port is reserved for manufacturer use. Incorrect use may damage the Display.

3 Antenna (ANT) Antenna receives signals from VHF/ UHF antennas or a cable system.

4 Audio Out The Audio Output sends the TV's connected audio signals to an A/V receiver or other equipment. Display features a R/L stereo output.

5 Component 1, 2 These inputs can be used for the connection of A/V equipment with component video outputs, such as a DVD player, Digital Satellite Receiver, or compatible Video Game System.

6 Video 1,2 These inputs can be used for the connection of a VCR, Super VHS (S-VHS) VCR, DVD player, or other video devices to the TV. There is a Video and an S-Video input for Video 1 and video 2. When both inputs are used simultaneously on Video 1, only the S-Video input will be recognized. Same behavior for Video 2. The display will automatically detect the input being used.

NOTE: The S-Video input has a better quality of picture than a composite Video signal.

Descriptions of Connector Types

You may find it necessary to use some of the following connector types during setup.

75-ohm coaxial cable Used for TV cable connection .



S-Video Cable High quality video cable for enhanced picture quality.



Audio/Video Cable

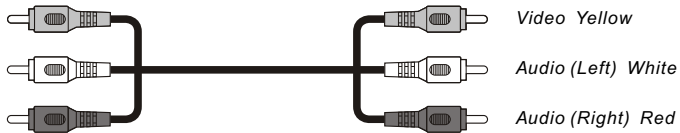

Some DVD players are equipped with the following three video connectors:

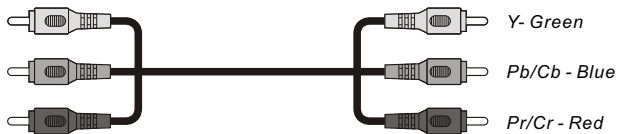

Connecting the Power Cord

Complete other connections prior to connecting the power cord:

1. Connect the power cord to the AC IN connector of the TV

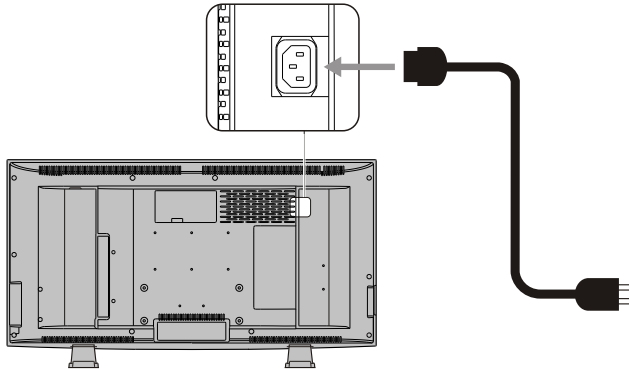

2. Connect the other end of the power cord to the wall outlet.

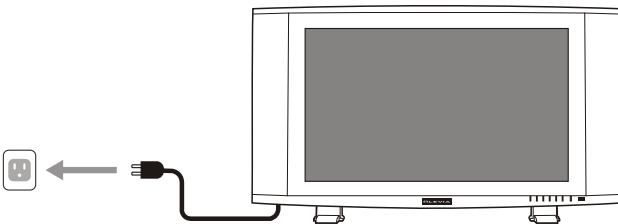

Installation

In the following pages, you will find directions on how to install your tv and choice of video equipment.

- **Connecting to an Antenna or Video Equipment with Antenna outlet**
- **Connecting to a VCR**
- **Connecting to an Audio Receiver/Home Theater System**
- **Connecting to a DVD Player with A/V or S Video Cables**
- **Connecting to a DVD Player with Component Cables**
- **Connecting to a Satellite Receiver or Cable Box with A/V Cables**
- **Connecting to a Satellite Receiver or Cable Box With Component Connectors**
- **Connecting to a PC with VGA, and a DVD Player with DVI/HDCP Cables**
- **Other Connections**

Connecting to an Antenna or Video Equipment with Antenna outlet

⚠ Disconnect all power sources before making any connection.

1. Connect a 75-ohm coaxial cable onto the ANT input on the back of the TV's right side panel.

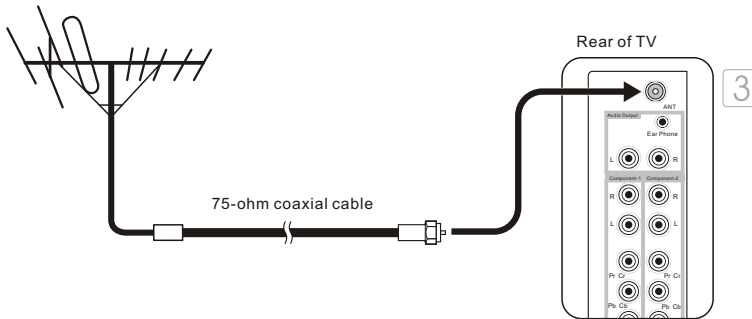

If connecting to Video Equipment with Antenna outlet

1. Using a 75-ohm coaxial cable (or choice of Antenna Cable), connect the cable box's OUT jack to the TV's ANT jack (RF Terminal).

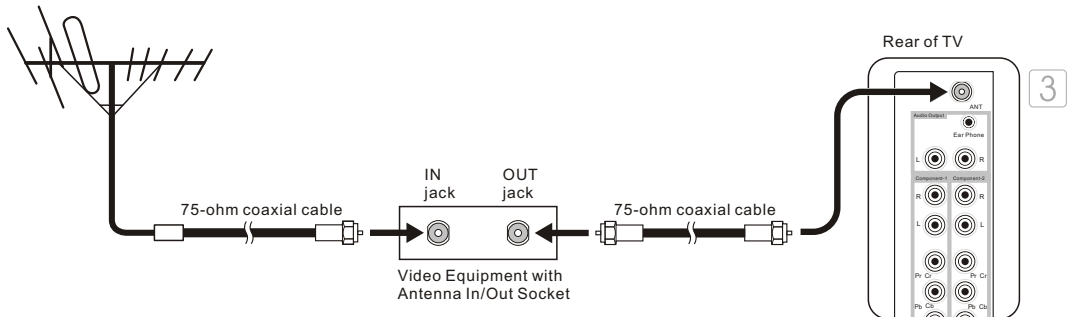

Connecting to a VCR

⚠ Disconnect all power sources before making any connections.

Use this hookup if you subscribe to a cable TV system that does not require a cable box.

1. Using A/V cable and S-Video cables, connect the VCR's Audio and S Video OUT jacks to the TV's Audio and S-Video In jacks.

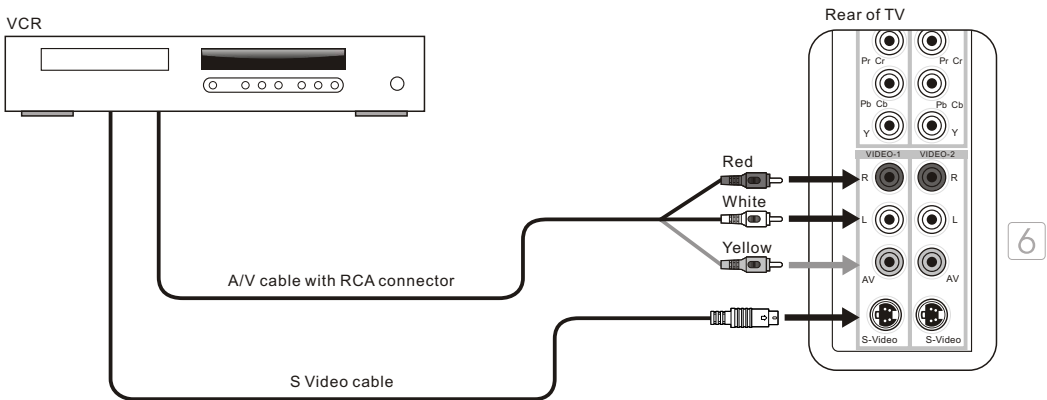

Connecting both Video IN or S-Video IN

Note: When you connect video equipment to both the same Video and S-Video input jacks, display will automatically select S-Video first. To view Video signal, please disconnect the S-Video jack or turn off the S-Video signal on the video equipment.

S-Video is strongly recommended for use if your VCR or video equipment has it. S-Video input has a better quality of picture than a composite Video signal.

Connecting to an Audio Receiver / Home Theater System

⚠ Disconnect all power sources before making any connections.

1. Using an audio cable, connect the TV's audio OUT jack to the audio receiver's audio IN or AUX IN jacks.

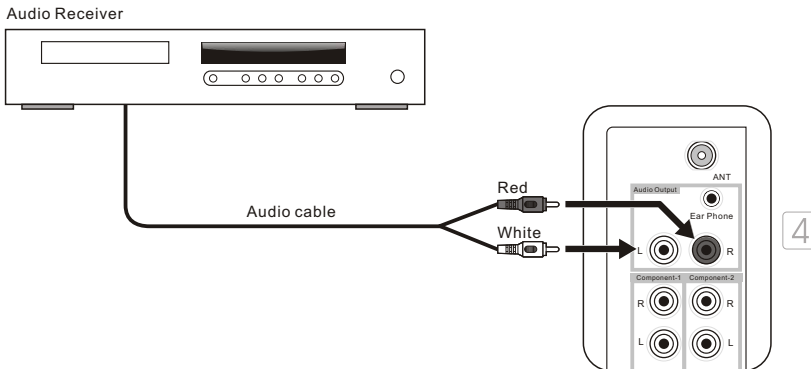

Note: When connecting an Audio output signal, an external Audio amplifier is necessary to amplify the signal for external speakers.

Note: If the audio out is hooked up to a home theatre sound system, please disable the audio in the OSD by selecting off in audio section. Volume adjustment must be made on the home theatre receiver. By not disabling the TV's speaker it could damage the speakers or TV itself.

Connecting to a DVD Player with A/V or S Video Cables

⚠ Disconnect all power sources before making any connections.

Use this hookup if your DVD player does not have component (Y, Pb, Pr) jacks.

Note: If your DVD player has component video output connectors, for best picture quality, use the connection described for *Connecting to a DVD Player With Component Connectors.* (See page.17)

1. Using an A/V cable, connect the DVD player's Audio OUT jacks to the TV's Audio IN jacks.
2. Using an SVideo Cable, connect the DVD player's S Video OUT jack to the TV's S Video IN jack.

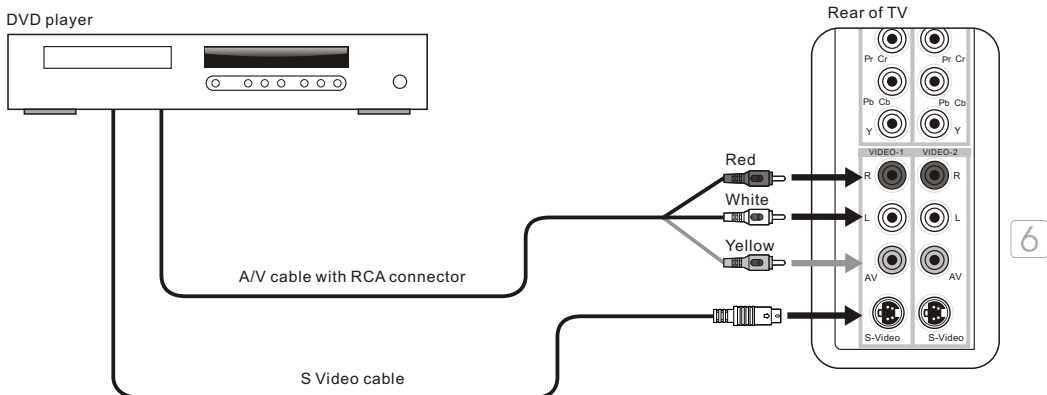

Note: When you connect video equipment to both the same Video and S-Video input jacks, the display will automatically select S-Video first. To view Video signal, please disconnect the S-Video jack or turn off the Video signal on the video equipment.

S-Video is strongly recommended for use if your VCR or video equipment has the option. S-Video input has better quality of picture than a composite Video signal.

Connecting to a DVD Player With Component Cables

⚠ Disconnect all power sources before making any connections.

Use this hookup if your DVD Player has component (Y, Pb, Pr) jacks.

1. Using a component video cable, connect the DVD Player's Y, Pb and Pr jacks to the Y, Pb and Pr jacks on the TV.

Colors on Component Video connectors:

Y: Green

Pb (also identified as Cb, CB or B-Y): Blue

Pr (also identified as Cr, CR or R-Y): Red

Note: The Y, Pb and Pr jacks on your DVD player are sometimes labeled as Y, Cb and Cr, or B-Y and R-Y. If so, connect the cables to the matching colors.

2. Using an Audio cable, connect the DVD player's Audio OUT jacks to the TV's Audio in jacks.

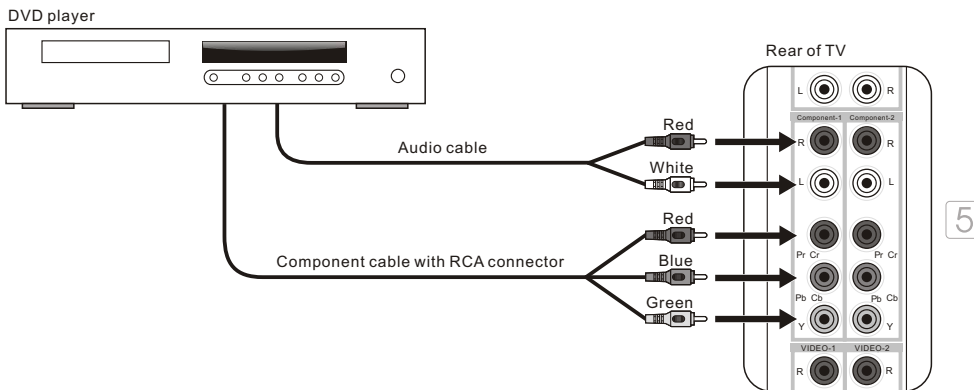

Note: The Y, Pb and Pr jacks do not provide audio, so audio cables must be connected to provide sound.

Note: The YPbPr connection provides the best quality of video signal compared to AV (Composite) and S-Video connection.

Connecting to a Satellite Receiver or Cable Box with A/V Connectors

⚠ Disconnect all power sources before making any connections.

1. Using Audio and S Video cables, connect the satellite receiver's Audio and S Video OUT jacks to the TV Audio and S Video IN jacks.
2. Connect a 75-ohm coaxial cable from your cable or antenna to the Satellite Receiver's or Cable Box's Ant (Antenna) jack.

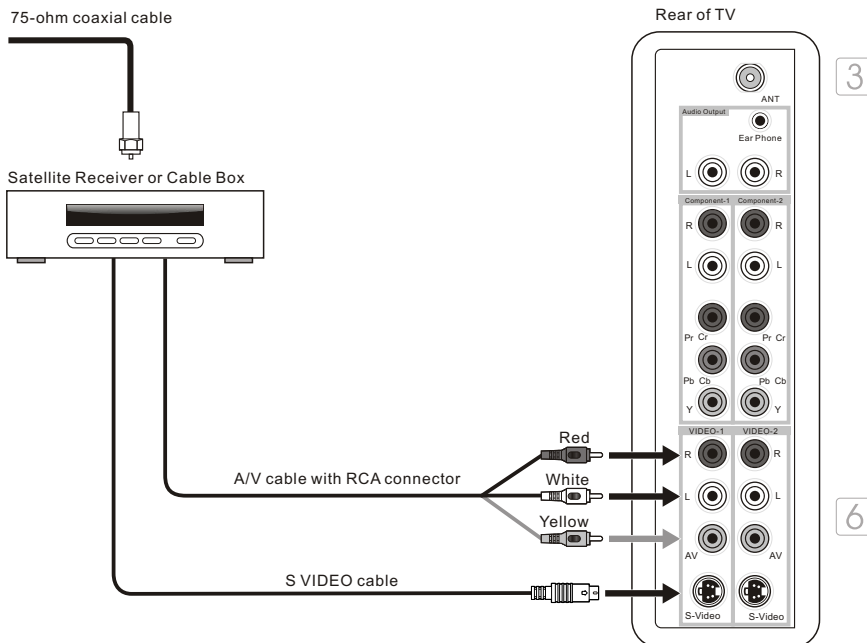

Note: When you connect video equipment to both the same Video and S Video input jacks, display will automatically select S Video first. To view S Video signal, please disconnect Video jack or turn off the Video signal on the video equipment.

S-Video is strongly recommended for use if your VCR or video equipment has it because S-Video input has better quality of picture than a composite Video signal.

Connecting to a Satellite Receiver or Cable Box With Component Connectors

⚠ Disconnect all power sources before making any connections.

Use this hookup if your Satellite Receiver or Cable Box has component (Y, Pb, Pr) jacks.

1. Using a component video cable, connect the Satellite Receiver or Cable Boxes' Y, Pb and Pr jacks to the Y, Pb and Pr jacks on the TV.

Colors on Component Video connectors:

Y: Green

Pb (also identified as Cb, CB or B-Y): Blue

Pr (also identified as Cr, CR or R-Y): Red

Note: The Y, Pb and Pr jacks on your Satellite Receiver or Cable Box are sometimes labelled as Y, Cb and Cr, or B-Y and R-Y. If so, connect the cables to the matching colors.

2. Using an Audio cable, connect the Satellite Receiver or Cable Boxes' Audio OUT jacks to the TV's Audio in jacks.

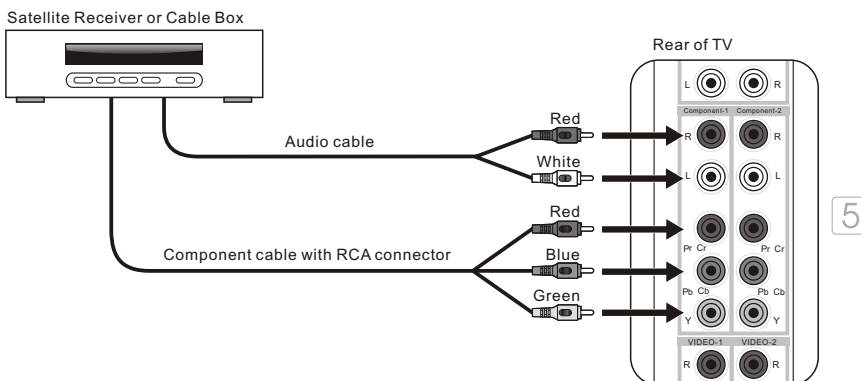

Note: The Y, Pb and Pr jacks do not provide audio, so audio cables must be connected to provide sound.

Note: The YPbPr connection provides the best quality of video signal compared to AV (composite) and S-Video connection.

Connecting to a PC with VGA Connector

⚠ Disconnect all power sources before making any connections.

1. Using a D-Sub 15 pin cable, connect the VGA output terminal of the PC to the TV's VGA signal input terminal.
2. You may need to use a Stereo mini jack to RCA L/R connectors to receive audio.

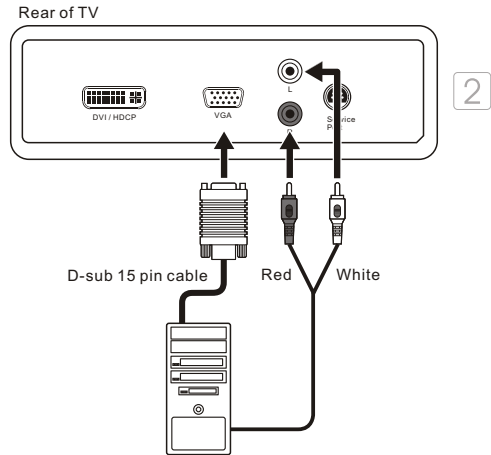

Connecting to a DVD Player or HD-Receiver with a DVI/HDCP Cable

⚠ Disconnect all power sources before making any connections.

1. Using a DVI cable, connect the DVD's DVI output terminal to the TV's DVI-HDCP input terminal.
2. Using an Audio cable, connect the DVD's Audio OUT jacks to the TV's Audio IN jacks.

Note: VGA and DVI/HDCP Connectors share the same audio input.

Note: HDCP is a copy protected digital connection that receives analog or digital video signals from equipment with DVI output that features the HDCP function. DVI allows the transfer of digital uncompressed data to the TV. DVI technology is better than Component, S Video or AV (composite) connections.

Note: DVI signal is purely digital and provides a crystal clear technology better than component, S-Video or Video connections. It is strongly recommended to use this connection if you have this function on your equipment.

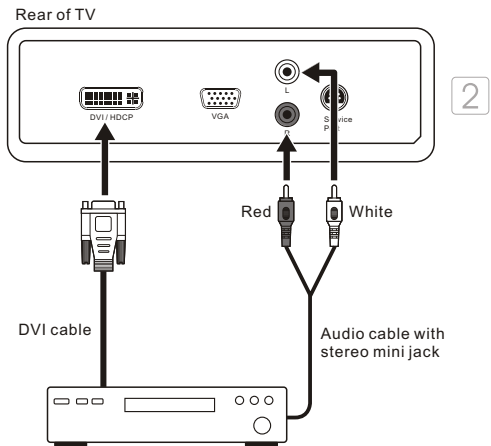

Other Connections

⚠ Disconnect all power sources before making any connections.

See setup instructions for: Connecting to an Audio Receiver on page 15.

Speaker Outputs

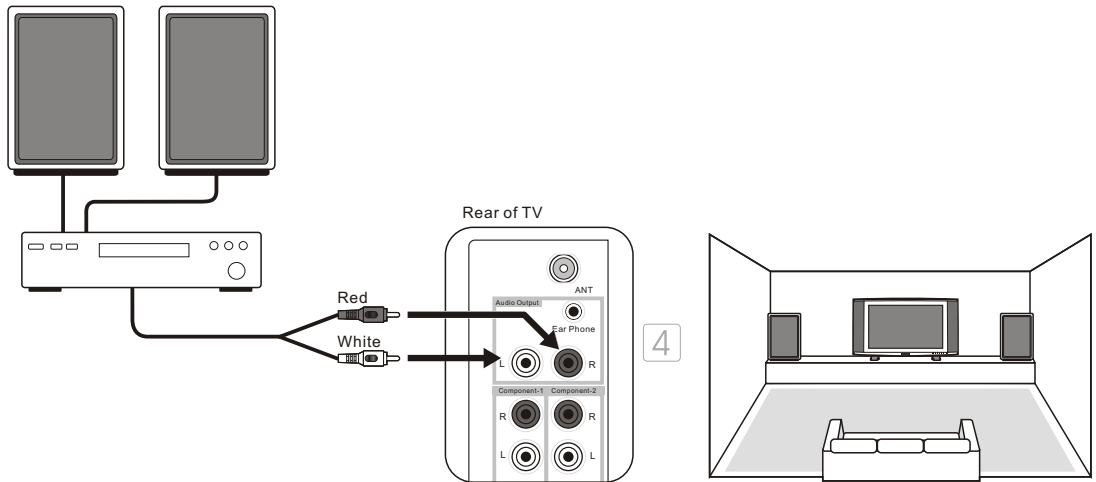

Headphone Set

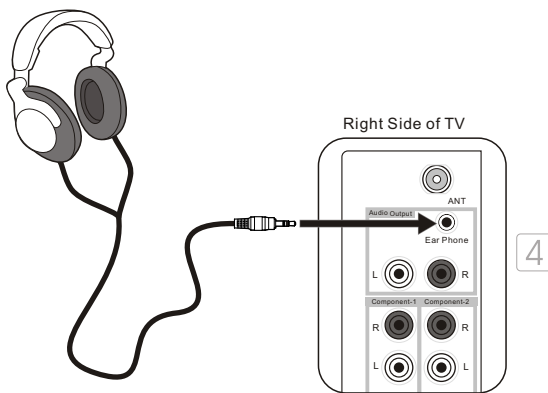

Note: When headphone is plugged in the speaker will turn into mute mode.

Remote Control Guide

Remote Function Keys & Description

Regular Buttons

- 1 POWER** Press to turn display on/off.
- 2 CH + / CH-** Press to adjust channel up and channel down.
- 3 NUMBER BUTTONS** Press the number buttons to select channels on the display.
- 4 VOL+ / VOL-** Press to adjust the volume.
- 5 RETURN (Channel Return)** Press to return the to previous-channel.
- 6 MTS** Press to select from SAP, Mono or Stereo mode
- 7  buttons (Direction Buttons)** Press to move highlighted selection through menus or submenus.
- 8 SOURCE** Press to show the source input from TV 1, AV 1, AV 2, SV 1, SV 2, YPbPr 1, YPbPr 2, DVI and VGA.
- 9 ENTER** Press to enter the channel number, highlighted menu or submenu item.
- 10 MUTE** Press to mute the sound.
- 11 MENU** Press to activate or close the On Screen Display menu. In OSD Menu, acts as a cancel button while navigating through the OSD.
- 12 DISPLAY** Press to display the information of current channel number.
- 13 Hotkeys** Press to directly access certain Shortcut TV functions..

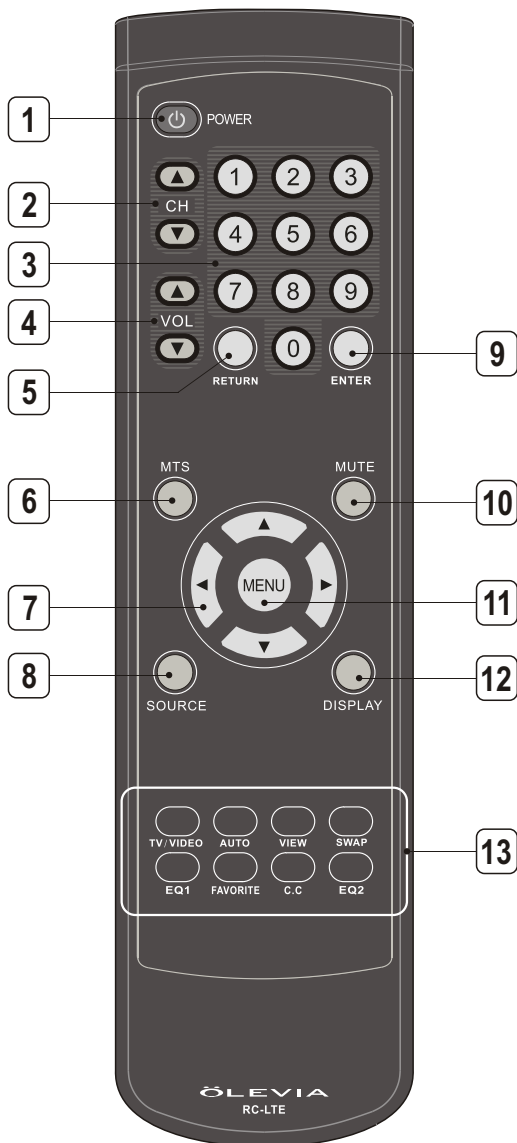

Hot Keys Tutorial

The remote control contains 15 additional "Hotkeys" that represent direct access to a certain function on your TV. Hotkeys enable you to directly change the setting to your preference without having to navigate through the OSD (On Screen Display) Menu.

How to use your Hot Keys

HOT KEY FUNCTION

TV / VIDEO Press to select a video signal from different sources (TV 1, AV 1, AV 2, SV 1, SV 2, YPbPr 1, YPbPr 2, DVI and VGA).

AUTO (Auto adjustment) Under VGA mode, the screen position could be automatically adjusted by pressing "Auto" button, when the screen image is not centered.

VIEW Press to select and program PIP, Split Screen or viewing options.

SWAP Press to select TV channels between main and sub screen. (This function is only in the PIP and Split Screen modes.)

EQ1 This function will provide an environmental effect to the audio for an added live experience.

FAVORITE Press to select favorite channels. Can be preset in OSD Menu.

C.C. Press to call up the Close Caption (CC) and Caption Service (CS) list. You can pre-select one to see Closed Caption.

EQ2 This function will provide a preset equalized effect to the audio for added audio definition.

Note: EQ1 and EQ2 selections can be used simultaneously to suite your preference.

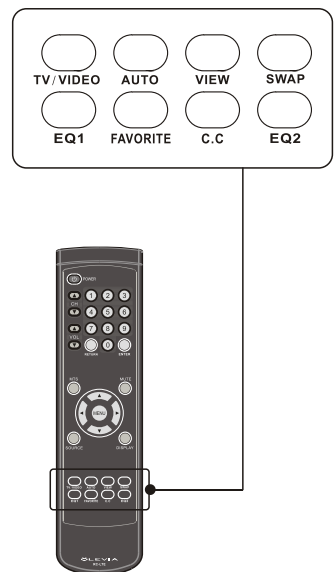

Battery Installation

1. Push the tab and pull it out as illustrated below.
2. Insert two size AAA batteries (supplied) by matching the (+) and (-) on the batteries to the diagram inside the remote control's battery department.
3. Replace the cover back and make sure the cover "snaps" into the remote control.

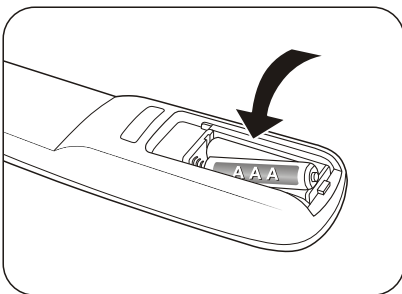

Note:

1. The display unit comes with two new AAA batteries as accessories. However, due to uncontrollable causes, the electricity of the accessorized batteries may be partially or completely drained. We do not warrant the quality of the batteries in any case since many factors are considered. If replacement is needed, please purchase two AAA batteries.
2. Handle remote with care. Avoid dropping it, placing in direct sunlight, near a heater, high areas of humidity or getting it wet. If the remote gets wet, please wipe it dry immediately. In the event of the remote not working properly or is inoperational, a replacement of remote control may be required.
3. If you do not use the remote control for a long period of time, please remove the batteries and store in a cool place to preserve battery life.
4. Do not mix new and used or with different types of batteries for operation.

Adjusting On Screen Displays (OSD)

Introduction

After you have finished connecting your TV, you are now ready to choose and personalize your TV settings in the OSD (On Screen Display) menu.



There are four main sections in the OSD Menu:

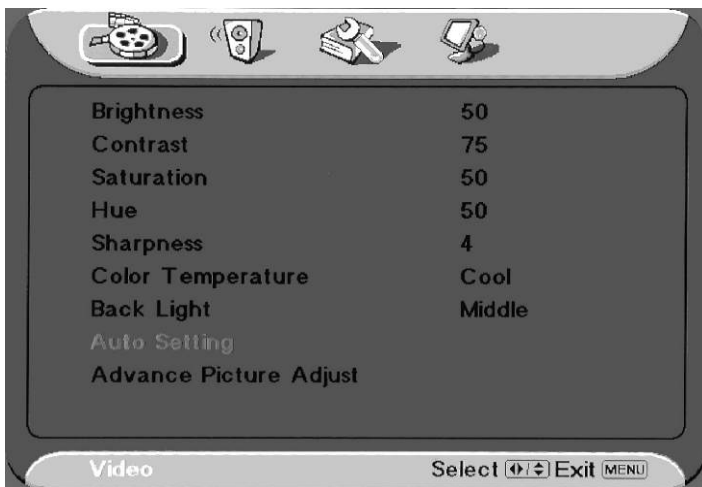

Video Audio Miscellaneous Screen



To Operate in the OSD

1. Press "Menu" button to enter OSD menu mode.
2. In Main OSD Menu, use the ► and ◀ keys to select and enter each main OSD Section: Video; Audio; Miscellaneous; Screen.
Note: The OSD Section appears at the bottom left corner of the OSD Screen at all times.
3. In Each OSD Section, press the ▲ and ▼ to select the function, and the  button to make an adjustment or selection.
4. To adjust the value bar, use the keys ► and ◀
5. After choosing your setting, press the ◀ to go back into Main OSD Section. To exit, press  to go back to Main OSD Menu.
6. To exit the OSD menu, press "Menu" until you exit the OSD menu, or without action for 12 seconds of inactivity. This is also adjustable in the OSD.

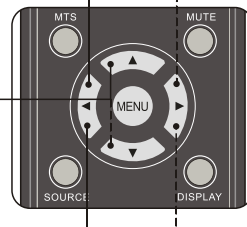

VIDEO Adjusting TV Picture Settings

Advance Video Quality

In this Setup Index, you can adjust the video and picture settings to suit your personal preferences.

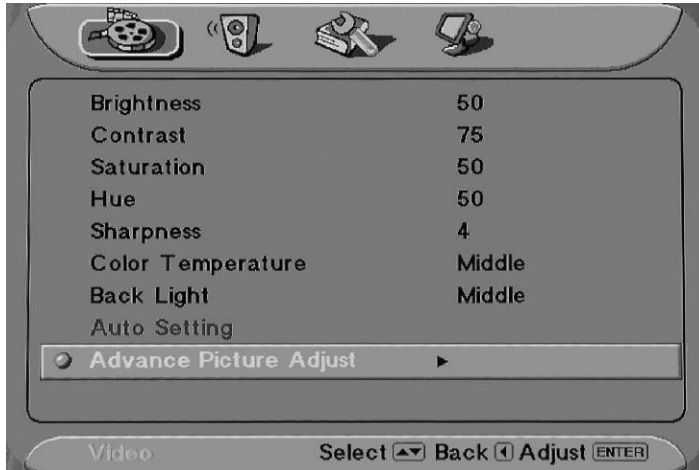

Video Settings

Item	Adjustment	Function
Brightness	0~100	Adjusts picture brightness contrast
Contrast	0~100	Adjusts picture color contrast
Saturation	0~100	Adjusts the color intensity
Hue	0~100	Adjusts the tint or shade of picture
Sharpness	0~100	Adjusts the picture sharpness or softness
Color temp	Cool / Middle / Warm / User	Adjusts image color intensity. Cool: More blue-tinted colors Middle: Standard color temperature Warm: More red-tinted colors User: Allows User to adjust RGB Gain
Red Gain	0~100	Adjusts the color control with red tones
Green Gain	0~100	Adjusts the color controls with green tones
Blue Gain	0~100	Adjusts the color controls with green tones
Backlight	Bright / Middle / Dark	Adjusts the darkness or lightness of the screen
Auto Setting	Enter	Adjusts OSD Settings back to factory default
Advance Picture Adjust	Enter	Adjusts additional specific picture settings (DNR, Black Level Extender, White Peak Limitor, Flesh Tone, Adaptive Luma Control)

Advance Picture Adjust

To further adjust specific picture settings, enter this function by pressing the ► button.



Advance Picture Adjust

Definition of Terms

Item	Status	Description and Function
DNR	Off/Low/Middle/Strong	DNR-Dynamic Noise Reduction. Reduces high frequency noise dynamically. Off- Dynamic Noise Reduction is disabled. Low/Middle/Strong---Set the DNR in low/medium/strong degree.
Black Level Extender	On/Off	Black Level Extender -Extends "grays" to black so a more accurate picture is produced with a wider contrast scale. On-The Black Level Extender is enabled. Off-The Black Level Extender is disabled.
White Peak Limitator	On/Off	White Peak Limitator-Limit the signal amplitude varying degree resulted in brightness over saturation. On-The White Peak Limitator is enabled. Off-The White Peak Limitator is disabled.
Flesh Tone	On/Off	Most LCD TV's video processing solutions have a red push to the their color matrix. With the FleshTone Control option, it helps to tone down these strong reds and produce more naturalistic color tones. On-Flesh tone adjustment is enabled. Off-Flesh tone adjustment is disabled.
Adaptive Luma Control	On/Off	Control the luminance adaptively. On-The Adaptive Luma control feature is enabled. Off-The Adaptive Luma control feature is disabled.

To Adjust Settings:

Use the ► and ◀ remote buttons to adjust each Video picture setting, as seen below:

Brightness

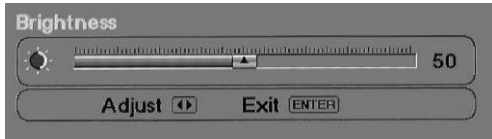

Saturation

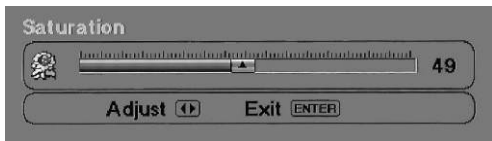

Hue

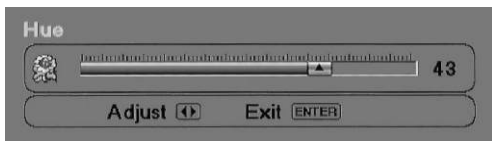

To exit, press the  Button

To Reset Factory Settings

If, at any time, you wish to go back to original factory setting, you may do so by choosing the Default setting in the OSD Picture and Audio Sections.

Selecting "Default," will reset all OSD settings to the original manufacture settings. The only items which will remain unaffected, are:

- Clock
- Auto Scan Channels
- Edited Channels
- Parental Control Password

Audio Adjusting Sound Quality



Audio setting

Definition of Terms

Item	Adjustment	Function
Treble	-50~50	Adjusts higher pitched sounds
Bass	-50~50	Adjusts lower pitched sounds
Balance	-20~20	Adjusts volume balance in Left and Right
Surround	On / Off	Creates a panoramic stereo audio image by producing deep and rich bass tones and clear treble tones. This enables you to enjoy powerful sound effects like those in a movie theatre
Equalizer 1	Off, Concert, Living Room, Hall, Arena, Church	Adjusts the sound as occurred in an enclosed space of varying spaces
Equalizer 2	Off, Rock, Pop, Live, Classic, Soft	Adjusts the volume of different bands (ranges of frequencies (HZ)) to control the overall sound
MTS	Mono, Stereo, SAP	Adjusts sound reception of stereo, bilingual and mono programs under the TV Source.
Speakers	On / Off	Turns off the speakers of the TV when using a Receiver or Home Theater System.

To Adjust Settings:

Use the ► and ◀ remote buttons to adjust each Audio sound quality, as seen below:

Treble



Bass

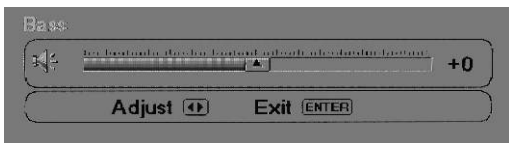

Balance

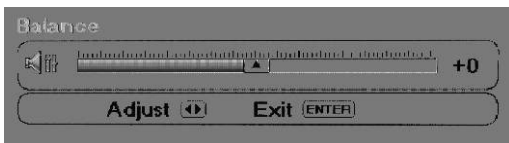

Surround Sound is an available option for creating a panoramic stereo audio image by producing deep and rich bass tones and clear treble tones. This enables you to enjoy powerful sound effects like those in a movie theater.

Speakers

Must turn off speakers of the TV when using a Receiver or Home Theater System.

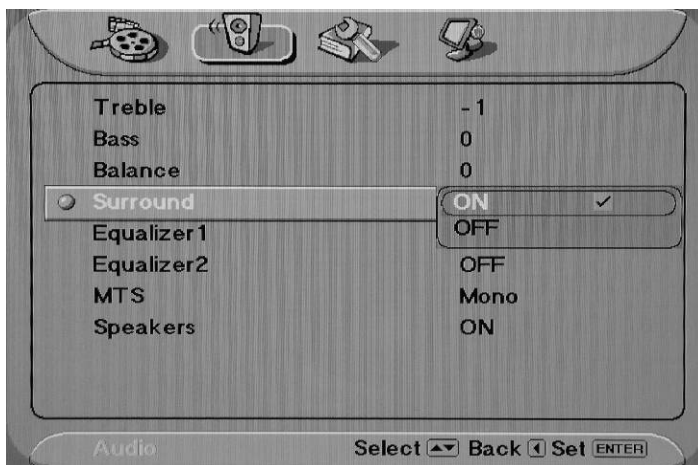

OSD Audio Settings: Equalizer 1



OSD Audio Settings: Equalizer 2



MTS System for Stereo TV

You can enjoy stereo, bilingual and mono programs.



Additionally, you can press the hotkey "MTS" until the desired sound indication appears. Each time you press the button, the sound indication changes as follows:

Mono, Sap, Stereo

Definition of Terms

Sound Effect	Description
Stereo	Select for stereo reception when viewing a program broadcast in stereo
SAP	Select to automatically switch the TV to Secondary Analog Program when a signal is received. (If no SAP signal is present, the TV remains in Stereo Mode)
Mono	Select for mono reception. (Use to reduce noise during weak stereo broadcasts)

MISCELLANEOUS Adjusting Personal TV Settings

In this Section, you can adjust additional TV settings to your personal preference, including channel setup, choosing tuner modes, setting up timer, closed caption services, parental controls, and viewing the OSD in your preferred language.



Description of Settings

Item	Adjustment	Function
Channel Setup		Setting up Channel functions
Channel-Favorite	24 favorite channels setting	Stores the favorite channels
Channel-Skip		Sets up available channels. Add : To add available channel. Skip : To cancel available channel
Channel-Name		Stores channel names
Tuner Mode	Air / Cable	
Auto Search		Selects to auto scan the available channels of the TV or CATV.
Timer	Time, Start/Stop Time, Channel, Activate option, Display option	Set Alarm with channel preference
Closed Caption	C1, C2, C3, C4, T1, T2, T3, T4	Switches different types of caption or cancel caption functions.
Parental	MPAA G/PG/PG-13/R/NC-17/X Tv rating TV-Y/TV-Y7/TV-Y7-FV NPAA Unrated TV-G/TV-PG(V,S,L,D)/ TV-14(V,S,L,D)/TV-MA(V,S,L) TV None Rating Password	Adjusts MPAA and TV Ratings under parental control settings and setup password lock.
Language	English / Deutsch / Francese / Italiano / Español / Português and Русский. 繁體中文 / 簡中	Switches the OSD language
Default		Resets OSD setting to default.

Setting the Channels

After you finish connecting your TV, you can run Auto Scan program to setup your channels. The program will scan and preset all receivable channels automatically.

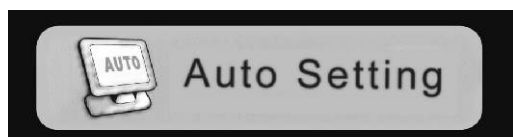

To Cancel Auto Program

Exit auto scan program by pressing "menu" Key.

Note: The Auto Scan is set to scan cable TV channels by default. You cannot receive and set the cable TV channels VHF/ UHF channels at the same time.

Setting Favorites Channels

You can select and store a list of your favorite channel settings. Selected favorite channels are marked with a  icon.



You can preset favorite channels on this page. You can also access this function by pressing the " FAVORITE " hotkey on the remote control and select or switch between your favorite channels .

1. Enter "Channel-Favorite" mode.
2. Press "Edit " to enter the channel(s) using the number keys.
You can "Delete" channels per line or "Empty" all channels at once.
3. Press "View" to see the selected channel display in real time.
4. Press "Enter" to exit when complete.

Watching favorite channels

To watch your favorite channels after specifying your preferences, just press the Hotkey "FAVORITE" to browse through each favorite channel.

Editing Channels

You can also edit channels to your personal preference. Once you edit a channel, it will be skipped when surfing through TV channels.

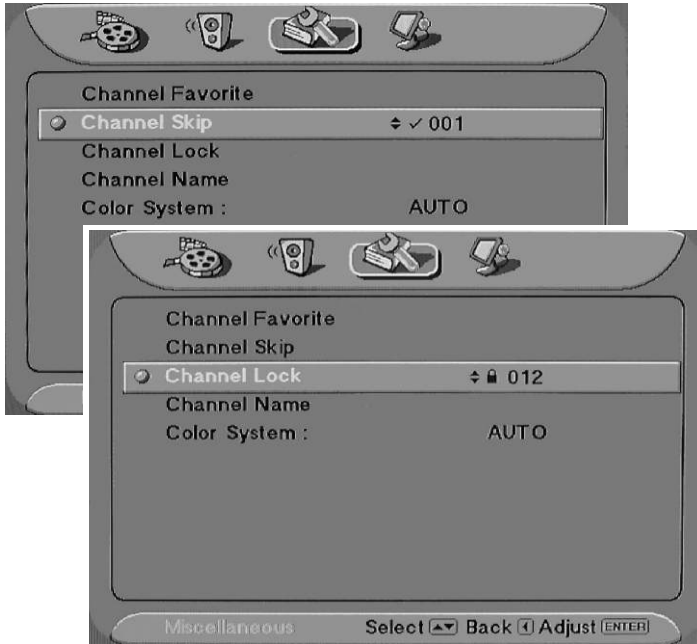

To Skip or Lock a Channel

1. Make sure Channel Skip or Channel Lock is highlighted.
2. Enter the channel number you wish to skip or lock, or scroll through channels using the ▲ and ▼ Arrow.
3. Press "Enter" to make your selection or adjustment.
Note: You will see a checkmark next to Skipped Channels, and a small lock icon next to Locked Channels.
4. Press ◀ to exit when complete.

To Undo a Skipped or Locked Channel:

1. Make sure Channel Skip or Channel Lock is highlighted.
2. Enter channel number you wish you undo, or scroll through channels using the ▲ and ▼ Arrow.
3. Press "Enter" to make your selection or adjustment.
Note: You will NOT see a checkmark next to Skipped Channels, or a small lock icon next to Locked Channels afterwards.
4. Press ◀ to exit when complete.

Personal Channel Preferences: Channel Naming

You can also create personal names for each channel, which will show up in the upper Right hand corner of the TV screen.

To Name a Channel:

1. Enter Channel Name sub-page
2. Enter Channel name using alphabet-numerical keypad as seen below:



3. Press "Okay" to exit keypad when naming is complete.

Once you have named a channel, your preset channel name will show up on the TV screen when flipping through channels, or by pressing the Display Key.



If you named your favorite channel, you will see the heart icon  next to the channel name.

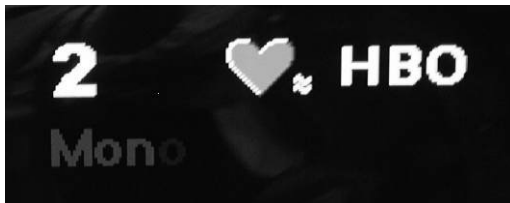

Setting up the TV Timer



To setup the time on the TV:

1. Using ▲ and ▼ keys, enter in HH: MM: SS Enter the time using the number keys found on the remote.
2. press "Enter" when complete.

NOTE: Clock will NOT BE affected when Factory Default settings are reset. Under Activate, "ON" allows the start/stop time to be ongoing whereas, "ONCE" allows it to only function once.

However, when the power cord is not connected to the TV, you will lose all previous time adjustments.

Timer: Start Time / Stop Time

You can set the TV to turn On and/or Off automatically at a predetermined time through the timer function. Use the Start Time to setup the hour and minute preferences. Your TV will automatically turn on at the set time. Use the Stop Time to setup the hour and minute preferences. Your TV will automatically turn off at the set time.

Note: Alarm WILL BE affected when Factory Default settings are reset.

When the power cord is not connected to the TV, you will lose all previous saved adjustments.

Watching with Closed Caption



You can display closed captioning if the broadcaster offers this service.

Close Caption option can be set On/Off from the OSD page. This function also can be accessed by pressing "C.C" hotkey on the remote control.

1. Not all programs offer the Closed Caption option.
2. Closed Caption may not be seen clearly (white blocks, strange characters, etc.) if the signal condition is poor, or if there are technical difficulties with the broadcaster.
3. If no TEXT broadcast is being received while viewing in the [TEXT] mode, the screen may become dark and blank for some programs. Switch Off the Closed Caption mode.

TV OSD Languages

There are nine language formats available for the OSD Menu. You may choose from the following:

English, Chinese Traditional, Chinese Simplified, Deutsch, Francese, Italiano, Español, Português and Русский.



Using the Parental Control Feature

To block programs you feel unsuitable for your children, you need to Set the TV for desired rating systems. The TV Parental Control feature functions by receiving the rating signal from your local broadcasting station or cable service provider.

The TV programs and movies shown on TV are given a rating signal based on the following rating systems.

In U.S.A.: U.S. Television Parental Guidelines to rate television programs (U.S. TV Ratings) and Motion Picture Association of America (MPAA) Guidelines to rate movies including those shown on TV (Movie ratings).

In Canada: Canadian English Language ratings to rate television programs in English, and Canadian French Language ratings to rate those in French.

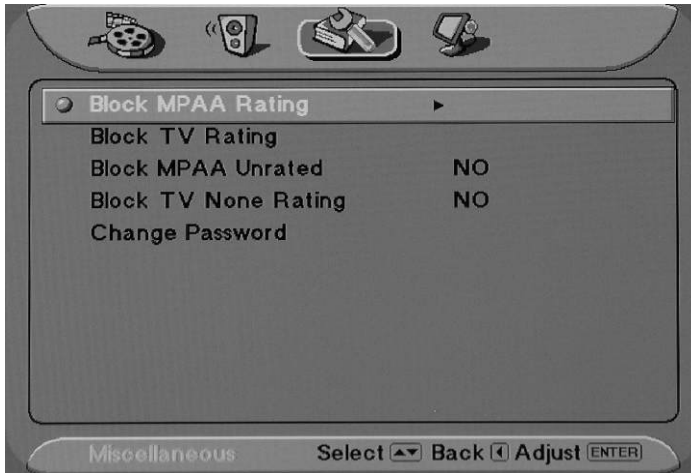

Parental Control

1. This function allows programs to be restricted and controlled by parents based on FCC regulation. It prevents children from watching program contents that may be prohibited by parents.
2. Restriction of programs is based on three Rating Systems: MPAA Rating, TV (Child) Rating and TV (Entire Audience) Rating. The MPAA Rating restricts based on age. TV (Child) rating and TV (Entire Audience) Rating restrict based on age and contents.
3. When you block the lower rating, the higher age-based ratings are blocked automatically.
4. When you enter "Parental control" mode, those messages display for different state.

The Parental Control Main Menu contains four options in the following categories:

- 1.MPAA Rating
- 2.TV Rating
- 3.MPAA Unrated
- 4.TV Unrating

Activating the Parental Control Feature

Once you enter the highlighted section of Parental Control, you will have to enter your password. The Factory Default password is "9999". Once you enter the Parental Control Menu, you may change the password to your personal preference.



To setup, enter each sub-menu to setup your parental controlled TV channels.

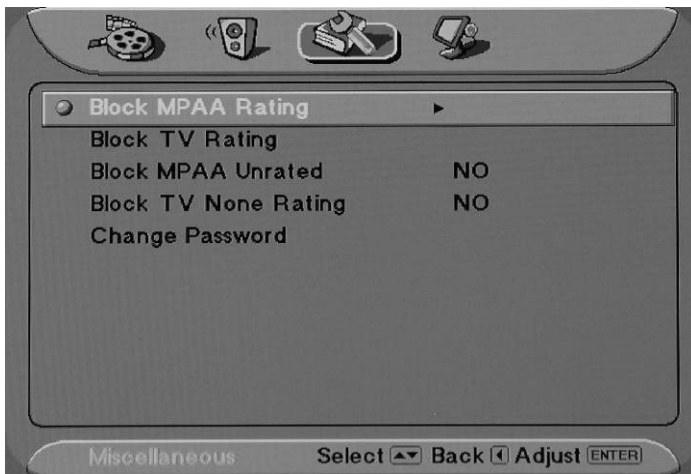

MPAA Rating controls channels and movies that are rated from **G**, **PG-13**, **R**, **NC-17**, and **X**.

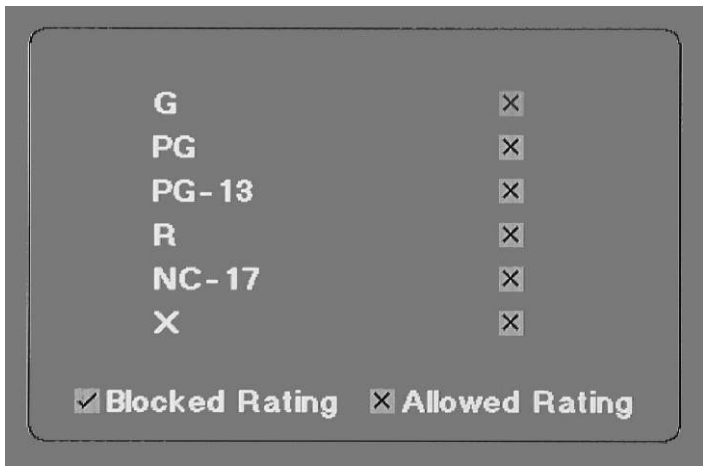

TV Rating controls channels and movies that have been rated from **TV-Y**, **TV Y-7**, **TV-G**, **TV-PG**, **TV-14**, and **TV-MA**.



To Block Unrated Channels

You may choose "YES" for Block MPAA Unrated and Block TV None Rating. This will lock you from accessing any channels that do not contain MPAA or TV Ratings. To watch unrated channels, re-activate Block MPAA Unrated and Block TV None Rating to "NO".

Setting up Parental Control Password

Enter the password sub-page. Enter the current password. If this is the first time, you do not have to enter a password.



You will have to enter and confirm your password before changing to a new password. Please keep password within 4 numbers.



If you enter the incorrect password, you will see an error page. Please re-enter the new password and confirmation password again.

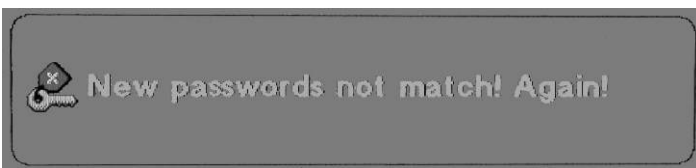

Note: If you forget the password, press "9999" to lift the Password lock and change to a new preferred password.

Factory Default Option



Reset Factory Settings:

Initiating Factory Default will reset all OSD settings to original manufacture settings. The only items, which will remain unaffected are:

- Clock
- Auto Scan Channels
- Edited Channels
- Parental Control Password

Adjusting Screen Modes

There are two options in the Screen Modes, "Aspect" & "View." Aspect will allow user to select different aspect ratios, whereas, View will allow different modes of viewing 1 or 2 sources.



Changing the Screen Mode



You can alter the aspect ratio of a picture by choosing between these four options:

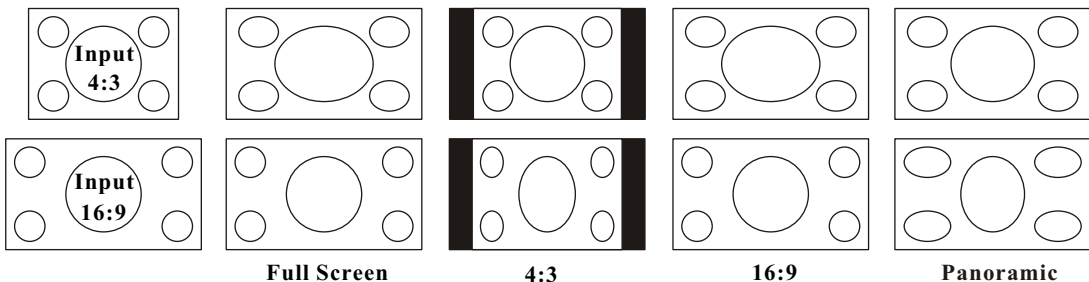

Full Screen Enlarges the picture to 16:9 wide mode, by stretching the picture horizontally only.

4:3 Returns the 4:3 picture to its original size. This is considered the "normal" viewing mode.

16:9 Enlarges (zoom-in) the size of a 4:3 picture on screen as geometric ratio, keeping the original image as much as possible.

Panoramic select to widen the displayed image. (only applies to content larger than 16:9)

Changing the View Modes

You can select four view types of picture modes that best suits the program you are watching. You can set a different view mode for each video mode for each input and store it manually.



View Modes	Function
PIP	Picture-in-Picture has a Main screen and small screen view
Split Screen	Full Screen split in two Views

Picture in Picture (PIP)

Allows you to view a main screen (Picture 1) and a secondary small screen (Picture 2).

Press 'source' button to switch from P1 to P2 and vice versa.

You may also choose the settings of P1 and P2 as well as the position of P2 on screen.

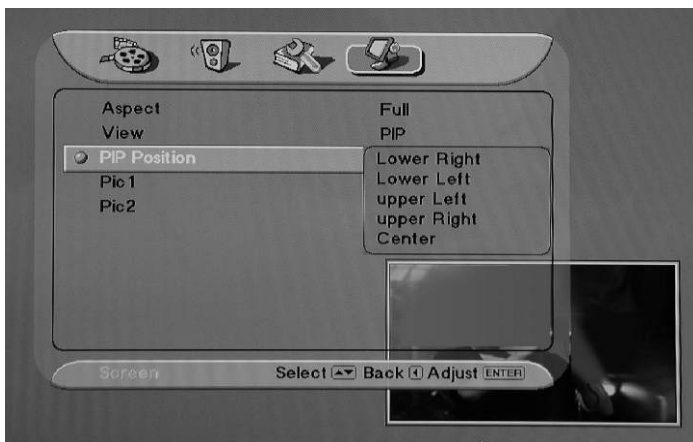

OSD View

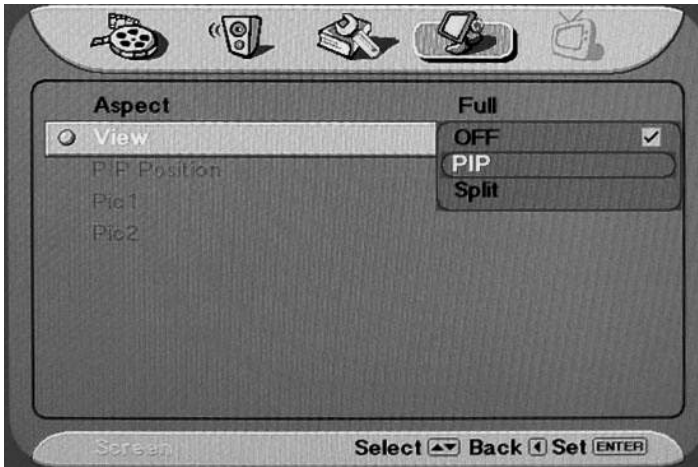

TV View

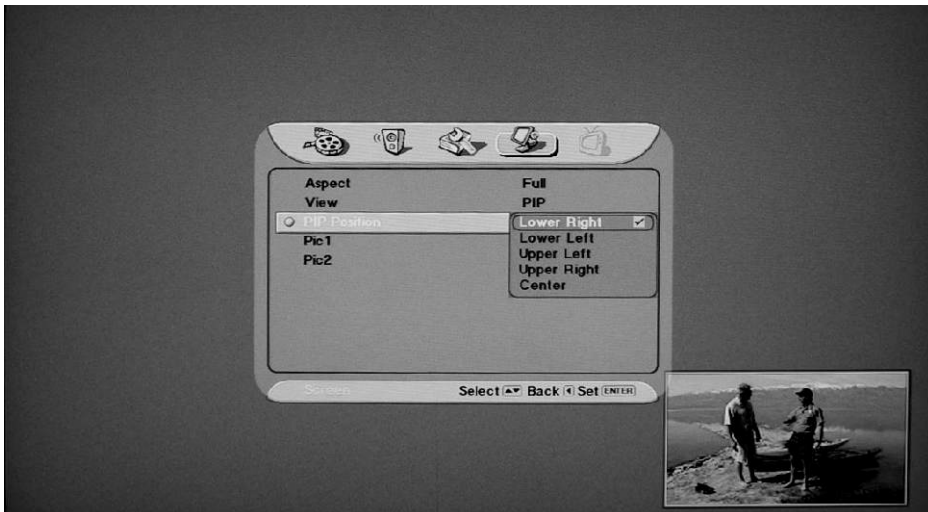

PIP mode

You may adjust setting for each Picture source. Pic 1 allows for a TV, AV1, AV2 and DVI sources while Pic 2 supports all other input sources.

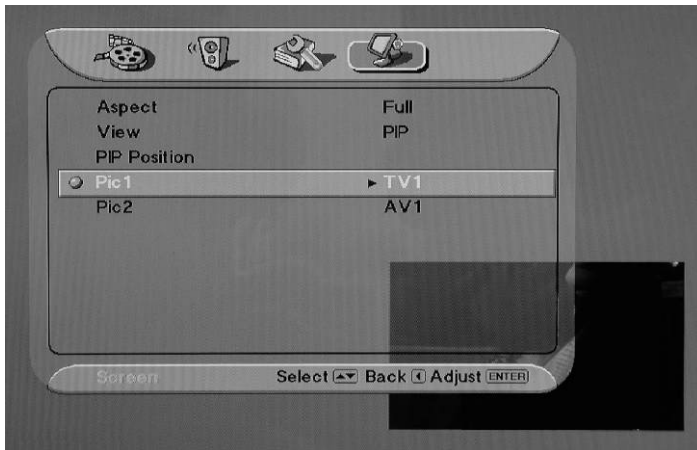

Item	Adjustment	Function
PIP Position	Upper Left / Upper Right / Lower Left / Lower Right	Changes the position of Picture 2
PIP-Pic1	TV1, AV1, AV2, DVI	Switches the source of Picture 1
PIP-Pic2	AV1, AV2, S-Video1, S-Video2, YpbPr1, YpbPr2, DVI, VGA	Switches the source of Picture 2

Note: Pic 1 allows for a TV, AV1, AV2 and DVI. Pic 2 allows for all sources except TV or if you are already using one of the other sources from Pic 1.

When you use the swap function, the signals from the main window and the PIP window will swap positions no matter what sources you specified on either window.

Split Screen

Allows you to view two separate screens simultaneously (Picture 1 and Picture 2).

Press 'source' button to switch from P1 to P2 and vice versa.

OSD View



TV View

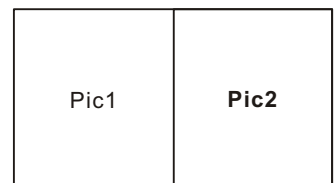
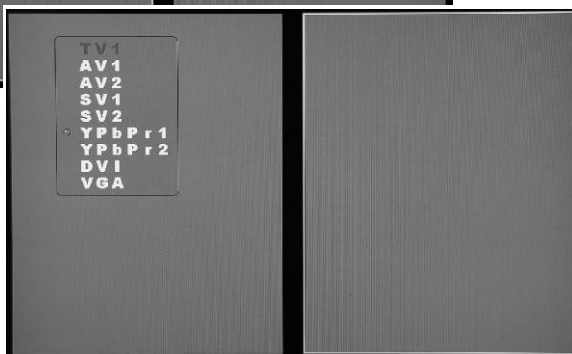
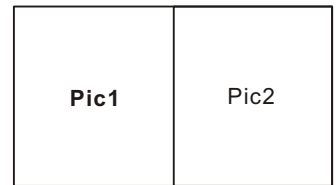
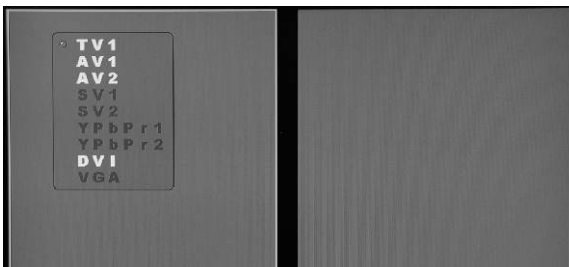

Split Screen mode

You may adjust setting for each Picture source. Only Pic1 supports a TV input source, while Pic2 supports all other TV input sources.

Item	Adjustment	Function
Pic1	TV1, AV1, AV2, DVI	Switches the source of Picture 1
Pic2	AV1, AV2, S-Video1, S-Video2, YpbPr1, YpbPr2, DVI, VGA	Switches the source of Picture 2

Note: Pic 1 allows for a TV, AV1, AV2 and DVI. Pic 2 allows for all sources except TV or if you are already using one of the other sources from Pic 1.

When you use the swap function, the signals from the main window and the PIP window will swap positions no matter what sources you specified on either window.

Specifications

Specifications	LT32HVE	LT32HVM
Panel Size	32"	32"
Aspect Ratio	16:9	16:9
Pixels	1366 X 768	1366 X 768
Dynamic Contrast Ratio	1600:1	1600:1
H/V(View Angle)	178 ° (H) / 178 ° (V)	178 ° (H) / 178 ° (V)
Gray to Gray Response Time	8 ms	12 ms

Video/Graphic Processing		
PC Compatible Frequency	30~85 KHz(H) / 50~80Hz(V) Max. 1360x768 @60Hz	30~85 KHz(H) / 50~80Hz(V) Max. 1360x768 @60Hz
Video Compatibility	NTSC	NTSC
DTV & HDTV Compatibility	480i, 480p, 720p, 1080i	480i, 480p, 720p, 1080i
Aspect Ratio Adjustment	Full screen, 4:3, 16:9, Panoramic	Full screen, 4:3, 16:9, Panoramic
3D Comb Filter	Y	Y
3 : 2 / 2 : 2 Pull Down	Y	Y
Digital Noise Reduction	ON/OFF, Low, Middle, Strong	ON/OFF, Low, Middle, Strong
Adjustable Color Temperature	Cool, Middle, Warm, User	Cool, Middle, Warm, User
De-interlacer	Y	Y
VGA Auto Frequency Correction	Y	Y
TV Auto Frequency Detection	Y	Y

Audio Processing		
Auto Sound Level Control	Y	Y
Output Watt	15W + 15W	15W + 15W
Sound Effect	MTS (Mono / Stereo / SAP) EQ1 and EQ2	MTS (Mono / Stereo / SAP) EQ1 and EQ2

Input Terminals		
TV Tuner	NTSC VHF/UHF tuner x 1	NTSC VHF/UHF tuner x 1
Video Input(Rear Side)	Input 1:AV x1, S-Video x1, RL x1 Input 2:AV x1, S-Video x1, RL x1 Input 3:Y, Pb/Cr, Pr/Cr x1, RLx1 Input 4:Y, Pb/Cb, PrCr x1, RLx1	Input 1:AV x1, S-Video x1, RL x1 Input 2:AV x1, S-Video x1, RL x1 Input 3:Y, Pb/Cr, Pr/Cr x1, RLx1 Input 4:Y, Pb/Cb, PrCr x1, RLx1
Graphic Input(Rear)	Input 1:RGB D-Sub 15 pin x1 Input 2:DVI-D(HDCP)x1, RL x1	Input 1:RGB D-Sub 15 pin x1 Input 2:DVI-D(HDCP)x1, RL x1
Service Port(Rear)	RS-232 mini DIN 6 pins X 1	RS-232 mini DIN 6 pins X 1

* **NOTE** : Product Specification is Subject to Change without Notice.

Output Terminals		LT32HVE	LT32HVM
Audio Output(Rear)		Output 1: Stereo Audio R/L x1	Output 1: Stereo Audio R/L x1
		Output 2: Earphone x 1	Output 2: Earphone x 1
Others			
Power	(Voltage)	100~240 VAC / 50-60 Hz	100~240 VAC / 50-60 Hz
	(Power Consumption)	135W	135W
	Stand-by	< 3W	< 3W
Dimensions (W x D x H)		39.8 in x 5.1 in x 21.72 in	39.8 in x 5.1 in x 21.72 in
Carton Dimensions (W x D x H)		42.52 in x 12 in x 26.38 in	42.52 in x 12 in x 26.38 in
Weight w/o stand		46.71 lbs	42.31 lbs
Weight		50.72 lbs	46.3 lbs
Gross Weight		66.15 lbs	61.74 lbs

Dimensional drawing

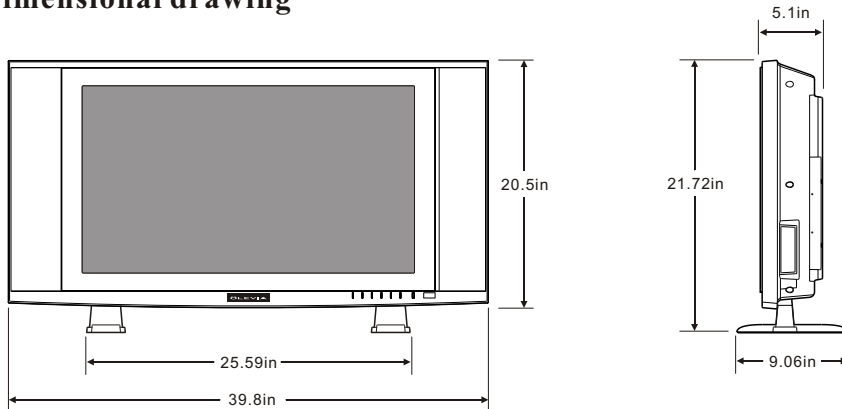

Timing Mode for VGA and DVI

Source	Resolution	Vertical frequency(Hz)	Horizontal frequency (Khz)	Pixel rate (MHZ)	
YPbPr	480p	59.94	31.469	27	
	720p	60	45	74.25	
	1080i	60	33.75	74.25	
VGA	512 x 384	60.147	24.48	15.667	
	640 x 350	85	37.861	31.5	
	640 x 400	85	37.861	31.5	
		56	24.823	21.05	
		59	30.296	24.964	
		640x480	59	30.295	25.024
		66	35	30.24	
	66	34.975	31.34		
	66	35	30.24		
	72	37.861	31.5		
	75	37.5	31.5		
	75	39.375	31.5		
	85	43.269	36		
	720 x 350	70	31.469	28.32	
	720 x 400	70	31.469	28.32	
		85	37.927	35.5	
		87	39.444	35.5	
	800 x 600	56	35.156	36	
		60	37.879	40	
		72	48.077	50	
		75	46.875	49.5	
		85	53.674	56.25	
	832 x 624	74.6	49.725	55	
	1024 x 768	59	48.193	64	
		60	47.699	64.1	
		60	48.363	65	
		70	56.476	75	
70		56.287	77		
71		57.87	75		
75	60.241	80			

Source	Resolution	Vertical frequency(Hz)	Horizontal frequency (Khz)	Pixel rate (MHZ)
VGA	1024 x 768	75	60.241	80
		75	62.937	84.6
		75	61.08	86
		75	60.023	78.75
		77	62.04	84.4
	1152 x 864	70.012	63.851	94.5
		75	67.5	108
	1152 x 870	75.062	68.681	100
	1152 x 900	65.95	61.795	92.9
		66.004	61.846	94.5
		76.047	71.713	105.6
		76.149	71.809	108
	1024 x 1024	60	63.36	89.2
		61.399	65.286	92.9
	1280x 960	60	60	108
	1280 x 720	60	45	74.25
	1280 x 768	60	48.36	81.631
	1280 x 1024	60	63.981	108
	1366 x 768	60	47.7	85.8
	DVI	1024 x 768	50.014	48.363
56.041			48.363	32.5
1280 x 720		60	45	74.25
800 x 600		60.317	37.879	40
1024 x 768		60.004	48.363	65
1280 x 768		60	48.36	81.631
1366 x 768		60	47.7	86

Pixels Policy

Syntax's D.O.A. Policy for LCD TVs for Defective Pixels on LCD Panels

(Applicable to the LCD TV sold within USA & Canada only)

Syntax™ LCD TVs are evaluated at a distance of approximately 50 centimeters (approximately 20 inches) between the LCD panel and the eyes of the user at a 90 degrees viewing angle. All LCD panels have been tested to ensure they comply with our factory standards. Our evaluation is based on the number of defective pixels and the distance between any two defective pixels. Bright dots are dots that appear bright and unchanged in size when a LCD TV screen displays under a black pattern; dark dots are dots that appear dark and unchanged in size when a LCD TV screen is displayed under pure red, green, or blue patterns ("defective pixels"). Adjacent dots are dots located directly next to each other.

Customers are required to check their LCD panel immediately after purchase. To identify defective pixels, the LCD panel should be examined under normal operating conditions as mentioned above, preferably in its native display resolution, and with a 90 degrees viewing angle.

A LCD TV will be considered dead on arrival (D.O.A.) with regards to defective pixels on the LCD panel when any one of the following criteria is met:

- A total of 7 defective pixels including both bright dots and dark dots are present (the typical 30" LCD Television screen has 16.7 million pixels), or
- 2 or more pairs of adjacent bright dots are present, or
- 3 adjacent bright dots are present, or
- 3 adjacent dark dots are present.

In view of customers' concerns about dead pixels, Syntax would like to address that defective pixels are not ultimately avoidable with the current LCD industry standard panel manufacturing processes. We always strive to improve our technology and minimize the chance of occurrence of defective pixels by applying strict screening processes in our factory production processes. However, Syntax cannot guarantee that a return unit to our customers will be 100% free of defective pixels.

For questions, please call our toll free service number in the USA at 888-SYNTAX-8.

"At SyntaxGroups, a satisfied customer is our most important focus."

Glossary

3:2 pull down - Process of converting 24 frames per second film to video by repeating one film frame as three fields, then the next film frame as two fields.

1	1	1	2	2	1	1	1	2	2
---	---	---	---	---	---	---	---	---	---

480I - 480 lines of display every 1/60 of a second; image is displayed by interlace scanning. See also Interlaced

480P - 480 lines of display every 1/60 of a second; image is displayed by progressive scanning. See also Progressive.

720P - 720 lines of display every 1/60 of a second; image is displayed by progressive scanning. See also Progressive.

1080I - 540 lines of display x 2 every 1/30 of a second; image is displayed by interlace scanning. See also Interlaced

16:9 - Aspect ratio under Hi Def. and theater movie formats. Also known as widescreen; see Aspect Ratio

4:3 - Aspect ratio under SDTV; see Aspect Ratio

Active Matrix TFT (Thin Film Transfer) - A type of display technology where the three primary colors are modulated. Results in better contrast ratios suitable for video.

Alarm - Feature on the Syntax Olevia models. Allows the unit to power on from the stand by mode.

Alarm Time - Time specified as to when the unit will power on. See Alarm.

Aspect Ratio - The ratio of an image according to the width and height of a picture.

ATSC - Advanced Television Systems Committee; international, non-profit organization that is committed to developing standards for digital television.

Reference: <http://www.atsc.org>

Bezel - Refers to the plastic or metal frame that acts like a shell around the LCD glass.

Backlight - Refers to the component, that lights up the LCD display.

Balance - Feature on the OSD for the Syntax Olevia models that adjust the left and right sound output from the speakers.

Background - Feature on the OSD for the Syntax Olevia models, which allows the user to change the OSD background, display to transparent or opaque.

Brightness - The measurement of color that is illuminated. Colors range from black to white.

CATV - Community Antenna Television (Cable Television)

Channel Favorite - Feature on the OSD for the Syntax Olevia models that allows the user to scroll through a defined list of channels that the user sets up.

Channel Edit - Feature on the OSD for the Syntax Olevia models that allows the user add or delete a channel.

Channel Source - Feature on the OSD for the Syntax Olevia models that lets the user select the source of their channels. Select TV for antennae or CATV for cable television.

Channel Auto Scan - Feature on the OSD for the Syntax Olevia models that when initiated, will determine which channels are available and which are not. If a desired channel is not accessible, you can add the channel in manually. See Channel Edit.

Channel Fine Tune - Feature on the OSD for the Syntax Olevia models that enables the user to tune the channel for better reception.

Chroma - (Chrominance) Refers to the color characteristics of a video signal.

CC - Closed Caption

Color - The term refers to the amount of color present. This varies between each user, as each person perceives colors differently.

Color Temperature - Feature on the OSD for the Syntax Olevia models that enables warm, normal or cool color settings. Warm emphasizes red, cool emphasizes blue, and normal doesn't emphasize any of the primary colors. This setting may affect each person individually depending on how color is perceived.

Comb Filter - A filtering system designed to removal unwanted artifacts by rejecting certain frequencies while permitting others.

Component - A three RCA type input that uses high quality cables (one for brightness, and two for color). Process increases bandwidth resulting in more color information to be carried to the TV producing a more accurate picture.

Composite - Also known as CVBS, Technology that permits the combination of color information and brightness under one wire. A single video signal that carries both brightness and color information are contained in a single wire.

Contrast - Difference in luminance between the white and black colors.

CRT - Cathode Ray Tube.

DB15 - Also referred to as VGA; See VGA

De-Interlace - Process of converting an interlaced video signal.

Display Area - The perimeter of the LCD glass the image is displayed on. See Video Resolution

Dual Link - See Single Link; Supports a maximum bandwidth of 2 x 165 MHz (1920 x 1080 @ 60 Hz, 1280 x 1024 @ 85 Hz).

DVI - Digital Video Interface Describes the technology that is used to take full advantage of a signal when paired with a high-end video card and flat panel displays

DVI-A - Digital Video Hi-Resolution Analog

DVI-D - Digital Video Interface Digital; Cable is used for direct connection from one digital source to the TV; See DVI

DVI-I - Digital Video Interface Integrated; Cable that supports analog and digital signals; See DVI

DTV - Digital Television

Factory Default - Feature on the OSD for the Syntax Olevia models that resets all menu options to factory default.

F-Connector - The standard connector found on video equipments that coaxial cables connect to.

Flat-Panel Display - ultra thin displays, usually found in notebooks are now entering the TV appliances sector as new technology enables wider/larger screens.

Frame - A complete picture that includes both even and odd lines. 30 video frames are present in 1 second.

Gain - Describes the amplification level of a particular signal.

HDCP - High bandwidth Digital Content Protection

HDTV - 1.High Definition Television 2. Designates as the unit having a built in ATSC tuner to decode High Definition signals (720P/1080I).

HD-Ready - A unit that supports the High Definition displays (720P/1080I) with the help of a Set-Top Box.

Horizontal Resolution - Refers to the number of vertical black and white lines defined along a horizontal line.

IR - Infrared

Input - term used in the On Screen Display

Interlaced - Images are the result of lines of data reassembled. Interlaced refers to the process of an image's odd lines reassembled from top to bottom taking about 1/60 of a second, before reassembling the even lines which results in a full picture. Antonym: Progressive

Language - Feature on the OSD for the Syntax Olevia models that enables the OSD to be read in different languages.

LCD - Liquid Crystal Display

LCoS - Liquid Crystal on Silicon

LED - Light Emitting Diode

Luminance - refers to the brightness of an image.

Lux - 1 Lux = 1 footcandle; measurement of brightness

Moire - A visual illusion in which a succession of parallel curved lines produces a pattern to the naked eye, but does not really exist. Otherwise known as the moire effect.

NCTA - National Cable Television Association

Noise reduction - Feature on the OSD for the Syntax Olevia models that enables channels from the tuner box to reduce noise displayed on the LCD unit.

NTSC - National Television systems Committee

OSD - On Screen Display; brought up by pressing the menu button on the TV or the Remote.

Over Scanning - An image displayed is larger than the display area

PAL - Phase Alternating Line

Parental Control - The ability to block access to specified content from an unsuitable audience.

PIP - Picture in Picture; feature that enables one source to be displayed on top of another source.

Pixel Resolution - Refers to the number of rows horizontal and vertical that produces the image.

PIP - Picture in Picture; Allows an image to be displayed in front of another image.

Plug and Play - Describes the hardware or software that is installed and does not require any configuration before using.

Progressive - An image or lines of data that is reassembled from top to bottom sequentially.

Antonym: Interlaced

RGB - Red, green & blue These primary colors provide the basis for many different colors.

Refresh Rate - Refers to the maximum number of frames that the monitor can display per second. Usually measured in hertz.

Saturation - The amount of a particular color present in an image.

SCART - An industry standard for interconnecting audio-video equipment developed by Peritel. Usually associated with PAL video equipment.

SDTV - Standard Definition Television usually in 480I/P format.

SECAM - Sequential Color with Memory or Sequential Couleur Avec Memoire

Set-Top-Box - box that is capable of receiving and decoding digital transmissions (i.e. High Definition Cable Box, Digital Cable box).

Sharpness - Tries to artificially enhance the edges of a picture.

Single Link - supports a maximum bandwidth of 165 MHz

(1920 x 1080 @ 60 Hz, 1280 x 1024 @ 85 Hz).

Split screen - Feature that places two images side by side.

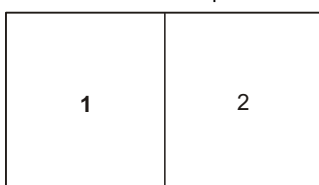

Swap - Button featured on the Olevia remote. Used in the POP3 or PIP12 views to swap the sub viewable boxes with the main viewable box.

Tint - Adjusts the whiteness level within the color. Similar to Hue.

Under- scanning Term used where the image displayed is smaller than the display area.

Up convert - Process of converting a 480P/I signals to 720P or 1080I.

V-Chip - Chip that controls access to forbidden content specified by an adult.

VGA - 1. Video Graphics Array (DB15) 2.

Video Display - Refers to the display resolution

Video Resolution

Aspect Ratio 4:3		Aspect Ratio 16:9	
VGA	640 x 480	WXGA	1280 X 800
SVGA	800 x 600	SXGA	1280 X 1024
XGA	1024 x 768	WXGA+	1400 X 1050
QVGA	1280 x 960	WSXGA	1680 X 1050
SXGA+	1400 x 1050	WUXGA	1920 X 1200
UXGA	1600 x 1200	QSXGA	2560 X 2048
QXGA	2048 x 1536		
QSXGA+	2800 x 2100		
QUXGA	3200 x 2400		

Viewable Angle - Angle at which the screen is still viewable.

Widescreen - See 16:9

YCbCr - Used often with standard interlaced video equipment. See Component

YPbPr - Used often with progressive video equipment. See Component

Free Manuals Download Website

<http://myh66.com>

<http://usermanuals.us>

<http://www.somanuals.com>

<http://www.4manuals.cc>

<http://www.manual-lib.com>

<http://www.404manual.com>

<http://www.luxmanual.com>

<http://aubethermostatmanual.com>

Golf course search by state

<http://golfingnear.com>

Email search by domain

<http://emailbydomain.com>

Auto manuals search

<http://auto.somanuals.com>

TV manuals search

<http://tv.somanuals.com>