

# Instruction Manual

For the digital camera  
CAMEDIA C-5000 Zoom

## Waterproof Case

ENGLISH

# PT-019

- Thank you for buying the Waterproof Case PT-019.
- Please read this instruction manual carefully and use the product safely and correctly.
- Please keep this instruction manual for reference after reading it.
- Wrong use may cause damage to the camera on the inside from water leakage, and repair may not be possible.
- Before use, perform an advance check as described in this manual.

**OLYMPUS CORPORATION**

Download from [Www.Somanuals.com](http://Www.Somanuals.com). All Manuals Search And Download.

## Introduction

- Unauthorized copying of this manual in part or in full, except for private use, is prohibited.  
Unauthorized reproduction is strictly prohibited.
- Our company shall not be responsible in any way for lost profits or any claims by third parties in case of any damage occurring from unsuitable use of this product.
- Our company shall not be responsible for damage, lost profits, etc. caused by loss of image data because of defects, disassembly, repair or modification of this product by people other than third parties specified by our company, or for other reasons.

## Please read the following items before use

- This Case is a precision device designed for use at a water depth within 40 m. Please handle it with sufficient care.
- Please use the Case correctly after sufficient understanding of the contents of this manual in regard to handling of the Case, checks before use, maintenance, and storage after use.
- Our company shall in no way be responsible for accidents involving immersion of a digital camera in water.
- Our company shall not pay any compensation for accidents (injuries or material damage) at the time of use.

## For safe use

This instruction manual uses various pictographs for correct use of the product and to prevent danger to the user and other persons as well as property damage. These pictographs and their meanings are shown below.

**⚠ WARNING** This indicates contents for which the possibility of human death or severe injury in case of handling under disregard of this indication can be assumed.

**⚠ CAUTION** This indicates contents for which the possibility of human injury or the possibility of material damage in case of handling under disregard of this indication can be assumed.

### **⚠ WARNING**

1. Keep this product out of the reach of babies, infants, and children. There is the possibility of occurrence of the following types of accidents.
  - Injury by dropping onto the body from a height.
  - Injury from parts of the body getting caught in parts which open and close.
  - Swallowing of small parts. Please consult a physician immediately if any parts have been swallowed.
  - Triggering of the flash in front of the eyes may cause permanent vision impairment etc.
2. Do not store with a battery in the digital camera housed in this product. Storage with a battery inserted may lead to leakage of the battery liquid and fire.
3. If leakage of water should occur with a camera installed in this product, quickly remove the battery from the camera. There is the possibility of ignition and explosion from generation of hydrogen gas.
4. This product is made of resin. There is the possibility that injuries may be caused when it becomes broken because of strong impact with a rock or other hard objects. Please handle with sufficient care.
5. The silica gel and the grease for silicone O-rings for this product are not edible.

### **⚠ CAUTION**

1. Do not disassemble or modify this product. This may cause water leakage or trouble. In case of disassembly or modification by persons other than those appointed by our company, the guarantee shall not apply.
2. Do not place this product at locations with abnormally high or abnormally low temperatures or at locations with extreme temperature changes. The product may deteriorate.
3. Opening and closing at locations with much sand, dust, or dirt may impair the waterproof characteristic and cause water leakage. This should be avoided.
4. This product has been designed and manufactured for use at a water depth within 40 m. Please note that diving to a depth in excess of 40 m may cause permanent deformation or damage to the Case and the camera inside the Case or may lead to water leakage.

5. Jumping into the water with the Case in your pocket or in your hand, throwing the Case from a boat or ship into the water, and other rough handling may cause water leakage. Please handle with sufficient care, when handing it over from hand to hand etc.
6. If the camera on the inside should become wet because of water leakage etc., immediately wipe off all moisture and confirm the operation.
7. Please remove the O-ring when traveling by air. Otherwise air pressure may make it impossible to open the Case.
8. For safe use of the digital camera in this product, please read the "Instruction Manual" for the digital camera carefully.
9. When sealing this product, take sufficient care that no foreign matter gets caught at the O-ring and the contact surfaces.

## Batteries

- When using this product, only the LCD monitor of the camera and not the optical viewfinder can be used. As a result, more battery power is used than when shooting with the LCD monitor turned off.
- Please use one Olympus lithium ion rechargeable battery for cameras (LI-10B).
- Batteries are subject to self-discharging. Therefore, always charge up batteries fully before use.
- Take care that the battery electrodes do not become wet. This may cause trouble or accidents.
- Carefully read the instruction manual for the camera about other cautions regarding batteries.

## For Prevention of Water Leakage Accidents

When water leakage occurs while this product is being used, repair of the camera housed in this product may become impossible. Please observe the following cautions for use.

1. When sealing this product, make sure that no hairs, fibers, sand particles or other foreign matter stick not only to the O-ring, but also to the contact surface (flat part of the front cover). Even a single hair or a single grain of sand may cause water leakage. Please check with special care.

En

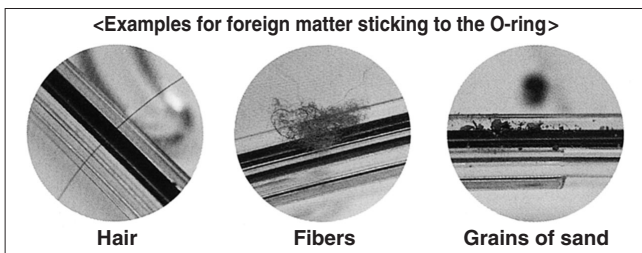

2. The O-ring is a consumption product. Please replace it at least once a year by new one. Also perform maintenance for every use.
3. Deterioration of the O-ring will progress according to the use conditions and the storage conditions. Immediately replace the O-ring by a new one if it is damaged, shows cracks, or has lost its elasticity.
4. At the time of O-ring maintenance, clean the inside of the O-ring groove and confirm the absence of dirt, dust, sand, and other foreign matter.
5. Apply the specified silicone O-ring grease to the O-ring.
6. The waterproof function is not effective when the O-ring is not installed correctly. When installing the O-ring, take care that it does not project from the groove and that it is not twisted. Also, when sealing the Case, close the lid after confirming that the O-ring has not come out of the groove.
7. This product is an airtight construction made of plastic (polycarbonate). When it is left for a long time in a car, on a boat, at the beach, or at other places reaching a high temperature, or when it is subjected for a long time to uneven external force, it may be deformed and the waterproof function may be lost. Pay sufficient attention to temperature control. Also do not place heavy objects onto the product during storage or transport, and avoid unreasonable storage.

8. When the O-ring contact surface is pressed strongly from the outside of the Case, or when the Case is twisted, the waterproof function may be lost. Take care not to exert excessive force.
9. Please be sure to perform the advance test and the final test each time before using the case.
10. If you should notice drops of water or other signs of water leakage while taking pictures, immediately stop the dive, remove any water from the camera and the product, test according to the item "Final check", and confirm whether leakage has occurred or not.

## Handling the Product

- Use or storage of the product at the following locations may cause defective operation, defects, trouble, damage, fire, internal clouding, or water leakage. Always avoid these locations.
  - Locations reaching high temperatures such as those under direct sunlight, in an automobile, etc.
  - Locations with open fire
  - Water depths in excess of 40 m
  - Locations subject to vibrations
  - Locations with high temperatures and much dust or with severe temperature changes
  - Locations with volatile substances
- This product is made of polycarbonate resin with excellent impact resistance, but it may be damaged by scraping against rocks etc. It also may break when it hits hard objects or is dropped.
- This product is not a case to soften impacts to the camera inside the product. When this product with a digital camera inside it is subjected to impacts or heavy objects are placed onto it, the digital camera may become damaged. Please handle the product with sufficient care.
- When the product is not used for a long time, the waterproof performance may drop because of deterioration of the O-ring etc. Before use, always perform the advance test and the final check.
- Do not apply excessive force to the tripod socket.
- When a flash is used while the Case is being used, shadows may appear at the edges of the picture. This is especially notable when taking pictures in macro mode on the wide-angle side. Please use a flash after image confirmation.
- Do not use the following chemicals for cleaning, corrosion prevention, prevention of fogging, repair or other purposes. When these are used for the Case directly or indirectly (with the chemicals in vaporized state), they may cause cracking under high pressure or other problems.

Chemicals which cannot be used	Explanation
Volatile organic solvents, chemical detergents	Do not clean the Case with alcohol, gasoline, thinner or other volatile organic solvents or with chemical detergents etc. Pure water or lukewarm water is sufficient.
Anticorrosion agent	Do not use anticorrosion agents. The metal parts use stainless steel or brass, and washing with pure water is sufficient.
Commercial defogging agents	Do not use commercial defogging agents. Always use the specified desiccant silica gel.
Grease other than specified silicone grease	Use only the specified silicone grease for the silicone O-ring, as otherwise the O-ring surface may deteriorate and water leakage may be caused.
Adhesive	Do not use adhesive for repairs or other purposes. When repair is required, please contact a dealer or a service station of our company.

- Do not perform operations other than specified in this instruction manual, do not remove or modify parts other than specified, and do not use parts other than specified.  
Any troubles in taking pictures or with the equipment resulting from the above actions shall be outside the guarantee.
- Our company shall be in no way responsible for accidents involving immersion of a digital camera in water.
- Our company shall not pay any compensation for accidents (injury or material damage) at the time of use.
- When the enclosure of the balance weight breaks, the metal on the inside may corrode. Take care not to damage the enclosure.
- After use, wash the balance weight with pure water and wipe off all moisture sufficiently.

## Contents

Introduction .....	E-1
Please read the following items before use .....	E-1
For safe use .....	E-1
Batteries .....	E-3
For Prevention of Water Leakage Accidents .....	E-4
Handling the Product .....	E-5

<b>Contents .....</b>	<b>E-7-8</b>
-----------------------	--------------

### **1. Preparations .....**

Check the contents of the package. ....	E-9
Names of the parts .....	E-10
Install the strap. ....	E-11
Master the basic operation. ....	E-11
Holding the Case .....	E-11
How to Press the Shutter .....	E-12
How to Use the Mode Dial .....	E-12
How to Use the Zoom Lever .....	E-12
Setting the Zoom Lever .....	E-13
Power Switch Operation Method .....	E-13

### **2. Advance Check of the Case .....**

Advance test before use .....	E-14
Advance Test .....	E-14

### **3. Install the digital camera. ....**

Check the digital camera. ....	E-15
Battery Confirmation .....	E-15
Confirmation of the Remaining Number of Pictures to be Taken .....	E-15
Remove the hand/neck strap and lens cap from the digital camera. ....	E-15
Loading in the Case .....	E-15
Which digital cameras can be loaded? .....	E-15
Check the operation of the camera. ....	E-15
Open the Case. ....	E-16
Pull the mode dial of the Case. ....	E-16
Load the digital camera. ....	E-16
Set the mode dial. ....	E-17
Insertion of silica gel .....	E-17
Check the loading status. ....	E-18
Seal the Case. ....	E-18





Install the special balance weight. ....	E-18
Installation and Removal of the LCD Hood .....	E-19
Installation .....	E-19
Removal .....	E-19
Mounting and Removing the Lens Cap .....	E-20
Perform the final checks. ....	E-20
Visual Inspection .....	E-20
Set the power to 'ON'. ....	E-20
Try to move the mode dial. ....	E-20
Final Test .....	E-21
<b>4. Taking Pictures Under Water .....</b>	<b>E-22</b>
How to Use the Hand Strap .....	E-22
Take pictures carefully. ....	E-22
Confirm the picture on the LCD monitor. ....	E-22
Quietly press the shutter lever. ....	E-22
Cautions when using the flash .....	E-22
<b>5. Handling After Shooting .....</b>	<b>E-23</b>
Wipe off any waterdrop. ....	E-23
Take out the digital camera. ....	E-24
Wash the Case with pure water. ....	E-25
Dry the Case. ....	E-25
<b>6. Maintaining the Waterproof Function .....</b>	<b>E-26</b>
Remove the O-ring. ....	E-26
Remove any sand, dirt, etc. ....	E-26
Install the O-ring. ....	E-27
How to Apply Grease to the O-ring .....	E-27
Replace consumable products. ....	E-28
<b>7. Appendix .....</b>	<b>E-29</b>
Q & A on the use of the PT-019 .....	E-29
After-sale Service .....	E-34
Specifications .....	E-35

# 1. Preparations

## Check the contents of the package.

Check that all accessories are in the box.

Contact your dealer if accessories should be missing or damaged.

En

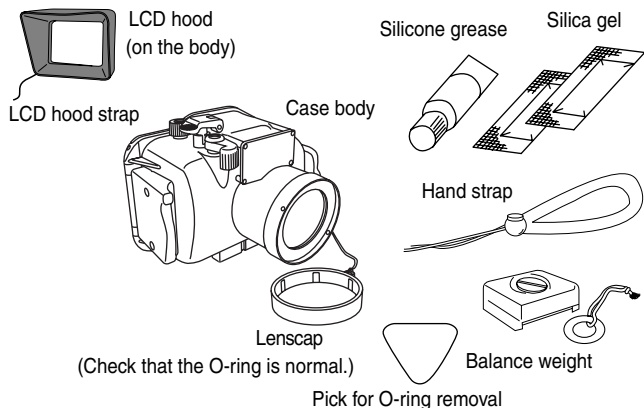

Instruction manual  
(this manual)

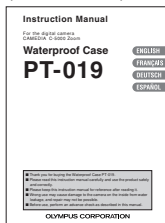

Guarantee card



Please read before use

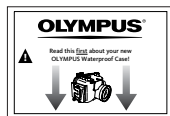

Authorised distributors list/  
Authorised service centres list



## Names of the parts

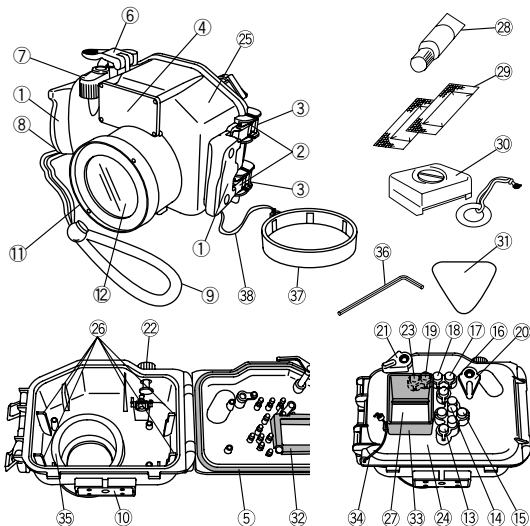

- |                               |                        |   |
|-------------------------------|------------------------|---|
| ① Palm Grip                   | ✱ ⑬ LCD monitor button | ②⑥ Loading guide rail                     |
| ② Buckle lock lever           | ✱ ⑭ OK/Menu button     | ②⑦ LCD monitor window                     |
| ③ Buckle hook                 | ✱ ⑮ Arrow Pad          | ②⑧ Grease for silicone O-ring (white cap) |
| ④ Diffuser and diffuser cover | ✱ ⑯ AEL/Custom button  | ②⑨ Silica gel                             |
| ⑤ O-ring                      | ✱ ⑰ Flash mode button  | ③⑩ Balance weight                         |
| ✱ ⑥ Shutter lever             | ✱ ⑱ Macro/Spot button  | ③⑪ Pick for O-ring removal                |
| ✱ ⑦ Zoom lever                | ✱ ⑲ Selftimer button   | ③⑫ LCD inner hood                         |
| ⑧ Hand strap ring             | ✱ ⑳ Flash lever        | ③⑬ LCD hood                               |
| ⑨ Hand strap                  | ✱ ㉑ Flash close lever  | ③⑭ LCD hood strap                         |
| ⑩ Tripod seat                 | ✱ ㉒ Mode dial knob     | ③⑮ Shade hood                             |
| ⑪ Lens ring                   | ✱ ㉓ Power switch       | ③⑯ Buckle opener                          |
| ⑫ Lens window                 | ⑲ Rear lid             | ③⑰ Lens cap                               |
|                               | ⑲ Front lid            | ③⑱ Lens cap strap                         |

**Note** : The Case operation parts marked by \* corresponds to the operation parts of the digital camera. When the operation parts of the Case are operated, the corresponding functions of the digital camera will operate. For details of the functions, refer to the instruction manual for the digital camera.



## Install the strap.

Install the strap on the Case body.

Installation explanation

Finished installation

Hand strap

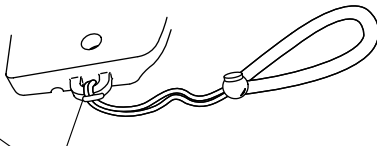
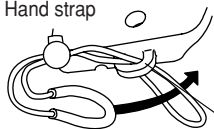

Hand strap ring

En

**CAUTION** : Please install the strap correctly as shown above. Our company shall bear no responsibility for damage etc. caused by dropping the Case because of incorrect installation of the strap.

## Master the basic operation.

Please master the basic operation of the Case before taking pictures.

### Holding the Case

Hold the Case securely with both hands, keep your elbows close to your body, and hold the Case so that you can confirm the picture on the LCD monitor of the digital camera through the LCD monitor window of the Case.

Good example

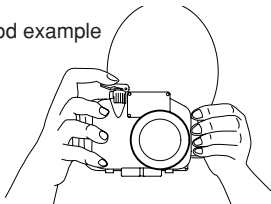

Bad example

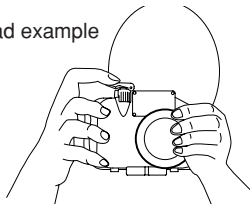

**CAUTION** :  
• Do not exert excessive force onto the lens window or the lens ring.  
• Take care not to put your fingers etc. over the lens window and the flash diffuser.

**Note** : • Use the LCD monitor to confirm your picture. The viewfinder cannot be used.

## How to Press the Shutter

When pressing the shutter lever, press it gently, so that there will be no movement of the camera.

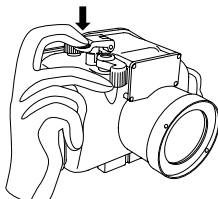

En

- Advice**
- If you use your index finger to operate the shutter release lever and your middle finger for the zoom lever, you will not need to change your finger position.
  - Before activating the shutter release lever, the zoom lever should be in the neutral (middle) position. The release cannot be activated if the zoom lever is in the tele or wide-angle position.
  - For more detailed information on operating the shutter release, please consult the digital camera's instruction manual.

## How to Use the Mode Dial

This Case is equipped with a mode dial knob which permits operation of the mode dial of the loaded digital camera from the outside. After loading the digital camera into the Case, seal the Case and confirm that the mode dial can be operated.

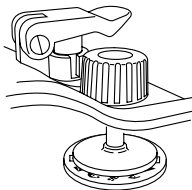

- Advice**
- Please confirm that the mode dial knob has been set securely to the mode dial of the digital camera. If the mode of the digital camera does not change when the mode dial knob is operated, turn the dial while pushing it lightly.

## How to Use the Zoom Lever

Zoom operation is possible by operating the zoom lever of this Case corresponding to the zoom lever of the digital camera in the Case.

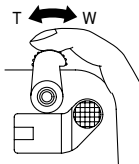

## Setting the Zoom Lever

When loading the digital camera in the Case, fit the projecting part of the zoom lever of the digital camera into the recessed part of the zoom lever on the inside of the Case.

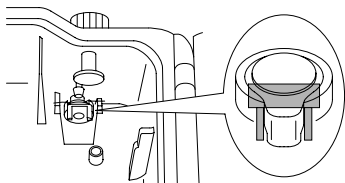

En

- ⚠ CAUTION :**
- When loading the camera, confirm that the projecting part of the zoom lever of the camera is properly set to the recessed part of the zoom lever of the Case.
  - When the setting is insufficient, the loading of the camera becomes imperfect and it may not be possible to seal the Case or zooming may not function. Insufficient sealing will cause water leakage.

## Power Switch Operation Method

Power switch operation is possible by operating the power switch lever of this Case corresponding to the power switch lever of the digital camera in the Case.

- Note:**
- When the set time (initial setting: 3 minutes) passes without any operation while the digital camera is installed in shooting mode, the camera enters into sleep mode (standby status) and the operation stops.  
To cancel sleep mode (return to operation status), press the shutter button or any other button.  
For details, refer to the instruction manual for the digital camera.

## 2. Advance Check of the Case

### Advance test before use

This Case has been the subject of thorough quality control for the parts during the manufacturing process and thorough function inspections during the assembly. In addition, a water pressure test is performed with a water pressure tester for all products to confirm that the performance conforms to the specifications. However, depending on the carrying and storage conditions, the maintenance status, etc., the waterproof function may be damaged.

Before diving, always perform the following advance test and the water leakage test after installation of the camera.

En

### Advance Test

1. Before installing the digital camera in the Case, immerse the empty Case to the intended water depth to confirm that there is no water leakage.
2. Main causes of water leakage are as follows.
  - The O-ring has not been installed.
  - A part of the O-ring or the entire O-ring is outside the specified groove.
  - O-ring damage, cracks, deterioration or deformation
  - Sand, fibers, hair or other foreign matter sticking to the O-ring, the O-ring groove or the O-ring contact surface on the front lid
  - Damage to the O-ring groove or the O-ring contact surface on the front lid
  - When closing the Case, check for catching of the hand strap and silica gel after the above causes have been eliminated.

**⚠ CAUTION :**

- The most suitable method for checking water leakage is to immerse the Case to the intended water depth. When this is difficult, water leakage also can be checked at a shallow depth with no water pressure. Do not feel that this is troublesome, but perform this test.
- If the advance test should show water leakage with normal handling, stop using the Case and contact your dealer or an Olympus service station (listed on the rear page of this instruction manual).

### 3. Install the digital camera.

#### Check the digital camera.

Check the digital camera before loading it in the Case.

#### Battery Confirmation

Since the LCD monitor is used for picture confirmation while taking pictures under water, the battery life becomes short. Confirm that the remaining battery capacity is sufficient.

**Note:** • In order to avoid losing shutter chances due to an exhausted battery, you should always replace a battery with a fully charged battery before each dive.

#### Confirmation of the Remaining Number of Pictures to be Taken

Confirm that the image storage has a sufficient remaining number of pictures to be taken.

#### Remove the hand/neck strap and lens cap from the digital camera.

When a strap/lens cap is attached to the digital camera, it must be removed to ensure proper fit.

**⚠ CAUTION :** • When a digital camera is loaded without removing the strap, the strap may get caught between the Case lids and may cause water leakage.  
• When removing the strap, handle the digital camera with sufficient care. Our company shall not be responsible for damage caused by dropping the camera etc.

#### Loading in the Case

#### Which digital cameras can be loaded?

This product (PT-019) is exclusively used for the CAMEDIA C-5000 Zoom

#### Check the operation of the camera.

Confirm the operation according to the instruction manual for the digital camera.



## Open the Case.

Insert the buckle opener of the accessory into the buckle opening lever as shown in the figure (in direction ①) Pull the buckle opener slowly (in direction ②). When not using the buckle opener, hold the buckle opening lever with your thumb and index finger from the side and pull it up slowly.

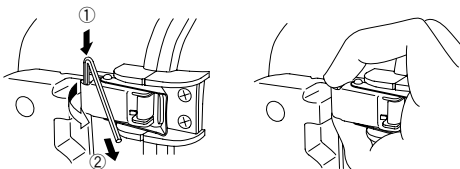

En

## Pull the mode dial of the Case.

Pull the mode dial of the Case until it stops, so that it does not interfere with the mode dial of the digital camera.

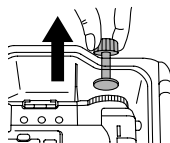

## Load the digital camera.

Quietly load the digital camera into the Case, taking care that the projecting part of the zoom lever of the digital camera properly fits into the recessed part of the zoom lever of the Case.

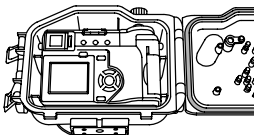

- CAUTION:**
- Confirm that the projecting part of the zoom lever of the digital camera is set securely to the zoom lever notch on the inside of the Case. When the setting is not secure, the loading of the digital camera is not complete and closing of the rear lid of the Case may not be possible or zoom may not function even when the zoom lever is operated.
  - Insufficient sealing will cause water leakage.

## Set the mode dial.

After the digital camera has been loaded, push down the mode dial of the Case from the upper surface of the Case. Set it so that the lower part of the mode dial on the inside of the Case fits properly onto the upper part of the mode dial of the digital camera itself.

Also, load the camera so that the power switch of the digital camera fits into the power switch lever notch on the inside of the protector.

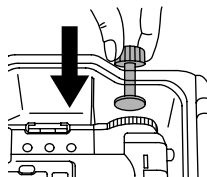

En

**Advice** • After setting the mode dial of the Case, set the power of the digital camera to 'OFF', and before sealing the Case, operate the mode dial and confirm that the mode of the digital camera is switched.

## Insertion of silica gel

Before sealing the Case, insert the accessory silica gel bag (for prevention of fogging) between the bottom of the camera and the Case. Insert the bag with the glued longer side to the inside.

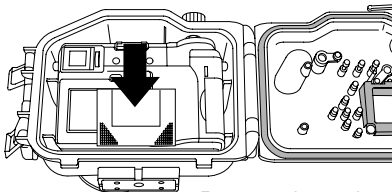

Pay attention to the orientation.

- CAUTION:**
- Insert the silica gel all the way at the specified location and with the specified orientation. When the orientation is not correct, the silica gel bag will be caught when the Case is sealed and water leakage will be caused.
  - Attempting to seal the Case with the bag inserted only part of the way will cause the silica gel bag to get caught by the O-ring and water leakage will occur.
  - Once silica gel has been used, the moisture absorption performance will be impaired. Always exchange the silica gel when the Case is opened and closed.

## Check the loading status.

Always perform the following final checks before sealing the Case.

- Has the digital camera been loaded so that the zoom lever operates properly?
- Has the silica gel been inserted all the way at the specified position?
- Has the O-ring at the Case opening part been installed properly?
- Are the O-ring and the O-ring contact surface on the front lid free of dirt and other foreign matter?

En

## Seal the Case.

When the rear lid is closed (quietly, so that the O-ring will not come out of the groove), the buckles are engaged with the edge of the rear lid, and the buckle lock levers are pushed down in arrow direction, the Case will be sealed airtight.

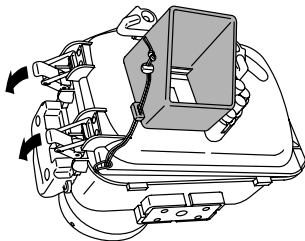

**CAUTION :** • Seal the Case by turning both buckle lock levers down in arrow direction. When one of the buckles is left open, the Case will not be sealed and water leakage will be caused.

## Install the special balance weight.

Install the special balance weight to the tripod mounting thread at the bottom of the Case. Install the balance weight securely by tightening the accessory screw of the balance weight.

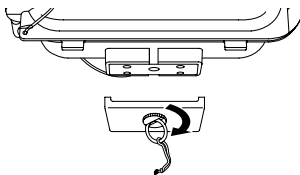



## Installation and Removal of the LCD Hood

### Installation

Strongly push the mounting projections of the LCD hood as shown in the figure into the guides above and below the LCD monitor window.

En

### Removal

Remove the mounting projections of the LCD hood from the guides above and below the LCD monitor window by widening the LCD hood.

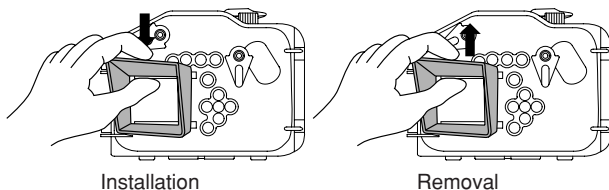

## Mounting and Removing the Lens Cap

Fit the lens cap onto the lens ring as shown in the figure. Be sure to remove the lens cap before shooting.

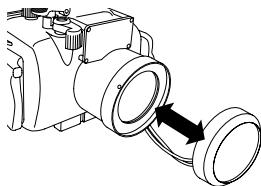

En

## Perform the final checks.

### Visual Inspection

After sealing the Case, check the sealing part of front and rear lid visually to confirm that the O-ring is not twisted or out of the groove and that no foreign matter has been caught.

**⚠ CAUTION :** • Hairs, fibers, and other narrow items are not very apparent, but they may cause entry of water, so that special attention is required.

### Set the power to 'ON'.

Move the power switch lever and confirm that the camera power can be switched ON and OFF.

### Try to move the mode dial.

After sealing, turn the mode dial knob and confirm that the mode dial of the camera is switched.

**⚠ CAUTION :** • After loading the camera into the Case, confirm that the mode dial moves. If it does not move, there is the possibility that oil or fat has been attached to the mode dial. Please wipe it clean.









• When no operation is performed for three minutes after the digital camera has been loaded (or for the specified time when a different time has been specified), the camera enters into sleep mode (standby status) to save battery power. It returns to operation status when the shutter button or the zoom lever is operated.

For details, refer to the instruction manual for the digital camera.

## Final Test

The final test after loading the camera is explained below. This is the only way to eliminate worry about possible entry of water! Always perform this test. It can be performed easily in a water tank or a bathtub. The required time is about five minutes.

En

	Simple water immersion test	Explanatory image	Hints
1	Place the Case slowly into the water.		As the Case is transparent, waterdrops entering into it can be confirmed easily.
2	At first, immerse the Case for only three seconds.		In case of trouble with the O-ring, three seconds are enough for water to enter. Are there air bubbles coming out between the lids? Please check carefully.
3	Check that no water has entered into the Case.		Remove the Case from the water and check that no water has accumulated at the bottom of the Case. Is there any water trickling down?
4	Next, immerse the Case for 30 seconds.		Check carefully for air bubbles! Do not perform any operation yet, but just observe.
5	Check that no water has entered.		Remove the Case from the water and check that no water has accumulated at the bottom of the Case. Perform very careful confirmation.
6	Next, check by immersing for three minutes.		Check carefully for air bubbles! Try operation of the buttons used frequently. Check carefully for air bubbles! If there is still no entry of water, everything is OK!
7	This is the final check. Has the silica gel become moist?		This is very important! Has the silica gel become moist? Please check carefully! As the inside can be seen, the inspection for entry of water also can be made securely!
8	Now everything is all right. Do not forget the balance weight.		Now everything is all right! Have a nice dive! Did you remember to attach the balance weight?

## 4. Taking Pictures Under Water

### How to Use the Hand Strap

Pass your hand through the accessory hand strap and adjust the length with the stop button.

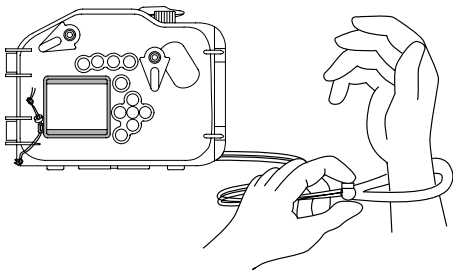

En

### Take pictures carefully.

#### Confirm the picture on the LCD monitor.

This Case uses the LCD monitor to confirm the picture. The viewfinder cannot be used.

#### Quietly press the shutter lever.

When pressing the shutter lever, hold the Case securely with both hands and operate the lever quietly to prevent camera shake.

#### Cautions when using the flash

When taking macro pictures on the wide-angle side, the flash light may be missing in some parts or the light volume may not be uniform.

Flash working range	W : Approx. 0.2 m to 3.8 m
	T : Approx. 0.3 m to 2.2 m

Depending on the conditions at the time of shooting (clarity of the water, suspended matter, etc.), the applicable flash distance may become shorter. After taking a picture, display it on the LCD monitor for confirmation.

## 5. Handling After Shooting

### Wipe off any waterdrop.

After completing the shooting and returning to land, wipe off any waterdrop sticking to the Case. Use air or a soft cloth not leaving any fibers to thoroughly wipe any waterdrop etc. from the joint between the front and rear lid, the shutter lever, the palm grips, and the buckles.

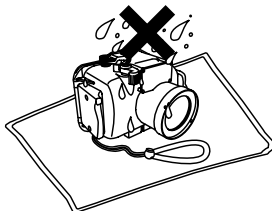

- ⚠ CAUTION:**
- Especially when waterdrops remain between the front and the rear lid, they may spill to the inside when the Case is opened. Take special care to wipe off all waterdrops.
  - When opening the Case, take sufficient care that no water will drop from your hair or body onto the Case and the camera.
  - Before opening the Case, make sure that your hands or gloves are free of sand, fibers, etc.
  - Do not open or close the Case at locations where water or sand is to be sprayed. When this cannot be avoided because you have to exchange the battery or the image storage, place a sheet downwind from some object and take care that no water or sand is sprayed.
  - Take care not to touch the digital camera or the battery with hands wet with sea water.

**Note:** • Moisten a towel etc. in advance with pure water and keep it in a plastic bag so that you can wipe the salt from your hands and fingers before handling the camera.



## Take out the digital camera.

Open the Case carefully, pull up the mode dial from the upper surface of the Case to disengage it from the mode lever of the camera, and then remove the digital camera from the Case.

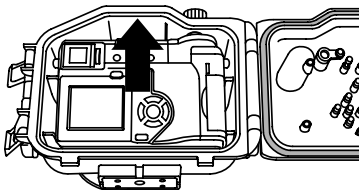

En

- ⚠ CAUTION :**
- Always place the opened Case with the O-ring side facing up. When the Case is placed with the O-ring side facing down, dirt or other foreign matter may be attached to the O-ring or the O-ring contact surface and may cause water leakage during the next dive.
  - Please read the operation manual for the digital camera for the storage of pictures etc.
  - Take special care so that no water drops get onto the camera.



## Wash the Case with pure water.

After use, seal the Case again after taking out the camera and wash it sufficiently in pure water as soon as possible. After use in sea water, it is effective to immerse it for a fixed time in pure water to remove any salt.

En

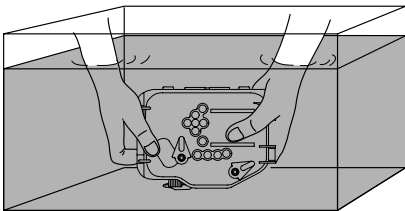

- △CAUTION:**
- Water leakage may be caused when a high water pressure is applied locally. Before washing the Case with water, remove the digital camera from it.
  - Operate the shutter lever and various buttons of this product in pure water to remove salt adhering to the shaft. Do not disassemble for cleaning.
  - Drying the Case with adhering salt may impair the function. Always wash off any salt after use.

## Dry the Case.

After washing with pure water, use a soft cloth without any salt on it and not causing any fibers to wipe off any waterdrop and dry the Case completely at a well ventilated location in the shade.

- △CAUTION:**
- Do not use hot air from a hair drier or the like for drying and do not expose the Case to direct sunlight, as this may accelerate deterioration and deformation of the Case and deterioration of the O-ring, leading to leakage of water.
- When wiping the Case, take care not to cause scratches.

## 6. Maintaining the Waterproof Function

### Remove the O-ring.

Open the Case and remove the O-ring from the Case.

Removal of the O-ring

- ① Insert the O-ring removal pick between the O-ring and the wall of the O-ring groove.
- ② Move the tip of the inserted pick under the O-ring. (Take care not to damage the O-ring groove with the tip of the pick.)
- ③ Hold the O-ring with your fingertips after it has come out of the groove and remove it from the Case.

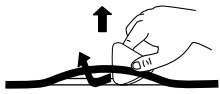

### Remove any sand, dirt, etc.

After visually checking that dirt has been removed from the O-ring, checking for attached sand and other foreign matter, as well as for damage and cracks can be done by squeezing the entire circumference of the O-ring lightly with your fingertips.

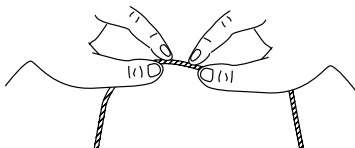

Use a clean cloth (that doesn't shed fibers), a toothbrush, tissue paper or the like, to remove any foreign matter from the O-ring groove. Clean the O-ring contact surface on the front lid in the same way to remove any sand and dirt.

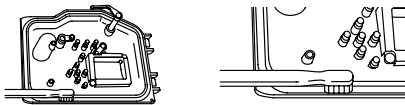

- ⚠ CAUTION :**
- When a mechanical pencil or a similar other sharp object is used to remove the O-ring or to clean the inside of the O-ring groove, the Case and the O-ring may be damaged and water leakage may be caused.
  - When the O-ring is checked with the fingertips, take care not to stretch the O-ring.
  - Never use alcohol, thinner, benzene or similar solvents or chemicals detergents to clean the O-ring. When such chemicals are used, it is likely that the O-ring will be damaged or that its deterioration will be accelerated.

## Install the O-ring.

Confirm that no foreign matter is attached, apply a thin coat of the accessory grease to the O-ring, and fit the O-ring into the groove. At this time, confirm that the O-ring does not stick out from the groove.

## How to Apply Grease to the O-ring

1	Apply the specified grease	Make sure there is no dirt on your fingers or on the O-ring; then squeeze about 5 mm of grease onto your fingertip.
2	Spread the grease over the O-ring.	Using two fingers and a thumb, spread the grease over the O-ring while rubbing it in. Use caution not to squeeze or pull the O-ring too hard.
3	Check that there is no damage or irregularities on the O-ring.	Once the grease has permeated throughout the O-ring, check it for damage or irregularities (both visually and by touch). If you notice any abnormalities, replace the O-ring with a new one.
4	Apply the grease to the O-ring contact surface.	Use any residual grease on your fingertips to clean and lubricate the O-ring contact surface on the front lid.

- 
- ⚠ CAUTION :**
- Always perform maintenance of the waterproof function even when the Case has been opened to exchange the battery or the image storage during shooting. Neglecting this maintenance may become the cause of water leakage.
  - When the Case is not to be used for a long time, remove the O-ring from the groove to prevent deformation of the O-ring, apply a thin coat of silicone grease, and store it in a clean plastic bag or the like.
  - When drying is done with salt attached, it is likely that a function impairment will be caused. After use, always wash off any salt.

En

## Replace consumable products.

- The O-ring is a consumable product. Independent of the number of times the Case is used, it is recommended that the O-ring should be replaced by a new one at least once a year.
- Deterioration of the O-ring is accelerated by the use conditions and the storage conditions. Replace the O-ring even before a year has passed if it shows signs of damage, cracking or loss of elasticity.

**Note:** • Please use original Olympus products for the silicone O-ring grease, the silica gel, and the O-ring. These consumable products also can be purchased at an Olympus service station.

## 7. Appendix

### Q & A on the use of the PT-019

Q1 : Which digital cameras can be used?

A1 : The PT-019 is only for the models C-5000 Zoom.

En

Q2 : What cautions must be observed when loading the digital camera into the Case?

A2 : Pay special attention to the following items when loading the camera into the Case.

- (1) Check that the remaining capacity of the battery in the digital camera is sufficient.

This should be checked as the LCD monitor is used under water, and the battery consumption becomes faster.

- (2) Check the remaining number of pictures on the image storage.

Please use a card with a sufficient remaining number in order to reduce the number of times the Case has to be opened and closed.

- (3) Remove the strap/lens cap from the digital camera.

When the camera is loaded without removing the strap/lens cap, the strap/lens cap may get caught when the Case is sealed and this will cause water leakage.

- (4) Before sealing the Case, confirm that the O-ring has been installed properly in the groove in the rear lid of the Case.

- (5) Confirm that the O-ring and the O-ring contact surface on the front lid are free of dirt, hairs, and other foreign matter.

- (6) Insert the silica gel for defogging. Please use silica gel for the Olympus Case.

- (7) Finally install the special balance weight to the tripod mounting thread.

Q3 : What cautions must be observed when using and storing the Case?

A3 : Pay special attention to the following items.

- (1) When the O-ring contact surface is pressed strongly from the outside of the Case, or when the Case is twisted, the waterproof function may be impaired and water leakage may be caused.

- (2) When the Case is used, left or stored at the following locations, defective operation or trouble may be caused. Always avoid such locations.

- (a) Places where the Case can reach high temperatures under direct sunlight or in a car, places with extremely low temperatures, and places with extreme temperature variations

- (b) Places with open fire

- (c) Places with volatile substances

- (d) Places with vibrations

- (3) In case of the following handling with a camera loaded into the Case, trouble or breakage may be caused for the Case and/or the loaded camera. Always avoid such handling.
  - (a) Hitting other objects
  - (b) Dropping
  - (c) Placing heavy objects on top of the Case
- (4) When the Case is not used for a long time, trouble from formation of mold etc. may be caused. Before use, confirm the operation of all operation parts and perform the advance test and the final test.

Q4 : What cautions must be observed when opening and closing the Case?

A4 : Pay special attention to the following items.

- (1) Do not open and close the Case at locations with water spray or sand spray.
- (2) Wipe off all waterdrops from the gap between the front lid and the rear lid and around projections and recesses such as the buckles. When this is not done, entry of waterdrops into the Case is to be feared at the time of opening and closing.
- (3) When opening the Case, take care that no water will drip from your hair or body into the Case or onto the camera.
- (4) When the Case is open, check that there is no attachment of sand, fibers or other foreign matter to the O-ring and the O-ring contact surface on the front lid.
- (5) Do not touch the camera or the image storage with your hands to which sea water is sticking.
- (6) If you should detect waterdrops or other signs of water leakage while shooting, immediately end the dive, perform the water leakage test again, and confirm that there is no leakage. If the camera is wet, wipe off any moisture and check the operation.

Q5 : How should the Case be handled after use?

A5 : After use, take out the camera as soon as possible and wash the Case with pure water. In case of use in the ocean, it is effective to immerse the Case for a certain time in pure water to remove any salt. Operate the buttons and levers under water to turn the shafts and wash off any salt. After washing, use a dry cloth without any salt on it to wipe off any moisture and dry the Case in the shade. Do not use hot air from a hair drier or the like and do not dry the Case under direct sunlight. Exposure to high temperatures or direct sunlight may cause deformation, discoloration or breakage of the Case and deterioration of the O-ring. Wipe the inside of the Case with a soft cloth not causing any fibers. Remove the O-ring, wipe off any salt, sand, dust, etc., and also clean the O-ring groove and the O-ring contact surface in the same way and then

dry them. When an object with a sharp tip is used to remove the O-ring from the groove, the O-ring may be damaged and water leakage may be caused. Always use the accessory pick for O-ring removal.

Q6 : How should I take pictures under water?

A6 : Please observe the following items for shooting under water.

- (1) Fix the Case with the accessory hand strap to your wrist.
- (2) When you place a finger onto the lens window, the finger will appear in the photo. Pay attention to the position of your fingers when holding the Case.
- (3) When pressing the shutter lever, hold the Case securely with both hands and operate the lever quietly to prevent camera shake.
- (4) Look through the LCD monitor window on the rear of the Case to confirm the picture and then press the shutter lever. Please note that the viewfinder cannot be used. When the LCD monitor is used, the battery is exhausted earlier. In order to avoid losing shutter chances due to an exhausted battery, please always replace a battery with a fully charged battery before each dive.

Q7 : How can I check for water leakage?

A7 : For confirmation, perform the advance test and the final test after loading the camera. The advance test with immersing the Case without the camera to the intended use depth to check for water leakage is the most accurate test, but when this is difficult, it is safer to perform this test even at a depth of 1 m or in a bathtub. The final test also can be performed in a bathtub or a bucket.

Q8 : What are the causes for entry of water?

A8 : The main causes for the entry of water are shown below. Please check them most carefully.

- (1) Forgetting to install the O-ring
- (2) The O-ring is partly or completely outside the groove.
- (3) Damage, deterioration, or deformation of the O-ring
- (4) Sand, fibers, hair or other foreign matter on the O-ring
- (5) Sand, fibers, hair or other foreign matter on the O-ring groove or the O-ring contact surface
- (6) Catching of the strap, the bag of silica gel, etc. at the time of sealing the Case.
- (7) Throwing the Case from a boat into the water, jumping with the Case into the water, or other sudden application of strong forces onto the Case. When entering the water, hand the Case over quietly or avoid impacts in other ways.



Q9: What are the important points for O-ring maintenance?

A9: Please observe the following items.

- (1) Never use alcohol, thinner, benzene or similar organic solvents or chemical detergents to clean the O-ring. When such chemicals are used, it is to be feared that the O-ring will be damaged or that its deterioration will be accelerated.
- (2) Use the original Olympus silicone O-ring grease (white cap). The grease attached to Cases up to PT-008 (red cap) and the grease of other companies are not suitable for this silicone O-ring, and use of such grease may cause deterioration of the surface and impairment of the waterproof function.
- (3) In order to avoid deformation of the O-ring when the Case is not used for a long time, remove the O-ring from the Case, apply a thin coat of the special grease, and store the O-ring in a clean plastic bag. For reuse, confirm that the O-ring is free of damage and cracks, that it has sufficient elasticity, that the surface is free of stickiness and other abnormalities, and use it after applying a thin coat of the special grease. Excessive application of grease does not improve the waterproof function or the permissible withstand pressure. However, it may facilitate attachment of sand, dirt, etc.  
A thin, uniform coat produces the best result.
- (4) The O-ring is a consumable product. Replace it at least once a year.
- (5) Deterioration of the O-ring is accelerated by the use conditions and the storage conditions. Replace the O-ring immediately by a new one if it shows signs of damage, cracking or loss of elasticity.

Q10: What are the important points for Case maintenance?

A10: Please observe the following items.

- (1) Never use the following chemicals for cleaning, corrosion protection, defogging, repair or other purposes.
  - Never use alcohol, thinner, benzene or similar volatile organic solvents or chemical detergents to clean the Case. Pure water or lukewarm water is sufficient for cleaning.
  - Do not use anticorrosion agents on the metal parts. The metal parts are made of aluminum, brass or stainless steel. Cleaning with pure water is sufficient.
  - Do not use commercial defogging agents. Always use the original Olympus defogging silica gel.
  - Do not use adhesive for repairs or other purposes. When repair is required, please contact a service station of our company or your dealer.

Q11: Please tell me about repairs.

A11: Please contact a service station of our company or your dealer, if repair should be necessary. Do not try to repair, disassemble or modify the Case yourself. Repair, disassembly or modification by you or third parties not authorized by Olympus invalidates the guarantee.

Q12: What are the model numbers of the PT-019 accessories?

A12: The following accessories are being sold.

- (1) O-ring for the PT-019 body (POL-019): This is a silicone rubber O-ring packing to be installed in the PT-019 body to make it waterproof. O-rings for other Case models cannot be used.
  - (2) Silicone O-ring grease (PSOLG-1): This is a special grease for silicone O-ring maintenance.
  - (3) Silica gel (SILCA-5): This is a desiccant used to prevent fogging of the glass parts of the Case. The quantity is five bags.
  - (4) LCD hood (PFUD-04): This hood is installed on the LCD monitor window of the Case to make it easier to see the LCD monitor of the camera.
  - (5) Balance weight for PT-019 (PWT-019): This is a weight intended to bring the Case close to neutral buoyancy in sea water. Under consideration of the environment, no lead is used.
- \* You can order in large computer shops and camera mass sale stores.
  - \* Please contact your dealer or a service station of our company when replacement is required. Replacement will be made against payment.

## After-sale Service

- You will receive the guarantee card from your dealer. Please make sure that the dealer's name, the date of purchase, etc. have been entered. If they have not been entered, immediately ask your dealer to have them entered. Read the guarantee conditions carefully and keep the guarantee card at a safe location.

- Please contact your dealer or one of the service stations of our company listed in this instruction manual for questions on after-sale service for this product or in case of defects. In case of a defect of this product, occurring within one year after the date of purchase and with handling according to this instruction manual, repair based on the conditions specified in the guarantee card is performed free of charge.

Payment is required for repairs after expiration of the guarantee period and for trouble caused by problematic handling by the customer even during the guarantee period.

- Our company keeps repair parts for this product for approximately five years after the end of production of the product. Accordingly, in principle repairs are accepted during this period. As repair may be possible even after this period, please contact your dealer or a service station in your neighborhood.
- Warranty is limited to and valid only in the region of intended distribution.
- Incidental damages from defects of this product (expenses required for diving, shooting expenses, loss of profit from photos, etc.) shall be excluded from the guarantee. In addition, transport expenses etc. related to repair shall be paid by the customer, independent of whether they are incurred during or after the guarantee period.

En

## Specifications

Available models	Olympus digital camera CAMEDIA C-5000 Zoom
Pressure resistance	Depth of up to 40 m
Main materials	Body: Transparent polycarbonate Buckles: Stainless steel Grip/Shutter lever/Zoom lever/Mode dial: Red polycarbonate Lens window: FL glass Lens ring: Aluminum Operation buttons: Stainless steel Nickel-plated brass O-ring/Lens cap: Silicon rubber LCD hood: NBR rubber
Dimensions	Width 000 mm x height 000 mm x thickness 000 mm (projections not included)
Weight	000 g (LCD hood not included)

\* We reserve the right to change the external appearance and the specifications without notice.

---

MEMO

---

En

---

MEMO

---

En

## Free Manuals Download Website

<http://myh66.com>

<http://usermanuals.us>

<http://www.somanuals.com>

<http://www.4manuals.cc>

<http://www.manual-lib.com>

<http://www.404manual.com>

<http://www.luxmanual.com>

<http://aubethermostatmanual.com>

Golf course search by state

<http://golfingnear.com>

Email search by domain

<http://emailbydomain.com>

Auto manuals search

<http://auto.somanuals.com>

TV manuals search

<http://tv.somanuals.com>