

OLYMPUS®

LINEAR PCM RECORDER LS-14/LS-12

Linear PCM Recorder

DETAILED INSTRUCTIONS

EN

Thank you for purchasing an Olympus Digital Voice Recorder. Please read these instructions for information about using the product correctly and safely. Keep the instructions handy for future reference. To ensure successful recording, we recommend that you test the record function and volume before use.

Register your product on www.olympus-consumer.com/register and get additional benefits from Olympus!

Download from Www.Somanuals.com. All Manuals Search And Download.

Introduction

- The contents of this document are subject to change without notice. Contact our Customer Support Center for the latest information relating to product names and model numbers.
- Illustrations of the screen and the recorder shown in this manual may differ from the actual product. The utmost care has been taken to ensure the integrity of this document but should you happen to find a questionable item, error or omission, please contact our Customer Support Center.
- Olympus does not accept any liability for passive damages or damage of any kind incurred due to data loss resulting from a defect of the product, repair performed by a third party other than Olympus or an Olympus authorized service station, or for any other reason.

Trademarks and registered trademarks

- IBM and PC/AT are trademarks or registered trademarks of International Business Machines Corporation.
- Microsoft and Windows are registered trademarks of Microsoft Corporation.
- Macintosh is a registered trademark of Apple Inc.
- SD and SDHC are registered trademarks of SD Card Association.
- MPEG Layer-3 audio coding technology is licensed from Fraunhofer IIS and Thomson.
- The tuner and metronome technologies are realized using "CRIWARE" from CRI Middleware Co., Ltd.

Other product and brand names mentioned herein are trademarks or registered trademarks of their respective owners.



INDEX

Introduction	P.2	
Getting started	P.10	1
About recording	P.26	2
About playback	P.40	3
File management	P.48	4
Menu setting	P.64	5
About the tuner	P.80	6
Using the recorder on your PC	P.82	7
Other information	P.89	8

Table of contents

Introduction

Safety precautions 6

1 Getting started

Main features..... 10

Identification of parts 12

 Display (LCD panel)..... 13

Inserting batteries 15

Turning on/off the power..... 16

HOLD..... 17

Setting the time and date

 [Time & Date]..... 18

Inserting and ejecting an SD card 20

 Inserting an SD card.....20

 Ejecting an SD card.....21

[Home] screen operations 22

Notes on the folders..... 24

Selecting folders and files..... 25

2 About recording

Recording tips for each instrument ... 26

Recording 28

 [QUICK] mode.....28

 [SMART] mode.....29

 [MANUAL] mode30

 Dividing a file while recording.....34

 Using the overdubbing function35

 Using the metronome function.....36

 Recording from an external microphone
 or other device.....38

3 About playback

Playback 40

 Changing the playback speed.....43

 Setting an index mark or
 a temp mark.....44

 How to begin segment
 repeat playback.....46

4 File management

Editing [OPTION]..... 48





Moving/Copying a file	
[Move/Copy].....	48
Protecting a file [File Lock].....	51
Dividing a file [File Divide].....	54
Partially erasing a file [Partial Erase].....	56
Trimming a file [Trimming]	
(LS-14 only).....	58
Confirming a file in memory	
[Property].....	60

Erasing 61

Erasing a file.....	61
Erasing multiple files at once.....	62

5 Menu setting

Menu setting method..... 64

 Rec Menu.....	66
 Play Menu.....	70
 LCD/Sound Menu.....	71
 Device Menu.....	72
Guidance [Voice Guide] (LS-14 only)....	74
Changing the time and date	
[Time & Date].....	75
Changing the USB class	
[USB Settings].....	76
Formatting the recorder [Format].....	78

6 About the tuner

Using the tuning function..... 80

7 Using the recorder on your PC

Operating environment 82

Connecting to your PC..... 84

Disconnecting from your PC.....85

Transferring voice files to your PC..... 86

Usage as external memory of your PC..... 88

8 Other information

Alarm message list 89

Troubleshooting 91

Accessories (optional)..... 94

Specifications 95

Technical assistance and support..... 99

Safety precautions

Before using your new recorder, read this manual carefully to ensure that you know how to operate it safely and correctly. Keep this manual in an easily accessible location for future reference.

- The warning symbols indicate important safety related information. To protect yourself and others from personal injury or damage to property, it is essential that you always read the warnings and information provided.



Danger:

If the product is used without observing the information given under this symbol, serious injury or death may result.



Warning:

If the product is used without observing the information given under this symbol, injury or death may result.



Caution:

If the product is used without observing the information given under this symbol, minor personal injury, damage to the equipment, or loss of valuable data may result.

Cautions relating to the operating environment

- Do not leave the product where it will be subject to high temperatures and/or humidity such as in a car parked in direct sunlight or at the seashore in summer.
- Do not store the product in a humid or dusty place.
- If the product gets wet, immediately wipe water off with a dry cloth. Especially avoid salt.
- Do not use organic solvent such as alcohol or thinner for cleaning.
- Do not place the product on or near a television set, refrigerator, or other electric appliance.
- Ensure that no sand or mud gets on the product. Sand or mud may cause irreparable damage.
- Do not apply strong vibration or shock to the product.
- Do not use the product where it will get wet.
- Do not put a magnetic card (such as bank card) near the speaker or headphones. Data recorded in the magnetic card may be damaged.
- When installing a tripod, rotate the screws on the tripod rather than the recorder.

Notes on data loss

- Data recorded in the memory could be damaged or erased due to a wrong operation, device failure, repair or other cause. It is recommended to save important data in the hard disk of your PC or other media for backup.
- Olympus bears no liability for any damage or lost earnings incurred by data loss due to a failure, repair by a third party not certified by Olympus, or other reason.

Notes on record files

- Olympus bears no liability even if a record file is erased or becomes unplayable due to a failure of the recorder or PC.
- Recorded contents can be used for personal use only. It is prohibited by the Copyright law to use copyrighted work for other purposes without permission from the owner.

Handling the recorder



Warning:

- Do not use the product where there may be flammable or explosive gas in the air.
Doing so could cause an ignition or explosion.
- Do not use or store the product for a long time where there is a lot of dust, humidity, oil, smoke, or steam.
Doing so could cause a fire or electric shock.
- Do not disassemble, repair, or modify the product.
Doing so could cause an electric shock or injury.
- If the product falls into water or if water, metal or a flammable foreign object gets into the product, perform the following steps:
 - ① Immediately remove the battery.
 - ② Contact your dealer or the Olympus Service Station for service. Continuing to use it could cause a fire or electric shock.
- Do not insert a card other than SD or SDHC card into the recorder.
If you accidentally insert such a card, do not try to forcibly remove it but contact our repair center or service station.
- Do not operate the product while driving a vehicle (such as bicycle, motorbike or car).
Doing so could cause a traffic accident.
- Do not leave the product within the reach of infants or children.
When using the product near them, take extra care and do not carelessly leave the product unattended. Children cannot understand warnings and cautions. In addition, the following accidents could happen:
 - Accidentally wrap the earphone cord around the neck and suffocate
 - Perform a wrong operation, causing injury or electric shock
- Avoid using the product in an airplane, hospital, or other place where use of electric devices is restricted. Or, follow the instructions given at the site.
- When carrying the recorder by a strap, ensure that it does not get caught on other items.

Safety precautions



Caution:

- Do not turn the volume up before starting operation.
Doing so could cause a hearing problem or hearing loss.
- Stop using the product if you notice an abnormality such as unusual odor, abnormal sound, or smoke.
Continuing to use the product could cause a fire or burn. Immediately remove the battery carefully not to get burned and contact your dealer, our repair center or service station (Do not touch the battery with bare hands when removing it. In addition, remove the battery outdoors away from combustible materials).
- Do not leave the product where it will be subject to high temperatures.
Doing so could cause deterioration of parts or a fire.
- Do not touch the metal part of the product for a long time when the ambient temperature is low.
Doing so could damage your skin. Avoid touching the product with bare hands if possible and use gloves or other protective gear at low temperatures.

Battery handling precautions



Danger:

- Do not put the battery near fire.
- Do not throw the battery into fire or heat it.
Doing so could cause a fire, blowout or ignition.
- Do not directly solder, deform, modify or disassemble the battery.
- Do not connect the positive and negative terminals.
Doing so could cause heat generation, electric shock or fire.
- When carrying or storing the battery, always put it into the case to protect the terminals.
Do not carry or store it with a key chain or other metal item.
Doing so could cause heat generation, electric shock or fire.
- Do not directly connect the battery to the power outlet or the slot of car cigarette lighter.
- Do not use or leave the battery at a place with high temperatures such as under direct sunlight, in the car in the hot sun, or near a heater.
Doing so could cause a fire, burn or injury due to liquid leak, heat generation, blowout or other reason.

Safety precautions



Warning:

- Do not touch or hold the battery with wet hands.
Doing so could cause an electric shock or failure.
- Do not use a battery whose package is scratched or damaged.
Doing so could cause a blowout or heat generation.
- Do not insert the batteries with the ⊕/⊖ polarity reversed.
Doing so may cause fluid leakage, heat generation, fire or bursting.
 - Do not use a battery whose outer seal (insulating cover) is torn.
 - Remove the batteries if you are not going to use the recorder for an extended period of time.
 - When a battery is depleted, cover the contacts with tape to insulate them and dispose of the battery as general waste in accordance with local regulations.
 - Remove expended batteries from the unit at once. Leaving them in the unit may result in fluid leakage.
- If battery fluid gets into your eyes, flush your eyes immediately with clean, cold running water and seek medical attention immediately.
- Do not leave the battery within the reach of infants or children.
They could swallow the battery. If this happens, immediately consult a doctor.

- If you notice an abnormality such as abnormal sound, abnormally high temperature, burnt odor or smoke during use, perform the following steps:
 - ① Immediately remove the battery carefully.
 - ② Contact your dealer or the Olympus Service Station for service. Leaving it could cause a fire or burn.
- Do not soak the battery in freshwater or seawater or let the terminals get wet.
- If a battery leaks, becomes discolored or deformed, or becomes abnormal in any other way during operation, stop using the recorder.
- If a battery leaks fluid onto your clothing or skin, remove the clothing and flush the affected area with clean, cold running water immediately. If the fluid burns your skin, seek medical attention immediately.



Caution:

- Do not apply a strong shock to the battery or throw it.
- Please recycle batteries to help save our planet's resources. When disposing of dead batteries, be sure to cover their terminals and always observe local laws and regulations.

Getting started

Main features

1

Main features

Smart mode ([SMART]) for facilitating high-quality recording

The [SMART] Mode detects the maximum volume input during a set time interval and automatically optimizes the recording level. Once the set time interval has elapsed, recording automatically starts. This means that even sudden increases in the volume of the sound source can be recorded without distortion.

Mode dial for easy setting adjustment to suit your usage

The Mode dial allows you to easily change the recording setting in accordance with the conditions of use. Four modes are available:

- [QUICK] mode: In this mode the recording level will be adjusted automatically.
- [SMART] mode: In this mode the recording level will be adjusted automatically to the optimum level to suit the volume input within the set time.
- [MANUAL] mode: In this mode the recording level can be adjusted manually.
- Tuning Mode (Ψ) to measure the difference between the source and the reference.



Tresmic, a triple microphone system that enables high-quality recording of all sound frequencies from low to high (LS-14 only)

This system enables high-quality recording of the full range of sounds, from bass to treble. The combination of a high performance stereo microphone with a center microphone that enriches the bass enables wideband recording between 20Hz and 20,000Hz that is closer to the original sound.

TRESMIC
3 MICROPHONE SYSTEM

Linear PCM Recording feature with recording quality at least equal to a CD

This feature is capable of realistically recording various different sound sources. High resolution recording at a high sampling frequency and bit count equivalent or superior to that of a music CD (Sampling frequency 44.1 kHz, Bit count 16bit) is possible.

EN

10

A brand-new microphone design with maximum sound pressure of 130dBspl

The new built-in microphones with acoustic resistance of 130dBspl are designed to produce high-quality and immersive recordings without clipping even when recording live shows and concerts. The new high-sensitivity and low-noise stereo microphones faithfully capture the original sound. Stereo microphones are fixed at a 90° angle to allow natural and expansive stereo recording.

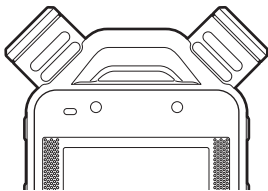

Metronome function

This feature can be used as a rhythm guide during recording.



Chromatic tuning function

This feature can be used to tune musical instruments. You can use the recorder as a tuning meter to tune musical instruments.

Download from www.Somanuals.com. All Manuals Search And Download.

Various other recording functions

In addition to the normal recording modes, two other functions can be selected: Overdubbing and Pre-recording. You can select the recording mode and function according to your use: recording of musical instrument practice, field recording, and so on.



File dividing function

You can divide files after recording (PCM, MP3) or during recording (PCM).

File trimming function (LS-14 only)

You can trim portions of files (PCM) and keep only the part you want.

Partial erase function

You can erase part of a PCM-format file that has been recorded with this recorder.

Large high-definition backlit display

Identification of parts

1

Identification of parts

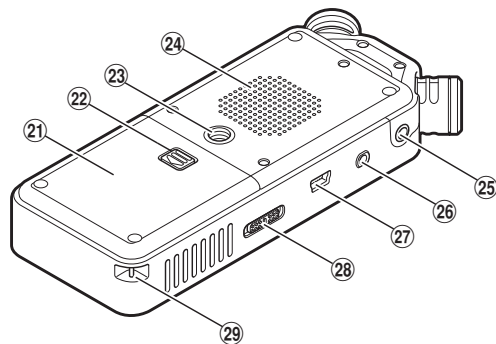
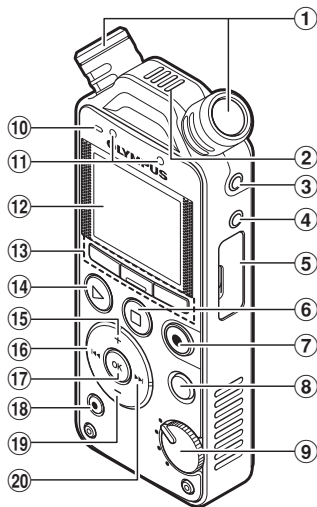

- ① Built-in stereo microphone
- ② Built-in center microphone (LS-14 only)
- ③ MIC (Microphone) jack
- ④ LINE IN jack
- ⑤ Card cover
- ⑥ STOP/⬇️ (■) button
- ⑦ REC (●) (Record) button,
Recording indicator light (LED)
- ⑧ MENU button
- ⑨ Mode dial
- ⑩ PEAK indicator light (LED)
- ⑪ LED indicator light
- ⑫ Display (LCD panel)

- ⑬ F1 button, F2 button, F3 button
- ⑭ PLAY (▶) button
- ⑮ + button
- ⑯ ◀◀ button
- ⑰ OK button
- ⑱ ERASE button
- ⑲ - button
- ⑳ ▶▶ button
- ㉑ Battery cover
- ㉒ Battery cover release button
- ㉓ Tripod socket
- ㉔ Built-in speaker

EN

12

Identification of parts

25 EAR (Earphone) jack

26 REMOTE jack

Connect the receiver of the exclusive remote control set RS30W (optional). This enables operation of the start and stop recording functions through the remote control.

27 USB connector

28 POWER/HOLD switch

29 Strap hole

1

Identification of parts

Display (LCD panel)

Folder list screen

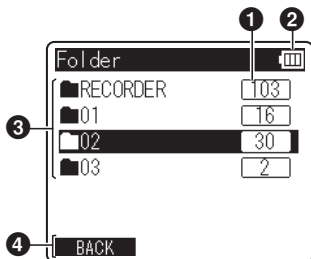

- 1 Total number of recorded files in the folder
- 2 Battery indicator
- 3 Folder name
- 4 Function guide indicator

File list screen

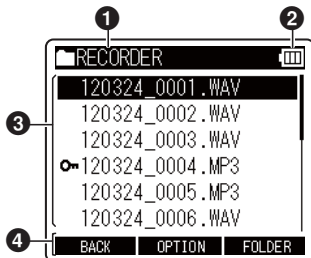

- 1 Current folder name
- 2 Battery indicator
- 3 File name
- 4 Function guide indicator

EN

13

Identification of parts

File screen

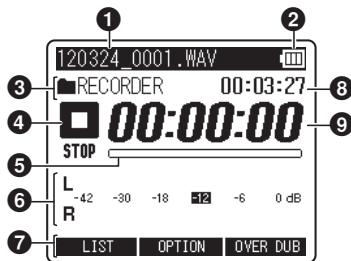

- 1 Current file name
- 2 Battery indicator
- 3 [OVERdub] indicator, Metronome indicator, Folder name
- 4 Recorder status indicator
 - REC: Record indicator
 - PAUSE: Pause indicator
 - STOP: Stop indicator
 - PLAY: Play indicator
 - FF: Forwarding indicator
 - REW: Rewinding indicator
 - F.PLAY: F. Play indicator
 - S.PLAY: S. Play indicator
- 5 Remaining memory bar indicator, Playback position bar indicator
- 6 Level meter
- 7 Function guide indicator
- 8 Remaining recording time, File length
- 9 Elapsed recording time, Elapsed playback time

1

Identification of parts

EN

14

Inserting batteries

This recorder can be used with AA Alkaline Batteries.

- 1 Press the battery cover release button, and then slide the battery cover open while lightly pressing it down.

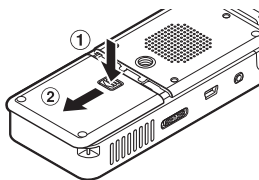

- 2 Insert the batteries, observing the correct ⊕ and ⊖ polarities.

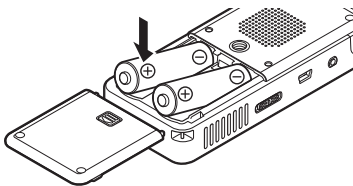

- 3 Close the battery cover completely by pushing the cover downwards in direction A while sliding it in direction B.

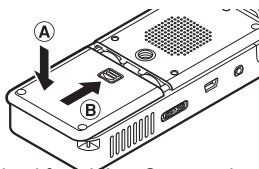

Battery indicator

The battery indicator on the display changes as the batteries lose power.



- When  appears on the display, replace the batteries as soon as possible. When the batteries are too weak, **[Battery Low]** will appear on the display and the recorder will shut down.

Notes

- Manganese batteries may not be used in this recorder.
- Be sure to turn off the recorder before replacing the batteries. Unloading the batteries while the recorder is in use may cause a malfunction such as corrupting the file, etc. If you take out the batteries while recording, you will lose your currently recorded file because the file header will not be able to close.
- If it takes longer than 15 minutes to replace the dead batteries or if you take the batteries in and out repeatedly at short intervals, you may have to re-enter the battery and time settings.
- Remove the batteries if you are not going to use the recorder for an extended period of time.
- When you are playing a file from the built-in speaker, the recorder may turn off depending on the volume level due to the reduced voltage output of the batteries even if  is displayed in the battery indicator. In this case, lower the volume of the recorder.

Turning on/off the power

When the recorder is not being used, turn the power off to reduce battery consumption. Existing data, mode settings, and clock settings are not lost when the power is turned off.

1

Turning on/off the power

Turning on the power

While the recorder is turned off, slide the **POWER/HOLD** switch in the direction of the arrow.

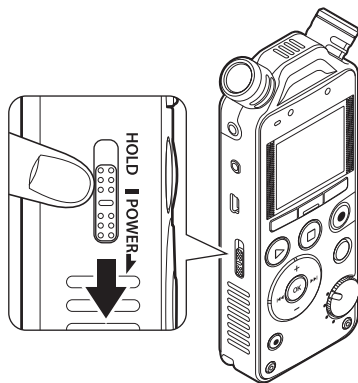

- The power turns on.

Turning off the power

Slide the **POWER/HOLD** switch in the direction of the arrow, and hold it for 1 second or longer.

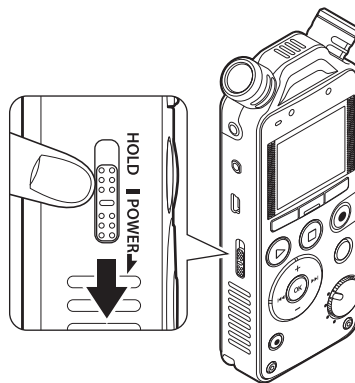

- The power turns off.

Power save mode

If the recorder is on but is not used for 10 minutes or longer (default), the display shuts off and the recorder goes into power save mode (P.72).

- To exit power save mode, press any button.

EN

16

HOLD

If you set the recorder to HOLD mode, the current settings will be preserved and all buttons will be disabled. This feature is useful when the recorder has to be carried in a bag or pocket. This mode can also prevent you from accidentally stopping recording.

Setting the recorder to HOLD mode

Slide the **POWER/HOLD** switch to the **[HOLD]** position.

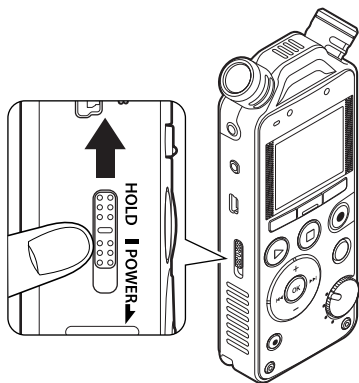

Exiting HOLD mode

Slide the **POWER/HOLD** switch to the **(A)** position.

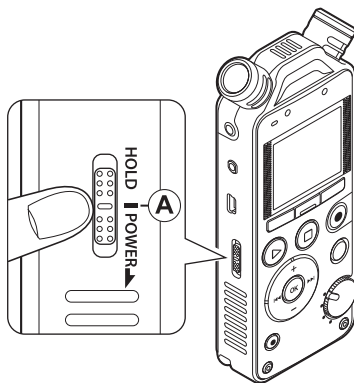

- After **[Hold]** appears on the display, the recorder is set to HOLD mode.

Notes

- If you press any button while the recorder is in HOLD mode, the clock screen lights for 2 seconds, but the recorder does not operate.
- If HOLD is applied during playback (recording), operation is disabled with the playback (recording) state unchanged (When playback has ended or recording has ended due to the remaining memory being used up, the recorder stops).
- The recorder can be effectively operated via the exclusive remote control set RS30W (optional), even when it is in HOLD mode.

Download from [Www.Somanuals.com](http://www.Somanuals.com). All Manuals Search And Download.

Setting the time and date [Time & Date]

If you set the time and date before using the recorder, recording time and date information is automatically stored for each file. Setting the time and date beforehand enables easier file management.

1

Setting the time and date [Time & Date]

When you use the recorder for the first time, or when the battery is inserted after the recorder has not been used for a long time, [Set time & date] will appear. When "Hour" is flashing, conduct setup from Step 1.

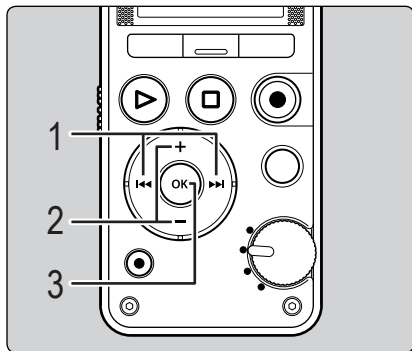

1 Press the ►► or ◀◀ button to select the item you want to set.

- Select "Hour", "Minute", "Year", "Month" or "Day" by moving the flashing position.

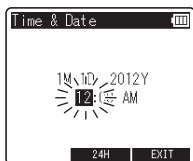

2 Press the + or – button to change the value.

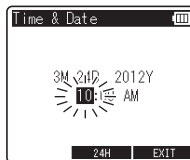

- Follow the same steps by pressing the ►► or ◀◀ button to select the next item, and pressing the + or – button to change the value.
- You can select between 12 and 24 hour display by pressing the F2 button while setting the hour and minute.

Example: 10:38 P.M

10:38 PM (Initial setting) ◀────────▶ 22:38

- You can select the order of "Month", "Day" and "Year" by pressing the F2 button while setting these items.

EN

18

Setting the time and date [Time & Date]

Example: March 24, 2012

3M 24D 2012Y
(Initial setting)

24D 3M 2012Y

2012Y 3M 24D

3

Press the **OK** button to complete the setting.

- The clock will start from the set date and time. Press the **OK** button when you want the clock to start.

Notes

- If you press the **OK** button during the setup operation, the recorder will save the items that were set to that point.
- After setup, a message will sound prompting you to select [**Off**], if voice guidance is not required and the screen will go into [**Voice Guide**] (☞ P.74) setup. If you don't want the guidance feature, select [**Off**] (LS-14 only).

While the recorder is in stop mode at the [**Home**] screen, press and hold the **STOP/⏏** (■) button to display [**Time & date**] and [**Remain**]. If the current time and date are not correct, set them using the time and date setting. See "**Changing the time and date [Time & Date]**" (☞ P.75).



1

Setting the time and date [Time & Date]

EN

19

Inserting and ejecting an SD card

"SD" indicated in the instruction manual refers to both SD and SDHC. This recorder enables you to store data not only to the internal memory but also to a commercially available SD card.

1

Inserting and ejecting an SD card

Inserting an SD card

- 1 While the recorder is in stop mode, open the card cover.

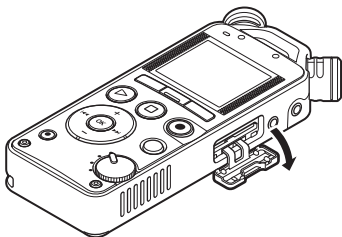

- 2 With the SD card facing the correct way, insert it into the card slot as shown in the diagram.

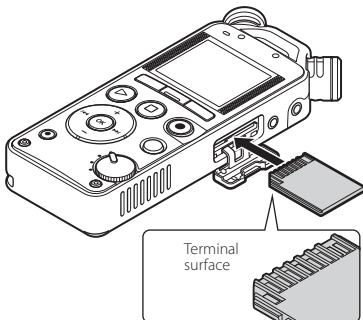

- Insert the SD card, keeping it straight.
- Inserting the SD card in the wrong way or at an angle could damage the contact area or cause the SD card to jam.
- If the SD card is not inserted all the way, data may not be recorded on the SD card.
- When you insert the SD card, the recording media changeover screen will appear.

- 3 Close the card cover securely.

- 4 To record on an SD card, press the + or – button and select [Yes].

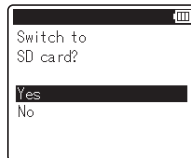

- 5 Press the OK button to complete the setting.

Notes

- It is possible to switch the recording media over to the internal memory (☞ P.72).
- In some cases SD cards that have been formatted (initialized) by another device, such as a computer, may not be recognized. Be sure to format SD cards with this recorder before using them (☞ P.78).
- Battery life may be shorter when using an SD card (☞ P.98).

Inserting and ejecting an SD card

Ejecting an SD card

- 1 While the recorder is in stop mode, open the card cover.
- 2 Push the SD card inward to unlock it, and let it eject partially.

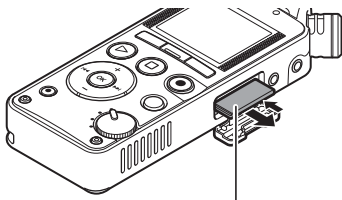

The SD card is visibly out of the slot and can be removed safely.

- If you eject the SD card when **[Memory Select]** is set to **[SD card]**, **[Memory Select]** will automatically change to **[Internal memory selected]**.

- 3 Close the card cover securely.

SD card

When the write protection switch is set to **[LOCK]**, you cannot record or erase files.

Write protection switch



Notes

- Quickly moving your finger away after pushing the SD card inward may cause it to eject forcefully out of the slot.
- Some SD cards or SDHC cards may not be recognized correctly depending on the manufacturer or type of card due to compatibility issues with this recorder.
- See the Olympus website for a list of SD cards that have been confirmed to operate with this recorder in conditions prescribed by Olympus. The website <http://olympus-imaging.jp/> introduces manufacturers and types of SD cards confirmed to be compatible. Please note, however, this is not meant to guarantee that SD cards will operate. Some SD cards may not be recognized correctly due to circumstances such as changes in manufacturer specifications.
- Always read the instructions that come with your SD card before using it.
- If an SD card is not recognized, remove the SD card and then insert it again to see if the recorder recognizes the SD card.
- Processing speed may be slower with some types of SD cards. Processing performance may also be reduced due to repeated writing and deleting. If that happens, reformat the SD card (P.78).

[Home] screen operations

When you turn on the recorder, the [Home] screen will be displayed. The [Home] screen is the main screen used for accessing each function. In addition, you can also verify the current settings for recording and playback.

1

[Home] screen operations

Switching functions

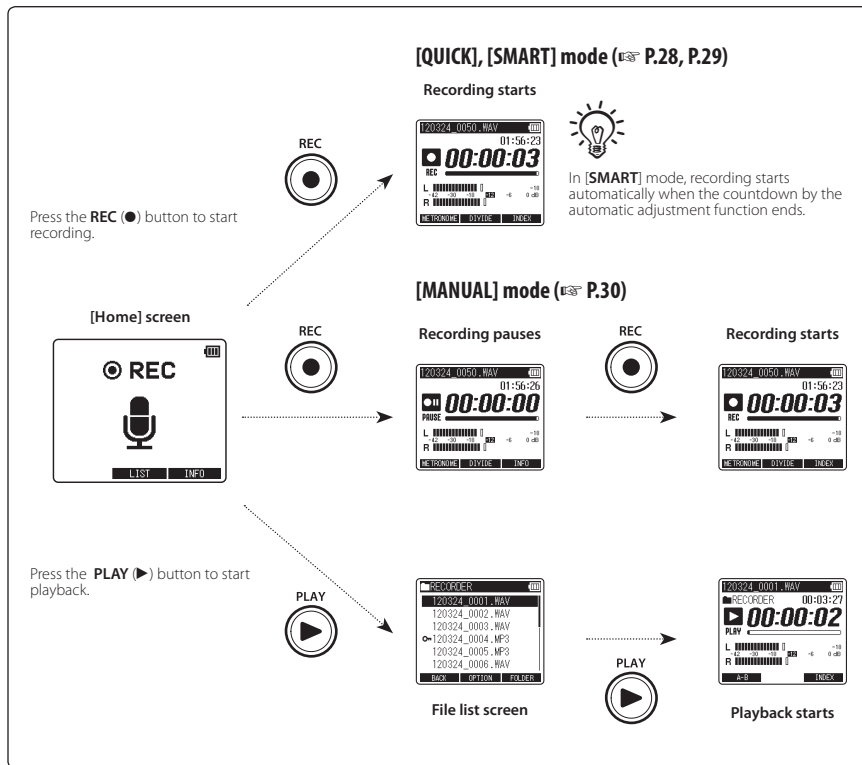

EN

22

Verifying the current settings

Press and hold the **F3 (INFO)** button on the **[Home]** screen. You can also check it while recording is paused.

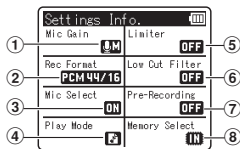

The following settings will be displayed.

- 1 **[Mic Gain]** (☞ P.66)
- 2 **[Rec Format]** (☞ P.66)
- 3 **[Mic Select]*** (☞ P.67)
- 4 **[Play Mode]** (☞ P.70)
- 5 **[Limiter]** (☞ P.66)
- 6 **[Low Cut Filter]** (☞ P.67)
- 7 **[Pre-Recording]** (☞ P.68)
- 8 **[Memory Select]** (☞ P.72)

* LS-14 only

Notes on the folders

The internal memory or an SD card can be used as the recording media. All files recorded with this recorder will be stored in the [RECORDER] folder regardless of the recording media.

1

Notes on the folders

Folder for recorded files:

Recorded files will be saved in the [RECORDER] folder.

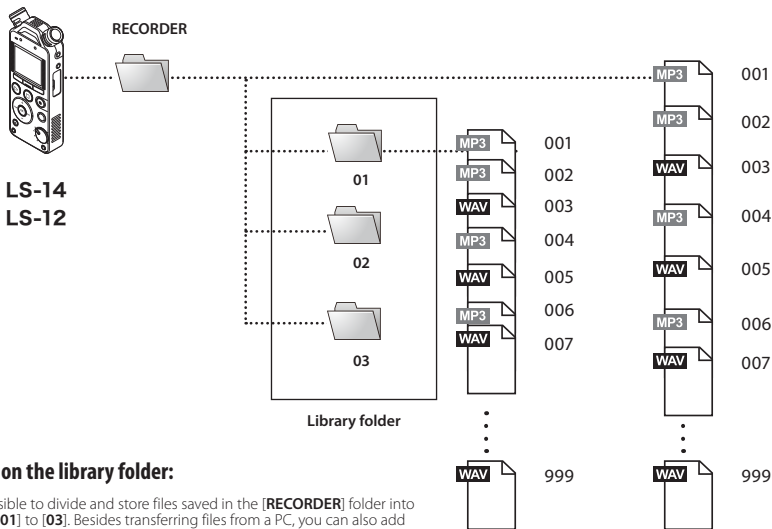

Notes on the library folder:

It is possible to divide and store files saved in the [RECORDER] folder into folders [01] to [03]. Besides transferring files from a PC, you can also add new folders by keeping the same hierarchy as folders [01] to [03]. You can add up to 200 folders (including the [01], [02] and [03] folders). It's not possible to add a folder with a name already in use.

Each folder can store up to 999 files.

Notes

- Files placed in the same hierarchical level as the [RECORDER] folder will not be recognized.
- This recorder will not recognize folders if they are created inside the [01], [02] or [03] folder.

Selecting folders and files

Change folders while the recorder is stopped. For information on the layered structure of the folders, see the section entitled “Notes on the folders” (see P.24).

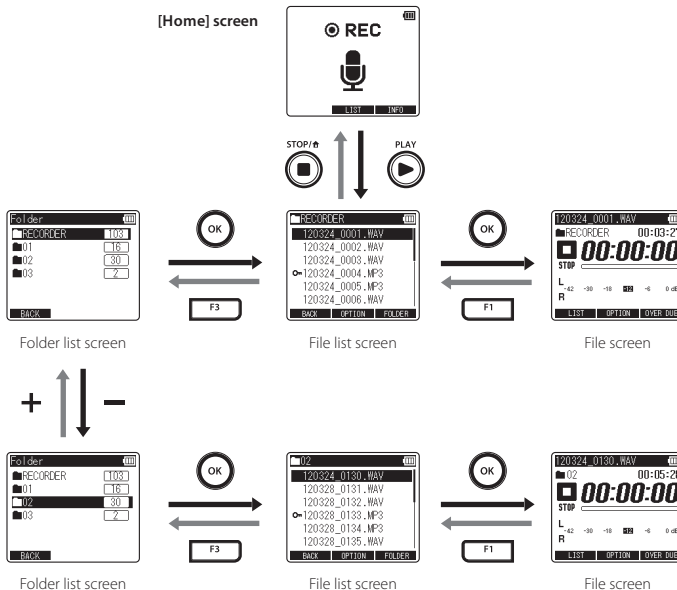

Moving through the levels

← Return: F1 (BACK) button

Pressing this button takes you back to the previous screen.

→ Proceed: OK button

Pressing this button opens the folder or file selected in the list screen.

+ or - button

Selects a folder or file.

F1 (LIST) button:

The display changes to the File list screen.

F3 (FOLDER) button:

The display changes to the Folder list screen.

List screen:

The folders and files stored in the recorder are displayed.

File screen:

Information about the selected file is displayed. The recorder is in playback standby mode.

About recording

Recording tips for each instrument

2

Recording tips for each instrument

Recorder position examples

Voice

Position the recorder slightly away from the singer's face. If breathing noises are audible, adjust the recorder position.

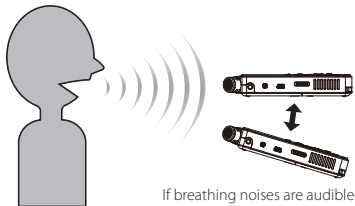

Wind instrument

Position the recorder pointing to the center of the so-called "bell." If breathing noises are audible, move the recorder slightly away from the center.

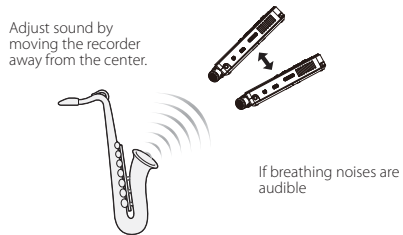

Piano

When recording the sound of a grand piano, position the recorder pointing to the center of the open lid. To record acousmato as well, move the recorder slightly away to get a richer sound.

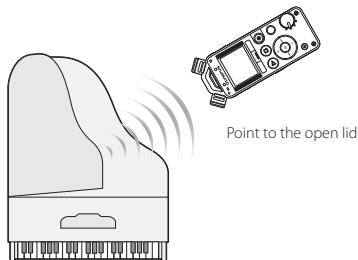

String instrument

When recording the sound of a string instrument such as a violin, position the recorder slightly away from the upper part of the instrument, pointing to the f-hole of the body.

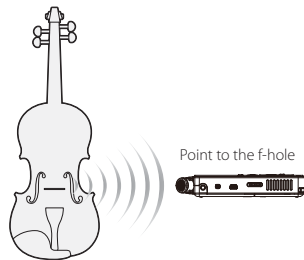

EN

26

Recording tips for each instrument

Acoustic guitar

Position the recorder pointing to a place slightly away from the sound hole of the guitar. For a rhythm guitar, keep a certain distance from the main body of the guitar. For solo or melody-focused music, keep the recorder closer to the main body of the guitar during recording.

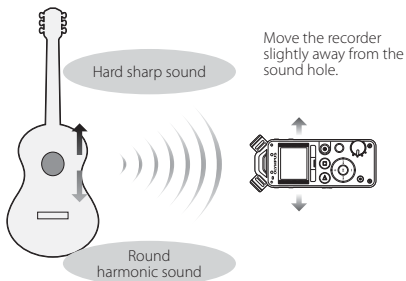

Hall

Place the recorder on the center line of the stage, with players also facing the direction of the microphone. Then, fix the recorder with a tripod or other tool before starting recording.

Orchestra, big band, choir, etc...



Electric guitar

To record sound directly from the speaker of a guitar amplifier, position the recorder slightly away from the speaker and pointing to the center of the speaker cone paper. To record sound from two speakers in stereo, position the recorder slightly away from the center between the left and right speakers. To record sound in mono, position the recorder slightly away from the center of the speaker cone paper.

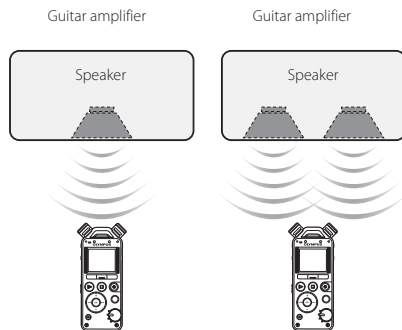

2

Recording tips for each instrument

EN

27

Recording

2

Recording

The recorder has three recording modes that can be selected by using the Mode dial. Use them according to your needs.

[QUICK] mode: In this mode the recording level will be adjusted automatically. This mode is useful if you want to start recording immediately.

[SMART] mode: In this mode the recording level will be adjusted automatically to the optimum level to suit the volume input within the set time. Recording starts after the recording level is adjusted, so even sudden loud sounds are recorded without distortion. This mode allows you to set a time for detecting the input volume (Ⓢ P.29, P.68).

[MANUAL] mode: In this mode the recording level can be adjusted manually (Ⓢ P.30).

Notes

- The newly recorded file will be saved last in the **[RECORDER]** folder.
- Set **[Rec Format]** while the recorder is stopped (Ⓢ P.66).
- Set the Mode dial while the recorder is stopped.

[QUICK] mode

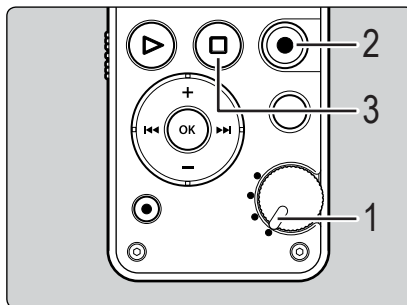

- 1 Switch the Mode dial to the **[QUICK]** position.



- 2 Press the **REC** (●) button to start recording.

- The recording indicator light turns on and  appears on the display.

Recording

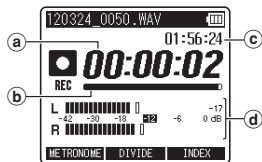

- a** Elapsed recording time
 - b** Remaining memory bar indicator
 - c** Remaining recording time
 - d** Level meter (changes according to the recording level and recording function settings)
- If the recording level is low, please change the **[Mic Gain]** setting to **[Hi]** or **[Mid]** (☞ P.66).
 - This recorder is able to record in high quality even when the volume of the sound source changes significantly. However even higher quality can be realized by adjusting the recording level manually.

3 Press the STOP/⏏ (■) button to stop recording.

- appears on the display.



- e** File length

[SMART] mode

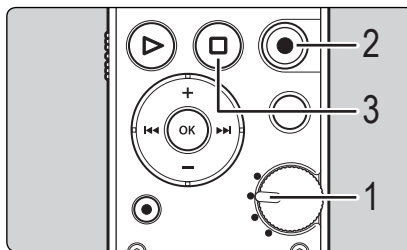

1 Switch the Mode dial to the [SMART] position.



2 Press the REC (●) button to start automatic adjustment of the recording level.

- The countdown of the **[Smart Time]** starts (☞ P.68).
- When the countdown of the automatic adjustment time ends, recording starts with the adjusted settings.

Recording

2

Recording

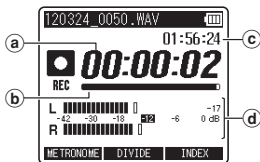

- a Elapsed recording time
- b Remaining memory bar indicator
- c Remaining recording time
- d Level meter (changes according to the recording level and recording function settings)
 - The recording level will be adjusted automatically depending on the volume input within the set time. During recording level adjustment, **[Setting Rec Level]** and the remainder of the set time will be displayed (see P.68).
 - If you want to cancel automatic adjustment, press the **F1 (CANCEL)** or **STOP/▲ (■)** button. If you want to skip automatic adjustment and start recording immediately, press the **F3 (SKIP)** or the **REC (●)** button.
 - After automatic adjustment, you can adjust the recording level manually by using the **▶▶1** and **1◀◀** buttons (see P.31).

3 Press the STOP/▲ (■) button to stop recording.

-  appears on the display.



- e File length

[MANUAL] mode

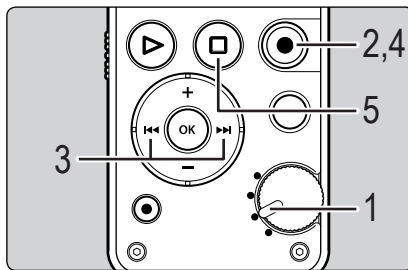

1 Switch the Mode dial to the [MANUAL] position.



2 Press the REC (●) button to prepare to record.

- The recording indicator light flashes and  appears on the display.

EN

30

Recording

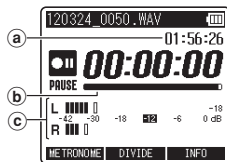

- a Remaining recording time
- b Remaining memory bar indicator
- c Level meter (changes according to the recording level and recording function settings)

3 Press the **▶▶** or **◀◀** button to adjust the recording level.

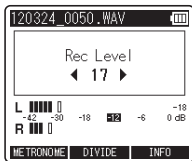

- Distorted sound will be recorded while **[OVER]** is displayed. Adjust the recording level so that **[OVER]** is not displayed.
- The level can be adjusted between **[01]** and **[70]***. The higher the number, the higher the level and the larger the indicator position on the level meter.

* When recording from the **LINE IN** jack, you can adjust the level between **[01]** and **[30]**.

4 Press the **REC** (●) or **PLAY** (▶) button to start recording.

- The recording indicator light turns on and **[RECORD]** appears on the display.

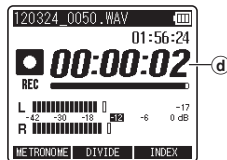

- d Elapsed recording time

5 Press the **STOP/⏏** (■) button to stop recording.

- **[RECORD]** appears on the display.

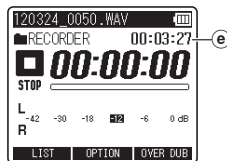

- e File length

Notes

- Inputting a very loud sound may produce noise even when the Mode dial is set to **[QUICK]** or **[SMART]**.
- To ensure that you do not lose the beginning of the recording, verify that the recording indicator light or the mode indicator is lit on the display.
- When the remaining recording time is less than 60 seconds, the LED indicator light starts flashing. When the remaining recording time drops to 30 and then 10 seconds, the light flashes faster.
- While adjusting the recording level manually, the sound input may be interrupted.
- **[Folder full]** will appear when recording cannot be continued. Delete unnecessary files or move them to another folder before recording (☞ P.48, P.61).
- **[Memory full]** will appear when the memory is full. Delete unnecessary files before recording any further (☞ P.61).
- When an SD card is inserted into the recorder, be sure to confirm the recording media as either **[Internal memory]** or **[SD card]** so that there is no mistake (☞ P.23, P.72).
- Processing speed may be slower with some types of SD cards. Processing performance may also be reduced due to repeated writing and deleting. If that happens, reformat the SD card (☞ P.78).
- We recommend formatting the recording media in the recorder before recording.

Recording more than 2 GB of data in linear PCM format

Recording will continue even if the volume of a single file exceeds 2 GB in linear PCM format recording.

- The data is saved every 2 GB in separate files. It is treated as multiple files during playback.
- If the 999th file in a folder exceeds 2 GB, recording stops.

Settings relating to recording

[Mic Gain] (☞ P.66)	Sets the recording sensitivity.
[Limiter] (☞ P.66)	Switches the correction method according to the sound input when recording.
[Rec Format] (☞ P.66)	Sets the recording rate for each recording format.
[Low Cut Filter] (☞ P.67)	This function can reduce noise from air conditions and projectors and other similar noises.
[Plug-in Power] (☞ P.67)	Selects whether or not to use the plug-in power function according to the external microphone connected to the MIC jack.
[Mic Select]* (☞ P.67)	Selects whether or not the built-in center microphone is to be turned On or Off.
[Pre-Recording] (☞ P.68)	Pre-recording enables you to start recording up to 2 seconds before you press the button for recording.
[Rec Monitor] (☞ P.68)	Selects whether or not to output the recording monitor sound from the EAR jack.
[Smart Time] (☞ P.68)	You can set the time for [SMART] mode automatic adjustment.
[Metronome] (☞ P.68)	You can set the metronome as a rhythm guide during recording.

* LS-14 only

Pause

While the recorder is in recording mode, press the **REC** (●) or **PLAY** (▶) button.

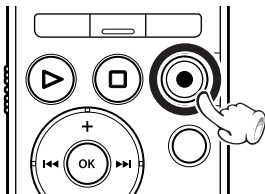

- [●] will appear on the display.
- The recorder will stop if left on pause for more than 60 minutes.

Resume Recording

Press the **REC** (●) or **PLAY** (▶) button again.

- Recording will resume at the point of interruption.

Listening while audio is recorded

If you start recording after inserting the earphones into the **EAR** jack on the recorder, you can hear the audio being recorded. The recording monitor volume can be adjusted by pressing the + or – button.

Connect the earphones to the **EAR** jack on the recorder.

- After recording has started, you can hear the audio being recorded through the earphones.



Notes

- You cannot control the recording level using the volume button.
- To avoid hurting your ears, turn down the volume before inserting the earphones into your ears.
- Do not place earphones near a microphone as this may cause feedback.
- If an external speaker is connected during recording, there is a risk that audio feedback will occur. It is recommended that you use earphones to monitor recording, or turn [Rec Monitor] to [Off] while recording (P.68).

Dividing a file while recording

You can also divide files while recording. This is useful, for example, when you want to have different files for each movement of a concert.

2

Recording

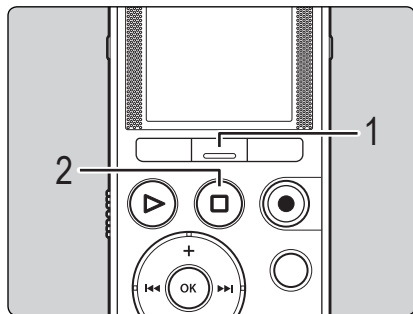

- Please set the [Rec Format] to [PCM] in advance (☞ P.66).
- The maximum number of files that can be stored in the [RECORDER] folder is 999. If there are already more than 998 files, file division will not be possible. If you have already reached the limit, calculate the number of times you will divide the file and delete the files that you do not need (☞ P.61) or move them to other folders (☞ P.48) beforehand to make space.
- You cannot divide a file while overdubbing is in progress.

1

At the position where you want to divide the file, press the **F2 (DIVIDE)** button.

- Recording will continue uninterrupted.

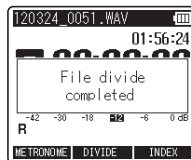

2

Press the **STOP/⏏ (■)** button to stop recording.

Using the overdubbing function

The overdubbing function enables you to dub sound over a file while listening to it. The recorded file is saved under a different name. This is useful when practicing songwriting and musical instruments.

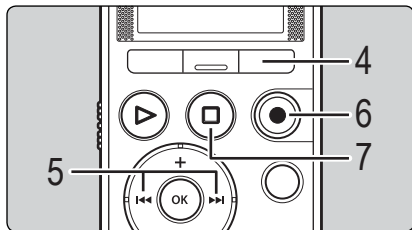

When using the overdubbing function, the following conditions must be met:

- Select a (.wav) file with the format [PCM 44.1kHz/16bit] as the file to be played (P.25, P.60).
- Set [Rec Format] to [PCM 44.1kHz/16bit] (P.66).

1 Switch the Mode dial to the [QUICK] or [MANUAL] position (P.28, P.30).

- This function is not enabled when the Mode dial is set to [SMART].

2 Select a file to dub over (P.25).

3 Connect earphones to the EAR jack of the recorder.

- The file to be dubbed over will be played back through the EAR jack.

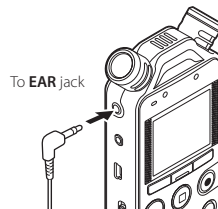

- Set [Rec Monitor] to [On] (P.68).

4 While the recorder is in stop mode, press the F3 (OVER DUB) button.

- If the Mode dial is set to [QUICK], recording and playback will start simultaneously. Proceed to Step 7.
- If the Mode dial is set to [MANUAL], playback will start first.

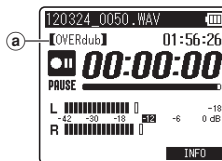

(a) Overdubbing

Recording

2

Recording

5 Press the ►►► or ◀◀◀ button to adjust the recording level.

- You can adjust the recording level by using the ►►► or ◀◀◀ button depending on the volume level during playback.

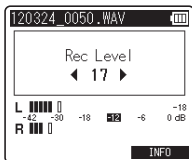

6 Press the REC (●) button to start recording.

- Playback will start again from the beginning. Recording will start at the same time.

7 Press the STOP/⏏ (■) button to stop recording.

Notes

- When the original playback file ends, overdubbing also ends.
- When the [OVER DUB] function is used, the following functions cannot be used.
 - [DIVIDE] (P.34)
 - [Pre-Recording] (P.68)
 - [Metronome] (P.68)

Using the metronome function

The metronome is a useful rhythm guide and can be used during recording.

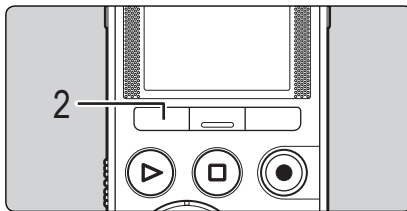

1 Set the metronome function (P.68).

- Set [Rec Monitor] to [On] (P.68).

2 Press the F1 (METRONOME) button while recording or pausing.

- Turn the metronome ON or OFF by pressing the F1 (METRONOME) button.

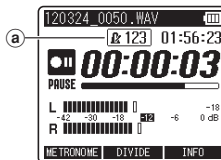

a Metronome

- The metronome works with the current settings. The sound of the metronome will not be recorded.
- The LED indicator lights on the recorder light in time with the metronome.

EN

36

Notes

- The sound of the metronome will be output from the **EAR** jack. Connect earphones to hear the metronome.
- When [**Rec Monitor**] is set to [**Off**], no metronome sound is output.

File names are automatically created for files recorded by this recorder.

120324 _0001 .WAV

①

②

③

① **Time stamp:**

2012.03.24

② **File number:**

A file number is consecutively assigned regardless of changes in the selected recording media.

③ **Extension:**

This is the file name extension indicating the recording format used when recording with this recorder.

- Linear PCM format .WAV
- MP3 format .MP3

Recording from an external microphone or other device

An external microphone or other device can be connected and audio can be recorded. Connect as follows according to the device to be used.

- Do not plug/unplug devices into the recorder's jack while it is recording.

Recording with an external microphone

Connect an external microphone to the **MIC** jack of the recorder.

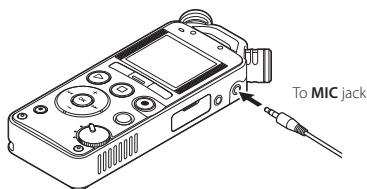

- Applicable external microphones (optional) (☞ P.94).

Notes

- The built-in microphone becomes inoperable when an external microphone is plugged into the recorder's **MIC** jack.
- Microphones supported by plug-in power can also be used.
- When an external monaural microphone is used while **[Rec Format]** is set to a stereo recording mode, audio is recorded to the L channel only (☞ P.66).
- When an external stereo microphone is used while **[Rec Format]** is set to a monaural recording mode, audio is recorded to the L channel only (☞ P.66).
- To record using an external microphone, connect it to the **MIC** jack. If you connect it to the **LINE IN** jack, the recorder will not record sound properly.
- If you use the **MIC** jack and **LINE IN** jack at the same time, input from the **LINE IN** jack has priority.

Recording audio from another device with this recorder

Audio can be recorded when you have connected the audio output terminal (earphone jack) of another device and the **LINE IN** jack of the recorder using the connecting cord KA334 (optional) for dubbing.

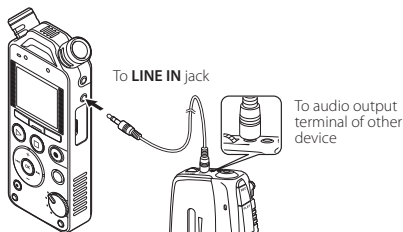

Recording audio from this recorder with another device

Audio from this recorder can be recorded to another device by connecting the audio input terminal (microphone jack) of the other device and the **EAR** jack of this recorder using the connecting cord KA333 (optional).

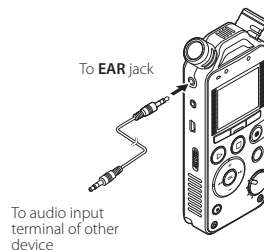

Notes

- If you are unable to produce a clear recording with this recorder even after adjusting the recording level (P.31), this could potentially be because the output level for the connected devices is too high or too low. When external devices are connected, perform a test recording and then adjust the output level for the external devices.
- To record sounds from another device, connect to the **LINE IN** jack. If you connect to the **MIC** jack, the sound will distort and cannot be recorded properly.

About playback

Playback

The recorder can play back WAV and MP3 format files. To play back a file recorded with another device, you need to transfer (copy) it from a computer.

3
Playback

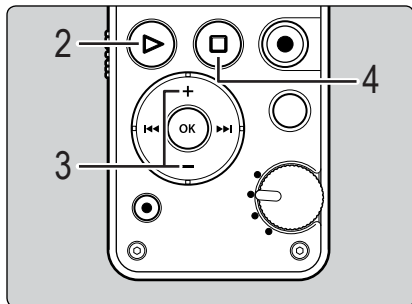

1 Select the file to be played back from the folder that contains it (see P.25).

2 Press the **PLAY** (▶) button to start playback.

- ▶ appears on the display.

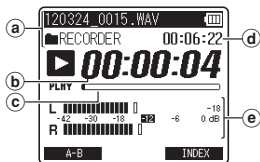

- a File name, Folder name
- b Elapsed playback time
- c Playback position bar indicator
- d File length
- e Level meter

3 Press the **+** or **-** button to adjust the volume.

- The volume can be adjusted within the range of [00] to [30].

4 Press the **STOP/PAUSE** (■) button at any point where you want to stop playback.

- appears on the display.
- Pressing this button stops the file being played.

Settings relating to playback

[Play Mode] (☞ P.70)	You can select the desired playback range and repeat playback.
[Skip Space] (☞ P.70)	The skip interval can be set.

Playback through the earphones

The earphones can be connected to the **EAR** jack of the recorder for listening.

- When the earphones are used, the recorder speaker is switched off.



Notes

- To avoid hurting your ears, turn down the volume before inserting the earphones into your ears.
- When using the earphones, do NOT set the volume too high. Listening at very high volume may lead to hearing loss.

Forwarding

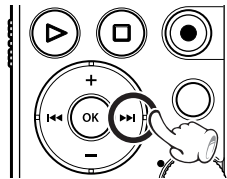

While the recorder is in stop mode in the File screen, press and hold the **▶▶▶** button.

- **▶▶▶** appears on the display.
- When you release the **▶▶▶** button, forwarding stops. Press the **PLAY (▶)** button to start playback from where forwarding stopped.

While the recorder is in playback mode, press and hold the **▶▶▶** button.

- When you release the **▶▶▶** button, the recorder resumes normal playback.
- If there is an index mark or temp mark within the file, the recorder stops at that location (☞ P.44).
- The recorder stops when it reaches the end of the file. Continue pressing the **▶▶▶** button to continue forwarding from the beginning of the next file.

Rewinding

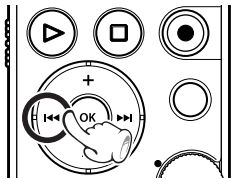

While the recorder is in stop mode in the File screen, press and hold the **◀◀** button.

- **◀◀** appears on the display.
- When you release the **◀◀** button, rewinding stops. Press the **PLAY (▶)** button to start playback from where rewinding stopped.

While the recorder is in playback mode, press and hold the **◀◀** button.

- When you release the **◀◀** button, the recorder resumes normal playback.
- If there is an index mark or temp mark within the file, the recorder stops at that location (☞ P.44).
- The recorder stops when it reaches the beginning of the file. Continue pressing the **◀◀** button to continue rewinding from the end of the previous file.

Locating the beginning of a file

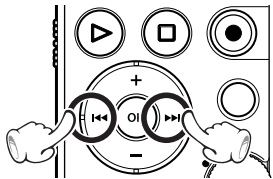

While the recorder is in stop mode or playback mode, press the **▶▶** button.

- The recorder skips to the beginning of the next file.

While the recorder is in playback mode, press the **◀◀** button.

- The recorder skips to the beginning of the current file.

While the recorder is in stop mode, press the **◀◀** button.

- The recorder skips to the beginning of the previous file. If the recorder is in the middle of a file, it will return to the beginning of the file.

While the recorder is in playback mode, press the **◀◀** button twice.

- The recorder skips to the beginning of the previous file.

Notes

- When you skip to the beginning of the file during playback, the recorder stops at the position of the index mark or temp mark. Index marks and temp marks are skipped when you perform this operation in stop mode (☞ P.44).
- When [Skip Space] is set to a setting other than [File Skip], the recorder skips forward/reverse by the specified time and then starts playback (☞ P.70).

About music files

In cases where the recorder is unable to play back music files that have been transferred to it, check to make sure that the sampling rate and bit rate are in the range where playback is possible. Combinations of sampling rates and bit rates for music files which the recorder can play back are given below.

File format	Sampling frequency	Bit rate
WAV format	44.1 kHz, 48.0 kHz	16 bit
	88.2 kHz, 96.0 kHz	24 bit
MP3 format	MPEG1 Layer3: 32 kHz, 44.1 kHz, 48 kHz MPEG2 Layer3: 16 kHz, 22.05 kHz, 24 kHz	From 8 kbps up to 320 kbps

- Variable bit rate MP3 files (in which conversion bit rates can vary) may not be played back properly.
- For WAV files, this recorder can only play back those in the linear PCM format. WAV files other than these cannot be played back.
- Even if the file format is compatible for playback on this recorder, the recorder does not support every encoder.

Changing the playback speed

The tone will be automatically adjusted digitally without changing the voice so it sounds natural.

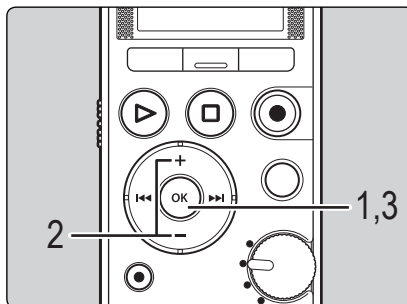

- 1 While the recorder is in playback mode, press the OK button.
- 2 Press the + or – button to select playback speed.

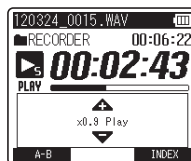

3 Press the OK button.

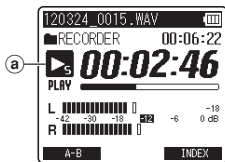

- a Playback speed indicator
- Even if playback is stopped, the changed playback speed will be retained. The next playback will be at that speed.

Note

- As in normal playback mode, you can stop playback, cue a file, or insert an index or temp mark in slow playback and fast playback modes as well.

Setting an index mark or a temp mark

If index marks and temp marks have been placed into your files, you can quickly find a location you want to listen to when you are fast forwarding, fast rewinding, or cueing a file. Index marks can only be placed into files created by Olympus voice recorders, but temp marks can be used to temporarily remember desired locations.

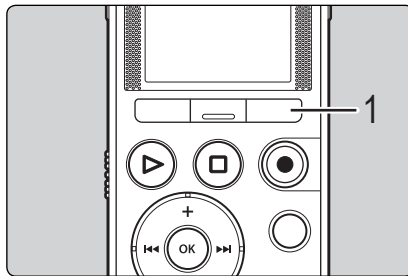

1 While the recorder is in recording mode or playback mode, press the F3 (INDEX) button.

- A number appears on the display and an index mark or temp mark is placed into the file.

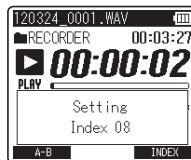

Playback

- Even after an index or temp mark has been placed into a file, recording or playback will continue so you can place index or temp marks in other locations in a similar manner.
- The index or temp mark is erased.
- Index or temp numbers after the erased index or temp number automatically decrement by 1.

Clearing an index mark or a temp mark

- 1 Play a file that contains index or temp marks you wish to erase.
- 2 Press the **▶▶|** or **|◀◀** button to select the index or temp mark to be erased.



- 3 While the index or temp number is displayed for approximately 2 seconds on the display, press the **ERASE** button.

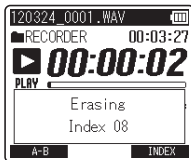

Notes

- Temp marks are temporary markings, so if you move to another file or connect the recorder to a PC, the marks will automatically be erased.
- Up to 99 index and temp marks can be set in a file. If you try to set more than 99 index or temp marks, the **[No more can be set]** message appears for index marks and the **[No more can be set]** message appears for temp marks.
- Index or temp marks cannot be set or erased in a locked file (see P.51).

How to begin segment repeat playback

This function enables repeated playback of part of the file being played.

3

Playback

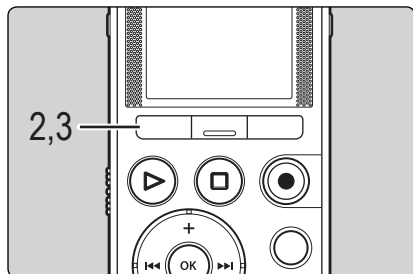

1 Select a file that has a segment you would like to play back repeatedly, and start playback.

2 Press the F1 (A-B) button at the position where you want to start segment repeat playback.

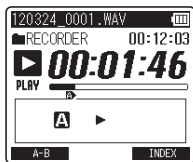

- While **[A]** is displayed, you can fast forward, rewind, or change the playback speed in the same way as in normal mode to find the end position (☞ P.41, P.43).
- If the recorder reaches the end of the file while **[A]** is displayed, point **[B]** becomes the end of the file, and repeat playback starts.

3 Press the F1 (A-B) button again at the position where you want to end segment repeat playback.

- The recorder continuously plays back the segment until segment repeat playback is canceled.

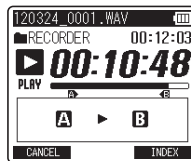

Note

- As in normal playback mode, the playback speed can be changed during segment repeat playback as well (☞ P.43). If an index mark or temp mark is set or cleared during segment repeat playback, segment repeat playback is canceled and the recorder returns to normal playback mode (☞ P.44).

Canceling the segment repeat playback function

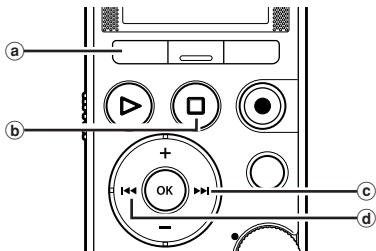

Pressing any of the following buttons releases segment repeat playback.

- a** Press the **F1 (CANCEL)** button
Pressing the **F1 (CANCEL)** button releases segment repeat playback, and it will return to normal playback mode.
- b** Press the **STOP/⏏ (■)** button
Pressing the **STOP/⏏ (■)** button releases segment repeat playback and stops playback.
- c** Press the **▶▶▶** button
Pressing the **▶▶▶** button releases segment repeat playback, and makes the recorder skip to the beginning of the next file.
- d** Press the **◀◀◀** button
Pressing the **◀◀◀** button releases segment repeat playback, and makes the recorder skip to the beginning of the current file.

File management

Editing [OPTION]

Recorded files options

[Move/Copy]	Files can also be moved or copied between memory.
[File Lock] (⇨ P.51)	Locking a file keeps important data from being accidentally erased.
[File Divide]*1 (⇨ P.54)	Only files recorded with this recorder can be divided.
[Partial Erase]*1 (⇨ P.56)	An unwanted part of a file can be erased. Only a PCM file recorded with this recorder can be partially erased.
[Trimming]*1 *2 (⇨ P.58)	You can trim a part of a file and save it as a new file. Only a PCM file recorded with this recorder can be trimmed.
[Property] (⇨ P.60)	[Name] (File name), [Date] (Time stamp), [Size] (File size), [Bit Rate] (File format), [File Lock] (File protection)

*1 This function is not available when the File list screen is displayed.

*2 LS-14 only

Note

- The recorder stops if you leave it idle for 3 minutes during a menu setup operation and do not set a selected item.

Moving/Copying a file [Move/Copy]

Files saved in the internal memory or an SD card can be moved or copied within the memory. Files can also be moved or copied between memory. You can edit a single selected file or multiple files.

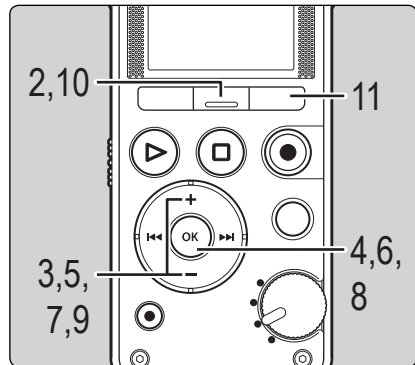

- 1 First, select the file or the folder that contains the file you want to copy/move (⇨ P.25).

2 While the recorder is in stop mode, press the **F2 (OPTION)** button.

- The [OPTION] screen appears on the display.

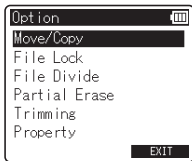

3 Press the **+** or **-** button to select [**Move/Copy**].

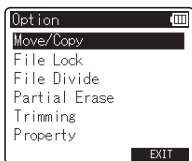

4 Press the **OK** button.

5 Press the **+** or **-** button to select the location to which you want to move or copy the file.

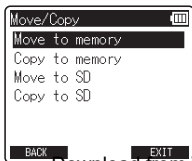

[Move to memory]: Move a file from the internal memory or SD card to another folder within the internal memory.

[Copy to memory]: Copy a file from the internal memory or SD card to another folder within the internal memory.

[Move to SD]: Move a file from the internal memory or SD card to another folder in the SD card.

[Copy to SD]: Copy a file from the internal memory or SD card to another folder in the SD card.

6 Press the **OK** button.

If you entered the [OPTION] screen from the File screen:

- Move or copy the selected file.
Proceed to Step 9.

If you entered the [OPTION] screen from the File list screen:

- Move or copy multiple files.
Proceed to Step 7.

7 Press the **+** or **-** button to select the number of files you want to move or copy.

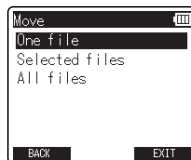

[One file]: Select only the specified file.

[Selected files]: Select multiple files.

[All files]: Select all files in the folder.

8 Press the **OK** button to move to the respective setting.

■ If you selected **[One file]**:

① Press the **+** or **-** button to select the file you want to move or copy.

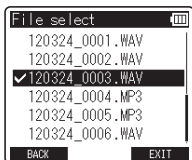

② Press the **OK** button to select the file.

■ If you selected **[Selected files]**:

① Press the **+** or **-** button to select the file(s) you want to move or copy.

② Press the **OK** button to check the file(s) selected.

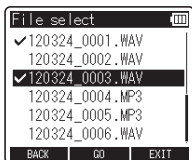

③ Repeat steps ① and ② until all the files you want to move/copy are selected, then press the **F2 (GO)** button.

■ If you selected **[All files]**:

When you select **[All files]**, all the files in the folder are automatically selected and the recorder moves to the **[Destination]** screen.

9 Press the **+** or **-** button to select the folder to which you want to move or copy the file.

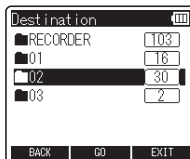

10 Press the **F2 (GO)** button.

- File move or file copy starts if **[Moving!]** or **[Copying!]** appears on the display. During the process, the progress status is shown as a percentage.

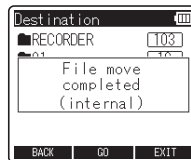
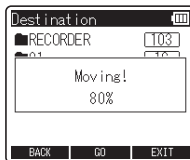

- The process is completed when **[File move completed]** or **[File copy completed]** is displayed.

- 11 Press the **F3 (EXIT)** button to close the [OPTION] screen.

Notes

- The recorder cannot copy when the memory capacity is not sufficient.
- You cannot move or copy files if the number of files in the move destination folder or copy destination folder will exceed 999.
- Do not remove the battery during moving or copying. Doing so may damage the data.
- A file cannot be moved or copied to the same folder.
- When operation is canceled during moving or copying, only the files for which the move or copy process has already been completed are saved at the new location. The move or copy process is canceled for all other files.
- Files which are locked remain so even after they are moved or copied.

Protecting a file [File Lock]

Locking a file keeps important data from being accidentally erased. Locked files are not erased when you select to erase all files from a folder (P.62). You can edit a single selected file or multiple files.

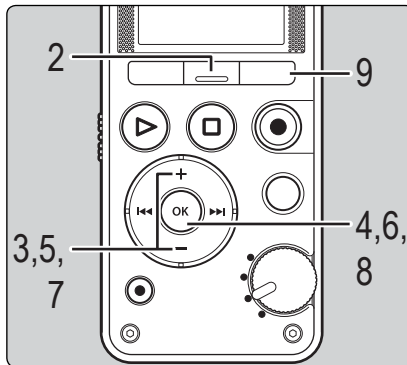

- 1 First, select the file or the folder that contains the file you want to protect (P.25).
- 2 While the recorder is in stop mode, press the **F2 (OPTION)** button.
 - The [OPTION] screen appears on the display.

3 Press the + or – button to select [File Lock].

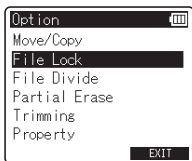

4 Press the OK button.

If you entered the [OPTION] screen from the File screen:

- Protect the selected file. Proceed to Step 7.

If you entered the [OPTION] screen from the File list screen:

- Protect multiple files. Proceed to Step 5.

5 Press the + or – button to select the number of files you want to protect.

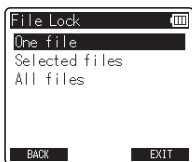

[One file]: Select only the specified file.

[Selected files]: Select multiple files.

[All files]: Select all files in the folder.

6 Press the OK button to move to the respective setting.

■ If you selected [One file]:

① Press the + or – button to select the file you want to protect.

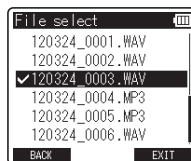

② Press the OK button to select the file.

■ If you selected [Selected files]:

① Press the + or – button to select the files you want to protect.

② Press the OK button to check the files selected.

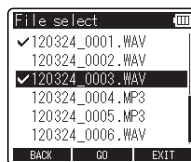

③ Repeat steps ① and ② until all the files you want to protect are selected, then press the **F2 (GO)** button.

■ If you selected [All files]:

When you select [All files], all the files in the folder are automatically selected and the recorder moves to the [Destination] screen.

- 7 Press the + or – button to select [On] or [Off].

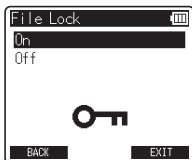

[On]:

Locks the file and prevents it from being erased.

[Off]:

Unlocks the file and allows it to be erased.

- 8 Press the **OK** button to complete the setting.

- Pressing the **F1 (BACK)** button without pressing the **OK** button will cancel the settings and return you to the [OPTION] screen.

- 9 Press the **F3 (EXIT)** button to close the [OPTION] screen.

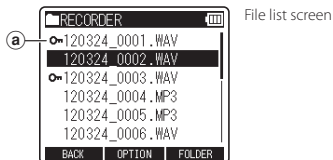

a File Lock

Dividing a file [File Divide]

Files with large capacities and long recording times can be divided so that they are easier to manage and edit.

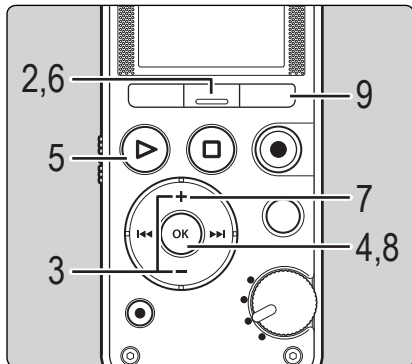

4

Editing [OPTION]



- Only files recorded with this recorder can be divided.
- This function is not available when the File list screen is displayed.

1

Select the file you want to divide.

2

While the recorder is in stop mode, press the **F2 (OPTION)** button.

- The [OPTION] screen appears on the display.

3

Press the + or – button to select [**File Divide**].

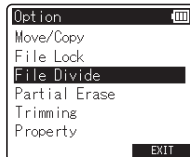

4

Press the **OK** button.

5

Press the **PLAY (▶)** button and play the file to the position where you want to divide it.

- While the recorder is in playback mode, press and hold the **▶▶▶** or **◀◀◀** button to fast-forward or rewind.
- It is useful to mark the divide position in advance by setting an index mark.

6

At the position where you want to divide the file, press the **F2 (DIVIDE)** button.

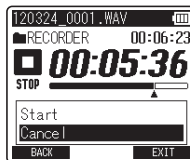

- Pressing the **F1 (BACK)** button without pressing the **OK** button will cancel the settings and return you to the [OPTION] screen.

7 Press the + button to select [Start].

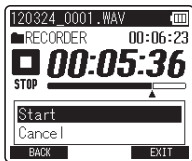

8 Press the OK button.

- [Dividing!] appears and file dividing starts. File dividing is completed when [File divide completed] appears.

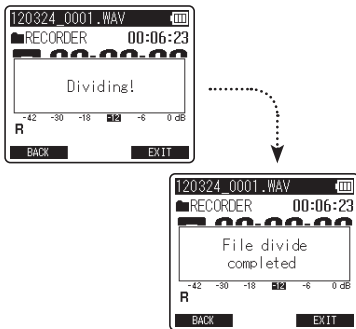

9 Press the F3 (EXIT) button to close the [OPTION] screen.

Notes

- [File Divide] is available only from the File screen.
- The recorder cannot divide files when the number of files in the folder exceeds 999.
- Locked files cannot be divided (P51).
- After the file is split, the front part of the file is renamed [File name_1.mp3] and the latter part of the file is named [File name_2.mp3].
- If a file has an extremely short recording time, it may not be divided even if it is an MP3 file or PCM file.
- Do not remove the battery while dividing a file. Doing so may damage the data.

Partially erasing a file [Partial Erase]

An unwanted part of a file can be erased.

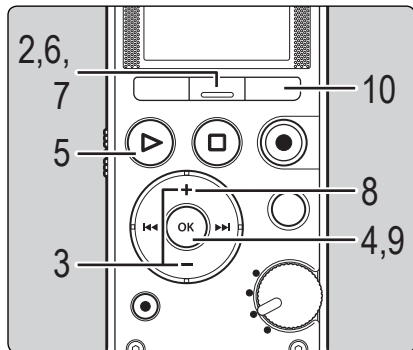

4

Editing [OPTION]



- Only a PCM file recorded with this recorder can be partially erased.
- This function is not available when the File list screen is displayed.

1 Select the file you want to partially erase.

2 While the recorder is in stop mode, press the **F2 (OPTION)** button.

- The [OPTION] screen appears on the display.

3 Press the + or – button to select [Partial Erase].

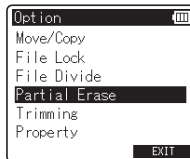

4 Press the OK button.

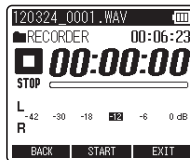

5 Press the **PLAY (▶)** button and play the file to the position where you want to start partial erase.

- Forward the file to the position where you want to start partial erase. If the file is long, use the **▶▶** button to move to the position you want to delete.

6 At the position where you want to start partial erase, press the **F2 (START)** button.

- Playback will continue even after the **F2 (START)** button is pressed. You can rewind or fast-forward as usual to quickly locate the erase end position.

- 7 At the position where you want to end partial erase, press the **F2 (END)** button again.

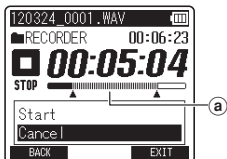

- a This is the part that will be erased.

- 8 Press the **+** button to select **[Start]**.

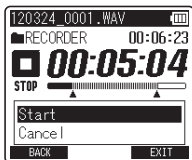

- 9 Press the **OK** button.

- The display will switch to **[Partial erasing !]** and start the partial erase. The deletion is completed when **[Partial erase completed.]** is displayed.

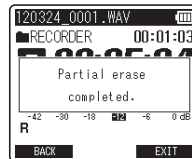
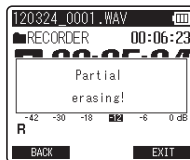

- The recorder stops the beginning of the edited file.

- 10 Press the **F3 (EXIT)** button to close the **[OPTION]** screen.

Trimming a file [Trimming] (LS-14 only)

A file can be trimmed down to just the required portion and then re-saved.

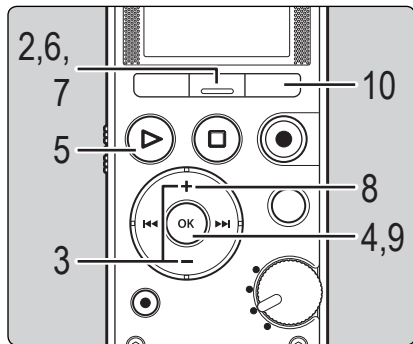

4

Editing [OPTION]



- Only a PCM file recorded with this recorder can be trimmed.
- This function is not available when the File list screen is displayed.

1 Select the file you want to trim.

2 While the recorder is in stop mode, press the **F2 (OPTION)** button.

- The [OPTION] screen appears on the display.

3 Press the + or – button to select [Trimming].

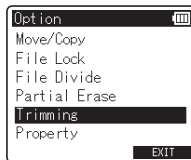

4 Press the OK button.

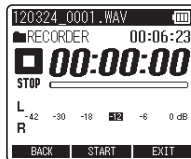

5 Press the **PLAY (▶)** button and play the file to the position where you want to start trimming.

- Forward the file to the position where you want to start trimming. If the file is long, use the ►►► button to move to the position you want to trim.

6 At the position where you want to start trimming, press the **F2 (START)** button.

- Playback will continue even after the **F2 (START)** button is pressed. You can rewind or fast-forward as usual to quickly locate the trimming end position.

- 7 At the position where you want to end trimming, press the F2 (END) button again.

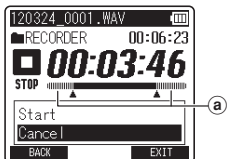

a This is the part that will be erased.

- 8 Press the + button to select [Start].

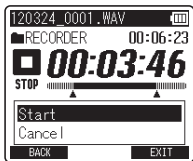

- 9 Press the OK button.

- The display will switch to **[Trimming !]** and start trimming. Trimming is completed when **[Trimming completed.]** is displayed.

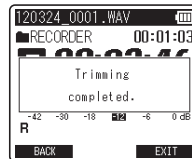
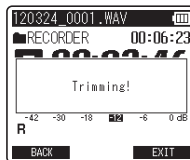

- The recorder stops the beginning of the edited file.

- 10 Press the F3 (EXIT) button to close the [OPTION] screen.

Note

- If a file has an extremely short recording time, it may not be trimmed even if it is a PCM file.

Confirming a file in memory [Property]

File information can be confirmed from the menu screen.

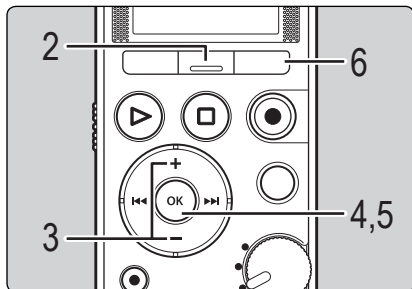

4

Editing [OPTION]

- 1 Select the file for which you want to check information (⏪ P.25).
- 2 While the recorder is in stop mode, press the F2 (OPTION) button.
 - The [OPTION] screen appears on the display.
- 3 Press the + or – button to select [Property].

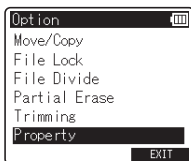

- 4 Press the OK button.

- The [Property] screen appears on the display.

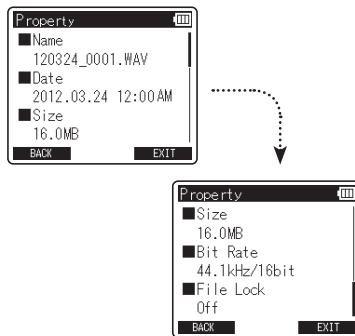

- [Name] (File name), [Date] (Time stamp), [Size] (File size), [Bit Rate]* (File format) and [File Lock] (File protection) appear on the display.
- * When a linear PCM format file has been selected, the [Bit Rate] area displays the sampling frequency and bit rate.

- 5 After checking the information, press the OK button to exit [Property] screen.

- 6 Press the F3 (EXIT) button to close the [OPTION] screen.

Erasing

Erasing a file

A selected file can be erased from a folder.

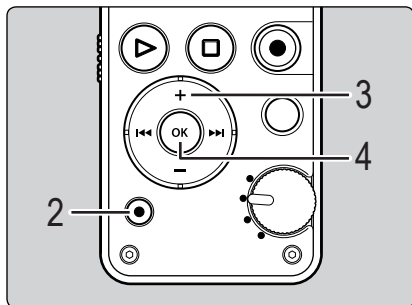

1 Select the file you want to erase (see P.25).

2 While the recorder is in stop mode in the File screen, press the ERASE button.

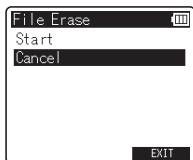

- If an action is not selected within 8 seconds, the recorder returns to stop mode.

3 Press the + button to select [Start].

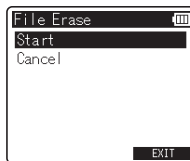

4 Press the OK button.

- The display changes to **[Erasing!]** and erasing starts.
- **[Erased]** is displayed when the file is erased. File numbers are reassigned automatically.

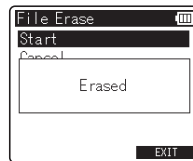
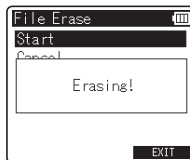

Erasing multiple files at once

4

Erasing

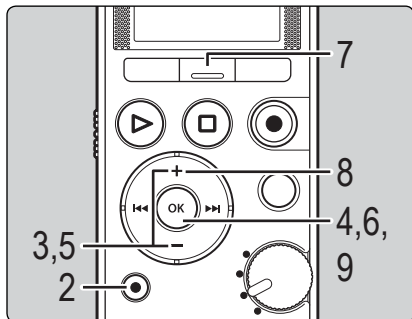

1 Select the folder where the file you want to erase is saved (see P.25).

2 Press the **ERASE** button in the File list screen.



- If an action is not selected within 8 seconds, the recorder returns to stop mode.

3 Press the + or – button to select [**Selected files**] or [**All files**].

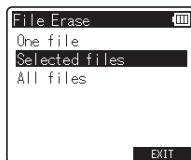

[**Selected files**]: Erase multiple selected files.

[**All files**]: Erase all files in a folder.

4 Press the **OK** button.

- If you selected [**All files**], proceed to Step 8.

5 Press the + or – button to select the file to be erased.

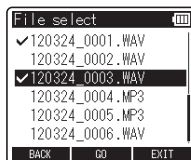

6 Press the **OK** button.

- Repeat steps 5 and 6 to select the files to be erased.

7 Press the **F2 (GO)** button.

8 Press the + button to select [Start].

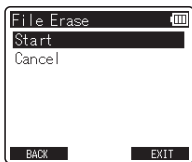

9 Press the OK button.

- The display changes to **[Erasing!]** and erasing starts.
- **[Erased]** is displayed when the file is erased. File numbers are reassigned automatically.

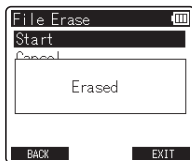
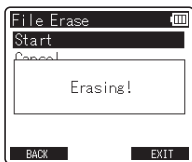

Notes

- You cannot recover a file once it has been erased. Please check carefully before erasing.
- When an SD card is inserted into the recorder, be sure to confirm the recording media as either **[Internal memory]** or **[SD card]** so that there is no mistake (☞ P.23, P.72).
- Locked files and files set as read-only cannot be erased (☞ P.51).
- If the SD card is write-protected, **[SD Card Locked]** will be displayed. If you want to erase a file, please release the card's write protection (☞ P.21).
- If there is a file that cannot be recognized by the recorder, the file will not be erased. Please connect the recorder to your PC to erase the file.
- Replace the battery with a new one in order to ensure that the battery does not go flat during erasing. In addition, it may take over 10 seconds to complete erasing. Never perform operations such as the following during erasing, as such operations may damage the data.
 - ① Disconnect the AC Adapter during erasing.
 - ② Remove the battery during erasing.
 - ③ Remove the SD card during erasing when **[SD card]** is selected as the recording media.
- You cannot delete folders with the recorder.

Menu setting

Menu setting method

Items in menus are categorized by area, so select an area first and move to the desired item to set it. You can set each menu item as follows.

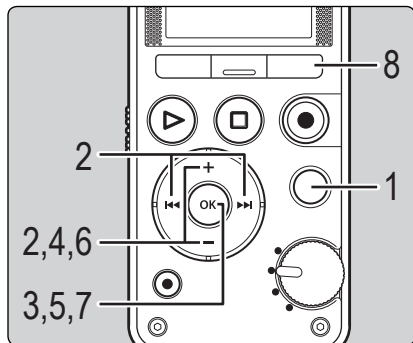

5

Menu setting method

1 While the recorder is in stop mode, press the **MENU** button.

- The menu appears on the display.

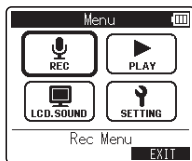

- Menu items can be set during recording or playback.

2 Press the **+**, **-**, **▶▶▶** or **◀◀◀** button to move to the area that contains the item you want to set.

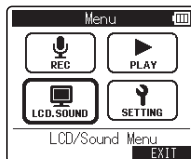

3 Press the **OK** button.

4 Press the **+** or **-** button to move to the item you want to set.



5 Press the **OK** button.

- The display shows the setting of the selected item.

EN

64

Menu setting method

- 6 Press the + or – button to change the setting.

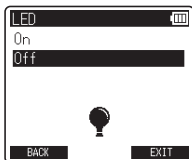

- 7 Press the OK button to complete the setting process.



- A message appears on the screen to inform you that the setting has been entered.
- Pressing the **F1 (BACK)** button without pressing the **OK** button cancels the setting process and returns you to the previous screen.

- 8 Press the **F3 (EXIT)** button to close the menu screen.

- If the menu screen is open during recording or playback, pressing the **F3 (EXIT)** button allows you to return to the recording or playback screen without interrupting recording or playback.

Notes

- The recorder stops if you leave it idle for 3 minutes during a menu setup operation and do not set a selected item.
- When menu settings are entered during recording or playback, the menu settings are canceled if 8 seconds elapse with no buttons being pressed.

Setting menu during recording

Function	Setting
[Mic Gain]	
[Low Cut Filter]	
[Plug-in Power]	To menu item options
[Rec Monitor]	

Setting menu during playback

Function	Setting
[Play Mode]	
[Skip Space]	To menu item options

Menu setting method

Rec Menu

Mic Gain

Recording sensitivity is adjustable to meet recording needs.

[Hi]:

Suitable for recording meetings and seminars with a small number of people.

[Mid]:

Suitable for recording musical performances.

[Lo]:

Suitable for recording loud musical performances.

- This function is enabled when the Mode dial is switched to **[QUICK]**. When the Mode dial is switched to **[SMART]*** or **[MANUAL]**, adjust the recording level via the correction function (☞ P.31).
- To confirm the setting, press and hold the **F3 (INFO)** button at the **[Home]** screen (☞ P.23).
 - * In **[SMART]** mode, you can adjust the recording level after setting the time for **[Smart Time]** (☞ P.68).

Limiter

Switch to the automatic adjustment function according to the input level during recording.

[Music]:

Select this setting for clarity of sound volume. This setting is suitable for music recordings.

[Voice]:

Select this setting to equalize the sound volume. The sound can be recorded at a predetermined volume to produce equalized recordings. This setting is suitable for voice recordings.

[Off]:

Use this position when adjusting the input levels without using the correction function.

- This function is enabled when the Mode dial is switched to **[SMART]** or **[MANUAL]** (☞ P.29, P.30).
- If the sound input is too loud, noise may occur even if you set **[Limiter]** to **[Music]** or **[Voice]**. Also, in certain cases the **PEAK** indicator light, which indicates loud input, may not light. To ensure successful recording, we recommend that you test the record function and volume before use.
- To confirm the setting, press and hold the **F3 (INFO)** button at the **[Home]** screen (☞ P.23).

Rec Format

This setting corresponds to the linear PCM format that can record sound at a sound quality that is better than CDs and to the MP3 format that can record by highly compressing the file.

1

Select the recording format.

[PCM]: This is an uncompressed audio format which is used for music CDs etc.

[MP3]: This is a common sound compression mode. File sizes in this format are smaller than in the PCM format.

Menu setting method

2 Select the recording rate.

When [PCM]*1 is selected:

[96.0 kHz/24 bit] to [44.1 kHz(mono)]*2

When [MP3] is selected:

[320 kbps] to [64 kbps(mono)]*2

*1 Files saved in the PCM (WAV) format correspond to BWF (Broadcast Wave Format), and the date and time that each file is recorded is added to the file.

*2 Monaural recording.

- For clear recording of musical performances or choirs, set [Rec Format] to any value other than [mono] before starting recording.
- When an external monaural microphone is used while [Rec Format] is set to a stereo recording mode, audio is recorded to the L channel only.
- To confirm the setting, press and hold the **F3 (INFO)** button at the [Home] screen (☞ P.23).

Low Cut Filter

The recorder has a Low Cut Filter function to minimize low-frequency sounds and record voices more clearly. This function can reduce noise from air conditioners and projectors and other similar noises.

[300Hz]:

Use this setting when sufficient noise reduction cannot be obtained with the [100Hz] setting.

[100Hz]:

This setting will reduce the noise generated from air conditioners and projectors. It is effective for indoor recording.

[Off]:

Disables the Low Cut Filter function.

- To confirm the setting, press and hold the **F3 (INFO)** button at the [Home] screen (☞ P.23).

Plug-in Power

External microphones supported by plug-in power can also be used. You can configure the recorder according to whether or not you want to supply power to external microphones.

[On]:

When the plug-in power function is activated, power will be supplied to any connected external microphone. Select this option when external microphones to be supported by plug-in power are connected (☞ P.94).

[Off]:

Disables this function. Select this option when external microphones that you do not want to support with plug-in power are connected.

- Turn the plug-in power function to [Off] when an external microphone that does not need to be supported by plug-in power is connected, as there is a risk that noise may be generated while recording.

Mic Select (LS-14 only)

Select whether or not the built-in center microphone is to be turned On or Off.

[Central Mic ON]:

Recording will be performed in 3-microphone mode.

[Central Mic OFF]:

Recording will be performed using only the built-in stereo microphones.

- To confirm the setting, press and hold the **F3 (INFO)** button at the [Home] screen (☞ P.23).

Menu setting method

Pre-Recording

Pre-recording enables you to record up to 2 seconds* of sound before you actually press the recording button. This function allows you, for example, to start recording birdsong up to 2 seconds* before the bird starts singing even if you press the recording button at the moment the bird starts singing.

[On]: For recording sound up to 2 seconds* before the recording button is pressed.

[Off]: For normal recording start.

* Recording start time will vary according to

[Rec Format] settings.

- To confirm the setting, press and hold the **F3 (INFO)** button at the **[Home]** screen (☞ P.23).

How to enable pre-recording

To enable pre-recording, set **[Pre-Recording]** to **[On]**.



This function is enabled when the Mode dial is switched to **[MANUAL]**.

1 While the recorder is in stop mode, press the REC (●) button.

- The recorder enters recording pause mode. However, it constantly records ambient sound and holds up to 2 seconds of data, which is refreshed every second.

2 Press the REC (●) button.

- The recorded data will include up to 2 seconds of sound recorded before the **REC (●)** button was pressed.

- When the **[Pre-Recording]** function is used, the following functions cannot be used.

• **[OVER DUB]** (☞ P.25)

Rec Monitor

Select whether or not to output audio while recording from the earphone jack (EAR).

[On]: Enables the recording monitor function. Sound will be output from the **EAR** jack.

[Off]: Disables this function. Sound will not be output from the **EAR** jack.

- If the external speaker is connected while recording, there is a risk that audio feedback will occur. It is recommended that you use earphones to monitor recording, or turn **[Rec Monitor]** to **[Off]** while recording.

Smart Time

Set the automatic adjustment time to be used in **[SMART]** mode.

[10 sec.] [30 sec.] [1 min.]: Set the time for automatic adjustment.

[Endless]: Automatic adjustment will continue until you skip it.

Metronome

The metronome is a useful rhythm guide and can be used during recording. You can also set it while recording is paused. The metronome sound is not output from the speaker.

1 Select the metronome options.

[Tempo]: Set the metronome's tempo.

[Sound]: Set the metronome's sound.

[Beat]: Set the metronome's pattern.

[Volume]: Set the metronome's volume.

Menu setting method

2 Change the settings.

When **[Tempo]** is selected:

Set a Tempo speed between **[40]** and **[250]**.

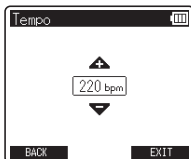

When **[Sound]** is selected:

Set **[Metronome 1]** or **[Metronome 2]** as the sound type.

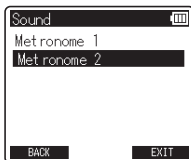

When **[Beat]** is selected:

Set a rhythm pattern between **[0]** and **[9]**.



When **[Volume]** is selected:

Set the volume between **[Volume 1]** and **[Volume 5]**.

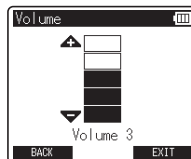

- To use the Metronome function, press the **F1 (METRONOME)** button during recording or while recording is paused (☞ P.36).
- The sound of the metronome will be output from the **EAR** jack. Connect earphones when using the metronome.
- The sound of the metronome will not be recorded.
- When **[Rec Monitor]** is set to **[Off]**, no metronome sound is output (☞ P.68).

■ Tempo terms and guide to tempo range

LARGO	Widely and slowly	♩=40 to 59
LARGHETTO	A little more slowly	♩=60 to 65
ADAGIO	Slowly	♩=66 to 75
ANDANTE	Walking tempo	♩=76 to 107
MODERATO	Moderately	♩=108 to 119
ALLEGRO	Rapidly	♩=120 to 167
PRESTO	Very fast	♩=168 to 200
PRESTISSIMO	Very very fast	♩=201 to 250

Menu setting method

▶ Play Menu

Play Mode

You can select the playback mode that best suits the type of audio.

Select the desired playback range

1 Select **[Play Area]**.

2 Select **[File]** or **[Folder]**.

[File]: Stop after playing back the current file.

[Folder]: Continuously play files in the current folder until the last file and then stop.

Select the desired playback mode

1 Select **[Repeat]**.

2 Select **[On]** or **[Off]**.

[On]: Sets the playback range to be played back repeatedly.

[Off]: Disables the playback mode function.

- In **[File]** mode, when the recorder comes to the end of the last file in the folder, **[End]** flashes for two seconds on the display and the recorder stops at the start of the last file.
- In **[Folder]** mode, when the recorder comes to the end of the last file in the folder, **[End]** flashes for two seconds on the display and the recorder stops at the start of the first file in the folder.
- To confirm the setting, press and hold the **F3 (INFO)** button at the **[Home]** screen (P.23).

Skip Space

This function enables you to skip (forward) or reverse skip (rewind) a small portion of the file being played. This function is convenient for quickly skipping to another playback position or repeatedly playing back short phrases.

1 Select **[Forward Skip]** or **[Reverse Skip]**.

2 Set the skip space.

When **[Forward Skip]** is selected:

[File Skip] [10 sec.] [30 sec.] [1 min.]
[5 min.] [10 min.]

When **[Reverse Skip]** is selected:

[File Skip] [5 sec.] [10 sec.] [30 sec.]
[1 min.] [5 min.]

Menu setting method

Forward/Reverse Skip Playback

- 1 Press the **PLAY** (▶) button to start playback.
- 2 Press the **▶▶** or **◀◀** button.
 - The recorder skips (forward) or reverse skips (rewind) a set space and starts playing back.
 - If there is an index mark/temp mark or a cue closer than the skip space, the recorder forward skips/ reverse skips to that position.

LCD/Sound Menu

Backlight

The display will remain lit for about 10 (Initial setting) seconds when a button on the recorder is pressed.

[5 sec.] [10 sec.] [30 sec.] [1 min.]:

Enables the Backlight function.

[Off]:

Disables the Backlight function.

Contrast

Display contrast can be adjusted in 12 levels.

- You can adjust the LCD display contrast level from **[01]** to **[12]**.

LED

You can set the recorder so the LED indicator light does not turn on.

[On]:

Enables the LED light function.

[Off]:

Disables the LED light function.

Menu setting method

Beep

The recorder beeps to alert you to button operations or warn you of errors. System sounds may be turned off.

[Volume 3]:

Increase the volume of beeps.

[Volume 2]:

Set beeps to the normal volume.

[Volume 1]:

Decrease the volume of beeps.

[Off]:

Disables the Beep function.

Language(Lang)

You can select the display language for this recorder.

[English] [Français] [Español]:

- The selectable languages differ depending on the region.

Voice Guide (LS-14 only)

This feature gives audio announcements of recorder operating conditions.

See "**Guidance [Voice Guide]**" (☞ P.74).

Device Menu

Memory Select

When an SD card is inserted, you can select to record to either the internal memory or to the SD card (☞ P.20).

[Internal memory]: Internal memory.

[SD card]: SD card.

- To confirm the recording media, press and hold the **F3 (INFO)** button at the **[Home]** screen (☞ P.23).

Power Save

If the recorder remains in stop mode for over 10 minutes (Initial setting) while the power is turned on, the recorder enters sleep mode.

[5 min.] [10 min.] [30 min.] [1 hr.]:

Set the length of time that is to elapse before the recorder enters sleep mode.

[Off]: Disables the Power Save function.

- If any button is pressed, the elapsed time count starts over again.

Time & Date

Setting the time and date beforehand enables easier file management.

See "**Changing the time and date [Time & Date]**" (☞ P.75).

Menu setting method

USB Settings

You can switch the USB class according to your usage.

See “**Changing the USB class [USB Settings]**”

(P.76).

Reset Settings

This function returns all other functions to their initial settings (factory default).

[Start]: Returns the settings to their initial values.

[Cancel]: Takes you back to **[Device Menu]**.

- After the settings have been returned to their initial values, the time settings and file numbers are preserved, without being returned to their initial settings.

Menu settings after resetting (initial settings)

Rec Menu:

[Mic Gain]	[Mid]
[Limiter]	[Off]
[Rec Format]	
[PCM]	[44.1kHz/16bit]
[Low Cut Filter]	[Off]
[Plug-in Power]	[On]
[Mic Select]*	[Central Mic On]
[Pre-Recording]	[Off]
[Rec Monitor]	[On]
[Smart Time]	[30 sec.]
[Metronome]	
[Temp]	[120]
[Sound]	[Metronome 1]
[Beat]	[0]
[Volume]	[Volume 3]

Play Menu:

[Play Mode]	
[Play Area]	[File]
[Repeat]	[Off]
[Skip Space]	
[Forward Skip]	[File Skip]
[Reverse Skip]	[File Skip]

LCD/Sound Menu:

[Backlight]	[10 sec.]
[Contrast]	[Level 06]
[LED]	[On]
[Beep]	[Volume 2]
[Language(Lang)]	[English]
[Voice Guide]*	
[On/Off]	[On]
[Speed]	[Speed 3]
[Volume]	[Volume 3]

Device Menu:

[Memory Select]	[Internal memory]
[Power Save]	[10 min.]
[USB Settings]	
[USB Connection]	[PC]
[USB Class]	[Storage]

* LS-14 only.

Format

When the recorder is formatted, all the saved data, including locked files and read-only files, are erased.

See “**Formatting the recorder [Format]**” (P.78).

Memory Info.

The recordable capacity remaining and overall capacity of the recording media can be seen from the menu.

- The recorder uses some of its memory capacity to maintain a management file. The indicated remaining capacity is less than the total capacity of the media due to its characteristic. This is not a malfunction.

System Info.

You can check information about the recorder on the menu screen. **[Model]** (Model Name), **[Version]** (System version) and **[Serial No.]** (Serial Number) appear on the display.

Menu setting method

Guidance [Voice Guide] (LS-14 only)

This feature gives audio announcements of recorder operating conditions. Adjust the speed and the volume of guidance announcements.

1 Select [Voice Guide] from the menu on the [LCD/Sound Menu].

- For details on how to enter the menu settings, see "Menu setting method" (☞ P.64).

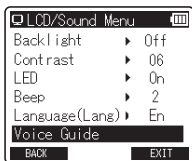

2 Press the + or – button to select the item you want to set.

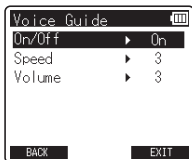

- Select items you want to set from among [On/Off], [Speed] and [Volume].

3 Press the OK button to move to the respective setting.

■ [On/Off] setting:

- Press the + or – button to select between [On] and [Off].
[On]: Guidance will be provided.
[Off]: Guidance will be canceled.
- Press the OK button to exit [On/Off] selection.

■ [Speed] setting:

- Press the + or – button to select from [Speed 5], [Speed 4], [Speed 3], [Speed 2], and [Speed 1].
- Press the OK button to exit [Speed] selection.

■ [Volume] setting:

- Press the + or – button to select from [Volume 5], [Volume 4], [Volume 3], [Volume 2], and [Volume 1].
- Press the OK button to exit [Volume] selection.

4 Press the F3 (EXIT) button to close the menu screen.

Notes

- The starting tune/closing tune when the power is turned On/Off (☞ P.16) can be canceled by setting the guidance to [Off].
- Set the volume of the starting tune/closing tune in the guidance [Volume] setting.
- The [Speed] setting in the [Voice Guide] settings is disabled during file playback.

Changing the time and date [Time & Date]

If the current time and date are not correct, set them using the procedure below.

1 Select [Time & Date] from the menu on the [Device Menu].

- For details on how to enter the menu settings, see "Menu setting method" (P.64).
- "Hour" flashes on the display, indicating the start of the Time and Date setup process.

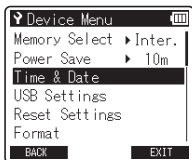

2 Press the ►► or ◀◀ button to select the item you want to set.

- Select "Hour", "Minute", "Year", "Month" or "Day" by moving the flashing position.

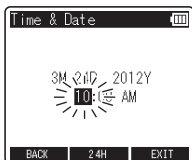

3 Press the + or – button to change the value.

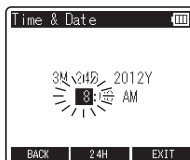

- Follow the same steps by pressing the ►► or ◀◀ button to select the next item, and pressing the + or – button to change the value.

4 Press the OK button to complete the setting.

- The clock will start from the set date and time. Press the OK button when you want the clock to start.

5 Press the F3 (EXIT) button to close the menu screen.

Changing the USB class [USB Settings]

You can select [PC] to connect the recorder to a PC to send and receive files, or [AC adapter] to connect it to the AC adapter (A514) (sold separately). It is also possible to switch the USB class between [Composite] and [Storage] to suit your usage.

1 Select [USB Settings] from the menu on the [Device Menu].

- For details on how to enter the menu settings, see "Menu setting method" (P.64).

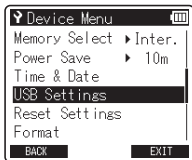

2 Press the + or – button to select [USB Connection] or [USB Class].

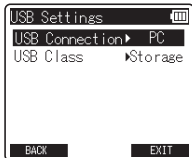

[USB Connection]:
Setting for connecting to a PC.

[USB Class]:
Setting for USB class.

3 Press the OK button.

4 Press the + or – button to change the setting.

■ When [USB Connection] is selected:

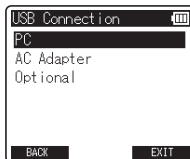

[PC]:
Setting for when the recorder is connected to a PC and used as a storage device or composite device. Connected as storage or composite.

[AC Adapter]:
This setting is available only when the recorder receives power from the USB or the AC adapter (A514) (Sold separately).

[Optional]:
Setting to confirm the connection method each time a USB connection is made.

Menu setting method

■ When [USB Class] is selected:

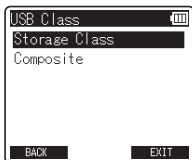

[Storage Class]:

Recognized by a PC as an external memory device.

[Composite]:

Setting when connected to a PC and used as an external memory device, USB speaker or microphone.

5 Press the **OK** button to complete the setting.

6 Press the **F3 (EXIT)** button to close the menu screen.

Notes

- When you first connect the recorder to your PC as an external storage device, the driver for the recorder will be automatically installed in your PC.
- The PC cannot recognize that the recorder is connected to the PC if [USB Connection] is set to [AC Adapter].
- If the recorder is not recognized by the PC as an external storage device, change the [USB Class] setting to [Storage Class].

Menu setting method

Formatting the recorder [Format]

If you format the recorder, all files will be erased and all function settings will return to the defaults except the date and time settings. Transfer any important files to a computer before formatting the recorder.

1 Select **[Format]** from the menu on the **[Device Menu]**.

- For details on how to enter the menu settings, see "Menu setting method" (P.64).

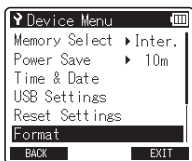

2 Press the + or – button to select the recording media to format.

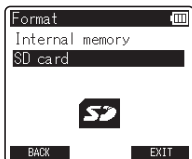

3 Press the **OK** button.

4 Press the + button to select **[Start]**.

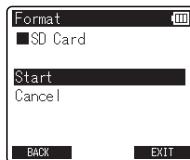

5 Press the **OK** button.

- After the **[All data will be erased]** message displays for two seconds, **[Start]** and **[Cancel]** appear.

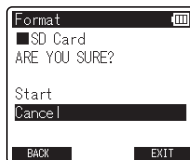

6 Press the + button again to select **[Start]**.

7

Press the OK button.

- Formatting begins and **[Formatting!]** flashes on the display.
- **[Format done]** appears when formatting ends.

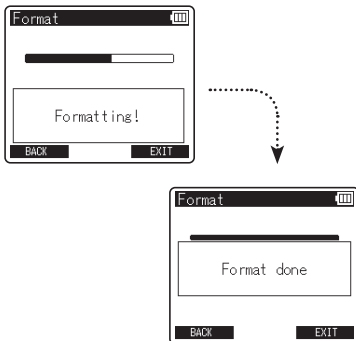

Notes

- Never format the recorder from a PC.
- When the recorder is formatted, all the saved data, including locked files and read-only files, is erased.
- To restore the function's settings to their initial values, use **[Reset Settings]** (☞ P.73).
- If the SD card is write-protected, **[SD Card Locked]** will be displayed. If you want to format the card, release the card's write protection (☞ P.21).
- When an SD card is inserted into the recorder, be sure to confirm the recording media as either **[Internal memory]** or **[SD card]** so that there is no mistake (☞ P.23, P.72).
- Replace the battery with a new one in order to ensure that the battery does not go flat during formatting. In addition, it may take over 10 seconds to complete formatting. Never perform operations such as the following during formatting, as such operations may damage the data.
 - ① Disconnect the AC Adapter during formatting.
 - ② Remove the battery during formatting.
 - ③ Remove the SD card during formatting when **[SD card]** is selected as the recording media.
- Formatting on the recorder is Quick Format. If you format the SD card, file management information is refreshed and the data inside the SD card is not deleted completely. When giving someone or disposing of the SD card, be careful of data leakage from the SD card. We recommend that the SD card be destroyed when you dispose of it.

About the tuner

Using the tuning function

You can use the recorder's chromatic tuning function to tune musical instruments. The difference between the reference tone and the input sound is measured and displayed on screen.

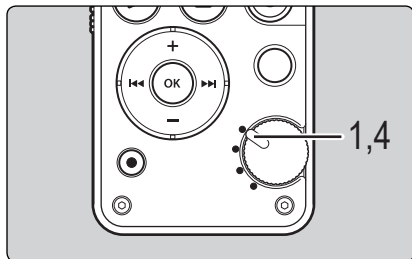

6

Using the tuning function

- 1 Switch the Mode dial to the [Ψ] position.



- 2 Tune the musical instrument by playing a single note.

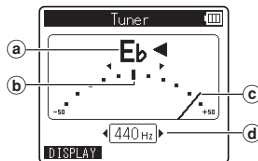

- a The name of the note closest to the entered sound
 - b Target position indicated by the reference tone
 - c Tuning meter
 - d Calibration value
- The name of the note closest to the recognized sound appears.
 - Press the **F1 (DISPLAY)** button to switch the type of visualization between the waveform type and the meter type.
 - Waveform type is useful for the practice of wind instruments because it shows the tone interval visually.

EN

80

Using the tuning function

- 3 Adjust while looking at the tuning meter and the indicators.

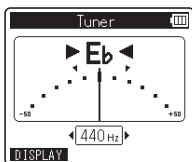

- Tune accurately with the needle pointing to the center of the meter.
- The LED indicator lights will turn on as the instrument becomes tuned. When the instrument is in tune, the bar will be at the center of the meter, and the left and right LED indicator lights will turn on simultaneously. The lights enable you to tune an instrument even when the display is in difficult lighting conditions.
- To change the calibration reference value, press the ►► or ◀◀ button to select the frequency. The frequency of the reference tone A can be adjusted by 1 Hz increments in the range of 435 Hz to 445 Hz.

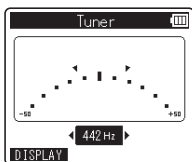

- 4 Switch the Mode dial to a position other than [Ψ] to exit the tuning mode.

Using the recorder on your PC

When connected to a PC, the recorder enables you to do the following:

- You can transfer files from a computer and play them back.
- This recorder is compatible with MP3 and WAV files.
- This recorder can also be used as external memory for a computer by storing data from a computer and reading it back out (** P.88).

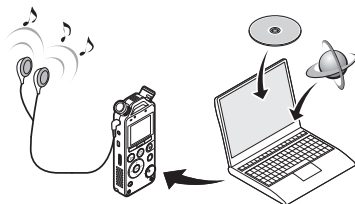

Operating environment

7

Windows

Operating System:

Microsoft Windows XP/Vista/7/8 (Standard Installation)

Compatible PC's:

Windows PC's equipped with more than one free USB port

Macintosh

Operating System:

Mac OS X 10.4.11 - 10.8 (Standard Installation)

Compatible PC's:

Apple Macintosh series equipped with more than one free USB port

Operating environment

Notes

- This is the operating environment required for saving files recorded by this recorder to your PC via the USB connection.
- The support service does not cover you if your PC has been updated from Windows 95/98/Me/2000 to Windows XP/Vista/7/8.
- Any failure on a self-modified PC will not be covered under the operational warranty.

Download from www.Somanuals.com. All Manuals Search And Download.

EN

82

Precautions on using the recorder connected to a PC

- When you are downloading a file from the recorder or uploading a file to the recorder, do not remove the USB cable even if the screen is indicating you can. Data is still being transferred while the **PEAK** indicator light is blinking. When removing the USB cable, be sure to follow the description in **☞** P.85. If the USB cable is removed before the drive is stopped, data may not be successfully transferred.
- On a PC, do not format the drive of the recorder. Initialization is not successfully achieved on a PC. For initialization, follow the instructions in the **[Format]** screen of the recorder (**☞** P.78).
- If folders or files stored on the recorder are moved or renamed by using a file management tool in Windows or Macintosh, the order of files may change or files may become unrecognizable.
- Data can be written or uploaded to the recorder even though the attribute of the recorder drive is shown as Read-only by the operating system of the PC.
- As noise may cause adverse effects on electronics devices near the recorder, unplug the external microphone and earphones when you connect the recorder to a PC.

Connecting to your PC

- 1 Boot the PC.
- 2 Connect the USB cable to the USB port of the PC.

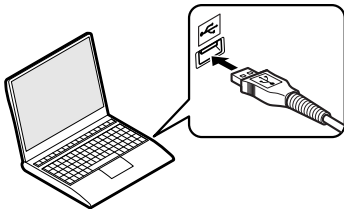

- 3 While the recorder is in stop mode or turned off, connect the USB cable to the connecting terminal of the recorder.

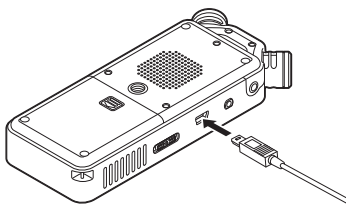

- **[Remote (Storage)]** is displayed on the recorder if the USB connector is connected.
- The recorder does not establish a connection with a PC if **[AC Adapter]** is selected in the USB connection setting. Select **[PC]** in the USB connection setting (P.76).

Windows:

When you connect the recorder to Windows and open **[My Computer]**, it is recognized by the drive name of the product.

Inserting an SD card will allow you to use it as **[Removable Disk]**.

Macintosh:

When you connect the recorder to Mac OS, it is recognized by the drive name of the product on the desktop. If an SD card is inserted, **[Untitled]** is displayed.

Notes

- Refer to the user's manual for your PC regarding the USB port on your PC.
- Be sure to push the cable connector all the way in. Otherwise, the recorder may not operate properly.
- When the recorder is connected through a USB hub, operation may become unstable. In such cases, refrain from using a USB hub.
- Use the dedicated USB cable. If any other company's cable is used, it may lead to malfunction of the recorder. Also, never use this dedicated cable with any other company's products.

Disconnecting from your PC

Windows

- 1 Click  on the task bar located at the lower-right corner of the screen. Click [**Safely remove USB Mass Storage Device**].



- The drive letter will differ depending on the PC being used.
- When the window indicating that it is safe to remove hardware appears, close the window.

- 2 Confirm that the recorder **PEAK** indicator light has turned off before disconnecting the USB cable.

Macintosh

- 1 Drag and drop the recorder's drive icon on the desktop to the Recycle Bin icon.

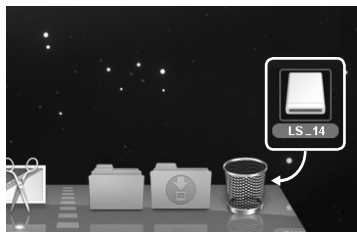

- 2 Confirm that the recorder **PEAK** indicator light has turned off before disconnecting the USB cable.

Note

- NEVER disconnect the USB cable while the **PEAK** indicator light is flashing. If you do, the data may be destroyed.

Download from www.Somanuals.com. All Manuals Search And Download.

Transferring voice files to your PC

The four folders on this recorder will be displayed as **[RECORDER]**, **[01]**, **[02]** and **[03]** when connecting the recorder to a PC. Copy them to the folder of your choice on your PC.

Windows

- 1 Connect the recorder to your PC (P.84).
- 2 Open the Explorer window.
 - When you connect the recorder to Windows and open **[My Computer]**, it is recognized by the drive name of the product. If you insert an SD card, it is recognized as **[Removable Disk]**.
- 3 Open the product name folder.
- 4 Copy the data.
- 5 Disconnect the recorder from the PC (P.85).

Macintosh

- 1 Connect the recorder to your PC (P.84).
 - When you connect the recorder to Mac OS, it is recognized by the drive name of the product on the desktop. If an SD card is inserted, **[Untitled]** is displayed.
- 2 Double-click the product name icon on the desktop.
- 3 Copy the data.
- 4 Disconnect the recorder from the PC (P.85).

Note

- While data is being transmitted, **[Busy]** is displayed and the **PEAK** indicator light flashes. NEVER disconnect the USB cable while the **PEAK** indicator light is flashing. If you do, the data may be destroyed.

Transferring voice files to your PC

Drive names and folder names when a PC is connected

Internal memory

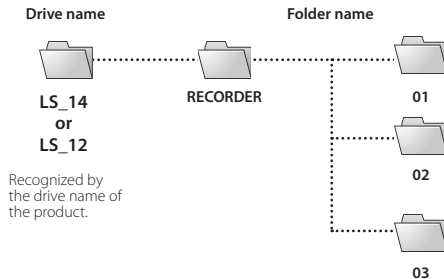

SD card

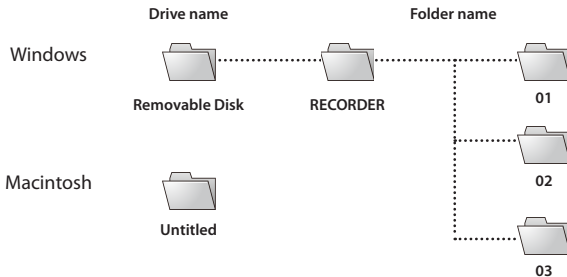

Usage as external memory of your PC

With the recorder connected to your PC, you can download data from the memory to your PC and upload data stored on your PC to the memory.

Windows

- 1 Connect the recorder to your PC (P.84).
- 2 Open the Explorer window.
 - When you open **[My Computer]**, the recorder is recognized by the drive name of the product.
- 3 Open the product name folder.
- 4 Copy the data.
- 5 Disconnect the recorder from the PC (P.85).

Macintosh

- 1 Connect the recorder to your PC (P.84).
 - When you connect the recorder to Mac OS, it is recognized by the drive name of the product on the desktop.
- 2 Double-click the product name icon on the desktop.
- 3 Copy the data.
- 4 Disconnect the recorder from the PC (P.85).

7

Usage as external memory of your PC

EN

Note

- While data is being transmitted, **[Busy]** is displayed and the **PEAK** indicator light flashes. NEVER disconnect the USB cable while the **PEAK** indicator light is flashing. If you do, your data may be damaged.

88

Other information

Alarm message list

Message	Meaning	Explanation	Action
[Battery low]	Low battery power.	Battery power is getting low.	Replace with new batteries (☞ P.15).
[File locked]	Erase-locked.	Tried to delete a locked file.	Unlock the file (☞ P.51).
[No more can be set]	Index full.	The file is full of index marks (maximum of 99 marks).	Erase unnecessary index marks (☞ P.45).
	Temp mark full.	The file is full of temp marks (maximum of 99 marks).	Erase unnecessary temp marks (☞ P.45).
[Folder full]	Folder full.	The folder is full of files (maximum of 999 files).	Move files to a different folder or delete unnecessary files (☞ P.48, P.61).
[Memory error]	Error in the memory.	Error in the memory.	This is a malfunction, so go to the store where you purchased the recorder or an Olympus service station for repair (☞ P.99).
[Card error]	Error in the memory.	SD card is not recognized correctly.	Remove the SD card and insert it again (☞ P.20).
[Illegally copied file]	Illegally copied file.	—————	Erase the file (☞ P.61).
[Memory full]	Zero remaining memory.	No remaining memory.	Erase unnecessary files (☞ P.61).
[SD Card Locked]	Card Locked.	The SD Card is write protected.	Release the SD card's write protection and then try again (☞ P.21).
[No file]	No file.	No files were found in the folder.	Select another folder (☞ P.25).
[Format error]	Formatting error.	There was an error while formatting the recorder's memory.	Reformat the memory (☞ P.78).

Alarm message list

Message	Meaning	Explanation	Action
[Can't create the system file. Connect to PC and erase unnecessary file]	The management file cannot be created.	The file for management cannot be created due to a shortage of remaining memory.	Connect the recorder to a computer and delete unnecessary files.
[Cannot play this file]	File cannot be played.	Incompatible format.	Confirm which files can be played on this recorder (P.43).
[Select a file]	Unselected File.	File is not selected.	Please select a file then carry out the operation (P.25).
[Same folder. Can't be moved (copied)]	Folder cannot be moved (copied).	Attempting to move (copy) into the same folder.	Select another folder.
[Some files can't be moved (copied)]	File cannot be moved (copied).	Attempting to move (copy) a file to destination folder in which a file with the same file name exists.	Select another file.
[This file can't be divided]	File cannot be split.	Attempting to split a file other than an MP3 or PCM file recorded by this recorder.	Select another file.

Troubleshooting

Symptom	Probable cause	Action
Nothing appears on the display	The battery is not loaded properly.	Verify that the battery polarities ⊕ and ⊖ are correct (☞ P.15).
	Battery power is getting low.	Replace with new batteries (☞ P.15).
	The power is off.	Turn the power on (☞ P.16).
Won't start	Battery power is getting low.	Replace with new batteries (☞ P.15).
	The power is off.	Turn the power on (☞ P.16).
	The recorder is in HOLD mode.	Release the recorder from HOLD (☞ P.17).
Unable to record	Low remaining memory.	Erase unnecessary files (☞ P.61).
	The maximum number of files has been reached.	Move files to a different folder or delete unnecessary files (☞ P.48, P.61).
Unable to record through the external microphone	An external device is connected to the LINE IN jack.	Disconnect the connecting cord from the recorder.
	An external microphone that must be supported by plug-in power is connected but [Plug-in Power] is set to [Off] .	Set [Plug-in Power] to [On] when an external microphone that must be supported by plug-in power is connected (☞ P.67).
No playback sound heard	The earphones are connected.	Unplug the earphones to use the built-in speaker.
	The volume level is set to [00] .	Adjust the volume level (☞ P.40).
Recording level too low	The recording level has not been adjusted.	Adjust the recording level and then try recording once more! (☞ P.31).
	The recording sensitivity is too low.	Set [Mic Gain] to [HI] or [Mid] (☞ P.66).
	This could potentially be because the output level for the connected external devices is too low.	Adjust the output level for the connected devices.

Troubleshooting

Symptom	Probable cause	Action
Recording level too high	The recording level has not been adjusted.	Adjust the recording level and then try recording once more (☞ P.31).
	This could potentially be because the recording level and output level for connected external devices is too high.	If you cannot record clearly even after adjusting the recording level, then adjust the output level for the connected devices (☞ P.31).
Voice files are not recorded in stereo	The connected external microphone is monaural.	When an external monaural microphone is connected for recording audio, audio is recorded to the L channel only.
	[Rec Format] is set to a monaural recording mode.	Set [Rec Format] to the stereo recording mode (☞ P.66).
Cannot find the recorded Voice File	Wrong folder.	Switch to the correct folder (☞ P.25).
Noise heard during playback	The recorder was shaken during recording.	—————
	The recorder was placed near a cell phone or fluorescent lamp while recording or during playback.	Move the recorder.
	The settings of the connected external microphone do not correspond to those of the recorder.	When a microphone that does not need to be supported by the plug-in power function is connected, turn the [Plug-in Power] setting to [Off] (☞ P.67).
Unable to hear any sound from the earphone through the recording monitor	[Rec Monitor] is set to [Off].	Set [Rec Monitor] to [On] (☞ P.68).
Unable to erase the file	The file is locked.	Unlock the file (☞ P.51).
	The file is read-only.	Unlock the file or cancel the file's read-only setting on the PC.

Troubleshooting

Symptom	Probable cause	Action
Noise is audible through the recording monitor	Acoustic feedback is occurring.	If the built-in speaker amps are used to monitor recording, there is a risk that audio feedback will occur while recording. It is recommended that you use earphones to monitor recording, or turn [Rec Monitor] to [Off] before starting recording (☞ P.68).
		Make adjustments, such as further distancing the earphones from the microphones, not pointing the microphones at the earphones, or lowering the volume of the recording monitor.
Cannot record using overdubbing	The chosen playback file is not a [PCM 44.1kHz/16bit] format file.	Choose a [PCM 44.1kHz/16bit] format file for playback (☞ P.25, P.60).
	[Rec Format] is not set to [PCM 44.1kHz/16bit] .	Set [Rec Format] to [PCM 44.1kHz/16bit] (☞ P.66).
Unable to set index marks, temp marks	The maximum number of marks has been reached.	Erase unnecessary marks (☞ P.45).
	The file is locked.	Unlock the file (☞ P.51).
	The file is read-only.	Unlock the file or cancel the file's read-only setting on the PC.
The PC is unable to recognize the recorder	[USB Connection] is set to [AC Adapter] .	Set [USB Connection] to [PC] (☞ P.76).

Accessories (optional)

Accessories exclusive to the Olympus voice recorder can be purchased directly from Online Shop on our company's website. Availability of accessories differs depending on the country.

- **Stereo microphone: ME51S**

The built-in large-diameter microphone enables sensitive stereo recording.

- **2 channel microphone (omni-directional): ME30W**

Two ME30 monaural microphones come in a set with a miniature tripod and a connection adapter. These highly sensitive omni-directional microphones are supported by plug-in power and are well-suited to recording musical performances.

- **Compact Gun Microphone (unidirectional): ME31**

This directional microphone is useful for various types of recording such as outdoor recording of wild birds singing. The metal body provides sturdiness and high rigidity.

- **Compact zoom microphone (unidirectional): ME32**

This microphone is integrated with a tripod, making it suitable for recording audio at a distance, such as from your table at a meeting or conference.

- **Highly sensitive noise-cancellation monaural microphone (unidirectional): ME52W**

This microphone is used to record audio at a distance while minimizing surrounding noise.

- **Tie clip microphone (omni-directional): ME15**

This small unobtrusive microphone comes with a tie-clip.

- **Telephone pickup microphone: TP8**

This earphone-type microphone can be placed into your ear while you are phoning. The voice or conversation from the phone can be recorded clearly.

- **USB connecting AC adapter: A514**
5VDC AC Adapter for USB connection.

- **Connecting cords: KA333**

This connecting cord has stereo mini-plugs (ø3.5) with resistance at both ends. Use it to connect from the earphone jack output of the recorder to the microphone input jack when recording. Converting plug adapters (PA331/PA231) which convert to the monaural mini plug (ø3.5) or monaural mini plug (ø2.5) are also included.

- **Connecting cords: KA334**

This connecting cord has stereo mini-plugs (ø3.5) without resistance at both ends.

- **Exclusive remote control set: RS30W**

When the receiver is plugged into the **REMOTE** jack, the recorder's recording and stop functions can be operated through the remote control. The receiving position can be adjusted, thereby allowing you to operate the recorder from various different angles.

General

Recording format:

Linear PCM (Pulse Code Modulation)

MP3 (MPEG-1 Audio Layer3)

Input level:

[Mic Gain]:

[Hi] : - 70 dBv

[Mid] : - 50 dBv

[Lo] : - 30 dBv

LINE IN jack:

- 6 dBv

Sampling frequency:

Linear PCM format

96.0 kHz 24 bit	96.0 kHz
88.2 kHz 24 bit	88.2 kHz
48.0 kHz 16 bit	48.0 kHz
44.1 kHz 16 bit	44.1 kHz
44.1 kHz (mono)	44.1 kHz

MP3 format

320 kbps	44.1 kHz
256 kbps	44.1 kHz
128 kbps	44.1 kHz
64 kbps (mono)	44.1 kHz

Maximum working output:

300 mW (8 Ω speaker)

Maximum headphone output:

≤ 150 mV (according to EN 50332-2)

Recording media*:

Built-in NAND FLASH memory:

LS-14: 4 GB

LS-12: 2 GB

SD card:

2 GB to 32 GB

- * The recorder uses some of its memory capacity to maintain a management file. The indicated remaining capacity is less than the total capacity of the media due to its characteristic. This is not a malfunction.

Speaker:

Built-in ø 28 mm round dynamic speaker

Built-in microphone with acoustic resistance:

130 dBspl

MIC jack:

ø 3.5 mm mini-jack, impedance 2 kΩ

LINE IN jack:

ø 3.5 mm mini-jack, impedance 10 kΩ

EAR jack:

ø 3.5 mm mini-jack, impedance 8 Ω or more

Input power requirement:

Batteries:

AA batteries (LR6) or

Ni-MH rechargeable batteries

External power supply:

USB connecting AC adapter (A514) 5 V

External dimensions:

138.7 mm × 52.5 mm × 23.5 mm
(without protrusions)

Weight:

170 g (including batteries)

Operating temperature:

0°C - 42°C / 32°F - 107.6°F

Frequency response

- During recording mode (MIC jack/ LINE IN jack):

Linear PCM format

96.0 kHz 24 bit	20 Hz to 44 kHz
88.2 kHz 24 bit	20 Hz to 42 kHz
48.0 kHz 16 bit	20 Hz to 23 kHz
44.1 kHz 16 bit	20 Hz to 21 kHz
44.1 kHz (mono)	20 Hz to 21 kHz

MP3 format

320 kbps	20 Hz to 20 kHz
256 kbps	20 Hz to 20 kHz
128 kbps	20 Hz to 17 kHz
64 kbps (mono)	20 Hz to 13 kHz

- During recording mode (Built-in microphones):

LS-14:

20 Hz to 20 kHz ([Central Mic ON])
60 Hz to 20 kHz ([Central Mic OFF])

LS-12:

60 Hz to 20 kHz

(However, when recording in MP3 format, the upper limit value of the frequency response depends on the recording format.)

- During playback mode:

20 Hz to 20 kHz

(The upper and lower limit values of the frequency response depends on each recording format.)

Maximum recording time per file

- The maximum capacity for a single file is approx. 4 GB for MP3, and approx. 2 GB for the Linear PCM format (WAV).
- Regardless of the amount of remaining memory, the longest sound recording time per file is restricted to the following value.

- Linear PCM format:

96.0 kHz 24 bit	approx. 1 h.
88.2 kHz 24 bit	approx. 1 h.
48.0 kHz 16 bit	approx. 3 h.
44.1 kHz 16 bit	approx. 3 h. 20 min.
44.1 kHz (mono)	approx. 6 h. 40 min.

- MP3 Format:

320 kbps	approx. 29 h. 40 min.
256 kbps	approx. 37 h. 10 min.
128 kbps	approx. 74 h. 30 min.
64 kbps (mono)	approx. 149 h.

Specifications

Guide to recording times

The following values are strictly for reference only.

■ Linear PCM format:

Recording format	Internal memory		SD card		
	LS-14 (4 GB)	LS-12 (2 GB)	32 GB	16 GB	8 GB
96.0 kHz 24 bit	1 h. 35 min.	40 min.	14 h. 30 min.	7 h. 15 min.	3 h. 35 min.
88.2 kHz 24 bit	1 h. 45 min.	45 min.	15 h. 45 min.	7 h. 50 min.	3 h. 55 min.
48.0 kHz 16 bit	4 h. 50 min.	2 h. 10 min.	43 h. 35 min.	21 h. 45 min.	10 h. 50 min.
44.1 kHz 16 bit	5 h. 15 min.	2 h. 20 min.	47 h. 25 min.	23 h. 40 min.	11 h. 45 min.
44.1 kHz (mono)	10 h. 35 min.	4 h. 40 min.	94 h. 55 min.	47 h. 20 min.	23 h. 35 min.

■ MP3 format:

Recording format	Internal memory		SD card		
	LS-14 (4 GB)	LS-12 (2 GB)	32 GB	16 GB	8 GB
320 kbps	23 h. 30 min.	10 h.	209 h.	104 h.	52 h.
256 kbps	29 h.	13 h.	261 h.	130 h.	65 h.
128 kbps	58 h. 30 min.	26 h.	523 h.	261 h.	130 h.
64 kbps (mono)	117 h.	52 h.	1,046 h.	522 h.	260 h.

Notes

- Available recording time may be shorter if numerous short recordings are made (The displayed available recording time and recorded time are approximate indications).
- Variations in the available recording time will arise as there may be differences in the available memory depending on the SD card.

Download from Www.Somanuals.com. All Manuals Search And Download.

Guide to battery life

The following values are strictly for reference only.

In recording mode (Internal memory):

Recording format		Built-in microphones*	
		Alkaline battery	
		LS-14 (4 GB)	LS-12 (2 GB)
Linear PCM format	44.1 kHz 16 bit	46 h.	50 h.
MP3 format	320 kbps	42 h.	46 h.
	64 kbps (mono)	43 h.	47 h.

* When [Mic Select] is set to [On] (LS-14 only).

In voice file playback mode:

Recording format		Built-in speaker
		Alkaline battery
Linear PCM format	44.1 kHz 16 bit	62 h.
MP3 format	320 kbps	53 h.
	64 kbps (mono)	61 h.

Recording format		Earphone playback
		Alkaline battery
Linear PCM format	44.1 kHz 16 bit	86 h.
MP3 format	320 kbps	75 h.
	64 kbps (mono)	86 h.

Notes

- Battery life is measured by Olympus. It varies greatly according to the type of battery used and the conditions of use.
- Battery life may be shorter when using an SD card.

Specifications and design are subject to change without notice.

Technical assistance and support

The following contact information relates to technical support for Olympus recorders and software only.

- **Technical Hotline Number in the U.S. and Canada**
1-888-553-4448
- **User Support E-mail address in the U.S. and Canada**
distec@olympus.com

Declaration of Conformity:

Model Number: LS-14/LS-12
Trade Name: LINEAR PCM RECORDER
Responsible Party: OLYMPUS IMAGING AMERICA INC.
Address: 3500 Corporate Parkway, P.O. Box 610, Center Valley,
PA 18034-0610, U.S.A.
Telephone Number: 1-888-553-4448

This device Complies with Part 15 of the FCC Rules. Operation is subject to the following two conditions: (1) This device may not cause harmful interference, and (2) this device must accept any interference received, including interference that may cause undesired operation.



**Tested To Comply
With FCC Standards
FOR HOME OR OFFICE USE**

Canadian RFI:

This digital apparatus does not exceed the Class B limits for radio noise emissions from digital apparatus as set out in the Radio Interference Regulations of the Canadian Department of Communications.

Cet appareil numérique ne dépasse pas les limites de la Catégorie B pour les émissions de bruit radio émanant d'appareils numériques, tel que prévu dans les Règlements sur l'Interférence Radio du Département Canadien des Communications.

OLYMPUS®

OLYMPUS IMAGING CORP.

2951 Ishikawa-machi, Hachioji-shi, Tokyo 192-8507, Japan.

Tel. +81 (0)42-642-6162

<http://www.olympus.com>

OLYMPUS IMAGING AMERICA INC.

3500 Corporate Parkway, P.O. Box 610, Center Valley, PA 18034-0610, U.S.A.

Tel. 1-888-553-4448

<http://www.olympusamerica.com>

Free Manuals Download Website

<http://myh66.com>

<http://usermanuals.us>

<http://www.somanuals.com>

<http://www.4manuals.cc>

<http://www.manual-lib.com>

<http://www.404manual.com>

<http://www.luxmanual.com>

<http://aubethermostatmanual.com>

Golf course search by state

<http://golfingnear.com>

Email search by domain

<http://emailbydomain.com>

Auto manuals search

<http://auto.somanuals.com>

TV manuals search

<http://tv.somanuals.com>