

User's Guide

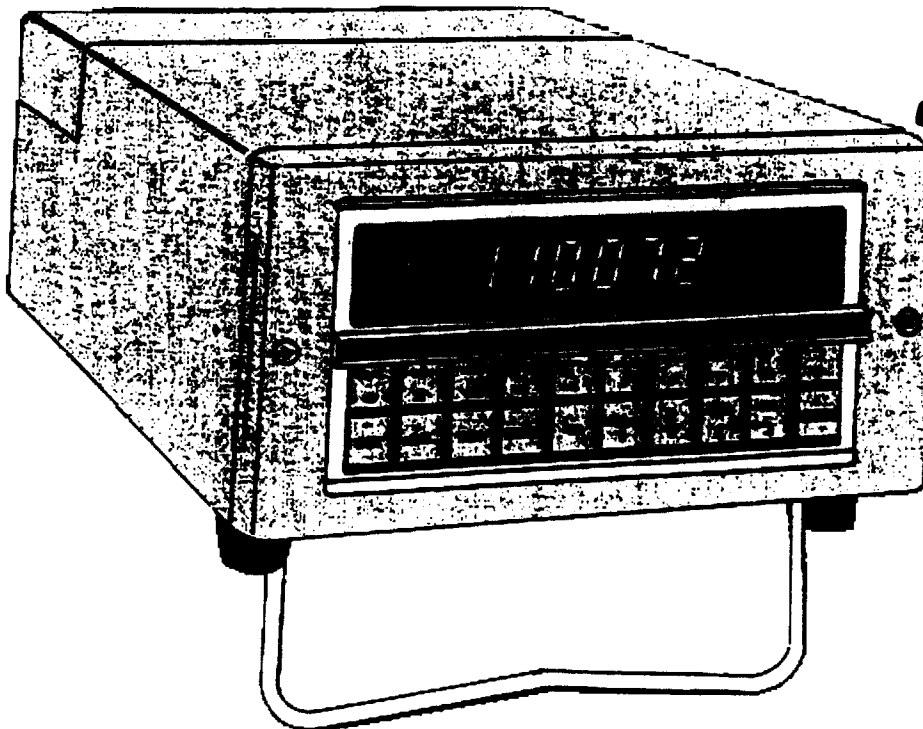
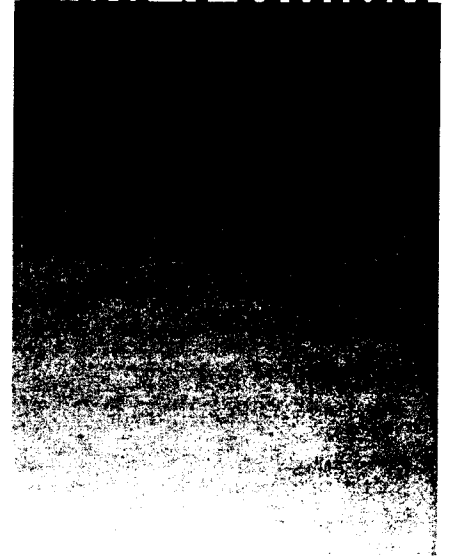

omega.com™

Ω OMEGA®

www.omega.com

e-mail: info@omega.com

DP95 DIGITAL RTD THERMOMETER

OMEGAnet® On-Line Service
www.omega.com

Internet e-mail
info@omega.com

Servicing North America:

USA:
ISO 9001 Certified

One Omega Drive, P.O. Box 4047
Stamford CT 06907-0047
TEL: (203) 359-1660 FAX: (203) 359-7700
e-mail: info@omega.com

Canada:

976 Bergar
Laval (Quebec) H7L 5A1
TEL: (514) 856-6928 FAX: (514) 856-6886
e-mail: info@omega.ca

For immediate technical or application assistance:

USA and Canada: Sales Service: 1-800-826-6342 / 1-800-TC-OMEGA®
Customer Service: 1-800-622-2378 / 1-800-622-BEST®
Engineering Service: 1-800-872-9436 / 1-800-USA-WHEN®
TELEX: 996404 EASYLINK: 62968934 CABLE: OMEGA

Mexico:

TEL: (001) 800-826-6342 FAX: (001) 203-359-7807
En Español: (001) 203-359-7803 e-mail: espanol@omega.com
info@omega.com.mx

Servicing Europe:

Benelux:

Postbus 8034, 1180 LA Amstelveen, The Netherlands
TEL: +31 (0)20 6418405 FAX: +31 (0)20 6434643
Toll Free in Benelux: 0800 0993344
e-mail: nl@omega.com

Czech Republic:

Rudé armády 1868, 733 01 Karviná 8
TEL: +420 (0)69 6311899 FAX: +420 (0)69 6311114
Toll Free in Czech Republic: 0800-1-66342 e-mail: czech@omega.com

France:

9, rue Denis Papin, 78190 Trappes
TEL: +33 (0)130 621 400 FAX: +33 (0)130 699 120
Toll Free in France: 0800-4-06342
e-mail: france@omega.com

Germany/Austria:

Daimlerstrasse 26, D-75392 Deckenpfronn, Germany
TEL: +49 (0)7056 3017 FAX: +49 (0)7056 8540
Toll Free in Germany: 0800 TC-OMEGASM
e-mail: germany@omega.com

United Kingdom:

ISO 9002 Certified

One Omega Drive, River Bend Technology Centre
Northbank, Irlam, Manchester
M44 5EX United Kingdom
TEL: +44 (0)161 777 6611 FAX: +44 (0)161 777 6622
Toll Free in United Kingdom: 0800 488 488
e-mail: sales@omega.co.uk

It is the policy of OMEGA to comply with all worldwide safety and EMC/EMI regulations that apply. OMEGA is constantly pursuing certification of its products to the European New Approach Directives. OMEGA will add the CE mark to every appropriate device upon certification.

The information contained in this document is believed to be correct, but OMEGA Engineering, Inc. accepts no liability for any errors it contains, and reserves the right to alter specifications without notice.

WARNING: These products are not designed for use in, and should not be used for, patient-connected applications.

TABLE OF CONTENTS

DP95 DIGITAL RTD THERMOMETER

CHAPTER	PAGE
CHAPTER 1 INTRODUCTION.....	1
1.1 About this Product.....	1
1.2 Manual Organization	1
1.3 Specifications	2
1.3.1 Signal Input.....	2
1.3.2 Input Specifications	2
1.3.3 Analog Output (Probe #1 Only)	3
1.3.4 RS-232C Communication Parameters	3
1.3.5 Environmental and Physical Properties	4
1.3.6 Probe Linearizations (When Only Alpha Is Selected)	4
1.3.7 Calculation Algorithms	5
1.4 Service Information.....	5
1.4.1 How To Pack And Return The DP95	5
1.4.2 Environmental (Storage)	5
CHAPTER 2 INSTALLATION/PREPARATION FOR USE.....	7
CHAPTER 3 PRINCIPLES OF OPERATION	9
3.1 About RTD Temperature Measurement	9
3.1.1 RTD Limitations	9
3.1.1.1 Nonlinearity	9
3.1.1.2 Resistance in Leads	10
3.1.1.3 Material Impurities	10
3.2 DP95 System Components.....	10
3.2.1 The CPU	10
3.2.2 RTD Input Cards	12
3.2.3 Power Supply.....	12
3.2.4 Display and Keyboard.....	12
3.3 System Programming.....	12
CHAPTER 4 PROBE CONFIGURATION INSTRUCTIONS.....	13
4.1 Connecting the Probes	13
4.2 Entering Probe Coefficients	16
4.2.1 Using the Configuration Panel	16
4.2.2 Entering Numbers	17
4.2.3 Entering Configuration Mode	18
<i>Method A:</i> If you know only alpha and R_0	21
<i>Method B:</i> If you know all Callendar-Van Dusen Coefficients	23
<i>Method C:</i> If you know all IPTS-68 Coefficients	25
<i>Method D:</i> If you know all ITS90 Coefficients	27
<i>Method E:</i> If you know all IPTS-68 Coefficients but want temperature on the ITS90 Scale	31

TABLE OF CONTENTS (Cont'd)

CHAPTER	PAGE
4.2.4	Completing the Configuration Process33
4.3	Securing the Probe Configuration.....33
4.4	Configuration Display Precision34
CHAPTER 5 USING THE THERMOMETER	37
5.1	Performing the Self-Test.....37
5.2	Reading a Temperature37
5.3	Using Autoscan.....40
5.4	Using Delta 1-240
5.5	Printing a Reading40
5.6	Using the Analog Output.....40
5.7	DP95 Communication Configurations41
5.7.1	No Communication Interface.....41
5.7.2	Using the RS-232C Communication Interface41
5.7.3	Using the IEEE-488 Communication Interface43
CHAPTER 6 IEEE-488 DATA INTERFACE	45
6.1	What You Can Do With the IEEE-488 Interface45
6.2	IEEE-488.2 Compliance45
6.3	IEEE-488 Specifications and Functions.....46
6.3.1	Message Terminators46
6.3.2	Receiver and Transmitter Queues46
6.3.3	Delay Times Between Commands and Responses47
6.3.4	ESR and STB Register Status Bits.....47
6.4	Addressing And Configuring The DP95 For Your Controller48
6.4.1	Setting Up The Address.....48
6.4.2	Changing the DP95 to Stand Alone Configuration49
6.4.3	Number Representations.....49
6.5	Specific DP95 IEEE-488 Command Summary50
6.5.1	Measurement Mode Commands50
6.5.2	PROGRAMMING Mode Commands52
6.5.3	IEEE Specific Commands.....54
6.6	IEEE-488 Commands for ITS 9057
CHAPTER 7 MAINTENANCE AND SERVICE	59
7.1	Introduction.....59
7.2	Performance Verification59
7.3	Recalibration60
7.3.1	Theory60
7.3.2	Choosing Calibration Points62
7.3.3	Recalibration Procedure62
7.3.4	Calibration Example 165
7.3.5	Calibration Example 275
7.4	Troubleshooting.....82

Chapter 1

Introduction

1.1 About this Product

The OMEGA DP95 Precision RTD Thermometer may be used to measure the temperatures of up to four probes with a level of accuracy which has typically been available only from expensive units. The thermometer's built-in microprocessor can be programmed to accept Callendar-Van Dusen, IPTS-68, or ITS-90 coefficients for each of up to four probes, or select one of four standard alpha values for each probe and have the thermometer supply approximations for remaining parameters. You can also program the thermometer to read in Ohms only mode.

Once you have programmed the DP95, you can read the temperatures in °C, °F, K, and ohms (unless you programmed the Ohms only mode). You may also individually set any of the four units as default units for each probe. Once set, the default units are displayed whenever the probe is read (with all other units still available at the touch of a key).

A companion data logging printer, pre-configured for use with the DP95, is also available. The DP95 sends preformatted information to the printer through the serial port located on its back panel.

1.2 Manual Organization

This manual has 7 Chapters. A summary of the chapters follows:

- Chapter 1** titled Introduction, contains a brief description of the DP95 thermometer. The Manual Organization is included as well as the Specifications for the instrument.
- Chapter 2** explains how to prepare and install the DP95.
- Chapter 3** gives a brief description of the principles of operation of an RTD (Resistive Temperature Device) Thermometer. This chapter briefly explains the various components that make up the instrument.
- Chapter 4** explains how to configure the probes that are used to sense temperature. This chapter is quite detailed.
- Chapter 5** titled Using the Thermometer, explains how to use the instrument. It will show you how to read a temperature and how to set up the instrument in various modes.
- Chapter 6** explains, in detail, how to use the DP95 interfaced to a controller via the IEEE-488 Data Interface. This chapter only applies to those instruments that have the "IE" option.
- Chapter 7** explains how to maintain and service the DP95. There is a troubleshooting section which should assist you if the instrument malfunctions.

1.3 Specifications

1.3.1 Signal Input

Configuration: Isolated input for each channel, four channels maximum.
 Input Range: -199.999 to 800.000°C.
 Isolation (CMV): 600V minimum, 1000 V typical.
 Gain Tempo: 1 PPM /°C typical, 2PPM /°C maximum. (of full scale)
 Zero Stability: Auto-zero, ± 0.1 uV /°C typical.
 CMRR: Greater than 160 dB typical

1.3.2 Input Specifications

Probe Model #	Ohms Ro	No. of Leads	Resolution		Accuracy		Sensor Excit'n
			°C	Ω	°C	Ω	
RT40	25	4	0.001	0.0001	0.01	0.001	1.0mA
RT41	100	4	0.001	0.001	0.01	0.004	1.0mA
RT42	200	4	0.001	0.001	0.01	0.008	0.5mA
RT43	500	4	0.001	0.01	0.01	0.020	0.2mA
RT44	1000	4	0.001	0.01	0.01	0.040	0.1mA
RT45	50	4	0.001	0.001	0.01	0.002	1.0ma
RT31	100	3	0.001	0.001	0.01	0.004	1.0mA
RT32	200	3	0.001	0.001	0.01	0.008	0.5mA
RT33	500	3	0.001	0.01	0.01	0.02	0.2mA
RT34	1000	3	0.001	0.01	0.01	0.04	0.1mA
CT40	25	4	0.001	0.001	0.005	0.0005	1.0mA
CT41	100	4	0.001	0.001	0.005	0.002	1.0mA
CT42	200	4	0.001	0.001	0.005	0.004	0.5mA
CT43	500	4	0.001	0.01	0.005	0.01	0.2mA
CT44	1000	4	0.001	0.01	0.005	0.02	0.1mA
CT45	50	4	0.001	0.001	0.005	0.001	1.0ma
CT31	100	3	0.001	0.001	0.005	0.002	1.0mA
CT32	200	3	0.001	0.001	0.005	0.004	0.5mA
CT33	500	3	0.001	0.01	0.005	0.01	0.2mA
CT34	1000	3	0.001	0.01	0.005	0.02	0.1mA

1.3.3 Analog Output (Probe #1 Only)

(For Instruments With AO Option Only)

Configuration:	Isolated and Floating Output
Output Range:	-199 to +800 mV
Analog Resolution:	0.276 mV
Digital Resolution:	12 bits (4096) 0.025%
Output Resolution:	1 mV /°C
Isolation (CMV):	600 V minimum, 1000 V typical.
Accuracy:	0.05% typical, 0.1% maximum (of Full Scale)
Gain Tempco:	10PPM /°C typical, 20PPM /°C maximum
Zero Tempco:	10PPM /°C typical, 15PPM /°C maximum
CMRR:	Greater than 160 dB typical

1.3.4 RS-232C Communication Parameters

(For Instruments With RS Option Only)

Baud Rate:	1200
Word Length:	7 bits
Parity:	Even
Stop Bits:	2 bits
Data Format:	ASCII
Flow Control:	X-ON X-OFF
Supported Lines:	Transmit Data Pin 3
	Receive Data Pin 2
	System Ground Pin 1
	Signal Ground Pin 7
Connector Type:	Standard 25 Pin "D" Connector

1.3.5 Environmental and Physical Properties

Temperature Range:	Operating, 0° to 60°C; Storage, -40° to 85°C
Relative Humidity:	0% to 95%, non condensing
Power Dissipation:	10 Watts typical
Fuse:	½A, 3AG Slow-Blow
Size (H x W x D):	4.5" x 8" x 13" (114.3 x 203.2 x 330.2 mm) Bench Top with tilt stand
Weight:	Approximately 16 lbs. (7.2 Kg)

1.3.6 Probe Linearizations (When Only Alpha Is Selected)

Selection	Linearizations
385PT	DIN 43760 Table
390PT	Alpha = 0.0038994 Delta = 1.494 A4 = -0.265668E-04 C4 = -0.205984E-11
3916PT	Alpha = 0.003916 Delta = 1.505 A4 = -0.99668E-05 C4 = -0.271142E-12
392PT	Alpha = 0.0039221 Delta = 1.493 A4 = -0.38668E-05 C4 = 0.192912E-13
OHMS	No linearizations, only probe resistance is measured

1.3.7 Calculation Algorithms

IPTS-68:	User enters reference coefficients R_0 , α , δ , A_4 and C_4 (A_4 and C_4 required only if measurements are to be taken below 0°C).
Callendar-Van Dusen:	User enters reference coefficients R_0 , α , δ , and β (β required only if measurements are to be taken below 0°C).
ITS-90	User enters reference coefficient R_0 , and other coefficients depending on the calibration range. Refer to "Entering Probe Coefficients" section for a list of coefficients.

1.4 Service Information

1.4.1 How To Pack And Return The DP95

Remove the Packing List and verify that all equipment has been received. If there are any questions about the shipment, please call the OMEGA Customer Service Department at 1-800-622-2378 or (203) 359-1660.

Upon receipt of shipment, inspect the container and equipment for any signs of damage. Take particular note of any evidence of rough handling in transit. Immediately report any damage to the shipping agent.

NOTE

The carrier will not honor any claims unless all shipping material is saved for their examination. After examining and removing contents, save packing material and carton in the event reshipment is necessary.

1.4.2 Environmental (Storage)

Due to its ruggedized enclosure, the DP95 Thermometer can be used in a wide variety of environments. For proper operation, the following environmental limits should be observed:

Temperature Ranges:

Operating: 32°F to 140°F (0°C to 60°C)

Storage: -40°F to 185°F (-40°C to 85°C)

Relative Humidity: 0% to 95%, non condensing.

Chapter 2

Installation/Preparation for Use

To properly install the DP95, follow these steps:

1. Unpack the instrument from its shipping container.

When your thermometer arrives, you should find the following items in the shipping carton:

- 1 DP95 thermometer
- 1 Configuration Panel (inside the back cover of the DP95). Refer to Figure 4.2
- 1 AC line cord
- 1 NIST calibration certificate for each channel
- 1 DP95 Operator's Manual

If an item is missing or appears defective, please notify OMEGA immediately. Every effort will be made to minimize your inconvenience.

2. The type of power (i.e. AC or DC), voltage, and frequency needed to operate the instrument is printed on the label on the bottom of the unit. Since the DP95 can be ordered with different power requirements (i.e. AC 110V, AC 220V, DC 12V) determine the power requirement of the instrument from the label and connect the appropriate power to the instrument. Plug the unit's power cable into the power connector on the rear of the unit, as shown in Figure 2.2.
3. Install and configure the probes. See Chapter 4 for more instructions on how to do this.

For the best performance of the unit:

- Protect instrument from air drafts and sudden temperature fluctuations. These can cause unstable and inaccurate readings.
- Cover the probe connections with the supplied cover.
- Allow 6-8 hours warm-up time after connecting power. It is recommended that the unit always be left on.

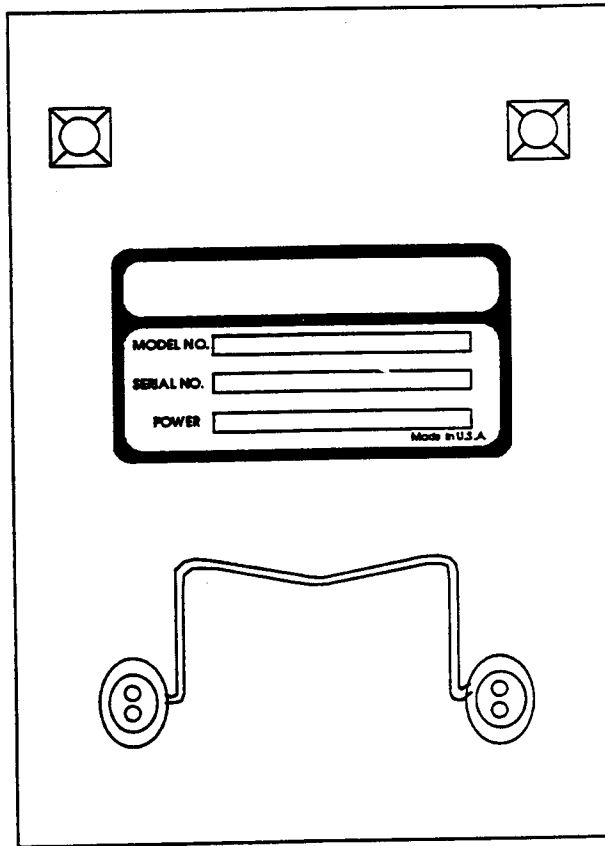

Figure 2.1 Bottom of the DP95, showing information sticker

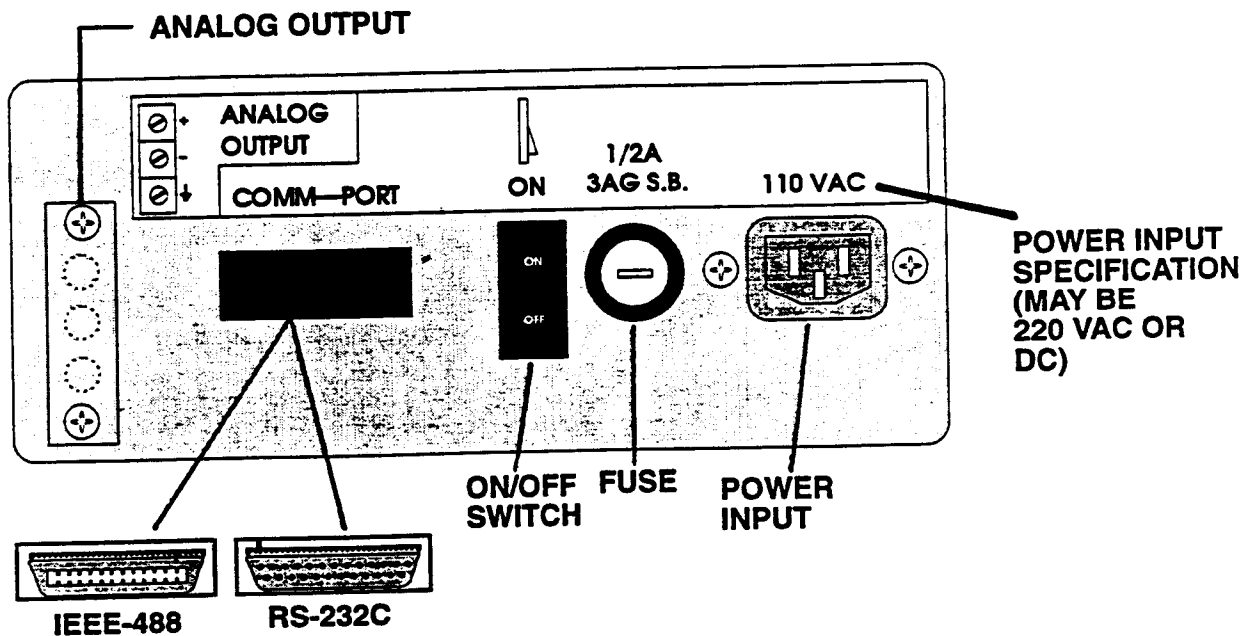

Figure 2.2 The back of the DP95

Chapter 3

Principles of Operation

3.1 About RTD Temperature Measurement

It probably comes as no surprise that temperature is the parameter most often measured in the laboratory, on the manufacturing floor, and even in the home. This is with good reason, as no other parameter can so drastically affect the outcome of so many processes, from smelting iron to baking a cake.

Measurement needs, however, vary over a wide range of conditions and temperatures. These needs have spawned the development of several different tools. The most common of these is the standard thermometer, suitable for every day use. The high precision required by science and industry is met by two other devices: the thermocouple and the resistive temperature device (RTD). The DP95 uses an RTD for measuring temperature.

RTD measurement is based on using a temperature probe made of a small coil of platinum wire. Since platinum wire has a different electrical resistance at different temperatures, measuring the resistance of a coil of platinum wire makes it possible to calculate the temperature of the probe.

3.1.1 RTD Limitations

Several factors based on the physical limitations of the probes have to be taken into account when using an RTD. These limitations affect how accurate the temperature measurements are, and in what temperature ranges the probes can be used.

3.1.1.1 Nonlinearity

While the resistance of a platinum wire changes with temperature, the change is not linear. For example, a 10% increase in temperature does not necessarily correspond to a 10% increase in resistance. To compensate for this, a mathematical formula which can translate the resistance of the wire into its temperature is needed. There are three standard formulas to do this, all of which are stored in the memory of the DP95.

The first formula is the Callendar-Van Dusen equation (CVD):

$$R_t = R_0 \left\{ 1 + \alpha \left[t - \delta \left(\frac{t}{100} \right) \left(\frac{t}{100} - 1 \right) - \beta \left(\frac{t}{100} - 1 \right) \left(\frac{t}{100} \right)^3 \right] \right\}$$

where t is the temperature on the CVD scale.

The other commonly used equation is the International Practical Temperature Scale 1968 (IPTS-68):

$$R_t = R_0 \left\{ 1 + \alpha \left[t' - \delta \left(\frac{t'}{100} \right) \left(\frac{t'}{100} - 1 \right) \right] \right\}$$

where t' is the temperature on the IPTS-68 scale. This equation is valid only when $t' > 0^\circ\text{C}$. Temperatures below 0°C are measured using the R_0 , A_4 and C_4 coefficients.

These equations use the parameters *alpha*, *beta* and *delta* to "match" a given resistance with a temperature. The more accurately these parameters are known, the more precise the measurement will be.

The third linearization method is the International Temperature Scale 1990 (ITS-90), which uses different equations and coefficients for different temperature ranges. Each temperature range has a group of coefficients called A, B, C, etc. Coefficients for different groups are distinguished by the subscripts 4 to 12.

3.1.1.2 Resistance in Leads

The resistance of wires and connectors of a probe can interfere with the accurate measurement of resistance in the platinum coil. To minimize this problem, most RTDs have three or four leads. Two of the leads send a known current through the platinum wire. The other lead or leads are used to measure the voltage drop across the platinum wire. From this measurement, the resistance of the platinum wire can be calculated with a minimum effect from the leads and connectors.

3.1.1.3 Material Impurities

It is impossible to find platinum that is absolutely free of impurities that would affect its resistance. In order to overcome this, the manufacturer adds a specific amount of impurities to the wire. These impurities can then be measured and compensated for.

3.2 DP95 System Components

The main components of the DP95 RTD Thermometer are the CPU, RTD input card(s), power supply, display, keyboard, and the case. The organization of these components are shown in Figure 3-1, and explained in the following sections.

3.2.1 The CPU

The central processor unit (CPU) controls the entire instrument. It drives the analog to digital (A/D) converters on the RTD input cards, displays measurements, and responds to commands from the keyboard and communication interface.

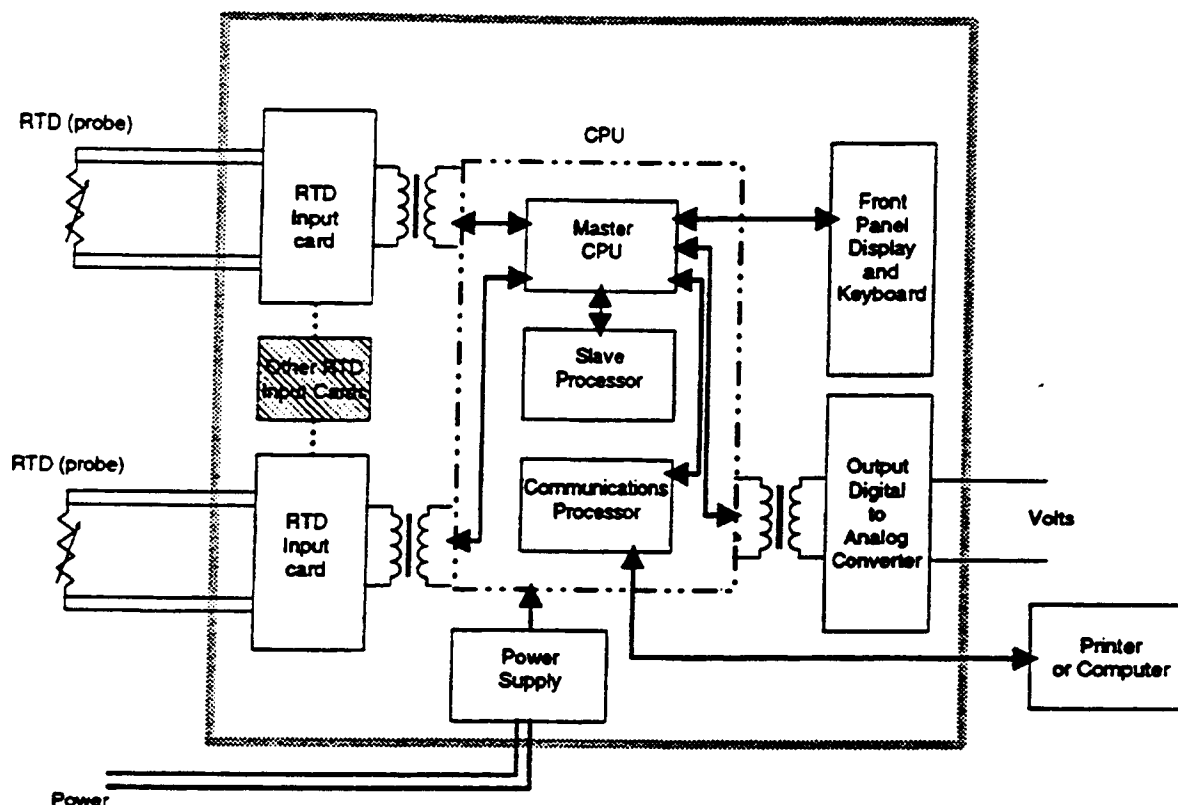

Figure 3.1 DP95 Block Diagram

The CPU is made up of two sandwiched printed circuit boards which are located in the top of the DP95's case. It has three microprocessors: the master processor, the slave processor, and the communications processor. All the processors run proprietary firmware stored on EPROMs.

The master processor accepts the system configuration information (number of inputs, calibration constants, etc.) and probe coefficients entered by the user and stores it in the EEPROM. The master and slave processors convert the counts from the A/D converters on the RTD cards into the resistance in ohms of the probe. They then calculate the temperature in Celsius, Kelvin, and Fahrenheit using the probe coefficients saved in the EEPROM. The slave processor handles all of the complex floating point computations.

The master processor handles displaying data and taking commands from the keyboard. It also passes data to the communications processor.

The communications processor controls the I/O port (either an IEEE-488 or RS-232, depending on the model of DP95), passing data to the remote host and executing the commands received.

3.2.2 RTD Input Cards

The DP95 unit has one RTD input card for each RTD input. Each card has its own, isolated and independent current source, analog signal conditioning circuit, A/D converter, and associated digital circuits. The voltage drop across the probe is measured by the A/D converter. A ratiometric measurement of the voltage and the current results in A/D counts proportional to the resistance of the RTD probe.

The RTD Input card goes through multistep processing at the factory and therefore is not field serviceable. Each RTD card has a unique set of calibration constants which are set at the factory. These constants control the scaling of A/D counts to resistance (ohms). These constants have to be changed every time a card is changed or recalibrated.

3.2.3 Power Supply

The main power supply generates different DC voltages for powering the instrument. The DC to DC voltage converters on the RTD Input card generate their own isolated voltages from the power they receive from the power supply. The type of line voltage that the power supply requires as input (i.e. the voltage, frequency, AC or DC) is set at the factory and cannot be changed in the field.

3.2.4 Display and Keyboard

The display is made up of several LED segmented displays, and is used to show the operator the collected data and configuration information. The keyboard is used by the operator to configure the DP95. They are both located on the front of the unit.

3.3 System Programming

The DP95 is configured at the factory for the RTD input boards installed in it. The configuration contains information about calibration constants, display resolutions, the averaging filter, etc. for each of the RTD Input boards.

The user has to program the type of temperature measurement (ITS90, IPTS68, or CVD, etc.) and the values of the calibration coefficients for the RTD probe connected to each of the RTD inputs. This configuration information is stored in the EEPROM and is therefore not lost when the power is turned off. The method used to program these coefficients into the DP95 is covered in the next chapter.

Chapter 4

Probe Configuration Instructions

This chapter will guide you through setting up the DP95, connecting and configuring the probes.

4.1 Connecting the Probes

To connect the probes:

1. Make sure that the probe's R_0 matches the DP95 probe input's R_0 input impedance. For example, you should not connect a 200 ohm R_0 probe to a 100 ohm R_0 probe input module.
2. Loosen the two spring-loaded thumbscrews at the back of the DP95, which hold the probe connection cover in place. The screws are attached to the cover by springs, so you do not have to remove the screws completely. Lift and remove the cover, as shown in Figure 4.1.

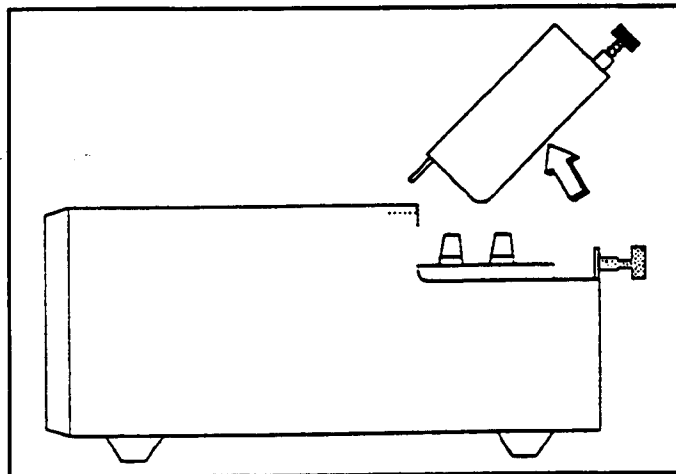

Figure 4.1 Removing the probe cover

3. Remove the magnetized configuration panel from the inside of the probe connection cover, as shown in Figure 4.2.
4. Refer to the documentation of your RTD probes and find the information identifying the probe leads. Match these to the binding posts on the back of the unit, as shown in Figure 4.3. If your probe is a 3 wire probe, do not connect a lead to the "S-" post. See Figure 4.4 for an idea of what probes look like.

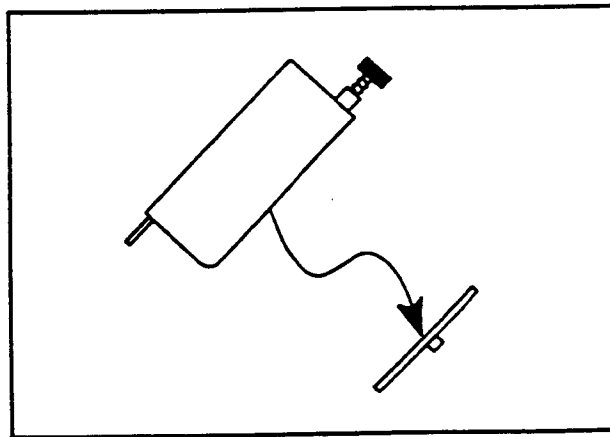

Figure 4.2 Removing the configuration panel from the probe cover

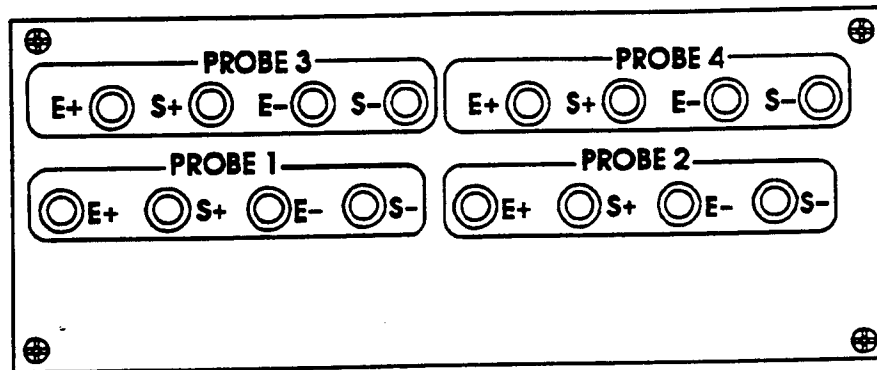

Figure 4.3 The Probe Connection Terminals

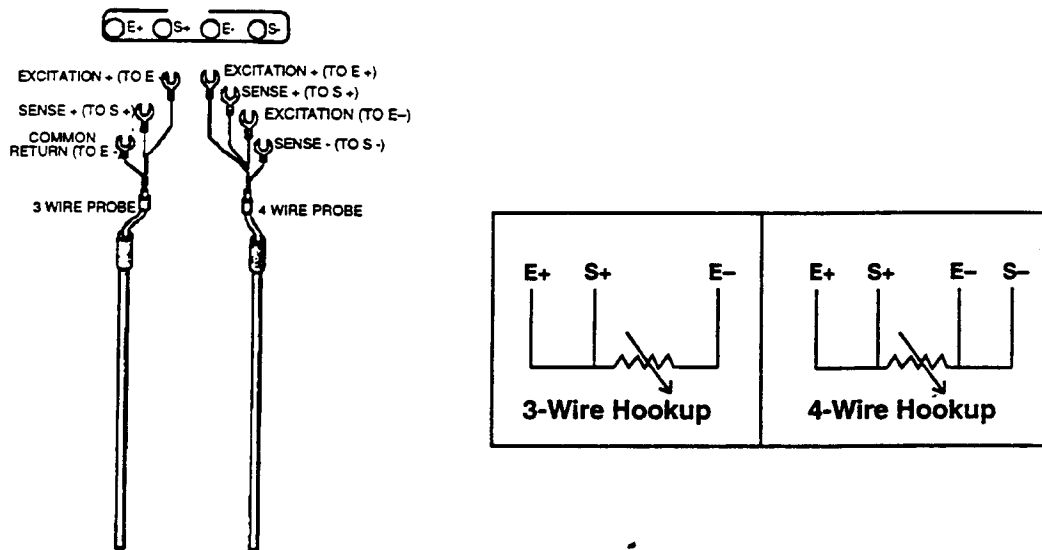

Figure 4.4 3- and 4-wire probes.

5. Connect the leads to the proper post for the first probe. The leads can be connected to the binding posts by spade lugs, banana jacks, alligator clips, or stripped and tinned leads. Run the probe wires towards the back of the unit, so that they will fit into the gap between the back panel of the unit and the probe cover.
6. Connect the leads for additional probes in the same manner.
7. You may replace the probe connection cover, but you might want to wait until the probes have been configured so you can also replace the configuration panel.

4.2 Entering Probe Coefficients

Until probe coefficients are entered, the DP95 will show measurement only in ohms. Without the probe coefficients, the DP95 has no way of converting resistance to temperature.

The probe coefficients are supplied by the probe manufacturer or calibrator. The steps that you follow to enter the probe coefficients depend on the information you have about the type of probe. The flowchart in Figure 4.6 will guide you through the process, as will the following text sections.

4.2.1 Using the Configuration Panel

Before going on, some of the keys on the configuration panel should be explained. The panel is shown in Figure 4.5.

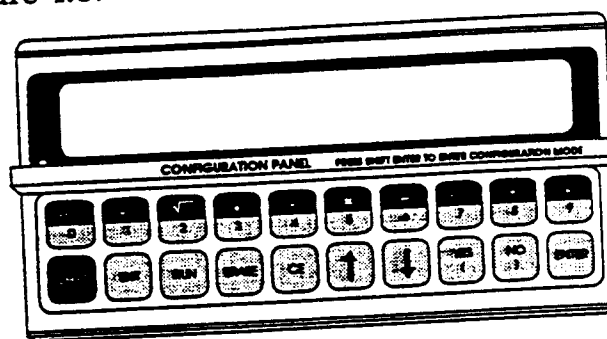

Figure 4.5 The DP95's configuration panel



If you look at the panel, you will notice that the top row of keys are split, with two symbols on them. You use the "SHIFT" key to enter the symbols on the top of these keys, just like a computer keyboard. Unlike a computer keyboard, however, *you do not need to hold down the shift key while you press the other key.*

For example, to get a decimal point, you can press and release the "SHIFT" key, and then press the "8" key.

To change the sign of a number, press "SHIFT" and the "1" key. The minus sign will appear to the left of the number you are entering. If the display is full (i.e. there are six digits on the display) then negating the number will replace the leftmost digit with the minus sign, unless the leftmost digit is 1. The leftmost digit must be removed since there is no other way to indicate that the number is negative. The digit 1 will not be replaced since that digit and the minus sign can be displayed in the same 7 segment display without confusion. If the leftmost digit is replaced with a minus sign, it is lost. For example, if you enter the number 234.567 and then press "SHIFT" "1", the display will read -34.567, and the number will be entered as -34.567.

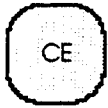

The "CE" key deletes the rightmost digit from the number you are currently entering. Repeatedly pressing the "CE" button will delete more digits.

You cannot enter a decimal point in a number if one is already displayed in the number. This may be a bit confusing, since initially, when you are asked to enter a value, the display will show "000000." (i.e. there will be a decimal point after the zeros in the display). You can delete this decimal point (along with the rightmost zero) by pressing the "CE" key. If you have already entered digits, so that the unwanted decimal point is now to the left of the number, you can enter enough zeros to "push" the decimal place off the display, and then use the "CE" key to delete the zeros you added on the right.

00.3419

For example, suppose you want to enter the number 3419.23. You press the keys "3", "4", "1", and "9", and only then notice that there is a decimal point in front of the 3:

314900

Press the "0" twice to push the decimal point off of the display, so it looks like the display shown to the right.

003149

Finally, press the "CE" key twice to get rid of the two zeros, and the display will show:

Now you can enter the rest of the number.

4.2.2 Entering Numbers

The DP95 uses scientific notation for entering most values with up to 12 digits of precision. Since the main display of the DP95 can only show six digits at a time, the number is entered in three steps: The mantissa high, mantissa low and the exponent. The mantissa high is the first six digits of the mantissa, and the mantissa low is the last six digits. The exponent for the number is power of ten that the mantissa is to be raised to. When you enter the number, the DP95 will prompt you for the these three parts in the right window of the display. For each part, you press the digits on the configuration panel then press the "ENTER" key. You will then be prompted for the next portion of the number.

The following table shows you how you would enter the number $1.23456789012 \times 10^2$

When the DP95 prompts:	You enter:
	1.23456
	789012
	2

One thing you should watch out for is leaving leading zeros in the low mantissa. For example, if the mantissa has only nine digits, like 1.23456789, the low mantissa should be entered as 789000, not 000789. Otherwise you would end up with 1.23456000789 instead of what you intended.



Negative exponents are entered the same as a negative mantissa, by using "SHIFT" "1" while entering the digits. The minus sign will never replace the left digit of the exponent, since the exponent can only have two digits in it. There is enough room to display both digits as well as the minus sign. After being entered, the exponent is usually shown in the right display, along with the letter "E" and the minus sign (if any). For example, the display to the right shows the exponent minus three (-3).

4.2.3 Entering Configuration Mode

After you have connected the power and the probes to the DP95 unit, you can turn it on. The instrument will go through a self-test procedure, which should end with the word "PASS" appearing in the units window. After the self test is completed:



1. Place the magnetized configuration panel on the front of the DP95. Now, press the "SHIFT" key, and then the "ENTER" key.



2. The DP95's displays will clear for a moment, and then rightmost window will display "PRB?" The DP95 is now asking you whether you want to configure a probe.



3. Since you want to configure a probe, press the "YES" key.



4. The rightmost window will now display "PRB#", asking you to enter the number of the probe you want to configure.

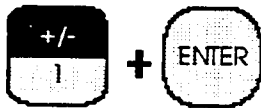

5. You probably want to configure probe 1, so press the "1" key. A "1" will show up in the leftmost window. If you want to configure another probe, enter its number instead. After you have entered the probe number, press the "ENTER" key.



6. At this point, the DP95 needs to know how the probe is to be configured. The type of configuration depends on the type of information you have on your probe.

Consult the documentation you have on your probe and find the type of parameters it supplies in the table below. Turn to the page indicated in the table and follow the procedures there.

The information you have:	Method to follow	Page number
Only alpha and R_0	A	21
All of the Callendar-Van Dusen Coefficients	B	23
All of the IPTS-68 Coefficients	C	25
All of the ITS90 coefficients	D	27
All IPTS-68 coefficients, but you want to use ITS90 Temperature Scale.	E	31

Figure 4.6 shows how you will proceed through the configuration process depending upon the information you have.

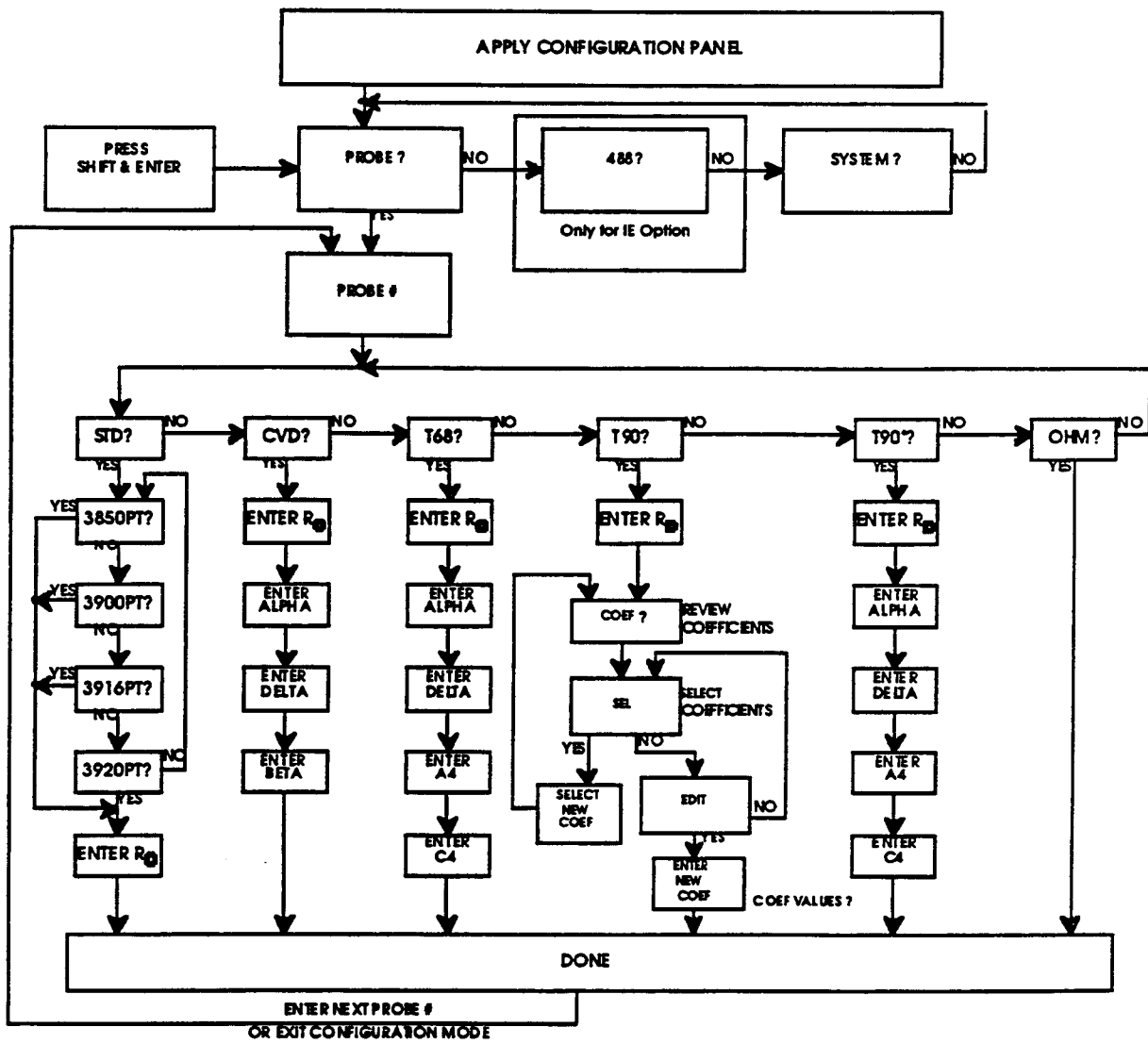









Figure 4.6 Flow Diagram Showing Probe Configuration

Method A

If you know only alpha and R_0

You must have already followed steps one through six in the beginning of Section 4.2.3 before continuing on.

- U
n
t
i
l
-  
- 
- 
- 
- 
- 
- 
1. In the rightmost window, the display will be showing the various methods for configuring the probe that you can select from. Press the "NO" key until this window reads "STD?", which stands for standard alpha mode.
 2. This is the method you want to use, so press the "YES" key.
 3. You now have to select one of the four standard alpha values for the probe that the DP95 has stored in memory. The rightmost window will be displaying "PT?", and the central window will be displaying one of the available alpha values: 3850, 3900, 3916, or 3920.
 4. Press the "NO" key to cycle through these four options until you get to the alpha value that corresponds to your probe. If you should accidentally hit "NO" in response to the alpha value you want, continue pressing "NO" and the value will eventually reappear.
 5. Once the alpha value that matches your probe is displayed in the central window, press the "YES" key to accept the value.
 6. Once you have selected the alpha value, the DP95 will display "Ro" in the right window, indicating that you will be entering the R_0 coefficient next.
 7. Press the "ENTER" key to continue.



8. The DP95 will now prompt you to enter the first six digits of the mantissa. The central display will show "000000." (unless the DP95 had previously been configured for another probe). Notice the decimal point on the right, delete it if necessary. Enter the first six digits of the number, placing the decimal point in the correct place. Remember that you can use the "CE" key to correct any mistakes you make. When you have entered the high mantissa, press the "ENTER" key.



9. Now the DP95 will prompt you for the rest of the mantissa. Again, the center display should read "000000.". Enter the last six digits (or whatever is left of the mantissa) for the low mantissa. When you are finished, press the "ENTER" key.



10. In the right window, the DP95 now prompts you to enter the exponent with "EXPO". The center window will read 00 since you can only enter two digits for the exponent. Press the keys to get the proper exponent and then press the "ENTER" key.

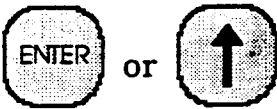

11. Next, the DP95 will display the R_0 value that you just entered, with the six most significant digits in the center display and the exponent in the right display. If you are satisfied that the value you entered is correct, press the "ENTER" key to move on to the next parameter to be entered. If you made a mistake, press the up-arrow key which will bring you back to the R_0 prompt where you will be able to correct the mistake.



12. By pressing "ENTER", you have completed entering the probe coefficients for this probe. The right window will display "DONE" momentarily, indicating that the probe has been setup. Turn to Section 4.2.4 for information on completing the configuration process.

Method B

If you know all Callendar-Van Dusen Coefficients

You must have already followed steps one through six in the beginning of Section 4.2.3 before continuing on.

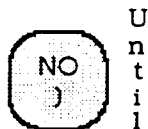

U
n
t
i
l



1. In the rightmost window, the display will be showing the various methods for configuring the probe that you can select from. Press the "NO" key until this window reads "CVD?", which stands for Callendar Van Dusen.



2. This is the method you want to use, so press the "YES" key.



3. The DP95 will display "R0" in the right window, indicating that you will be entering the R0 coefficient first.



4. Press the "ENTER" key to continue.



5. The DP95 will now prompt you to enter the first six digits of the R_0 's mantissa. The central display will show "000000." (unless the DP95 had previously been configured for another probe). Notice the decimal point on the right, delete it if necessary. Enter the first six digits of the number, placing the decimal point in the correct place. Remember that you can use the "CE" key to correct any mistakes you make. When you have entered the high mantissa, press the "ENTER" key.



6. Now the DP95 will prompt you for the rest of the mantissa. Again, the center display should read "000000." Enter the last six digits (or whatever is left of the mantissa) for the low mantissa. When you are finished, press the "ENTER" key.



7. In the right window the DP95 now prompts you to enter the exponent for R_0 with "EXPO". The center window will read "00" since you can only enter two digits for the exponent. Press the numeric keys required to get the proper exponent and then press the "ENTER" key.

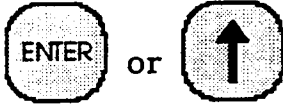

8. Next, the DP95 will display the R_0 value that you just entered, with the six most significant digits in the center display and the exponent in the right display. If you are satisfied that the value you entered is correct, press the "ENTER" key to move on to the next parameter to be entered. If you made a mistake, press the up-arrow key which will bring you back to the R_0 prompt where you will be able to correct the mistake.



9. The DP95 now displays "ALPH" in the right window, indicating that you will be entering the Callendar-Van Dusen's alpha coefficient. Press "Enter" to begin entering the coefficient. This coefficient is entered the same way you entered R_0 : you will type in the high and low mantissa and the exponent, and review the value you entered. You can go back and correct any mistakes you might make with the up arrow key



10. After entering the alpha coefficient, the DP95 will display "DLTA" in the right window, indicating that you will be entering the Callendar-Van Dusen delta coefficient next. Press the "ENTER" key and enter the data for delta as you did with R_0 and alpha.



11. Next, the DP95 prompts you to enter the Callendar-Van Dusen beta coefficient. Press enter and enter it as you did the others.



12. After you review what you entered for the beta coefficient and accept it by pressing the "ENTER" key, you will have completed entering the coefficients for this probe, indicated by the word "DONE" appearing in the right window for a moment. Turn to Section 4.2.4 for instructions on how to complete the configuration process.

Method C

If you know all IPTS-68 Coefficients

You must have already followed steps one through six in the beginning of Section 4.2.3 before continuing on.



1. In the rightmost window, the display will show the various methods for configuring the probe that you can select from. Press the "NO" key until this window reads "T68?", which stands for IPTS-68 mode.



2. This is the method you want to use, so press the "YES" key.



3. The DP95 will display "Ro" in the right window, indicating that you will be entering the R_0 coefficient for your probe first.



4. Press the "ENTER" key to continue.



5. The DP95 will now prompt you to enter the first six digits of the R_0 's mantissa. The central display will show "000000." (unless the DP95 had previously been configured for another probe). Notice the decimal point on the right, delete it if necessary. Enter the first six digits of the number, placing the decimal point in the correct place. Remember that you can use the "CE" key to correct any mistakes you make. When you have entered the high mantissa, press the "ENTER" key.



6. Now the DP95 will prompt you for the rest of the mantissa. Again, the center display should read "000000." Enter the last six digits (or whatever is left of the mantissa) for the low mantissa. When you are finished, press the "ENTER" key.



7. In the right window the DP95 now prompts you to enter the exponent for R_0 with "EXPO". The center window will read "00" since you can only enter two digits for the exponent. Press the numeric keys required to get the proper exponent and then press the "ENTER" key.

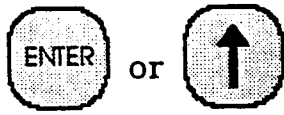

8. Next, the DP95 will display the R_0 value that you just entered, with the six most significant digits in the center display and the exponent in the right display. If you are satisfied that the value you entered is correct, press the "ENTER" key to move on to the next parameter to be entered. If you made a mistake, press the up-arrow key which will bring you back to the R_0 prompt where you will be able to correct the mistake.



9. The DP95 now displays "ALPH" in the right window, indicating that you will be entering the IPTS-68 alpha coefficient. Press "Enter" to begin entering the coefficient. This coefficient is entered the same way you entered R_0 : you will type in the high and low mantissa and the exponent, and review the value you entered. You can go back and correct any mistakes you might make with the up arrow key.



10. After entering the alpha coefficient, the DP95 will display "DLTA" in the right window, indicating that you will be entering the IPTS-68 delta coefficient next. Press the "ENTER" key and enter the data for delta as you did with R_0 and alpha.



11. Next, the DP95 prompts you to enter the IPTS-68 A4 coefficient. Press "ENTER" and type it in as you did the others.



12. Finally, the DP95 will prompt you to enter the IPTS-68 C4 coefficient. Press "ENTER" and go on to enter the coefficient as you did with the others.



13. After you review what you entered for the C4 coefficient and accept it by pressing the "ENTER" key, you will have completed entering the coefficients for this probe, as indicated by the word "DONE" appearing in the right window. Turn to Section 4.2.4 for instructions on how to complete the configuration process.

Method D

If you know the ITS90 coefficients

You must have already followed steps one through six in the beginning of Section 4.2.3 before continuing on.

ITS-90 standard has different coefficients for different temperature ranges. For example, the A6, B6, C6, and D6 coefficients are used for temperatures in the 273.15 K to 1234.93 K range. Consult the table below and find the temperature ranges you want to measure. The calibration information that you have on your probe may limit your choice of temperature ranges. For example, if your probe only came with values for A4, B4, A8, and B8, then you can only use your probe in the 83.5058 K to 692.677 K range.

TABLE 4-1

ITS90 TABLE OF COEFFICIENTS

Temperature Range	Coefficients used
83.8058 K to 273.16 K	A4, B4
273.15 K to 1234.93 K	A6, B6, C6, D6
273.15 K to 933.473 K	A7, B7, C7
273.15 K to 692.677 K	A8, B8
273.15 K to 505.078 K	A9, B9
273.15 K to 429.7485 K	A10
273.15 K to 302.9146 K	A11
234.3156 K to 302.9146 K	A5, B5



1. In the rightmost window, the display will be showing the various methods for configuring the probe that you can select from. Press the "NO" key until this window reads "T90?", which stands for ITS-90.

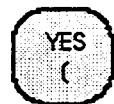

2. This is the method you want to use, so press the "YES" key.



3. The DP95 will display "Ro" in the right window, indicating that you will be entering the Ro coefficient for your probe first.



4. Press the "ENTER" key to continue.



5. The DP95 will now prompt you to enter the first six digits of the R_0 's mantissa. The central display will show "000000." (unless the DP95 had previously been configured for another probe). Notice the decimal point on the right, delete it if necessary. Enter the first six digits of the number, placing the decimal point in the correct place. Remember that you can use the "CE" key to correct any mistakes you make. When you have entered the high mantissa, press the "ENTER" key.



6. Now the DP95 will prompt you for the rest of the mantissa. Again, the center display should read "000000." Enter the last six digits (or whatever is left of the mantissa) for the low mantissa. When you are finished, press the "ENTER" key.



7. In the right window the DP95 now prompts you to enter the exponent for R_0 with "EXPO". The center window will read "00" since you can only enter two digits for the exponent. Press the numeric keys required to get the proper exponent and then press the "ENTER" key.

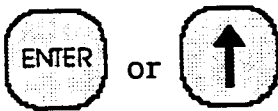

8. Next, the DP95 will display the R_0 value that you just entered, with the six most significant digits in the center display and the exponent in the right display. If you are satisfied that the value you entered is correct, press the "ENTER" key to move on to the next parameter to be entered. If you made a mistake, press the up-arrow key which will bring you back to the R_0 prompt where you will be able to correct the mistake.



9. After you have entered the R_0 coefficient, the DP95 will display "COEF" in the right window, informing you that you will enter the ITS90 coefficients next. Press the "ENTER" key to continue.



10. The DP95 will show you in the right window the temperature ranges that have been previously selected. It does this by showing you the first coefficient used by the temperature range (i.e. if the range 83.8058 K to 273.16 K has been selected, it will display "A4" in the right window). If this is the first time this probe is configured, then the DP95 selects the A4 and A8 temperature ranges for the probe as a default. Otherwise, the last coefficients that were chosen for this probe number will be shown.



11. Note the temperature ranges that the DP95 has selected and press the "ENTER" key. Usually, two ranges will be selected, so you will press the enter key twice.

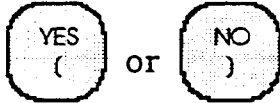

12. "SEL?" will now be displayed in the right window, asking you whether the selected temperature ranges that the DP95 just showed you were correct, or whether you would like to select new ones. If you want to select new ranges, press the "YES" key. Otherwise, press the "NO" key and skip to step 15.



13. The DP95 will show you each of the available ranges. The ranges that were not selected previously will be shown with a question mark after them, and the previously selected ranges will be displayed without a question mark. You can select either one of the positive ranges (A6 to A11) or a negative temperature range (A4) or one of each. If you want to use the A5 range, no other range can be selected. Press "NO" when the DP95 displays a range you don't want to use, and press "YES" when it shows one of the ranges you do want to use.



14. After you have selected the ranges you want to use, the DP95 will go back to the "COEF" prompt so you can check the new ranges you selected. Follow the same procedure here as you did at the last "COEF" prompt: look through the options you selected and make sure you got the right ones, and press "NO" to the "SEL?" prompt if you got everything right.



15. After you have selected the ranges you want to use, the DP95 will ask you if you want to edit the coefficients with the "EDT?" prompt in the right window.



16. Usually, you will want to do this, so press the "YES" key. Press NO if you want to go back to SEL?



17. The DP95 will display the first coefficient that you will be entering for the temperature range ("A4", "A5", etc.) in the right window. Press the "ENTER" key to continue.



18. You will now be prompted to enter the high mantissa. Enter it and the rest of the coefficient (the low mantissa and the exponent) using the same procedure that you used to enter R_0 for the probe. After you enter the coefficient, you will get to review the value you enter as before, and be able to make changes using the up-arrow key if necessary.
19. After you have accepted the value you entered for the first coefficient, you will be prompted to enter the remaining coefficients (if any). Follow the same procedure you used to enter R_0 and the first coefficient.
20. After you enter and confirm the last coefficient value, you will have completed the configuration process for this probe. The right window will display "DONE" momentarily indicating this. Turn to Section 4.2.4 for instructions on completing the configuration process.



Method E

If you know all IPTS-68 coefficients, but want temperature on the ITS90 scale

The DP95 computes the temperature on the IPTS-68 scale using IPTS-68 coefficients and then scales this temperature to the corresponding temperature on ITS-90 scale. The ITS-90 temperature is displayed. This option is used for getting ITS-90 temperatures with probes that are not calibrated for ITS-90.

You must have already followed steps one through six in the beginning of Section 4.2.3 before continuing on.

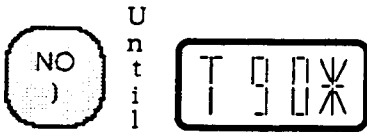

1. In the rightmost window, the display will be showing the various methods for configuring the probe that you can select from. Press the "NO" key until this window reads "T90*", which selects the ITS90 measurement mode with IPTS-68 coefficients.



2. This is the method you want to use, so press the "YES" key.



3. The DP95 will display "Ro" in the right window, indicating that you will be entering the Ro coefficient for your probe first.



4. Press the "ENTER" key to continue.



5. The DP95 will now prompts you to enter the first six digits of the R_0 's mantissa. The central display will show "000000." (unless the DP95 had previously been configured for another probe). Notice the decimal point on the right, delete it if necessary. Enter the first six digits of the number, placing the decimal point in the correct place. Remember that you can use the "CE" key to correct any mistakes you make. When you have entered the high mantissa, press the "ENTER" key.



6. Now the DP95 will prompt you for the rest of the mantissa. Again, the center display should read "000000". Enter the last six digits (or whatever is left of the mantissa) for the low mantissa. When you are finished, press the "ENTER" key.



7. In the right window the DP95 now prompts you to enter the exponent for R_0 with "EXPO". The center window will read 00 since you can only enter two digits for the exponent. Press the numeric keys required to get the proper exponent and then press the "ENTER" key.

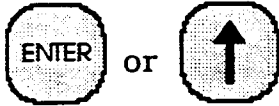

8. Next, the DP95 will display the R_0 value that you just entered, with the six most significant digits in the center display and the exponent in the right display. If you are satisfied that the value you entered is correct, press the "ENTER" key to move on to the next parameter to be entered. If you made a mistake, press the up-arrow key which will bring you back to the R_0 prompt where you will be able to correct the mistake.



9. The DP95 now displays "ALPH" in the right window, indicating that you will be entering the IPTS-68 alpha coefficient. Press "ENTER" to begin entering the coefficient. This coefficient is entered the same way you entered R_0 : you will type in the high and low mantissa and the exponent, and review the value you entered. You can go back and correct any mistakes you might make with the up arrow key.



10. After entering the alpha coefficient, the DP95 will display "DLTA" in the right window, indicating that you will be entering the IPTS-68 delta coefficient next. Press the "ENTER" key and enter the data for delta as you did with R_0 and alpha.



11. Next, the DP95 prompts you to enter the IPTS-68 A4 coefficient. Press "ENTER" and type it in as you did the others.



12. Finally, the DP95 will prompt you to enter the IPTS-68 C4 coefficient. Press "ENTER" and go on to enter the coefficient as you did with the others.



13. After you review what you entered for the C4 coefficient and accept it by pressing the "ENTER" key, you will have completed entering the coefficients for this probe. The right window will display "DONE" for a moment to indicate this. Turn to Section 4.2.4 for instructions on how to complete the configuration process.

4.2.4 Completing the Configuration Process

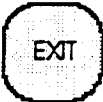

1. Once you have entered the last coefficient for the probe, the DP95 will display "DONE" in the right window for a moment, and then return to the "PRB#" prompt. At this point, you can configure another probe by entering the probe's number with the keypad and pressing the "ENTER" key.
2. If you are done configuring probes, you should press the "EXIT" key to get out of the configuration mode.
3. In the right window, the DP95 will prompt you with "EXT?", asking you if you really want to exit.
4. Press the "YES" key to confirm that you want to exit.
5. The DP95 will show the "PANL" prompt in the right window. At this point, you should remove the magnetic configuration panel. Once you have removed the panel, the DP95 will automatically perform a self test and then return to measurement mode, showing the temperature measured with the current probe.

4.3 Securing the Probe Configuration

For correct measurements and calibrations, it is vital that the correct probe configuration be entered into memory, and remain uncorrupted for as long as measurements are taken with that probe. Should the configuration data be accidentally or deliberately altered, the subsequent measurements made by the DP95 will most likely be useless.

To protect against the corruption of configuration data, the DP95 has three levels of security.

- Level 1.** This level of security involves securing the DP95's magnetic configuration panel by locking it away in a desk drawer or safe. This method does not protect against someone using another DP95 configuration panel (either from another unit or as a spare part which was not secured).
- Level 2.** This level uses a cutoff switch located behind the front of the DP95 to disable configuration mode using the configuration panel (see Figure 4.7). To toggle this switch, it is necessary to remove the two Phillips head screws from the front of the DP95 case and swing the front panel open on the hinges on the left side of the case. The switch disables the sensor in the DP95 used to detect the presence of a magnetic configuration panel.

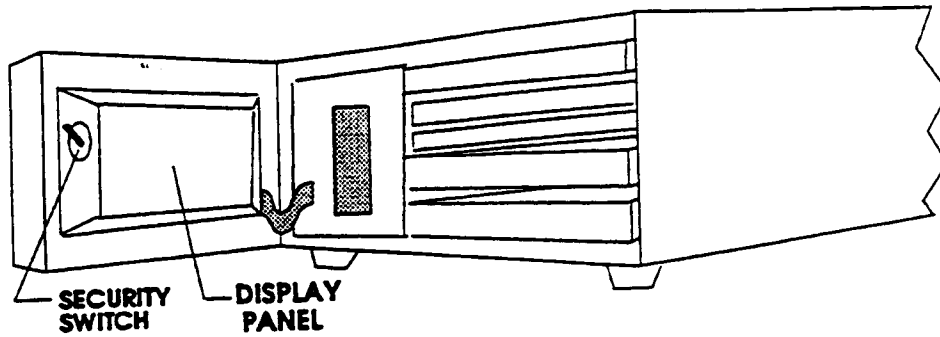

Figure 4.7 The DP95, with Front Panel Open and Cutoff Switch Highlighted.

Level 3. This security level uses the precautions of level two, but in addition uses seals on the screws to provide a visual indicator of tampering. These seals can be calibration stickers (which self destruct if removed) applied to either or both of the screws on the front panel.

The probe configuration can also be changed via the IEEE-488 communications port (but not through the RS232C port). A password on the computer connected to the DP95 or in the software used to access the DP95 would provide the needed security in this case.









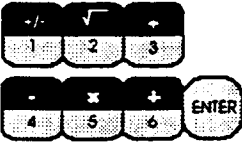

4.4 Configuration Display Precision











The measurements of the DP95 can be displayed in four units: Ω , K, $^{\circ}\text{C}$, and $^{\circ}\text{F}$, as well as the Delta 1-2 measurement. Each of these units can have the precision with which they are displayed changed for each probe on the DP95. All of the displays default to 000.000, but can be reprogrammed in the step-by-step manner shown below.

The example below will show all of the displays for probe #1 being changed from 000.000 to 0000.00. If you wish to configure a different probe than #1, substitute that probe's number for the "1" entered in step number nine.

Steps 13 through 20 are where the display precision is actually changed. "DISP", "DV1", "DV2", and "DV3" correspond to the " Ω ", "K", "C", and "F" keys on the DP95's front panel. Therefore, altering the "DISP" display option will affect how the " Ω " key displays its information.

Step #	Left Disp.	Center Display	Right Display	Keys to press	Comments
1					Apply the configuration panel to the front of the DP95
2				SHIFT ENTER	Enter Configuration mode
3			PRB?	NO	Press "NO" until you see SYS?

Step #	Left Disp.	Center Display	Right Display	Keys to press	Comments
4			SYSP		Yes, this is the mode you want.
5		"000000"	CODE		Enter the access code "123456"
6			USR?		Select the user channel.
7			OLD?		This is an old channel.
8			CFG?		You want to configure the old channel.
9	"_ "		WCHN		Select probe # (in this case, you are selecting 1, you want to configure probe 2 or 3 or 4, etc.).
10	"01"		NRM?		Press "YES".
11	"01"		DRT?		Press "YES".
12	"01"	"04"	PEHI		Press the down arrow key until "DISP" appears in the right window.
	"01"	"000.000"	DISP		
At this point, you should make the display look the way you want the final display to appear. In this example, we are going to make all of the displays show 0000.00 (i.e. four digits before the decimal place, and two digits after.)					
13	"01"	"000.000"	DISP		Remove the rightmost zero from the display by pressing "CE".
14	"01"	"000.00"	DISP		Accept the DP95's display as shown.

Step #	Left Disp.	Center Display	Right Display	Keys to press	Comments
15	"01"	"000.000"	Div 1		Remove the rightmost zero from the "K" display.
16	"01"	"000.00"	Div 1		Accept the new display.
17	"01"	"000.000"	Div 2		Remove right zero from "C".
18	"01"	"000.00"	Div 2		Confirm new "C" setting.
19	"01"	"000.000"	Div 3		Remove the rightmost zero from the display for "F".
20	"01"	"000.00"	Div 3		Accept the new display setting for "F".
21	"01"		END		Go one step past "END" to save data.
22	"01"		ALM?		Exit user channel setup.
23			EXT?	 or 	If you want to configure the displays for other probes, press "NO" and go back to step 6. Otherwise press "YES"
24			PANL		Remove the configuration panel.

Chapter 5

Operating Instructions

5.1 Performing the Self-Test

When you have finished configuring the DP95, and have removed the configuration panel, the unit automatically performs its self-test. During the test, all segments of each LED will be activated, showing a combination of 8's and star bursts across the display. When the test is completed, the right most section of the display should display "PASS". This indicates that the system's self-test has determined the DP95 to be in working order, and ready to be used. The self-test may also be activated at any time by depressing the SELF TEST key on the front panel. If the DP95 (with IEEE-488 interface) is in NSA mode, this key will not work. Refer to Section 6.4.2 to change to SA (Stand Alone) mode.

5.2 Reading a Temperature

If you wish to read a temperature from probe #1, use the following procedure:

1. Make sure the probe you are using is connected to the probe #1 inputs on the back of the thermometer. (Refer to Chapter 4 for proper Probe installation, and for Configuration of the Probe.)
2. Depress the READ PROBE 1 key. The panel will display "1" under PROBE NO.
3. The DP95 front panel (Figure 5.1) will now display a reading in ohms. By depressing one of the other units keys (°C, °F, or K) you can see the reading converted to the units of choice.

If you wish to read a temperature from probe #2, #3 or #4, use the following procedure.

1. Make sure the probes you are using are connected to the correct probe inputs on the back of the thermometer. (Refer to Chapter 4 for proper Probe installation, and for Configuration of the Probe.)
2. To obtain a reading from probe #2, press the "NEXT PROBE" key. The panel will display "2" under "PROBE NO."
3. The DP95 front panel will now display a reading in ohms. By depressing one of the other units keys (°C, °F, or K), you can see the reading converted to the units of choice.
4. To obtain a reading from probe #3, press the "NEXT PROBE" key. The panel will display "3" under "PROBE NO."
5. The DP95 will display a reading in ohms. Again pressing one of the other units keys, you will see the reading converted to the units selected.
6. To obtain a reading from probe #4, press the "NEXT PROBE" key. The panel will display "4" under "PROBE NO."

7. Again, the DP95 will display a reading in the previously selected default units. Selecting one of the other unit keys, you will see the reading converted to the units selected.
8. Once you have selected the units you wish to see most often, you may set those units as the default units by depressing the SET PROBE UNITS key. Now whenever you ask the DP95 to read the temperature of the probe, it will display the units you have chosen. You may, however, still display any of the other units by depressing the appropriate units key. If you wish to change default units, simply depress the SET PROBE UNITS key while the display displays the reading in new units of choice.

NOTES

When the Ohms only selection is made through the configuration panel for Probe # 1, depressing the READ PROBE 1 key will provide a reading in ohms. Other display units are not available since only ohms are measured.

Even while the display is frozen on a selected probe #, the DP95 continues scanning all connected probes.

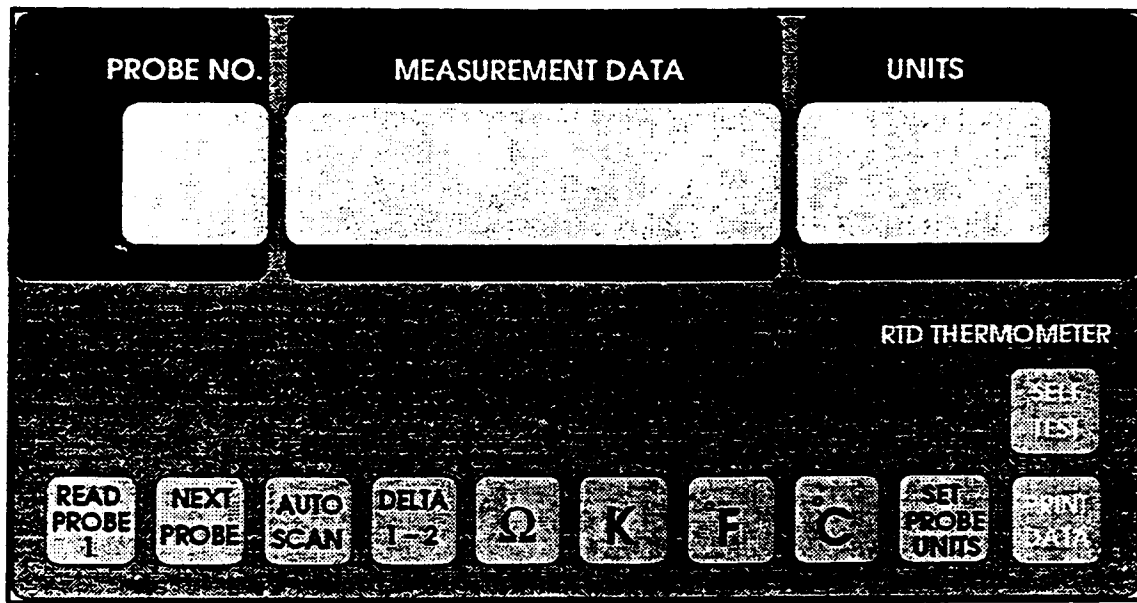

DISPLAY WINDOWS	
MEASUREMENT DATA	A display of the temperature reading.
PROBE NO.	The probe currently being displayed.
UNITS	Indicating the units of displayed data: K = Kelvin; C = Celsius; F = Fahrenheit; Ω = Resistance.
FRONT PANEL KEYS	
READ PROBE 1	MEASUREMENT DATA will display the reading for the probe connected to Probe #1 inputs.
NEXT PROBE	This key will display reading of each probe, sequentially.
AUTO SCAN	MEASUREMENT DATA will display the value from each probe for 2 seconds then move to the next probe.
DELTA 1-2	MEASUREMENT DATA will display the difference between the value of Probe #1 and the value of Probe #2.
Ω	Used to display the measurement in Ohms Units.
K	Used to display the measurement in Kelvin.
$^{\circ}$F	Used to display the measurement in Fahrenheit.
$^{\circ}$C	Used to display the measurement in Celsius.
SET PROBE UNITS	Used to change the default units. Select the desired units by depressing a units key then "lock" in the scale by pressing this key.
PRINT DATA	Used to send readings to a data logging printer via the Com. Port.
SELF TEST	Used to perform a self test of the instrument.

Figure 5.1 Front Panel of the DP95 Thermometer

5.3 Using Autoscan

When the AUTOSCAN key is depressed, the DP95 displays the value read from each probe for two seconds, and then moves to the next probe. Each value is displayed in the default units for that probe.

5.4 Using Delta 1-2

When the DELTA 1-2 feature is used, the DP95 displays the difference between the value being read on Probe # 1 and the value being read on Probe # 2. To use the feature:

1. Set the default units for both probes to a desired unit.
2. Depress the DELTA 1-2 key. The difference will be displayed in the default units, but may be converted to any of the other units by depressing the appropriate units key.

NOTE: Even if the default units are not the same for both probes, the difference can be displayed in °C, °F, K, or ohms.

If the default units for one or both probes are defined as Ohms, then the DELTA 1-2 key will not provide a reading.

5.5 Printing a Reading

Readings may be printed on the data logging printer (when connected) by depressing the PRINT DATA key. The DP95 then sends a preformatted heading and reading, as shown in Figure 5.2 to its communication port for transmission to the printer. If the DP95, with IEEE-488 interface, is in NSA (Not Stand Alone) mode, this key will not work. Refer to Section 6.4.2 to change to SA (Stand Alone) mode.

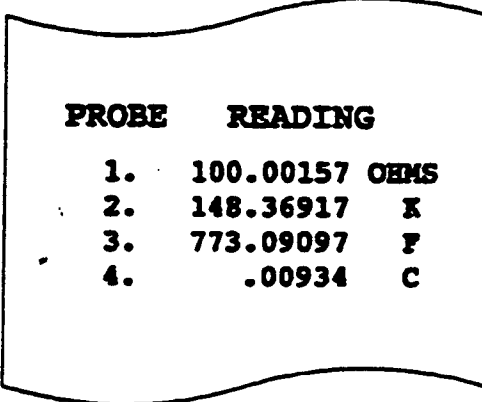

PROBE	READING	
1.	100.00157	OHMS
2.	148.36917	K
3.	773.09097	F
4.	.00934	C

Figure 5.2 Printout From Data Logging Printer

5.6 Using the Analog Output

The analog output on the back panel of the DP95 is used to provide trending information on the reference probe. A device such as a strip chart recorder is typically connected to the output. The analog output (in mV) will equal the temperature (in °C) of Probe # 1.

5.7 DP95 Communication Configurations

The DP95 can have:

1. No communication Interface, or
2. RS-232C Communication Interface, or
3. IEEE-488 (GPIB) Interface.

5.7.1 No Communication Interface

If there is no communication interface for the DP95, it will not be able to communicate with any other peripheral including a printer. The instrument can only be used as a stand-alone meter and all readings will have to be observed from its front panel.

5.7.2 Using the RS-232C Communication Interface

For the RS-232C Communication Interface, the four pins which are used on the DB25 25 Communication Port connector are:

System Ground	Pin 1
Signal Ground	Pin 7
Data Send	Pin 3
Data Receive	Pin 2

The DP95 supports X-ON/X-OFF protocol.

If you wish to connect the DP95 to a computer or a printer, the following are the communication parameters for the interface:

Flow Control:

X-ON/X-OFF

Serial Line Parameters:

Baud Rate: 1200

Parity: Even

Length: 7 bits

Stop Bits: 2

Commands Supported by RS-232 Interface

The following commands can be sent to the DP95 either through a program (see attached sample program) or through a terminal emulation program. (eg., TERM or PRO COMM). The commands should be terminated by a carriage return <RETURN>. The DP95 will respond with a CMD ERR to any improper command.

Before sending commands, confirm that you have established communication with the DP95 by sending it a carriage return <RETURN> and receiving back a prompt '>'.
>

DSPnn : where nn is (01, 02, 03, or 04) the probe number, or 05 for the DELTA 1-2 channel.

The DP95 will return the set (default) value and units of nn probe.

Example: If probe 01 has set probe units of OHMS, DSP01 will return 108.10934 OHMS

VALnn : where nn is (01, 02, 03, or 04) the probe number, or 05 for the DELTA 1-2 channel.

The DP95 will return only the value in set (default) units of nn probe.

Example: If probe 1 measures 108.10934 ohms, sending VAL01 will return 108.10934

YMD

YMD transmits the current day and date.

Example: September 1, 1992

DAY

DAY transmits the current day of the week.

Example: Friday

TIM24

TIM24 transmits the current time.

Example: 4:32:54 p.m.

CLK

You can set the clock remotely from the computer. CLK=YY:MM:TT:dd:hh:mm:ss, where:

YY	=	the last two digits of the year (00-99)
MM	=	the month (01-12)
TT	=	the day (01-31)
dd	=	the day of the week (SU, MO, TU, WE, TH, FR, or SA)
hh	=	the hour (00 - 24) in 24 hour format)
mm	=	the minutes (00-59)
ss	=	the seconds (00-59)

The clock settings will revert to the default on power up.

Sample Program

The following is a sample program that can be used to access the DP95.

```
1 'THIS PROGRAM DISPLAYS THE READINGS OF PROBES 1, 2
2 'AND THE DIFFERENCE BETWEEN READINGS OF PROBES 1 & 2.
10 OPEN "COM2:1200,E,7,2" AS #1
20 FOR I=1 TO 5
30 PRINT #1, "DSP01"
31 INPUT #1, A$
32 PRINT RIGHT$(A$,14)" PROBE #1"
35 PRINT #1, "DSP02"
36 INPUT #1, B$
37 PRINT RIGHT$(B$,14)" PROBE #2"
40 PRINT #1, "DSP05"
41 INPUT #1, C$
42 PRINT RIGHT$(C$,14)" DELTA 1-2"
60 NEXT I
```

5.7.3 Using the IEEE-488 Communication Interface

The IEEE-488 Communication Interface provides you with the maximum communications capability with the DP95. The instrument can be configured to operate as a STAND-ALONE meter. In other words all the front panel keys are operable and you operate the instrument from the front panel keys. A printer can be connected to the IEEE-488 port to print readings, by pressing the "PRINT DATA" key on the panel.

The instrument can also be configured for "NOT STAND-ALONE" OPERATION. This allows maximum interface between the unit and a controller through the IEEE-488 interface. Chapter 6 explains this operation in more detail.

Notes

Chapter 6

IEEE-488 Data Interface

6.1 What You Can Do With the IEEE-488 Interface

When the DP95 is equipped with the "IE" option, it is directly compatible with the industry-standard IEEE-488 / HP-IB / GPIB data communication format. As such, high speed bi-directional data communication between the DP95 and your controller is available. This means that essentially all front panel key functions of the DP95 can be executed under program control and in addition, specific probe set-up data can be "down loaded" from your controller into the memory of the DP95. Furthermore, stored, measured or computed values can be requested by the controller from the DP95.

This bi-directional data capability, i.e., the capability of the DP95 to function as a "listener" or a "talker", makes fully automatic operation under program control possible.

Specifically, using your controller, you can do the following:

Program the probe coefficients such as Ro, Alpha, Delta, etc. for each probe.

1. Read probe measurements for any probe in any of the four engineering units: Ohms, Kelvin, Degrees C or F.
2. Read the delta function in any units.
3. Read previously programmed probe coefficients for verification.

With the above capabilities, completely automated measurement and calibration systems using the DP95 can be implemented.

6.2 IEEE-488.2 Compliance

The syntax of the commands has been constructed to comply with the DRAFT specification of IEEE-488.2 wherever possible. Beyond that, primary consideration has been given to the following:

1. Making simple commands which more or less duplicate the front-panel functions.
2. Making command responses numeric in nature when the primary use of the response will be to make a decision.
3. Making exception handling uniform but flexible to accommodate different applications.

When a controller is reading probe values or directing the storage of a set of readings, its decision-making tasks consist of either decoding integer values (e.g., "What does a status code of 12 mean?"), or converting numeric display values for display and comparison.

In addition, the controller must be able to dispose of multiple lines of text, each terminated by a line-feed character. The end of data is indicated by a single line-feed transmitted with the EOI bit set.

Also, when programming or querying the probe configuration, the controller must be prepared to transmit or receive a single line of data which contains all the information of interest about a particular probe. The response to a valid probe configuration query is always a valid command itself, which simplifies both the task of learning the commands, and of configuring / reconfiguring the instrument, since the configuration for a probe and the command necessary to reconfigure it are one and the same.

Commands which generate a response from the DP95 always contain a "?" character (**Note:** The IEEE-488.2 syntax specification for such queries requires that the arguments, if any, FOLLOW the question mark; this goes against the more natural English-language convention of placing the question mark at the end of the query.) Those not containing this query indication simply instruct the instrument to perform an operation, or to accept programming data. Responses are always directly displayable (i.e., no binary or floating point data is returned), and consist of multiple fields in the form of comma-separated elements for easy data value separation.

6.3 IEEE-488 Specifications and Functions

The DP95's IEEE bus interface meets IEEE Standard 488-1978 requirements and is compatible with HP-IB and GPIB instruments. The bus interface uses the IEEE Standard 24 pin connector with metric (black) studs.

The DP95's IEEE-488 bus interface supports the following functions:

CODE	DESCRIPTION
SH1	Source Handshake
AH1	Acceptor Handshake
T5	Talker
L3	Listener
SR1	Service Request
DC1	Device Clear
RL1	Remote / Local
PP0	Parallel Poll
DT0	Device Trigger
C0	Controller

NOTE: The factory configuration for the DP95 is set with a listener and talker address of 00.

6.3.1 Message Terminators

The DP95 accepts either the "newline" character (a linefeed) or any character sent with EOI as a message terminator. When sending data, the instrument always terminates a response with a "newline" character concurrent with EOI.

6.3.2 Receiver and Transmitter Queues

The receiver queue, for accepting commands from the 488 interface, is 80 characters long. Once the receiver queue is full, the subsequent characters are lost until space is available in the queue. The transmitter queue is 100 characters long.

6.3.3 Delay Times Between Commands and Responses

Almost all of the commands respond within 0.1 to 0.2 seconds except as noted below:

CAL?n and CALREPORT?n respond in about 2 to 3 seconds.

STORE?, OMIT?n, USE?n and PROGRAM respond in about 1 second.

PROGRAMEND and TEST? can take about 4 to 5 seconds to respond.

6.3.4 ESR and STB Register Status Bits

The DP95 IEEE-488 interface defines the contents of the ESR register as follows:

Bit		Meaning
0	OPC	operation complete
1	RQC	request control - not used
2	QYE	query error
3	DDE	device dependent error - not used
4	EXE	execution error
5	CME	command error
6	URQ	user request - not used
7	PON	power on

The contents of the STB register are as follows:

Bit		Meaning
0		not used
1		not used
2		not used
3		not used
4	MAV	message available in output queue
5	ESB	event summary bit - logical 'OR' of ESE bits.
6	MSS	master summary status - logical 'OR' of STB bits.
7		not used

The bits are interpreted as outlined in the DRAFT IEEE-488.2 specification.

6.4 Addressing And Configuring The DP95 For Your Controller

The IEEE-488 Interface Standard requires that every instrument which is connected to the bus has a specific address. Those instruments which can "talk" and "listen" may have a talker address and a listener address. Since the DP95 can talk as well as listen, both addresses must be set before communication with the bus can begin. The DP95 does not have mechanical dip switches or jumpers for address selection, but rather the addresses are programmed by Front Panel keyboard entry into a section of the instruments non-volatile EEPROM memory.

6.4.1 Setting Up The Address

To set the addresses, proceed according to the following sequence:

Disconnect any IEEE-488 cable from the instrument and turn the AC power on. Wait until the instrument has Passed the Self Test and is in the measurement mode.

1. **Apply the Configuration Panel to the front panel keyboard.**
2. **Press the SHIFT and then the ENTER key.**

If your DP95 configuration mode is enabled (i.e. the switch on the inside of the front panel is in the UP position), the alphanumeric display will respond briefly with "WAIT" and then with "PRB?".

3. **Press the NO key.**

The display will respond with "488?".

4. **Press the YES key.**

The display will respond with either "NSA?" or with "SA?".

5. **Press the NO key until the display shows "NSA?"**

6. **Press the YES key.**

The display will respond with "XX MTA" where XX represents the two digit decimal talk address. (MTA stands for My Talk Address).

To enter the two digit address:

7. **Enter any two digits between 00 and 30 on the Numeric keys.**

For example, to set address number 7, enter "0" and "7". If an error is made on entry, use the CE key to clear the entry or enter the correct address again.

8. **Press the ENTER KEY after the desired address is displayed.**

The display will respond with "XX MLA" where XX represents the two digit listener address. (MLA stands for My Listener Address).

9. **Follow Steps 7 and 8 above to enter the MLA Address.**

The display will respond with "PRB?".

10. **Press the EXIT key, then the YES key.**

11. **Remove the Configuration Panel**

After the instrument completes the Self Test, it will enter the measurement mode.

NOTE: Only the display function keys are active when the instrument is operated on the IEEE-488 bus. All other keys are in-operative.

ALSO NOTE: The IEEE-488 Programming mode cannot interrupt the front panel configuration mode but the front panel configuration mode is not deactivated during IEEE-488 bus operation. To fully secure the configuration parameters, open the front panel via the two Phillips head screws and flip the switch on the back of the front panel door to the DOWN position. This disables the Configuration Panel. Then close the door and position seals over the screws. In this manner, critical Reference Probe parameters can only be entered or altered via the IEEE-488 bus.

6.4.2 Changing the DP95 to Stand Alone Configuration

Following are the instructions for changing the instrument to a Stand Alone mode:

1. Turn the AC power on, wait until the instrument has passed the Self Test and is in the measurement mode.
2. Apply the Configuration Panel to the front panel keyboard, press the SHIFT key and then the ENTER key. If your DP95 configuration mode is enabled (i.e., the switch on the inside of the front panel is in the UP position), the alphanumeric display will respond briefly with "WAIT" and then with "PRB?". If not, refer to Chapter 4 for instructions on how to enable the switch.
3. Press the NO key and the display will respond with "488?".
4. Press the YES key and the display will respond with either "NSA?" (Not Stand-Alone?) or with "SA?" (Stand-Alone?).
5. Press the NO key until the display shows "SA?". (This is the abbreviation for: "Do you want the Stand Alone mode?").
6. Press the YES key, then the EXIT key, then the YES key again and remove the Configuration Panel.
7. Wait until the instrument has passed the Self Test and entered the measurement mode. The instrument is now in the Stand Alone Mode. You are now ready to connect the IEEE-488 printer and use the front panel PRINT DATA key to activate your printer.

If the instrument is used in the NSA (Non Stand Alone) mode, there are two keys on the front panel that will not operate:

SELF TEST
PRINT DATA

6.4.3 Number Representations

The DP95 IEEE-488 interface accepts numeric input in various formats. The restrictions placed on numeric input are as follows:

Floating point / fixed point representations are not allowed when the destination is explicitly an integer, as is the case, for example, with the status register masks.

Floating point / fixed point representations must conform to the same rules applied during configuration panel entry of probe constants (specifically, these have to do with the number of significant digits and the representation of non-displayable numbers). For example, the following numbers are all valid floating point representations:

1

1.0

+1.0

1.000000000000

1.23456123456E0

-1.23456123456E-1

0000000000000000000001. (leading zeros are ignored).

The following are INVALID floating point representations, either for obvious reasons or for the reason given:

-1234561.23456E01 (too many integer digits in mantissa)

E-1

-2.23456123456E-02 (not displayable from the front panel)

.E0

1.000000000000 (too many zeros)

6.5 Specific DP95 IEEE-488 Command Summary

Commands for the DP95 IEEE-488 Interface fall into three specific groups:

MEASUREMENT Mode Commands

Programming Mode Commands

IEEE Specific Commands

6.5.1 Measurement Mode Commands

These commands are used when the instrument is in the MEASUREMENT mode. A typical example is the READ command which is used to read the measured data for a probe.

Command	Purpose
READ?	Read Probe Data
CFG?	Read Probe Configuration
PROGRAM	Start Programming Mode

READ

SYNTAX: Read? <probe#>, <units>

<probe#> Probe numbers 1,2,3, or 4.
NOTE: Delta is Probe #5

<units> units (C, F, K or OHMS)

RESPONSE: <status>, <value>, <units> ,

<status> 3 digit code.
000 Response is valid
001 Inactive Probe
002 Probe not configured
003 Probe overrange
004 Probe underrange
005 Probe value not displayable
006 Requested units not available

<value> Value similar to the front panel display for the probe with 2 additional digits after the decimal point. Note that the two additional digits represent a running statistical average and are not indicative of additional precision.

<units> Either C
or F
or K
or OHMS
or OR
or UR

EXAMPLE Command READ? 2, K

Response 000, 394.56342, K

CFG

SYNTAX: CFG? <probe#>

<probe#> Probe numbers 1,2,3, or 4.

RESPONSE: Possible responses are:
OHMS
<std type>,<r0>
CVD,<r0>,<alpha>,<delta>,<beta>
T68, <r0>,<alpha>,<delta>,<a4>,<c4>

Command	Purpose
PROGRAMEND	Exit Programming Mode
CFG	Configure Probe

NOTE: The Programming mode is entered by giving the PROGRAM command when the instrument is in the MEASUREMENT mode.

PROGRAMEND

SYNTAX: PROGRAMEND

RESPONSE: none

CFG

SYNTAX: One of the following:

```
CFG <probe#>,OHMS
CFG <probe#>,<std type>,<r0>
CFG <probe#>,CVD,<r0>,<alpha>,<delta>,<beta>
CFG <probe#>,T68,<r0>,<alpha>,<delta>,<a4>,<c4>
CFG <probe#>,T90(X1,X2),<Ro>,<C1>,<C2>,<C3>,...ETC.
CFG <probe#>,T90*,<Ro>,<ALPHA>,<DELTA>,<A4><>C4,
```

EXPLANATION:

In many cases only one value is to be changed in the entire string. Constants can be skipped by eliminating the value and entering a comma ",". Coefficients that are skipped are not changed. For example, to only change Ro, enter the following:

```
CFG 1,T90(0,5),100.66,,,
```

This would set probe 1 for ranges A5 and B5. It would change the value of Ro to 100.66 and not change the A5, and B5 constants.

<std type> STD_3850, STD_3900, STD_3916, or STD_3922

EXAMPLES

```
CFG 1,T90(0,5),100.055,123.456E-2,321.543-3
```

This would set probe 1 for the coefficients A5 and B5. The coefficient values would be as follows.

```
Ro = 100.055
A5 = 123.456E-2
b5 = 321.543e-3
```

```
CFG 1,T90(4,0),100.055,0.90036E-2,215.543E-3
```

This would set probe 1 for the coefficients A4 and B4. The coefficient values would be as follows:

```
Ro = 100.055
A4 = 0.90036E-2
B4 = 215.543-3
```

RESPONSE: none

6.5.3 IEEE Specific Commands

These commands are active in the MEASUREMENT and PROGRAMMING mode and support IEEE-488 System requirements.

Command	Purpose
*IDN?	Identification
*RST?	Reset
*WAI	Wait
*CLS	Clear status
*TST?	Self test
*OPC	Operation complete command
*OPC?	Operation complete query
*ESE n	Set event status enable register
*ESE?	Read event status enable register
*SRE n	Set service request enable register
*SRE?	Read service request enable register
*STB?	Read status byte register

IDN (IDeNtification)

SYNTAX: *IDN?

RESPONSE:

<company name>	OMEGA Engineering, Inc.
<model>	DP95
<ser num>	Serial Number, Default = "0"
<firmware #>	Software Version Number

RST (ReSeT)

SYNTAX: *RST?

RESPONSE: none

WAI (WAI)

SYNTAX: *WAI

RESPONSE: none

CLS (CLearStatus)

SYNTAX: *CLS

RESPONSE: none

TST (self TeST)

SYNTAX: *TST

RESPONSE: <status>

<status> Value from 000 to 015. Indicates the probes which are active. This is a byte value.
BIT 0 set means probe 1 active
BIT 1 set means probe 2 active
BIT 2 set means probe 3 active
BIT 3 set means probe 4 active

OPC (OPeration Complete)

SYNTAX 1: *OPC

RESPONSE: none

SYNTAX 2: *OPC?

RESPONSE: <opc status>

<opc status> 1 (operation complete)

ESE (Event Status Enable)

SYNTAX 1: *ESE <ese value>

<ese value> Event status enable register value to be set.

RESPONSE: none

SYNTAX 2: *ESE?

RESPONSE: <ese value>

<ese value> Event status enable register value.

SRE (Service Request Enable)

SYNTAX 1: *SRE <sre value>

<sre value> Service request enable register value to be set.

RESPONSE: none

SYNTAX 2: *SRE?

RESPONSE: <sre value>

<sre value> Service request enable register value.

STB (SStatus Byte)

SYNTAX: *STB?

RESPONSE: <stb value>

<stb value> Status byte register value.

6.6 IEEE-488 Commands for ITS 90

The DP95 will support the IEEE-488 commands for ITS90 and T90*. These commands are similar to existing commands for the IPTS68 or CVD temperature standards.

The IEEE commands to support T90* are similar in form to the IPTS68 commands. T90* will be substituted for T68 in the command or in the response.

The IEEE commands to support ITS90 temperature standard differs from the other commands in that ITS90 supports multiple temperature ranges. Each temperature range in the ITS90 temperature standard is defined by specific constants for that range (see Table 4.1). These temperature ranges are selected by specifying the numeric value of the coefficients. In all the ITS90 IEEE commands, T90 is followed by (X1,X2) where X1 indicates the negative temperature range and X2 indicates the positive temperature range. The "(" and ")" must be included.

X1 =	0	Negative temperature range not selected.
	4	Corresponds to A4 and B4.
X2 =	0	Upper temperature range not selected.
	5	Corresponds to A5, B5
	6	Corresponds to A6, B6, C6, D6
	7	Corresponds to A7, B7, C7
	8	Corresponds to A8, B8
	9	Corresponds to A9, B9
	10	Corresponds to A10
	11	Corresponds to A11

NOTE: X1 and X2 cannot both be zero.

Chapter 7

Maintenance and Service

7.1 Introduction

In order to maintain the highest possible accuracy of your DP95, periodic checking and if necessary recalibration of the equipment should be performed. Sections 7.1 and 7.2 will explain how to verify that the DP95 is within the standards for accuracy, and how it can be recalibrated if it is not within those limits.

7.2 Performance Verification

The accuracy of an RTD input card can be measured by checking the resistance that the input card measures when a standard resistor, whose resistance is known, is connected to the input. If the measurement displayed by the DP95 is within a certain tolerance level shown below, it does not need to be calibrated.

1. Turn on the DP95 and allow it to warm up for six to eight hours.
2. Connect a standard resistance in the input card's measurement range (see Table 7.2) to the probe 1 input.
3. Read the measured resistance by pressing the "Ω" key and the "NEXT PROBE" key.
4. Compare the reading shown in the Measurement Data window with the value of the resistor connected. The two values should be within the uncertainty of the resistor plus the value shown in Table 7.1. If they are not, then the RTD input card needs to be recalibrated.

Table 7.1
Maximum allowable deviations from resistor values

RTD Probe Input Type	Deviation from Displayed Value
RT40	0.0010Ω
RT41 / RT31	0.004Ω
RT42 / RT32	0.008Ω
RT43 / RT33	0.02Ω
RT44 / RT34	0.04Ω
RT45	0.002Ω
CT40	0.0005Ω
CT41 / 31	0.002Ω
CT42 / 32	0.004Ω
CT43 / 33	0.01Ω
CT44 / 34	0.02Ω
CT45	0.001Ω

7.3 Recalibration

7.3.1 Theory

The recalibration of the DP95 is done at two resistances called R_{low} and R_{high} . These resistances correspond to the points X_1 and X_2 shown in Figure 7.1. The point on the Y axis marked Y_1 is what the DP95 measures when the resistance R_{low} is applied across the probe input terminals. Y_2 is the value measured when R_{high} is attached across the input terminals.

Drawing a line through two points in an X-Y coordinates system, you can define the line with the equation:

$$Y = MX + B \quad (\text{Eq. 1})$$

Where M is defined as the slope of the line, and B is the value of Y at $X=0$. By taking two equations, one for each of the points plotted on the chart, you can solve for M .

$$Y_1 = MX_1 + B \quad (\text{Eq. 2})$$

$$Y_2 = MX_2 + B \quad (\text{Eq. 3})$$

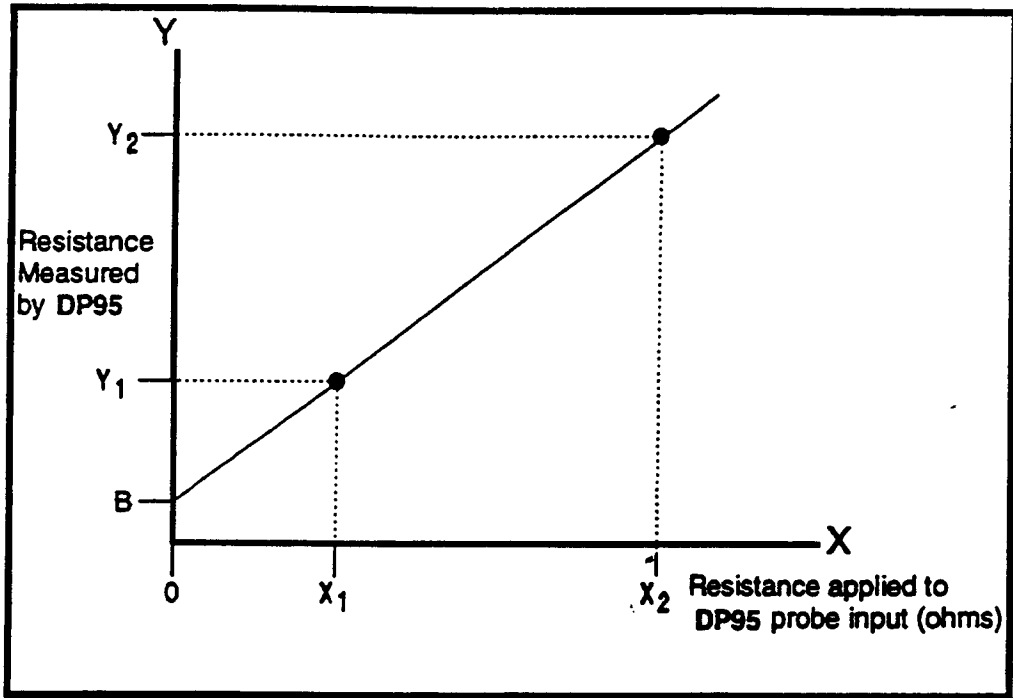

Figure 7.1 X-Y Coordinates System for Calibration

If you solve for B you find:

$$B = Y_1 - MX_1 = Y_2 - MX_2 \quad (\text{Eq. 4})$$

Therefore:

$$Y_1 - MX_1 = Y_2 - MX_2 \quad (\text{Eq. 5})$$

and

$$Y_2 = Y_1 - M(X_1 - X_2) \quad (\text{Eq. 6})$$

By solving the two simultaneous equations, you find:

$$M = \frac{Y_1 - Y_2}{X_1 - X_2} \quad (\text{Eq. 7})$$

and:

$$B = Y_1 - MX_1 \quad (\text{Eq. 8})$$

or:

$$B = Y_1 - \left(\frac{Y_1 - Y_2}{X_1 - X_2} \right) X_1 \quad (\text{Eq. 9})$$

Table 7.2
Recommended calibration values for input modules

RTD Probe Input Type	R _{low} Ω	R _{high} Ω
RT40	25	65
RT41 / RT31 / CT41 / CT 31	100	250
RT42 / RT32 / CT42 / CT 32	200	500
RT43 / RT33 / CT43 / CT33	500	1500
RT44 / RT34 / CT44 / CT34	1000	3000
RT45 / CT45	50	130

With these two equations, you can calculate all of the values needed to calibrate the DP95.

7.3.2 Choosing Calibration Points

It is necessary to pick two points in the RTD Input card's measurement range to use in the calibration procedure (i.e. pick values for X1 and X2 in Figure 7.1). OMEGA recommends that the calibration be performed using resistances which simulate 0° C and 400° C since this covers the most widely used temperature ranges, and resistors of these values are more widely available. Table 7.2 shows the commonly used calibration points for the different DP95 input modules. Alternatively, two points, from the measurement range of interest to the user can be chosen. Table 7.4 gives the values of the resistors to use to simulate different temperatures. Located on the left side of the table is the temperature that you want to simulate. Across the top is the usual probe resistance for your system. The numbers in the table are the values of the resistor you would use to simulate the desired temperature.

7.3.3 Recalibration Procedure

The following section provides step-by-step procedures to follow in order to recalibrate the DP95. Two examples are provided, one where R_o is 100 Ω and one where R_o is 25 Ω. You should follow the procedure that most closely matches your unit's RTD inputs, although the procedure is the same for any of the input probe types.

The unit should be turned on for the minimum warm up period and all precautions should be followed.

The recalibration process, briefly, is broken down into six steps:

Enter the system mode of the DP95 and record the I/O channel's value for M and B. These values will be referred to as M_{old} and B_{old}. Also, change the user channel M from 1.00000 E 00 to the proper value shown in Table 7.3 (note that this does not have to be done for the model RT40 and RT30 input boards). This value will be referred to as M_{temp}.

Table 7.3
Values for M_{temp}

RTD Input Type	M _{temp} (USER Channel)
RT40 / RT30 / RT45 / CT 45	1.00000 E 00
RT41 / RT31	3.00000 E 00
RT42 / RT32	1.50000 E 00
RT43 / RT33	0.60000 E 00
RT44 / RT34	0.30000 E 00

Table 7.4
The RTD range table

Temp. to be simulated	Resistor value to use to simulate temperature, based on nominal probe Ω				
	25 Ω	100 Ω	200 Ω	500 Ω	1000 Ω
$^{\circ}\text{C}$					
-200	5	20	40	100	200
-100	15	60	120	300	600
0*	25	100	200	500	1000
100	35	140	280	700	1400
200	45	180	360	900	1800
300	55	220	440	1100	2200
400*	65	260	520	1300	2600
500	75	300	600	1500	3000
600	85	340	680	1700	3400
700	95	380	760	1900	3800
800	105	420	840	2100	4200

*These are the most practical calibration points

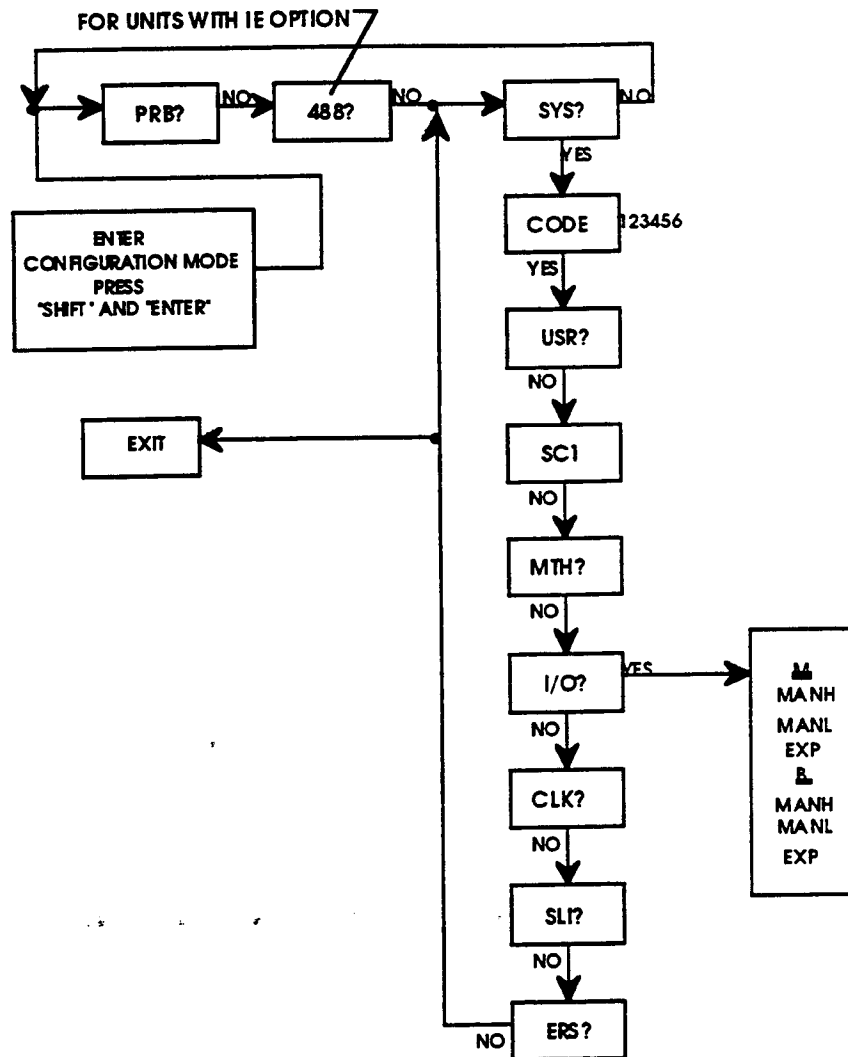

Figure 7.2 Flow diagram for the recalibration process

Exit the system mode and connect the resistor of value R_{low} to the probe input terminals. Record the value measured by the DP95 as $DISPLAY_{low}$. Remove R_{low} and connect R_{high} , and record the measured value as $DISPLAY_{high}$.

Calculate the values for M and B using the following equations:

$$M = \frac{DISPLAY_{high} - DISPLAY_{low}}{R_{high} - R_{low}} \quad (\text{Eq. 10})$$

$$B = DISPLAY_{low} - M \times R_{low} \quad (\text{Eq. 11})$$

Using these values, calculate the new values for M and B to be programmed into the unit:

$$M_{new} = \frac{M_{old} \times M_{temp}}{M} \quad (\text{Eq. 12})$$

$$B_{new} = \frac{(M_{temp} \times B_{old}) - B}{M} \quad (\text{Eq. 13})$$









Enter the DP95's system mode and enter Mnew and Bnew into the I/O channels M and B. Also, change the USER channel M back to its original value of 1.00000 E 00.





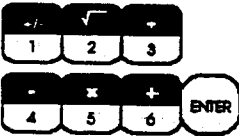









Recalibration is complete, and the main display of the DP95 should now read the value of the applied resistors within the tolerance levels discussed in Chapter 7.2.





7.3.4 Calibration Example 1

This example is for a 4-wire, 100 ohm RTD probe input module. Consulting Table 7.3, you get the value of M_{temp} as 3.0. Two calibration resistors are available: 100.0014Ω and 250.0123Ω.

First, enter the DP95's system mode and read the values for M and B using the following steps:

Step #	Left Disp.	Center Display	Right Display	Keys to press	Comments
1					Apply the configuration panel to the front of the DP95
2				 	Enter Configuration mode
3			PRB?		Press NO until you see SYS?
4			SYS?		You want to enter the system setup.
5		"000000"	CODE		Enter the access code "1 2 3 4 5 6"
6			USR?	  	Press "NO" until I/O is displayed..
7			I/O?		Select the I/O channel.

Step #	Left Disp.	Center Display	Right Display	Keys to press	Comments
			OLD?		The channel already exists.
8			CFG?		You want to configure the channel.
9	" - "		PCHN	  	Enter the probe to be configured: 04 = probe #1 08 = probe #2 12 = probe #3 16 = probe #4
10	"04"		INP?	  ...	Press the down arrow key until "MX+B" appears.
11	"04"		MX+B		Check the MX+B equation
12	"04"		M		Enter I/O channel M.
13	"04"	"2.37635"	MANH		Note the value of the high mantissa down, and press enter. (Note that all of these values are examples only. Write down the number that your DP95 displays).
14	"04"	"417800"	MANL		Note the last 6 digits of the mantissa. The mantissa is 2.37635417800.
15	"04"	" . 03 "	EXPO		Note the exponent.
16	"04"		E-03		Go on to get the value of B.
17	"04"		B		Press ENTER to continue.







Step #	Left Disp.	Center Display	Right Display	Keys to press	Comments
18	"04"	"0.00015"	MANH		Note the first 6 digits of B that the DP95 show you (the value shown is an example only.)
19	"04"	"690000"	MANL		Note the last 6 digits of B.
20	"04"	" 00"	EXPO		Write down the exponent for B. In this example, B is 0.0001569. You are finished retrieving the values of M and B, so press "EXIT".
21			EXT?		Do not exit setup mode.

















You therefore have:

$$M_{old} = 2.37635417800 \times 10^{-03}$$

$$B_{old} = 0.00015690000 \times 10^0$$

Now change the value of M_{temp} with the following procedure:

Step #	Left Disp.	Center Display	Right Display	Keys to press	Comments
1			USR?		Select the user channel.
2			OLD?		This is an old channel.
3			CFG?		You want to configure an old channel.
4	" -"		UCHN	 	Select probe # (in this case, you are selecting 1, you may want to configure probe 2 or 3, etc.).
5	"01"		NRM?		Press "YES"
6	"01"		DAT?		Enter data field

Step #	Left Disp.	Center Display	Right Display	Keys to press	Comments
7	"01"	" 04"	PCHI		Press the down arrow key until "MX+B" appears in the right window.
8	"01"		MX+B		Check the MX+B equation
9	"01"		M		Enter user channel M.
10	"01"	"1.00000"	MFANT		The leftmost digit will fall off.
11	"01"	"000003"	MFANT	 	Add the decimal point.
12	"01"	"000003."	MFANT	    	Move the digit "3" to the leftmost position.
13	"01"	"3.00000"	MFANT		Accept the value of "3.00000"
14	"01"	" 00"	EXPO		Enter exponent "00"
15	"01"	"3.00000"	E 00		Review and accept the values for "M"
16	"01"		B		Press down arrow key until "ALM?" appears.
17	"01"		ALM?		Exit the user channel setup.
18			EXT?		Confirm that you want to exit.
19			PANL		Remove the configuration panel.

In this example, the calibration resistors to be used have values of 100.0014Ω and 250.0123Ω . Therefore, $R_{low} = 100.0014\Omega$ and $R_{high} = 250.0123\Omega$. Your resistors may have different values.

Connect R_{low} to the probe 1 input jacks at the rear of the unit. Turn the unit on and allow it to warm up for 6 to 8 hours minimum. If the input modules were in perfect calibration, the display would read 300.004Ω (three times the resistor value, since you set M_{temp} to 3.0). However, in this example, the display reads 300.087.

So record:

$$DISPLAY_{low} = 300.087$$

$$R_{low} = 100.0014$$

Replace R_{low} with R_{high} . Again, ideally the display would read three times the actual resistor value, or 750.034Ω . However, in this example the DP95 measures 750.196Ω .

Therefore:

$$DISPLAY_{high} = 750.196$$

$$R_{high} = 250.0123$$

Using Equation 10 you calculate:

$$M = \frac{750.196 - 300.087}{250.0123 - 100.0014}$$

$$M = 3.00050863$$

and using Equation 11 you get:

$$B = 300.087 - (3.00050863 \times 100.0014)$$

$$B = 0.031936288$$

You can now calculate M_{new} from Equation 12

$$M_{new} = \frac{(2.376354178 \times 10^{-3}) \times 3.0}{3.0050863}$$















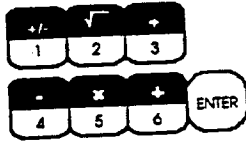

$$M_{new} = 2.37595135100 \times 10^{-3}$$

and B_{new} from Equation 13:









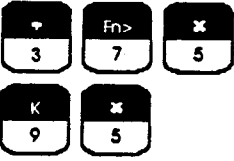
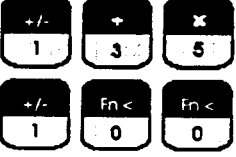















$$B_{new} = \frac{(3.00000 \times 0.0001569) - 0.031936288}{3.00050863}$$





$$B_{new} = -1.048675137 \times 10^{-02}$$

Now, enter the values for M_{new} and B_{new} using the following procedure:







Step #	Left Disp.	Center Display	Right Display	Keys to press	Comments
1					Apply the configuration panel to the front of the DP95
2				 	Enter Configuration mode
3			PRB?		Press NO until you see SYS?
4			SYS?		You want to enter the system setup.
5		"000000"	CODE		Enter the access code "123456".
6			USR?	  	Press "NO" until I/O is displayed.
7			I/O?		Select the I/O channel.
			OLD?		The channel already exists.
8			CFG?		You want to configure the channel.
9	".."		PCHN	  	Enter the probe to be configured: 04 = probe #1 08 = probe #2 12 = probe #3 16 = probe #4
10	"04"		INP?	  ...	Press the down arrow key until "MX+B" appears.

Step #	Left Disp.	Center Display	Right Display	Keys to press	Comments
11	"04"		MX+B	ENTER	Select the MX+B equation to be altered.
12	"04"		M	ENTER	Enter I/O channel M.
13	"04"	"2.37635"	MANH	CE ...	Press the CE key until the entire display is cleared.
14	"04"		MANH		Enter the first digit and the decimal point (note, these values are examples only, use the values you calculated yourself).
15	"04"	" 2."	MANH		Enter the remaining digits of the high mantissa.
16	"04"	"2.37595"	MANH	ENTER	Press enter and accept the new high mantissa for M.
17	"04"	"417800"	MANL		Enter the new value for M's low mantissa.
		"135100"	MANL	ENTER	Accept the new value for M's low mantissa.
18	"04"	"- 03"	EXPO	ENTER	Accept the exponent as is, since it is what you need.
19	"04"	"2.37595"	E- 03	ENTER	Review the new value for M, and accept it by pressing "ENTER"



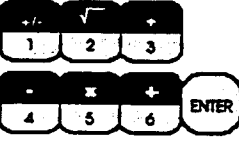

Step #	Left Disp.	Center Display	Right Display	Keys to press	Comments
20	"04"		B		Now change B.
21	"04"	"0.00015"	MANH	 ...	Press the "CE" key until display is clear.
22	"04"		MANH	 	The new high mantissa for B is negative, so enter the negative sign.
23	"04"	"."	MANH	  	Enter the first digit and the decimal point.
24	"04"	" 1."	MANH	    	Enter the remaining digits of the low mantissa.
25	"04"	"-1.0486"	MANH		Press ENTER to accept the low mantissa.
26	"04"	"690000"	MANL	     	Enter the new low mantissa.
27	"04"	"751370"	MANL		Accept the new low mantissa for B.
	"04"	"00"	EXPO	   	Enter the exponent of -2.
28	"04"	" 02"	EXPO		Accept the new value for the exponent.

Step #	Left Disp.	Center Display	Right Display	Keys to press	Comments
29	"04"	"-1.0486"	E--03		Accept the new value for B.
30	"04"	"999999"	+F5C		Press the down arrow key until "OLD?" appears in the right window.
31			OLD?		Exit I/O channel configuration.
32			EXT?		Confirm that you want to exit.
33			PANL		Remove the configuration panel.

Now that the calibration constants have been entered, you have to reset the M user channel back to its value of 1.

Step #	Left Disp.	Center Display	Right Display	Keys to press	Comments
1					Apply the configuration panel to the front of the DP95
2				 	Enter Configuration mode
3			PRB?	 	You do not want to configure a probe.
4			SYS?		Yes, this is the mode you want.
5		"000000"	CODE		Enter the access code "123456".
6			USR?		Select the user channel.
7			OLD?		This is an old channel.



Step #	Left Disp.	Center Display	Right Display	Keys to press	Comments
8			CFG?		You want to configure an old channel.
9	"_"		UCHN		Select probe # (in this case, you are selecting 1, you may want to configure probe 2 or 3, etc.).
10	"01"		NRM?		Press "YES"
11	"01"		DAT?		Enter data field
12	"01"	" 04"	PCHI		Press the down arrow key until "MX+B" appears in the right window.
13	"01"		MX+B		Check the MX+B equation
14	"01"		M		Enter user channel M.
15	"01"	"3.00000"	MAN T		The leftmost digit will fall off.
16	"01"	"000001"	MAN T.		Add the decimal point.
17	"01"	"000001."	MAN T	 	Move the digit "1" to the leftmost position.
18	"01"	"1.00000"	MAN T		Accept the value of "1.00000"
19	"01"	" 00"	EXPO		Enter exponent "00"









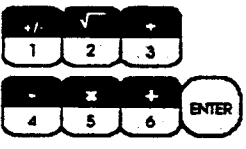







Step #	Left Disp.	Center Display	Right Display	Keys to press	Comments
20	"01"	"1.00000"	E 00		Review and accept the values for "M"
21	"01"		B		Press down arrow key until "ALM?" appears.
22	"01"		ALM?		Exit the user channel setup.
23			EXT?		Confirm that you want to exit.
24			PANL		Remove the configuration panel.

7.3.5 Calibration Example 2

This example is for a four-wire, 25Ω RTD probe input module. Two calibration resistors are used: 24.9994Ω and 65.0003Ω.

First, record the values for M and B that are currently in the DP95.

Step #	Left Disp.	Center Display	Right Display	Keys to press	Comments
1					Apply the configuration panel to the front of the DP95
2					Enter Configuration mode
3			PRB?		Press "NO" until you see SYS?
4			SYS?		You want to enter the system setup.
5		"000000"	CODE		Enter the access code "123456".

Step #	Left Disp.	Center Display	Right Display	Keys to press	Comments
6			USR?	  	Press "NO" until I/O is displayed.
7			I/O?		Select the I/O channel.
8			OLD?		The channel already exists.
9			CFG?		You want to configure the channel.
10	"_"		PCHN	  	Enter the probe to be configured: 04 = probe #1 08 = probe #2 12 = probe #3 16 = probe #4
11	"04"		INP?	  ...	Press the down arrow key until "MX+B" appears.
12	"04"		MX+B		Check the MX+B equation
13	"04"		M		Enter user channel M.
14	"04"	"1.89041"	MANH		Note the value of the high mantissa, and press "ENTER". (Note that all of these values are examples only. Write down the number that your DP95 displays).
15	"04"	"847500"	MANL		Note the last 6 digits of the mantissa. The full mantissa is 1.89041847500.
16	"04"	"_ 03"	EXPO		Note the exponent.
17	"04"	"1.89041"	E- 03		Go on to get the value of B.

Step #	Left Disp.	Center Display	Right Display	Keys to press	Comments
18	"04"		B	ENTER	Press ENTER to continue.
19	"04"	"4.13531"	MANH	ENTER	Write down the first 6 digits of B that the DP95 shows you (the value shown is an example only.)
20	"04"	"000000"	MANL	ENTER	Write down the last 6 digits of B.
21	"04"	"- 03"	EXPO	EXIT	Write down the exponent for B. In this example, B is 4.13531000000. You are finished retrieving the values of M and B, so press "EXIT".
22			EXT ?	NO)	Do not exit setup mode.

Therefore, you have:

$$M_{old} = 1.89041847500 \times 10^{-03}$$

$$B_{old} = 4.13531000000 \times 10^{-03}$$

In this example, the resistor R_{low} is 24.9994 Ω , and R_{high} is 69.0003 Ω . Remember that the actual values you use will be slightly different, depending on what resistors you use.

Consulting Table 7.3, you see that M_{temp} should be set to 1.0 for the RT40 and CT40 input cards. Since M_{temp} defaults to 1.0, you do not need to set it. If you have a different input card, follow the procedure shown in the second half of Section 7.3.4.

You now need to find out how far off the DP95 is in measuring the known resistances you have picked. Connect R_{low} to the probe 1 input on the back of the DP95. Press the Ω key on the front panel if the readings are not already in OHMS. If the DP95 was correctly calibrated, the display would read 24.9994, the value of the resistor attached to the probe input. In this example, however, the DP95 displays 24.9991.

So you have:

$$DISPLAY_{low} = 24.991$$

and

$$R_{low} = 24.9994$$

Replace the resistor R_{low} with R_{high} . The display would now read 65.0003 if the DP95 were correctly calibrated. It isn't, however, and in this example the display reads 65.0016.

So:

$$\text{DISPLAY}_{\text{high}} = 65.0016$$

and

$$R_{\text{high}} = 65.0003$$

With these measurements you can calculate M and B.

Using Equation 10:

$$M = \frac{65.0016 - 24.9991}{65.0003 - 24.9994}$$

$$M = 1.000039999$$

Using Equation 11, you calculate:

$$B = 24.9991 - (1.000039999 \times 24.9994)$$

$$B = -1.299951 \times 10^{-3}$$

With M and B known, you can go on and calculate the values needed to calibrate the instrument:



$$M_{\text{new}} = \frac{(1.890418475 \times 10^{-3}) \times 1.000000}{1.000039999}$$













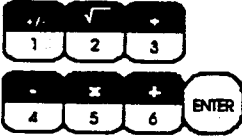



$$M_{\text{new}} = 1.89034286300 \times 10^{-3}$$

$$B_{\text{new}} = \frac{(1.000000 \times 4.13531 \times 10^{-3}) - (-1.299951 \times 10^{-3})}{1.000039999}$$

$$B_{\text{new}} = 5.435043603691 \times 10^{-3}$$

Now that you have M_{new} and B_{new} , you can enter them into the DP95:

Step #	Left Disp.	Center Display	Right Display	Keys to press	Comments
1					Apply the configuration panel to the front of the DP95.
2				 	Enter Configuration mode

Step #	Left Disp.	Center Display	Right Display	Keys to press	Comments
3			PRB?	 	You do not want to configure a probe.
4			SYS?		You want to enter the system setup.
5		"000000"	CODE		Enter the access code 123456.
6			USR?	  	Press "NO" until I/O is displayed.
7			I/O?		Select the I/O channel.
			OLD?		The channel already exists.
8			CFG?		You want to configure the channel.
9	" _"		PCHN	  	Enter the probe to be configured: 04 = probe #1 08 = probe #2 12 = probe #3 16 = probe #4
10	"04"		INP?	  ...	Press the down arrow key until "MX+B" appears.
11	"04"		MX+B		Select the MX+B equation to be altered.
12	"04"		M		Enter user channel M.
13	"04"	"1.89041"	MANH	 ...	Press the CE key until the entire display is cleared.

Step #	Left Disp.	Center Display	Right Display	Keys to press	Comments
14	"04"		MANH		Enter the first digit and the decimal point (note, these values are examples only, use the values you calculated yourself).
15	"04"	" 1."	MANH		Enter the remaining digits of the high mantissa.
16	"04"	"1.89034"	MANH		Press ENTER and accept the new high mantissa for M.
17	"04"	"847500"	MANL		Enter the new value for M's low mantissa.
18	"04"	"286300"	MANL		Accept the new value for M's low mantissa.
19	"04"	"- 03"	EXPO		Accept the exponent as is, since it is what you need.
20	"04"	"1.89034"	E-03		Review the new value for M, and accept it by pressing "ENTER"
21	"04"		B		Now change B.
22	"04"	"4.13531"	MANH		Press the "CE" key until display is clear.
23	"04"		MANH		Enter the first digit and the decimal point.

Step #	Left Disp.	Center Display	Right Display	Keys to press	Comments
24	"04"	" 5."	MANH		Enter the remaining digits.
25	"04"	"5.43504"	MANH		Press "ENTER" to accept the new high mantissa.
26	"04"	"000000"	MANL		Enter the new low mantissa.
27	"04"	"360369"	MANL		Accept the new low mantissa for B.
28	"04"	"- 03"	EXPO		Do not change the exponent, since it is what you want.
29	"04"	"5.43504"	E-- 03		Accept the new value for B.
30	"04"	"999999"	↑FSC		Press the down arrow key until "OLD?" appears in the right window.
31			OLD?		Exit I/O channel configuration.
32			EXT?		Confirm that you want to exit.
33			PANL		Remove the configuration panel from the front of the DP95.

The DP95 is now calibrated. At this point, you should reset the user channel M if you had to change it (you did not have to in this example). You should repeat the performance verification test to ensure that the calibration was performed properly.

7.4 Troubleshooting

Find the specific problem you are having in the left column, and then check the possible causes to its right. If the problem you are experiencing is not listed in this table, or if the solutions do not seem to work, then contact OMEGA Customer Support.

PROBLEM	CAUSE	SOLUTION
1. After connecting power, instrument performs "SELF TEST" and then displays "ON" in right hand display.	- No inputs are connected.	- Connect an RTD probe or resistance to the input terminals and press the SELF TEST key.
2. An input is connected but the display still shows ON.	- Input may have been connected after power up.	- Press the SELF TEST key.
	- DP95 may not be functioning properly.	- Contact the Factory.
3. The instrument reads a temperature of 000.000 for a probe.	- The probe may not be connected to the RTD input.	- Connect an RTD probe or resistance to the input terminals and press the SELF TEST key.
	- DP95 may be malfunctioning.	- Contact the Factory.
4. A probe input reads only ohms, not temperature.	- The probe coefficients were not entered.	- Enter the coefficients for the probe. See Chapter 4 for instructions.
5. Configuration mode cannot be entered by using the configuration panel.	- The switch behind the front panel door is in the down position, disabling the configuration option.	- Move the switch into the up position. Align the configuration panel (move it around on front).
6. The readout of a probe is .xxx (i.e. no leading zeros).	- The suppression of leading zeros means that the CPU is sensing an input. Either the probe is not connected or it has open circuited, or the RTD input card itself has malfunctioned.	- Check the probe. Make sure it is properly connected, and that the wires are in good condition. Contact the factory.

PROBLEM	CAUSE	SOLUTION
7. No printout occurs when the PRINT DATA key is pressed.	- The printer cable may not be connected.	- Check the printer cable and plug it in if it is unplugged.
	- The printer may not be properly set up.	- Check the printer setup, making sure it is on line. Refer to your printer manual.
	- The DP95's interface is not working.	- Using a breakout box or terminal, see if the DP95's communications port is sending out data when the PRINT DATA button is pressed. If no data is sent out from the port, then the DP95 may not be functioning properly. Contact the factory.
8. The unit does not turn on.	- The wrong type of power is connected to the DP95.	- Check the type of power required by the DP95, and make sure that it matches the power type it is connected to.
	- The fuse has blown.	- Check and replace the fuse if blown. The fuse is a Type 3AG, 1/2A @ 250V.
	- The DP95 is malfunctioning.	- Contact the factory.
9. The probe reading fluctuates widely.	- There may be an intermittent break in the probe.	- Replace the probe to determine if it is faulty. If high temperatures are involved, make sure that they are within the RTD probe's operating range.
	- The temperature may be unstable in the measured medium.	- Place the probe in a constant temperature bath, or connect a resistor across the input terminals and see if the measurement still fluctuates.
	- If the temperature measurement still fluctuates, then the DP95 may be defective.	- Contact the factory.

PROBLEM	CAUSE	SOLUTION
10. The temperature reading is not accurate.	<ul style="list-style-type: none"> - The unit has not warmed up. 	<ul style="list-style-type: none"> - Allow the unit to warm up after it is switched on. For continuous operation, leave the instrument on.
	<ul style="list-style-type: none"> - The DP95 is not in a stable environment. 	<ul style="list-style-type: none"> - Move the DP95 to a place where there are no air drafts or wide temperature fluctuations. Cover the binding posts with the metal cover provided.
	<ul style="list-style-type: none"> - Probe coefficients have not been entered correctly. 	<ul style="list-style-type: none"> - Check the probe coefficients, especially the sign of the mantissa, the sign of the exponent, the position of decimal point, and the entry of the mantissa low.
	<ul style="list-style-type: none"> - The probe coefficients may no longer be valid if the probe has been shocked or damaged. 	<ul style="list-style-type: none"> - Replace the probe with a new probe, and enter the coefficient information for this probe.
	<ul style="list-style-type: none"> - The RTD input card is out of calibration. 	<ul style="list-style-type: none"> - Check the calibration of the RTD input channel. See Section 7.2.

NOTES



WARRANTY/DISCLAIMER

OMEGA ENGINEERING, INC. warrants this unit to be free of defects in materials and workmanship for a period of **13 months** from date of purchase. OMEGA's WARRANTY adds an additional one (1) month grace period to the normal **one (1) year product warranty** to cover handling and shipping time. This ensures that OMEGA's customers receive maximum coverage on each product.

If the unit malfunctions, it must be returned to the factory for evaluation. OMEGA's Customer Service Department will issue an Authorized Return (AR) number immediately upon phone or written request. Upon examination by OMEGA, if the unit is found to be defective, it will be repaired or replaced at no charge. OMEGA's WARRANTY does not apply to defects resulting from any action of the purchaser, including but not limited to mishandling, improper interfacing, operation outside of design limits, improper repair, or unauthorized modification. This WARRANTY is VOID if the unit shows evidence of having been tampered with or shows evidence of having been damaged as a result of excessive corrosion; or current, heat, moisture or vibration; improper specification; misapplication; misuse or other operating conditions outside of OMEGA's control. Components which wear are not warranted, including but not limited to contact points, fuses, and triacs.

OMEGA is pleased to offer suggestions on the use of its various products. However, OMEGA neither assumes responsibility for any omissions or errors nor assumes liability for any damages that result from the use of its products in accordance with information provided by OMEGA, either verbal or written. OMEGA warrants only that the parts manufactured by it will be as specified and free of defects. OMEGA MAKES NO OTHER WARRANTIES OR REPRESENTATIONS OF ANY KIND WHATSOEVER, EXPRESS OR IMPLIED, EXCEPT THAT OF TITLE, AND ALL IMPLIED WARRANTIES INCLUDING ANY WARRANTY OF MERCHANTABILITY AND FITNESS FOR A PARTICULAR PURPOSE ARE HEREBY DISCLAIMED. LIMITATION OF LIABILITY: The remedies of purchaser set forth herein are exclusive, and the total liability of OMEGA with respect to this order, whether based on contract, warranty, negligence, indemnification, strict liability or otherwise, shall not exceed the purchase price of the component upon which liability is based. In no event shall OMEGA be liable for consequential, incidental or special damages.

CONDITIONS: Equipment sold by OMEGA is not intended to be used, nor shall it be used: (1) as a "Basic Component" under 10 CFR 21 (NRC), used in or with any nuclear installation or activity; or (2) in medical applications or used on humans. Should any Product(s) be used in or with any nuclear installation or activity, medical application, used on humans, or misused in any way, OMEGA assumes no responsibility as set forth in our basic WARRANTY/DISCLAIMER language, and, additionally, purchaser will indemnify OMEGA and hold OMEGA harmless from any liability or damage whatsoever arising out of the use of the Product(s) in such a manner.

RETURN REQUESTS/INQUIRIES

Direct all warranty and repair requests/inquiries to the OMEGA Customer Service Department. BEFORE RETURNING ANY PRODUCT(S) TO OMEGA, PURCHASER MUST OBTAIN AN AUTHORIZED RETURN (AR) NUMBER FROM OMEGA'S CUSTOMER SERVICE DEPARTMENT (IN ORDER TO AVOID PROCESSING DELAYS). The assigned AR number should then be marked on the outside of the return package and on any correspondence.

The purchaser is responsible for shipping charges, freight, insurance and proper packaging to prevent breakage in transit.

FOR **WARRANTY** RETURNS, please have the following information available BEFORE contacting OMEGA:

1. Purchase Order number under which the product was PURCHASED,
2. Model and serial number of the product under warranty, and
3. Repair instructions and/or specific problems relative to the product.

FOR **NON-WARRANTY** REPAIRS, consult OMEGA for current repair charges. Have the following information available BEFORE contacting OMEGA:

1. Purchase Order number to cover the COST of the repair,
2. Model and serial number of the product, and
3. Repair instructions and/or specific problems relative to the product.

OMEGA's policy is to make running changes, not model changes, whenever an improvement is possible. This affords our customers the latest in technology and engineering.

OMEGA is a registered trademark of OMEGA ENGINEERING, INC.

© Copyright 1999 OMEGA ENGINEERING, INC. All rights reserved. This document may not be copied, photocopied, reproduced, translated, or reduced to any electronic medium or machine-readable form, in whole or in part, without the prior written consent of OMEGA ENGINEERING, INC.

Where Do I Find Everything I Need for Process Measurement and Control? OMEGA...Of Course!

TEMPERATURE

- Thermocouple, RTD & Thermistor Probes, Connectors, Panels & Assemblies
- Wire: Thermocouple, RTD & Thermistor
- Calibrators & Ice Point References
- Recorders, Controllers & Process Monitors
- Infrared Pyrometers

PRESSURE, STRAIN AND FORCE

- Transducers & Strain Gages
- Load Cells & Pressure Gages
- Displacement Transducers
- Instrumentation & Accessories

FLOW/LEVEL

- Rotameters, Gas Mass Flowmeters & Flow Computers
- Air Velocity Indicators
- Turbine/Paddlewheel Systems
- Totalizers & Batch Controllers

pH/CONDUCTIVITY

- pH Electrodes, Testers & Accessories
- Benchtop/Laboratory Meters
- Controllers, Calibrators, Simulators & Pumps
- Industrial pH & Conductivity Equipment

DATA ACQUISITION

- Data Acquisition & Engineering Software
- Communications-Based Acquisition Systems
- Plug-in Cards for Apple, IBM & Compatibles
- Datalogging Systems
- Recorders, Printers & Plotters

HEATERS

- Heating Cable
- Cartridge & Strip Heaters
- Immersion & Band Heaters
- Flexible Heaters
- Laboratory Heaters

ENVIRONMENTAL MONITORING AND CONTROL

- Metering & Control Instrumentation
- Refractometers
- Pumps & Tubing
- Air, Soil & Water Monitors
- Industrial Water & Wastewater Treatment
- pH, Conductivity & Dissolved Oxygen Instruments

M1541/0999

Free Manuals Download Website

<http://myh66.com>

<http://usermanuals.us>

<http://www.somanuals.com>

<http://www.4manuals.cc>

<http://www.manual-lib.com>

<http://www.404manual.com>

<http://www.luxmanual.com>

<http://aubethermostatmanual.com>

Golf course search by state

<http://golfingnear.com>

Email search by domain

<http://emailbydomain.com>

Auto manuals search

<http://auto.somanuals.com>

TV manuals search

<http://tv.somanuals.com>