

**YEAR
2000
COMPLIANT**

CE

**UL[®]
C US**



User's Guide



An OMEGA Technologies Company

<http://www.omega.com>
[e-mail: info@omega.com](mailto:info@omega.com)

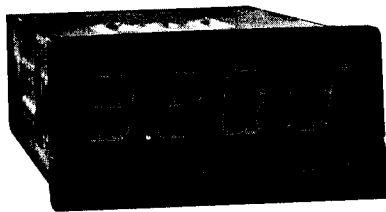

DP1632 SERIES Temperature & Process Panel Meters



OMEGAnetSM On-Line Service
<http://www.omega.com>

Internet e-mail
info@omega.com

Servicing North America:

USA:
ISO 9001 Certified

One Omega Drive, Box 4047
Stamford, CT 06907-0047
Tel: (203) 359-1660
e-mail: info@omega.com

FAX: (203) 359-7700

Canada:

976 Bergar
Laval (Quebec) H7L 5A1
Tel: (514) 856-6928
e-mail: info@omega.ca

FAX: (514) 856-6886

For immediate technical or application assistance:

USA and Canada: Sales Service: 1-800-826-6342 / 1-800-TC-OMEGASM
Customer Service: 1-800-622-2378 / 1-800-622-BESTSM
Engineering Service: 1-800-872-9436 / 1-800-USA-WHENSM
TELEX: 996404 EASYLINK: 62968934 CABLE: OMEGA

**Mexico and
Latin America:**

Tel: (95) 800-826-6342
En Español: (95) 203-359-7803

FAX: (95) 203-359-7807
e-mail: espanol@omega.com

Servicing Europe:

Benelux:

Postbus 8034, 1180 LA Amstelveen, The Netherlands
Tel: (31) 20 6418405
Toll Free in Benelux: 06 0993344
e-mail: nl@omega.com

FAX: (31) 20 6434643

Czech Republic:

ul.Rude armady 1868, 733 01 Karvina-Hranice
Tel: 420 (69) 6311899
e-mail: czech@omega.com

FAX: 420 (69) 6311114

France:

9, rue Denis Papin, 78190 Trappes
Tel: (33) 130-621-400
Toll Free in France: 0800-4-06342
e-mail: france@omega.com

FAX: (33) 130-699-120

Germany/Austria:

Daimlerstrasse 26, D-75392 Deckenpfronn, Germany
Tel: 49 (07056) 3017
Toll Free in Germany: 0130 11 21 66
e-mail: info@omega.de

FAX: 49 (07056) 8540

United Kingdom:
ISO 9002 Certified

One Omega Drive, River Bend Technology Centre
Northbank, Irlam, Manchester
Tel: 44 (161) 777-6611
Toll Free in the United Kingdom: 0800-488-488
e-mail: info@omega.co.uk

FAX: 44 (161) 777-6622

It is the policy of OMEGA to comply with all worldwide safety and EMC/EMI regulations that apply. OMEGA is constantly pursuing certification of its products to the European New Approach Directives. OMEGA will add the CE mark to every appropriate device upon certification. The information contained in this document is believed to be correct, but OMEGA Engineering, Inc. accepts no liability for any errors it contains, and reserves the right to alter specifications without notice. **WARNING:** These products are not designed for use in, and should not be used for, patient-connected applications.

Table of Contents

	Page
Section 1 - Installation - Panel-Mounting	5
1.1 Unpacking the Instrument	6
1.2 Installing the Instrument in the Mounting Panel	6
Section 2 - Installation - Wiring Connections	8
2.1 Mains (Line) Supply	8
2.2 Low Voltage (24V AC/DC) Supply - Option	9
2.3 Thermocouple Input	9
2.4 RTD Inputs	9
2.5 DC Inputs	9
2.6 Relay Outputs (Output 2 & Output 3)	10
2.7 dc Pulse Output (Output 1)	10
2.8 RS485 Communications	10
Section 3 - Front Panel	11
3.1 Indicators	11
3.2 Keys	11
Section 4 - Instrument Configuration	13
4.1 Entry into Instrument Configuration Mode	13
4.2 Parameter Sequence	17
4.3 Exit from Instrument Configuration Mode	17
Section 5 - Operation Mode	19
5.1 Normal Operation (Yellow LED OFF)	19
Section 6 - Instrument Setup (Yellow LED ON)	21
6.1 Adjustment Ranges	21
6.2 Default Values/Settings	21
Section 7 - Calibration Mode	22
7.1 Prerequisites	23
7.2 Entry into Calibration Mode	24
7.3 Calibration Procedure	24
7.4 Exiting Calibration Mode	25

Appendix

A - Product Specification
B - Order Matrix

26
31

Figures & Tables

Figure 1-1	Main Dimensions	5
Figure 1-2	Panel Cut-out Dimensions	5
Figure 2-1	Rear Terminal Connections	7
Figure 2-2	Mains (Line) Supply Connections	8
Figure 2-3	Low Voltage AC/DC Supply Connections	9
Figure 2-4	RS485 Line Termination	10
Table 4-1	Sensor Selection Codes	16
Table 4-2	Output Selection Codes	16

Installation - Panel-Mounting

1.1 UNPACKING THE INSTRUMENT

1. Remove the Instrument from its packing. A panel gasket and a "no tools required" fixing strap are supplied. Retain the packing for future use (e.g. moving the Instrument to a different site).
2. Examine the delivered items for damage or deficiencies. If any are found, notify the carrier immediately. Check that the Product Code on the label affixed to the Instrument housing corresponds to that ordered.

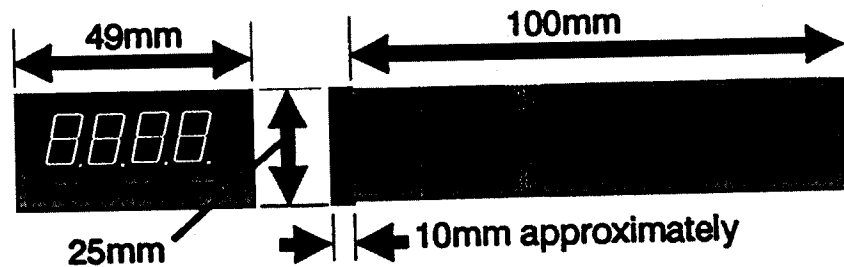

FIGURE 1-1 Main Dimensions

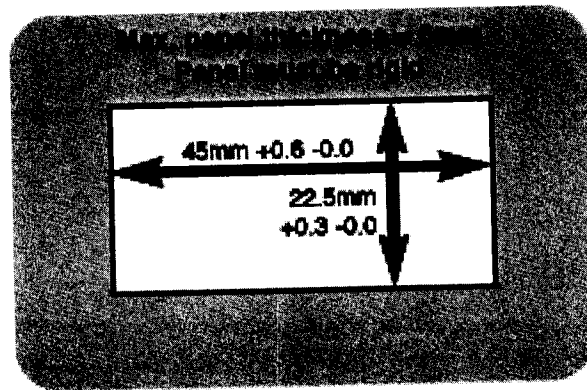
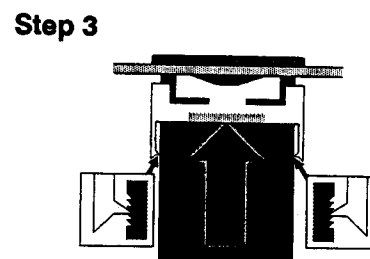
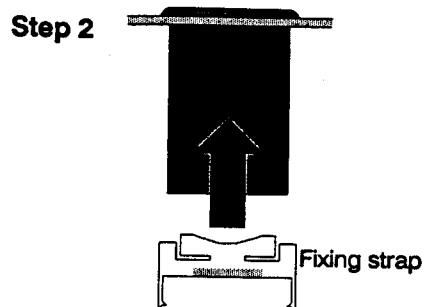
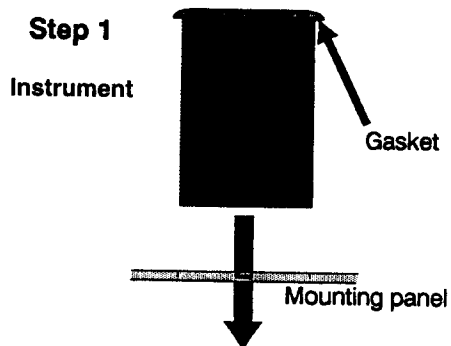

FIGURE 1-2 Panel Cut-out Dimensions

1.2 INSTALLING THE INSTRUMENT IN THE MOUNTING PANEL

CAUTION: Do not remove the front panel gasket from the Instrument, as this may cause inadequate clamping of the Instrument to the mounting panel. Ensure that this gasket is not distorted and that the Instrument is positioned squarely against the mounting panel. Apply pressure to the front panel bezel only.



Installation - Wiring Connections

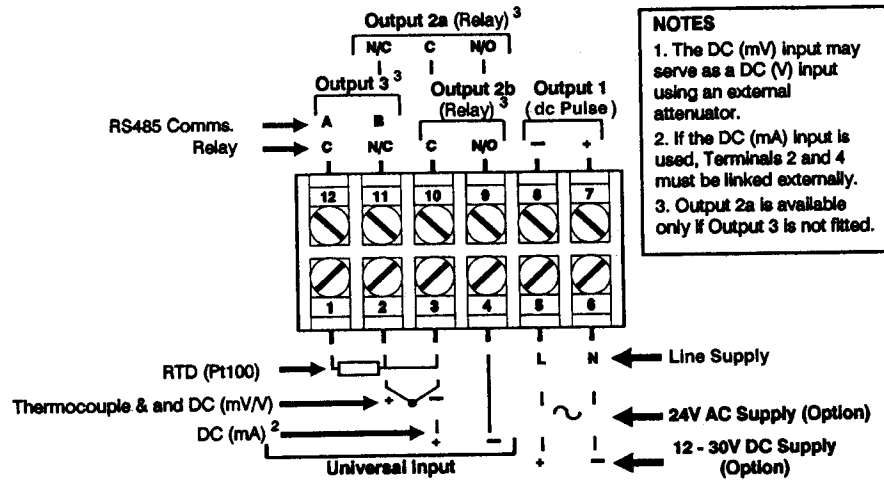

FIGURE 2-1 Rear Terminal Connections

NOTE: Terminals 7 & 8 are dedicated to those units which a dc Pulse output was ordered. If a single output relay unit was ordered, the relay is wired between pins 9 & 10.

Output	Function (see Table 4-2)		
	Alarm 1	Alarm 2	RS485 Comms.
Output 1	*		
Output 2a ³	*		
Output 2b ³	*		
Output 3 ³		*	*

2.1 MAINS (LINE) SUPPLY

This version of the Instrument will operate on a 96 - 264V AC 50/60Hz mains (line) supply. The power consumption is approximately 4W.

CAUTION: This equipment is designed for installation in an enclosure which provides adequate protection against electric shock. Local regulations regarding electrical installation should be rigidly observed. Consideration should be given to prevention of access to the power terminations by unauthorized personnel. Power should be connected via a two-pole isolating switch (preferably situated near the Instrument) and a 1A fuse, as shown in Figure 2-2.

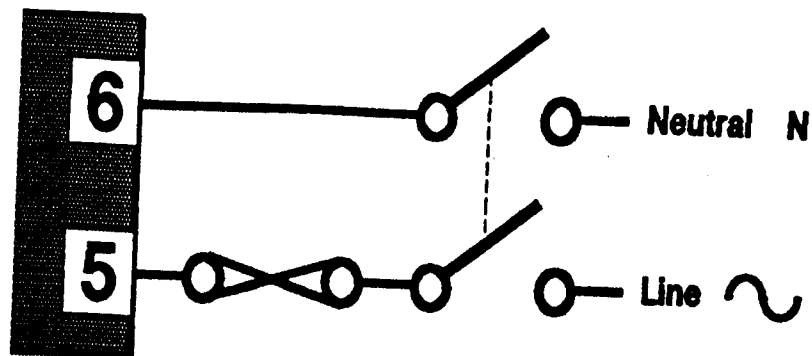

FIGURE 2-2 Mains (Line) Supply Connections

If the contacts of the relay output(s) are used to carry mains (line) voltage, it is recommended that the relay contacts mains (line) supply should be switched and fused in a similar manner but should be separate from the Instrument mains (line) supply.

2.2 LOW VOLTAGE (24V AC/DC) SUPPLY - OPTION

This version of the Instrument will operate on 12 - 24V AC 50/60Hz or 12 - 30V DC supply. The power consumption is approximately 4W. The connections are shown in Figure 2-3; these should be made via a two-pole isolating switch and a 315mA slow-blow (anti-surge Type T) fuse.

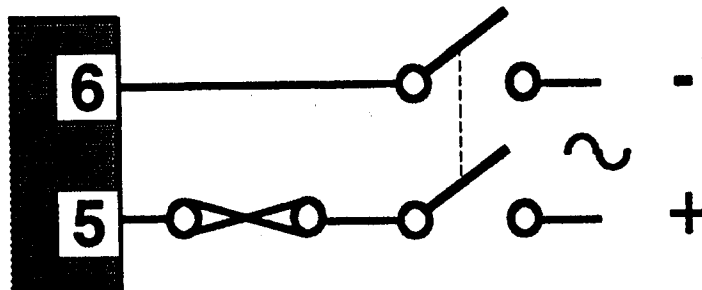

FIGURE 2-3 Low Voltage AC/DC Supply Connections

2.3 THERMOCOUPLE INPUT

The correct type of thermocouple extension leadwire or compensating cable must be used for the full distance between the Instrument and the thermocouple, ensuring that the correct polarity is observed throughout.

NOTE: Do not run the thermocouple cables adjacent to power-carrying conductors. If the wiring is run in a conduit, use a separate conduit for the thermocouple wiring. If the thermocouple is grounded, this must be done at one point only. If the thermocouple extension lead is shielded, the shield must be grounded at one point only.

2.4 RTD INPUTS

The compensating lead should be connected to Terminal 3. For two-wire RTD inputs, Terminals 2 and 3 should be linked. The extension leads should be of copper and the resistance of the wires connecting the resistance element should not exceed 5 ohms per lead (the leads should be of equal length).

2.5 DC INPUTS

DC (mV) inputs are connected to Terminals 2 and 3 in the polarity shown in Figure 2-1; DC (V) inputs are connected to the same terminals with the same polarity but require an external attenuator. DC (mA) inputs are connected to Terminals 3 and 4 in the polarity shown in Figure 2-1 with Terminals 2 and 4 linked externally.

2.6 RELAY OUTPUTS (OUTPUT 2 & OUTPUT 3)

The contacts are rated at 2A resistive at 120/240V AC.

2.7 dc PULSE OUTPUT (OUTPUT 1)

This output produces a time-proportioned non-isolated DC signal (0 - 10V nominal, into 500 Ω minimum).

2.8 RS485 COMMUNICATIONS

The "A" terminal (Terminal 12) on the Instrument should be connected to the "A" terminal on the master device; the "B" terminal (Terminal 11) on the Instrument should be connected to the "B" terminal on the master device. This instrument uses standard RS485 devices, isolated from all other inputs and outputs. The devices present a 1/4-unit load to the RS485 line. Generally, termination will not be required but may be necessary for line lengths greater than 100 metres. Where termination is necessary, it is recommended that a 120 Ω resistance in series with a 0.1 μ F capacitor be used at each end of the line (see Figure 2-4).

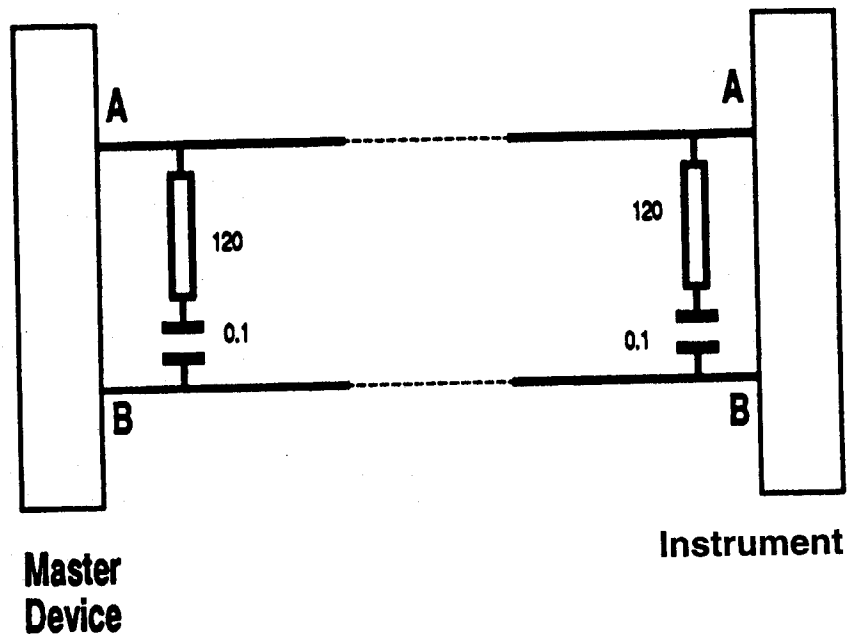
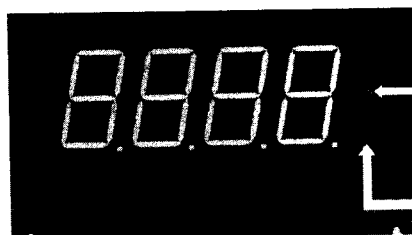

FIGURE 2-4 RS485 Line Termination

Front Panel

3.1 INDICATORS



Yellow: OFF - Normal Operation
ON - Setup
Flashing - Instrument Configuration

Red: Flashes when alarm(s) active

3.2 KEYS



Scroll key

All Modes except Calibration:

If parameter value displayed, shows parameter legend (for 1.5 seconds). If legend displayed, shows value of next parameter.

Calibration:

Starts calibration phase.



Down key

Normal Operation:

Decrements parameter value. With process variable displayed. Also confirms request for entry into *Instrument Configuration*.

Control Setup/Instrument Configuration:

Decrements parameter value.

Calibration:

Steps to previous calibration phase.



Up key
Normal Operation: Decrements parameter value.
Control Setup/Instrument Configuration: Decrements parameter value.
Calibration: Steps to next calibration phase.



Scroll & Down keys
Normal Operation: Enters <i>Calibration</i> .



Scroll & Up keys
Normal Operation: Requests entry into <i>Instrument Configuration</i> .



Down & Up keys
Normal Operation: Enters <i>Setup</i> .
Setup/Instrument Configuration/Calibration: Returns to <i>Normal Operation</i> .

Instrument Configuration

4.1 ENTRY INTO INSTRUMENT CONFIGURATION MODE

1. Hold down Scroll and Up keys simultaneously until the display begins to flash.

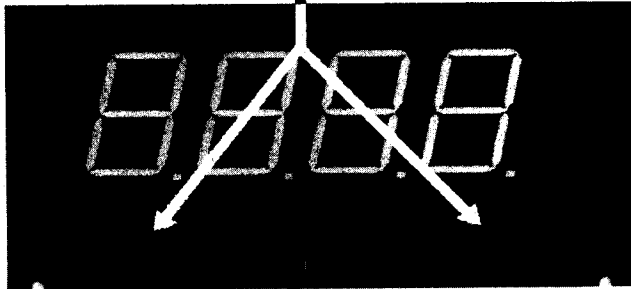

2. When display begins to flash, release the Scroll and up keys and press the Down key.

4.2 PARAMETER SEQUENCE

The Scroll key is used to step through the parameters in the following manner:

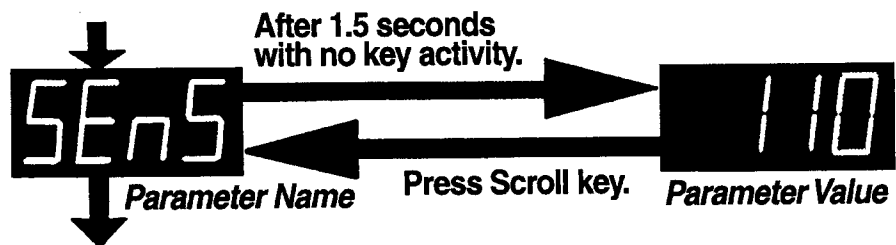

To display next parameter name, press Scroll key.

The parameter sequence is as follows:

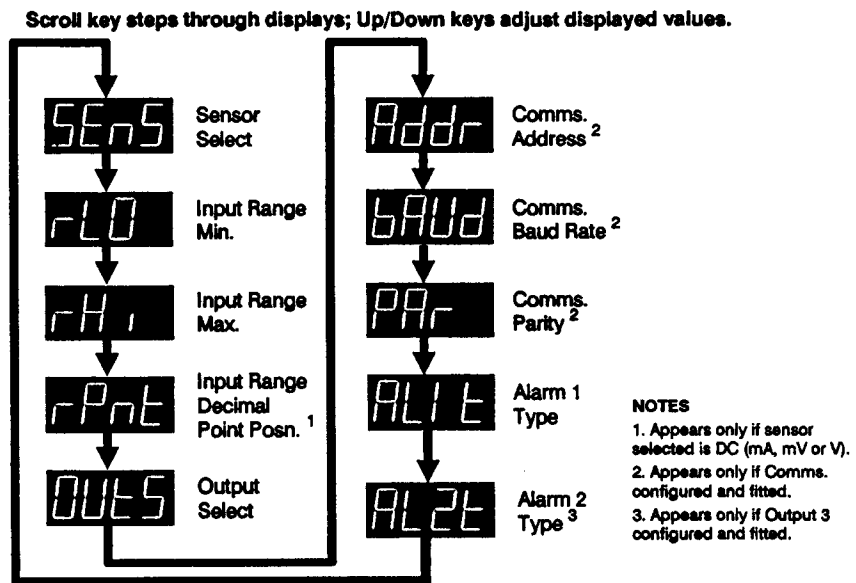

4.2.1 Adjustment Ranges











Parameter	Function	Adjustment Range
Sensor Select	Selects input sensor type, resolution and input units (°F or °C) by means of a code number	See Table 4-1
Input Range Minimum	Defines minimum value of input range	Thermocouple/RTD inputs: Range Min. value for selected sensor (see Table 4-1) to 100 LSDs less than current Input Range Max. setting. DC inputs: -1999 to 9999 with decimal point set according to <i>Input Range Decimal Point Position</i> parameter.
Input Range Maximum	Defines maximum value of input range	Thermocouple/RTD inputs: 100 LSDs greater than current Input Range Min. setting to Range Max. for selected sensor (see Table 4-1). DC inputs: -1999 to 9999 with decimal point set according to <i>Input Range Decimal Point Position</i> parameter.
Input Range Decimal Point Position	For DC inputs only, defines decimal point position	0 (xxxx), 1 (xxx.x), 2 (xx.xx) or 3 (x.xxx)
Output Selection	Links outputs to functions required by a 3-digit code (see Table 4-2)	See Table 4-2.
Communications Address	Defines unique communications address of Controller	1 to 128
Communications Baud Rate	Selects Baud rate for serial communications	 1200 Baud  2400 Baud  4800 Baud  9600 Baud
Communications Parity	Defines parity for serial communications	 Odd parity  Even parity  No parity
Alarm 1 Type	Selects type of alarm for Alarm 1	 Process High, direct-acting  Process Low, direct-acting  Process High, reverse-acting  Process Low, reverse-acting
Alarm 2 Type	Selects type of alarm for Alarm 2	As for Alarm 1 Type.

TABLE 4-1 Sensor Selection Codes

Input Type	Code		Range Min. (°C)	Range Max. (°C)	Range Min. (°F)	Range Max. (°F)
	°C	°F				
T/C - J	100	101	-200	1200	-328	2191
	110	111	-128.0	537.0	-198.4	998.5
T/C - T	200	201	-240	401	-400	753
	210	211	-128.0	400.6	-198.4	753.0
T/C - K	300	301	-240	1371	-400	2499
	310	311	-128.0	536.7	-198.4	998.0
T/C - N	400	401	0	1399	32	2550
T/C - B	500	501	100	1824	211	3315
T/C - R	600	601	0	1759	32	3198
T/C - S	700	701	0	1770	32	3217
	810	811	-199	802	-327	1475
RTD	800	801	-199	802	-327	1475
	810	811	-127.9	537.0	-198.3	998.5

DC Linear Input Type	Code	Range Min.	Range Max.
0 - 20mA	900	-1999	9999
4 - 20mA	1000	-1999	9999
0 - 50mV	2000	-1999	9999
10 - 50mV	3000	-1999	9999

TABLE 4-2 Output Selection Codes



Alarm 1 Output		Option	
Code	Meaning	Code	Meaning
0	Not fitted	0	Not fitted
1	Relay	1	Second Relay Output fitted
2	dc Pulse	2	Comms. (MODBUS) fitted

4.2.2 DEFAULT VALUES

Parameter	Default Value
Sensor Select	100 - Thermocouple Type J (-200 to 1200°C)
Input Range Minimum	For Thermocouple/RTD Input: Input Range Minimum For DC Linear Input: 0
Input Range Maximum	For Thermocouple/RTD Input: Input Range Maximum For DC Linear Input: 1000
Input Range Decimal Point Position	0
Output Selection	021 - Relay control output, SSR Drive, no option
Communications Address	1
Communications Baud Rate	4800
Communications Parity	None
Alarm 1 Type	Process High Alarm
Alarm 2 Type	Process Low Alarm

4.3 EXIT FROM INSTRUMENT CONFIGURATION MODE

To exit from Instrument Configuration Mode:

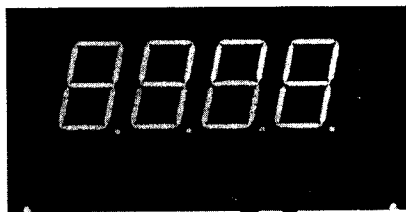

Hold down the Up and Down keys
for three seconds

The instrument will then return to Normal Operation Mode via an instrument reset and self-test sequence.

NOTE: If there is no key activity for five minutes in Instrument Configuration Mode, an automatic return is made to Normal Operation Mode (via an instrument reset and self-test sequence).

Operation Mode

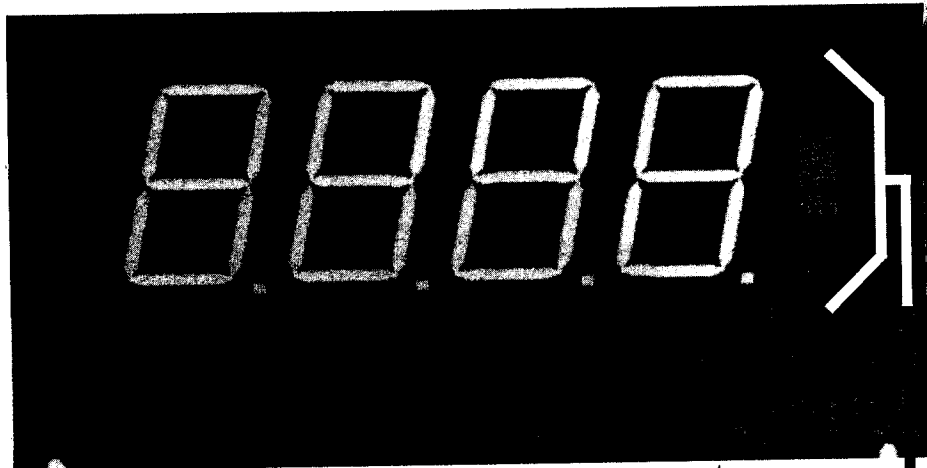

↑
Scroll Key
↓
Down Key
↑
Up Key

INDICATORS

Yellow:	OFF	- Normal Operation
	ON	- Control Setup
Red:	Flashing	- Alarm(s) active

5.1 NORMAL OPERATION (Yellow LED OFF)

In this mode, the display normally shows the process variable value. Use the Scroll key to step through a sequence of parameters as follows:

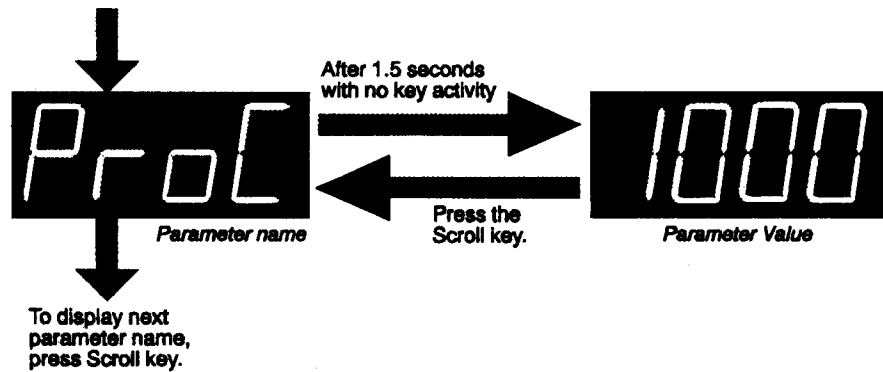

The following parameters are available in Normal Operation.

Scroll key steps through displays; Up/Down keys adjust displayed values.

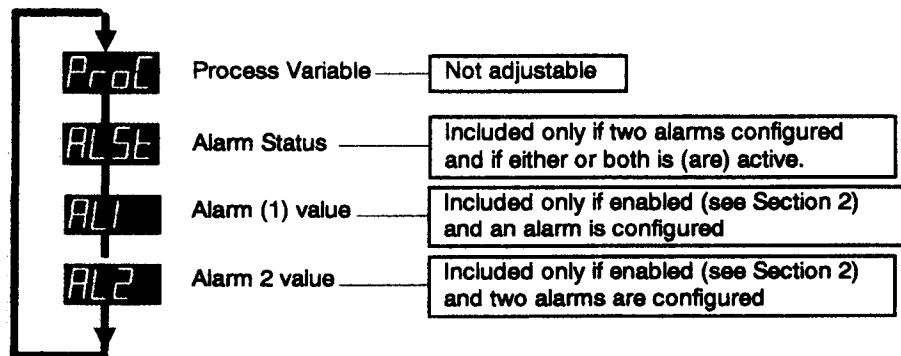

Instrument Setup (Yellow LED ON)

To enter Instrument Setup mode, press the Up and Down keys simultaneously for more than three seconds. The same key action exits this mode. The parameters are as follows:

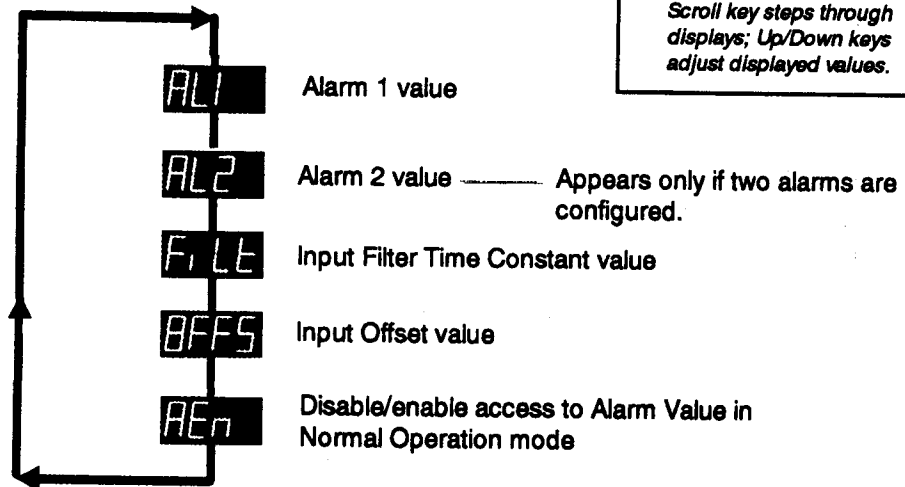

6.1 ADJUSTMENT RANGES

Parameter	Adjustment Range
Alarm (1 & 2) level	Process High: Input Range Min. to Input Range Max. Process Low: Input Range Min. to Input Range Max. NOTE: Negative values limited by display to -1999
Input Filter Time Constant	0sec. to 100sec.
Input Offset	± input span NOTE: Negative values limited by display to -1999
Alarm Value Display Enable/Disable	En/Dis display/adjustment enabled in Normal Operation En/Dis display/adjustment disabled in Normal Operation

6.2 DEFAULT VALUES/SETTINGS

Parameter	Default Value/Setting
Setpoint(s)	Input Range Min.
Proportional Band	10.0%
Reset	5 minutes
Rate	1 minute 15 seconds
Bias (Manual Reset)	25%
ON/OFF Hysteresis	0.5% of input span
Alarm (1 & 2) level	Alarm 1 Process High: Input Range Max. Alarm 2 Process Low: Input Range Min.
Input Filter Time Constant	2 seconds
Input Offset	0
Output Cycle Time	16 seconds
Setpoint Lock	Off (adjustment enabled)
Alarm Value Display Enable/Disable	En/Dis (enabled)

Calibration Mode

The Instrument is shipped from the factory ready-calibrated and normally does not need further calibration. However, some users may have a legal requirement for annual calibration. The procedures set out in this Section serve that purpose.

7.1 PREREQUISITES

The Calibration Mode has four phases. In addition to the Instrument to be calibrated, each phase requires the appropriate input to be fitted before that phase is executed. These prerequisites are shown in the box below.

NOTE: These procedures should be implemented only by personnel competent and authorized to do so.

CALIBRATION PREREQUISITES

Phase 1 - DC mV Linear Input:	50mV DC across Terminals 2 & 3 in the polarity shown in Figure 2-1.
Phase 2 - RTD Input:	200W across Terminals 1 & 2 with compensating lead connected to Terminal 3.
Phase 3 - DC mA Input:	20mA current source connected to Terminals 3 & 4 in the polarity shown in Figure 2-1.
Phase 4 - Thermocouple Input/CJC:	0°C reference facility, Type K thermocouple leads (or equivalent) connected to Terminals 2 & 3.

7.2 Entry Into Calibration Mode

To enter Calibration Mode:

1. Power-down the Instrument.

2. Power-up the Instrument.

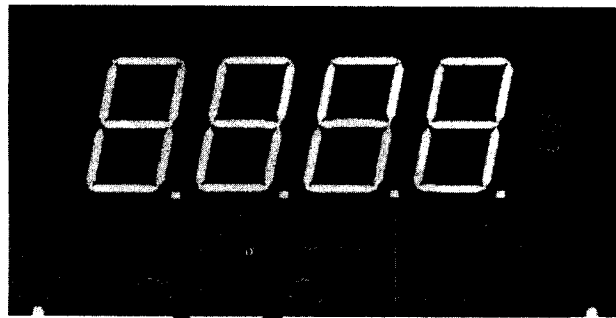

3. As the first key action after power-up, hold down the Scroll and Down keys for at least six seconds.

The Controller will then enter the Calibration Mode and will display:



indicating that the first calibration phase is ready to be executed.

7.3 Calibration Procedure

- Use Up key (step forward) or Down key (step backward) to select required phase.
- Use Scroll key to start selected phase.
- If FAIL displayed, use Up or Down key to return to start of failed phase.

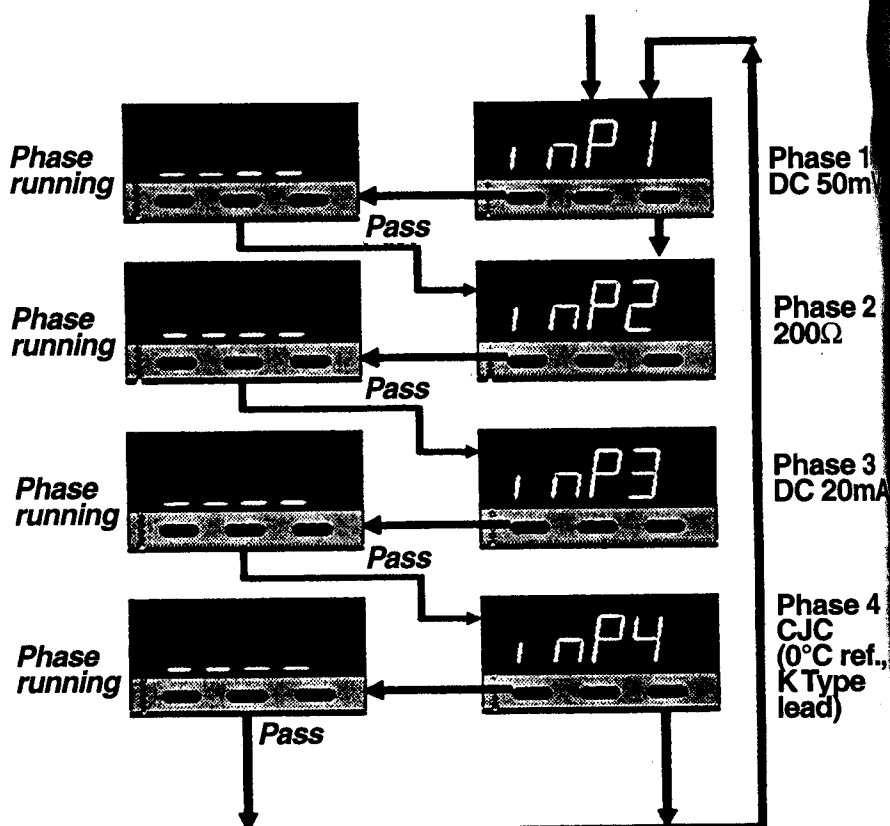

7.4 EXITING CALIBRATION MODE

To exit Calibration Mode:

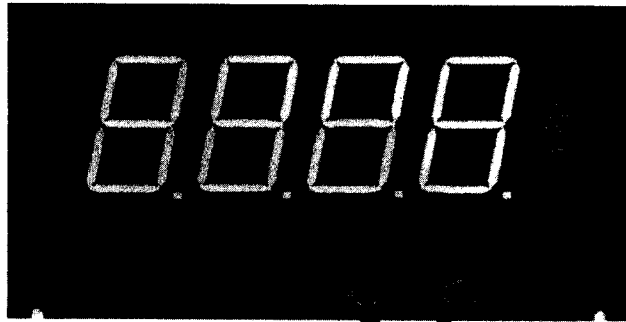

Hold down the Up and Down keys for three seconds.

The Instrument will then return to Normal Operation Mode

NOTE: If there is no key activity for five minutes in Calibration Mode, an automatic return is made to Normal Operation Mode.

Appendix A Product Specification

UNIVERSAL INPUT

- Sample Rate: 4 samples/second
- Digital Filter: Filter time constant selectable from front panel. Adjustment range 0.0 to 100.0 seconds in 0.5 second increments.
- Input Resolution: 14-bit resolution approximately. Always at least four times better than the display resolution.
- Input Impedance: >10M Ω resistive.
- Isolation: 240V ac isolation from all outputs except dc Pulse.
- Input Offset: Adjustable \pm input span, subject to display limit on negative values (-1999).

Thermocouple Input

Ranges selectable from the front panel are:

Input Type	Range Min. (°C)	Range Max. (°C)	Range Min. (°F)	Range Max. (°F)	Code	
					°C	°F
J	-200 -128.0	1200 537.0	-328 -198.4	2191 998.5	100 110	101 111
T	-240 -128.0	401 400.6	-400 -198.4	753 753.0	200 210	201 211
K	-240 -128.0	1371 536.7	-400 -198.4	2499 998.0	300 310	301 311
N	0	1399	32	2550	400	401
B	100	1824	211	3315	500	501
R	0	1759	32	3198	600	601
S	0	1760	32	3217	700	701

Calibration: Complies with BS4937, NBS125 and IEC584.

Sensor Break Detection: Break detected within two seconds.

RTD Input

Ranges selectable from the front panel are:

				Code	
Range Min. (°C)	Range Max. (°C)	Range Min. (°F)	Range Max. (°F)	°C	°F
-199	802	-327	1475	800	801
-127.9	537.0	-198.3	998.5	810	811

Type and Connection: Three-wire Pt100.
Calibration: Complies with BS1904 and DIN43760.
Lead Compensation: Automatic scheme.
RTD Sensor Current: 150µA approximately.
Sensor Break detection: Break detected within two seconds.

DC Input

Ranges selectable from the front panel are:

Input Type	Range Min.	Range Max.	Code
0 - 20mA	-1999	9999	900
4 - 20mA	-1999	9999	1000
0 - 50mV	-1999	9999	2000
10 - 50mV	-1999	9999	3000

OUTPUTS

Output 1 - dc Pulse (Standard)

Usage: Alarm 1 Output.
Drive Capability: >10Vdc into 500Ω minimum (50mA maximum).
Isolation: Not isolated from input.

Output 2 - Relay (Standard)

Usage: Alarm 1 Output.
Contact Type: Single pole, single throw (SPST).
Rating: 2A resistive at 120/240V ac.
Life: >500,000 operations at rated voltage & current.
Isolation: Inherent.

Output 3 - Relay or Communications (Options)

Relay Output

Usage:	Alarm 2.
Contact Type:	Single pole, single throw (SPST).
Rating:	2A resistive at 120/240V ac.
Life:	>500,000 operations at rated voltage & current.
Isolation:	Inherent.

Communications Port

Type:	Serial Asynchronous UART-to-UART link.
Data Format:	1 start bit, selectable parity (odd, even or none), 8 data bits, 1 stop bit.
Physical Layer:	RS485 (two-wire).
Transmitter Drive Capability:	32 standard RS485 unit loads.
Receiver Bus Loading:	0.25 standard RS485 unit load.
Presentation Layer:	MODBUS RTU protocol.
Maximum Number of Zones:	128.
Baud Rate:	Selectable from front panel in the range 9600, 4800, 2400 and 1200.
Zone Address Range:	1 to 128.

ALARM CONTROL

Max. Number of Alarms: Two, if two physical outputs are available.

Alarm Types-

Process High:	Input Range Minimum to Input Range Maximum.
Process Low:	Input Range Minimum to Input Range Maximum.

PERFORMANCE

Reference Conditions

Generally as BS5558.

Ambient Temperature: 20°C±2°C.

Relative Humidity: 60 to 70% non-condensing.
Supply Voltage: 90 to 254V ac 50Hz \pm 1%
Source Resistance: <10 Ω for thermocouple.
Lead Resistance: <0.1 Ω /lead balanced (Pt100).

Performance Under Reference Conditions

Common Mode Rejection: >120dB @ 50/60Hz giving negligible effect at up to 264V at 50/60Hz.
Series Mode Rejection: >500% of input span at 50/60Hz giving negligible effect.

Thermocouple Inputs

Measurement Accuracy: 0.1% of input span \pm 1 LSD typical (0.25% for Types J and T). NOTE: Reduced performance for Type B 100 to 600°C (and °F equivalent).
Linearisation Accuracy: Better than \pm 0.2°C at any point for any 0.1°C range (\pm 0.05°C typical).
Better than \pm 0.5°C at any point for any 1°C range.
Cold Junction Compensation: Better than \pm 0.7°C.

RTD Inputs

Measurement Accuracy: \pm 0.1% of input span \pm 1 LSD.
Linearisation Accuracy: Better than \pm 0.2°C at any point for any 0.1°C range (\pm 0.05°C typical).
Better than \pm 0.5°C at any point for any 1°C range.

DC mA/mV Inputs

Measurement Accuracy: \pm 0.1% of input span \pm 1 LSD.

Operating Conditions

Ambient Temperature (Operating): 0°C to 55°C.
Ambient Temperature (Storage): -20°C to 80°C.

Relative Humidity: 20% to 95% non-condensing.
Supply Voltage: 90 to 264V ac 50/60Hz
Source Resistance: 1000Ω maximum (thermocouple).
Lead Resistance: 50Ω/lead maximum (Pt100).

Performance Under Operating Conditions:

Temperature Stability: 0.01% on input span/°C change in ambient temperature (RTD and DC mA/mV 0.005% of span/°C).

Cold Junction Compensation: Better than ±1°C.

Supply voltage Influence: Negligible.

Relative Humidity Influence: Negligible.

Sensor Resistance Influence: Thermocouple 1000Ω <0.1% of span error.
RTD Pt100 50Ω/lead <0.25% of span error.

ENVIRONMENTAL

Operating Conditions: See **PERFORMANCE**.

EMI Immunity: Complies with BS EN 50082 Parts 1 (1992) and 2 (1995).

EMI Emissions: Complies with BS EN 50081 Parts 1 (1992) and 2 (1994).

Safety Considerations: Complies with BS EN 61010 Part 1 (1993) in so far as it applies.

Supply Voltage: 90 - 264V ac 50/60Hz (standard);
12 - 24V ac 50/60Hz or 12 - 30V dc (option).

Power Consumption: 4W maximum.

Front Panel Sealing: To IP66 (similar to NEMA4).

PHYSICAL

Dimensions: Behind-panel depth 100mm. Front face 25mm high x 49 mm wide.

Mounting: Plug-in with panel-mounting sleeve. Panel cutout 45mm x 22.5mm.

Terminals: Screw type.

Weight: 100g.

Appendix B Order Matrix

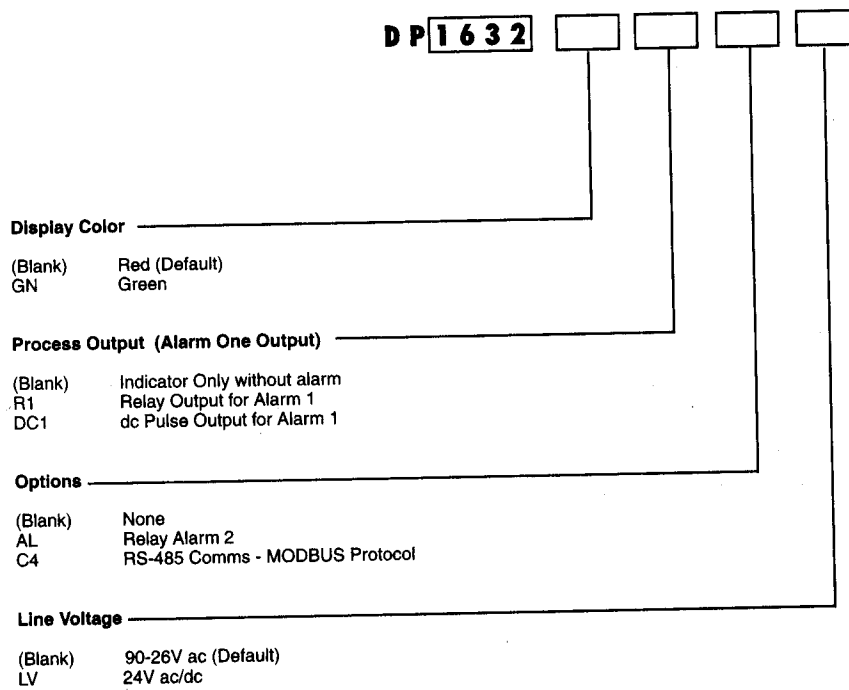

Order Example 1:
DP1632 R1 AL LV - 1/32 DIN Indicator with two alarm outputs and low voltage power supply

WARRANTY/DISCLAIMER

OMEGA ENGINEERING, INC. warrants this unit to be free of defects in materials and workmanship for a period of **37 months** from date of purchase. OMEGA Warranty adds an additional one (1) month grace period to the normal **three (3) year product warranty** to cover handling and shipping time. This ensures that OMEGA's customers receive maximum coverage on each product.

If the unit malfunctions, it must be returned to the factory for evaluation. OMEGA's Customer Service Department will issue an Authorized Return (AR) number immediately upon phone or written request. Upon examination by OMEGA, if the unit is found to be defective, it will be repaired or replaced at no charge. OMEGA's WARRANTY does not apply to defects resulting from any action outside of the purchaser, including but not limited to mishandling, improper interfacing, operation outside of design limits, improper repair, or unauthorized modification. This WARRANTY is VOID if the unit shows evidence of having been tampered with or shows evidence of having been damaged as a result of excessive corrosion; or current, heat, moisture or vibration; improper specification; misapplication; misuse or other operating conditions outside of OMEGA's control. Components which wear are not warranted, including but not limited to contact points, fuses, and triacs.

OMEGA is pleased to offer suggestions on the use of its various products. However, OMEGA neither assumes responsibility for any omissions or errors nor assumes liability for any damages that result from the use of its products in accordance with information provided by OMEGA, either verbal or written. OMEGA warrants only that the parts manufactured by it will be as specified and free of defects. OMEGA MAKES NO OTHER WARRANTIES OR REPRESENTATIONS OF ANY KIND WHATSOEVER, EXPRESS OR IMPLIED, EXCEPT THAT OF TITLE, AND ALL IMPLIED WARRANTIES INCLUDING ANY WARRANTY OF MERCHANTABILITY AND FITNESS FOR A PARTICULAR PURPOSE ARE HEREBY DISCLAIMED. LIMITATION OF LIABILITY: The remedies of purchaser set forth herein are exclusive, and the total liability of OMEGA with respect to this order, whether based on contract, warranty, negligence, indemnification, strict liability or otherwise, shall not exceed the purchase price of the component upon which liability is based. In no event shall OMEGA be liable for consequential, incidental or special damages.

CONDITIONS: Equipment sold by OMEGA is not intended to be used, nor shall it be used: (1) as a "Basic Component" under 10 CFR 21 (NRC), used in or with any nuclear installation or activity; or (2) in medical applications or used on humans. Should any Product(s) be used in or with any nuclear installation or activity, medical application, used on humans, or misused in any way, OMEGA assumes no responsibility as set forth in our basic WARRANTY/DISCLAIMER language, and, additionally, purchaser will indemnify OMEGA and hold OMEGA harmless from any liability or damage whatsoever arising out of the use of the Product(s) in such a manner.

RETURN REQUESTS / INQUIRIES

Direct all warranty and repair requests/inquiries to the OMEGA Customer Service Department. **BEFORE RETURNING ANY PRODUCT(S) TO OMEGA, PURCHASER MUST OBTAIN AN AUTHORIZED RETURN (AR) NUMBER FROM OMEGA'S CUSTOMER SERVICE DEPARTMENT (IN ORDER TO AVOID PROCESSING DELAYS).** The assigned AR number should then be marked on the outside of the return package and on any correspondence.

The purchaser is responsible for shipping charges, freight, insurance and proper packaging to prevent breakage in transit.

FOR **WARRANTY** RETURNS, please have the following information available BEFORE contacting OMEGA:

1. Purchase Order number under which the product was PURCHASED,
2. Model and serial number of the product under warranty, and
3. Repair instructions and/or specific problems relative to the product.

FOR **NON-WARRANTY** REPAIRS, consult OMEGA for current repair charges. Have the following information available BEFORE contacting OMEGA:

1. Purchase Order number to cover the COST of the repair,
2. Model and serial number of the product, and
3. Repair instructions and/or specific problems relative to the product.

OMEGA's policy is to make running changes, not model changes, whenever an improvement is possible. This affords our customers the latest in technology and engineering.

OMEGA is a registered trademark of OMEGA ENGINEERING, INC.

© Copyright 1998 OMEGA ENGINEERING, INC. All rights reserved. This document may not be copied, photocopied, reproduced, translated, or reduced to any electronic medium or machine-readable form, in whole or in part, without the prior written consent of OMEGA ENGINEERING, INC.

Where Do I Find Everything I Need for Process Measurement and Control? OMEGA...Of Course!

TEMPERATURE

- Thermocouple, RTD & Thermistor Probes, Connectors, Panels & Assemblies
- Wire: Thermocouple, RTD & Thermistor
- Calibrators & Ice Point References
- Recorders, Controllers & Process Monitors
- Infrared Pyrometers

PRESSURE, STRAIN AND FORCE

- Transducers & Strain Gauges
- Load Cells & Pressure Gauges
- Displacement Transducers
- Instrumentation & Accessories

FLOW/LEVEL

- Rotameters, Gas Mass Flowmeters & Flow Computers
- Air Velocity Indicators
- Turbine/Paddlewheel Systems
- Totalizers & Batch Controllers

pH/CONDUCTIVITY

- pH Electrodes, Testers & Accessories
- Benchtop/Laboratory Meters
- Controllers, Calibrators, Simulators & Pumps
- Industrial pH & Conductivity Equipment

DATA ACQUISITION

- Data Acquisition & Engineering Software
- Communications-Based Acquisition Systems
- Plug-in Cards for Apple, IBM & Compatibles
- Datalogging Systems
- Recorders, Printers & Plotters

HEATERS

- Heating Cable
- Cartridge & Strip Heaters
- Immersion & Band Heaters
- Flexible Heaters
- Laboratory Heaters

ENVIRONMENTAL MONITORING AND CONTROL

- Metering & Control Instrumentation
- Refractometers
- Pumps & Tubing
- Air, Soil & Water Monitors
- Industrial Water & Wastewater Treatment
- pH, Conductivity & Dissolved Oxygen Instruments

M3165/0998

Free Manuals Download Website

<http://myh66.com>

<http://usermanuals.us>

<http://www.somanuals.com>

<http://www.4manuals.cc>

<http://www.manual-lib.com>

<http://www.404manual.com>

<http://www.luxmanual.com>

<http://aubethermostatmanual.com>

Golf course search by state

<http://golfingnear.com>

Email search by domain

<http://emailbydomain.com>

Auto manuals search

<http://auto.somanuals.com>

TV manuals search

<http://tv.somanuals.com>