

SB2R

Shadow Box



ULN # 10081

PN # SB2R = L3-10081-CON-111708vB



EN	Instruction Manual
ES	Manual De Instrucciones
FR	Manuel D'instructions

EN	Images may differ from actual product
ES	El producto real puede variar respecto a la imagen mostrada.
FR	Le produit réel peut différer de l'illustration.

		MAXIMUM WEIGHT CAPACITY MÁXIMA CAPACIDAD DE PESO CAPACITÉ DE CHARGE MAXIMALE	POUNDS (LBS) LIBRAS (LB) LIVRES (LB)	KILOGRAMS (KG) KILOGRAMOS (KG) KILOGRAMMES (KG)	MAXIMUM SCREEN SIZE TAMAÑO DE PANTALLA MÁXIMO TAILLE D'ÉCRAN MAXIMALE	
COMPLETE UNIT			200 (LBS)	90.7 (KG)	N/A	

EN	USE WITH PRODUCTS LARGER THAN THE MAXIMUM WEIGHT AND SIZE MAY RESULT IN INSTABILITY CAUSING POSSIBLE INJURY. USER MUST REMOVE TELEVISION OR OBJECT OFF THE BRACKET BEFORE ADJUSTING. IF THE PRODUCT IS A TELEVISION MAXIMUM WEIGHT CAPACITY SUPERSEDES / OBTIENE PREFERENCIA SOBRE EL TAMAÑO DE PANTALLA RECOMENDADO DE LA TELEVISIÓN
ES	EL USO CON EL PRODUCTOS MÁS GRANDE QUE EL PESO MÁXIMO Y TAMAÑO PUEDE CAUSAR INESTABILIDAD Y POSIBLEMENTE HERIDAS. EL USUARIO DEBE QUITAR LA TELEVISIÓN U OBJETO DEL SOPORTE ANTES DEL AJUSTE. SI EL PRODUCTO ES UNA TELEVISIÓN, LA CAPACIDAD DE PESO MÁXIMA REEMPLAZA EL TAMAÑO DE PANTALLA RECOMENDADO DE LA TELEVISIÓN
FR	NE PAS UTILISER DES PRODUITS QUI SONT PLUS GRANDS DE LA CAPACITÉ DE CHARGE OU DES DIMENSIONS MAXIMALES – CELA POURRAIT PROVOQUER L'INSTABILITÉ DE PRODUIT ET DES BLESSURES. AVANT TOUT AJUSTEMENT, IL FAUT DÉMONTER LE TÉLÉVISEUR OU L'AUTRE PRODUIT ÉLECTRONIQUE. SI LE PRODUIT EST UN TÉLÉVISEUR, LA CAPACITÉ DE CHARGE MAXIMALE SE SUBSTITUTE AU GRANDEUR DIAGONALE RECOMMANDÉ DU TÉLÉVISEUR.

WARNING! - ENGLISH

- WARNING!** SEVERE PERSONAL INJURY AND PROPERTY DAMAGE CAN RESULT FROM IMPROPER INSTALLATION OR ASSEMBLY. READ THE FOLLOWING WARNINGS BEFORE BEGINNING.
- If you do not understand the instructions or have any concerns or questions, please contact a qualified installer. North America residents can contact OmniMount customer service at 800.668.6848 or info@omnimount.com.
- Do not install or assemble if the product or hardware is damaged or missing. If you require replacement parts, contact OmniMount Customer Service at 800.668.6848 or info@omnimount.com. International customers need to contact a local distributor for assistance.
- For wall mounted products:** This product has been designed for use on a vertical wall constructed of wood studs. Wood studs being defined as a wall consisting of a minimum of 2" x 4" studs with a maximum of 24" stud spacing and a minimum of 16" stud spacing with a maximum of 1/2" inch of wall covering (drywall, lath, plaster). For custom installations please contact a qualified installer. For safe installation, the wall you are mounting to must support 4 times the weight of the total load. If not, the surface must be reinforced to meet this standard. The installer is responsible for verifying that the wall structure/surface and the anchors used in the installation will safely support the total load. This product is not designed to support the load of a CRT Television. Do not use this product for any application other than those specified by OmniMount.
- This product is not designed to support the load of a CRT Television
- This product may contain moving parts. Use with caution.
- DO NOT EXCEED THE MAXIMUM WEIGHT CAPACITY FOR THIS PRODUCT.**

¡ADVERTENCIA! - ESPAÑOL

- ¡ADVERTENCIA!** LA INSTALACIÓN O EL MONTAJE INAPROPIADOS PUEDEN PROVOCAR LESIONES, DAÑOS MATERIALES O INCLUSO LA MUERTE. ANTES DE COMENZAR, LEA LAS SIGUIENTES ADVERTENCIAS.
- Si las instrucciones no le resultan claras o si tiene alguna duda o pregunta, comuníquese con un instalador calificado. Los residentes de América del Norte pueden comunicarse con el servicio de Atención al cliente de OmniMount al 800.668.6848 o por escrito a info@omnimount.com.
- Si el producto o el hardware está dañado o no se le envió alguna pieza, no realice la instalación ni el montaje. Si necesita piezas de repuesto, comuníquese con el servicio de Atención al cliente de OmniMount al 800.668.6848 o por escrito a info@omnimount.com. Los clientes internacionales deberán comunicarse con un distribuidor local para recibir asistencia.
- Información acerca de los productos que se instalan en la pared:** Este producto está diseñado para ser instalado en paredes verticales con paneles de madera u hormigón. Se define a los paneles verticales como una pared que consiste de un mínimo de paneles de 5 x 10 cm con un espacio entre paneles máximo de 60 cm y un espacio mínimo entre paneles de 41 cm, con un máximo de cobertura de pared (hoja de yeso, listón, yeso) de 13 mm. Para instalaciones a medida contacte a un instalador calificado. Para realizar una instalación segura, la pared elegida debe ser capaz de soportar 4 veces el peso de la carga total. De lo contrario, deberá reforzar la superficie para que cumpla con este requisito. El instalador es el responsable de comprobar que la estructura/superficie de la pared y los tacos que se utilizan en la instalación soporten la carga total de manera segura.
- Este producto no está diseñado para soportar la carga de un televisor CRT o de pantalla plana. Ce produit n'est pas conçu pour supporter le poids d'un téléviseur à écran cathodique ou à écran plat. Ne utilisez este producto para ninguna aplicación que OmniMount no haya especificado.
- Este producto puede contener componentes móviles. Úselo con precaución.
- NO EXCEDA LA CAPACIDAD DE PESO MÁXIMA PARA ESTE PRODUCTO.**

AVERTISSEMENT! - FRANÇAIS

- AVERTISSEMENT!** SI CE PRODUIT N'EST PAS CORRECTEMENT INSTALLÉ OU ASSEMBLÉ, IL RISQUE DE CAUSER DES BLESSURES GRAVES, VOIRE MORTELLES, AINSI QUE DES DOMMAGES MATÉRIELS IMPORTANTS. AVANT DE COMMENCER, LISEZ LES AVERTISSEMENTS SUIVANTS.
- Si vous ne comprenez pas les instructions, de même que si vous avez un doute ou des questions, veuillez contacter un installateur qualifié. Les personnes qui résident en Amérique du Nord peuvent contacter le service à la clientèle OmniMount au 800.668.6848 ou à info@omnimount.com.
- Si vous découvrez que le produit est endommagé ou que des fixations sont manquantes ou endommagées, n'installez pas le produit. Si vous avez besoin de pièces de rechange, contactez le service à la clientèle OmniMount au 800.668.6848 ou à info@omnimount.com. Les clients habitant hors de l'Amérique du Nord peuvent obtenir de l'aide auprès de leur distributeur local.
- Produits s'installant au mur :** Ce produit a été conçu pour une installation sur un mur vertical de béton massif ou construit sur une charpente en bois. Une charpente en bois est une structure murale constituée avec des pièces de colombage d'une épaisseur d'au moins 5 cm x 10 cm ayant un espacement de 41 cm à 60 cm et étant recouverte d'un revêtement d'une épaisseur d'au moins 13 mm (cloison sèche, lattes, plâtre). Veuillez contacter un installateur qualifié pour les installations spéciales. Pour que l'installation soit sécuritaire, le mur d'installation doit pouvoir supporter 4 fois le poids de la charge appliquée. Si tel n'est pas le cas, la surface doit être renforcée en conséquence. L'installateur doit s'assurer que la structure/surface du mur d'installation et les chevilles d'ancrage utilisées peuvent supporter sans danger le poids de tous les équipements.
- Ce produit n'est pas conçu pour supporter le poids d'un téléviseur à écran cathodique ou à écran plat. Este producto no está diseñado para soportar la carga de un televisor CRT o de pantalla plana.
- Ce produit ne doit pas être utilisé pour un usage autre que ceux spécifiés par OmniMount.
- Ce produit peut contenir des pièces mobiles. Utilisez-le avec précaution.
- NE DÉPASSEZ JAMAIS LA CAPACITÉ DE CHARGE MAXIMALE DE CE PRODUIT.**

SYMBOL KEY



EN	Find Center Position
ES	Encuentre la posición del centro
FR	Repérez la position centrale



EN	Adjust
ES	Ajuste
FR	Ajustez

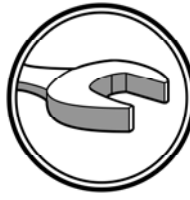

EN	Open-Ended Wrench
ES	Llave española
FR	Clé ouverte



EN	Cable Management
ES	Sistema de organización de cables
FR	Gestion des câbles



EN	Drill
ES	Agujerear
FR	Perçer



EN	Level
ES	Nivel
FR	Niveau



EN	Caution
ES	Precaución
FR	Attention



EN	Optional
ES	Opcional
FR	Optionnel



EN	Remove
ES	Retiré
FR	Retirez

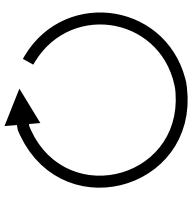

EN	Tighten Fastener
ES	Ajuste el sujetador
FR	Serrez l'attache

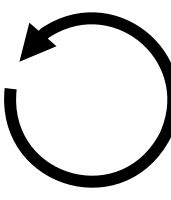

EN	Loosen Fastener
ES	Alloje el sujetador
FR	Desserrez l'attache



EN	Hand tighten
ES	Ajuste manual
FR	Serrer avec les doigts



EN	Pencil Mark
ES	Marque con lápiz
FR	Marque de crayon



EN	Phillips Screwdriver
ES	Destornillador Phillips
FR	Tournevis Phillips



EN	Allen Wrench
ES	Llave Allen
FR	Clé hexagonale



EN	Tools Needed
ES	Herramientas necesarias
FR	Outils requis

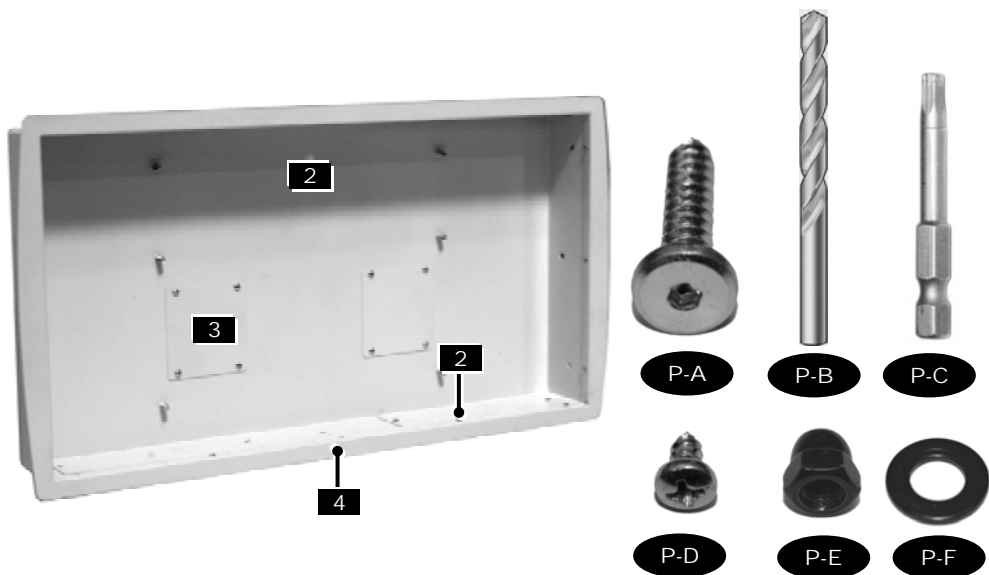

10081vA			
Pouch #	Part #	Qty	Description
1	P-A	9	Low Profile Lag Screws
2	P-B	1	Drill Bit 7/32" x 2"
3	P-C	1	Hex Driver Bit 5/32"
4	P-D	16	Screw 8-32 x 1/4" Type 23 (16 pre-installed)
5	P-E	6	Acorn Hex Nut M8 x 1.25
6	P-F	6	Washer .344" ID x .69" OD x .065" THK
Contents			
N/A	1	1	Wall Box
	2	4	J-box Cover
	3	2	Center Cover
	4	1	Flange

TOOLS NEEDED



EN	Tools Needed	EN	Not included
ES	Herramientas necesarias	ES	No se incluye
FR	Outils requis	FR	Non inclus

OPTION A / ROUGH IN

OPT
A

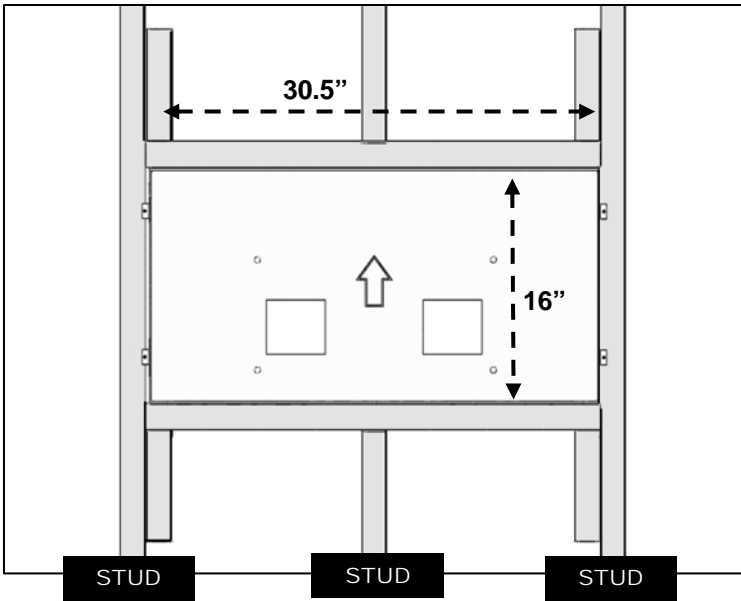

Please contact a qualified contractor for all custom installation. Death or serious injury can occur if proper care is not taken.

Take caution of electrical and plumbing that may be within the wall framing. Serious damage to persons or property can occur from improper construction.

OPTION B / RETRO FIT

OPT
B

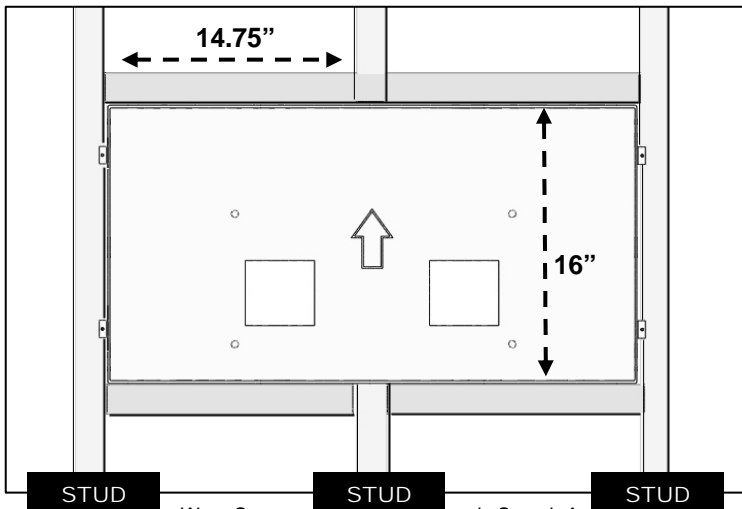

OPT
A

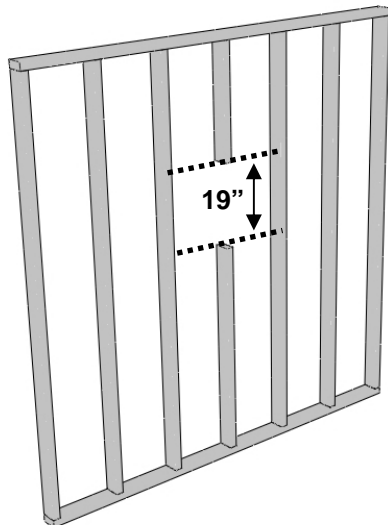
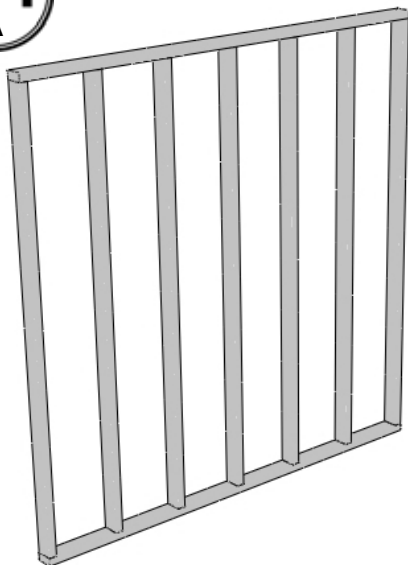

EN	Cut
ES	Corte
FR	Couper

OPTIONS

OPT
B

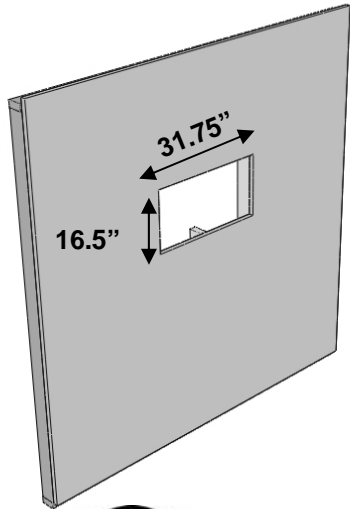
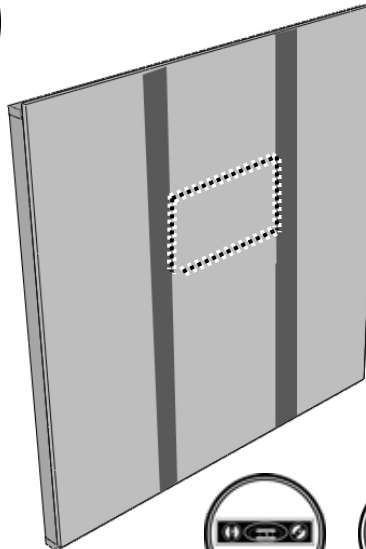

EN	Cut
ES	Corte
FR	Couper

Create support for cut stud. Contact a qualified contractor to review building codes for your area.

OPTIONS

OPT A **OPT B**

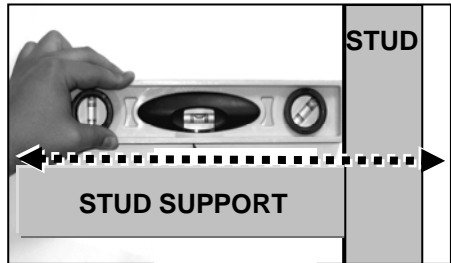
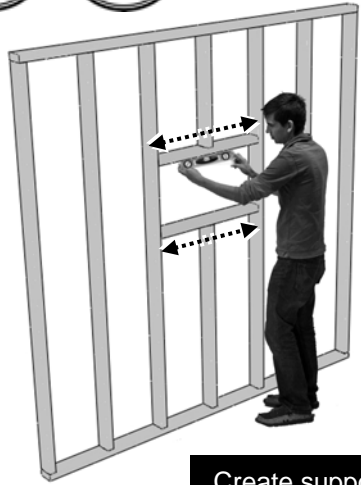

EN Level
ES Nivel
FR Niveau



Good



No Good

Create support for cut stud. **Contact a qualified contractor to review building codes for your area.**

OPTIONS

OPT A

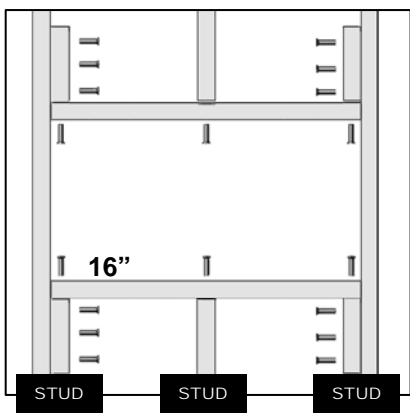

OPT B

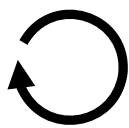
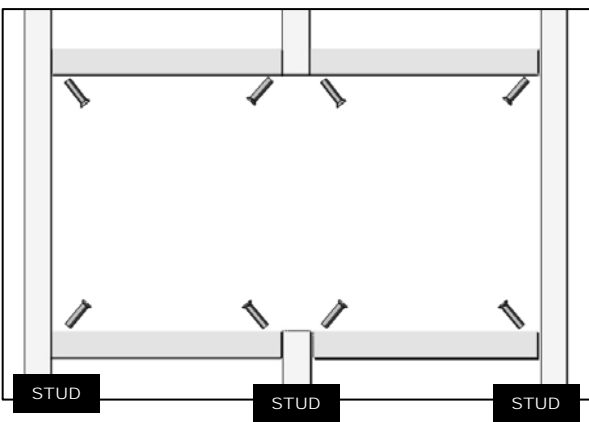

D. Install supports using wood screws (not included).

STEP 1

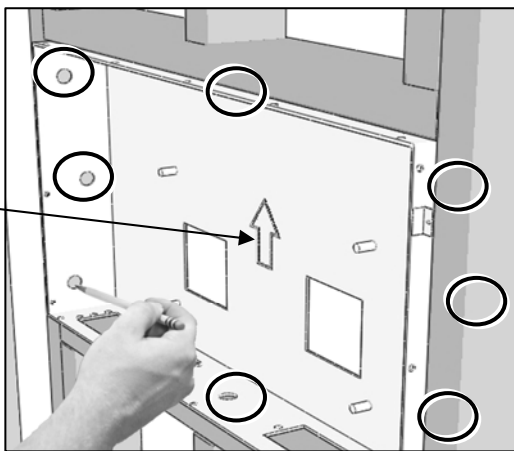

EN Important
ES Importante
FR Important

EN Up
ES Arriba
FR Haut



X 8

EN Use wall box to mark mounting locations
ES Use la guía o placa de la pared para marcar el lugar donde se realizará la instalación
FR Utilisez la plaque ou le gabarit mural pour marquer les emplacements de montage

The cable management covers can be removed in this step to mark locations on the stud for the installation of junction boxes. Use the marked location to cut the stud and install j-box.

Remember to contact a qualified contractor for safe installation of in wall box, and electrical equipment. Death, serious injury, or property damage may occur from improper installation.

STEP 2

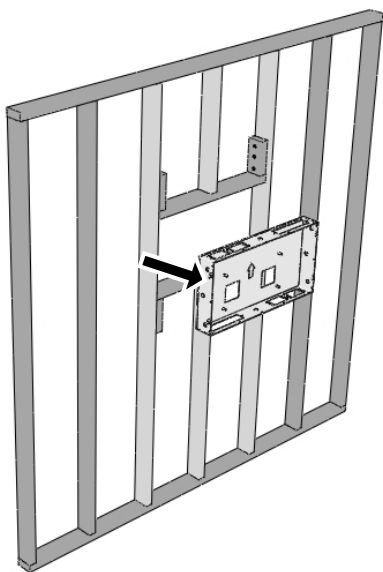

Wood Pilot

Pilot Hole Size	Pilot Drill Depth
7/32" inch	2 inch
4 mm	50 mm

P-B

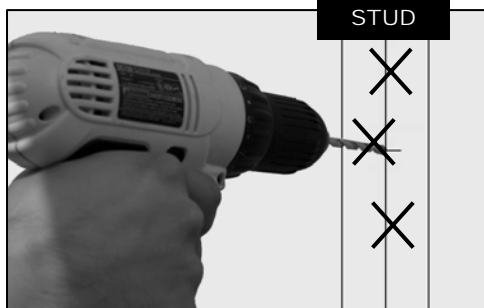

EN Wood Stud Wall Installation
ES Instalación en pared con paneles de madera
FR Installation murale sur poteau de cloison en bois

EN Drill pilot hole
ES Realice el agujero piloto
FR Percez le trou de guidage



STEP 3

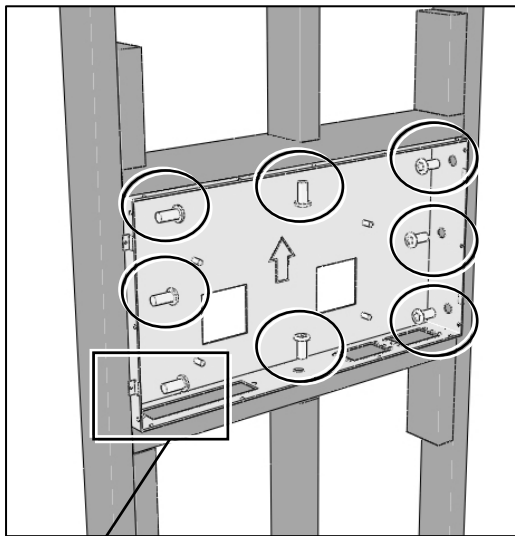
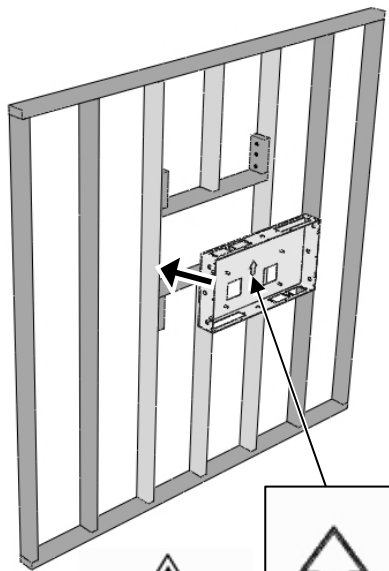

EN	Important	EN	Up
ES	Importante	ES	Arriba
FR	Important	FR	Haut

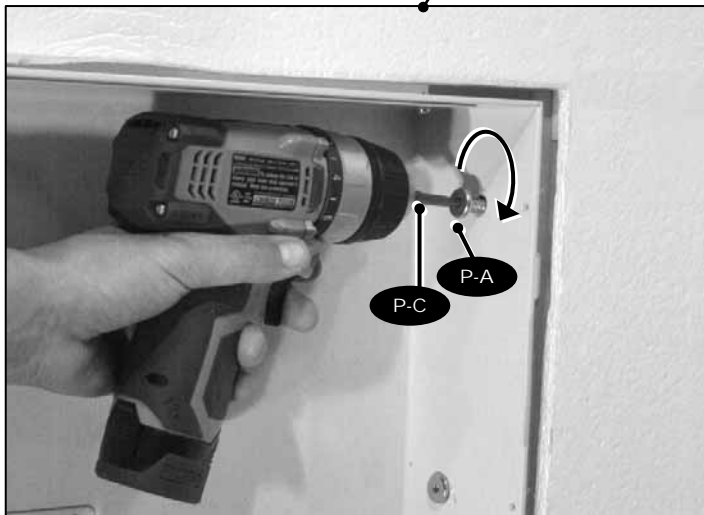

EN	Tighten Fastener
ES	Ajuste el sujetador
FR	Serrez l'attache

**Install Shadow Box using lag screws (Part P-A) and hex drive (Part P-C).
DO NOT OVERTIGHTEN**

STEP 4

OPT
A

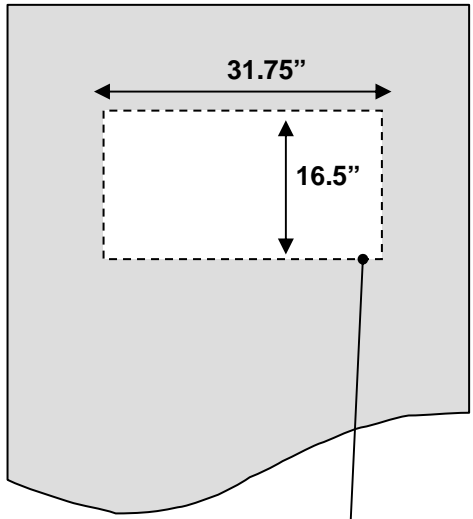
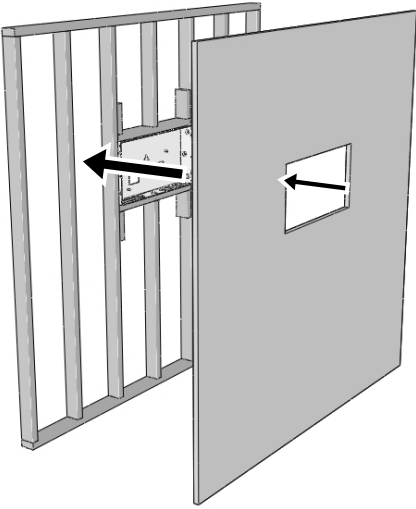

Cut hole in drywall to fit outer dimension of shadow box. Mount drywall to stud (**hardware not included**).

EN	Cut	EN	Install
ES	Corte	ES	Instale
FR	Couper	FR	Installer

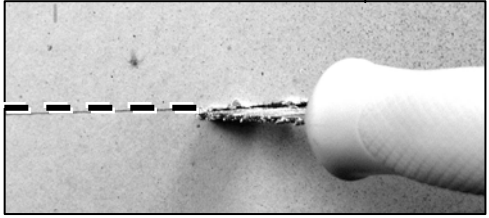

STEP 5

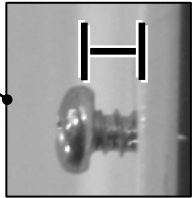
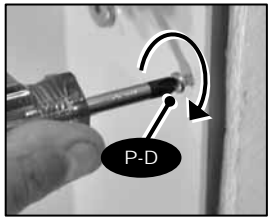
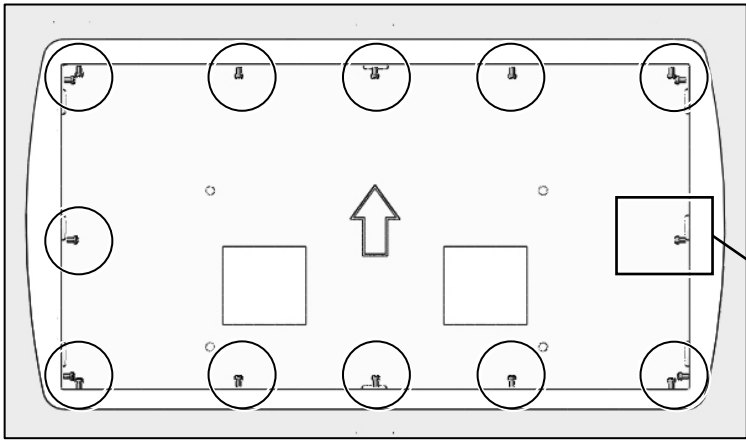

EN	Partially install
ES	Instalación parcial
FR	Installez partiellement



P-D

STEP 6

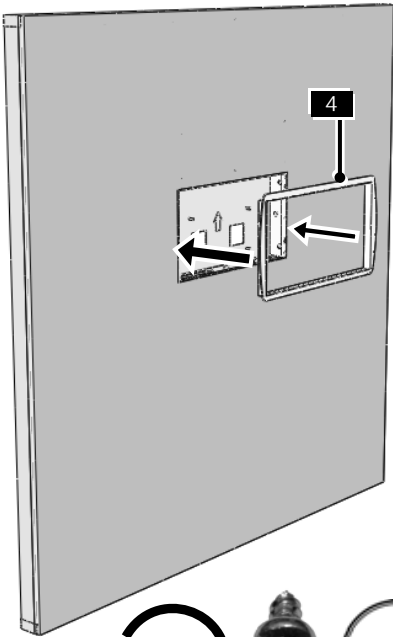

EN Attach cover
 ES Coloque la cubierta
 FR Fixez le cache

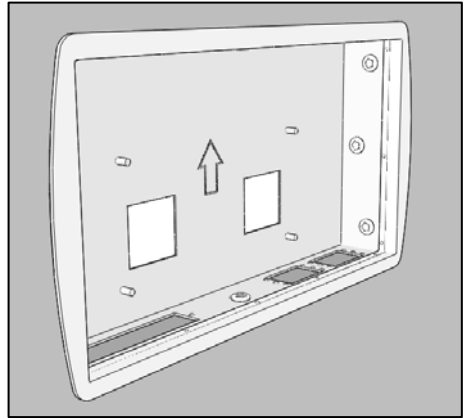

X 16



P-D

EN Tighten Fastener
 ES Ajuste el sujetador
 FR Serrez l'attache

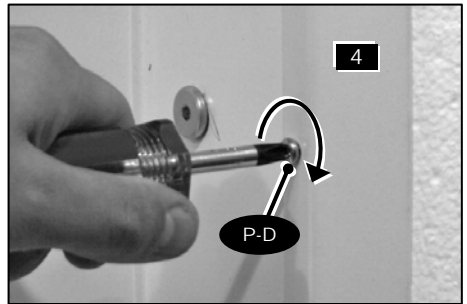

STEP 7

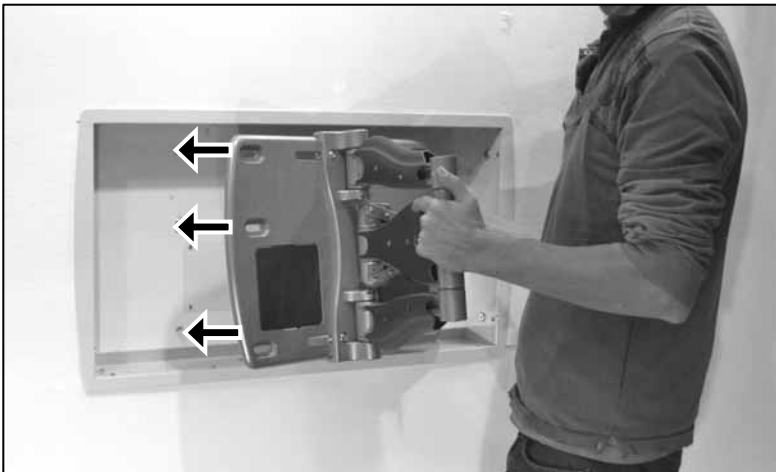

EN Not included
 ES No se incluye
 FR Non inclus

EN Mount wall plate
 ES Coloque la placa de pared
 FR Montez la plaque murale

STEP 8



X 6



P-E



P-F

EN	Tighten Fastener
ES	Ajuste el sujetador
FR	Serrez l'attache

OPTIONS

OPT

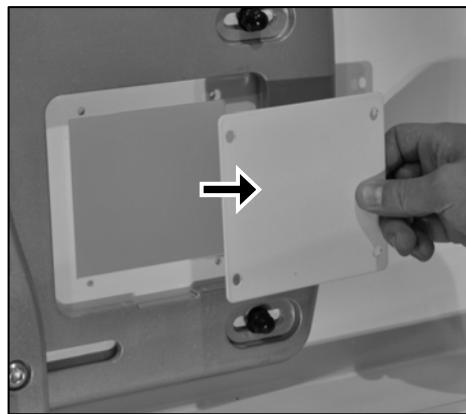

EN	Remove	EN	Cable Management
ES	Retire	ES	Sistema de organización de cables
FR	Retirez	FR	Gestion des câbles

- This warranty applies to US Residents who purchase from an authorized OmniMount Dealer. OmniMount products are covered against defects in materials and workmanship for 5 years. OmniMount will repair or replace the defective component or product, at its sole discretion. Failure to follow product care instructions from OmniMount will result in void of warranty.
- To obtain warranty service, contact OmniMount customer service at 800.MOUNT.IT (800.668.6848) or info@omnimount.com. You must supply a copy of your original receipt. If your product be shipped to OmniMount for inspection, you will be responsible for the shipping charges. Replacement product shipped to you will be returned freight prepaid.
- OmniMount disclaims any liability for modifications, improper installations, installations over the specified weight range, or failure to follow care instructions provided by OmniMount. To the maximum extent permitted by law, OmniMount disclaims any other warranties, expressed or implied, including warranties of fitness for a particular purpose and warranties of merchantability. OmniMount will not be liable for any damages arising out of the use of, or inability to use, OmniMount products. OmniMount bears no responsibility for incidental or consequential damages. This includes, but is not limited to, any labor charges for the repair of OmniMount products performed by anyone other than OmniMount.
- This warranty gives you specific legal rights, and you may also have other rights which vary from state to state.
- Specifications are subject to change without prior notice.

ESPAÑOL

- Esta garantía se aplica a los residentes de los Estados Unidos que realizaron la compra en un distribuidor autorizado de OmniMount. Esta garantía cubre los productos OmniMount de los defectos de materiales y de mano de obra por un período de 5 años. OmniMount, a su exclusivo criterio, reparará o reemplazará el producto o componente defectuoso. En caso de que no se sigan las instrucciones proporcionadas por OmniMount para el cuidado del producto la garantía quedará anulada.
- Para obtener el servicio de garantía, comuníquese con el servicio de Atención al cliente de OmniMount. Llame al 800.MOUNT.IT (800.668.6848) o escribanos a info@omnimount.com. Deberá proporcionar el recibo original. Si fuera necesario enviar el producto a OmniMount para revisarlo, los gastos de envío correrán por su cuenta. El producto de reemplazo que se le envíe se le devolverá con los gastos de envío pagados.
- OmniMount no se hace responsable de modificaciones, instalaciones inadecuadas o instalaciones que superen el rango de peso especificado ni se hace responsable en casos en los que no se hayan seguido las instrucciones proporcionadas por OmniMount. En la medida en que la ley lo permita, OmniMount no se hace responsable de ninguna otra garantía, expresa o implícita, incluso las garantías de aptitud para un fin determinado o de comercialización. OmniMount no se hace responsable de ningún tipo de daños causados por el uso de los productos OmniMount o por el uso inapropiado de dichos productos. OmniMount no es responsable de los daños incidentales o emergentes. Dentro de éstos se incluyen todo tipo de gastos que pudieran surgir de las reparaciones de productos OmniMount que no se hayan realizado en OmniMount.
- Esta garantía le otorga derechos legales específicos. Es posible que además tenga otros derechos que varían según el estado.
- Las especificaciones están sujetas a cambios sin previo aviso.

FRANÇAIS

- Cette garantie s'applique aux résidents des États-Unis qui achètent un produit OmniMount auprès d'un détaillant OmniMount autorisé. Les produits OmniMount sont garantis 5 ans contre les défauts de matériaux et de fabrication. OmniMount se chargera de réparer ou remplacer, à son entière discrétion, tout produit qui s'avèrera défectueux. Le non-respect des directives d'entretien fournies par OmniMount annulera la garantie.
- Pour obtenir une réparation sous garantie, contactez le service à la clientèle OmniMount au 800.MOUNT.IT (800.668.6848) ou à info@omnimount.com. Vous devrez fournir une copie de votre reçu d'achat original. Si votre produit doit être expédié à un centre de réparation OmniMount pour y être inspecté, vous devrez payer les frais de port. Le produit de remplacement vous sera envoyé en port payé.
- OmniMount rejette toute responsabilité relativement à quelque problème pouvant être associé à une modification d'un produit, à une mauvaise installation ou à une installation ne respectant pas les limites de charge, ou du non-respect des directives d'entretien fournies par OmniMount. Sous réserve des lois en vigueur, OmniMount réfute toute autre garantie expresse ou implicite, notamment toute garantie de commercialisation ou de convenance à un usage quelconque. OmniMount réfute toute responsabilité pour des dommages résultants de l'utilisation ou de l'impossibilité d'utiliser des produits OmniMount. OmniMount réfute également toute responsabilité pour quelque dommage accessoire ou indirect. Ceci s'applique notamment aux frais de main d'œuvre pour la réparation de produits OmniMount par une personne ne travaillant pas pour OmniMount.
- Cette garantie vous accorde des droits juridiques spécifiques, mais il est possible que vous ayez également d'autres droits selon votre lieu de résidence.
- Les spécifications sont susceptibles d'être modifiées sans préavis.

(EN) English	THANK YOU FOR PURCHASING AN OMNIMOUNT PRODUCT
(ES) Spanish	GRACIAS POR ADQUIRIR UN PRODUCTO DE OMNIMOUNT
(FR) French	MERCI D'AVOIR ACHETÉ UN PRODUIT OMNIMOUNT



OmniMount Systems, Inc.
8201 South 48th Street
Phoenix, AZ 85044-5355

1-800-MOUNT-IT (1-800-668-6848)
www.omnimount.com

Free Manuals Download Website

<http://myh66.com>

<http://usermanuals.us>

<http://www.somanuals.com>

<http://www.4manuals.cc>

<http://www.manual-lib.com>

<http://www.404manual.com>

<http://www.luxmanual.com>

<http://aubethermostatmanual.com>

Golf course search by state

<http://golfingnear.com>

Email search by domain

<http://emailbydomain.com>

Auto manuals search

<http://auto.somanuals.com>

TV manuals search

<http://tv.somanuals.com>