

# The SAM3G User Guide

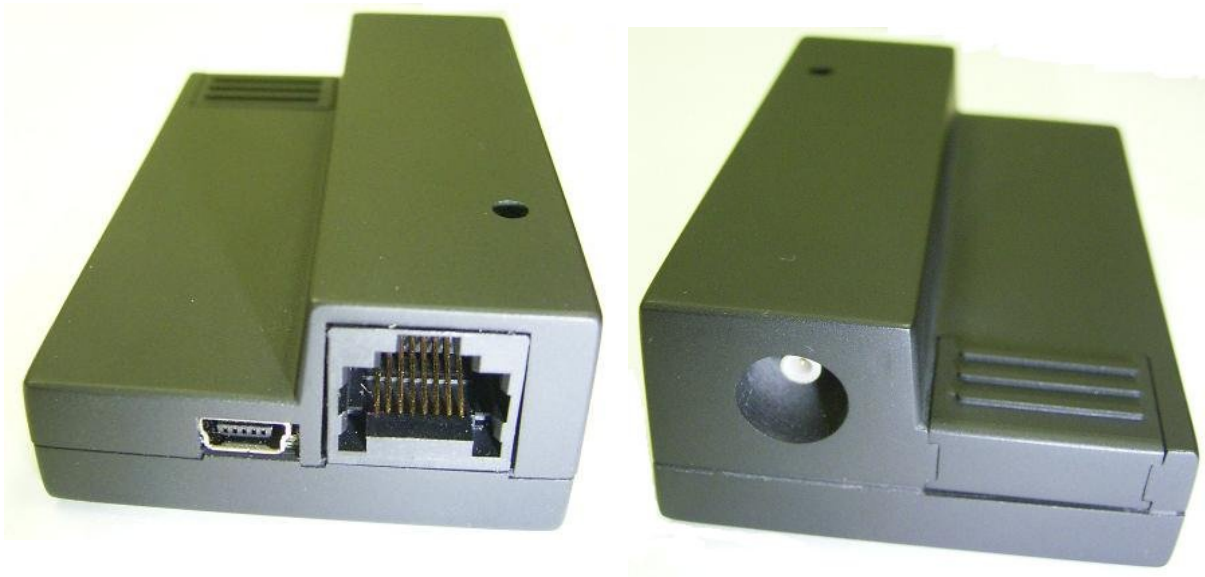

## Document history

18th May 2007 : Start version 1.0

## Contents

1. Introduction
2. Safety precautions
3. Radio frequency exposure - SAR
4. WEEE Directive 2002/96/EC - disposal of old electronic equipment
  
5. Packaging
6. Functionality
  - a. General
  - b. The RJ45 socket
  - c. The MiniB USB connector
  - d. The SMB-Jack 50Ω antenna connector
  - e. The USIM holder
  - f. The LED status
  - g. The Data cable
  
7. Electrical characteristics
  - a. Power consumption
  - b. RF bands
  - c. Receive sensitivity
  - d. Conducted transmit power tolerances
  - e. Main antenna specifications
  
8. Operation
  - a. Using the USB port
  - b. Using the serial RS232 port

## 1. Introduction

The SAM3G is a compact, light-weight, UMTS based modem. It provides GSM, GPRS, EDGE and WCDMA connectivity.

- GSM, GPRS, EDGE : 850MHz, 900MHz, 1800MHz, 1900MHz
- UMTS, WCDMA/HSDPA : 850MHz, 1900MHz, 2100MHz

The SAM3G is designed for both mobile and fixed M2M applications. It has an RJ45 socket for both input voltage and serial RS232 signals, a MiniB USB connector, a SMB-Jack for antenna connection, a SIM holder and an LED indicator.

The SAM3G is capable of sending/receiving SMS, Circuit switched data and Packet-switched data.

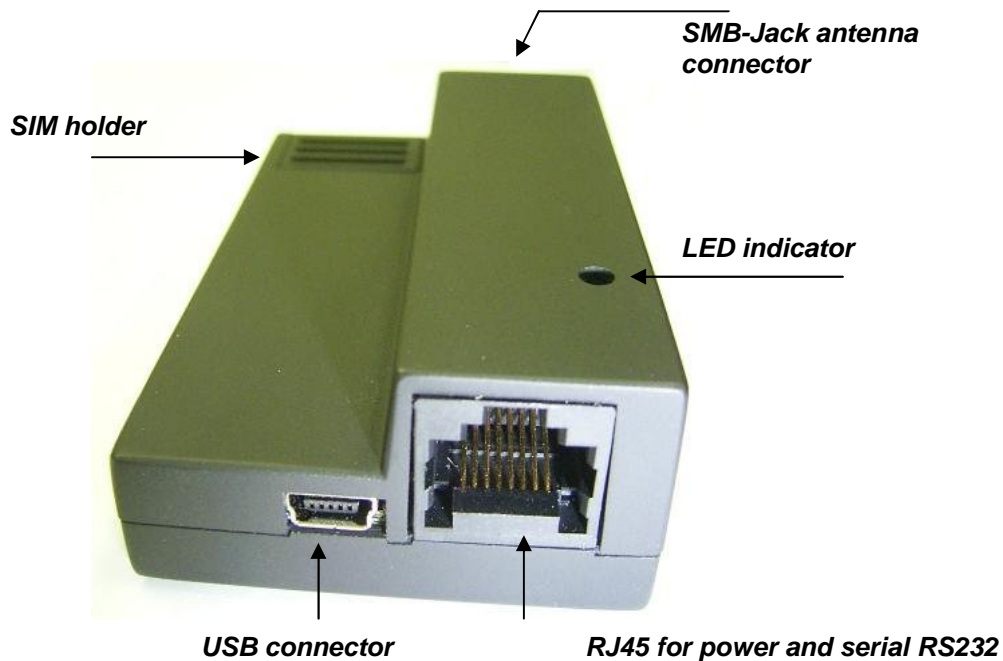

## 2. Safety Precautions

The following safety precautions must be observed whenever the SAM3G modem is in operation or in service. Failure to comply with these precautions violates the safety standards of the design, manufacture and intended use of the product

- Switch off the SAM3G modem :
  - In hospitals or places where medical equipments may be in use.
  - In an aircraft
  - Refueling points
  - Explosive areas
- Restricted use of the SAM3G modem
  - Near any chemical plant
  - Near any Fuel depot
  - Areas with mobile phone warning signs

Respect national regulations on the use of cellular devices. Road safety always comes first

The SAM3G modem receives and transmit radio frequency energy while switched on, therefore interference can occur if the SAM3G is near TVs, radios, PCs or any inadequately shielded equipments.

## 3. Radio frequency exposure - SAR

The SAM3G modem is a low-power transceiver, similar to a typical handheld GSM/GPRS/UMTS mobile phone. When it is turned on, it will emit low-level radio frequency energy.

There are different guidelines and standards around the world that govern the permitted levels of radio frequency exposure for general population. The levels include a safety margin to a human body.

The Specific Absorption rate (SAR) is a measure of the rate at which radio frequency energy is absorbed by the body when exposed to radio frequency electromagnetic field. The SAR value is determined at the highest certified power level in the laboratory conditions, but the actual SAR level of the transceiver while operating can be well below this value. This is because the transceiver is designed to use minimum power to connect to the network.

The SAM3G modem is approved to use in applications where the **antenna is placed more than 20cm from the body.**

For other applications, the integrator is responsible for the local SAR requirements.

#### 4. WEEE directive 2002/96/EC, disposal of old electronic equipment



This symbol on the product indicates that this product shall not be treated as household waste. It must be placed at an appropriate collection point for the recycling of electrical and electronic equipments.

By ensuring the correct disposal of this equipment, it will help the environment and human's health. The recycling will help to conserve the natural resources.

***The SAM3G product is RoHS compliant***



## 5. Packaging

The SAM3G package consists of :

- A SAM3G modem
- A data cable
- A one-page Specification of the SAM and its pinouts
- A SAM3G User Guide

The carton box diameter is 120mm x 95mm x 60mm

The Data cable is 2m long

The Label diameter is 50mm x 33mm



The Power supply is available on request. It is recommended that the SAM3G is powered using a 12Vdc/1A power supply.

The Antenna is also available on request. Make sure the correct antenna is used to get optimised performance from the SAM3G.

## 6. Functionality

### a. General

The SAM3G modem consists of an RJ45 connector for serial port and input power, a miniB USB connector, an SMB Jack antenna connector and a SIM holder. The LED indicator, located on top, indicates the SAM operating status.

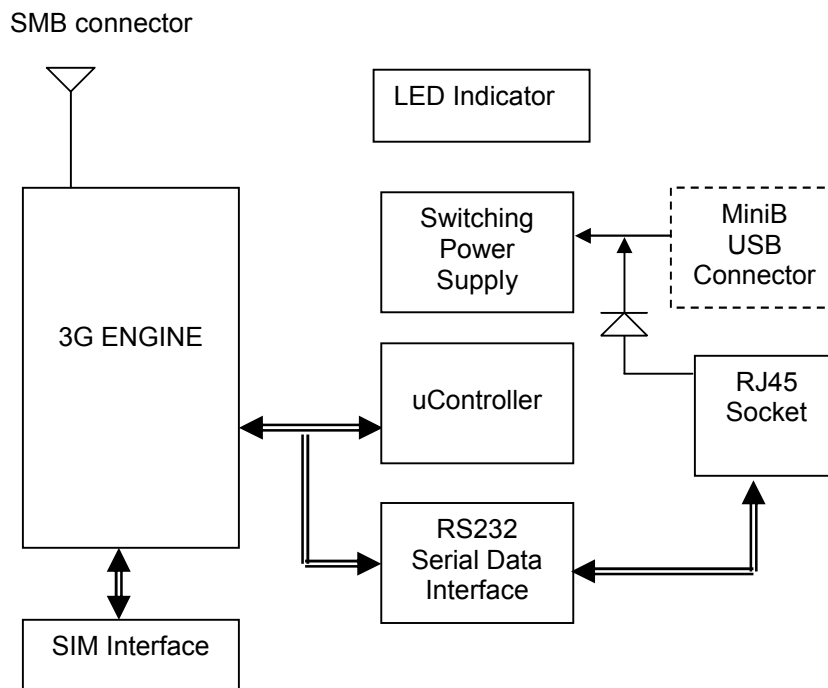

*The SAM3G Functional Block Diagram*

**b. The RJ45 socket**

<b>Pin</b>	<b>Signals</b>	<b>Description</b>
1	VIN	Input voltage 5Vdc - 32Vdc
2	DCD	Data Carrier Detect
3	N/U	Not used
4	GND	Common Ground
5	RXD	Serial Data out of the SAM
6	TXD	Serial Data into the SAM
7	RTS	Ready to Send
8	CTS	Clear to Send

**c. The MiniB USB connector**

**Pin Signal**

1	VIN
2	D-
3	D+
4	N/C
5	GND

**Important Note : RS232 and USB ports must not be connected/operated simultaneously**

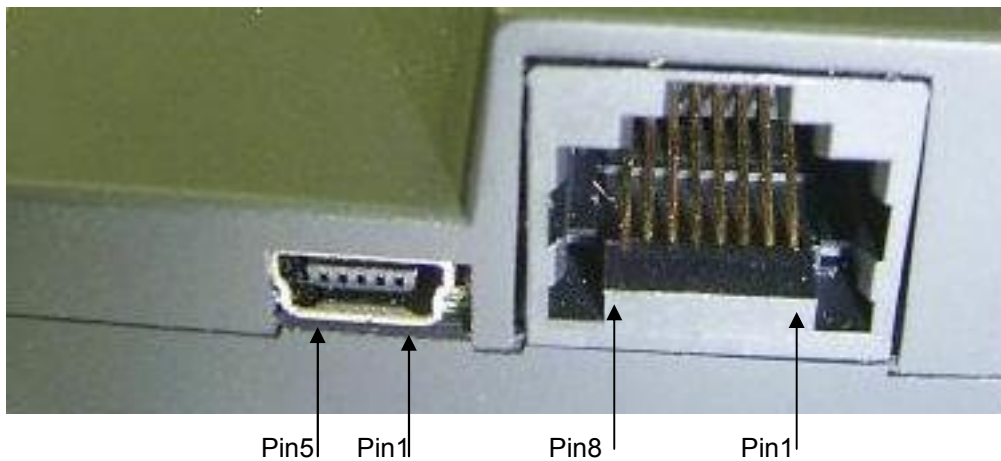



**d. The SMB-Jack 50Ω antenna connector**

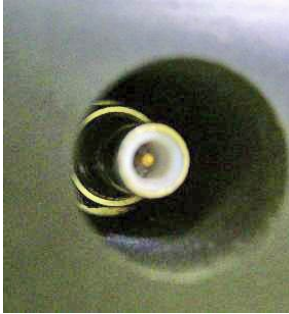

**e. The USIM holder**

To insert the SIM card, remove the door by sliding it back toward the end. Make sure the SIM card faces the right way as indicated on the box. Voltage levels over this USIM interface complies with 3GPP standards



**f. The LED status**

The LED indication has the following status :

- LED on steady : The SAM3G is on and connected, but not transmitting/receiving data
- LED flashes slowly : The SAM3G is on and searching for network connection
- LED flashes intermittently : The SAM3G is in use (transmit/receive data)
- LED is off : No power

**g. The data cable**

The data cable is 2m long. It consists of an RJ45 plug, a DB9-female connector and a 2-wire input power.

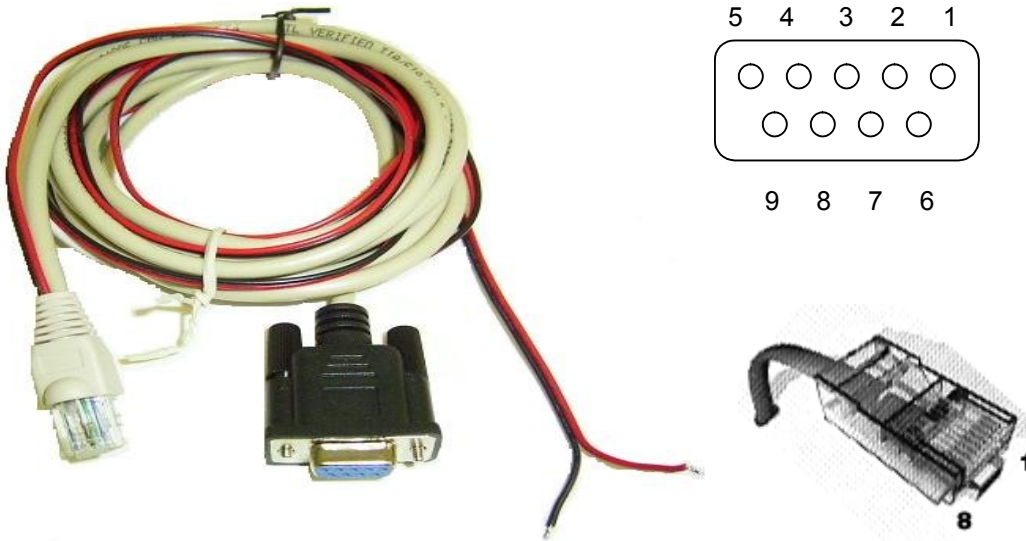

DB9	Signals		RJ45	Description
1	DCD	↔	2	Data Carrier Detect
2	RXD	↔	5	Serial Data out of the SAM3G
3	TXD	↔	6	Serial Data into the SAM3G
4	DTR		3	Not used
5	GND	↔	4	Common Ground
6	DSR			
7	RTS	↔	7	Ready to Send
8	CTS	↔	8	Clear to Send
9	RI			
			1	RED wire : Input voltage from 5Vdc to 32Vdc
			4	BLACK wire : Power Ground

## 7. Electrical characteristics

### a. Power consumption

Vin = 12Vdc	HSDPA/WCDMA	GSM/GPRS/EDGE
Low Power mode	4mA	4mA
Normal mode	90mA	80mA
@ 0dBm Tx power	151mA	-
@ 15dBm Tx power	200mA	-
@ 21dBm Tx power	250mA	-
Maximum peak	500mA	
@ 5dBm Tx power	-	151mA
@ 13dBm Tx power	-	130mA
@ 33dBm Tx power	-	170mA
Maximum peak	-	830mA

### b. RF bands

GSM850 :	Tx = 824MHz - 849MHz, Rx = 869MHz - 894MHz
EGSM900 :	Tx = 880MHz - 915MHz, Rx = 925MHz - 960MHz
DCS1800 :	Tx = 1710MHz - 1785MHz, Rx = 1805MHz - 1880MHz
PCS1900 :	Tx = 1850MHz - 1910MHz, Rx = 1930MHz - 1990MHz
UMTS2100 :	Tx = 1920MHz - 1980MHz, Rx = 2110MHz - 2170MHz
UMTS1900 :	Tx = 1850MHz - 1910MHz, Rx = 1930MHz - 1990MHz
UMTS850 :	Tx = 824MHz - 849MHz, Rx = 869MHz - 894MHz

### c. Receive sensitivity

Band	Typical Rx Sensitivity (dBm)	Maximum Rx Sensitivity (dBm)
GSM850 (2% ber) CS	-107.5	-106
EGSM900 (2% ber) CS	-107.5	-106
DCS1800 (2% ber) CS	-106.5	-105
PCS1900 (2% ber) CS	-106.5	-105
UMTS2100(.1% ber) 12.2Kbps	-110.5	-109
UMTS1900(.1% ber) 12.2Kbps	-110.5	-109
UMTS850(.1% ber) 12.2Kbps	-110.5	-110

**d. Conducted Transmit Power tolerances**

Parameter	Conducted Tx Power	Note
GSM850 & GSM900 CS	+32dBm ±1dBm +27dBm ±1dBm	GMSK mode, connectorized (Cl.4) 8PSK mode, connectorized (Cl.E2)
DCS1800 & PCS1900 CS	+29dBm ±1dBm +626Bm ±1dBm	GMSK mode, connectorized (Cl.1) 8PSK mode, connectorized (Cl.E2)
UMTS1900 & 850 12.2Kbps	+23dBm ±1dBm	connectorized (Cl.3)
UMTS2100 12.2Kbps	+23dBm ±1dBm	connectorized (Cl.3)

**e. Main antenna specifications**

Frequency band (MHz)	Network type	VSWR test frequency (MHz)
824-894	GSM,GPRS,EDGE,UMTS CDMA	Low : 824 Mid : 859 High : 894
880-960	GSM,GPRS,EDGE	Low : 880 Mid : 920 High : 960
1710-1880	GSM,GPRS,EDGE	Low : 1710 Mid : 1795 High : 1880
1850-1990	GSM,GPRS,EDGE,UMTS CDMA	Low : 1850 Mid : 1920 High : 1990
1920-2170	UMTS	(Tx : 1920-1980) Low : 1920 Mid : 1950 High : 1980 (Rx : 2110-2170) Mid : 2110 Mid : 2140 Mid : 2170

The maximum antenna gain recommended, for consideration against RF exposure and ERP/EIRP limits, is :

- In Cellular band : 8dBi
- In PCS band : 4dBi

## 8. Operation

The SAM3G can support *either* the USB port *or* the Serial RS232 port. The port configuration is done at the point of sale. **Do not operate these 2 ports at the same time !**

### 8.1 Using the USB port

#### a. *Installing the USB driver*

**Note :** If the old driver version has been installed, it must be removed, before installing the latest driver. To uninstall the old driver, follow these steps :

- Open the **Control Panel**
- Double click **System**, System Properties window appears
- Select the **Hardware** tab
- Select the **Device Manager**
- Expand the **Universal Serial Bus controllers** to show the installed devices.
- Right click the **Sierra Wireless MC87xx device** entry and choose **Uninstall**.
- Click **OK** to confirm.

**Step1 :** Locate and run the DriverInstaller.exe . Note that there is no feedback, just wait a few moments for the program to run.

**Step2 :** Connect the SAM3G to the PC, using the supplied USB cable. Several **Found New Hardware** balloons appear above the tool tray as the system detects the new devices. After the devices are detected, the Device Manager will show, in the following categories :

- Network Adapters : Sierra Wireless HSDPA Network adapter.
- Port (COM&LPT) :
  - Sierra Wireless AT Command port (UMTS)
  - Sierra Wireless CNS port (UMTS)
  - Sierra Wireless Data Port (UMTS)
  - Sierra Wireless DM Port (UMTS)
- Universal Serial Bus Controllers : Sierra Wireless MC87xx device

#### b. *Installing the 3G\_Watcher*

**Note :** If the old Watcher has been installed, it must be removed before installing the latest Watcher. To uninstall the old Watcher, follow these steps :

- Open the **Control Panel**
- Double-click **Add or Remove programs**
- Select **Sierra Wireless 3G Watcher**
- Click **Change/Remove**

**Step 1 :** Run the 3G\_Watcher.exe, the 3G\_Watcher welcome-window, appears, click **Next**

**Step 2 :** Select Australia region, click **Next**

**Step 3 :** Select " I accept the terms in the license agreement" , click **Next**

**Step 4** : Use the default folder, click **Next**

**Step 5** : Click **Install**, then **Finish**

### c. Connection

Connect the SAM3G to the PC using the supplied USB cable. After connection, the PC will automatically detect the SAM3G and run the 3G\_Watcher.

To set up the data profile, go to the "Tools" option, select "Connections" -> "Profile" then enter Profile name, User name, Password, Access Point Name (APN) and Connection type. PDP type default is IP.

## **8.2 Using the Serial RS232 port**

The SAM3G has 2 different configurations for the serial port : General configuration and Meter configuration.

### a. General configuration :

In this configuration, the SAM3G's default terminal speed is 115200bps, data format is 1+8+1. There are only 4 serial data signals supported, namely RXD, TXD, RTS and CTS.

### b. Meter configuration :

In this configuration, the SAM3G will be controlled by an internal micro-controller, its default terminal speed is 9600bps, 1+8+1. There are 5 serial data signals supported, namely RXD, TXD, RTS, CTS and DCD.

### c. Connection :

To test the serial port configuration, follow these steps :

- Insert the USIM card into the SAM3G
- Connect the Antenna
- Connect the SAM3G to the PC's COM port using the supplied serial cable (RJ45-DB9).
- On the PC, run a terminal program, ex. HyperTerminal, set the program speed at either 115200bps, or 9600bps.
- Connect the 12Vdc to the SAM3G Red+Black wires

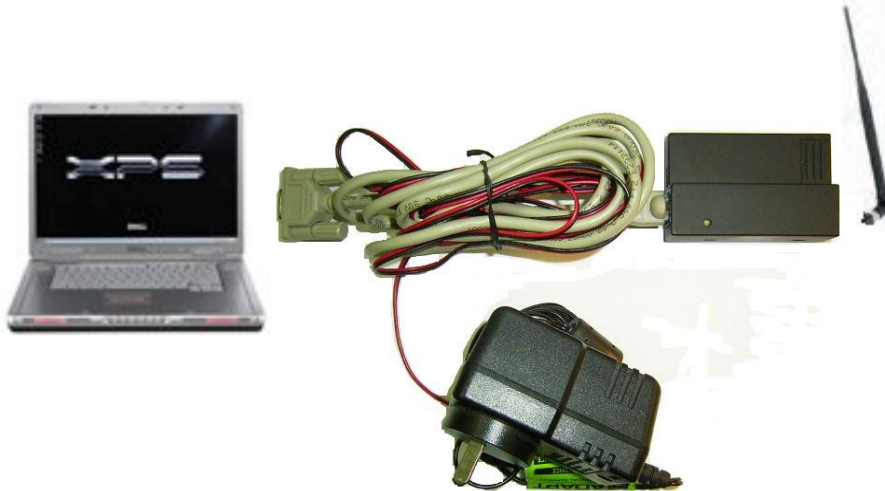

**SAM3G typical connection to test the serial RS232 configuration**

**d. AT commands :**

The SAM3G modem supports **most** of the AT commands specified in the following standards :

- 3GPP TS 27.005 : Control SMS functions for devices on GSM/WCDMA networks
- 3GPP TS27.007 : Control devices operating on GSM/WCDMA networks
- ITU-T V.250 : Control serial communications over an asynchronous interface

For details of the AT commands, refer to the “**Supported AT command reference**” manual.

## Free Manuals Download Website

<http://myh66.com>

<http://usermanuals.us>

<http://www.somanuals.com>

<http://www.4manuals.cc>

<http://www.manual-lib.com>

<http://www.404manual.com>

<http://www.luxmanual.com>

<http://aubethermostatmanual.com>

Golf course search by state

<http://golfingnear.com>

Email search by domain

<http://emailbydomain.com>

Auto manuals search

<http://auto.somanuals.com>

TV manuals search

<http://tv.somanuals.com>