

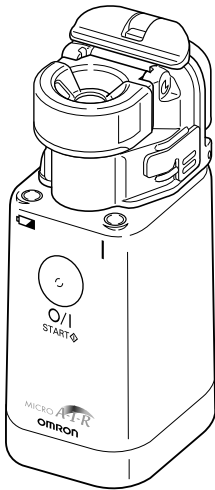

# INSTRUCTION MANUAL

## MESH NEBULIZER

Model **NE-U22**



Thank you very much for purchasing OMRON Mesh Nebulizer.

Be sure to read this Instruction Manual before using the unit for you to use it safely and correctly.

Keep this Instruction Manual always at hand for your future reference.

### Before Using the Unit

- Notes on Safety . . . . . 2
- Product Features . . . . . 5
- Product Contents . . . . . 5
- Names and Functions of the Parts . . . . . 6
- How to Assemble the Main Unit. . . . . 8

### Correct Use of the Unit

- How to Prepare the Power Source . . . . . 10
- How to Fill the Medication . . . . . 12
- How to Select the Nebulization Mode . . . 14
- How to Inhale. . . . . 15
- How to Clean the Unit after Inhalation. . . 16

### How to Disinfect the Unit

- How to Disinfect. . . . . 18
- How to Replace the Mesh Cap . . . . . 19

### Troubleshooting

- How to Carry the Unit . . . . . 20
- Troubleshooting . . . . . 21
- Specifications / Option parts . . . . . 22

This unit is a medical instrument. Be sure to follow the instructions of a doctor and use the unit correctly. For the type, dose, and regimen of medication, be sure to follow the instructions of a doctor.

This unit is not appropriate to use as a household inhalator for humidifying the mucous membranes of throat and nose.

The nebulization characteristics of this unit differ by the properties of medication. Especially with the use of a medication having high surface activity or viscosity such as medication solubilizing agent or expectorant, the nebulization rate may be reduced. The nebulization rate may also be reduced when the temperature of medication is low.

This unit cannot nebulize distilled water.

The electromagnetic compatibility of this unit conforms to the Medical Electric Instrument EMC Standard IEC60601-1-2 (1993 version).  
The illustrations in this Instruction Manual are image drawings.

**A Good Sense of Health**

# Notes on Safety Be sure to read the notes on safety before using the unit.

- The warning signs and the sample icons shown here are listed for you to use this product safely and correctly as well as to prevent the risk and the damage to you and others from happening.
- The icons and meanings are as follows.

Before Using the Unit

Notes on Safety

## Warning

For the type, dose, and regimen of the medication, be sure to follow the instructions of a doctor.

- Your symptom(s) may worsen.

When you use the unit for the first time after purchasing it or after not using it for a long period of time, be sure to clean and disinfect Medication Bottle, Mesh Cap, Inhalation Mask, Mouthpiece, and Mask Adapter. (Refer to Pages 14 to 16.)

- Miscellaneous bacteria may propagate and you may get infected.

Clean and disinfect Medication Bottle, Mesh Cap, Inhalation Mask, Mouthpiece, and Mask Adapter after each use. (Refer to Pages 14 to 16.)

Be sure to dry the cleaned and disinfected parts promptly, and store them in a clean place.

- Miscellaneous bacteria may propagate and you may get infected.

When the unit is used by more than one person, be sure to use the disinfected Medication Bottle, Mesh Cap, Inhalation Mask, Mouthpiece, and Mask Adapter for each user.

- The user may be infected.

Keep the unit out of reach of children or infants.

- They may swallow small pieces such as Mesh Cap. The Main Unit may be damaged or may cause injury to children or infants. In case a child swallows a Mesh Cap, immediately consult with a doctor.

Do not plug in or pull out the AC Adapter from the electric outlet with wet hands.

- You may suffer electric shock or get burned.

Do not wash the Main Unit and AC Adapter with water or hot water.

Do not immerse them in water.

- The unit may experience electricity leakage or you may suffer electric shock.
- The unit will cause trouble and may not be able to be used.



## Caution

Rinse off the disinfectant from the disinfected parts with water thoroughly.

- If you inhale from the nebulizer with residual disinfectant, your symptom(s) may worsen.



If you are not going to use the unit for a long period of time, be sure to unplug the power plug from the electric outlet.

- You may suffer electric shock or the unit may experience electricity leakage or catch fire.



Do not use disinfection solution containing sodium hypochlorite.

- The Mesh may not be able to be used after getting covered with rust.

Do not inhale by using water in the medication bottle.

- Your symptom(s) may worsen.

Do not drop medication on the Main Unit or AC Adapter. If you drop medication, immediately wipe it off with gauze.

- If you use the unit while it is wet, it may cause trouble or you may suffer electric shock.

Do not poke Mesh or Vibrator with a cotton swab or a pin.

- The unit may be broken and cannot be used.

Do not drop or apply strong shock to the Main Unit, AC adapter, Medication Bottle, or Mesh Cap.

- They may be broken and cannot be used or you may suffer electric shock.

Do not use the AC adapter other than the one supplied by Omron. Do not use a broken AC adapter. (AC adapter is an optional part.)

- It may catch fire, you may suffer electric shock or the main unit may cause trouble.



Do not disassemble, repair, or modify the unit.

- You may suffer electric shock or injure yourself. The unit may experience electricity leakage or catch fire.

## Product Features

**1 Newly developed alloy mesh and titanium vibrator**  
**Superior mesh technology that improves nebulization efficiency.**

**2 Pocket-sized unit.**

As the unit is small enough to be placed in the pocket, you can easily carry it around wherever you go.

**3 Inhalation possible at various tilt angles.**

The new bottle structure enables inhalation at various tilt angles. Nebulization remains stable even when the unit is tilted.

Before Using the Unit

## Product Contents Please check the product.

The following items are contained in the box. If any item is missing, please contact the store where you purchased the product or the nearest OMRON dealer.

1. Main Unit  
Cover

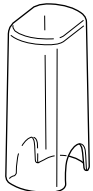

2. Main Unit



3. Medication  
Bottle



4. Mesh Cap  
(with Mesh)



5. Mask  
Adapter



6. Mouthpiece



7. Inhalation Mask (S)  
(with rubber string)



8. Inhalation Mask (L)  
(with rubber string)

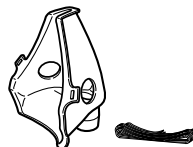

9. Storage bag

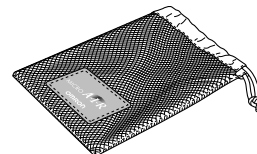

10. Instruction Manual

Features of the Product / Construction of the Product

### To start inhalation, you must assemble the unit.

Please read the section on "How to Assemble the Main Unit" and understand the points for assembling before starting to use the unit.

(Refer to Pages 6 and 7.)



# Names and Functions of the Parts

Names and Functions of the Parts

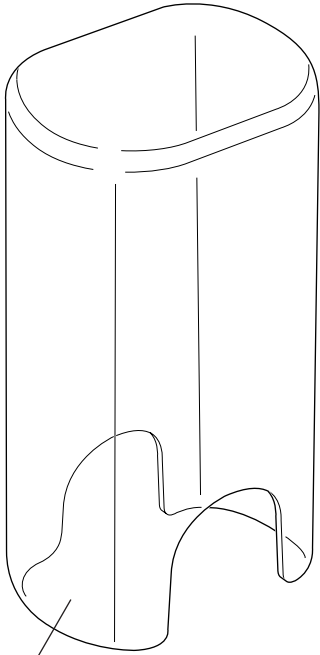

**Main Unit Cover**  
Used for storing or carrying the unit.

**Mesh Cap**  
An alloy mesh is installed for nebulization.  
- Mesh Cap is consumable.

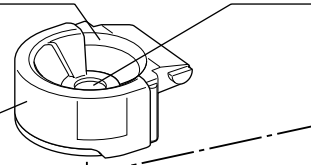

A figure viewed from the above

**Mesh Cap Cover**  
Protects the Mesh.

**Medication Port**  
Fill the medication by opening the Mesh Cap.

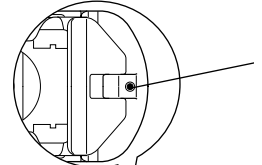

**Vibrator**  
The tip of this Vibrator vibrates at high frequency and pushes out medication from the pores of Mesh.

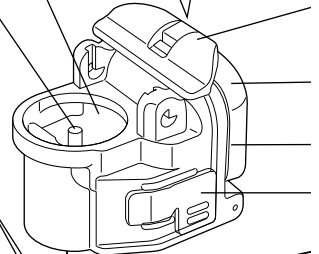

**Electrode**  
A contact point connecting the Main Unit and the Medication Bottle.

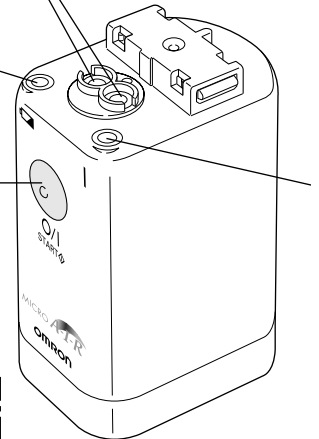

**Battery Low Indicator**  
An orange light flashes when the batteries are worn.

**Button**  
Turns on and off the power with a push of the Button.

**Battery Cover Disengaging Lever**  
Opens and closes the Battery Cover.

**Battery Cover**

**AC Adapter Jack to Electrode**  
Connects the Main Unit and AC Adapter.

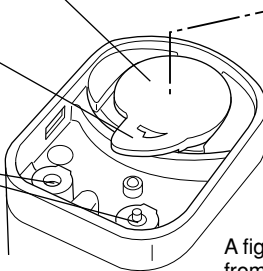

A figure viewed from the rear

A figure viewed from the rear

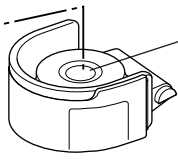

**Nebulization Port**  
Nebulize medication here.

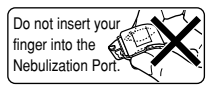

**Mesh**  
Efficient nebulization is realized from the minute pores.  
- Mesh is an extremely minute part. Handle it carefully.

**Air Port**  
Stabilizes nebulization.

**Medication Bottle Cap Locking Lever**  
Opens the Medication Bottle Cap.  
- Do not open Medication Bottle Cap except when washing Medication Bottle.

**Medication Bottle Cap**

**Medication Bottle**  
Stores the medication.

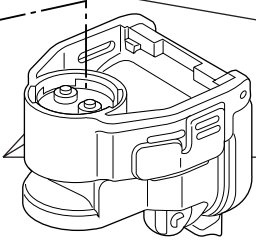

**Medication Bottle Disengaging Button**  
Medication Bottle can be removed when the Buttons on both sides of the Medication Bottle are pressed.

**Electrode**  
Connects the Main Unit and the Power Source.

A figure viewed from the rear

**Power Indicator**  
A green lamp turns on when the power is on.



**AC Adapter as Optional Supply**

**Electrode**  
Supplies the power to the Main Unit.

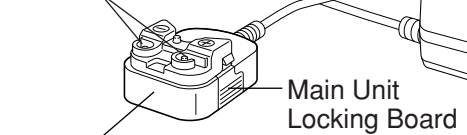

**AC Adapter Connection Stand**

**Main Unit Locking Board**

**Cord Band**

**AC Adapter**

**Power Plug\***

\* Actual power plug may not be the same as illustration.

# How to Assemble the Main Unit

## First, check how to assemble the unit.

You must assemble the unit before starting to use it.

You may find the parts slightly hard to assemble because they are made to prevent the medication from leaking.

Be sure to clean and disinfect the unit before using. Dry the unit after cleaning and disinfecting. (Refer to Pages 14 to 16.)

Before Using the Unit

How to Assemble the Main Unit

## 1 Install the Mesh Cap on the Medication Bottle.

- Do not insert the Mesh Cap in the opposite direction.

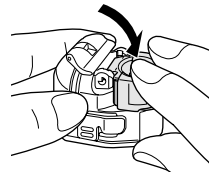
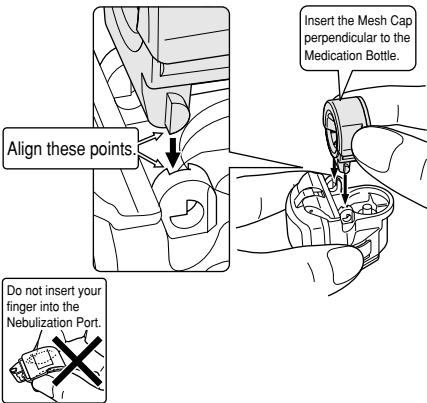

Securely close the Mesh Cap and the Medication Bottle.

Installation is complete.

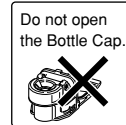
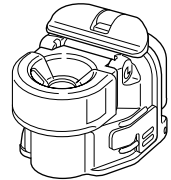

## 2 Install the Medication Bottle to the Main Unit.

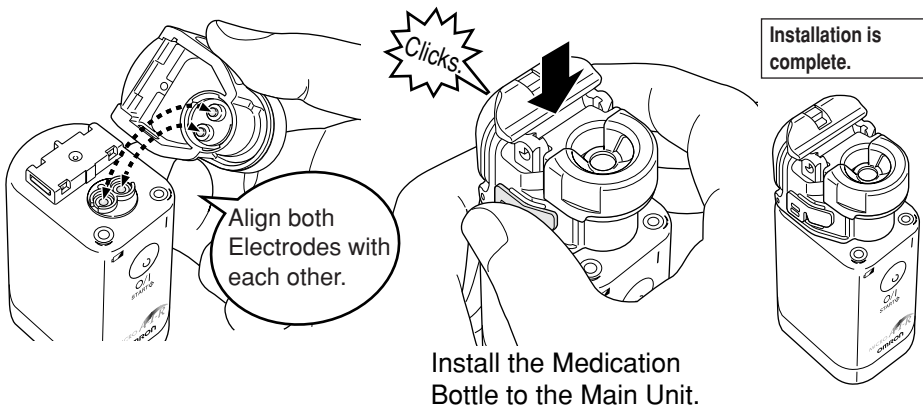

- If carrying the unit after the Medication Bottle is installed, hold on the Main Unit. Do not hold on the Medication Bottle.

### 3 Install the Mask Adapter to the Main Unit.

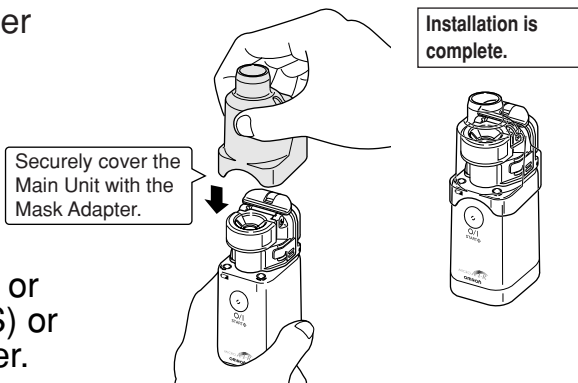

### Install the Mouthpiece or the Inhalation Mask (S) or (L) to the Mask Adapter.

#### ■ How to install the Inhalation Mask (S)

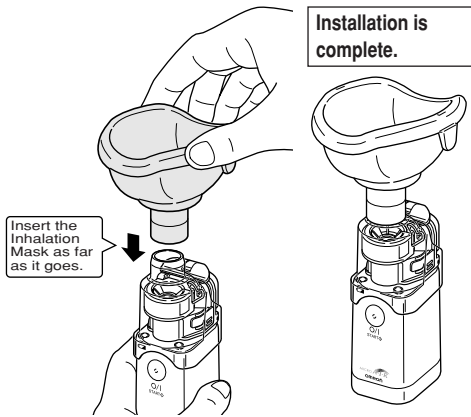

#### ■ How to install the Mouthpiece

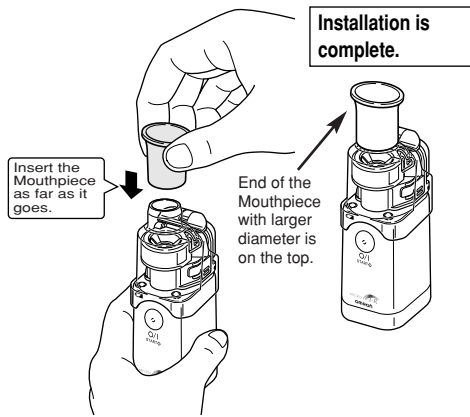

Before Using the Unit  
How to Assemble the Main Unit

### If you are not going to use the unit soon after it is assembled.

Remove the supplied Mask Adapter and Mouthpiece, or Inhalation Mask as shown in the Figure. Store the unit in the supplied Storage Bag or in a clean place.

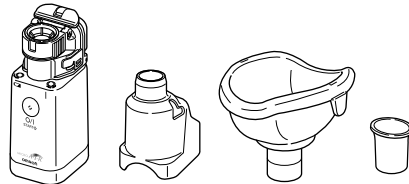

#### To remove the Medication Bottle from the Main Unit

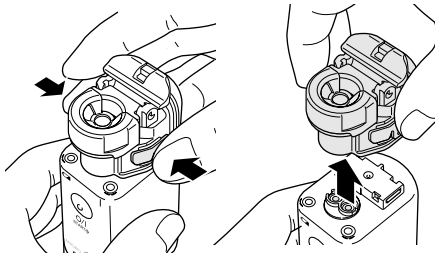

#### To remove the Mesh Cap from the Medication Bottle

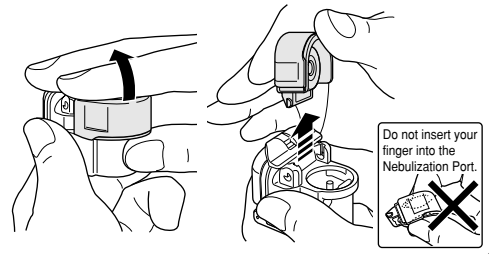

# How to Prepare the Power Source

Connect the unit to the power source before starting to use it.  
Use batteries or optional AC Adapter as the power source.

## How to use the optional AC Adapter

Please note that this AC Adapter is not a battery charger.

- 1 Place the Main Unit on the AC Adapter Connection Stand as shown in the Figure.

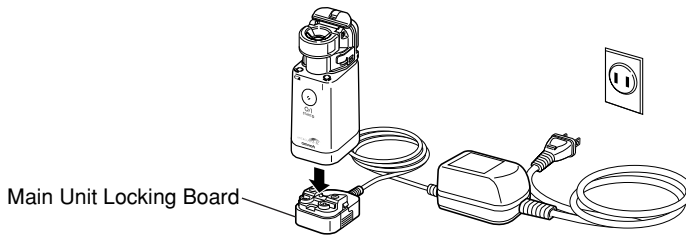

- Push in the AC Adapter until it clicks and is locked to the Stand.

- 2 Plug in the power plug of AC Adapter to the electric outlet.

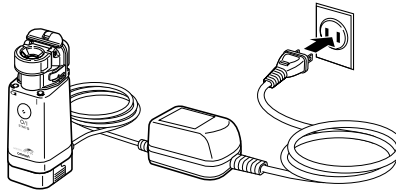

Connection is completed.

## How to remove the AC Adapter from the Main Unit

- (1) Unplug the power plug from the electric outlet.
- (2) Unlock the Main Unit by pushing in both ends of the Main Unit Locking Board of the AC Adapter Connection Stand with your fingers.

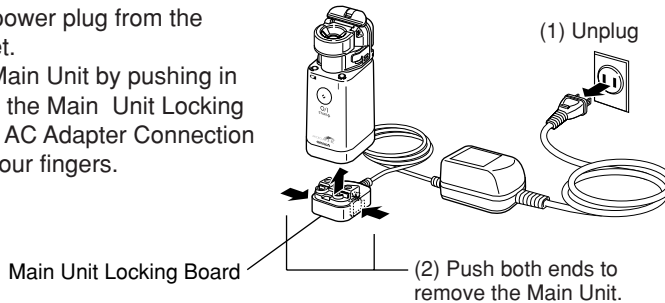



## How to Insert Batteries

Batteries are not supplied. Use two commercially available AA alkaline batteries. You can also use nickel-hydrogen batteries (rechargeable batteries). If you use a commercially available battery charger, you can save cost by recharging the batteries repeatedly.

### 1 Remove the Battery Cover.

- (1) Slightly rotate the Battery Cover Disengagement Lever in the direction of the arrow, and
- (2) Remove the Battery Cover.
  - The Battery Cover may not be removed easily when the batteries are not inserted.

### 2 Insert batteries correctly by aligning the polarities (+ and -) with the battery indication mark.

### 3 Put on the Battery Cover.

Put the Battery Cover on the Battery Case, and push it in until it catches the claws and clicks. Push both ends firmly.

- You may find it difficult to push in because the unit is made to prevent water dropping inside the unit.

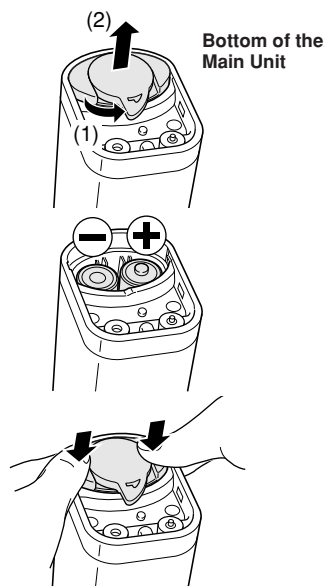

Correct Use of the Unit

How to Prepare the Power Source

### Battery life and battery replacement

#### ■ When using alkaline batteries

The unit can be used for approximately 8 days (if it is used for 30 minutes a day).

When the Battery Low Indicator (orange) flashes, batteries will be worn out soon. Replace both batteries with new ones.



When the Battery Low Indicator (orange) turns on, batteries are worn out. As the unit will not nebulize, immediately replace both batteries with new ones.

- You may use manganese batteries. However, manganese batteries tend to have a shorter life.

#### ■ When using nickel-hydrogen batteries

The unit can be used for approximately 8 days (if it is used for 30 minutes a day with the batteries fully charged).

When the Battery Low Indicator (orange) flashes, the rechargeable batteries have little residual power. As the unit does not nebulize, immediately recharge the batteries with a commercially available charger.

- The optional AC Adapter does not function as a battery charger. Use a commercially available battery charger suitable for the batteries you are using.

### General advice

- Immediately replace the worn batteries with new ones.
- If you are not going to use the unit for a long period of time (3 months or more), remove the batteries or rechargeable batteries in it, the batteries may leak and cause trouble to the unit.
- Do not use the batteries other than the ones specified for the unit. Do not use worn and new batteries together or different types of batteries together.
- Do not insert batteries with the polarities (+ and -) in the wrong direction.

# How to Fill the Medication

Remove the Mask Adapter, Mouthpiece, or Inhalation Mask (S), then fill the medication.

## 1 Remove the Medication Bottle from the Main Unit.

Lift up the Medication Bottle by pushing in the Medication Bottle Disengaging Buttons on both sides and releasing the engagement.

Medication Bottle Disengaging Button

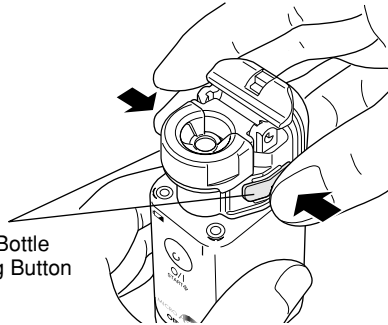

## 2 Remove the Mesh Cap.

Hold the Medication Bottle as if by covering it with your hand.

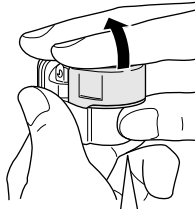

Lift up the Mesh Cap by applying your thumb on the brim.

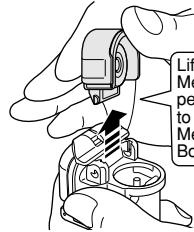

Lift up the Mesh Cap perpendicular to the Medication Bottle.

Do not open the Bottle Cap.



Do not insert your finger into the Nebulization Port.



## 3 Fill the medication.

Fill the medication as shown in the Figure.

- The maximum capacity of Medication Bottle is 7 ml.

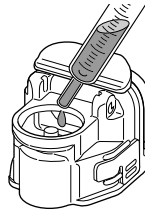

## 4 Install the Mesh Cap.

- If the Mesh Cap is not securely closed, medication may leak.

Insert the Mesh Cap perpendicular to the Medication Bottle.

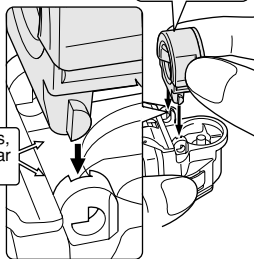

Align these points, then push in as far as it goes.

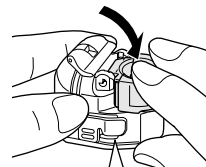

Close the Mesh Cap securely.

Do not insert your finger into the Nebulization Port.



Correct Use of the Unit

How to Fill the Medication

## 5 Install the Medication Bottle to the Main Unit.

- If the Medication Bottle is not installed correctly, the power will not turn on.
- If the Electrodes are extremely stained, the unit will not nebulize normally. In that case, wipe off the stain.

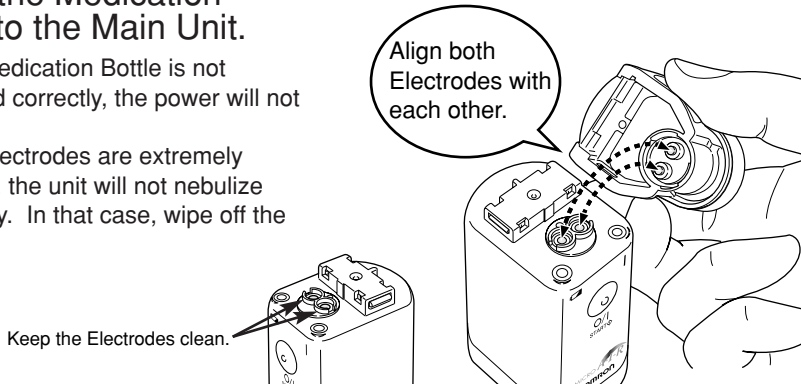

## 6 Install the Mask Adapter.

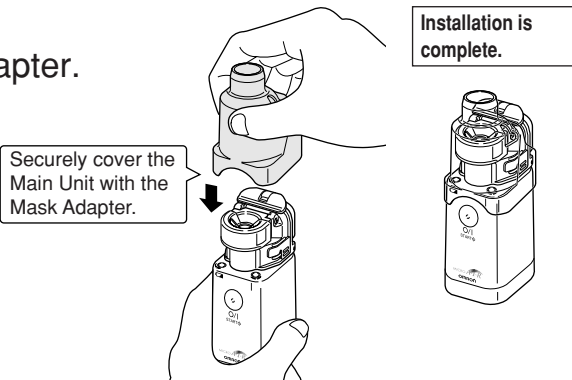

## 7 Install the Inhalation Mask or the Mouthpiece.

### ■ How to install the Inhalation Mask (S)

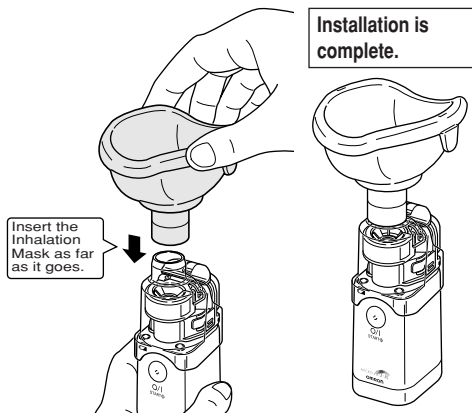

### ■ How to install the Mouthpiece

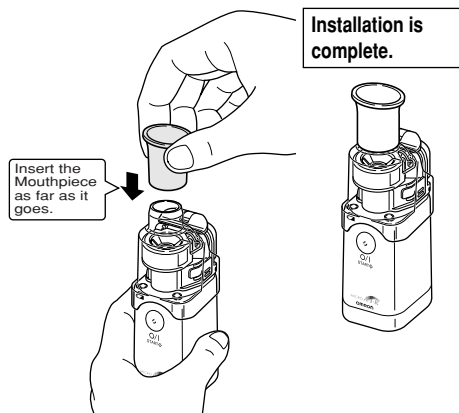

# How to Select the Nebulization Mode

You can select the nebulization mode by the way how you push the Button.

## Continuous Nebulization Mode

If you push the Button and immediately lift your finger away from the Button (within approximately 1 second), the unit nebulizes in Continuous Nebulization Mode.

If you push the Button again, the unit stops nebulization.

Push the Button and immediately lift your finger (within approximately 1 second).

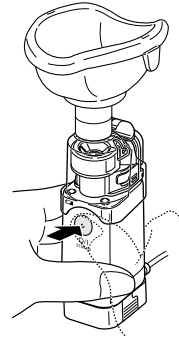

## Manual Nebulization Mode

If you keep pressing the Button (approximately for 2 seconds or more), the unit nebulizes in Manual Nebulization Mode.

The unit nebulizes only while you keep on pressing the Button and stops nebulization when you lift your finger from the Button.

You can inhale in tandem with respiration.

Keep on pressing (for approximately 2 seconds or more).

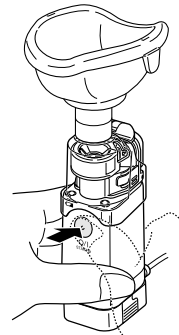

Correct Use of the Unit

How to Select the Nebulization Mode

- The Power Indicator (green) turns on during nebulization.

## How to Inhale

- 1 Hold the Main Unit with your hand and start inhalation in relaxed posture.

Slightly slant the Main unit (the side of Button) towards yourself.

Immerse the Vibrator in the medication. If the Vibrator is not immersed such as when the Main Unit is placed on a horizontal surface, the unit may not nebulize.

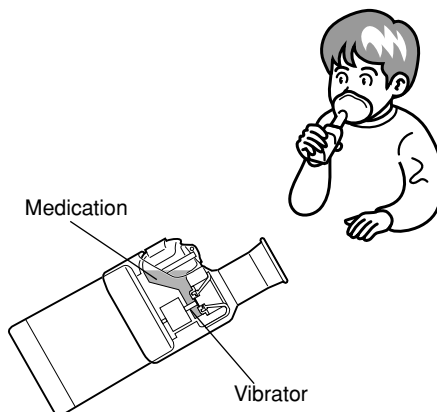

- If medication or slobber collects on the Mesh, the unit stops nebulization. After removing the Mask Adapter, Inhalation Mask, or Mouthpiece, turn off the power once and absorb the medication or slobber with new gauze. (If a medication has high surface activity, it may exude from Mesh holes or the Bottle Cap, or the medication may leak from the Air Port.)

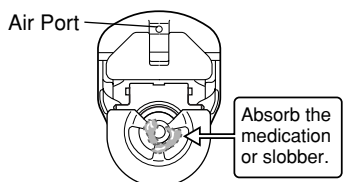

**⚠ Caution**

Do not poke the Mesh or the Vibrator with a cotton swab or a pin.

- The Mesh will be damaged and cannot be used.

- If the medication has high surface activity or viscosity such as medication solubilizing agent or expectorant, the nebulization rate may be reduced.
- If you push the Button and starts the unit while the Vibrator is not immersed in the medication,
  - (1) The Battery life may be shortened or the Battery Low Indicator may turn on.
    - Slant the Main Unit and check if the Vibrator is immersed in the medication, then push the Button and start inhalation.
    - Use the unit by immersing the Vibrator of the Inhalation Port in the medication.
    - Immediately after the medication is nebulized, turn off the power.
  - (2) A metallic sound may be generated, but it is not a trouble.

- 2 When you finish inhalation, push the Button to turn off the power.

- When the optional AC Adapter is used, unplug the power plug from the electric outlet. (Refer to Page 10.)

Correct Use of the Unit

How to Inhale

# How to Clean the Unit after Inhalation

## Be sure to clean and store the unit after inhalation.

If you do not clean the unit after inhalation, medication will be dried and adhered, and will not nebulize normally the next time. If this happens, clean the Mesh Cap by boiling to wash off the adhered medication. (Refer to Page 16.)

### 1 Remove the parts from the Main Unit.

Remove Inhalation Mask or Mouthpiece, Mask Adapter, and Medication Bottle from the Main Unit. (Refer to Page 9.)

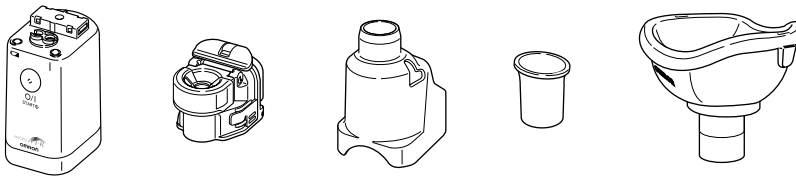

### 2 Discard the remaining medication.

After removing the Mesh Cap, open the Medication Bottle Cap and discard the medication. (Refer to Page 9.)

(1)

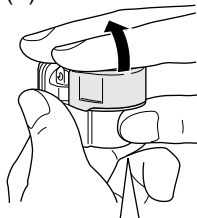

Lift up the Mesh Cap by applying your thumb on the brim.

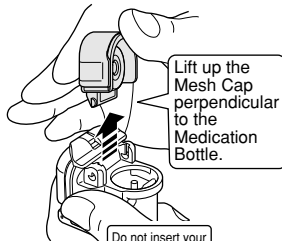

Lift up the Mesh Cap perpendicular to the Medication Bottle.

Do not insert your finger into the Nebulization Port.



(2)



Discard the remaining medication.

Disengage the Medication Bottle Cap Locking Lever and open the Medication Bottle Cap.

(3)

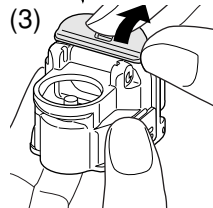

Correct Use of the Unit

How to Care the Unit after Inhalation

### 3 Wash the parts sufficiently in water.

Wash Inhalation Mask or Mouthpiece, Mask Adapter, Medication Bottle, and Mesh Cap in water.

- Carefully wash the Mesh when using a medication having high surface activity or viscosity such as medication solubilizing agent or expectorant because the medication is often left on the Mesh.
- Please be careful not to spray water on the Main Unit.

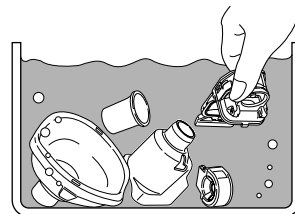

#### 4 Dry the parts thoroughly.

Immediately after washing the parts, wipe off water with new gauze and dry them thoroughly.

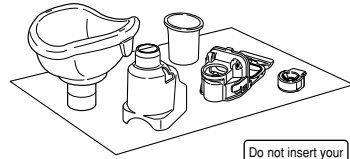

**General advice**

Never try to wipe off water with tissues or cloth.

- Dust or lint left on the Mesh may affect nebulization.



#### 5 Wipe off the stain on the Main Unit.

Wipe off the stain on the Main Unit with gauze.

If the Main Unit is heavily stained, lightly moisten gauze with water and wipe the stain off. Then use new gauze to wipe the Main Unit dry.

Keep the Electrodes clean.

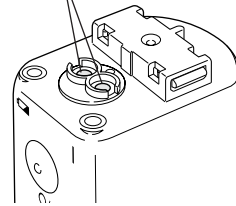

**General advice**

Do not wipe the Main Unit with volatile agent such as benzene or thinner.

#### 6 After assembling the unit, store it in a clean place.

**Warning**

Immediately dry the cleaned and disinfected parts, then store them in a clean place.

- Miscellaneous bacteria may propagate and may lead to infection.



Correct Use of the Unit

How to Care the Unit after Inhalation

### How to remove the Mesh Cover

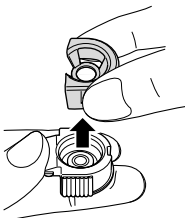

When washing a Mesh cap, you can remove the Mesh Cap Cover as shown in the Figure.

- Do not insert your finger into the Mesh Cap.

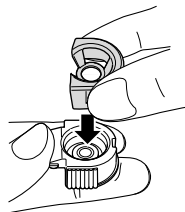

- Be sure to install the Mesh Cap Cover to the Mesh Cap after cleaning.

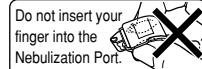

# How to Disinfect

This unit can be easily cleaned and disinfected because the Medication Bottle and the Mesh Cap can be removed from the Main Unit.

The unit can be disinfected with benzalkonium chloride.

- Disinfection at the medical facility for medical treatment must be done after confirming the target bacteria and the effects of disinfection method.

## 1 Make a 0.1% diluted solution using benzalkonium chloride, such as Osvan S and soak the unit for 10 minutes.

- As for the dilution method, follow the instruction manual of benzalkonium chloride.
- Do not leave the unit soaked in the solution for a long time.

## 2 Remove the unit from the solution and rinse it with water.

## 3 Immediately dry the unit by wiping off water with new gauze.

### ⚠ Caution

Do not disinfect the unit with the disinfection solution containing sodium hypochlorite.

- The unit may not be able to be used after getting covered with rust.



How to Disinfect the Unit

How to Disinfect

### The following parts can be cleaned by boiling.

#### Mesh Cap, Inhalation Mask, Mouthpiece, Mask Adapter

- (1) Place the parts in a container filled with sufficient water, and bring to boil.
- (2) The parts can be disinfected by boiling for 10 to 30 minutes.
- (3) When disinfection is finished, immediately dry the parts by wiping thoroughly with new gauze.
  - Never dry the parts in the microwave oven.
  - Never wipe dry with tissues or cloth. Dust or lint left on the Mesh may affect nebulization.

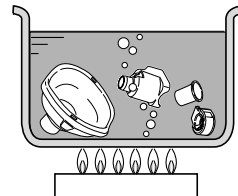

### Parts that cannot be disinfected by boiling

#### Medication Bottle, Main Unit, Main Unit Cover, Battery Cover, AC Adapter, Storage Bag



# How to Replace the Mash Cap

You can usually use a Mesh Cap for approximately 1 year (according to the test result of OMRON). However, the unit may not nebulize even before using it a year depending on how you use it. The unit also may not nebulize or nebulize extremely weak even after disinfected by boiling. In those cases, replace the Mesh Cap with a new one.

(Mesh Cap is a consumable part.)

For the inquiry on where to purchase the Mesh Cap or the broken or lost accessory, contact the store where you purchased the unit or the nearest OMRON dealer.

## 1 Remove the Medication Bottle from the Main Unit.

- Lift up the Medication Bottle from the Main Unit by pushing in the Medication Bottle Disengaging Buttons from both sides and releasing the engagement.

Medication Bottle Disengaging Button

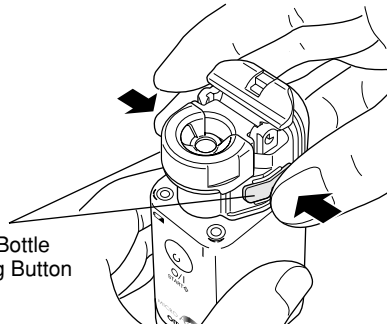

## 2 Remove the Mesh Cap from the Medication Bottle

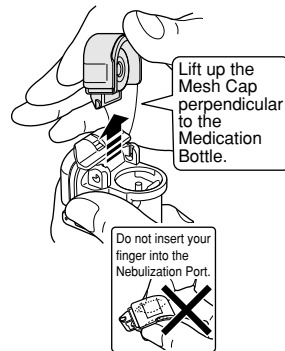
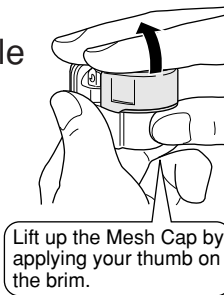

## 3 Install a new Mesh Cap.

- The nebulization rate may vary depending on the type of Mesh Cap you use.

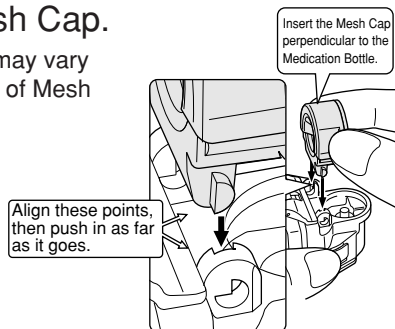

How to Disinfect the Unit  
How to Replace the Mesh Cap

## How to Carry the Unit

You can carry the with the Mouthpiece or the Inhalation Mask in the Storage Bag.

- When carrying the unit, cover the Main Unit with a Main Unit Cover.
- Wash the storage bag when it becomes dirty.
- Do not place the AC Adapter in the storage bag to avoid the Main Unit being scratched.

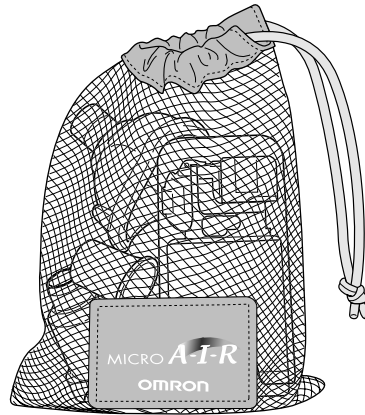

For Optional AC adapter:  
Bundle the power cord of AC Adapter and bind it with the AC Adapter using a Cord Band as shown in the Figure.

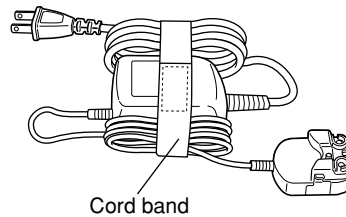

### Troubleshooting

#### How to Carry the Unit

##### General advice

Do not leave or carry the unit containing residual medication or water in the Medication Bottle.

- Medication may leak and damage the Main Unit or stain the area around the unit.

Do not place the unit under high temperature, high humidity, and direct sunshine.

# Troubleshooting

If any trouble occurs while you are using the unit, please check the following first.

Trouble	Possible cause	How to correct
The nebulization rate is extremely low.	The Battery Low Indicator flashes / turns on, and the batteries are low/worn out.	Replace the batteries with new ones. (Refer to page 9.)
	The Mesh is stained.	Clean the Mesh Cap by boiling to remove the stain. (Refer to Page 16.) - If the trouble cannot be corrected by the above-mentioned procedure, replace the Mesh Cap with a new one. (Refer to Page 17.)
The Power Indicator does not turn on and the unit does not nebulize.	The polarities (+ and -) of batteries are in the wrong direction.	Insert batteries in the correct alignment. (Refer to Page 9.)
	The batteries are low.	Replace batteries with new ones. (Refer to Page 9.)
	The capacity of rechargeable batteries (nickel-hydrogen batteries) is low.	Recharge the batteries with a commercially available recharger or replace them with new ones.
	The AC Adapter is not correctly connected to the electric outlet of the Connection Port of Main Unit.	Remove the AC Adapter from the Main Unit and connect it correctly. (Refer to Page 8.)
	The Medication Bottle is not installed correctly to the Main Unit.	Install the Medication Bottle correctly. (Refer to Page 11.)
The Power Indicator turns on but the unit does not nebulize.	The Medication Bottle is not filled with medication.	Fill the medication. (Refer to Page 10.)
	The Mesh is extremely stained.	Clean the Mesh Cap by boiling to remove the stain. (Refer to Page 16.) - If the trouble cannot be corrected by the above-mentioned procedure, replace the Mesh Cap with a new one. (Refer to Page 17.)
	The Mesh is broken.	Replace the Mesh Cap with a new one. (Refer to Page 17.)
	Medication is not supplied to the Medication Bottle. (Medication is not in contact with the Vibrator.)	Use the unit by slightly slanting the Main Unit (the side of the Button) towards yourself. (Refer to Page 13.)
	Medication or water is collected on the Electrodes of the Main Unit.	Remove the medication or water. (Refer to Page 13.)
	The Electrode of the Main Unit is stained.	Wipe off the stain. (Refer to Page 15.)

If the unit does not nebulize normally after taking the above-mentioned procedure, contact the store where you purchased the unit or the nearest OMRON dealer.

# Specifications

Product name:	Omron Mesh Nebulizer
Model:	<b>NE-U22</b>
Power source:	3 VDC (two AA alkaline batteries) 2.4 VDC (two AA nickel-hydrogen batteries) optional AC adapter
Power consumption:	Approximately 1.5 W*
Ultrasonic frequency:	Approximately 180 kHz
Nebulization rate:	0.25 ml / minute or more*
Particle size:	MMAD approximately 5 $\mu\text{m}$ (Measured by OMRON based on CEN/TC215)
Capacity of Medication Bottle:	Maximum of 7 ml
External dimensions:	Approximately 38 (W) x 104 (H) x 51 (D) mm
Weight:	Approximately 97 g (not including batteries)
Battery life:	Approximately 4 hours* with continuous nebulization Approximately 8 days when used about 30 minutes a day (with the use of alkaline batteries)
Operating temperature and humidity:	10 to 40°C, 30 to 85% RH
Accessories:	Inhalation Mask (S), Inhalation Mask (L), Mouthpiece, Mask Adapter, Storage Bag, Instruction Manual

\* Under normal temperature of 23°C. When nebulizing physiological saline. (Varies with the type of medication.)

- Nebulization rate is lowered at low temperature.
- The unit turns off automatically in approximately 30 minutes after the power is turned on.
- Specifications and appearance may be changed without prior notice for improvement.

Troubleshooting

## Option Parts Parts that can be purchased separately

Specifications / Option Parts



U10-1-P: Inhalation Mask (L) (with a rubber string)



U10-2-P: Inhalation Mask (S) (with a rubber string)



U22-1: Mouthpiece



U22-2: Mask Adapter

U22-3: Medication Bottle



U22-4: Mesh Cap (With a mesh)



U22-5: AC Adapter

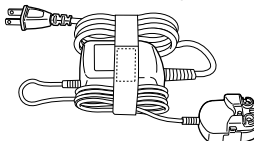

U22-7: Storage Bag

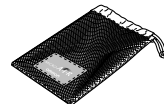

For the inquiry on where to purchase the option parts, contact the store where you purchased the unit or the nearest OMRON dealer.

## Free Manuals Download Website

<http://myh66.com>

<http://usermanuals.us>

<http://www.somanuals.com>

<http://www.4manuals.cc>

<http://www.manual-lib.com>

<http://www.404manual.com>

<http://www.luxmanual.com>

<http://aubethermostatmanual.com>

Golf course search by state

<http://golfingnear.com>

Email search by domain

<http://emailbydomain.com>

Auto manuals search

<http://auto.somanuals.com>

TV manuals search

<http://tv.somanuals.com>