

# ONKYO®

## CD Receiver

# CR-525

# CR-325

## Instruction Manual

Thank you for purchasing an Onkyo CD receiver. Please read this manual thoroughly before making any connections and plugging it in. Following the instructions in this manual will enable you to obtain optimum performance and listening enjoyment from your new CD receiver. Please retain this manual for future reference.

## Contents

Getting Started ..... 2

Connections ..... 17

Basic Operations ..... 25

Playing a Disc ..... 28

USB Playback (CR-525 only)... 37

Listening to the Radio ..... 41

Clock and Timer ..... 49

Miscellaneous ..... 56

    Troubleshooting ..... 56

If you can't resolve an issue, try resetting the CD receiver by holding down the [■] button and pressing the [STANDBY/ON] button.



## WARNING:

TO REDUCE THE RISK OF FIRE OR ELECTRIC SHOCK, DO NOT EXPOSE THIS APPARATUS TO RAIN OR MOISTURE.

## CAUTION:

TO REDUCE THE RISK OF ELECTRIC SHOCK, DO NOT REMOVE COVER (OR BACK). NO USER-SERVICEABLE PARTS INSIDE. REFER SERVICING TO QUALIFIED SERVICE PERSONNEL.



**WARNING**  
RISK OF ELECTRIC SHOCK  
DO NOT OPEN

**AVIS**  
RISQUE DE CHOC ELECTRIQUE  
NE PAS OUVRIR



The lightning flash with arrowhead symbol, within an equilateral triangle, is intended to alert the user to the presence of uninsulated "dangerous voltage" within the product's enclosure that may be of sufficient magnitude to constitute a risk of electric shock to persons.



The exclamation point within an equilateral triangle is intended to alert the user to the presence of important operating and maintenance (servicing) instructions in the literature accompanying the appliance.

## Important Safety Instructions

1. Read these instructions.
2. Keep these instructions.
3. Heed all warnings.
4. Follow all instructions.
5. Do not use this apparatus near water.
6. Clean only with dry cloth.
7. Do not block any ventilation openings. Install in accordance with the manufacturer's instructions.
8. Do not install near any heat sources such as radiators, heat registers, stoves, or other apparatus (including amplifiers) that produce heat.
9. Do not defeat the safety purpose of the polarized or grounding-type plug. A polarized plug has two blades with one wider than the other. A grounding type plug has two blades and a third grounding prong. The wide blade or the third prong are provided for your safety. If the provided plug does not fit into your outlet, consult an electrician for replacement of the obsolete outlet.
10. Protect the power cord from being walked on or pinched particularly at plugs, convenience receptacles, and the point where they exit from the apparatus.
11. Only use attachments/accessories specified by the manufacturer.
12. Use only with the cart, stand, tripod, bracket, or table specified by the manufacturer, or sold with the apparatus. When a cart is used, use caution when moving the cart/apparatus combination to avoid injury from tip-over.  

PORTABLE CART WARNING  
S3125A
13. Unplug this apparatus during lightning storms or when unused for long periods of time.
14. Refer all servicing to qualified service personnel. Servicing is required when the apparatus has been damaged in any way, such as power-supply cord or plug is damaged, liquid has been spilled or objects have fallen into the apparatus, the apparatus has been exposed to rain or moisture, does not operate normally, or has been dropped.
15. Damage Requiring Service  
Unplug the apparatus from the wall outlet and refer servicing to qualified service personnel under the following conditions:
  - A. When the power-supply cord or plug is damaged,
  - B. If liquid has been spilled, or objects have fallen into the apparatus,
  - C. If the apparatus has been exposed to rain or water,
  - D. If the apparatus does not operate normally by following the operating instructions. Adjust only those controls that are covered by the operating instructions as an improper adjustment of other controls may result in damage and will often require extensive work by a qualified technician to restore the apparatus to its normal operation,
  - E. If the apparatus has been dropped or damaged in any way, and
  - F. When the apparatus exhibits a distinct change in performance this indicates a need for service.
16. Object and Liquid Entry  
Never push objects of any kind into the apparatus through openings as they may touch dangerous voltage points or short-out parts that could result in a fire or electric shock.  
The apparatus shall not be exposed to dripping or splashing and no objects filled with liquids, such as vases shall be placed on the apparatus.  
Don't put candles or other burning objects on top of this unit.
17. Batteries  
Always consider the environmental issues and follow local regulations when disposing of batteries.
18. If you install the apparatus in a built-in installation, such as a bookcase or rack, ensure that there is adequate ventilation.  
Leave 20 cm (8") of free space at the top and sides and 10 cm (4") at the rear. The rear edge of the shelf or board above the apparatus shall be set 10 cm (4") away from the rear panel or wall, creating a flue-like gap for warm air to escape.

# Precautions

---

1. **Recording Copyright**—Unless it's for personal use only, recording copyrighted material is illegal without the permission of the copyright holder.
2. **AC Fuse**—The AC fuse inside the unit is not user-serviceable. If you cannot turn on the unit, contact your Onkyo dealer.
3. **Care**—Occasionally you should dust the unit all over with a soft cloth. For stubborn stains, use a soft cloth dampened with a weak solution of mild detergent and water. Dry the unit immediately afterwards with a clean cloth. Don't use abrasive cloths, thinners, alcohol, or other chemical solvents, because they may damage the finish or remove the panel lettering.

## 4. Power

### WARNING

BEFORE PLUGGING IN THE UNIT FOR THE FIRST TIME, READ THE FOLLOWING SECTION CAREFULLY.

AC outlet voltages vary from country to country. Make sure that the voltage in your area meets the voltage requirements printed on the unit's rear panel (e.g., AC 230 V, 50 Hz or AC 120 V, 60 Hz).

The power cord plug is used to disconnect this unit from the AC power source. Make sure that the plug is readily operable (easily accessible) at all times.

Pressing the [STANDBY/ON] button to select Standby mode does not fully shutdown the unit. If you do not intend to use the unit for an extended period, remove the power cord from the AC outlet.

5. **Never Touch this Unit with Wet Hands**—Never handle this unit or its power cord while your hands are wet or damp. If water or any other liquid gets inside this unit, have it checked by your Onkyo dealer.
6. **Handling Notes**
  - If you need to transport this unit, use the original packaging to pack it how it was when you originally bought it.
  - Do not leave rubber or plastic items on this unit for a long time, because they may leave marks on the case.
  - This unit's top and rear panels may get warm after prolonged use. This is normal.
  - If you do not use this unit for a long time, it may not work properly the next time you turn it on, so be sure to use it occasionally.
  - When you've finished using this unit, remove all discs and turn off the power.
7. **Installing this Unit**
  - Install this unit in a well-ventilated location.
  - Ensure that there's adequate ventilation all around this unit, especially if it's installed in an audio rack. If the ventilation is inadequate, the unit may overheat, leading to malfunction.

- Do not expose this unit to direct sunlight or heat sources, because its internal temperature may rise, shortening the life of the optical pickup.
  - Avoid damp and dusty places, and places subject to vibrations from loudspeakers. Never put the unit on top of, or directly above a loudspeaker.
  - Install this unit horizontally. Never use it on its side or on a sloping surface, because it may cause a malfunction.
  - If you install this unit near a TV, radio, or VCR, the picture and sound quality may be affected. If this occurs, move this unit away from the TV, radio, or VCR.
8. **To Obtain a Clear Picture**—This unit is a high-tech, precision device. If the lens on the optical pickup, or the disc drive mechanism becomes dirty or worn, the picture quality may be affected. To maintain the best picture quality, we recommend regular inspection and maintenance (cleaning or worn part replacement) every 1,000 hours of use depending on the operating environment. Contact your Onkyo dealer for details.

## 9. Moisture Condensation

### Moisture condensation may damage this unit.

Read the following carefully:

Moisture may condense on the lens of the optical pickup, one of the most important parts inside this unit.

- Moisture condensation can occur in the following situations:
  - The unit is moved from a cold place to a warm place.
  - A heater is turned on, or cold air from an air conditioner is hitting the unit.
  - In the summer, when this unit is moved from an air conditioned room to a hot and humid place.
  - The unit is used in a humid place.
- Do not use this unit when there's the possibility of moisture condensation occurring. Doing so may damage your discs and certain parts inside this unit.

If condensation does occur, remove all discs and leave this unit turned on for two to three hours. By this time, the unit will have warmed up and any condensation will have evaporated.

## Precautions—Continued

This unit contains a semiconductor laser system and is classified as a “CLASS 1 LASER PRODUCT”. So, to use this model properly, read this Instruction Manual carefully. In case of any trouble, please contact the store where you purchased the unit.

To prevent being exposed to the laser beam, do not try to open the enclosure.

### CAUTION:

CLASS 1M VISIBLE AND INVISIBLE LASER RADIATION WHEN OPEN. DO NOT VIEW DIRECTLY WITH OPTICAL INSTRUMENTS. THIS PRODUCT UTILIZES A LASER. USE OF CONTROLS OR ADJUSTMENTS OR PERFORMANCE OF PROCEDURES OTHER THAN THOSE SPECIFIED HEREIN MAY RESULT IN HAZARDOUS RADIATION EXPOSURE.

The label on the right is applied on the rear panel.



1. This unit is a CLASS 1 LASER PRODUCT and employs a laser inside the cabinet.
2. To prevent the laser from being exposed, do not remove the cover. Refer servicing to qualified personnel.

### For U.S. models

#### FCC Information for User

### CAUTION:

The user changes or modifications not expressly approved by the party responsible for compliance could void the user's authority to operate the equipment.

### NOTE:

This equipment has been tested and found to comply with the limits for a Class B digital device, pursuant to Part 15 of the FCC Rules. These limits are designed to provide reasonable protection against harmful interference in a residential installation.

This equipment generates, uses and can radiate radio frequency energy and, if not installed and used in accordance with the instructions, may cause harmful interference to radio communications. However, there is no guarantee that interference will not occur in a particular installation. If this equipment does cause harmful interference to radio or television reception, which can be determined by turning the equipment off and on, the user is encouraged to try to correct the interference by one or more of the following measures:

- Reorient or relocate the receiving antenna.
- Increase the separation between the equipment and receiver.
- Connect the equipment into an outlet on a circuit different from that to which the receiver is connected.
- Consult the dealer or an experienced radio/TV technician for help.

### For Canadian Models

**NOTE:** THIS CLASS B DIGITAL APPARATUS COMPLIES WITH CANADIAN ICES-003.

For models having a power cord with a polarized plug: **CAUTION:** TO PREVENT ELECTRIC SHOCK, MATCH WIDE BLADE OF PLUG TO WIDE SLOT, FULLY INSERT.

### Modèle pour les Canadien

**REMARQUE:** CET APPAREIL NUMÉRIQUE DE LA CLASSE B EST CONFORME À LA NORME NMB-003 DU CANADA.

Sur les modèles dont la fiche est polarisée:

**ATTENTION:** POUR ÉVITER LES CHOCS ÉLECTRIQUES, INTRODUIRE LA LAME LA PLUS LARGE DE LA FICHE DANS LA BORNE CORRESPONDANTE DE LA PRISE ET POUSSER JUSQU'AU FOND.

### For British models

Replacement and mounting of an AC plug on the power supply cord of this unit should be performed only by qualified service personnel.

### IMPORTANT

The wires in the mains lead are coloured in accordance with the following code:

**Blue:** Neutral

**Brown:** Live

As the colours of the wires in the mains lead of this apparatus may not correspond with the coloured markings identifying the terminals in your plug, proceed as follows: The wire which is coloured blue must be connected to the terminal which is marked with the letter N or coloured black.

The wire which is coloured brown must be connected to the terminal which is marked with the letter L or coloured red.

### IMPORTANT

The plug is fitted with an appropriate fuse. If the fuse needs to be replaced, the replacement fuse must be approved by ASTA or BSI to BS1362 and have the same ampere rating as that indicated on the plug. Check for the ASTA mark or the BSI mark on the body of the fuse.

If the power cord's plug is not suitable for your socket outlets, cut it off and fit a suitable plug. Fit a suitable fuse in the plug.

### For European Models

|   |  |
|---|--|
| <b>Declaration of Conformity</b>  |  |
| We, ONKYO EUROPE ELECTRONICS GmbH<br>LIEGNITZERSTRASSE 6,<br>82194 GROEBENZELL,<br>GERMANY  |               |
| declare in own responsibility, that the ONKYO product described in this instruction manual is in compliance with the corresponding technical standards such as EN60065, EN55013, EN55020 and EN61000-3-2, -3-3. |  |
| GROEBENZELL, GERMANY  | <br>K. MIYAGI |
| ONKYO EUROPE ELECTRONICS GmbH   |  |

# Features

---

## Amplifier

---

- WRAT (Wide Range Amplifier Technology)
- High Current, Low Impedance Drive
- Discrete Output Stage Circuitry
- 2 Audio Inputs and 1 Output
- Optimum Gain Volume Circuitry
- Subwoofer Pre Out

## CD Player

---

- Plays CDs, MP3 CDs, CD-Rs and CD-RWs<sup>\*1</sup>
- 25 Track Programming
- 2 Repeat Mode (Track/Full)
- 4 Play Modes (Normal/Random/Memory/1 Folder)

### — CR-525 —

- VLSC (Vector Linear Shaping Circuitry)<sup>\*2</sup>
- Wolfson Stereo D/A Converter

### — CR-325 —

- Single-Bit D/A Converter

## Tuner & Other

---

- 40 AM/FM Presets
  - 4-Program Timer (Play or Rec / Once or Every)
  - Sleep Timer
  - Battery-Free Memory Backup
  - Headphone Jack
  - Aluminium Front Panel
  - RI-Dock Compatible Remote Control (iPod Control Capable)
- ### — CR-525 —
- USB Interface for Sticks and Portable Audio Player (WMA<sup>\*3</sup>, MP3)
  - Aluminium Volume Knob
  - Gold Plated, Banana Plug-Compatible Transparency Speaker Posts

# Supplied Accessories

---

Make sure you have the following accessories:

CR-525

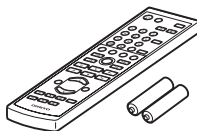

CR-325

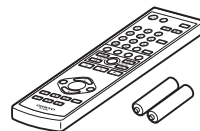

Remote controller and two batteries (R6/AA)

---



Indoor FM antenna

(Connector type varies from country to country.)

---

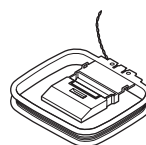

AM loop antenna

---

\* In catalogs and on packaging, the letter at the end of the product name indicates the color. Specifications and operations are the same regardless of color.

\*1. Make sure to use discs that have been finalized.

\*2. VLSC and the VLSC logo are registered trademarks of Onkyo Corporation.

\*3.  Designed for Windows Media

Windows Media, and the Windows logo are trademarks, or registered trademarks of Microsoft Corporation in the United States and/or other countries.

\* Apple and iPod are trademarks of Apple, Inc., registered in the U.S. and other countries.

# Before Using the CD receiver

In general, the illustrations in this Instruction Manual show the CR-325.

## Installing the Batteries

- 1 Detach the battery cover by pressing the tab and pulling up the cover.**

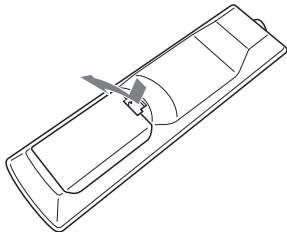

- 2 Insert two batteries (R6/AA) into the battery compartment.**

Carefully follow the polarity diagram (positive (+) and negative (-) symbols) inside the battery compartment.

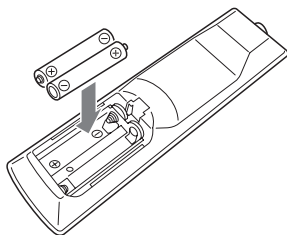

- 3 After the batteries are installed and seated correctly, attach the compartment cover.**

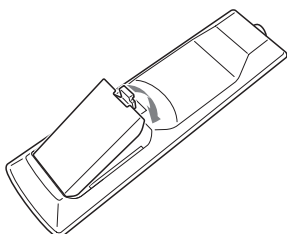

### Notes:

- If the remote controller doesn't work reliably, try replacing the batteries.
- Don't mix new and old batteries or different types of batteries.
- If you intend not to use the remote controller for a long time, remove the batteries to prevent damage from leakage or corrosion.
- Expired batteries should be removed as soon as possible to prevent damage from leakage or corrosion.

## Using the Remote Controller

When you operate the remote controller, point it at the CD receiver's remote control sensor, as shown below.

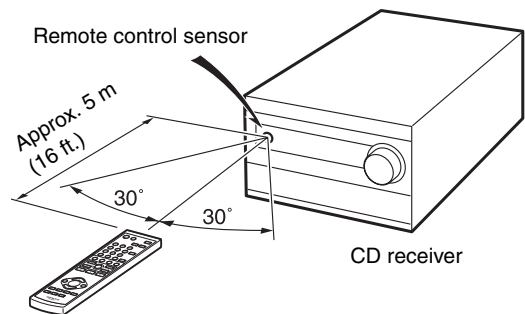

### Notes:

- The remote controller may not work reliably if the CD receiver is subjected to bright light, such as direct sunlight or inverter-type fluorescent lights. Keep this in mind when installing.
- If another remote controller of the same type is used in the same room, or the CD receiver is installed close to equipment that uses infrared rays, the remote controller may not work reliably.
- Don't put anything, such as a book, on the remote controller because the buttons may be pressed inadvertently, thereby draining the batteries.
- The remote controller may not work reliably if the CD receiver is installed in a rack behind colored glass doors. Keep this in mind when installing.
- The remote controller will not work if there's an obstacle between it and the CD receiver's remote control sensor.

# Contents

## Getting Started

|                                       |    |
|---------------------------------------|----|
| Important Safety Instructions .....   | 2  |
| Precautions .....                     | 3  |
| Features .....                        | 5  |
| Supplied Accessories .....            | 5  |
| Before Using the CD receiver .....    | 6  |
| Installing the Batteries .....        | 6  |
| Using the Remote Controller .....     | 6  |
| Getting to Know the CD receiver ..... | 8  |
| Front Panel .....                     | 8  |
| Display .....                         | 10 |
| Rear Panel .....                      | 11 |
| Remote Controller .....               | 12 |
| Disc Notes .....                      | 15 |

## Connections

|   |    |
|---|----|
| Connecting Antennas .....                                   | 17 |
| Connecting Speakers .....                                   | 19 |
| Connecting Other Components .....                           | 20 |
| About Connections .....                                     | 20 |
| Connecting a Subwoofer .....                                | 20 |
| Connecting an Onkyo Cassette Deck .....                     | 21 |
| Connecting an Onkyo MD recorder .....                       | 22 |
| Connecting an Onkyo RI Dock (Remote Interactive Dock) ..... | 23 |
| Connecting the Power Cord .....                             | 23 |
| First Time Setup (European models only) .....               | 24 |
| Setting the Clock with the AccuClock Function ...           | 24 |

## Basic Operations

|                                     |    |
|-------------------------------------|----|
| Basic Operations .....              | 25 |
| Turning On the CD receiver .....    | 25 |
| Adjusting the Volume .....          | 25 |
| Selecting the Input Source .....    | 25 |
| Using Headphones .....              | 25 |
| Adjusting the Bass and Treble ..... | 26 |
| Using the Super Bass Function ..... | 26 |
| Using the Direct Function .....     | 26 |
| Muting the Sound .....              | 26 |
| Changing the Input Display .....    | 27 |

## Playing a Disc

|                                   |    |
|-----------------------------------|----|
| Playing CDs .....                 | 28 |
| Using the Remote Controller ..... | 29 |
| Displaying CD Information .....   | 29 |
| Selecting/Playing MP3 Files ..... | 30 |
| Displaying MP3 Information .....  | 32 |
| Memory Playback .....             | 33 |
| Random Playback .....             | 34 |
| Repeat Playback .....             | 34 |
| Setting MP3 Preferences .....     | 35 |

## USB Playback (CR-525 only)

|  |    |
|--|----|
| Using USB interface (CR-525 only) .....                | 37 |
| Playing Music Files on a USB Mass Storage Device ..... | 38 |

## Listening to the Radio

|  |    |
|--|----|
| Listening to the Radio .....                             | 41 |
| Tuning into Radio Stations .....                         | 41 |
| Presetting FM Stations Automatically (Auto Preset) ..... | 42 |
| Presetting AM/FM Stations Manually .....                 | 43 |
| Selecting Preset Stations .....                          | 44 |
| Displaying Radio Information .....                       | 45 |
| Receiving RDS (European models only) .....               | 45 |
| Naming Presets .....                                     | 46 |
| Copying Presets .....                                    | 47 |
| Erasing a Preset's Name .....                            | 48 |
| Erasing Presets .....                                    | 48 |

## Clock and Timer

|  |    |
|--|----|
| Setting the Clock .....  | 49 |
| Setting AccuClock to Use a Specific Station (European models only) ..... | 49 |
| Setting the Clock Manually .....   | 50 |
| Using the Timers .....   | 51 |
| About the Timers .....   | 51 |
| Programming the Timers .....   | 52 |
| Turning Timers On and Off .....  | 54 |
| Checking Timer Settings .....  | 54 |
| Using the Sleep Timer .....  | 55 |

## Miscellaneous

|                       |    |
|-----------------------|----|
| Troubleshooting ..... | 56 |
| Specifications .....  | 59 |

# Getting to Know the CD receiver

## Front Panel

CR-525

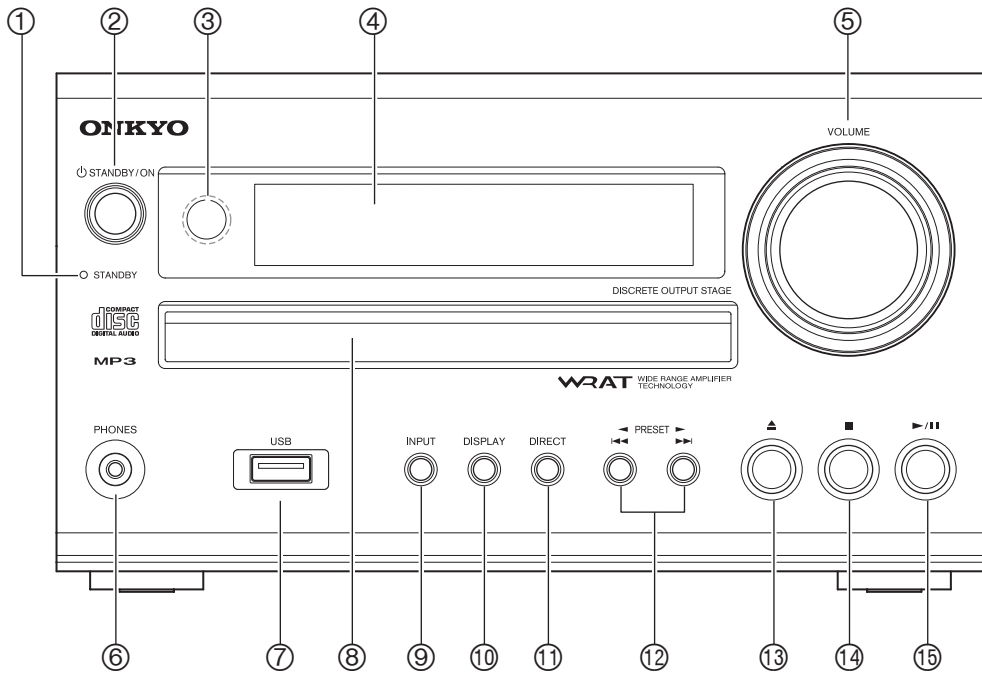

CR-325

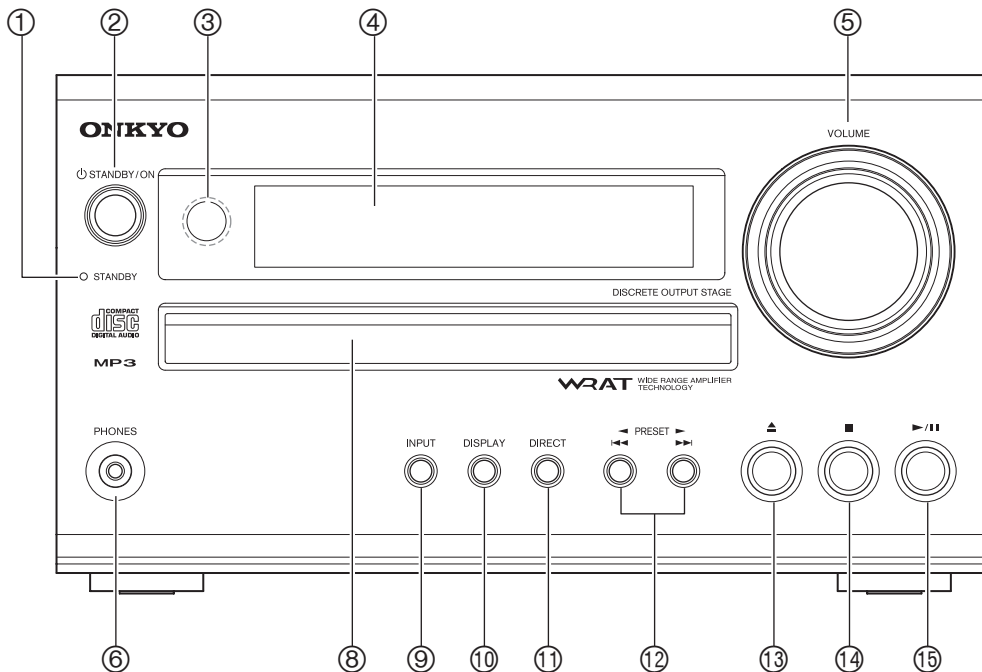



## Getting to Know the CD receiver—Continued

---

The page numbers in parentheses show where you can find the main explanation for each item.

- ① **STANDBY indicator (23, 25)**  
Lights up in Standby mode.
- ② **STANDBY/ON button (25, 50, 53, 56)**  
Sets the CD receiver to On or Standby.
- ③ **Remote control sensor (6)**  
Receives control signals from the remote controller.
- ④ **Display**  
See “Display” on page 10.
- ⑤ **VOLUME control (25) and indicator**  
This control is used to adjust the volume of the CD receiver to “Min”, “1” through “41”, “Max”.  
The volume control indicator lights up when the CD receiver is on.
- ⑥ **PHONES jack (25)**  
This stereo minijack is for connecting a pair of stereo headphones for private listening.
- ⑦ **USB port (CR-525 only) (38)**  
A USB mass storage device, such as a USB flash drive or MP3 music player, containing music files (MP3, WMA) can be plugged in here and the music selected and played through the CD receiver.
- ⑧ **Disc tray (28)**  
The CD is loaded here.
- ⑨ **INPUT button (25, 27, 42, 44)**  
Used to select the input source.
- ⑩ **DISPLAY button (29, 32, 45, 46, 50)**  
Used to change the information shown on the display. Also used to select characters when naming radio presets.
- ⑪ **DIRECT button (26)**  
Used with the Direct function.
- ⑫ **Previous/Next [◀◀]/[▶▶] buttons or PRESET [◀]/[▶] buttons (28, 41)**  
The Previous [◀◀] button selects the previous track. During playback it selects the beginning of the current track. The Next [▶▶] button selects the next track.  
When the AM or FM input source is selected, these buttons are used to tune the tuner, or select radio presets.
- ⑬ **Open/Close [▲] button (28)**  
Used to open and close the disc tray.
- ⑭ **Stop [■] button (28, 56)**  
Stops CD playback.
- ⑮ **Play/Pause [▶/||] button (28)**  
Starts CD playback. Pressing it during playback pauses playback.

Display

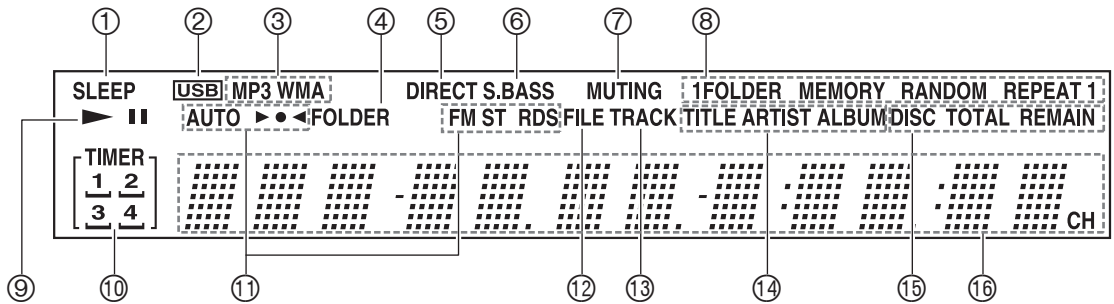

- ① **SLEEP indicator**  
Lights up when the Sleep function has been set.
- ② **USB indicator (CR-525 only)**  
The CD receiver lights up on detecting a USB mass storage device.
- ③ **File format indicators**  
**MP3:**  
Lights up when an MP3 file is loaded.  
**WMA (CR-525 only):**  
Lights up when a WMA file is loaded.
- ④ **FOLDER indicator**  
Lights up when a folder number or name is being displayed.
- ⑤ **DIRECT indicator**  
Lights up when the Direct function is on.
- ⑥ **S.BASS indicator**  
Lights up when the Super Bass function is on.
- ⑦ **MUTING indicator**  
Flashes while the CD receiver is muted.
- ⑧ **Playback mode indicators**  
**1FOLDER:**  
Lights up when 1-folder playback is selected.  
**MEMORY:**  
Lights up when memory playback is selected.  
**RANDOM:**  
Lights up when random playback is selected.  
**REPEAT:**  
Lights up when repeat playback is selected for all tracks.  
**REPEAT 1:**  
Lights up when repeat playback is selected for one track.
- ⑨ **Play and pause ►/|| indicators**  
The Play indicator lights up for playback. The Pause indicator lights up while playback is paused.
- ⑩ **TIMER indicators**  
Show the status of the timers.  
**TIMER:**  
Lights up when a timer has been programmed.
- ⑪ **Tuning indicators**  
**AUTO:**  
Lights up when Auto Tuning is selected, and disappears when Manual Tuning is selected.  
**►●◄:**  
Lights up when the CD receiver is tuned to a radio station.  
**FM ST:**  
Lights up when the CD receiver is tuned to a stereo FM station.  
**RDS (European models only):**  
Lights up when the CD receiver is tuned to a radio station that supports RDS (Radio Data System).
- ⑫ **FILE indicator**  
Lights up when a music file number or name is being displayed.
- ⑬ **TRACK indicator**  
Lights up when a CD track number is being displayed.
- ⑭ **TITLE, ARTIST, and ALBUM indicators**  
**TITLE** lights up when the title (ID3 tag) of a music file is being displayed.  
**ARTIST** lights up when the artist name from a music file (ID3 tag) is being displayed.  
**ALBUM** lights up when the album name from a music file (ID3 tag) is being displayed.
- ⑮ **DISC, TOTAL, and REMAIN indicators**  
These indicators light up when the total time or the remaining disc or track time is being displayed.
- ⑯ **Message area**  
Various information is displayed here, including radio preset numbers, tuning frequency, current time, volume level, sleep time, mode settings, and so on.

### Rear Panel

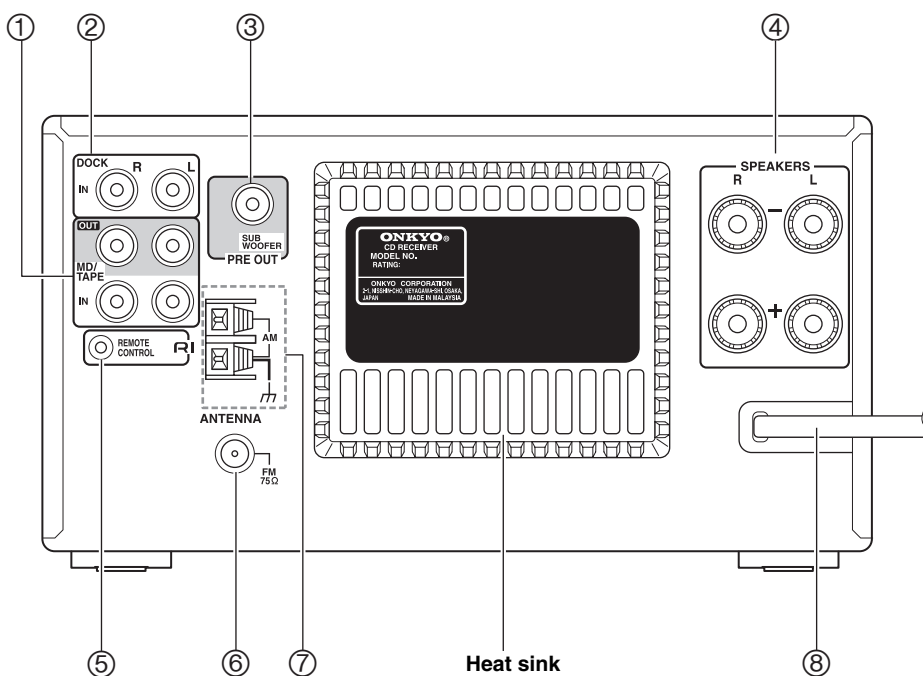

The page numbers in parentheses show where you can find the main explanation for each item.

- ① **MD/TAPE IN/OUT (21, 22)**  
These analog audio inputs and outputs are for connecting a recorder with an analog input and output, such as a MiniDisc recorder or cassette deck.
- ② **DOCK IN (23)**  
This analog audio input is for connecting an Onkyo RI Dock.
- ③ **SUBWOOFER PRE OUT (20)**  
This jack is for connecting a powered subwoofer.
- ④ **SPEAKERS (19)**  
These terminal posts are for connecting speakers.
- ⑤ **RI REMOTE CONTROL (21–23)**  
This **RI** (Remote Interactive) jack can be connected to an **RI** jack on another Onkyo component. The CD receiver's remote controller can then be used to control that component. To use **RI**, you must make an analog audio connection (RCA) between the CD receiver and the other component.
- ⑥ **FM ANTENNA (17, 18)**  
This jack is for connecting an FM antenna.
- ⑦ **AM ANTENNA (17, 18)**  
These push terminals are for connecting an AM antenna.

- ⑧ **Power cord (23)**

The power cord should be connected to a suitable power source (Plug type varies from country to country).

See pages 17–23 for connection information.

**Caution:**

The heat sink is a device designed to disperse heat from within the CD receiver. Do not to place objects around the CD receiver and ensure that there is adequate ventilation all around the CD receiver. If the ventilation is inadequate, the CD receiver may overheat, leading to malfunction.

Remote Controller

RC-721S  
(CR-525)

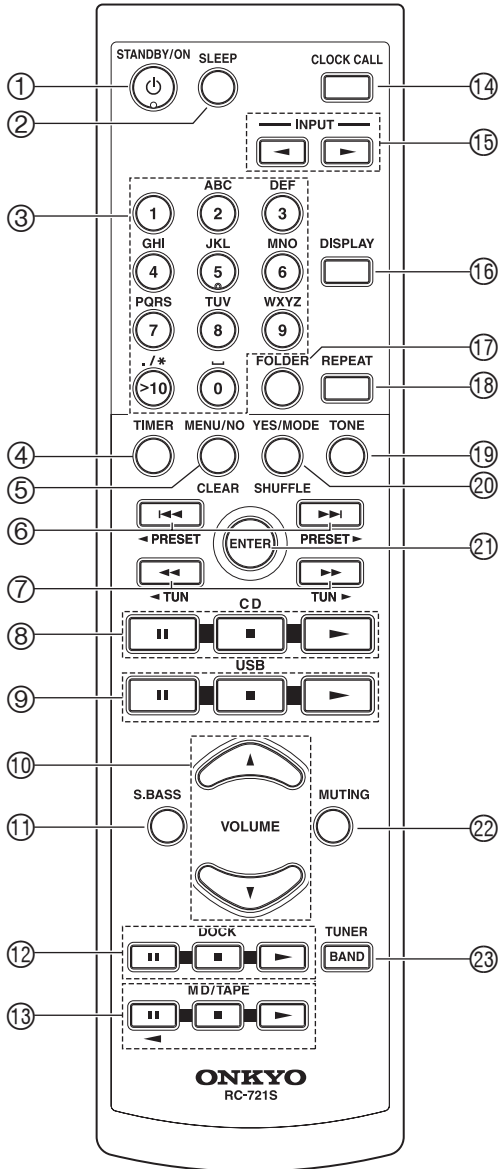



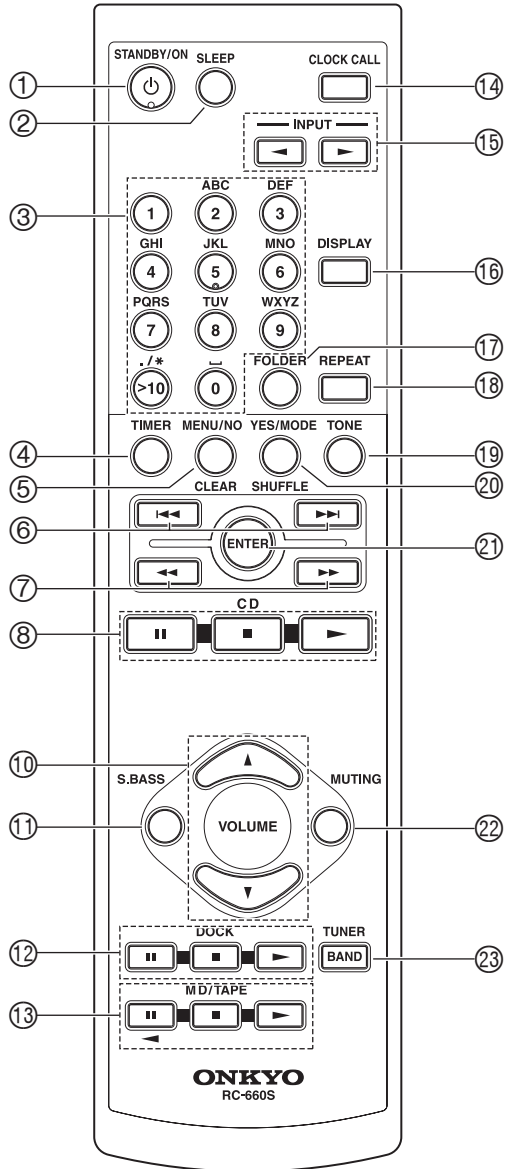









RC-660S  
(CR-325)



## Getting to Know the CD receiver—Continued

The page numbers in parentheses show where you can find the main explanation for each item.

- ① **STANDBY/ON button (25, 50, 53)**  
This button is used to set the CD receiver to On or Standby.
- ② **SLEEP button (55)**  
Used to set the Sleep timer, which turns off the CD receiver after a specified time.
- ③ **Number buttons (29, 31, 33, 44, 46, 52)**  
Used to select tracks and radio presets. Also used to set the clock manually, set the timers, and enter names for radio presets.
- ④ **TIMER button (24, 49, 50, 52, 54)**  
Used to set the timers and clock.
- ⑤ **MENU/NO/CLEAR button (27, 35, 42, 43, 46–48)**  
Used with various functions and settings for selecting, cancelling, and deleting. With an Onkyo RI Dock, it works as a mode button.
- ⑥ **Previous/Next [/]] and [ PRESET]/[PRESET ] buttons (29, 44)**  
Used to select the previous or next track or radio preset. Can also be used with an Onkyo RI Dock. With an Onkyo cassette deck, they work as rewind and fast forward buttons.
- ⑦ **Rewind/Fast Forward []/]] and [ TUN]/[TUN ] buttons (29, 41, 49)**  
Used to rewind or fast forward CD playback. Can also be used with an Onkyo RI Dock. Also used to tune the radio and edit preset names.
- ⑧ **CD control buttons (29)**
  - ▬ : Pauses playback.
  - : Stops playback.
  - ▶ : Starts playback.
- ⑨ **USB device control buttons (CR-525 only) (38)**
  - ▬ : Pauses playback.
  - : Stops playback.
  - ▶ : Starts playback.
- ⑩ **VOLUME [/]] buttons (25, 29)**  
Adjust the volume level.
- ⑪ **S.BASS button (26)**  
Sets the Super Bass function.
- ⑫ **Onkyo RI Dock control buttons**
  - ▬ : Pauses playback.
  - : Stops playback.
  - ▶ : Starts playback.
- ⑬ **Onkyo MD recorder and cassette deck control buttons**  
For twin cassette decks, only Deck B can be controlled.
  - ◀ : Plays side B (cassette deck).
  - ▬ : Pauses playback or recording (MD).
  - : Stops playback, recording, fast-forward, or rewind.
  - ▶ : Plays side A.
- ⑭ **CLOCK CALL button (50)**  
Calls up the clock to display the day and time.
- ⑮ **INPUT []/]] buttons (25, 27, 42, 44)**  
Used to select the input source.
- ⑯ **DISPLAY button (29, 32, 45, 46, 50)**  
Used to change the information shown on the display. Also used to select characters when naming radio presets. With an Onkyo RI Dock, it works as a backlight button.
- ⑰ **FOLDER button (30, 31, 36)**  
Used to select MP3 folders.
- ⑱ **REPEAT button (34)**  
Sets repeat playback. Can also be used with an Onkyo RI Dock. With an Onkyo cassette deck, it works as a reverse mode button.
- ⑲ **TONE button (26)**  
Used to adjust the bass and treble.
- ⑳ **YES/MODE/SHUFFLE button (32–34, 41)**  
Used with various functions and settings for confirming, selecting modes, and selecting random playback. Can also be used with an Onkyo RI Dock, it works as a shuffle button.
- ㉑ **ENTER button**  
Used to confirm various functions and settings. Can also be used with an Onkyo RI Dock.
- ㉒ **MUTING button (26)**  
Mutes the output of the CD receiver.
- ㉓ **TUNER/BAND button (41, 42, 44)**  
Selects AM or FM radio as the input source.

## Getting to Know the CD receiver—Continued

### Controlling an Onkyo MD recorder, cassette deck, or RI Dock

Explanation of buttons for using the Onkyo MD recorder, cassette deck, or RI Dock, when connected to the MD/TAPE jack or DOCK IN jack of the CD receiver.

- See pages 21-23 for instructions on connecting the components.
- To control the MD recorder, the Input Display for the MD/TAPE jacks must be set to “MD” (see page 27).

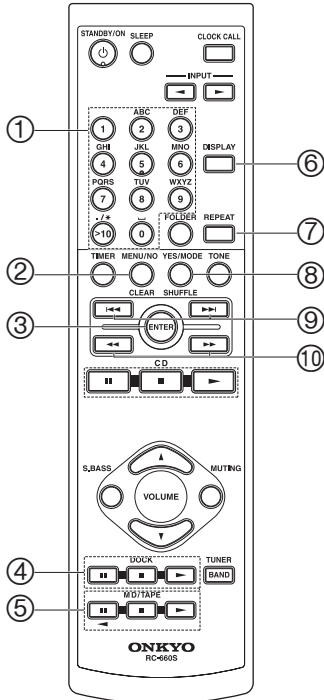

**Example: Shows the case of ⑧:**

**the [YES/MODE/SHUFFLE] button.**

- When the cassette deck is connected to the MD/TAPE jack of the CD receiver and the input source is set to “TAPE”, it works as a DOLBY NR button.

|   | Jack             | MD/TAPE  |          | DOCK                   |
|---|------------------|----------|----------|------------------------|
|   | Input source     | TAPE     | MD       | DOCK                   |
| ① | 1 ~ 9            |          | 1 ~ 9    |                        |
|   | 0                |          | 10/0     |                        |
|   | >10              |          | >10      |                        |
| ② | MENU/NO/CLEAR    |          | CLEAR    | MODE                   |
| ③ | ENTER            |          | ENTER    | SELECT                 |
| ④ | DOCK ►           |          |          | ►                      |
|   | DOCK ■           |          |          | ■                      |
|   | DOCK             |          |          |                        |
| ⑤ | MD/TAPE ►        | ►        | ►        |                        |
|   | MD/TAPE ■        | ■        | ■        |                        |
|   | MD/TAPE    (◄)   | ◄        |          |                        |
| ⑥ | DISPLAY          |          | DISPLAY  | BACKLIGHT              |
| ⑦ | REPEAT           | REV MODE | REPEAT   | REPEAT                 |
| ⑧ | YES/MODE/SHUFFLE | DOLBY NR | MODE     | SHUFFLE <sup>*1</sup>  |
| ⑨ | ◄◄/  /►►         | ◄◄/►►    | ◄◄/  /►► | ◄◄/  /►► <sup>*2</sup> |
| ⑩ | ◄◄/►►            |          | ◄◄/►►    | ◄◄/►►                  |

\*1. In “Cursor Mode” it works as a MENU button.





\*2. In “Cursor Mode” it can be used for navigation menus.

- Refer to the instruction manual for each connected component for details. For column items with no notation: buttons will not function when pressed.

# Disc Notes

## Supported Discs

The CD receiver supports the following discs.

| Disc     | Logo  | Format or file type                   |
|----------|---|---------------------------------------|
| Audio CD |  | PCM                                   |
| CD-R     |  | Audio CD, MP3                         |
|          |  | MP3                                   |
| CD-RW    |  | Audio CD, MP3                         |
|          |  | MP3                                   |
| CD Extra |   | Audio CD (Session 1), MP3 (Session 2) |

- Some audio CDs use copy protection that doesn't conform to the official CD standard. Since these are non-standard discs, they may not play properly in the CD receiver.
- The CD receiver supports 8 cm and 12 cm discs.
- The CD receiver does not support disc types not listed.
- Don't use discs with an unusual shape, such as those shown below, as you may damage the CD receiver.



- Don't use discs that have residue from adhesive tape, rental discs with peeling labels, or discs with custom-made labels or stickers. Doing so may damage the CD receiver and you may not be able to remove the disc properly.

## CD-R/RW Compatibility

- The CD receiver supports CD-R and CD-RW discs. However, some CD-R and CD-RW discs may not work properly for any of the following reasons: disc burner characteristics, disc characteristics, the disc is damaged or dirty. See the manual supplied with your disc burner for more information. Condensation or dirt on the optical pickup lens can also affect playback.
- Make sure to use discs that have been finalized.

## Discs Made on Personal Computers

Discs made on personal computers, including those of a compatible format, may not work properly in the CD receiver because of incorrect settings in the disc burning software. Check the manuals supplied with your disc burning software for additional compatibility information.

## MP3 Compatibility

- MP3 discs must be ISO 9660 Level 1 or Level 2, Romeo or Joliet compliant. Supported formats: Mode 1, Mode 2 XA Form 1.
- Folders can be up to eight levels deep.
- MP3 files must be MPEG-1/MPEG-2 Audio Layer 3 format with a sampling rate of between 8 kHz and 48 kHz and a bit-rate of between 8 kbps and 320 kbps (128 kbps recommended). Incompatible files cannot be played.
- Constant bit rate MP3 files are recommended, however, variable bit-rate (VBR) MP3 files between 8 kbps and 320 kbps are supported. (Playing times may not display correctly.)
- MP3 files must have a ".mp3" or ".MP3" file name extension. MP3 files without the proper extension will not be recognized. To prevent noise and malfunction, do not use these extensions for other types of files.
- The CD receiver supports up to 499 MP3 files and folders. Files and folders in excess of this cannot be played. Note that if the file and folder structure is very complicated, the CD receiver may not be able to read or play all of the MP3 files on the disc.
- Disc, file, and folder names may contain up to 32 characters.
- The maximum time that can be displayed for a single file is 99 minutes and 59 seconds.
- The remaining time cannot be displayed when playing MP3 files.
- MP3 file and folder names (excluding the extension) are shown on the display.
- Multisession discs are supported, however, some multisession discs may take a long time to load and some may not load at all. When burning CDs, we recommend that you use a single-session (disc-at-once), and select "Disc Close".
- Normally, the music in the audio session of a CD Extra disc is played. However, you can set the CD receiver so that it plays any MP3 files in the data session of a CD-R/RW disc instead. If the data session contains no MP3 files, the audio session will be played regardless. See "Setting MP3 Preferences" on page 35 for more information.
- The Emphasis is not supported.

## Disc Notes—Continued

- The following ID3 tags are supported: versions 1.0/1.1 and 2.2/2.3/2.4. Versions 2.5 and later are not supported. Normally, version 2.2/2.3/2.4 tags have priority and will be displayed.
- For ID3 version 2 tags, the tag information recognized will be those embedded in the beginning of the file. We recommend that you include only title, artist name, and album name information in ID3 tags. Compressed, encrypted, and unsynchronized ID3 tags cannot be displayed.

### Note:

With CD-ROM, CD-R, and CD-RW discs that contain many files and folders and files other than MP3s, it may take a long time to read the disc. We recommend that you include only MP3 files on your discs, use about 20 folders, and limit folder nesting to three levels deep.

## Disc Content Organization

### ■ CD

CDs contain tracks.



### ■ MP3

MP3 discs contain MP3 files organized into folders.

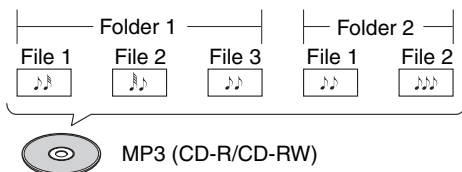

## Handling Discs

- Never touch the underside of a disc. Always hold discs by the edge, as shown.

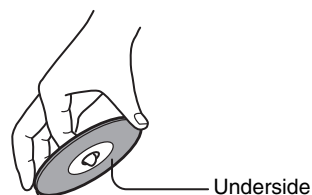

- Never attach adhesive tape or sticky labels to discs.



## Cleaning Discs

- For best results, keep your discs clean. Fingerprints and dust can affect the sound quality and should be removed as follows. Using a clean soft cloth, wipe from the center outwards, as shown. Never wipe in a circular direction.



- To remove stubborn dust or dirt, wipe the disc with a damp soft cloth, and then dry it with a dry cloth.
- Never use solvent-based cleaning fluids, such as thinner or benzene, commercially available cleaners, or antistatic sprays intended for vinyl records, as they may damage the disc.

## Storing Discs

- Don't store discs in places subject to direct sunlight or near heat sources.
- Don't store discs in places subject to moisture or dust, such as in a bathroom or near a humidifier.
- Always store discs in their cases and vertically. Stacking, or putting objects on unprotected discs may cause warping, scratches, or other damage.



# Connecting Antennas

This section explains how to connect the supplied indoor FM antenna and AM loop antenna, and how to connect commercially available outdoor FM and AM antennas. The CD receiver won't pick up any radio signals without an antenna connected, so you must connect the antenna to use the tuner.

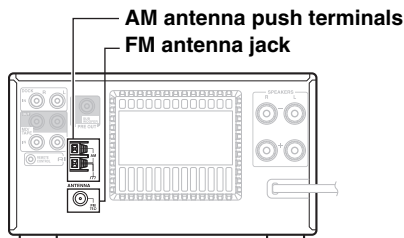

## Connecting the Indoor FM Antenna

The supplied indoor FM antenna is for indoor use only.

### 1 Attach the FM antenna, as shown.

#### ■ North American Model

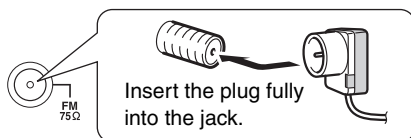

#### ■ Other Models

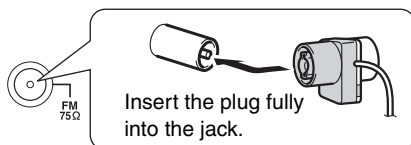

Once the CD receiver is ready for use, you'll need to tune into an FM radio station and adjust the position of the FM antenna to achieve the best possible reception.

### 2 Use thumbtacks or something similar to fix the FM antenna into position.

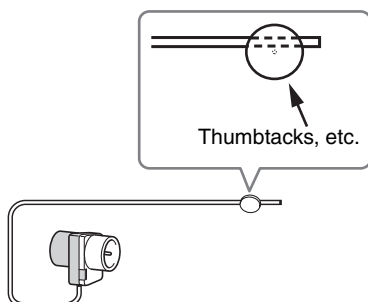

#### Caution:

Be careful that you don't injure yourself when using thumbtacks.

If you cannot achieve good reception with the supplied indoor FM antenna, try a commercially available outdoor FM antenna instead (see page 18).

## Connecting the AM Loop Antenna

The supplied indoor AM loop antenna is for indoor use only.

### 1 Assemble the AM loop antenna, inserting the tabs into the base, as shown.

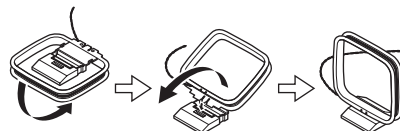

### 2 Connect both wires of the AM loop antenna to the AM push terminals, as shown.

(The antenna's wires are not polarity sensitive, so they can be connected either way around).

Make sure that the wires are attached securely and that the push terminals are gripping the bare wires, not the insulation.

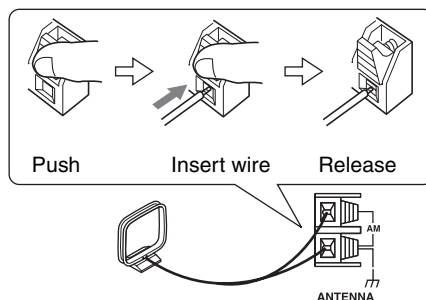

Once the CD receiver is ready for use, you'll need to tune into an AM radio station and adjust the position of the AM antenna to achieve the best possible reception.

Keep the antenna as far away as possible from the CD receiver, TV, speaker cables, and power cords.

If you cannot achieve good reception with the supplied indoor AM loop antenna, try using it with a commercially available outdoor AM antenna (see page 18).

## Connecting Antennas—Continued

### Connecting an Outdoor FM Antenna

If you cannot achieve good reception with the supplied indoor FM antenna, try a commercially available outdoor FM antenna instead.

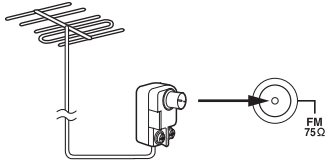

#### Notes:

- Outdoor FM antennas work best outside, but usable results can sometimes be obtained when installed in an attic or loft.
- For best results, install the outdoor FM antenna well away from tall buildings, preferably with a clear line of sight to your local FM transmitter.
- Outdoor antenna should be located away from possible noise sources, such as neon signs, busy roads, etc.
- For safety reasons, outdoor antenna should be situated well away from power lines and other high-voltage equipment.
- Outdoor antenna must be grounded in accordance with local regulations to prevent electrical shock hazards.

### ■ Using a TV/FM Antenna Splitter

It's best not to use the same antenna for both FM and TV reception, as this can cause interference problems. If circumstances demand it, use a TV/FM antenna splitter, as shown.

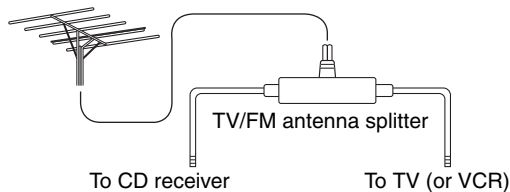

### Connecting an Outdoor AM Antenna

If good reception cannot be achieved using the supplied AM loop antenna, an outdoor AM antenna can be used in addition to the loop antenna, as shown.

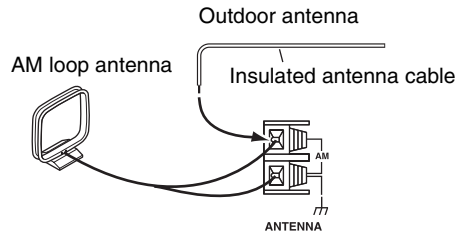

Outdoor AM antennas work best when installed horizontally outside, but good results can sometimes be obtained indoors by mounting horizontally above a window. Note that the AM loop antenna should be left connected.

Outdoor antenna must be grounded in accordance with local regulations to prevent electrical shock hazards.

# Connecting Speakers

## Connecting Your Speakers

- Connect the right speaker to the CD receiver's right (R) SPEAKERS terminals. Connect the left speaker to the left (L) SPEAKERS terminals.
- Connect the positive (+) terminal on each speaker to the corresponding positive (+) terminal on the CD receiver. Connect the negative (–) terminal on each speaker to the corresponding negative (–) terminal on the CD receiver. Use the red wires to connect the positive (+) terminals.

Right speaker      Left speaker

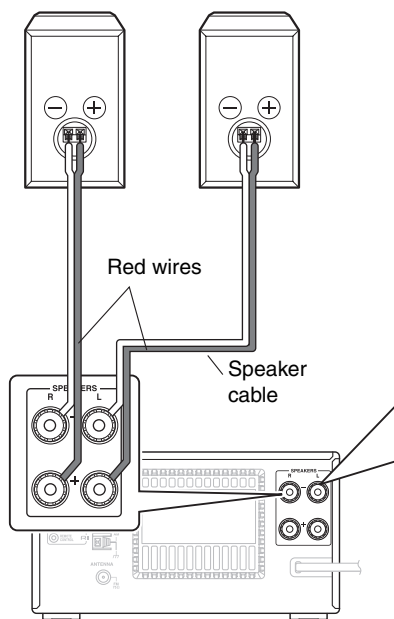

### —Terminal posts—

Strip about 15 mm (5/8") of insulation from the ends of the speaker cables, and twist the bare wires tightly. Unscrew the terminal. Fully insert the bare wire, making sure that it's touching the threaded shaft in the center. Screw the terminal tight.



- Connect only speakers with an impedance of between 4 and 16 ohms. Connecting a speaker with a lower impedance may damage the speaker.
- Be careful not to short the positive and negative wires. Doing so may damage the CD receiver.

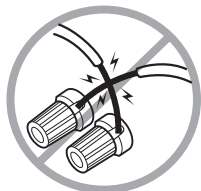

- Do not connect both speaker cables to the same L or R terminals (Fig. 1). Do not connect more than two speaker terminals to each speaker (Fig. 2).

Fig. 1

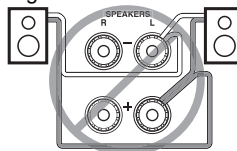
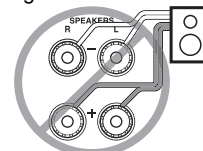

Fig. 2



# Connecting Other Components

## About Connections

- Before making any connections, read the manuals supplied with your other components.
- Don't connect the power cord until you've completed and double-checked all connections.

## Connection Color Coding

RCA-type audio connections are usually color-coded: red and white. Use red plugs to connect right-channel audio inputs and outputs (typically labeled "R"). Use white plugs to connect left-channel audio inputs and outputs (typically labeled "L").

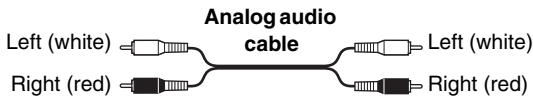

- Push plugs in all the way to make good connections (loose connections can cause noise or malfunctions).
- To prevent interference, keep audio cables away from power cords and speaker cables.

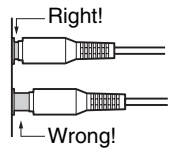

### Note:

Do not put anything on top of the CD receiver, as it may interfere with proper ventilation.

## Connecting a Subwoofer

The CD receiver has a SUBWOOFER PRE OUT jack for connecting a powered subwoofer (i.e., a subwoofer with a built-in amplifier).

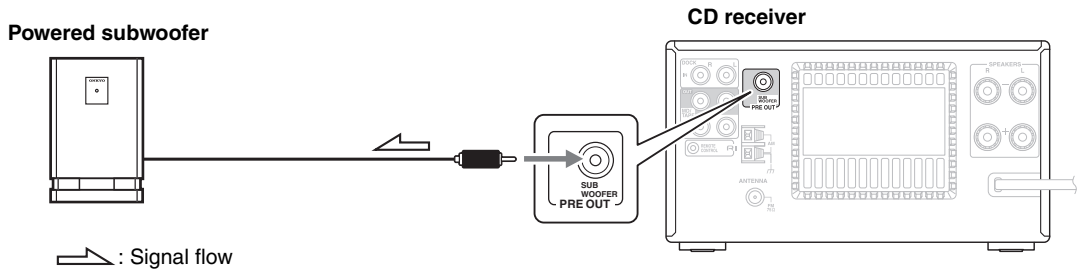

### Connecting an Onkyo Cassette Deck

The following diagram shows how to connect an optional Onkyo cassette deck.

Connect the CD receiver's MD/TAPE OUT jacks to the cassette deck's INPUT (REC) jacks, and connect the CD receiver's MD/TAPE IN jacks to the cassette deck's OUTPUT (PLAY) jacks.

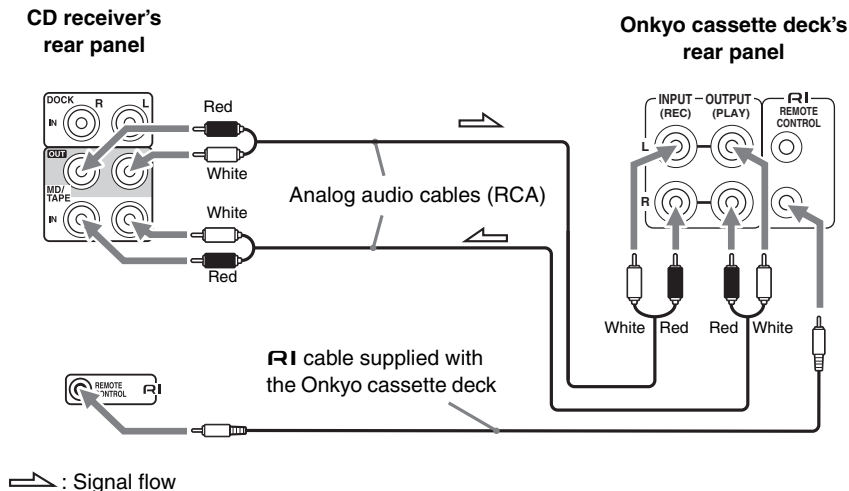

#### What can you do with RI?

- Connecting an Onkyo cassette deck to the CD receiver with an **RI** cable allows you to control the cassette deck with the CD receiver's remote controller. In addition, when playback is started on the cassette deck, the CD receiver will automatically select it as the input source.
- To use **RI**, you must connect the Onkyo cassette deck to the CD receiver with an **RI** cable and an analog audio cable (RCA). In addition, the Input Display for the MD/TAPE jacks must be set to "TAPE". Since this is the default setting, unless you've changed it, it can be left as it is (see page 27).
- Some **RI**-capable components have two **RI** jacks. They're both the same, so you can use either one. The extra jack is for connecting additional **RI**-capable components.

#### Notes:

- When listening to the audio of a component connected to the CD receiver but with no **RI** connection, select TAPE input source.
- It is also possible to connect the MD/TAPE jacks to a DAT recorder. When connected to a DAT recorder, set the Input Display to "DAT" (see page 27).
- The MD/TAPE IN jacks can be connected to the audio output jack of a VCR. The VCR video output jack should be connected to a TV. When the CD receiver is connected to a VCR, set the Input Display to "VIDEO" (see page 27).

### Connecting an Onkyo MD recorder

The following diagram shows how to connect an optional Onkyo MD recorder.

Connect the CD receiver's MD/TAPE OUT jacks to the MD recorder's INPUT (REC) jacks, and connect the CD receiver's MD/TAPE IN jacks to the MD recorder's OUTPUT (PLAY) jacks.

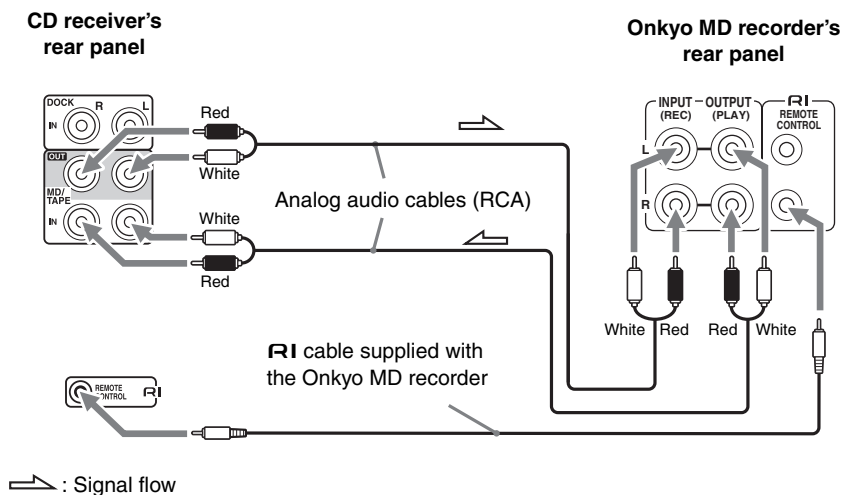

#### What can you do with RI?

- Connecting an Onkyo MD recorder to the CD receiver with an **RI** cable allows you to control the MD recorder with the CD receiver's remote controller. In addition, when playback is started on the MD recorder, the CD receiver will automatically select it as the input source.
- To use **RI**, you must connect the Onkyo MD recorder to the CD receiver with an **RI** cable and an analog audio cable (RCA). In addition, the Input Display for the MD/TAPE jacks must be set to "MD" (see page 27).
- Some **RI**-capable components have two **RI** jacks. They're both the same, so you can use either one. The extra jack is for connecting additional **RI**-capable components.

#### Notes:

- When listening to the audio of a component connected to the CD receiver but with no **RI** connection, select TAPE input source.
- It is also possible to connect the MD/TAPE jacks to a DAT recorder. When connected to a DAT recorder, set the Input Display to "DAT" (see page 27).
- The MD/TAPE IN jacks can be connected to the audio output jack of a VCR. The VCR video output jack should be connected to a TV. When the CD receiver is connected to a VCR, set the Input Display to "VIDEO" (see page 27).

## Connecting Other Components—Continued

### Connecting an Onkyo RI Dock (Remote Interactive Dock)

The following diagram shows how to connect an optional Onkyo RI Dock (Remote Interactive Dock). Connect the CD receiver's DOCK IN jacks to the RI Dock's AUDIO OUT jacks.

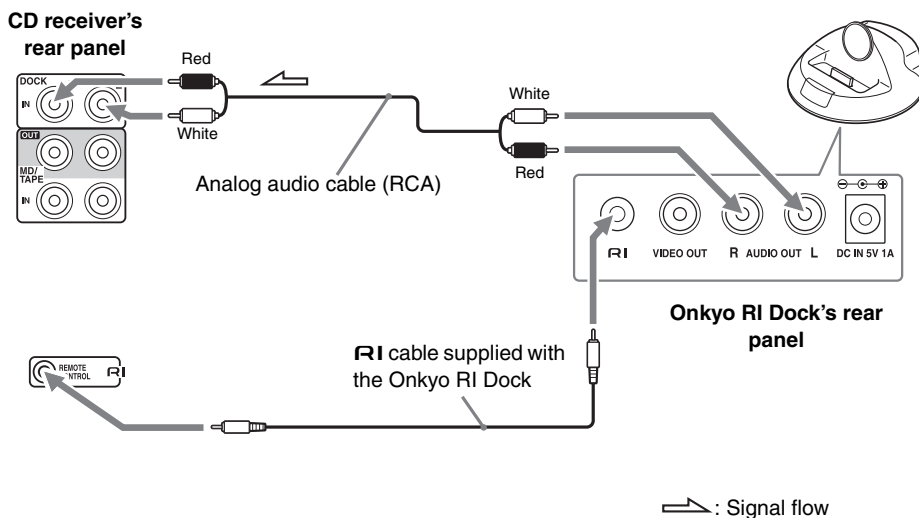

#### What can you do with RI?

- Connecting an Onkyo RI Dock to the CD receiver with an **RI** cable allows you to control the RI Dock with the CD receiver's remote controller. In addition, when playback is started on the RI Dock, the CD receiver will automatically select it as the input source.
- To use **RI**, you must connect the Onkyo RI Dock to the CD receiver with an **RI** cable and an analog audio cable (RCA). On the RI Dock, set the RI MODE switch to "HDD" or "HDD/DOCK". See the RI Dock's instruction manual for details.

## Connecting the Power Cord

#### Notes:

- Before connecting the power cord, connect all of your speakers and AV components.
- Turning on the CD receiver may cause a momentary power surge that might interfere with other electrical equipment on the same circuit. If this is a problem, plug the CD receiver into a different branch circuit.

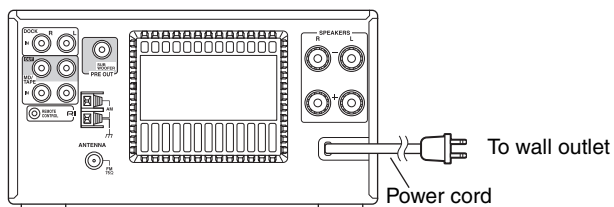

#### Plug the power cord into a suitable wall outlet.

The STANDBY indicator lights up.

#### For European models

To set the clock with the AccuClock function, the CD receiver must be able to receive RDS radio stations, which means an FM antenna must be connected (see page 17).

# First Time Setup (European models only)

## Setting the Clock with the AccuClock Function

To use the AccuClock function, the CD receiver must be able to receive RDS radio stations, which means an FM antenna must be connected. Be sure to connect an FM antenna before attempting to use this function (see page 17).

The very first time you turn on the CD receiver, the AccuClock function automatically sets the CD receiver's clock based on the CT (Clock Time) information present in an RDS radio broadcast. While the clock is being set, "Wait..." flashes on the display, as shown. Note that it may take up to 5 minutes to set the clock.

When the clock has been set, the message "Clock Adjusted" scrolls across the display, then the day and time are displayed for a while, as shown.







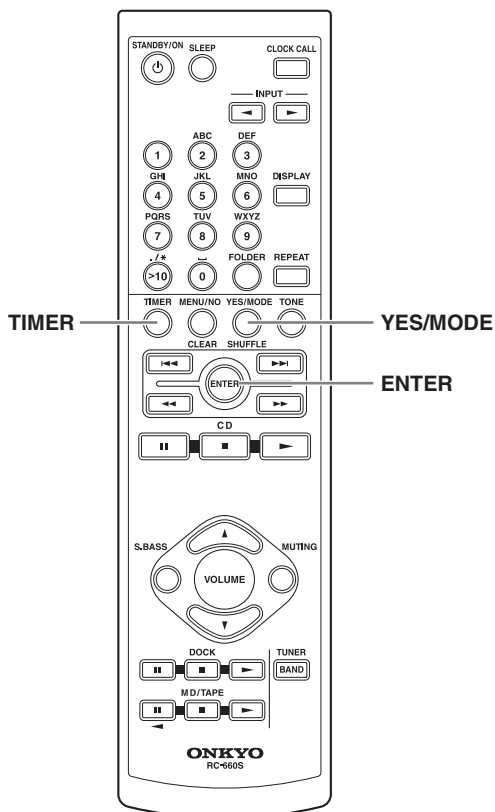

The AccuClock function automatically updates the clock daily at 2 A.M., 3 A.M., and 2 P.M.

If for some reason the clock cannot be set automatically, see "Setting AccuClock to Use a Specific Station (European models only)" on page 49 and "Setting the Clock Manually" on page 50.

## Turning Off the AccuClock Function

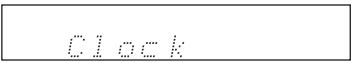
If you don't want AccuClock to automatically update the clock each day, you can turn it off as follows.



|   |   |
|---|---|
| <b>1</b><br>TIMER<br>     | <b>Press the [TIMER] button repeatedly until "Clock" appears on the display.</b><br>   |
| <b>2</b><br>             | <b>Press [ENTER].</b><br>**AccuClock** appears on the display.<br><br>The asterisks indicate that the AccuClock function is on.   |
| <b>3</b><br>YES/MODE<br> | <b>To turn off AccuClock, press the [YES/MODE] button.</b><br><br>The asterisks disappear, indicating that the AccuClock function is off. To turn AccuClock back on again, press the [YES/MODE] button so that the asterisks are displayed. |

### Note:

The AccuClock function cannot be turned off until the clock has been set.



# Basic Operations

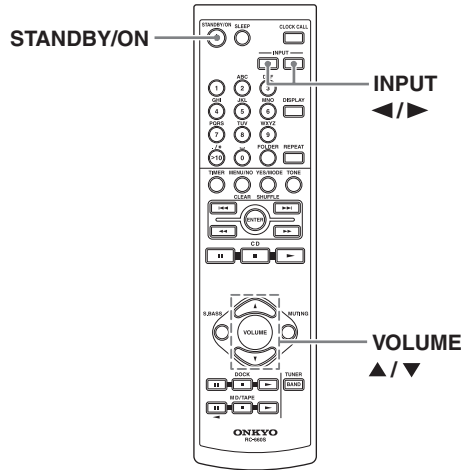
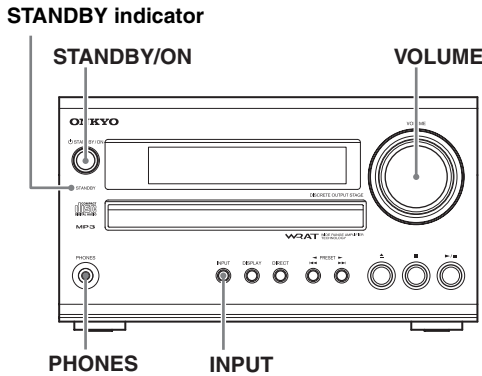

## Turning On the CD receiver

CD receiver



Remote controller



To turn on the CD receiver, press the [STANDBY/ON] button on the CD receiver or remote controller. The STANDBY indicator goes off.

Press the [STANDBY/ON] button again to set the CD receiver to Standby. The STANDBY indicator lights up.

### Tip:

When you start playback on (or turn on) an Onkyo RI Dock, MD recorder, or cassette deck that's connected to the CD receiver with an **RI** cable and analog audio cable, the CD receiver turns on automatically. Similarly, when you set the CD receiver to On or Standby, the other component will also be set to On or Standby.

## Adjusting the Volume

CD receiver

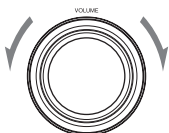

Remote controller



Turn the [VOLUME] control clockwise to increase the volume or counterclockwise to decrease it.

You can also use remote controller's VOLUME [▲]/[▼] buttons.

## Selecting the Input Source

You can select CD, AM, FM, or a connected component (TAPE, DOCK, USB) as the input source.

To select the input source, press the remote controller's INPUT [◀]/[▶] buttons repeatedly. On the CD receiver, press the [INPUT] button repeatedly. The input sources are selected in the following order.

### • CR-525

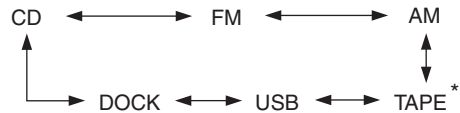

### • CR-325

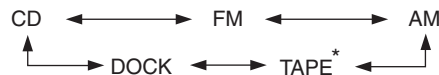

\* Input Display can be changed (see page 27).

## Using Headphones

Turn down the volume, then connect your stereo headphones to the PHONES minijack.

You can adjust the volume and mute the sound, as explained earlier.

The speakers output no sound while the headphones are connected.

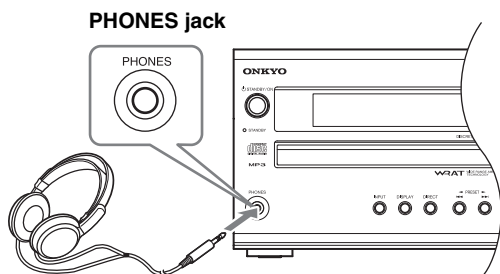

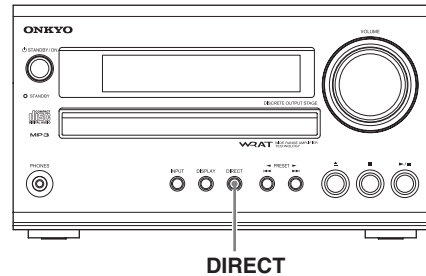
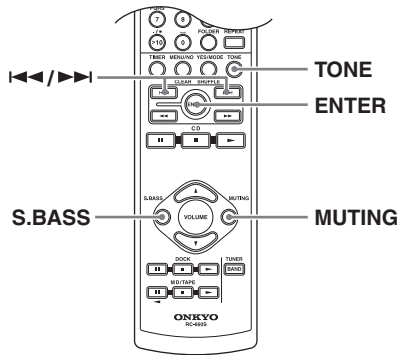

## Adjusting the Bass and Treble

1

Remote controller

TONE



Press the [TONE] button to select "Bass".

2



Use the Previous and Next [◀◀]/[▶▶] buttons to adjust the bass.

The default setting is "±0". You can adjust the bass and treble from -3 to +3. Press [ENTER], and then use the Previous and Next [◀◀]/[▶▶] buttons to adjust the treble.

### Notes:

- If you press no buttons for 8 seconds, the previous display will appear automatically.
- If you press the [TONE] button while the Direct function is on, the Direct function will be turned off.

## Using the Direct Function

To turn the Direct function on or off, press the [DIRECT] button on the CD receiver.

When the Direct function is off, the tone controls can be used to adjust the sound.

When the Direct function is on, the tone controls are bypassed, so you can enjoy a pure sound, and the DIRECT indicator lights up.

CD receiver  
DIRECT



DIRECT indicator



On the remote controller, press the [TONE] button for 3 seconds to turn on the Direct function.

## Muting the Sound

To mute the output of the CD receiver, press the remote controller's [MUTING] button.

The MUTING indicator flashes on the display. The volume control indicator flashes, too.

Remote controller

MUTING



MUTING



MUTING indicator



To unmute the CD receiver, press the [MUTING] button again.

### Tips:

While the CD receiver is muted:

- Turning the [VOLUME] control on the CD receiver or pressing the VOLUME [▲]/[▼] buttons on the remote controller will unmute the CD receiver.
- If you turn the CD receiver off, the next time you turn it on, the CD receiver will be unmuted.

## Using the Super Bass Function

To turn on the Super Bass function, press the [S.BASS] button.

The S.BASS indicator lights up.

To turn off the Super Bass function, press the [S.BASS] button again.

### Note:

If you press the [S.BASS] button while the Direct function is on, the Direct function will be turned off.

Remote controller

S.BASS

S.BASS



## Changing the Input Display

You can choose what name is displayed when an input source is selected so that it matches the type of component that you've connected to the MD/TAPE IN. When you connect an Onkyo **RI**-capable component, it's important that you select the input source name that matches the type of component for **RI** to work properly.

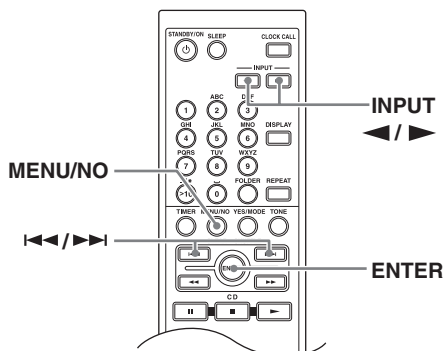

**4**

Press [ENTER] to confirm your selection.



"Complete" appears on the display.

### Input Source Name Abbreviations

Sometimes the input source name may be displayed as a 2-letter abbreviation, as per the following table.

| Full name | Abbreviation |
|-----------|--------------|
| DAT       | DT           |
| MD        | MD           |
| TAPE      | TP           |
| VIDEO     | VD           |

**1**

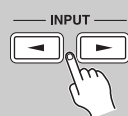

Use the INPUT [◀]/[▶] buttons to select "TAPE".

**2**

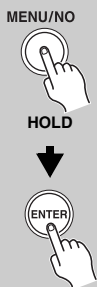

Press and hold the [MENU/NO] button until "Name Select?" appears on the display, and then press [ENTER].

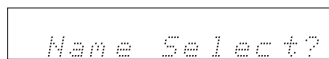

**3**



Use the Previous or Next [◀◀]/[▶▶] button to select the new input source name.



The input source names are selected in the following orders:

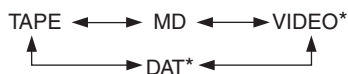

\* When you select an input source name, you cannot select it as the recording component at the set timer recording.

# Playing CDs

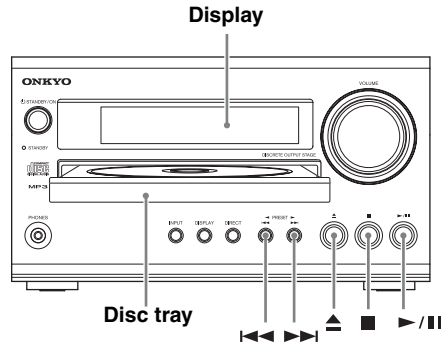

- 1**



**Press the Open/Close [▲] button to open the disc tray.**

**Tip:**  
Pressing the Open/Close [▲] button while the CD receiver is on Standby will turn on the CD receiver and open the disc tray.
- 2**

**Place the CD on the tray with the label-side facing up.**  
Place 8 cm CDs in the center of the tray.
- 3**



**To start playback, press the Play/Pause [▶/||] button.**  
The disc tray closes and playback starts.

**To stop playback:**  
Press the Stop [■] button. Playback stops automatically when the last track has been played.

**To pause playback:**  
Press the Play/Pause [▶/||] button. The Pause [||] indicator appears. To resume playback, press the Play/Pause [▶/||] button again.

**To remove the CD:**  
Press the Open/Close [▲] button to open the disc tray.

## • Audio CD Display

“DISC TOTAL” lights up while the disc information is being displayed.

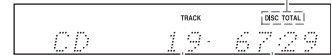

Total number of tracks      Total playing time

## • MP3 CD Display

Disc name or file format



Total number of folders      Total number of files

## Selecting Tracks

**To return to the beginning of the track currently playing, press the Previous [◀◀] button.**

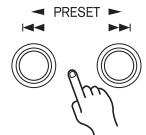

**Press the Previous [◀◀] button repeatedly to select earlier tracks.**

- While playback is stopped, pressing the Previous [◀◀] button will select the previous track.

**Press the Next [▶▶] button repeatedly to select subsequent tracks.**

- On MP3 CDs, you can select MP3 files in other folders (see page 30).

## Using the Remote Controller

**Use the number buttons as shown in the examples below to select tracks.**

| To select: | Press:  |
|------------|---------|
| Track #8   | 8       |
| Track #10  | 0       |
| Track #34  | >10 3 4 |

⊙>10 Used to enter numbers over 10.  
With MP3 CDs, you can select files in the current folder with these buttons.

**Press to select tracks**

- Press the Previous [◀◀] button to locate the beginning of the currently playing or paused track. Press it repeatedly to select earlier tracks.
- Press the Next [▶▶] button repeatedly to select subsequent tracks. On MP3 CDs, you can select files in other folders (see page 30).

**Press to pause playback**  
To resume playback, press the Pause [⏸] or Play [▶] button.

ONKYO RC-6605

**Press to display more CD information**

**Press to fast forward or fast reverse**  
During playback or while playback is paused, press and hold the Fast Forward [▶▶] button to fast forward, or the Reverse [◀◀] button to fast reverse.

**Press to start playback**  
Pressing this button while the CD receiver is on Standby will turn on the CD receiver and start playback.

**Press to stop playback**

**Press to adjust the volume**  
Press the VOLUME Up [▲] button to turn up the volume. Press the VOLUME Down [▼] button to turn it down.

## Displaying CD Information

During playback or while playback is paused, press the remote controller's [DISPLAY] button repeatedly to display the following CD information.

TRACK

CD 1- 0:13

The elapsed track time is displayed.

TRACK

CD 1- 4:38

REMAIN

**“REMAIN”**  
Lights up while the remaining track time is being displayed.

TRACK

CD 1- 67:16

TOTAL REMAIN

**“TOTAL REMAIN”**  
Lights up while the remaining disc time is being displayed.  
The total time is more than 99 minutes and 59 seconds, “- -: -” is displayed.

**Note:**  
See page 32 for details on displaying MP3 information.

**Note:**  
You can also use the CD receiver's [DISPLAY] button to display this information.

**Selecting/Playing MP3 Files**

On an MP3 CD, MP3 files may be organized in a hierarchically, with folders containing files and subfolders, as shown below. On the CD receiver, there are two modes for selecting MP3 files: *Navigation mode* and *All Folder mode*. In Navigation mode, you can select MP3 files by navigating through the folder hierarchy, moving in and out of folders and subfolders. In All Folder mode, all folders appear at the same level, making it easy to select folders regardless of the hierarchy.

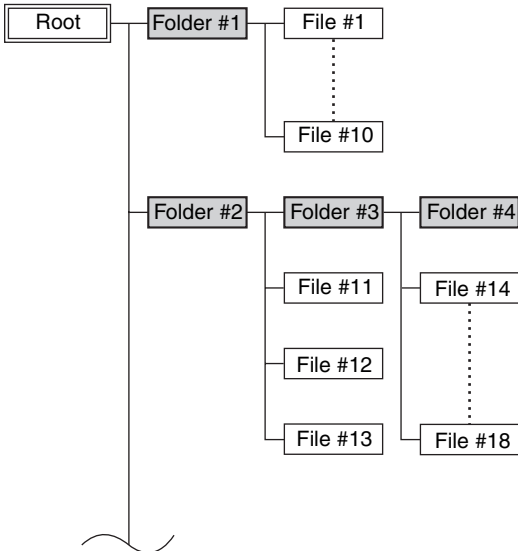

If you don't select a specific MP3 file or folder for playback, all of the MP3 files on the CD will be played in numerical order starting with file #1.

**Selecting MP3 Files in Navigation Mode**

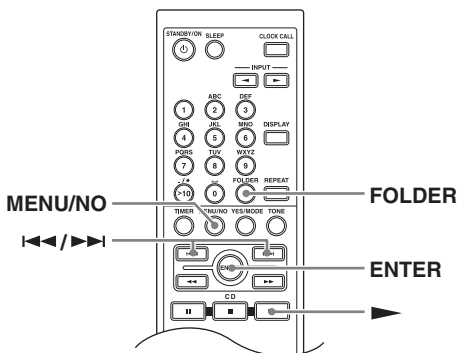

With Navigation mode, you can select MP3 files by navigating through the folder hierarchy. This mode can only be used while playback is stopped. If random mode or 1-folder mode is currently selected, press the [YES/MODE] button to cancel it before proceeding.

- 1** While playback is stopped, press the [FOLDER] button.

The CD receiver enters Navigation mode and “Root” appears on the display.

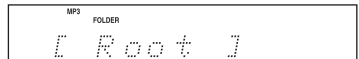

- 2** Press [ENTER].

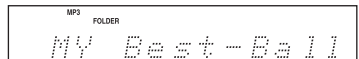
The name of the first folder one level down from root appears on the display.





If the disc contains no folders, the name of the first MP3 file is displayed.
- 3** Use the Previous and Next [◀]/[▶] buttons to select other folders and files at the same level.

Folders that don't contain MP3 files or subfolders can't be selected.

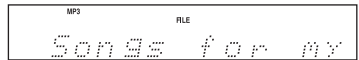

- 4** To access files or subfolders inside another folder, select the folder, and then press [ENTER].

Use the Previous and Next [◀]/[▶] buttons to select the files and subfolders within that folder.





To move up a level, press the [MENU/NO] button.
- 5** To start playback, press the [ENTER] or Play [▶] button.

Playback will start with the specified file or folder and continue until all of the MP3 files on the disc have been played.

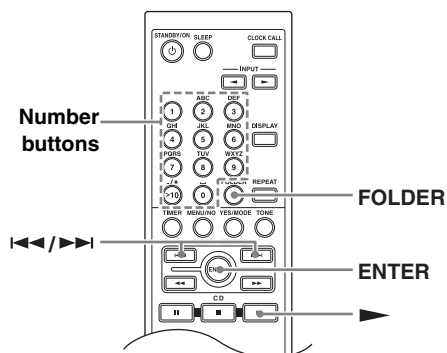

## Selecting MP3 Files in All Folder Mode



With All Folder mode, you don't have to navigate the folder hierarchy because all folders that contain MP3 files appear at the same level.

If random playback is currently selected, press the [YES/MODE] button to cancel it before proceeding.

**1**



**While playback is stopped, press and hold the [FOLDER] button for 2 seconds.**

The CD receiver enters All Folder mode and the name of the first folder appears on the display.

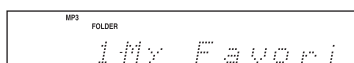

**2**



**Use the Previous and Next [◀]/[▶] buttons to select the other folders.**

You can select any folder that contains MP3 files.

To play the first file in the selected folder, go to Step 4.

**3**



**To access the files inside the folder, press the [FOLDER] button.**

The name of the first MP3 file inside the folder is displayed.

Use the Previous and Next

[◀]/[▶] buttons to select the MP3 files within the folder.



To select another folder, press the [FOLDER] button again, and then use the Previous and Next [◀]/[▶] buttons to select it.

**4**



**To start playback, press the [ENTER] or Play [▶] button.**

Playback will start with the specified file or folder and continue until all of the MP3 files on the disc have been played.

To select an MP3 file in another folder during playback, press the [FOLDER] button, select the folder by using the Previous and Next [◀]/[▶] buttons, and then press [ENTER]. Now use the Previous and Next [◀]/[▶] buttons to select the MP3 files within that folder.

### ■ Pausing Playback

To pause playback, press the Pause [⏸] button. To resume playback, press it again.

### ■ Cancelling Navigation or All Folder Mode

To cancel Navigation mode or All Folder mode while selecting MP3 files, press the Stop [■] button.

### ■ Selecting MP3 Folders and Files by Number

- 1 Press the [FOLDER] button for 2 seconds to enter All Folder mode.
- 2 Use the number buttons as shown in the examples below to enter folder numbers.

| To select: | Press:         |
|------------|----------------|
| Folder #8  | [8]            |
| Folder #10 | [0]            |
| Folder #34 | [<10>] [3] [4] |

[<10>] Used to enter numbers over 10.

If playback is stopped, playback starts with the first MP3 file in the specified folder. If playback is already in progress, press [ENTER] to play the first MP3 file in the specified folder.

- 3 Use the number buttons to enter the file number. Playback starts.

If a folder contains more than 99 MP3 files, double-digit file numbers must be preceded by zeros. For example, to specify file #5, press [5]. To specify file #32, press [>10], [0], [3], and [2].

## Playing the MP3 Files in Only One Folder

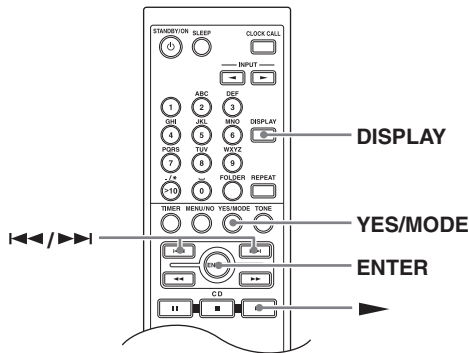



Normally, all of the MP3 files in all of the folders on the disc are played. With 1-folder playback, only the MP3 files in the specified folder are played.

- 1** Press the [YES/MODE] button repeatedly until the 1FOLDER indicator appears.



1FOLDER indicator

- 2** Use the Previous and Next [◀◀]/[▶▶] buttons to select the folder.



You can select any folder that contains MP3 files.
- 3** To start playback, press the [ENTER] or Play [▶] button.



Playback will start with the first MP3 file in the specified folder and continue until all of the MP3 files in that folder have been played.

### Displaying MP3 Information

You can display various information about the MP3 file currently playing, including ID3 tags such as title, artist name, and album name.

- DISPLAY**
- 
- During playback, press the [DISPLAY] button repeatedly to display the following MP3 information.**

#### Elapsed time:

The length of time that the current MP3 file has been playing (default display). If the elapsed time is more than 99 minutes and 59 seconds, “--:--” is displayed.



#### File name:

Name of the current MP3 file.



#### Folder name:

Name of the current folder.



#### Title name:

Title of the current file (if ID3 tag present).

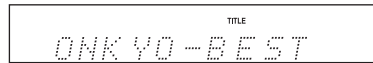

#### Artist name:

Name of the artist (if ID3 tag present).

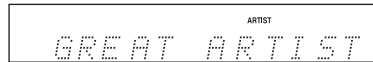

#### Album name:

Name of the album (if ID3 tag present).

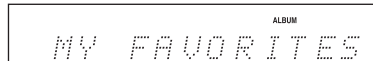

#### Sampling rate and bit rate:

Sampling rate and bit rate of the current MP3 file.

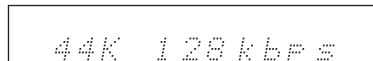

#### Notes:

- You can also use the CD receiver’s [DISPLAY] button to display this information.
- To display the disc name, press the [DISPLAY] button while playback is stopped.
- If a file or folder name contains any characters that cannot be displayed, an underscore will be displayed in place of those characters. Alternatively, you can set the CD receiver so that names containing such characters are displayed as “File\_n” or “Folder\_n”, “n” being the file or folder number (see page 35).



## Memory Playback

With memory playback, you can create a playlist of up to 25 tracks.

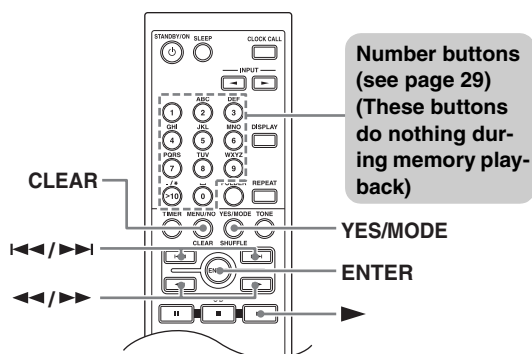

Memory playback can be set only when the input source is set to CD and playback is stopped.

**1**

YES/MODE



Press the [YES/MODE] button repeatedly until the MEMORY indicator appears.

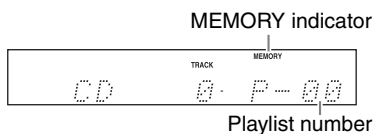

**2**



Use the Previous and Next [◀/▶] buttons to select the first track you want to add to the playlist, and then press [ENTER].

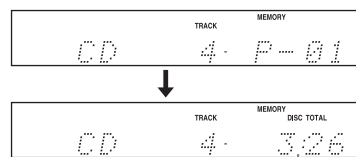

Track to be added to the playlist      Total time of playlist

Repeat this step to add additional tracks to the playlist.

You can also use the number buttons on the remote controller to select tracks.

**To select MP3 files for memory playback:**

In Navigation mode, use steps 1–4 on page 30. In All Folder mode, use steps 1–4 on page 31.

**To remove tracks from the playlist:** Press the [CLEAR] button. Each press removes the last track from the playlist.

**Notes:**

- If the total playing time is more than 99 minutes and 59 seconds, “--:--” is displayed.
- You can add up to 25 tracks to the playlist. If you try to add more, the message “Memory Full” appears.

**3**



To start memory playback, press the Play [▶] button.

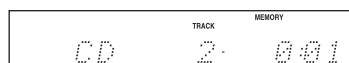

On the CD receiver, press the Play/Pause [▶/||] button to start memory playback.

## Selecting Other Tracks During Memory Playback

To select other playlist tracks during memory playback, use the remote controller's Previous and Next [◀/▶] buttons.

## Checking What's on the Playlist

To check what tracks are on the playlist, with playback stopped, use the Fast Reverse and Fast Forward [◀◀/▶▶] buttons to scroll through the playlist.

## Removing Tracks from the Playlist

- While memory playback is stopped, press the [CLEAR] button. Each press removes the last track from the playlist.
- The playlist will be deleted when you cancel memory playback, select random playback, press the Open/Close [▲] button to open the disc tray, or turn off the CD receiver.

## Cancelling Memory Playback

- To cancel Memory playback, press the [YES/MODE] button repeatedly until the MEMORY indicator disappears.
- Memory playback is cancelled when you press the Open/Close [▲] button to open the disc tray, or turn off the CD receiver.

## Random Playback

With random playback, all of the tracks on the disc are played in random order.

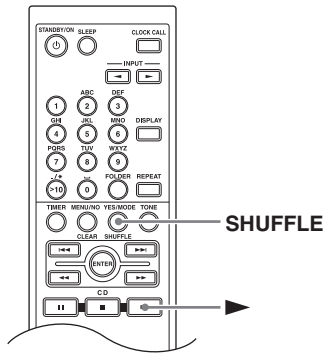

Random playback can be set only when the input source is set to CD and playback is stopped.

|  |   |
|--|---|
| <p><b>1</b></p> <p>YES/MODE</p> <p>SHUFFLE</p> | <p>Press the [SHUFFLE] button repeatedly until the RANDOM indicator appears.</p> <div style="border: 1px solid black; padding: 5px; text-align: center;"> <p>RANDOM indicator</p> <p>CD    TRACK    RANDOM DISC TOTAL</p> <p>10    47:27</p> </div> |
| <p><b>2</b></p>                                | <p>To start random playback, press the Play [▶] button.</p> <div style="border: 1px solid black; padding: 5px; text-align: center;"> <p>CD    TRACK    RANDOM</p> <p>6    0:01</p> <p>Track currently playing</p> </div>                            |

### Cancelling Random Playback

- To cancel random playback, press the [SHUFFLE] button repeatedly until the RANDOM indicator disappears.
- Random playback is cancelled when you press the Open/Close [▲] button to open the disc tray, or turn off the CD receiver.

## Repeat Playback

With repeat playback, you can play an entire CD repeatedly, play one track repeatedly, or combine it with memory playback to play the playlist repeatedly, or random playback to play all of the tracks on the disc in random order repeatedly. With an MP3 CD, you can combine repeat playback with 1-folder playback to play all of the tracks in a specified folder repeatedly.

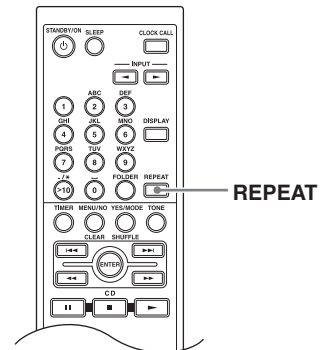

|               |   |
|---------------|---|
| <p>REPEAT</p> | <p>Press the [REPEAT] button repeatedly until the REPEAT or REPEAT 1 indicator appears.</p> <div style="border: 1px solid black; padding: 5px; text-align: center;"> <p>REPEAT or REPEAT 1 indicator</p> <p>REPEAT 1</p> </div> |
|---------------|---|

Repeat-1 playback can't be combined with memory playback, random playback, or 1-Folder playback.

### Cancelling Repeat Playback



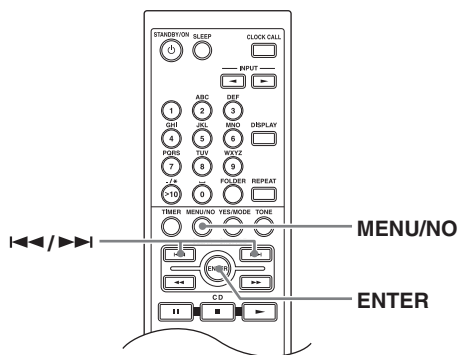

- To cancel repeat playback, press the [REPEAT] button repeatedly until both the REPEAT and REPEAT 1 indicators disappear.
- Repeat playback is cancelled when you press the Open/Close [▲] button to open the disc tray, or turn off the CD receiver.

## Setting MP3 Preferences

With the MP3 preferences, you can change the way MP3 file information is displayed and the way MP3 CDs are played.

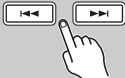

The MP3 preferences can be set only when the input source is set to CD and playback is stopped.

|  |  |
|--|--|
| <b>1</b><br>MENU/NO<br> | <p><b>Press the [MENU/NO] button repeatedly until “Bad Name?” appears.</b></p> <div style="border: 1px solid black; padding: 5px; text-align: center; margin-top: 10px;">             MP3<br/>Bad Name?         </div> |
| <b>2</b><br>          | <p><b>Use the Previous and Next [◀▶] buttons to select the preference you want to change.</b></p> <p>The preferences are explained in the next column.</p>   |
| <b>3</b><br>          | <p><b>Press [ENTER].</b></p>   |
| <b>4</b><br>          | <p><b>Use the Previous and Next [◀▶] buttons to select the preference’s options.</b></p>   |
| <b>5</b><br>          | <p><b>Press [ENTER].</b></p> <p>When the preference has been set, “Complete” appears on the display.</p>   |

To cancel the procedure at any point, press the [MENU/NO] button.

## Preferences

### Bad Name?

This preference determines whether or not file and folder names that contain undisplayable characters are replaced with “File\_n” or “Folder\_n”, “n” being the file or folder number. When set to “Not Replace”, displayable characters are displayed and underscore characters are used in place of any undisplayable characters.

For ID3 tags, underscore characters are used in place of undisplayable characters regardless of this preference.

- Replace**
- Not Replace (default)**

### Note:

On the CR-525, this setting will be reflected even when playing MP3 and WMA files from a USB mass storage device that is connected to the USB port of the CR-525.

### CD Extra?

This preference applies to CD Extra discs and determines whether music in the audio session or MP3 files in the data session are played.

- Audio:** Music in the audio session will be played (default).
- MP3:** MP3 files will be played.

### Joliet?

This preference applies to MP3 discs in Joliet format and determines whether the CD receiver reads the SVD data or treats the disc as an ISO 9660 disc. Normally, this preference doesn’t need to be changed.

SVD (Supplementary Volume Descriptor) supports long file and folder names and characters other than letters and numbers. Some CD burning software refers to the Joliet format as “Windows format”.

- Use SVD:** Reads in SVD data (default).
- ISO9660:** Will be read in as ISO9660 format.

### Hide Number?

This preference determines whether or not the numbers at the beginning of file and folder names are hidden.

When you create an MP3 CD on a personal computer, you cannot normally determine the playback order of the files. However, if you number the MP3 files in order, starting with 01, 02, 03, and so on, they will play in that order. If you don’t want these numbers to appear on the display, choose “Enable”.

- Disable:** The file and folder name, including numbers, will be displayed as is (default).
- Enable:** The file and folder name will be displayed but numbers will be hidden.

Continued on the following page.

## Playing CDs—Continued

---

The following table shows a few examples of numbered file and folder names and how they will appear with the “Disable” and “Enable” options.

| File/folder name | “Hide Number?” Option |              |
|------------------|-----------------------|--------------|
|                  | Disable               | Enable       |
| 01 Pops          | 01 Pops               | Pops         |
| 10-Rock          | 10-Rock               | Rock         |
| 16_Jazz          | 16_Jazz               | Jazz         |
| 21th Century     | 21th Century          | 21th Century |
| 05-07-20 Album   | 05-07-20 Album        | Album        |

**Note:**

On the CR-525, this setting will be reflected even when playing MP3 and WMA files from a USB mass storage device that is connected to the USB port of the CR-525.

**Folder Key?**

This preference determines how the [FOLDER] button works.

**All Folder:** Pressing the [FOLDER] button once selects All Folder mode.

Pressing and holding the [FOLDER] button for 2 seconds selects Navigation mode.

**Navigation (default):** Pressing the [FOLDER] button once selects Navigation mode.

Pressing and holding the [FOLDER] button for 2 seconds selects All Folder mode.

# Using USB interface (CR-525 only)

The CR-525 can play back MP3 and WMA files that have been stored on USB mass storage devices, e.g., USB flash drives and MP3 players.

## Supported Audio File Formats

For USB mass storage device playback, the CD receiver supports the following music file formats.

### ■ MP3

- MP3 files must be MPEG-1 Audio Layer 3 format with a sampling rate of 32 kHz, 44.1 kHz, and 48 kHz and a bit-rate of between 32 kbps and 320 kbps. Incompatible files cannot be played.
- Variable bit-rate (VBR) MP3 files are supported. (Playing times may not display correctly.)
- MP3 files must have a “.mp3” or “.MP3” filename extension.

### ■ WMA

WMA stands for Windows Media Audio and is an audio compression technology developed by Microsoft Corporation. The CD receiver supports WMA format that conform to the WMA ver.9 standard.

- WMA files must have the copyright option turned off.
- Sampling rates of 32 kHz, 44.1 kHz, and 48 kHz and bitrates of between 48 kbps and 320 kbps, are supported. Incompatible files cannot be played.
- Variable bit-rates (VBR) are supported. (Playing times may display incorrectly with VBR.)
- WMA files must have a “.wma” or “.WMA” filename extension.
- Protected WMA music files on an MP3 player cannot be played.

## USB Mass Storage Device Requirements

- The CD receiver supports USB mass storage devices that support the USB Mass Storage Class\*.
- Playback may not be possible with some USB devices even if they conform to the USB Mass Storage Class\*.
- USB mass storage devices formatted with the FAT16 or FAT32 file system are supported.
- If the USB mass storage device has been partitioned, only music files in the first partition can be played.
- Each folder may contain up to 500 music files, and folders may be nested up to eight levels deep.
- USB hubs and USB mass storage devices with hub functions are not supported.
- Onkyo accepts no responsibility whatsoever for the loss or damage to data stored on a USB mass storage device when that device is used with the CD receiver. We recommend that you back up your important music files beforehand.

- The CD receiver supports USB MP3 players that support the USB Mass Storage Class standard\*. Note that not all USB MP3 players support the USB Mass Storage Class standard\*. Refer your USB MP3 player’s instruction manual for details.
- MP3 players containing music files that are managed with special music software, and iPods containing music files managed with iTunes are not supported. To listen to iPod music on a CD receiver, connect an optional Onkyo RI Dock to the CD receiver (see page 23).
- Recording is not possible from the CD receiver to a USB mass storage device.

\* USB Mass Storage Class standard allows USB mass storage devices to be connected to computers without the need for special drivers or software.

## USB Mass Storage Device Folders and Files

On the USB mass storage device, MP3 or WMA files may be organized in a hierarchically, with folders containing files and subfolders, as shown below.

On the CR-525, all folders appear at the same level regardless of the hierarchy.

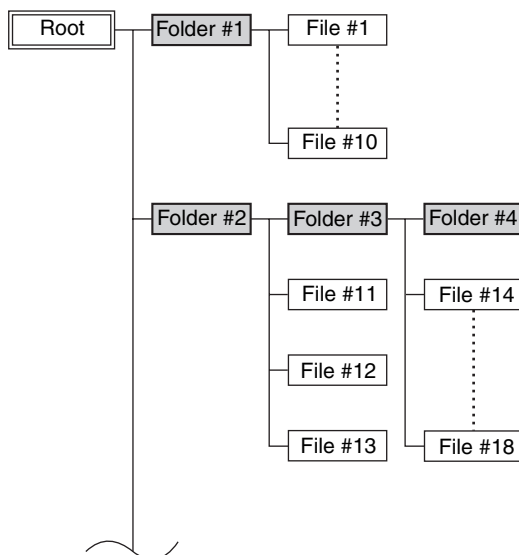

If you don’t select a specific music file or folder for playback, all of the music files on the USB mass storage device will be played in numerical order starting with file #1.

## Playing Music Files on a USB Mass Storage Device

This section explains how to play music files on a USB mass storage device. Connect a USB mass storage device as shown below.

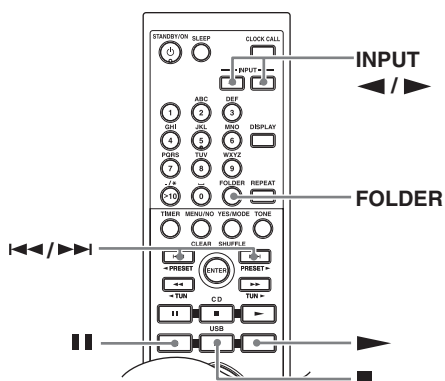
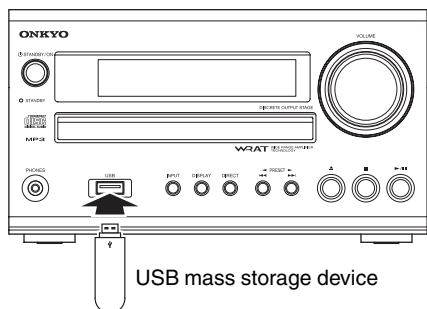

**1**

Remote controller

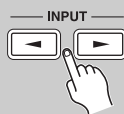

**Use the INPUT [◀]/[▶] buttons to select “USB”.**

- When no USB mass storage device is connected, “No USB” will be displayed.
- When there is no MP3 or WMA file in the USB mass storage device, “No File” will be displayed.

**2**



**To start playback, press the Play [▶] button.**

Playback will begin with the top file in the folder organization (see page 37, File #1).

**To stop playback:**

Press the Stop [■] button.

**To pause playback:**

Press the Pause [⏸] button. The Pause [⏸] indicator appears. To resume playback, press the Pause [⏸] button again.

### Display during Stop

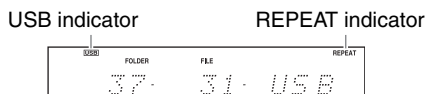

Total number of folders      Total number of files

### Note:

In general, playback of USB mass storage device music files is a repeating playback. When all music files have been played, playback will repeat from the top music file in the folder organization. The type of repeat playback can be selected (see page 39).

### Selecting Music files

To return to the beginning of the music file currently playing, press the Previous [◀◀] button.

Press the Previous [◀◀] button repeatedly to select previous file.

- While playback is stopped, pressing the Previous [◀◀] button will select the previous file.

Press the Next [▶▶] button repeatedly to select next file.

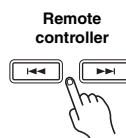

### Selecting Music files in other folders

- 1 Press the [FOLDER] button to display the current folder name.  
The folder name will flash.
- 2 To select the previous folder, press the Previous [◀◀] button.  
To select the next folder, press the Next [▶▶] button.
- 3 Press the [FOLDER] button to display the file name.
- 4 Use the Previous [◀◀] and Next [▶▶] buttons to select a file.

### Notes:

- Do not connect the CD receiver's USB port to a USB port on your computer. Music on your computer cannot be played through the CD receiver in this way.
- Operation with all USB mass storage devices including the ability to power them is not guaranteed.
- Do not connect your USB mass storage device via a USB hub. The USB mass storage device must be connected directly to the CD receiver's USB port.
- If the USB mass storage device contains a lot of data, the CD receiver may take a while to read it.

## Resume Playback

After playback has been stopped, when the Play [▶] button is pressed to begin playback again, it will resume playback from the beginning of the file in which it stopped.

### Canceling Resume Playback

While playback is stopped, press the Stop [■] button. “Resume Clear” will appear on the display.

“Resume” will be cleared even if the following operations are performed:

- another music file is selected;
- the power cord is unplugged;
- the USB mass storage device is unplugged during playback.

## Random Playback

With random playback, all of the music files on the USB mass storage device are played in random order.

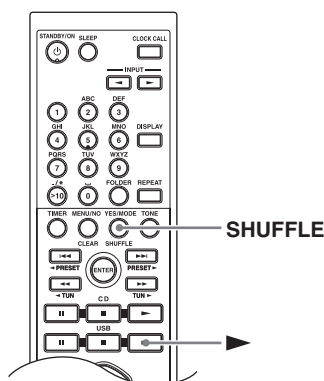

**1**



Press the [SHUFFLE] button. The RANDOM indicator appears.

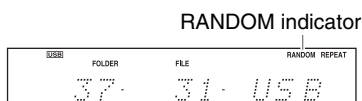

**2**



To start random playback, press the Play [▶] button.

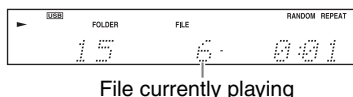

### Canceling Random Playback

- To cancel random playback, press the [SHUFFLE] button. The RANDOM indicator disappears.
- Random playback is cancelled when the USB mass storage device is removed or the CD receiver is set to Standby.

## Select the type of Repeat Playback

When playing back USB mass storage device music files, all files on the USB mass storage device will be played according to repeat playback (the REPEAT indicator is already lit up). The type of Repeat playback can be selected.

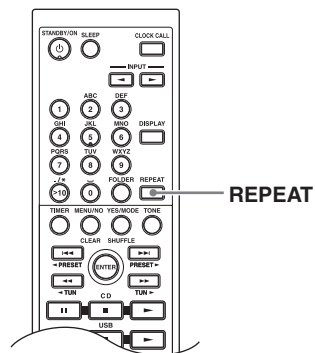

REPEAT



Press the [REPEAT] button repeatedly to select the type of repeat playback.

REPEAT or REPEAT 1 indicator  
1FOLDER indicator

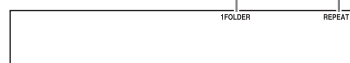

- Repeat playback (default): REPEAT indicator appears
- Repeat-1 playback: Repeats a single selected file. REPEAT 1 indicator appears
- 1-Folder playback: Repeat playback of all files in a selected folder. REPEAT and 1FOLDER indicators appear.

### Note:

Repeat-1 or 1-Folder playback can't be combined with random playback.

## Displaying Music File Information

You can display various information about the MP3 and WMA files currently playing, including ID3 tags such as title, artist name, and album name.

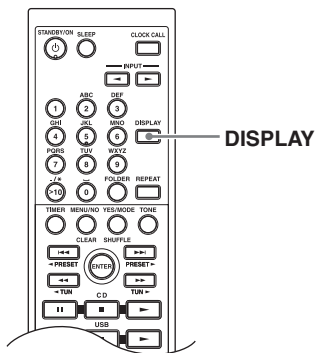



**DISPLAY**

**During playback, press the [DISPLAY] button repeatedly to display the following music file information.**

### Elapsed time:

The length of time that the current MP3 or WMA file has been playing (default display). If the elapsed time is more than 99 minutes and 59 seconds, “--:--” is displayed.

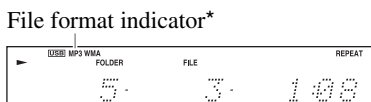

### File name:

Name of the current file.

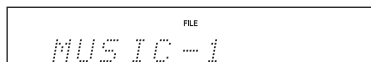

### Folder name:

Name of the current folder.

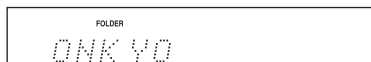

### Title name:

Title of the current file (if ID3 tag present).

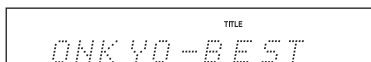

### Artist name:

Name of the artist (if ID3 tag present).

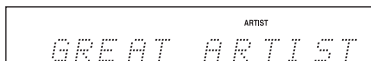

### Album name:

Name of the album (if ID3 tag present).

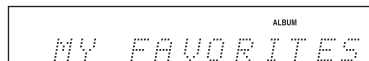

- \* While an MP3 file is playing, “MP3” will appear. While a WMA file is playing, “WMA” will appear.

### Notes:

- You can also use the CD receiver’s [DISPLAY] button to display this information.
- If a file or folder name contains any characters that cannot be displayed, an underscore will be displayed in place of those characters. Alternatively, you can set the CD receiver so that names containing such characters are displayed as “File\_n” or “Folder\_n”, “n” being the file or folder number (See “Bad Name?” on page 35).
- The number at the beginning of file and folder names can be hidden (See “Hide Number?” on page 35).



# Listening to the Radio

## Tuning into Radio Stations

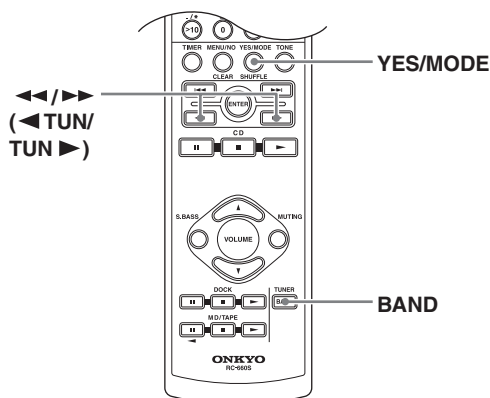

When tuned into a station, the Tuned  $\blacktriangle \bullet \blacktriangleleft$  indicator appears. When tuned into a stereo FM station, the FM ST indicator appears as well.

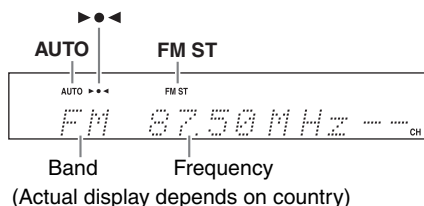

### Tuning into weak stereo FM stations

If the signal from a stereo FM station is weak, it may be impossible to get good reception. In this case, switch to Manual Tuning mode and listen to the station in mono.

1



Press the [BAND] button repeatedly to select "AM" or "FM".

2



Press the [YES/MODE] button repeatedly to select "Auto" or "Manual".

- **Auto Tuning Mode**  
The AUTO indicator appears and stereo radio reception is possible.
- **Manual Tuning Mode**  
The AUTO indicator is not displayed and radio reception will be in mono.

AUTO indicator



3

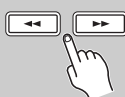

Use the Fast Reverse and Fast Forward [  $\blacktriangleleft$  ]/[  $\blacktriangleright$  ] buttons to tune into a station.

**In Auto tuning mode**, once a station is found, tuning stops automatically.

The North American models changes FM frequency in 0.2 MHz steps, 10 kHz steps for AM. For other models it's 0.05 MHz steps for FM and 9 kHz or 10 kHz steps for AM.

**In Manual Tuning mode**, the frequency stops changing when you release the button. Press the button repeatedly to change the frequency one step at a time.

**Note:**

On the CD receiver, you can also tune into a station by pressing its PRESET [  $\blacktriangleleft$  ]/[  $\blacktriangleright$  ] button for a few seconds.

## Adjusting the Antennas

### Adjusting and installing the FM antenna

Choose a location for the FM antenna while listening to an FM station.

1

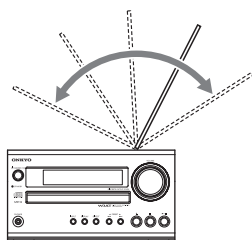

Change the direction of the antenna to achieve the best reception.

2

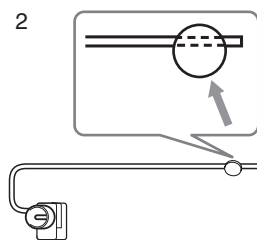

Affix the antenna with a thumbtack. (Do not push the thumbtack *through* the antenna.)

**Caution:**

Be careful not to prick your finger!

### Adjusting the AM antenna

Adjust the location and position of the AM antenna while listening to an AM station to achieve the best reception.

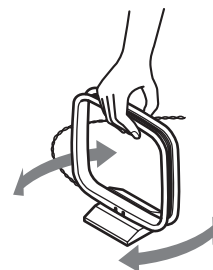

## Presetting FM Stations Automatically (Auto Preset)

With the Auto Preset function, you can automatically preset all of the FM radio stations available in your area in one go. Presets make it easy to select your favorite stations and eliminate the need to tune the radio manually each time you want to change stations. The Auto Preset function does not preset AM radio stations (see page 43).

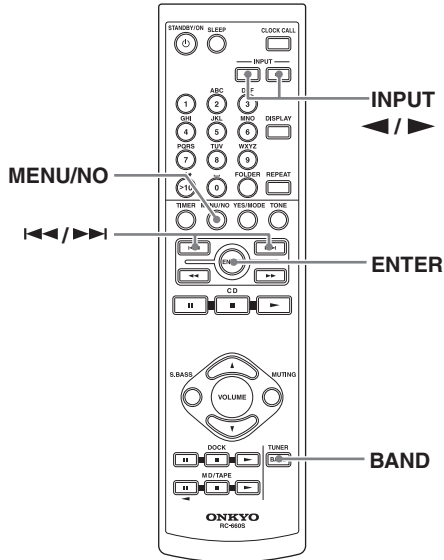

**Auto Preset Caution!**  
Any existing presets will be deleted when the Auto Preset function is run.

**1** Press the [BAND] or INPUT [◀]/[▶] buttons repeatedly until “FM” appears.

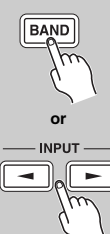

AUTO  
FM

Make sure the FM antenna is positioned to achieve the best possible reception.

**2** Press the [MENU/NO] button, and then use the Previous and Next [◀◀]/[▶▶] buttons to select “AutoPreset?”.

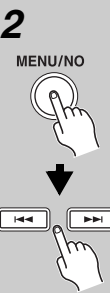

AUTO  
AutoPreset?

**3** Press [ENTER]. The confirmation message “AutoPreset??” appears.



AUTO  
AutoPreset??

To cancel the Auto Preset function at this point, press the [MENU/NO] button.

**4** To start the Auto Preset function, press [ENTER].



AUTO \*\*\* FM ST  
FM 88.00MHz 1 ch

Up to 20 stations can be preset and presets are stored in frequency order.

**Note:**  
Depending on your location, a preset may be stored with no station and you will hear only noise when you select it. In this case, delete the preset (see page 48).

**After Storing Presets You Can:**

- Select them (see page 44)
- Name them for easy identification (see page 46)
- Copy them (see page 47)
- Erase them (see page 48)

## Presetting AM/FM Stations Manually

With the Preset Write function, you can manually preset individual AM and FM radio stations. Presets make it easy to select your favorite stations and eliminate the need to tune the radio manually each time you want to change stations. FM stations can also be preset automatically (see page 42).

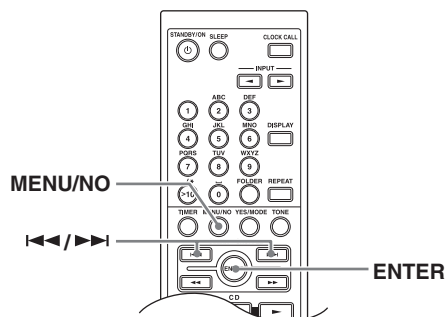

### About Presets

- You can store up to 40 stations as presets and this can be any combination of AM and FM stations. For example, 27 FM and 13 AM or 32 FM and 8 AM.
- Although AM and FM presets share the same numbers, they're selected independently. For example, preset #1 will store an AM station when the AM band is selected, and an FM station when the FM band is selected.
- Stations can be stored to presets in any order. For example, you could store preset #5 first, #1 second, and so on.

|          |   |
|----------|---|
| <b>1</b> | <p><b>Tune into the station that you want to store as a preset.</b></p>   |
| <b>2</b> | <p><b>Press the [MENU/NO] button, and then use the Previous and Next [◀◀]/[▶▶] buttons to select "PresetWrite?".</b></p>  |
| <b>3</b> | <p><b>Press [ENTER].</b></p> <p>The preset number flashes.</p> <p>To cancel the Preset Write function at this point, press the [MENU/NO] button.</p>  |
| <b>4</b> | <p><b>Use the Previous and Next [◀◀]/[▶▶] buttons to select a preset.</b></p>   |
| <b>5</b> | <p><b>To store the station, press [ENTER].</b></p> <p>If no station has yet been stored to the selected preset, "Complete" appears and the station is stored.</p> <p>If a station has already been stored in the selected preset, the message "Overwrite?" appears.</p> |

|          |   |
|----------|---|
| <b>6</b> | <p>To overwrite the previously stored station, press the [YES/MODE] button.</p> <p>To not overwrite the previously stored station, press the [MENU/NO] button.</p> <p>If the message "Memory Full" appears, all 40 presets have been stored and you'll need to erase some presets before you can store any more stations (see page 48).</p> |
| <b>6</b> | <p>Repeat steps 1 to 5 to preset more radio stations.</p>   |

### For European models

If the current FM station supports RDS and PS (Program Service Name), the station's name will be displayed instead of the frequency. (See page 45 for more on RDS.)

### After Storing Presets You Can:

- Select them (see page 44)
- Name them for easy identification (see page 46)
- Copy them (see page 47)
- Erase them (see page 48)

## Selecting Preset Stations

You must store some presets before you can select them (see pages 42 and 43).

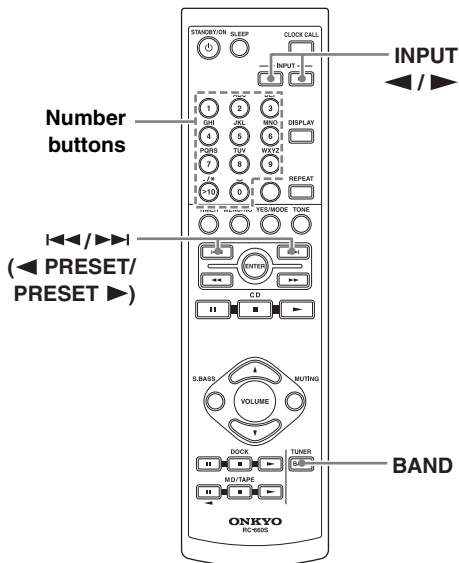

You can also use the number buttons as shown in the examples below to select presets.

| To select: | Press: |
|------------|--------|
| Preset #8  |        |
| Preset #10 |        |
| Preset #22 |        |

Used to enter numbers over 10.

You can also use the front panel controls.

1. Use the [INPUT] button to select “AM” or “FM”.
2. Use the PRESET [ $\leftarrow$ ]/[ $\rightarrow$ ] buttons to select a preset.

**1**

Use the [BAND] or INPUT [ $\leftarrow$ ]/[ $\rightarrow$ ] buttons to select “AM” or “FM”.

The preset you selected the last time you listened to the radio will still be selected.

or

**2**

Use the Previous and Next [ $\leftarrow\leftarrow$ ]/[ $\rightarrow\rightarrow$ ] buttons to select a preset.

Press the Previous [ $\leftarrow\leftarrow$ ] button to select the previous preset. Press the Next [ $\rightarrow\rightarrow$ ] button to select the next preset.

or

## Displaying Radio Information

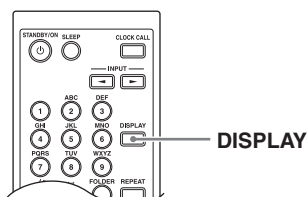

Press the remote controller's [DISPLAY] button repeatedly to display more radio information.

You can also use the CD receiver's [DISPLAY] button to display this information.

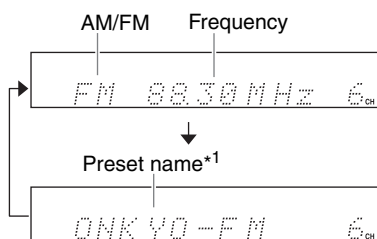

\*1 If the selected preset has no name, "No Name" appears briefly and then the frequency is displayed. See "Naming Presets" on page 46.

## Receiving RDS (European models only)

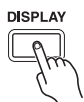

Press the [DISPLAY] button repeatedly to display the following RDS information.

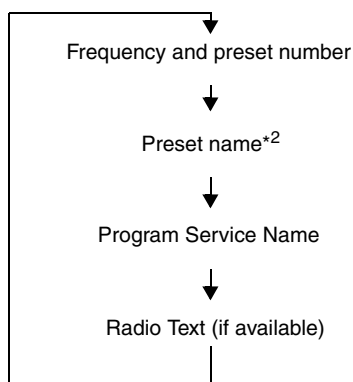

RDS is only available on European models and only in areas where RDS broadcasts are available.

### What is RDS?

RDS stands for *Radio Data System* and is a method of transmitting data in FM radio signals. It was developed within the European Broadcasting Union (EBU) and many European FM radio stations use it these days. The CD receiver supports and displays the Program Service Name (PS) and Radio Text (RT) types of RDS data. The RDS indicator appears on the display when the CD receiver is tuned to an FM station that supports RDS.

### Notes:





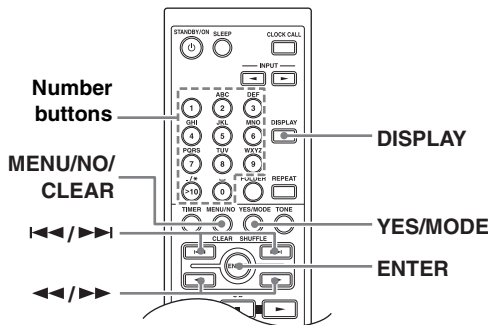

- If the signal from an RDS station is weak, RDS data may be displayed intermittently or not at all.
- The message "Waiting..." may appear while the RT data is being received.

\*2 If the selected preset has no name, it will be skipped and the next Program Service Name will be displayed.

## Naming Presets

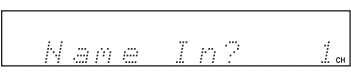
You can name presets for easy identification. The preset name may contain up to eight characters.

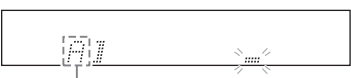

|  |   |
|--|---|
| <b>1</b>   | <b>Select the preset you want to name (see page 44).</b>  |
| <b>2</b><br>MENU/NO<br><br>↓<br> | <b>Press the [MENU/NO] button, and then use the Previous and Next [◀]/[▶] buttons to select “Name In?”.</b><br>  |
| <b>3</b><br>  | <b>Press [ENTER].</b><br>  |
| <b>4</b><br>DISPLAY<br>   | <b>Press the [DISPLAY] button repeatedly to select one of the following character groups:</b> <ul style="list-style-type: none"> <li>• “A” for uppercase letters.</li> <li>• “a” for lowercase letters.</li> <li>• “1” for numbers and symbols.</li> </ul> <br>Character group |



- **Selecting letters:**  
Press the number buttons repeatedly to select the available letters. For example, press the [2] button repeatedly to select: A, B, or C.
- **Selecting numbers and symbols:**  
Use the number buttons to select numbers.  
Press the [>10] button repeatedly to select: ◻ (space) . / \* - , ! ? & ' ( )  
Press the [0] button repeatedly to select: 0 or ◻ (space)

**Note:**  
Not all of the symbols can be entered by using the number buttons. Use the Previous and Next [◀] or [▶] buttons to select from the full range of symbols.  
**When you’ve selected the character you want, press [ENTER], and then choose the next character.**

- **Editing characters:**  
To change or delete a character you’ve already entered, use the Rewind and Fast Forward [◀◀]/[▶▶] buttons to select it, and then select another character, or press the [CLEAR] button to delete it.
- **Inserting a new character:**  
To insert a new character, use the Rewind and Fast Forward [◀◀]/[▶▶] buttons to select the character immediately after the insertion point. That character flashes. Use the Previous and Next [◀] or [▶] buttons to select “#”, press [ENTER], and then select the new character.  
To cancel the Name In function, press and hold the [MENU/NO] button for 2 seconds.



**6**  
**When you’ve finished entering the name, press the [YES/MODE] button.**  
The preset is named and “Complete” appears on the display.

## Available Characters

ABCDEFGHIJKLMNOPQRSTUVWXYZ  
abcdefghijklmnopqrstuvwxyz  
0123456789  
\_ @ ' < > # \$ % & \* = ; : + - / ( ) ?  
! ' " , . ◻ (space) # (insert)

## Copying Presets

With the Preset Copy function, you can organize your presets in the order you want. When you copy a preset, its name is also copied.

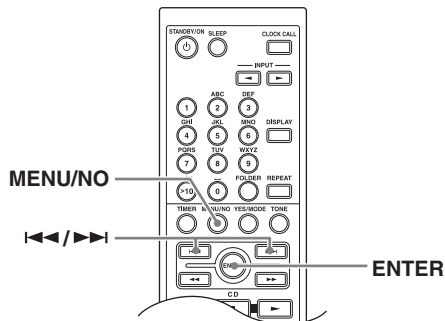

**1** Select the preset you want to copy (see page 44).

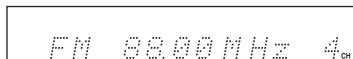

**2** Press the [MENU/NO] button, and then use the Previous and Next [◀◀]/[▶▶] buttons to select "PresetCopy?".

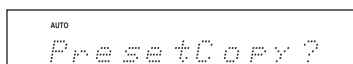
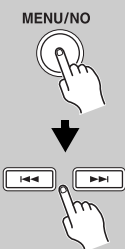

**3** Press [ENTER].

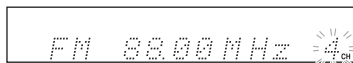

The number of the preset to be copied flashes.

**4** Use the Previous and Next [◀◀]/[▶▶] buttons to select the destination preset.

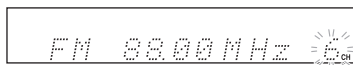
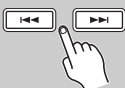

The number of the destination preset flashes.

**5**



To copy the preset, press [ENTER].

If no station has yet been stored in the destination preset, the station is copied and "Complete" appears.

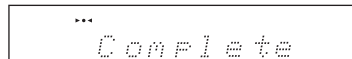

MENU/NO



If a station has already been stored in the destination preset, the message "Overwrite?" appears.

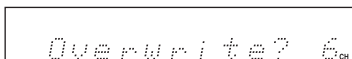

To overwrite the previously stored station, press [ENTER].

To not overwrite the previously stored station, press the [MENU/NO] button.

If the message "Memory Full" appears, all 40 presets have been stored and you'll need to erase some presets before you can store any more stations (see page 48).

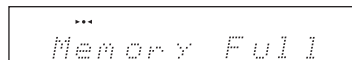

### Tip:



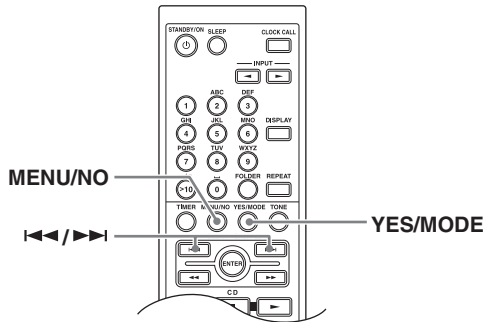

If your favorite station is stored in preset #5 and you want to make it preset #1, copy preset #5 to preset #1. To keep the station that's already stored in preset #1, you may want to copy it to an unused preset first.



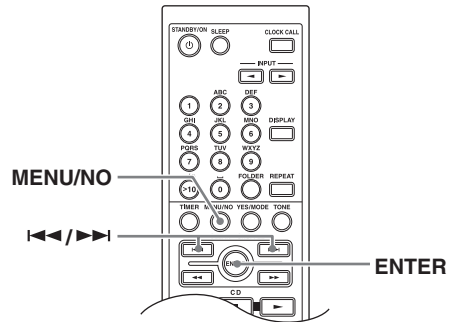



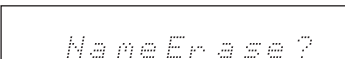

## Erasing a Preset's Name



## Erasing Presets

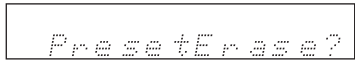

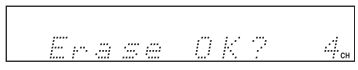
|  |   |
|--|---|
| <b>1</b>   | Select the preset whose name you want to erase (see page 44).   |
| <b>2</b><br>MENU/NO<br><br>↓<br><br> | Press the [MENU/NO] button, and then use the Previous and Next [◀]/[▶] buttons to select "NameErase?".<br><br> |
| <b>3</b><br>YES/MODE<br>  | To erase the preset's name, press the [YES/MODE] button.<br>The preset's name is erased and "Complete" appears on the display.  |





|  |  |
|--|--|
| <b>1</b>   | Select the preset you want to erase (see page 44).<br><br>   |
| <b>2</b><br>MENU/NO<br><br>↓<br><br> | Press the [MENU/NO] button, and then use the Previous and Next [◀]/[▶] buttons to select "PresetErase?".<br><br>  |
| <b>3</b><br>  | Press [ENTER].<br>A message requesting confirmation appears.<br><br><br><br>To cancel the Preset Erase function at this point, press the [MENU/NO] button. |
| <b>4</b><br>  | To erase the preset, press [ENTER].<br>The preset is erased and "Complete" appears on the display.   |



# Setting the Clock

## Setting AccuClock to Use a Specific Station (European models only)

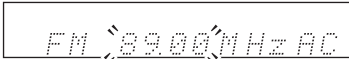
The AccuClock function normally uses the FM station with the strongest signal to set the clock. However, if the clock cannot be set properly using that station, you can specify which FM station the AccuClock function should use. This must be an FM station that supports RDS CT (Clock Time) information.





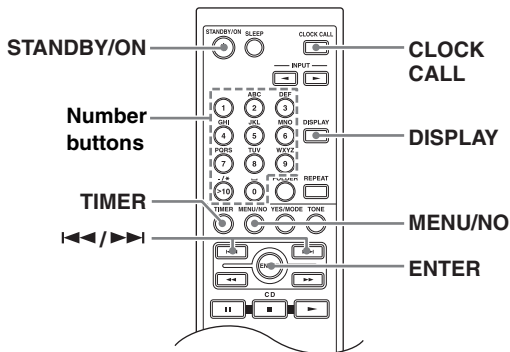

|   |  |
|---|--|
| <b>1</b><br>Remote controller<br>TIMER<br> | <b>Press the [TIMER] button.</b><br>“Clock” appears on the display.<br>If the clock has already been set, a timer option appears instead, in which case you’ll need to press the [TIMER] button repeatedly until “Clock” appears.  |
| <b>2</b><br>                               | <b>Press [ENTER].</b><br>“AccuClock” or “*AccuClock*” appears on the display.<br>If “ManualAdjust” appears, use the Previous and Next [◀◀]/[▶▶] buttons to select “AccuClock” or “*AccuClock*”.  |
| <b>3</b><br>                               | <b>Press [ENTER].</b><br>The frequency flashes on the display.<br>  |
| <b>4</b><br>                             | <b>Use the Rewind and Fast Forward [◀◀]/[▶▶] buttons to tune into the FM station.</b><br><b>Tip:</b><br>If you press the [YES/MODE] button instead of using the Rewind and Fast Forward [◀◀]/[▶▶] buttons, the CD receiver will automatically search for a suitable station.<br>The RDS indicator appears when tuned into a station that supports RDS.<br>The RDS indicator will flash while the CD receiver searches for a station and light up continuously when a station is found. |

|   |  |
|---|--|
| <b>5</b><br> | <b>When you’ve selected the station, press [ENTER].</b><br>While the clock is being set, “Wait” flashes on the display. It may take a few minutes to set the clock. When the clock has been set, the message “Clock Adjusted” scrolls across the display, then the day and time are displayed for a while.<br><b>Notes:</b> <ul style="list-style-type: none"><li>• If the clock is not set correctly, specify another FM station and try again or set the clock manually (see page 50).</li><li>• The AccuClock function automatically updates the clock every day. If you don’t want it to, you can turn off the AccuClock function (see page 24).</li></ul> |
|---|--|

## Setting the Clock Manually

The time can be displayed in either 12- or 24-hour format.



|   |   |
|---|---|
| <b>1</b><br>   | <p><b>Press the [TIMER] button repeatedly until “Clock” appears.</b></p> <div style="border: 1px solid black; padding: 5px; text-align: center;">Clock</div>  |
| <b>2</b><br>  | <p><b>Press [ENTER].</b></p> <div style="border: 1px solid black; padding: 5px; text-align: center;">AccuClock</div>  |
| <b>3</b><br> | <p><b>Use the Previous and Next [◀◀]/[▶▶] buttons to select “Manual-Adjust”.</b></p> <div style="border: 1px solid black; padding: 5px; text-align: center;">ManualAdjust</div>                           |
| <b>4</b><br> | <p><b>Press [ENTER].</b></p> <div style="border: 1px solid black; padding: 5px; text-align: center;">SUN 000</div>  |
| <b>5</b><br> | <p><b>Use the Previous and Next [◀◀]/[▶▶] buttons to select the day of the week.</b><br/>                 You can select: SUN, MON, TUE, WED, THU, FRI, or SAT.</p>                                       |
| <b>6</b><br> | <p><b>Press [ENTER].</b></p> <div style="border: 1px solid black; padding: 5px; text-align: center;">THU 000</div> <p>To cancel the Manual Adjust function at this point, press the [MENU/NO] button.</p> |

**7**

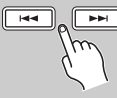

**Use the Previous and Next [◀◀]/[▶▶] buttons to set the time.**  
 You can also use the remote controller’s number buttons to enter the time.

THU 1903

For the 12-hour format, use the remote controller’s [>10] button to select AM or PM.

**8**



**Press [ENTER].**

THU 1903\*

The clock is set and the second dot starts flashing.

### Displaying the Day and Time

To display the day and time, press the remote controller’s [CLOCK CALL] button.  
 If the CD receiver is on Standby, the time is displayed for 8 seconds.

### Using the 12- or 24-hour Format

To change the time format between 12-hour and 24-hour, while the time is shown on the display, press the [DISPLAY] button.

### Displaying the Time in Standby Mode

To set the CD receiver so that the time is displayed while its on Standby, turn on the CD receiver, and then press and hold its [STANDBY/ON] button for 2 seconds.  
 Note that having the time displayed in Standby mode will consume a little more power.

# Using the Timers

The CD receiver has five timers: four programmable timers for automated playback or recording, and a sleep timer for turning the CD receiver off after a specified period. The timers can be used with other Onkyo components that are connected to the CD receiver via **RI** (see pages 21 to 23 for hookup details).

## About the Timers

The various settings for the four programmable timers are explained here. For details on the sleep timer, see page 55.

### Timer Types

Each timer can be programmed for playback (Play) or recording (Rec).

#### ■ Play

Play mode can be used to start playback at a specified time on the CD receiver or another Onkyo component that's connected to the CD receiver with an **RI** cable. You could use a Play timer to turn on the CD receiver every morning, just like a radio alarm.

#### ■ Rec

Rec mode can be used to start playback on one component and start recording on another component at a specified time. The recording component (e.g., Onkyo cassette deck or MD recorder) must be connected to the CD receiver with an **RI** cable. You could use a Rec timer to record your favorite radio show every day.

### Playback and Recording Components

The playback component can be the CD receiver (AM, FM, or CD), an Onkyo component (MD recorder, cassette deck, etc.) that's connected to the CD receiver with an **RI** cable, or a component that's connected to one of the CD receiver's inputs, perhaps one with its own built-in timer. On the CR-525, it is also possible to play MP3 and WMA files from a USB mass storage device that is connected to the USB port of the CR-525.

The recording component can be an Onkyo MD recorder or cassette deck that's connected to the CD receiver with an **RI** cable.

### Repeat Timers

Each timer can be programmed to work just once (Once), every week (Every), every day (Every Day), or on a range of days (Days Set).

#### ■ Once

The timer will work just once.

#### ■ Every

The timer will work every week on the specified day and time.

#### • Everyday

The timer will work every day.

#### • Days Set

The timer will work on the specified range of days. With this setting, you could set up a morning alarm for Monday to Friday.

### Timer Examples

The following examples highlight some of the ways in which you can use the timers.

**Timer 1:** To wake up to your favorite radio station (preset #1) every morning, set as follows:  
Play→FM 1→Every→Every Day→On  
7:00→Off 7:30

If you want a radio alarm only on weekdays, select "Days Set" instead of "Every Day" and specify "MON-FRI".

**Timer 2:** To record a one-off radio show (preset #2) to a cassette deck this Sunday, set as follows:  
Rec→FM 2→TAPE→Once→SUN→On  
21:00→Off 22:00

(You need an **RI**-capable Onkyo cassette recorder or MD recorder to do the recording.)

**Timer 3:** To record an FM radio show to a MiniDisc recorder every day from Monday to Friday, set as follows:  
Rec→FM 1→MD→Every→Days Set→MON→FRI→On 15:00→Off 15:30

### Timer Priority

If two or more timers are set to the same On time, the lowest numbered timer has priority. For example:

**Timer 1:** 07:00 – 13:00 (This timer has priority.)

**Timer 2:** 07:00 – 12:30

If two or more timers overlap, the timer with the earliest start time has priority. For example:

**Timer 1:** 9:00 – 10:00

**Timer 2:** 8:00 – 10:00 (This timer has priority.)

If the On and Off times of two timers are the same, the timer with the earliest start time has priority and the other timer will fail. For example:

**Timer 1:** 0:00 – 1:00 (This timer has priority.)

**Timer 2:** 1:00 – 2:00

### Timer Indicators

When a timer has been set, the **TIMER** indicator and the number of the timer appear on the display. If the timer has been set to perform recording, an underscore character appears underneath the timer's number.



#### Notes:

- The timers work only if the CD receiver is on Standby. If it's on when a timer is supposed to start playback or recording, nothing will happen.
- While timed playback or recording is in progress, the timer's Off time cannot be changed.
- To use timed playback or recording with an external component, make sure it's properly connected to the CD receiver. Also, for **RI** to work properly, make sure that the Input Display on the CD receiver is set to match the type of component you've connected to the MD/TAPE IN (see page 27).

## Programming the Timers

### Notes:

- You must set the clock before you can program the timers.
- Before programming a timer to turn on the radio, you must preset the station you want to use. (See pages 42 and 43.)
- If you don't operate any buttons for 60 seconds while programming a timer, the procedure will be cancelled and the previous display will reappear.

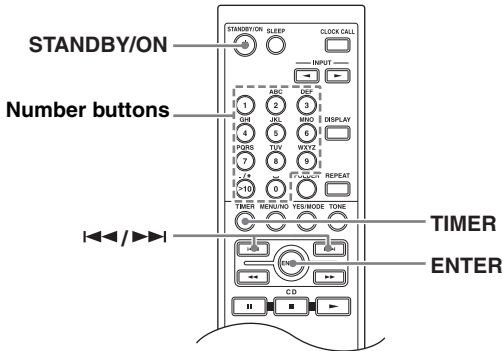

**1**



TIMER





**Press the [TIMER] button repeatedly to select timer 1, 2, 3, or 4, and then press [ENTER].**

Timer 1

If “Clock” appears, you need to set the clock (see pages 24, 49, and 50).

---

**2**

**Use the Previous and Next [Previous/Next] buttons to select “Play” or “Rec”, and then press [ENTER].**



Play

or

Rec

If you can't select “Rec”, make sure that your Onkyo cassette deck or MD recorder is properly connected to the MD/TAPE jacks (see pages 21 and 22) and the Input Display is set accordingly (see page 27).

**3**



**Use the Previous and Next [Previous/Next] buttons to select the source, and then press [ENTER].**

FM

You can select the following sources:  
**CR-525**  
 FM, AM, TAPE, USB, DOCK, or CD.  
**CR-325**  
 FM, AM, TAPE, DOCK, or CD.  
 If you selected “Rec”, only “FM” or “AM” can be selected as the source.

---

**4**





**If you selected “AM” or “FM”, use the Previous and Next [Previous/Next] buttons to select the radio preset, and then press [ENTER].**

FM 87.50MHz

---

**5**





**If you selected “Rec”, make sure the name of the connected recorder is flashing on the display, and then press [ENTER].**

FM TAPE

---

**6**





**Use the Previous and Next [Previous/Next] buttons to select “Once” or “Every”, and then press [ENTER].**

Select “Once” for on-off operation.  
 Select “Every” to perform the same operation every week.

Every

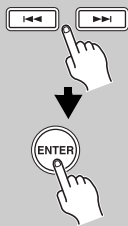
**7**



If you selected “Once”, use the Previous and Next [◀]/[▶] buttons to select the day, and then press [ENTER].

You can select: SUN, MON, TUE, WED, THU, FRI, or SAT.

Go to step 10.

**8**

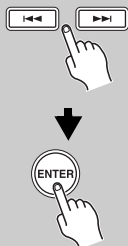

If you selected “Every”, use the Previous and Next [◀]/[▶] buttons to select the day, “Everyday”, or “Days Set”, and then press [ENTER].

You can select the following:

MON ⇄ TUE ⇄ WED ⇄ THU ⇄ FRI  
 ↓ ↓ ↓ ↓ ↓  
 SUN ⇄ Days Set ⇄ Everyday ⇄ SAT

**9**

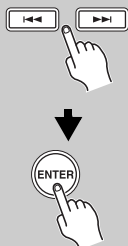

If you selected “Days Set”, use the Previous and Next [◀]/[▶] buttons to select the first day, and then press [ENTER].



Use the Previous and Next [◀]/[▶] buttons again to select the last day, and then press [ENTER].

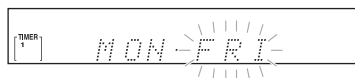

You can select only consecutive days.

**10**

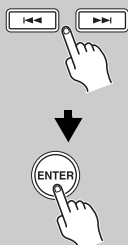

Use the Previous and Next [◀]/[▶] buttons to specify the On time, and then press [ENTER].



You can also use the remote controller’s number buttons to enter the time. For example, to enter 7:29, press [7], [2], and [9].

**Notes:**

- Once the On time is set, the Off time is automatically set to one hour later.
- To ensure that the first few seconds of a program are recorded when using timer recording, set the On time slightly ahead of the program’s start time (about 1 minute).

**11**

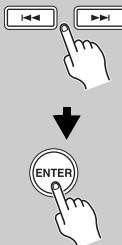

Use the Previous and Next [◀]/[▶] buttons to specify the Off time, and then press [ENTER].

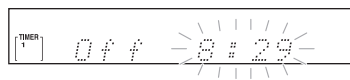

**12**

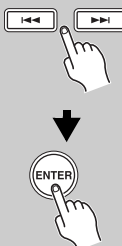

If you selected “Play” in step 2, use the Previous and Next [◀]/[▶] buttons to specify the CD receiver’s volume level, and then press [ENTER].

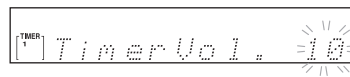

The default setting is 10.

If you want to use your normal volume level setting for the timer, press the Previous [◀] button repeatedly until “TimerVol.Off” appears on the display. In this case, the timer will use the volume level that was set before the CD receiver was set to Standby.

**13**

CD receiver  
 Ⓞ STANDBY/ON



Remote controller  
 STANDBY/ON



Timer indicator 1, 2, 3, or 4 will stop flashing and light up.

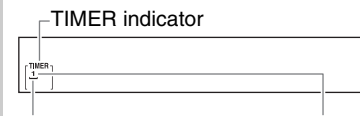

Underscore indicates timer programmed for recording      Number of programmed timer

Press the [STANDBY/ON] button to set the CD receiver to Standby.

**Notes:**

- Be sure to set the CD receiver to Standby, otherwise the timed operation will not work.
- While a timed operation is in progress, you can cancel it by pressing the [TIMER] or [SLEEP] button.
- While timed recording is in progress, the output of the CD receiver is muted. To hear what’s being recorded, press the [MUTING] button. Press it again to mute the CD receiver.
- Memory, random, and 1-Folder playback cannot be used with the timers.

To return to step 1 and start timer programming all over again, press the [MENU/NO] button at any point in this procedure.

## Turning Timers On and Off

Once a timer has been programmed, you can turn it on or off as necessary. For example, while you're on holiday, you may want to turn off the timer you use as an early-morning alarm.

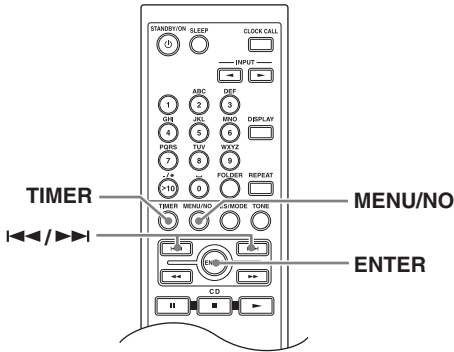

**1**

TIMER



**Press the [TIMER] button repeatedly to select timer 1, 2, 3, or 4.**

[TIMER] Tiner 1

When a timer has been programmed, its number appears on the display.

**2**



**Use the Previous and Next [◀◀]/[▶▶] buttons to select “Timer On” or “Timer Off”.**

[TIMER] Tiner On

or

Tiner Off

After a few moments, the previous display reappears.

## Checking Timer Settings

**1**

TIMER



**Press the [TIMER] button repeatedly to select timer 1, 2, 3, or 4, and then press [ENTER].**

Tiner 1

**2**



**Press [ENTER] repeatedly to see all of the timer's settings.**

Rec

**Notes:**

- You can change the settings by using the Previous and Next [◀◀]/[▶▶] buttons.
- If you change the settings of a timer that is off, that timer will be turned on. If you don't change any settings, the previous display reappears.

To return to the previous display at any point in this procedure, press the [MENU/NO] button.

### Using the Sleep Timer

With the sleep timer, you can set the CD receiver so that it automatically turns off after a specified period.

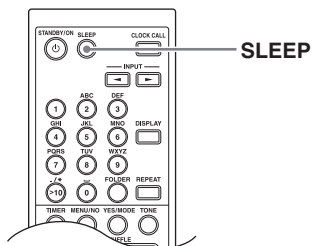

#### SLEEP



**Press the [SLEEP] button repeatedly to select the required sleep time.**

With the [SLEEP] button, you can set the sleep time from 90 to 10 minutes in 10 minute increments.

Use the Previous and Next [**◀◀**]/[**▶▶**] buttons to set the sleep time in 1 minute increments from 99 to 1.

SLEEP indicator

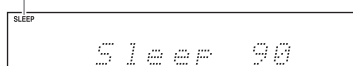

When the sleep timer has been set, the SLEEP indicator appears on the display, as shown. The sleep time appears on the display for about 8 seconds, then the previous display reappears.

#### Note:

The sleep timer will be ignored while dubbing a CD to an Onkyo cassette deck or MD recorder is in progress. The CD receiver will automatically switch to Standby when the dubbing is complete.

### Checking the Remaining Sleep Time

To check the remaining sleep time, press the [SLEEP] button.

Note that if you press the [SLEEP] button while the sleep time is being displayed, you'll shorten the sleep time by 10 minutes.

### Canceling the Sleep Timer

To cancel the sleep timer, press the [SLEEP] button repeatedly until the SLEEP indicator disappears.

# Troubleshooting

If you have any trouble using the CD receiver, look for a solution in this section.

If you can't resolve the issue yourself, try resetting the CD receiver before contacting your Onkyo dealer. Note that resetting the CD receiver will delete your radio presets and custom settings.

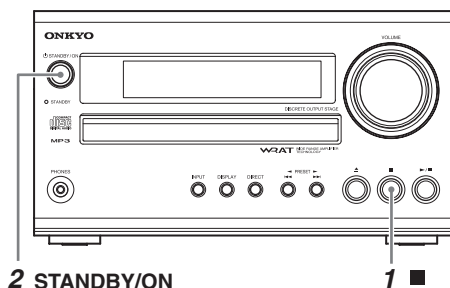

To reset the CD receiver to its factory defaults, turn it on and, while holding down the [■] button, press the [STANDBY/ON] button.

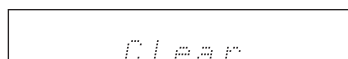
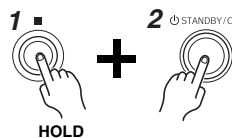

"Clear" will appear on the display and the CD receiver will enter Standby mode.

## Power

### Can't turn on the CD receiver.

- Make sure that the power cord is properly plugged into the wall outlet (see page 23).
- Unplug the power cord from the wall outlet, wait 5 seconds or more, then plug it in again.

### The CD receiver turns off unexpectedly.

- If the sleep timer has been set and the TIMER indicator is shown on the display, the CD receiver will turn off automatically after a specified period.
- When timed playback or recording finishes, the CD receiver automatically switches to Standby mode.
- If the STANDBY indicator is flashing, the built-in amplifier protection circuit has been activated. This can happen if there's a short between the positive and negative wires of a speaker cable.

## Audio

### There's no sound.

- Make sure the CD receiver's volume control is not set to minimum (see page 25).
- Make sure the correct input source is selected (see page 25).
- Make sure the CD receiver is not muted (see page 26).
- Make sure the speakers are connected correctly (see page 19).
- Check all connections and correct as necessary (see pages 17 to 23).
- While headphones are connected, the speakers output no sound (see page 25).

### The sound quality is not good.

- Make sure the speaker cables are connected with the correct polarity (see page 19).
- Make sure all audio connecting plugs are pushed in all the way (see page 20).
- The sound quality can be affected by strong magnetic fields, such as that from a TV. Try moving any such devices away from the CD receiver.
- If you have any devices that emit high-intensity radio waves near the CD receiver, such as a cellular phone that's being used to make a call, the CD receiver may output noise.
- The CD receiver's precision drive mechanism may emit a faint hissing sound while reading discs during playback or when searching for tracks. You may be able to hear this noise in extremely quiet environments.

### Audio output is intermittent when the CD receiver is subjected to vibration.

- The CD receiver is not a portable device. Use it in a location that's not subject to shock or vibration.

### Headphone output is intermittent or there's no sound.

- This may be due to dirty contacts. Clean the headphones plug. See your headphones' instruction manual for cleaning information. Also, make sure that the headphones cable is not broken or damaged.



## Troubleshooting—Continued

---

### Audio performance

---

- Audio performance will be at its best about 10 to 30 minutes after the CD receiver has been turned on and had time to warm up.
- Using cable ties to bundle audio cables with speaker or power cables may degrade the sound quality, so don't do it.

### CD Playback

---

#### Playback jumps.

---

- The CD receiver is being subjected to vibration or the disc is scratched or dirty (see page 16).

#### Can't add tracks to the playlist for memory playback.

---

- Make sure there's a disc in the CD receiver. Also, you can only add valid track numbers. For example, if the CD contains 11 tracks, you cannot add track #12.

#### The disc will not play.

---

- Make sure the disc has been loaded correctly, with the label-side facing up.
- Check to see if the surface of the disc is dirty (see page 16).
- If condensation is suspected, turn on the CD receiver and leave it for 1 hour before playing any discs.
- Some CD-R/RW discs may not be playable (see page 15).

#### It takes a long time for playback to start.

---

- It may take the CD receiver a while to read CDs that contain many tracks or files.

#### Can't play MP3 discs.

---

- Use only ISO 9660 Level 1 or Level 2 format discs (see page 15).
- The disc has not been finalized. Finalize the disc.
- MP3 files without a ".mp3" or ".MP3" filename extension are not recognized.

### Tuner

---

#### Reception is noisy, stereo FM reception suffers from hiss, the Auto Preset function doesn't preset all stations, or the ST indicator doesn't light up when tuned to a stereo FM station.

---

- Check the antenna connections (see page 17).
- Change the position of the antenna (see page 41).
- Move the CD receiver away from a nearby TV or computer.
- Cars or airplanes can cause noisy interference.
- The radio signal will be weakened if it has to pass through a concrete wall before reaching the antenna.
- Try setting FM mode to mono (see page 41).
- Move power cords and speaker cables as far away as possible from the tuner's antenna.
- When listening to an AM station, noise may be heard when you operate the remote controller.
- If none of the above improves the reception, install an outdoor antenna (see page 18).

#### If a power outage occurs or the power cable is disconnected:

---

- If the preset stations are lost, preset them again (see pages 42, 43).
- The clock and timer settings will be lost. Set the clock and timers again (see pages 49, 50).

#### Can't adjust the frequency of the radio.

---

- Use the Fast Reverse and Fast Forward [◀◀]/[▶▶] buttons to change the frequency of the radio (see page 41).

#### RDS doesn't work.

---

- The FM station you are tuned to doesn't support RDS.
- Install an outdoor FM antenna (see page 18).
- Change the position or direction of your outdoor FM antenna (see pages 18, 41).
- Move the FM antenna as far away as possible from fluorescent lights (see page 41).

### Remote Controller

---

#### The remote controller doesn't work properly.

---

- Make sure the batteries have been installed with the correct polarity (+/-) (see page 6).
- Replace both batteries with new ones. (Do not mix different types of batteries or new and old batteries.)
- The remote controller is too far away from the CD receiver, or there's an obstacle between them (see page 6).
- The CD receiver's remote control sensor is being subjected to bright light (inverter-type fluorescent light or sunlight).
- The CD receiver is located behind the glass doors of a audio rack or cabinet.

### USB Mass Storage Device Playback (CR-525 only)

#### Can't access the music files on a USB mass storage device.

- Make sure that the USB indicator light is on. If the light is not on, make sure that it is connected correctly and that the USB mass storage device is one that is supported (see pages 37, 38).
- The CD receiver supports USB mass storage devices that support the USB Mass Storage Class. However, playback may not be possible with some USB mass storage devices even if they conform to the USB Mass Storage Class.
- Check that the memory format is FAT16 or FAT32.
- USB mass storage devices with an internal USB hub are not supported.

#### Can't play MP3 files.

- MP3 files without a “.mp3” or “.MP3” filename extension are not recognized.

#### Can't play WMA files.

- WMA files without a “.wma” or “.WMA” filename extension are not recognized.
- The WMA file's copyright option is on. Don't use the copyright option.

### External Components

#### Interactive control with other Onkyo **RI**-capable components is not working.

- Make sure the **RI** cables and analog audio cables are connected correctly (see pages 21 to 23). Connecting only an **RI** cable won't work.
- Make sure the Input Display matches the type of device that you've connected to the CD receiver (see page 27).

#### No sound is heard from a connected component.

- Make sure the correct input source is selected (see page 25).
- Make sure the analog audio cable is connected correctly (see pages 21 to 23).
- Make sure that all audio connecting plugs are pushed in all the way (see page 20).

#### No sound is heard from your turntable.

- Make sure the turntable has a built-in phono equalizer.
- If the turntable doesn't have a phono equalizer built-in, you must provide one.

### Timers

#### Timer playback or recording doesn't work.

- Make sure the clock has been set correctly (see pages 49, 50).
- Timed operation will fail if the CD receiver is on at the specified On time, so make sure it's set to Standby (see page 53).
- The timer may overlap with another timer. If you program several timers, make sure they don't overlap (see page 51).
- If you press the [SLEEP] or [TIMER] button while a timed operation is in progress, the timer will be cancelled.
- Make sure the **RI** cables and analog audio cables are connected correctly (see pages 21 to 23).
- If you're using an Onkyo component for timed playback or recording, you must set the Input Display to match that component (see page 27).

### Clock

#### The time is not displayed in Standby mode.

- Set the CD receiver so that the time is displayed in Standby mode (see page 50).

Onkyo is not responsible for damages (such as CD rental fees) due to unsuccessful recordings caused by the unit's malfunction. Before you record important data, make sure that the material will be recorded correctly.

The CD receiver contains a microcomputer for signal processing and control functions. In very rare situations, severe interference, noise from an external source, or static electricity may cause it to lockup. In the unlikely event that this should happen, unplug the power cord, wait at least 5 seconds, and then plug it again.

# Specifications

| General                     | CR-525  | CR-325   |
|-----------------------------|---|--|
| Power Supply:               | European: AC 220 - 230 V, 50/60 Hz<br>Others: AC 220 - 230 V, 50/60 Hz<br>AC 120 V, 60 Hz | European: AC 220 - 230 V, 50/60 Hz<br>North American: AC 120 V, 60 Hz<br>Others: AC 220 - 230 V, 50/60 Hz<br>AC 120 V, 60 Hz |
| Power Consumption:          | European: 65 W<br>Others: 65 W<br>68 W  | European: 58 W<br>North American: 62 W<br>Others: 58 W<br>62 W   |
| Stand-by Power Consumption: | 0.25 W  | North American: 0.15 W<br>Others: 0.25 W   |
| Dimensions (W × H × D):     | 205 × 116 × 367 mm<br>(8-1/16" × 4-9/16" × 14-7/16")                                      | 205 × 116 × 367 mm<br>(8-1/16" × 4-9/16" × 14-7/16")   |
| Weight:                     | 4.0 kg (8.8 lbs.)   | 4.0 kg (8.8 lbs.)  |

## Audio Inputs

|                |                         |                         |
|----------------|-------------------------|-------------------------|
| Analog Inputs: | 2 (DOCK IN, MD/TAPE IN) | 2 (DOCK IN, MD/TAPE IN) |
|----------------|-------------------------|-------------------------|

## Audio Outputs

|                        |                 |                 |
|------------------------|-----------------|-----------------|
| Analog Outputs:        | 1 (MD/TAPE OUT) | 1 (MD/TAPE OUT) |
| Subwoofer Pre Outputs: | 1               | 1               |
| Speaker Outputs:       | 2               | 2               |
| Phones:                | 1               | 1               |

## Amplifier Section

|                                  | CR-525  | CR-325  |
|----------------------------------|---|---|
| Power Output:                    | European: 2ch × 20 W (4Ω, 1 kHz,<br>2ch driven, IEC)<br>Asian: 19 W + 19 W (8Ω, 1 kHz,<br>JEITA)<br>26 W + 26 W (4Ω, 1 kHz,<br>JEITA) | North American: 14 W + 14 W (8Ω, 1 kHz, FTC)<br>19 W + 19 W (4Ω, 1 kHz, FTC)<br>European: 2ch × 19 W (4Ω, 1 kHz,<br>2ch driven, IEC)<br>Asian: 19 W + 19 W (8Ω, 1 kHz,<br>JEITA)<br>26 W + 26 W (4Ω, 1 kHz,<br>JEITA) |
| Dynamic Power:                   | 22 W + 22 W (3Ω, Front)<br>20 W + 20 W (4Ω, Front)<br>14 W + 14 W (8Ω, Front)   | 22 W + 22 W (3Ω, Front)<br>20 W + 20 W (4Ω, Front)<br>14 W + 14 W (8Ω, Front)   |
| THD (Total Harmonic Distortion): | 0.4% (1 kHz, 1 W)   | 0.9% (Power Rated) 0.4% (1 kHz, 1 W)  |
| Damping Factor:                  | 25 (Front, 1 kHz, 8 Ω)  | 25 (Front, 1 kHz, 8 Ω)  |
| Input Sensitivity and Impedance: | 150 mV/50 kΩ (DOCK IN, MD/TAPE IN)  | 150 mV/50 kΩ (DOCK IN, MD/TAPE IN)  |
| Output Level and Impedance:      | 150 mV/2.2 Ω (MD/TAPE OUT)  | 150 mV/2.2 Ω (MD/TAPE OUT)  |
| Frequency Response:              | 10 Hz–100 kHz/±3 dB (DOCK, MD/TAPE)   | 10 Hz–100 kHz/±3 dB (DOCK, MD/TAPE)   |
| Tone Control:                    | ±6 dB, 80 Hz (BASS)<br>±8 dB, 10 kHz (TREBLE)<br>+7 dB, 80 Hz (S.BASS)  | ±6 dB, 80 Hz (BASS)<br>±8 dB, 10 kHz (TREBLE)<br>+7 dB, 80 Hz (S.BASS)  |
| Signal to Noise Ratio:           | 100 dB (DOCK, MD/TAPE, IHF-A)   | 100 dB (DOCK, MD/TAPE, IHF-A)   |
| Speaker Impedance:               | 4 Ω–16 Ω  | 4 Ω–16 Ω  |

## Tuner Section

|                         | CR-525             | CR-325   |
|-------------------------|--------------------|--|
| <b>FM</b>               |                    |  |
| Tuning Frequency Range: | 87.5 MHz–108.0 MHz | North American: 87.5 MHz–107.9 MHz<br>Others: 87.5 MHz–108.0 MHz |
| <b>AM</b>               |                    |  |
| Tuning Frequency Range: | 522 kHz–1611 kHz   | North American: 530 kHz–1710 kHz<br>Others: 522 kHz–1611 kHz     |

## CD

|                                  | CR-525                           | CR-325                           |
|----------------------------------|----------------------------------|----------------------------------|
| Frequency Response:              | 4 Hz–20 kHz                      | 10 Hz–20 kHz                     |
| Audio Dynamic Range:             | 96 dB                            | 95 dB                            |
| THD (Total Harmonic Distortion): | 0.005%                           | 0.009%                           |
| Wow and Flutter:                 | Below threshold of measurability | Below threshold of measurability |

Specifications and features are subject to change without notice.

## **ONKYO CORPORATION**

Sales & Product Planning Div. : 2-1, Nisshin-cho, Neyagawa-shi, OSAKA 572-8540, JAPAN  
Tel: 072-831-8023 Fax: 072-831-8163

### **ONKYO U.S.A. CORPORATION**

18 Park Way, Upper Saddle River, N.J. 07458, U.S.A.  
Tel: 201-785-2600 Fax: 201-785-2650 <http://www.us.onkyo.com/>

### **ONKYO EUROPE ELECTRONICS GmbH**

Liegnitzerstrasse 6, 82194 Groebenzell, GERMANY  
Tel: +49-8142-4401-0 Fax: +49-8142-4401-555 <http://www.eu.onkyo.com/>

### **ONKYO EUROPE UK Office**

Suite 1, Gregories Court, Gregories Road, Beaconsfield, Buckinghamshire, HP9 1HQ  
UNITED KINGDOM Tel: +44-(0)1494-681515 Fax: +44(0)-1494-680452

### **ONKYO CHINA LIMITED**

Unit 1&12, 9/F, Ever Gain Plaza Tower 1, 88, Container Port Road, Kwai Chung,  
N.T., HONG KONG Tel: 852-2429-3118 Fax: 852-2428-9039  
<http://www.ch.onkyo.com/>



Y0802-1

SN 29344705

(C) Copyright 2008 ONKYO CORPORATION Japan. All rights reserved.



Download from [www.Somanuals.com](http://www.Somanuals.com). All Manuals Search And Download. \* 2 9 3 4 4 7 0 5 \*

## Free Manuals Download Website

<http://myh66.com>

<http://usermanuals.us>

<http://www.somanuals.com>

<http://www.4manuals.cc>

<http://www.manual-lib.com>

<http://www.404manual.com>

<http://www.luxmanual.com>

<http://aubethermostatmanual.com>

Golf course search by state

<http://golfingnear.com>

Email search by domain

<http://emailbydomain.com>

Auto manuals search

<http://auto.somanuals.com>

TV manuals search

<http://tv.somanuals.com>