

ONKYO®

DVD receiver

DR-815

Instruction Manual

Thank you for purchasing the Onkyo DR-815 DVD receiver. Read this manual carefully before using your new DVD receiver. A good understanding of its features and operation will allow you to achieve optimum performance and enjoyment.

Keep this manual for future reference.

Contents

Getting Started 2

Connections 16

Operations 25

Playing a Disc..... 29

Listening to the Radio 42

Enjoying Surround Sound 52

Adjusting Sound 56

Setting Clock and Timer 58

Detailed Settings and Informations (DVD) 67

Miscellaneous 76



WARNING:

TO REDUCE THE RISK OF FIRE OR ELECTRIC SHOCK, DO NOT EXPOSE THIS APPARATUS TO RAIN OR MOISTURE.

CAUTION:

TO REDUCE THE RISK OF ELECTRIC SHOCK, DO NOT REMOVE COVER (OR BACK). NO USER-SERVICEABLE PARTS INSIDE. REFER SERVICING TO QUALIFIED SERVICE PERSONNEL.



WARNING
RISK OF ELECTRIC SHOCK
DO NOT OPEN

AVIS
RISQUE DE CHOC ELECTRIQUE
NE PAS OUVRIR



The lightning flash with arrowhead symbol, within an equilateral triangle, is intended to alert the user to the presence of uninsulated "dangerous voltage" within the product's enclosure that may be of sufficient magnitude to constitute a risk of electric shock to persons.



The exclamation point within an equilateral triangle is intended to alert the user to the presence of important operating and maintenance (servicing) instructions in the literature accompanying the appliance.

Important Safety Instructions

1. Read these instructions.
2. Keep these instructions.
3. Heed all warnings.
4. Follow all instructions.
5. Do not use this apparatus near water.
6. Clean only with dry cloth.
7. Do not block any ventilation openings. Install in accordance with the manufacturer's instructions.
8. Do not install near any heat sources such as radiators, heat registers, stoves, or other apparatus (including amplifiers) that produce heat.
9. Do not defeat the safety purpose of the polarized or grounding-type plug. A polarized plug has two blades with one wider than the other. A grounding type plug has two blades and a third grounding prong. The wide blade or the third prong are provided for your safety. If the provided plug does not fit into your outlet, consult an electrician for replacement of the obsolete outlet.
10. Protect the power cord from being walked on or pinched particularly at plugs, convenience receptacles, and the point where they exit from the apparatus.
11. Only use attachments/accessories specified by the manufacturer.
12. Use only with the cart, stand, tripod, bracket, or table specified by the manufacturer, or sold with the apparatus. When a cart is used, use caution when moving the cart/apparatus combination to avoid injury from tip-over.

PORTABLE CART WARNING



S3125A
13. Unplug this apparatus during lightning storms or when unused for long periods of time.
14. Refer all servicing to qualified service personnel. Servicing is required when the apparatus has been damaged in any way, such as power-supply cord or plug is damaged, liquid has been spilled or objects have fallen into the apparatus, the apparatus has been exposed to rain or moisture, does not operate normally, or has been dropped.
15. Damage Requiring Service

Unplug the apparatus from the wall outlet and refer servicing to qualified service personnel under the following conditions:

 - A. When the power-supply cord or plug is damaged,
 - B. If liquid has been spilled, or objects have fallen into the apparatus,
 - C. If the apparatus has been exposed to rain or water,
 - D. If the apparatus does not operate normally by following the operating instructions. Adjust only those controls that are covered by the operating instructions as an improper adjustment of other controls may result in damage and will often require extensive work by a qualified technician to restore the apparatus to its normal operation,
 - E. If the apparatus has been dropped or damaged in any way, and
 - F. When the apparatus exhibits a distinct change in performance this indicates a need for service.
16. Object and Liquid Entry

Never push objects of any kind into the apparatus through openings as they may touch dangerous voltage points or short-out parts that could result in a fire or electric shock.

The apparatus shall not be exposed to dripping or splashing and no objects filled with liquids, such as vases shall be placed on the apparatus.

Don't put candles or other burning objects on top of this unit.
17. Batteries

Always consider the environmental issues and follow local regulations when disposing of batteries.
18. If you install the apparatus in a built-in installation, such as a bookcase or rack, ensure that there is adequate ventilation.

Leave 20 cm (8") of free space at the top and sides and 10 cm (4") at the rear. The rear edge of the shelf or board above the apparatus shall be set 10 cm (4") away from the rear panel or wall, creating a flue-like gap for warm air to escape.

Precautions

1. **Recording Copyright**—Unless it's for personal use only, recording copyrighted material is illegal without the permission of the copyright holder.
2. **AC Fuse**—The AC fuse inside the unit is not user-serviceable. If you cannot turn on the unit, contact your Onkyo dealer.
3. **Care**—Occasionally you should dust the unit all over with a soft cloth. For stubborn stains, use a soft cloth dampened with a weak solution of mild detergent and water. Dry the unit immediately afterwards with a clean cloth. Don't use abrasive cloths, thinners, alcohol, or other chemical solvents, because they may damage the finish or remove the panel lettering.

4. Power

WARNING

BEFORE PLUGGING IN THE UNIT FOR THE FIRST TIME, READ THE FOLLOWING SECTION CAREFULLY.

AC outlet voltages vary from country to country. Make sure that the voltage in your area meets the voltage requirements printed on the unit's rear panel (e.g., AC 230 V, 50 Hz or AC 120 V, 60 Hz).

The power cord plug is used to disconnect this unit from the AC power source. Make sure that the plug is readily operable (easily accessible) at all times.

Pressing the [STANDBY/ON] button to select Standby mode does not fully shutdown the unit. If you do not intend to use the unit for an extended period, remove the power cord from the AC outlet.

5. **Never Touch this Unit with Wet Hands**—Never handle this unit or its power cord while your hands are wet or damp. If water or any other liquid gets inside this unit, have it checked by your Onkyo dealer.
6. **Handling Notes**
 - If you need to transport this unit, use the original packaging to pack it how it was when you originally bought it.
 - Do not leave rubber or plastic items on this unit for a long time, because they may leave marks on the case.
 - This unit's top and rear panels may get warm after prolonged use. This is normal.
 - If you do not use this unit for a long time, it may not work properly the next time you turn it on, so be sure to use it occasionally.
 - When you've finished using this unit, remove all discs and turn off the power.
7. **Installing this Unit**
 - Install this unit in a well-ventilated location.
 - Ensure that there's adequate ventilation all around this unit, especially if it's installed in an audio rack. If the ventilation is inadequate, the unit may overheat, leading to malfunction.

- Do not expose this unit to direct sunlight or heat sources, because its internal temperature may rise, shortening the life of the optical pickup.
- Avoid damp and dusty places, and places subject to vibrations from loudspeakers. Never put the unit on top of, or directly above a loudspeaker.
- Install this unit horizontally. Never use it on its side or on a sloping surface, because it may cause a malfunction.
- If you install this unit near a TV, radio, or VCR, the picture and sound quality may be affected. If this occurs, move this unit away from the TV, radio, or VCR.

8. **To Obtain a Clear Picture**—This unit is a high-tech, precision device. If the lens on the optical pickup, or the disc drive mechanism becomes dirty or worn, the picture quality may be affected. To maintain the best picture quality, we recommend regular inspection and maintenance (cleaning or worn part replacement) every 1,000 hours of use depending on the operating environment. Contact your Onkyo dealer for details.

9. Moisture Condensation



Moisture condensation may damage this unit.

Read the following carefully:

Moisture may condense on the lens of the optical pickup, one of the most important parts inside this unit.

- Moisture condensation can occur in the following situations:
 - The unit is moved from a cold place to a warm place.
 - A heater is turned on, or cold air from an air conditioner is hitting the unit.
 - In the summer, when this unit is moved from an air conditioned room to a hot and humid place.
 - The unit is used in a humid place.
- Do not use this unit when there's the possibility of moisture condensation occurring. Doing so may damage your discs and certain parts inside this unit.

If condensation does occur, remove all discs and leave this unit turned on for two to three hours. By this time, the unit will have warmed up and any condensation will have evaporated.

10. **Region Numbers**—The DVD standard uses region numbers to control how discs can be played around the world, the world being divided into six regions. This unit will only play DVD discs that match its region number, which can be found on its rear panel (e.g., , ).

Precautions—Continued

11. About this Manual—This manual explains how to use all of this unit's functions. Although the DVD standard offers many special features, not all discs use them all, so depending on the disc being played, this unit may not respond to certain functions. See the disc's sleeve notes for supported features.

For British models

Replacement and mounting of an AC plug on the power supply cord of this unit should be performed only by qualified service personnel.

IMPORTANT

The wires in the mains lead are coloured in accordance with the following code:

Blue: Neutral
Brown: Live

As the colours of the wires in the mains lead of this apparatus may not correspond with the coloured markings identifying the terminals in your plug, proceed as follows:

The wire which is coloured blue must be connected to the terminal which is marked with the letter N or coloured black.

The wire which is coloured brown must be connected to the terminal which is marked with the letter L or coloured red.

IMPORTANT

The plug is fitted with an appropriate fuse. If the fuse needs to be replaced, the replacement fuse must be approved by ASTA or BSI to BS1362 and have the same ampere rating as that indicated on the plug. Check for the ASTA mark or the BSI mark on the body of the fuse.

If the power cord's plug is not suitable for your socket outlets, cut it off and fit a suitable plug. Fit a suitable fuse in the plug.

This unit contains a semiconductor laser system and is classified as a "CLASS 1 LASER PRODUCT". So, to use this model properly, read this Instruction Manual carefully. In case of any trouble, please contact the store where you purchased the unit.

To prevent being exposed to the laser beam, do not try to open the enclosure.

CAUTION:

CLASS 1M VISIBLE AND INVISIBLE LASER RADIATION WHEN OPEN. DO NOT VIEW DIRECTLY WITH OPTICAL INSTRUMENTS.

THIS PRODUCT UTILIZES A LASER. USE OF CONTROLS OR ADJUSTMENTS OR PERFORMANCE OF PROCEDURES OTHER THAN THOSE SPECIFIED HEREIN MAY RESULT IN HAZARDOUS RADIATION EXPOSURE.

The label on the right is applied on the rear panel.



1. This unit is a CLASS 1 LASER PRODUCT and employs a laser inside the cabinet.
2. To prevent the laser from being exposed, do not remove the cover. Refer servicing to qualified personnel.

For European Models

Declaration of Conformity

We, ONKYO EUROPE ELECTRONICS GmbH
LIEGNITZERSTRASSE 6,
82194 GROEBENZELL,
GERMANY



declare in own responsibility, that the ONKYO product described in this instruction manual is in compliance with the corresponding technical standards such as EN60065, EN55013, EN55020 and EN61000-3-2, -3-3.

GROEBENZELL, GERMANY 
K. MIYAGI

ONKYO EUROPE ELECTRONICS GmbH

Features

Receiver

- Built-in Dolby Pro Logic II, Dolby Digital and DTS
- On board Theater Dimensional Circuit
- Deep bass adjustable S. Bass feature
- Subwoofer or power amplifier connectable PRE-OUT terminals allowing 5.1ch playback with add on speakers
- WRAT (Wide Range Amplifier Technology) exploiting the broadband potential of next generation media
- VLSC (Vector Linear Shaping Circuitry) on the front left and right channels
- Up to 30 stations memory storable tuner with FM auto preset feature
- Program timer capable of multi settings for both playback and recording

DVD

- Dolby^{*1} Digital and DTS^{*2}
- DVD-Video / Video CD / Audio CD playback
- CD-R, CD-RW (Video CD, audio CD, MP3/WMA^{*3}/JPEG)
- DVD-Audio and SACD compatible
- DVD-R (DVD-Video)
- DVD-RW (DVD-Video, VR format)

Others

- Full-function remote controller

Supplied Accessories

Make sure you have the following accessories:

RC-640S

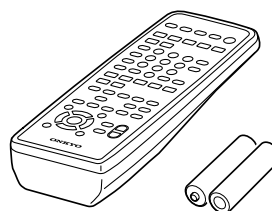

Remote controller & two batteries (AA/R6)

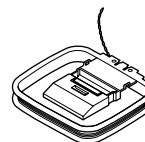

AM loop antenna x 1



Indoor FM antenna x 1

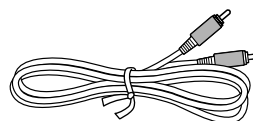

Video cable x 1

* In catalogs and on packaging, the letter at the end of the product name indicates the color. Specifications and operations are the same regardless of color.

*1. Manufactured under license from Dolby Laboratories. "Dolby", "Pro Logic" and the double-D symbol are trademarks of Dolby Laboratories.

*2. "DTS", "DTS 96/24" and "DTS Digital Out" are trademarks of DTS, Inc.

*3. Windows Media, and the Windows logo are trademarks, or registered trademarks of Microsoft Corporation in the United States and/or other countries.



4. Theater-Dimensional is a trademark of Onkyo Corporation.

Table of Contents

Getting Started

Important Safety Instructions.....	2
Precautions	3
Features	5
Supplied Accessories	5
Disc Notes	8
Remote Controller	10
Installing the Batteries	10
Using the Remote Controller	10
Part Names and Functions.....	11
Front Panel	11
Display	12
Rear Panel.....	13
Remote Controller	14

Connections

Connecting Antenna	16
Connecting Speakers	18
Connecting Speakers	18
Speaker Connection Precautions	18
AV Cables and Connectors	19
Before Making Any Connections	19
AV Cables & Connectors.....	19
Connecting Your TV	20
Connecting External Devices	21
Connecting an Onkyo Stereo Cassette Tape Deck	21
Connecting an RI Dock (Remote Interactive Dock)	21
Connection for TV Audio Signal	22
Connecting a Subwoofer	22
Connection for Enjoying 5.1ch Playback.....	23
Enjoying Home Theater	24

Operations

Connecting the Power Cord	25
First Time Setup	25
Turning Off ACCUCLOCK	25
Understanding Common Operations	26
Turning the Unit On and Off	26
Adjusting the Volume.....	26
Selecting a Source	27
Muting the Sound	27
Controlling Display Brightness.....	27
Listening through the Headphones.....	27
Customizing the Source Names	28

Playing a Disc

Before Starting DVD Playback.....	29
Using the On-screen Displays	29
Setting Up the Player for Your TV.....	29
Setting the Language of This Player's On-screen Displays	30
Playing Discs	31
Resume and Last Memory	31
Basic Playback Controls	32
DVD Disc Menus.....	32
Video CD PBC menus	33
Scanning Discs	33
Playing in Slow Motion.....	34
Frame Advance/Frame Reverse	34
Switching Audio Language/Channel	35
Switching Subtitles.....	35
Switching Camera Angles.....	35
Zooming the Screen.....	35
Browsing Video Content with the Disc Navigator...	36
Browsing WMA, MP3 and JPEG files with the Disc Navigator	37
Creating a Program List	38
Searching a Disc.....	39
Using Random Play	39
Looping a Section of a Disc	40
Using Repeat Play	40
Viewing a JPEG Slideshow.....	41
Displaying Disc Information	41

Listening to the Radio

Listening to the Radio	42
Manually Tuning a FM/AM Broadcast Station.....	42
Adjusting the Antenna.....	43
Programming FM Stations Automatically – Auto Preset	44
Programming FM/AM Stations One by One – Preset Write.....	45
Selecting Preset Stations.....	46
Switching the Display Information.....	47
Receiving RDS.....	47
Changing the Preset Channels	48
Tips for Changing the Preset Channels	48
Copying a Preset Channel – Preset Copy	48
Erasing a Preset Channel – Preset Erase	49
Naming Preset Channels.....	50
Naming a Preset Channel	50
Entering a Name	50
Correcting and Erasing a Character	50
Inserting a Character	51
Erasing the Name Assigned to a Preset Channel	51
Inputting Characters from the Remote Controller...	51

Table of Contents—Continued

Enjoying Surround Sound

Enjoying Surround Sound	52
Configuring Subwoofer and Setting Up the Number of Speakers	52
Setting Distance of Speakers	53
Speaker Level Calibration	53
Enjoying Listening Modes	54
Selecting Listening Mode	55

Adjusting Sound

Adjusting Sound	56
Adjusting Individual Speaker Levels	56
Emphasizing the Low End Using the Remote Controller	56
Using the Late Night Function (Dolby Digital only)	56
Audio Adjust Function	57

Setting Clock and Timer

Setting the Clock	58
Setting ACCUCLOCK to Use a Specific Station	58
Setting the Clock Manually	59
Checking the Time and the Day of the Week	60
To Switch between the 12-hour and 24-hour Displays	60
Turning the Current Time Display On or Off while the Unit is in Standby Mode	60
Using the Timer Functions	61
About the Once and Every Timers	61
Using the Sleep Timer	62
Programming a Once / Every Timer	63
Switching the Timer On and Off	66
Viewing the Timer Settings	66

Detailed Settings and Informations (DVD)

DVD Audio Settings and Video Adjust menus	67
Video Adjust menu	67
Initial Settings menu	68
Using the Initial Settings menu	68
How to Use Parental Lock	71
Additional information	73
Screen sizes and disc formats	73
Setting the TV system	73
Resetting the DVD player	74
Titles, chapters and tracks	74
DVD-Video regions	74
Selecting languages using the language code list	74

Miscellaneous

Input Source Names and Available Buttons on Remote Controller	76
Recording	78
Troubleshooting	79
Specifications	82

Disc Notes

Supported Discs

The DVD receiver supports the following discs.

Disc	Logo	Format or file type
DVD-Video		See page 74 for region information.
DVD-Audio		DVD-Audio
SACD		Super Audio CD (single layer, dual layer, hybrid)
DVD-R		DVD-Video
DVD-RW		DVD-Video, VR format
Video CD		Including PBC
Audio CD		PCM and DTS
CD-R		Video CD, audio CD, MP3, WMA, JPEG
CD-RW		Video CD, audio CD, MP3, WMA, JPEG

- Some audio CDs feature copy protection that doesn't conform to the official CD standard. Since these are nonstandard discs, they may not play properly in the DVD receiver.
- The DVD receiver supports CD-R and CD-RW discs recorded in Video CD format, audio CD format, or ISO 9660 Level 1 or 2 format with MP3, WMA, and JPEG files. It also supports DVD-R and DVD-RW discs recorded in DVD-Video format. However, some CD-R, CD-RW, DVD-R, and DVD-RW discs may not work properly for any of the following reasons: incomplete disc finalization, disc burner characteristics, disc characteristics, the disc is damaged or dirty. See the manual supplied with your disc burner for more information. Condensation or dirt on the optical pickup lens can also affect playback.
- The DVD receiver supports 8 cm and 12 cm discs.
- The DVD receiver does not support disc types not listed. If you load any disc for playback other than listed above, the DVD receiver may cause noise or may not operate properly.

- Don't use discs with an unusual shape, such as those shown below, because you may damage the DVD receiver.



- Don't use discs that have residue from adhesive tape, rental discs with peeling labels, or discs with custom-made labels or stickers. Doing so may damage the DVD receiver and you may not be able to remove the disc properly.

Discs Made on Personal Computers

Discs made on personal computers, including those of a compatible format, may not work properly in the DVD receiver because of incorrect settings in the disc burning software. Check the manuals supplied with your disc burning software for additional compatibility information.

CD-R/RW compatibility

- Compatible formats: CD-Audio, Video CD, ISO 9660 CD-ROM* containing MP3, WMA or JPEG files
* ISO 9660 Level 1 or 2 compliant. CD physical format: Mode1, Mode2 XA Form1. Romeo and Joliet file systems are both compatible with this player.
- Multi-session playback: No
- Unfinalized disc playback: No

DVD-R/RW compatibility

- Compatible formats: DVD-Video, Video Recording (VR)*
* Edit points may not play exactly as edited; screen may go momentarily blank at edited points.
- Unfinalized playback: No
- WMA/MP3/JPEG file playback on DVD-R/RW: No

Compressed audio compatibility

- Compatible formats: MPEG-1 Audio Layer 3 (MP3), Windows Media Audio (WMA)
- Sampling rates: 32, 44.1 or 48kHz
- Bit-rates: Any (128Kbps or higher recommended)
- VBR (variable bit rate) MP3 playback: No
- VBR WMA playback: No
- WMA lossless encoding compatible: No
- DRM (Digital Rights Management) compatible: Yes (DRM-protected audio files will not play in this player.)
- File extensions: .mp3, .wma (these must be used for the player to recognize MP3 and WMA files – do not use for other file types)
- File structure: Up to 299 folders; up to 648 folders and files combined

About WMA

WMA is an acronym for Windows Media Audio and refers to an audio compression technology developed by Microsoft Corporation. WMA content can be encoded by using Windows Media® Player version 7, 7.1, Windows Media® Player for Windows® XP, or Windows Media® Player 9 Series.

JPEG file compatibility

- Compatible formats: Baseline JPEG and EXIF 2.2* still image files up to a resolution of 3072 x 2048.
* File format used by digital still cameras
- Progressive JPEG compatible: No
- File extensions: .jpg (must be used for the player to recognize JPEG files – do not use for other file types)
- File structure: Up to 299 folders; up to 648 folders and files combined

Copyright

It is forbidden by law to copy, broadcast, show, broadcast on cable, play in public, or rent copyrighted material without permission.

DVD-Video discs are copy-protected, and any recordings made from these discs will be distorted.

This product incorporates copyright protection technology that is protected by U.S. patents and other intellectual property rights. Use of this copyright protection technology must be authorized by Macrovision Corporation, and is intended for home and other limited consumer uses only unless otherwise authorized by Macrovision. Reverse engineering or disassembly is prohibited.

Handling Discs

- Never touch the underside of a disc. Always hold discs by the edge, as shown.

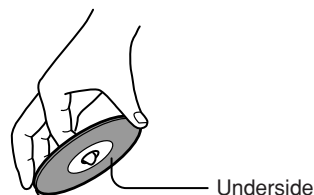

- Never attach adhesive tape or sticky labels to discs.



Cleaning Discs

- For best results, keep your discs clean. Fingerprints and dust can affect the sound and picture quality and should be removed as follows. Using a clean soft cloth, wipe from the center outwards, as shown. Never wipe in a circular direction.



- To remove stubborn dust or dirt, wipe the disc with a damp soft cloth, and then dry it with a dry cloth.
- Never use solvent-based cleaning fluids, such as thinner or benzine, commercially available cleaners, or antistatic sprays intended for vinyl records, because they may damage the disc.

Storing Discs

- Don't store discs in places subject to direct sunlight, or near heat sources.
- Don't store discs in places subject to moisture or dust, such as in a bathroom or near a humidifier.
- Always store discs in their cases and vertically. Stacking, or putting objects on unprotected discs may cause warping, scratches, or other damage.

Remote Controller

Installing the Batteries

- 1 To open the battery compartment, press the small hollow and slide off the cover.**

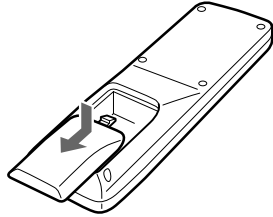

- 2 Insert the two supplied batteries (AA/R6) in accordance with the polarity diagram inside the battery compartment.**

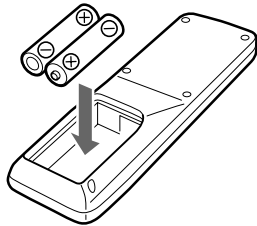

- 3 Put the cover onto the remote controller and slide it shut.**

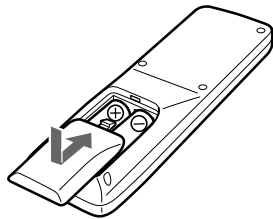

Notes:

- If the remote controller doesn't work reliably, try replacing the batteries.
- Don't mix new and old batteries or different types of batteries.
- If you intend not to use the remote controller for a long time, remove the batteries to prevent damage from leakage or corrosion.
- Expired batteries should be removed as soon as possible to prevent damage from leakage or corrosion.

Using the Remote Controller

To use the remote controller, point it at the DVD receiver's remote control sensor, as shown below.

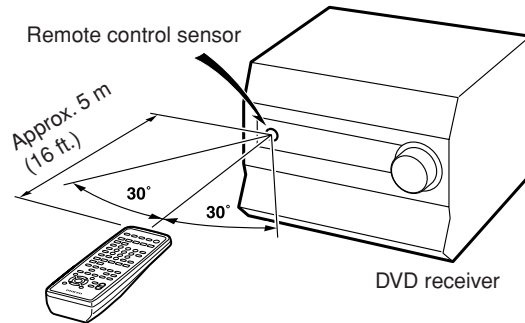

Notes:

- The remote controller may not work reliably if the DVD receiver is subjected to bright light, such as direct sunlight or inverter-type fluorescent lights. Keep this in mind when installing.
- If another remote controller of the same type is used in the same room, or the DVD receiver is installed close to equipment that uses infrared rays, the remote controller may not work reliably.
- Don't put anything, such as a book, on the remote controller, because the buttons may be pressed inadvertently, thereby draining the batteries.
- The remote controller may not work reliably if the DVD receiver is installed in a rack behind colored glass doors. Keep this in mind when installing.
- The remote controller will not work if there's an obstacle between it and the DVD receiver's remote control sensor.

Part Names and Functions

Front Panel

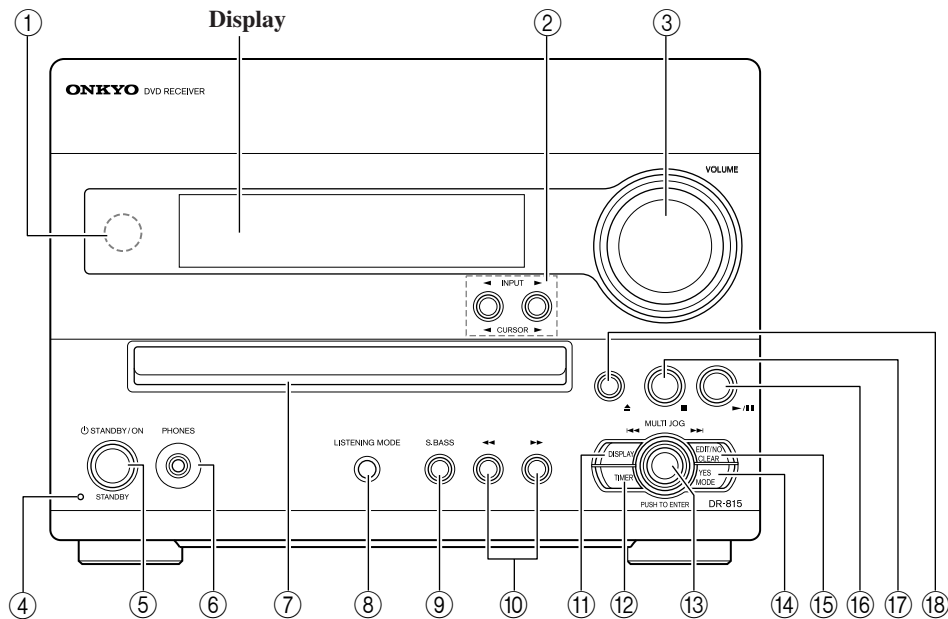



The page numbers in parentheses show where you can find the main explanation for each item.

- ① **Remote control sensor (10)**
Receives signals from the remote controller.
- ② **INPUT/CURSOR buttons (27, 28, 44, 46, 78)**
Enable you to select an input source. These buttons also move the cursor when you input characters.
- ③ **VOLUME control (26)**
Adjusts the volume level.
- ④ **STANDBY indicator (25)**
Lights up in Standby mode.
- ⑤ **STANDBY/ON button (31, 60, 65)**
Press this button to turn on the power to the unit or place the unit in Standby mode.
- ⑥ **PHONES jack (27)**
Connect a headphone mini plug here.
- ⑦ **DVD disc tray (31)**
Place a DVD in the disc tray.
- ⑧ **LISTENING MODE button (55)**
Use this button to select the listening modes.
- ⑨ **S.BASS button (56)**
Use this button to adjust the low end bass range.
- ⑩ **◀◀/▶▶ buttons (32)**
Fast-forward or reverse the track being played. These buttons also move the cursor when you input characters.
- ⑪ **DISPLAY button (41, 47, 50)**
Each time you press this button, the information on the display changes. This button also enables you to select the input character type.
- ⑫ **TIMER button (59, 62, 63, 66)**
Press this button to enable the timer function or set current time.
- ⑬ **MULTI JOG dial (28, 32, 33, 44, 46)**
Turn the dial to select a programmed station, playback track or groups. It also assists you to choose an edit type, and to select characters when you enter characters. Press it to confirm the current setting.
- ⑭ **YES/MODE button (42, 45, 50)**
Press this button to confirm the displayed settings for playback and other editing operations.
- ⑮ **EDIT/NO/CLEAR button (28, 44-45, 48-50)**
Enables you to adjust settings for playback and select editing operations. It also cancels the displayed setting.
- ⑯ **DVD ▶/|| button (32)**
Starts DVD playback. When you press this button during playback, the unit enters Pause mode.
- ⑰ **DVD ■ button (32)**
Stops DVD playback.
- ⑱ **DVD ▲ button (31)**
Ejects a loaded DVD.

Part Names and Functions—Continued

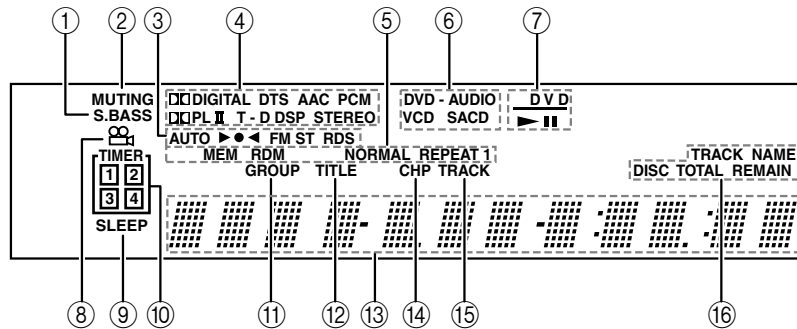
Display



- ① **S.BASS indicator**
This indicator lights up when the super bass is selected.
- ② **MUTING indicator**
This indicator flashes while the DVD receiver is muted.
- ③ **Tuning indicators**
AUTO: This indicator lights up when the Auto Tuning mode is selected, and disappears when the Manual Tuning mode is selected.
▶●◀: This indicator lights up when the DVD receiver is tuned into a radio station.
FM ST: This indicator lights up when the DVD receiver is tuned to a stereo FM station.
RDS: This indicator lights up when the DVD receiver is tuned to a radio station that supports RDS (Radio Data System).
- ④ **Listening mode & format indicators**
These indicators show the currently selected listening mode and the format of the playing disc.
- ⑤ **Playback mode indicators**
MEM: Lights up when memory playback is selected.
RDM: Lights up when random playback is selected.
NORMAL: Lights up when normal playback is selected.
REPEAT: Lights up when repeat playback is selected for all the tracks.
REPEAT 1: Lights up when repeat playback is selected for a track.
- ⑥ **Disc type indicators**
These indicators show the type of disc loaded.
- ⑦ **DVD operation indicators**
These indicators show the status of DVD playback.
- ⑧ **Camera angle  indicator**
This indicator appears if the DVD-Video disc being played features multiple camera angles.
- ⑨ **SLEEP indicator**
This indicator lights up when the Sleep function has been set.
- ⑩ **TIMER indicators**
These indicators show the status of the timers.
: Lights up when timed recording has been set.
Numbers 1-4: Lights up when a timer has been set.
- ⑪ **GROUP indicators**
This indicator lights up when the Group number is displayed.
- ⑫ **TITLE indicator**
During playback, the number of the current title is displayed.
- ⑬ **Message area**
Various information is displayed here, including preset number, tuning frequency, time, volume level, sleep time, mode settings, and so on.
- ⑭ **CHP indicator**
This indicator appears while the number of the current chapter is being displayed.
- ⑮ **TRACK indicators**
This indicator lights up when the track number is displayed.
- ⑯ **DVD information indicators**
The item lights up, which corresponds to the information in the message area.

Rear Panel

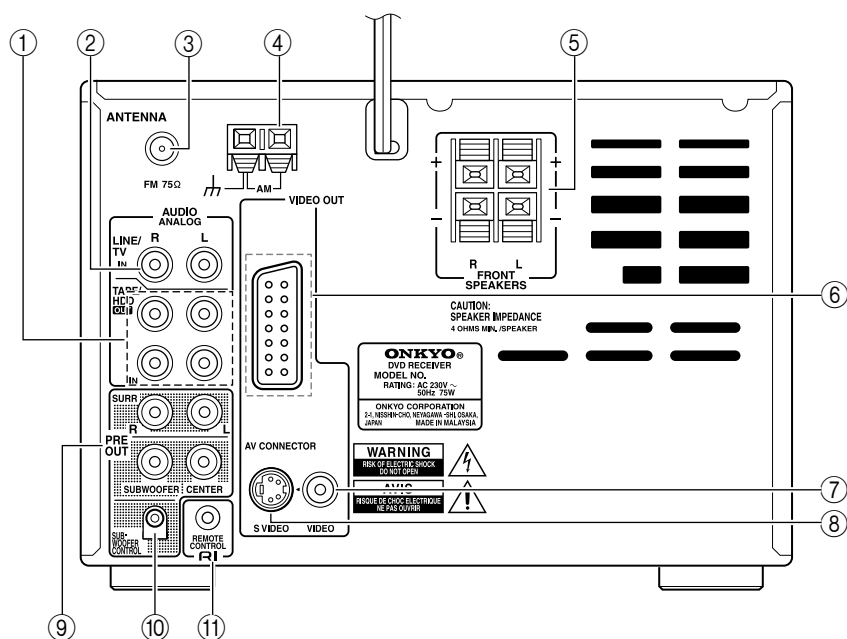

The page numbers in parentheses show where you can find the main explanation for each item.

- ① **TAPE/HDD IN/OUT (21)**
This analog audio input and output are for connecting a recorder with an analog audio input and output (cassette, Mini Disc, etc.). If you want to connect Onkyo RI Dock, connect the RI Dock output with the TAPE/HDD IN terminal.
- ② **LINE/TV IN (22)**
These terminals are for connecting audio output of external devices such as TV, DVD or turntable with a built-in phono equalizer.
- ③ **FM ANTENNA (16, 17)**
This jack is for connecting an FM antenna.
- ④ **AM ANTENNA (16,17)**
These push terminals are for connecting an AM antenna.
- ⑤ **FRONT SPEAKERS (18)**
These terminals are for connecting speakers.
- ⑥ **AV CONNECTOR (20)**
This SCART output can be connected to a TV or projector with a SCART input. This SCART connector outputs composite video, S Video, and RGB video.
- ⑦ **VIDEO OUT VIDEO (20)**
This RCA connector can be used to connect a TV or projector with a composite video input.
- ⑧ **VIDEO OUT S VIDEO OUT (20)**
This connector can be used to connect a TV or projector with an S Video input.
- ⑨ **PRE OUT (22, 23)**
These terminals are for connecting a power amplifier.
- ⑩ **SUBWOOFER CONTROL**
This terminal is provided for future use with Onkyo subwoofer equipped with SUBWOOFER CONTROL terminals.
No product is available as of July 2006.
- ⑪ **RI REMOTE CONTROL (21)**
This **RI** (Remote Interactive) jack can be connected to an **RI** jack on another Onkyo AV component. The DVD receiver's remote controller can then be used to control that component. To use **RI**, you must make an analog audio connection (RCA) between the DVD receiver and the other AV component.

See pages 16-23 for connection information.

Part Names and Functions—Continued

Remote Controller

This section describes the role of the individual buttons you use to control the amplifier and the tuner.

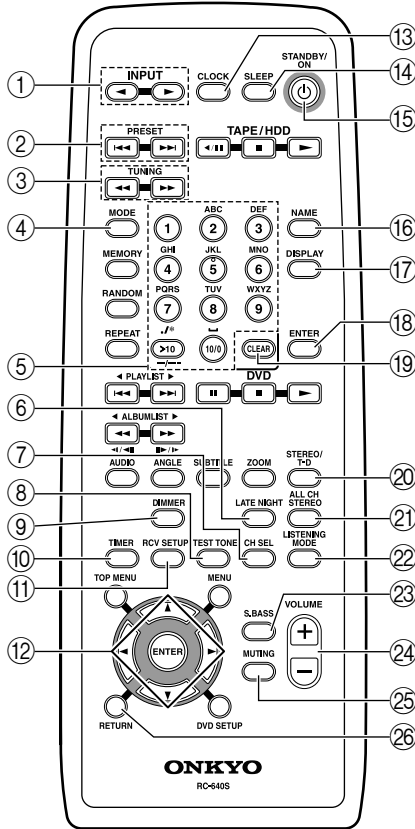

The page numbers in parentheses show where you can find the main explanation for each item.

- ① **INPUT buttons (27, 42, 44, 46, 78)**
Each time you press these buttons, the input source switches.
- ② **PRESET \lll/\ggg buttons (46)**
These buttons select programmed stations.
- ③ **TUNING \lll/\ggg buttons (42)**
These buttons tune in a broadcast station or move the cursor when you input characters.
- ④ **MODE button (42)**
This button is used to select the Auto or Manual tuning mode.
- ⑤ **Number buttons (46, 51)**
Used to name a preset station.
- ⑥ **LATE NIGHT button (56)**
Switches the dynamic range for playback at minimum volume.
- ⑦ **CH SEL button (56)**
Selects the speakers.
- ⑧ **TEST TONE button (53)**
Outputs the test tone.
- ⑨ **DIMMER button (27)**
Adjusts the display brightness.

\rightarrow normal \rightarrow dim \rightarrow dimmer \rightarrow
- ⑩ **TIMER button (59, 63, 66)**
Press this button to enable the timer function or set current time.
- ⑪ **RCV SETUP button (52, 57)**
Press this button to configure settings for the DVD receiver.
- ⑫ **$\blacktriangle/\blacktriangledown/\lll/\ggg$ /ENTER buttons (52, 53)**
These buttons are used to select and adjust settings.
- ⑬ **CLOCK button (60)**
Press this button to display the current time.
- ⑭ **SLEEP button (62)**
Used to program the Sleep timer, which turns off the power to the unit at a specified time.
- ⑮ **STANDBY/ON button (26, 65)**
Switches between power standby and on.
- ⑯ **NAME button (51)**
Used to input characters when you give a name to each FM/AM preset channel.
- ⑰ **DISPLAY button (47, 51, 53, 60)**
Each time you press this button, the information on the display changes. It also selects the character input type.
- ⑱ **ENTER button (51)**
Press this button to confirm the current setting.
- ⑲ **CLEAR button (50)**
Cancels the settings, and erases a character.
- ⑳ **STEREO/T-D button (55)**
Switches over between Stereo Sound and Theater Dimensional Surround.
- ㉑ **ALL CH STEREO button (55)**
This button is used to select the All Ch Stereo listening mode. It is operable when center/surround speakers are connected.
- ㉒ **LISTENING MODE button (55)**
Selects the listening mode.
- ㉓ **S.BASS button (56)**
Adjusts the low end bass range.
- ㉔ **VOLUME +/- buttons (26)**
Adjust the volume level.
- ㉕ **MUTING button (27)**
Lowers the volume level temporarily.
- ㉖ **RETURN button (52, 53)**
This button is used to return to the previously selected menu.

Remote Controller

This section describes the role of the individual buttons you use to control DVD and CD.

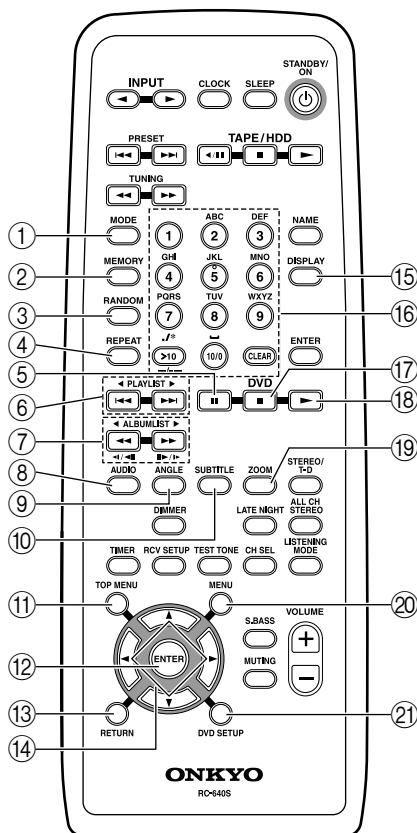

The page numbers in parentheses show where you can find the main explanation for each item.

- ① **MODE button (38, 39, 40)**
Switches the play mode while DVD is loaded.
- ② **MEMORY button (38)**
This button is used with the memory playback function, which allows you to create a custom playlist of titles, chapters, or tracks.
- ③ **RANDOM button (39)**
This button is used with the random playback function.
- ④ **REPEAT button (40)**
Repeats playback or RI Dock playback.
- ⑤ **Pause ■■ button (32, 34, 41)**
This button is used to pause playback.
- ⑥ **Previous/Next ◀◀/▶▶ buttons (32, 33, 41)**
The Previous button is used to select the previous chapter or track. During playback it selects the beginning of the current chapter or track.
The Next button is used to select the next chapter or track.

- ⑦ **◀◀/▶▶ buttons (32, 33, 34)**
Fast-forward or reverse being played.
- ⑧ **AUDIO button (35)**
This button is used to select foreign language soundtracks and audio formats (e.g., Dolby Digital or DTS) on DVD-Video discs.
For Video CDs you can select left-channel, right-channel, or stereo.
- ⑨ **ANGLE button (35)**
This button is used to select camera angles on DVD-Video discs.
- ⑩ **SUBTITLE button (35)**
This button is used to select subtitles on DVD-Video discs.
- ⑪ **TOP MENU button (32)**
This button is used to display the top menu on a DVD-Video disc.
- ⑫ **ENTER button (29, 32, 68, 71, 72)**
This button is used to start playback of the selected title, chapter, or track, and to confirm settings.
- ⑬ **RETURN button (29, 32, 33)**
This button is used to return to the main menu without saving your changes.
- ⑭ **Arrow [▲]/[▼]/[◀]/[▶] buttons (29, 32, 41, 68, 74)**
These buttons are used to select items on the onscreen setup menus.
- ⑮ **DISPLAY button (41)**
Each time you press this button, the information on the display changes.
- ⑯ **Number buttons and CLEAR button (32, 38, 71, 72)**
You can select a track or sort tracks for Memory playback by using the number buttons. You can cancel the setting by pressing the CLEAR.
- ⑰ **Stop ■ button (32)**
This button is used to stop playback.
- ⑱ **Play ▶ button (31-34)**
This button is used to start playback.
- ⑲ **ZOOM button (35, 41)**
This button is used with the Zoom function.
- ⑳ **MENU button (32, 41)**
This button is used to display the menu on a DVD-Video disc or to open the Disc Navigator when using a Video CD, audio CD, WMA/MP3/JPEG disc, or VR format DVD-RW disc.
- ㉑ **DVD SETUP button (29, 36, 37, 67, 68)**
This button is used to access the DVD player's onscreen setup menus.

Connecting Antenna—Continued

Connecting an Outdoor FM Antenna

If you cannot achieve good reception with the supplied indoor FM antenna, try a commercially available outdoor FM antenna instead.

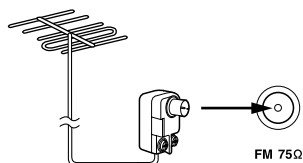

Notes:

- Outdoor FM antennas work best outside, but usable results can sometimes be obtained when installed in an attic or loft.
- For best results, install the outdoor FM antenna well away from tall buildings, preferably with a clear line of sight to your local FM transmitter.
- Outdoor antenna should be located away from possible noise sources, such as neon signs, busy roads, etc.
- For safety reasons, outdoor antenna should be situated well away from power lines and other high-voltage equipment.
- Outdoor antenna must be grounded in accordance with local regulations to prevent electrical shock hazards.

■ Using a TV/FM Antenna Splitter

It's best not to use the same antenna for both FM and TV reception, as this can cause interference problems. If circumstances demand it, use a TV/FM antenna splitter, as shown.

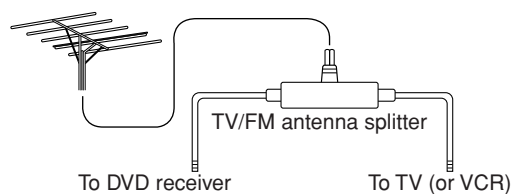

Connecting an Outdoor AM Antenna

If good reception cannot be achieved using the supplied AM loop antenna, an outdoor AM antenna can be used in addition to the loop antenna, as shown.

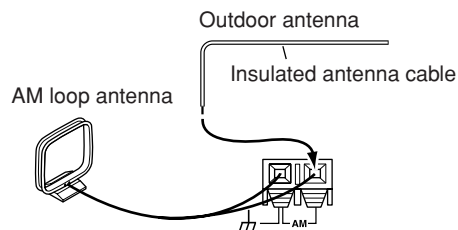

Outdoor AM antennas work best when installed outside horizontally, but good results can sometimes be obtained indoors by mounting horizontally above a window. Note that the AM loop antenna should be left connected. Outdoor antenna must be grounded in accordance with local regulations to prevent electrical shock hazards.

Connecting Speakers

Connecting Speakers

- Connect the right speaker to the DVD receiver's right (R) SPEAKERS terminals. Connect the left speaker to the DVD receiver's left (L) SPEAKERS terminal.
- Connect the positive (+) terminal on each speaker to the corresponding positive (+) terminal on the DVD receiver. Connect the negative (-) terminal on each speaker to the corresponding negative (-) terminal on the DVD receiver. Use the red wires to connect the positive (+) terminal.

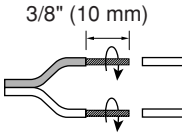
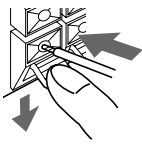
- 1** Strip 3/8" (10 mm) of insulation from the ends of the speaker cables, and twist the bare wires tightly, as shown.

- 2** While pressing the lever, insert the wire into the hole, and then release the lever. Make sure that the terminals are gripping the bare wires, not the insulation.

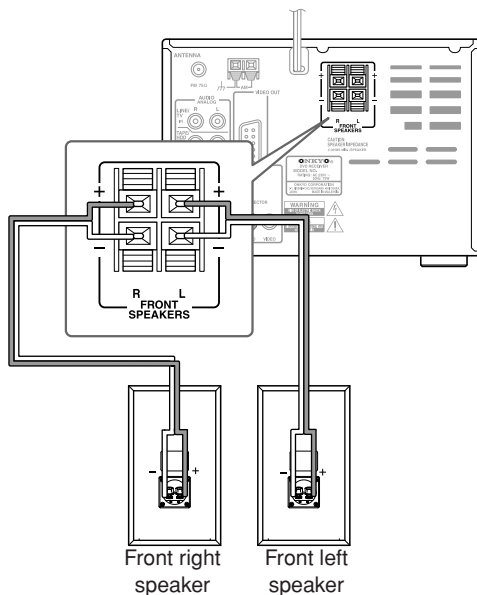
The following illustration shows which speaker should be connected to each pair of terminals.

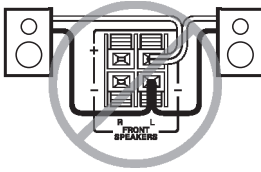
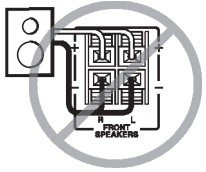

Speaker Connection Precautions

Read the following before connecting your speakers:

- You can connect speakers with an impedance of **4 ohms or higher**. If you use speakers with a lower impedance, and use the amplifier at high volume levels for a long period of time, the built-in protection circuit may be activated.
- Disconnect the power cord from the wall outlet before making any connections.
- Read the instructions supplied with your speakers.
- Pay close attention to speaker wiring polarity. In other words, connect positive (+) terminals to only positive (+) terminals, and negative (-) terminals to only negative (-) terminals. If you get them the wrong way around, the sound will be out of phase and will sound unnatural.
- Unnecessarily long, or very thin speaker cables may affect the sound quality and should be avoided.
- Be careful not to short the positive and negative wires. Doing so may damage the AV receiver.

- Don't connect more than one cable to each speaker terminal. Doing so may damage the AV receiver.

- Don't connect one speaker to several terminals.

AV Cables and Connectors

Before Making Any Connections

- Read the manuals supplied with your AV components.
- Don't connect the power cord until you've completed all audio and video connections.
- ⚠ Do not place objects on the unit as they may interfere with proper ventilation.

RCA AV Connection Color Coding

RCA AV connections are usually color coded: red, white, and yellow. Use red plugs to connect right-channel audio inputs and outputs (typically labeled "R"). Use white plugs to connect left-channel audio inputs and outputs (typically labeled "L"). And use yellow plugs to connect composite video inputs and outputs.

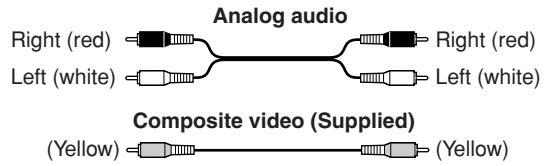

- Push each plug in all the way to make a good connection (loose connections can cause noise or malfunctions).
- To prevent interference, keep audio and video cables away from power cords and speaker cables.

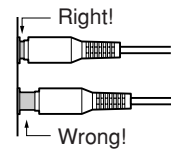

AV Cables & Connectors

Video			
S Video			S Video provides better picture quality than composite video.
Composite video			Composite video can be found on virtually all TVs, VCRs, and video equipment.
Scart			SCART connections carry video (composite, S Video, RGB) all in one cable.
Audio			
Analog			RCA analog audio connectors can be found on virtually all AV components.

Connecting Your TV

Connect the DVD receiver to the TV directly. If you connect the DVD receiver to a VCR, TV/VCR combination, or video selector, the playback picture may be distorted as DVD videos are copy protected.

Using Video

Use the supplied video cable (RCA) and connect the VIDEO OUT to the VIDEO input on your TV.

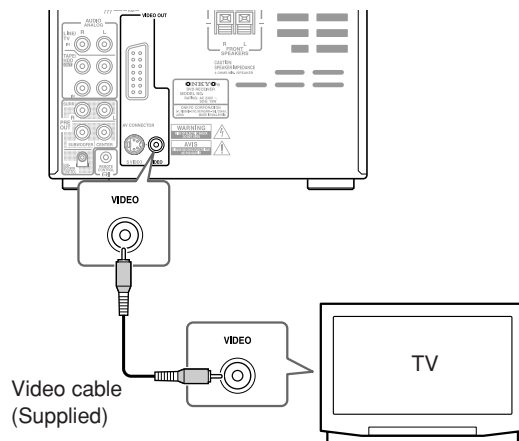

Using S Video

If your TV (or other equipment) has an S Video input, you can use this instead of the standard (composite) output for a better quality picture.

- Use an S Video cable (not supplied) to connect the S VIDEO OUTPUT to an S Video input on your TV (or monitor or AV receiver).

Line up the small triangle above the jack with the same mark on the plug before plugging in.

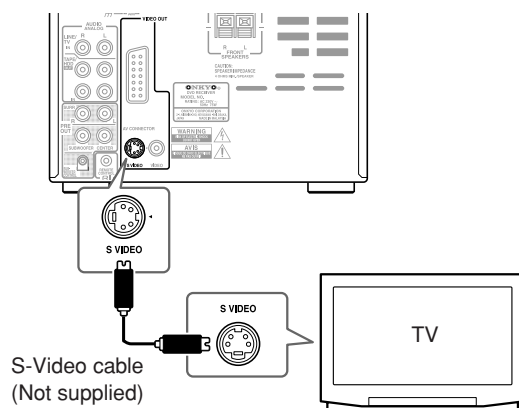

Using SCART

If your TV has a SCART-type AV input, you can use a SCART cable to connect the DVD receiver to your TV.

- Use a SCART cable (not supplied) to connect the AVCONNECTOR to an AV input on your TV.

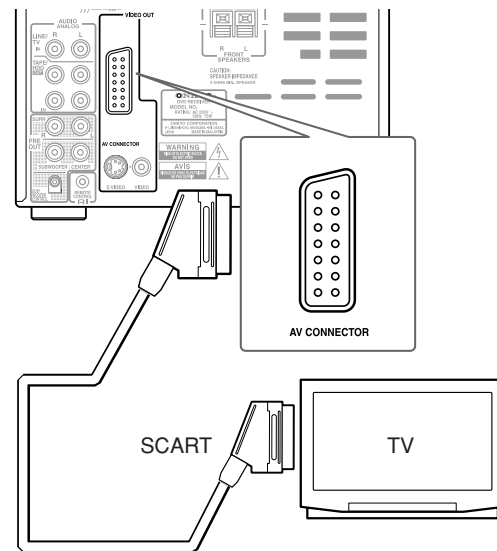

This connector can output composite video, S-Video, or RGB video. The default setting is composite, which should work with all TVs. Consult the manual that came with your TV to see if you can use one of the higher quality settings. See page 68 for how to change the video output.

Connecting External Devices

Connect the white plugs of the audio cables to the L jacks and connect the red plugs of the audio cables to the R jacks.
Tip: The source names appearing in the display can be customized for the connected component (see page 28).

Connecting an Onkyo Stereo Cassette Tape Deck

The following diagram illustrates how to connect an optional Onkyo stereo cassette tape deck. Connect the DVD receiver's TAPE/HDD OUT jacks to the tape deck's INPUT (REC) jacks, and the DVD receiver's TAPE/HDD IN jacks to the tape deck's OUTPUT (PLAY) jacks.

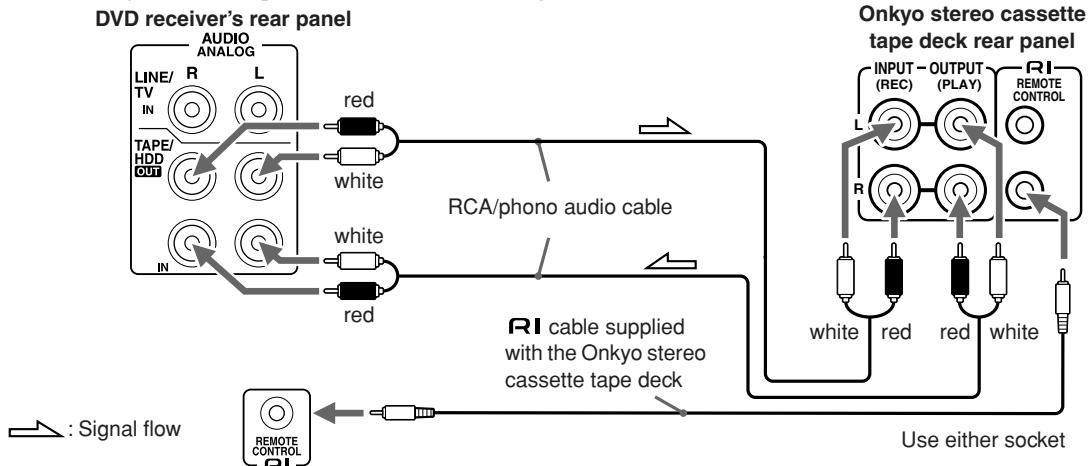

What does connecting an Onkyo stereo cassette tape deck using an RI cable enable you to do?

- You can control a connected Onkyo stereo cassette tape deck using the supplied remote controller. You also need to connect the RCA/phono audio cable.
- To operate the RI system, the source name in the display should be TAPE. (Since the default source name in the display is TAPE, you do not need to change the setting. See page 28 for further information.)
- When the connected Onkyo stereo cassette tape deck plays back, the Input Selector on the DVD receiver is automatically switched to TAPE.

Connecting an RI Dock (Remote Interactive Dock)

The following diagram illustrates how to connect the Onkyo RI Dock which is sold separately. Connect the TAPE/HDD IN jacks on the DVD receiver to the AUDIO OUT jacks on the RI Dock.

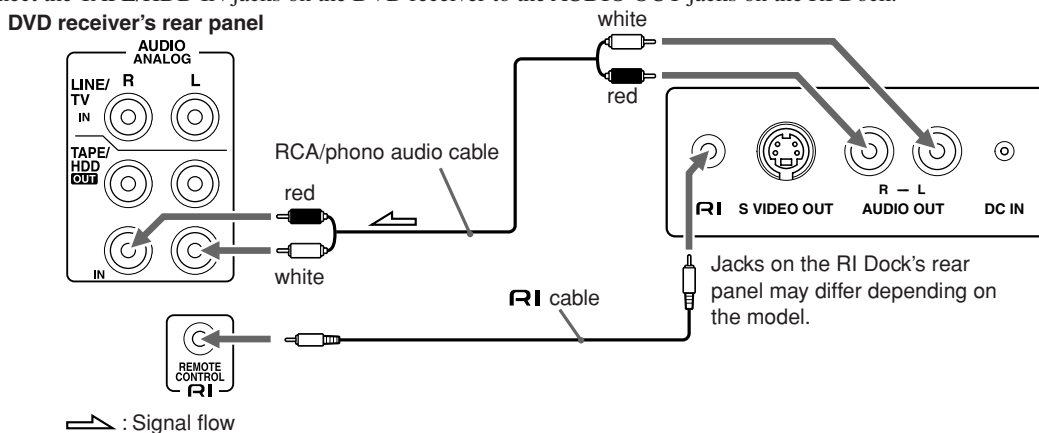

The RI jack connection enables you to use the following functions:

- You can control a connected Onkyo RI Dock using the supplied remote controller. You also need to connect the RCA/phono audio cable.
- When an RI Dock and other RI-compatible devices are connected with the DVD receiver, you must also interconnect the RI terminals between the two external devices.
- You need to change the source name in the display to HDD. (The default source name in the display is TAPE. See page 28 for further information.) If the RI Dock has a MODE switch, you must set the switch to HDD.
- When the connected Onkyo RI Dock plays back, the input selector on the DVD receiver is automatically switched to HDD.

Connecting External Devices—Continued

Connection for TV Audio Signal

Connect the LINE IN terminal on the DVD receiver and an audio output terminal on TV.

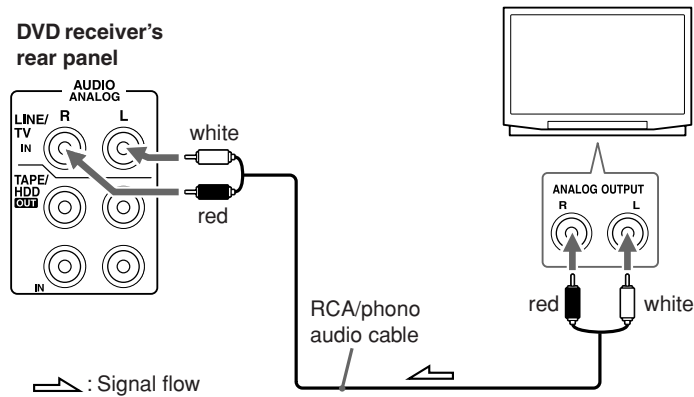

Connecting a Subwoofer

The DVD receiver has a SUBWOOFER PRE OUT jack. Connect an active subwoofer (a subwoofer that contains an amplifier).

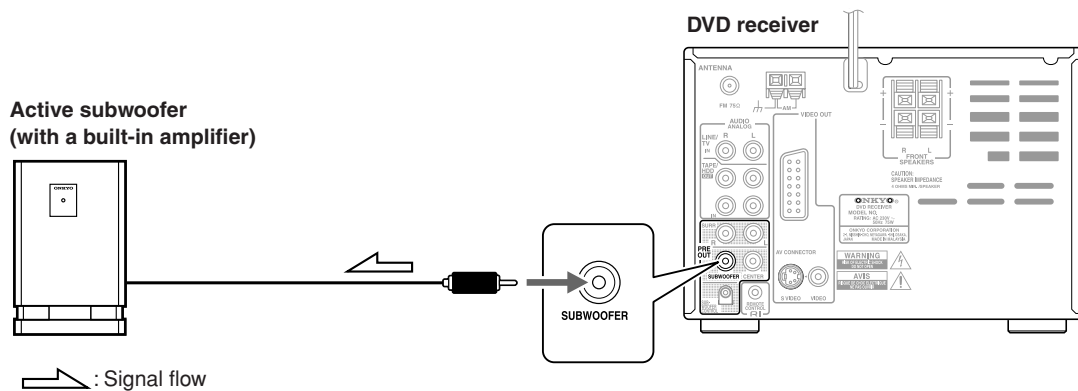

Note:

If you want to connect any passive subwoofer, you must connect at first a power amplifier with the DVD receiver, and then connect a subwoofer to the power amplifier.

Connection for Enjoying 5.1ch Playback

You can connect a center speaker and a left and a right surround speakers by adding on a power (main) amplifier. In addition to this configuration, you can add on a subwoofer to enjoy the 5.1ch surround sound. (See page 22.) Once you have completed the connection, make sure to configure the settings for speakers, described on page 52, so that you can enjoy your favorite surround mode.

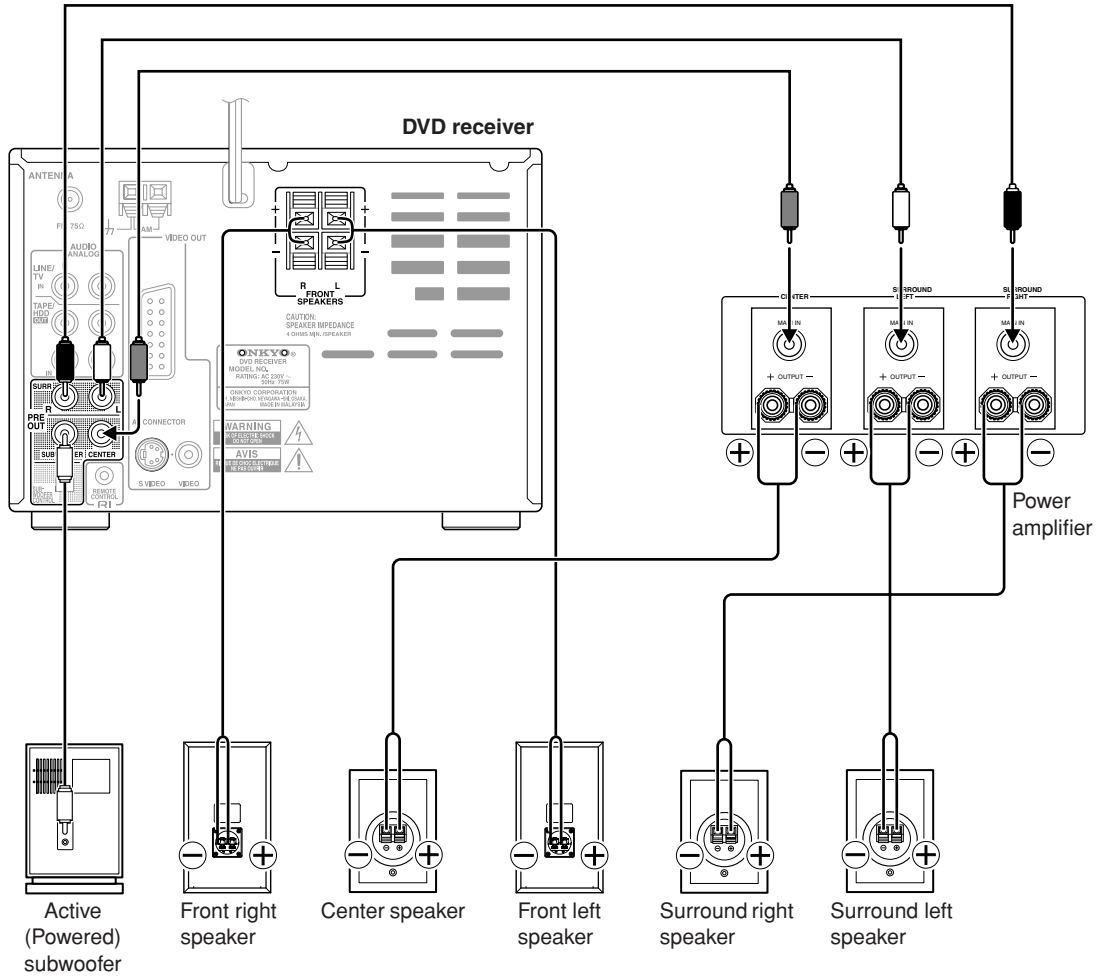

Connecting External Devices—Continued

Enjoying Home Theater

The DVD receiver provides multi-channel playback with its theater dimensional feature, even under two front speaker conditions.

Certainly, it can provide full 5.1ch playback in combination with an add-on subwoofer, center and surround speakers off the shelf, so that you can enjoy more realistic, movie theater/concert hall-in-the-home sound effect.

With DVDs you can enjoy DTS and Dolby Digital.

Front left and right speakers

These output the overall sound. Their role in a home theater is to provide a solid anchor for the sound image. They should be positioned facing the listener at about ear level, and equidistant from the TV. Angle them inward so as to create a triangle, with the listener at the apex.

Center speaker

This speaker enhances the front left and right speakers, making sound movements distinct and providing a full sound image. In movies it's used mainly for dialog.

Position it close to your TV (preferably on top) facing forward at about ear level, or at the same height as the front left and right speakers.

Subwoofer

The subwoofer handles the bass sounds of the LFE (Low-Frequency Effects) channel. The volume and quality of the bass output from your subwoofer will depend on its position, the shape of your listening room, and your listening position. In general, a good bass sound can be obtained by installing the subwoofer in a front corner, or at one-third the width of the wall, as shown.

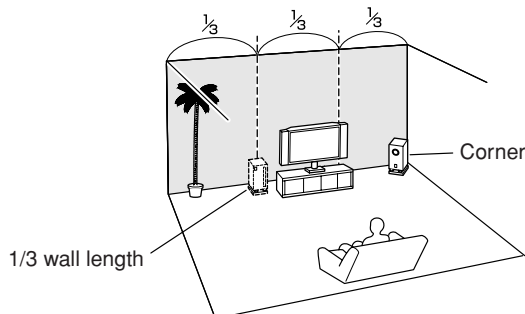

Surround left and right speakers

These speakers are used for precise sound positioning and to add realistic ambience.

Position them at the sides of the listener, or slightly behind, about 2–3 feet (60–100 cm) above ear level. Ideally they should be equidistant from the listener.

- For optimum surround playback, set the distance between the listener and the speakers so that the time it takes the sound to reach the listener is same. Also, you need to set each speaker volume level individually in order to balance the volume level between speakers (see pages 52-53).

Connecting the Power Cord

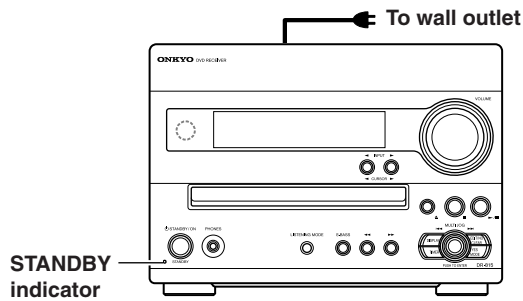

When the power cord is connected to the AC outlet, the DVD receiver enters Standby mode. The STANDBY indicator lights up.

When you want to set the clock using the DVD receiver's ACCUCLOCK function, the FM antenna needs to be connected for receiving the RDS radio broadcasts. For more information, see page 16.

First Time Setup

The very first time you turn on the DVD receiver, the ACCUCLOCK function automatically sets the clock by using the CT (Clock Time) information present in RDS radio broadcasts. While the clock is being set, "Wait" flashes on the display, as shown. It may take up to five minutes to set the clock.

When the clock has been set, the message "Clock Adjusted" scrolls across the display, then the day and time are displayed for a while, as shown.



The ACCUCLOCK function automatically updates the clock daily at 2 A.M., 3 A.M. and 2 P.M.

If the clock has not been set correctly, see "Setting ACCUCLOCK to Use a Specific Station" on page 58 and "Setting the Clock Manually" on page 59.

Turning Off ACCUCLOCK

If you don't want ACCUCLOCK to automatically update the clock at 2 A.M., 3 A.M. and 2 P.M. everyday, you can turn it off as follows.

1 	<p>Press TIMER button repeatedly until "Clock" appears on the display, as shown.</p> <div style="border: 1px solid black; padding: 5px; text-align: center; margin: 10px 0;"> Clock </div>
2 	<p>Press MULTI JOG.</p> <p>"*AccuClock*" appears on the display, as shown.</p> <div style="border: 1px solid black; padding: 5px; text-align: center; margin: 10px 0;"> *AccuClock* </div> <p>These asterisks appear when the ACCUCLOCK function is on.</p>
3 	<p>To turn off ACCUCLOCK, press YES/MODE.</p> <div style="border: 1px solid black; padding: 5px; text-align: center; margin: 10px 0;"> AccuClock </div> <p>The asterisks disappear, indicating that the ACCUCLOCK function is off. To turn the ACCUCLOCK function on again, press YES/MODE so that asterisks appear.</p>

Note:
This operation is not available if time adjustment was not properly performed in the previous section.

Understanding Common Operations

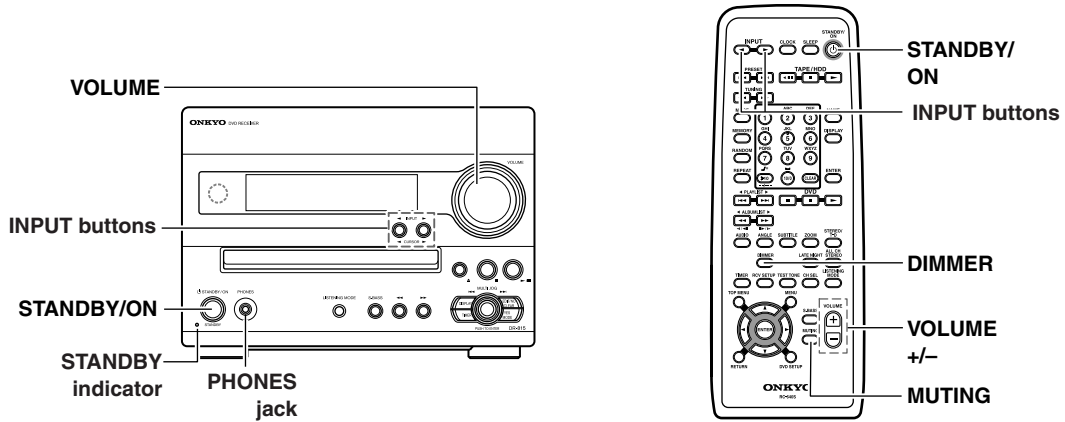

Turning the Unit On and Off

Press STANDBY/ON on the unit or on the remote controller.

If you press the same button again, the unit will turn off and enter Standby mode.

The DVD receiver is not completely shutdown in Standby mode.

To completely shut down the DVD receiver, disconnect the power cord from wall outlet.

Tip:

- When you start playing (or turn on the power to) an Onkyo RI Dock, CD recorder or cassette tape deck that is connected to the DVD receiver via an **RI** cable and RCA/phono audio cables, the power to the DVD receiver is automatically turned on. Also, if you turn on or off the power to the DVD receiver, the power to such a device is automatically turned on or off (standby).

Adjusting the Volume

DVD receiver

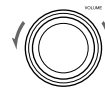

Remote controller

VOLUME

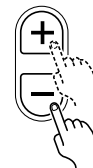

Turn VOLUME clockwise to increase the volume or counterclockwise to decrease the volume on the DVD receiver.

Press VOLUME +/- on the remote controller.

Understanding Common Operations—Continued

Selecting a Source

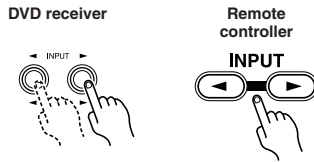

You can select DVD, FM, AM, or connected external audio/video equipment (HDD, CD-R, TAPE, LINE) as the audio source.

To select the audio source, press the INPUT ◀ or ▶ button repeatedly.

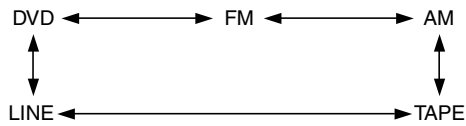

Muting the Sound

Press MUTING on the remote controller. The MUTING indicator lights in the display.

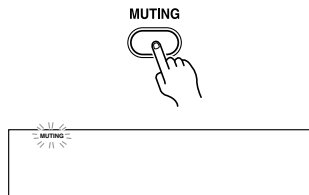

To restore the sound, press MUTING again.

Tip:

During muting:

- If you press VOLUME +/- on the remote controller or turn VOLUME on the front panel, the sound will be restored.
- If you turn the unit off and then on again, the sound will be restored.

Controlling Display Brightness



Press DIMMER on the remote controller.

Every time you press the button, the display brightness will change as follows:

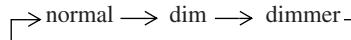

Listening through the Headphones

Decrease the volume, then connect the stereo headphones mini plug to the PHONES jack.

You can adjust the volume and mute the sound as described above.

The speakers will reproduce no sound while the headphones are connected.

To PHONES jack

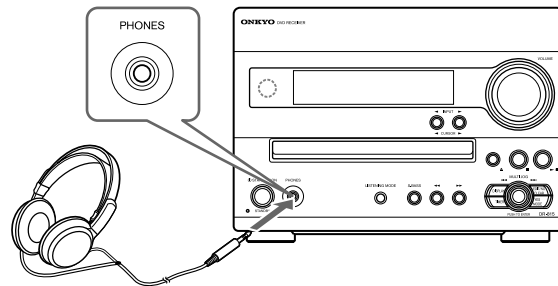

Hint:

When you connect a pair of headphones, the listening mode is set to Stereo, unless it's already set to Stereo, Mono, or Direct.

Customizing the Source Names

You can change the source name that appears in the display to suit any component you connected per the instructions on pages 21-22.

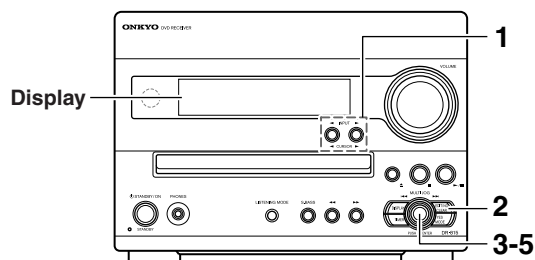

1 Press **INPUT** until the source whose name you wish to change appears in the display. You can select TAPE or LINE.

2 Press **EDIT/NO/CLEAR** repeatedly until "Name Select?" appears in the display.

3 Press **MULTI JOG**.

4 Turn **MULTI JOG** to select a new name for the source. Depending on the source you've selected in step 1, the name changes in the following order:

```

    TAPE ↔ HDD ↔ CD-R
           ↗     ↖
            PC *1
           ↖     ↗
    LINE ↔ TV
           ↗     ↖
            GAME
    
```

*1 Select this if you connected an Onkyo USB component that supports **RI** connection.

5 Press **MULTI JOG** to enter the new name.

"Complete" appears in the display. You may press YES/MODE instead of MULTI JOG to get the same result.

About short source names

The short source names appear in the display depending on the situation. Check the short names in the table below.

Ordinary names	Short names
CD-R	CR
GAME	GM
HDD	HD
LINE	LI
PC	PC
TAPE	TA
TV	TV

Note: Pages 76 and 77 offer a list of the remote controller buttons you can use after you have changed the source names.

Before Starting DVD Playback

Using the On-screen Displays

For ease of use, this player makes extensive use of graphical on-screen displays (OSDs). All the screens are navigated in basically the same way, using the cursor buttons (◀/▶/▲/▼) to change the highlighted item and pressing ENTER to select it.

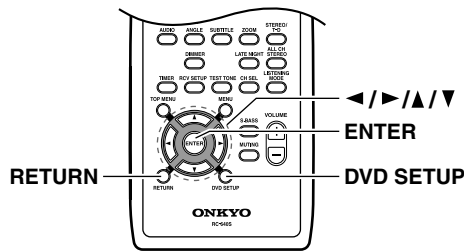

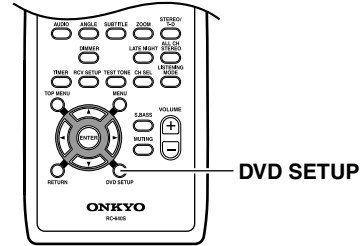

Setting Up the Player for Your TV

Note: If you have a widescreen (16:9) TV, you should setup the player so that the picture will be presented correctly. If you have a conventional (4:3) TV, you can leave the player on the default setting and move on to the next section.



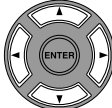

Note:

From here on in this manual, the word “select” generally means use the cursor buttons to highlight an item on-screen, then press ENTER.

Button	What it does
	Display/exit the on-screen display.
	Changes the highlighted menu item.
	Selects the highlighted menu item (both ENTER buttons on the remote work in exactly the same way).
	Returns to the main menu without saving changes.

- 1** Press DVD SETUP and select “Initial Settings”.

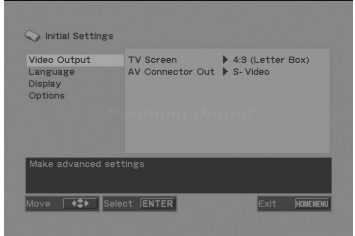

- 2** Select “TV Screen” from the “Video Output” settings.

- 3** If you have a widescreen (16:9) TV, select “16:9 (Wide)”.

If you have a conventional (4:3) TV, you can change the setting from 4:3 (Letter Box) to 4:3 (Pan & Scan) if you prefer. See “Video Output settings” on page 68 for more details.
- 4** Press DVD SETUP to exit the menu screen.



Note:

This player features a screen saver function. If the player is stopped and no button is pressed for five minutes, the screen saver starts.

Before Starting DVD Playback—Continued

Setting the Language of This Player's On-screen Displays

This sets the language of this system's on-screen displays.

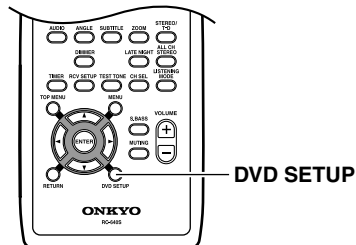

1



Press DVD SETUP and select "Initial Settings".

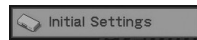

2

Select "OSD Language" from the "Display" settings.

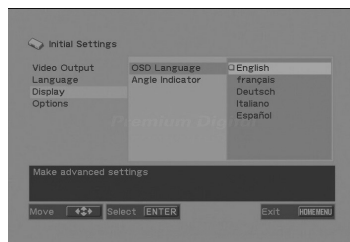

- English, French, German, Italian and Spanish are available.
- Note that the language you choose here may not be available on all discs.

3

Select a language.

The on-screen language will change according to your selection.

4



Press DVD SETUP to exit the menu screen.

Playing Discs

The basic playback controls for playing DVD, CD, SACD, Video CD and MP3/WMA discs are covered here. Further functions are detailed in the next chapter.

For details on playing JPEG picture discs, see “Viewing a JPEG Slideshow” on page 41.

Important:

Throughout this manual, the term “DVD” means DVD-Video, DVD-Audio and DVD-R/ RW. If a function is specific to a particular kind of DVD disc, it is specified.

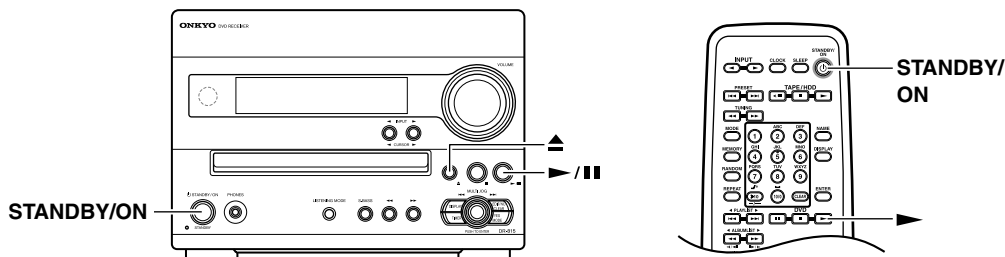

- 1**

If the player isn't already on, press STANDBY/ON to switch it on.

If you're playing a DVD or Video CD, also turn on your TV and make sure that it is set to the correct video input.
- 2**

Press ▲ OPEN/CLOSE to open the disc tray.
- 3**

Load a disc.

Load a disc with the label side facing up, using the disc tray guide to align the disc (if you're loading a double-sided DVD disc, load it with the side you want to play face down).
- 4**

Press ► (play) to start playback.

If you're playing a DVD or Video CD, an on-screen menu may appear. See “DVD Disc Menus” on page 32 and “Video CD PBC menus” on page 33 for more on how to navigate these.

 - If you're playing an MP3/WMA disc, it may take a few seconds before playback starts.

Remote controller

Note:

- You may find with some DVD discs that some playback controls don't work in certain parts of the disc. This is not a malfunction.

Resume and Last Memory

With the DVD-Video, Video CD and Audio CD, when you stop playback of a disc, RESUME is shown in the display indicating that you can resume playback again from that point.

If the disc tray is not opened, the next time you start playback the display shows RESUME and playback resumes from the resume point. (If you want to clear the resume point, press ■ (stop) while RESUME is displayed.)

If you take a VCD out of the player after stopping playback, the last play position is stored in memory. If the next disc you load is the same one, the display shows LAST MEM and playback will resume. For DVD-Video discs (except VR mode DVD-RW), the player stores the play position of the last five discs. When one of these discs is next loaded, you can resume playback.

Notes:

- The Last Memory function doesn't work with VR format DVD-RW, DVD-Audio or SACD discs.
- If you don't need the Last Memory function when you stop a disc, you can press ▲ OPEN/CLOSE to stop playback and open the disc tray.

Playing Discs—Continued

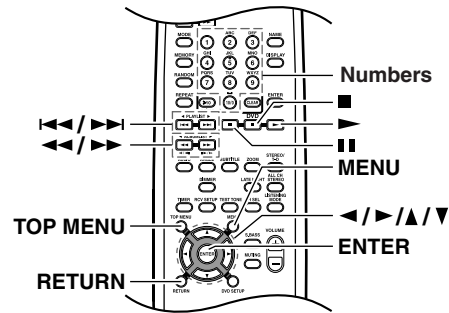
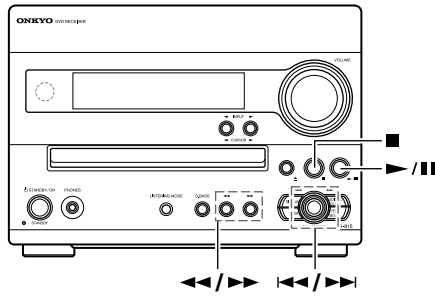

Basic Playback Controls

The table below shows the basic controls on the remote for playing discs. The following chapter covers other playback features in more detail.

Button		What it does
DVD receiver	remote	
▶/	▶	Starts playback. If the display shows RESUME or LAST MEM playback starts from the resume or last memory point (see also "Resume and Last Memory" on page 31).
▶/		Pauses a disc that's playing, or restarts a paused disc.
■	■	Stops playback. See also "Resume and Last Memory" on page 31.
◀◀	◀◀	Press to start fast reverse scanning. Press ▶ (play) to resume normal playback.
▶▶	▶▶	Press to start fast forward scanning. Press ▶ (play) to resume normal playback.
MULTI JOG 	◀◀	Skips to the start of the current track or chapter, then to previous tracks/chapters.
	▶▶	Skips to the next track or chapter.
Numbers (remote only)		Use to enter a title/chapter/track number. Press ENTER to select. <ul style="list-style-type: none"> If the disc is stopped, playback starts from the selected title (for DVD), group (for DVD-Audio) or track (for CD/SACD/Video CD). If the disc is playing, playback jumps to the start of the selected title (VR mode DVD-RW), chapter (DVD-Video) or track (DVD-Audio^{*1}/SACD/CD/Video CD) <p>^{*1} within the current group</p> <p>Note: Depending on the disc you load, you may not use the number buttons for direct selection.</p>

DVD Disc Menus

Many DVD-Video and DVD-Audio discs feature menus from which you can select what you want to watch.

They may also give access to additional features, such as subtitle and audio language selection, or special features such as slideshows. See the disc packaging for details. Sometimes DVD-Video menus are displayed automatically when you start playback; others only appear when you press MENU or TOP MENU.

Important:



- Some DVD-Audio discs feature a "bonus group". To play this group you first have to input a password, which you can find on the disc's packaging. Use the number buttons to input the password.

Button (remote only)	What it does
TOP MENU	Displays the "top menu" of a DVD disc—this varies with the disc.
MENU	Displays a DVD disc menu—this varies with the disc and may be the same as the "top menu".
◀/▶/▲/▼	Moves the cursor around the screen.
ENTER	Selects the current menu option.
RETURN	Returns to the previously displayed menu screen.
Numbers	Highlights a numbered menu option (some discs only). Press ENTER to select.

Video CD PBC menus

Some Video CD have menus from which you can choose what you want to watch. These are called PBC (Playback control) menus.

You can play a PBC Video CD without having to navigate the PBC menu by starting playback using a number button to select a track, rather than the ► (play) button.



Button		What it does
DVD receiver	remote	
—	RETURN	Displays the PBC menu.
—	Numbers (remote only)	Use to enter a numbered menu option. Press ENTER to select.
		Displays the previous menu page (if there is one).
		Displays the next menu page (if there is one).

Notes:

- When playing Video CD, some of the functions are not available during PBC playback. If you want to use them, start the disc playing using a number button to select a track.
- To start playback without PBC, use the number buttons to select a track for playback while the DVD receiver is stopped, and then press ENTER.

Scanning Discs

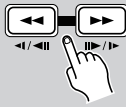







You can fast-scan discs forward or backward at four different speeds.

<p>1</p> 	<p>During playback, press ◀◀ or ▶▶ to start scanning.</p> <ul style="list-style-type: none"> • There is no sound while scanning DVDs (including DVD-Audio) and Video CD/ Super VCDs.
<p>2</p>	<p>Press repeatedly to increase the scanning speed.</p> <ul style="list-style-type: none"> • The scanning speed is shown on-screen.
<p>3</p> 	<p>To resume normal playback, press ► (play).</p> <ul style="list-style-type: none"> • When scanning a Video CD playing in PBC mode or a WMA/MP3 track, playback automatically resumes at the end or beginning of the track. • Depending on the disc, normal playback may automatically resume when a new chapter is reached on a DVD disc.

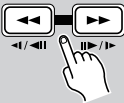
Playing Discs—Continued

Playing in Slow Motion

Playing in slow motion you can play DVD-Videos and DVD-R/RW at four different slow motion speeds, forwards and backwards. Video CD/Super VCDs can be played at four different forward slow motion speeds.









1 	During playback, press  (pause).
2 	Press and hold /  or /  until slow motion playback starts. <ul style="list-style-type: none">• The slow motion speed is shown on-screen.• There is no sound during slow motion playback.
3	Press repeatedly to change the slow motion speed.
4 	To resume normal playback, press  (play). <ul style="list-style-type: none">• Depending on the disc, normal playback may automatically resume when a new chapter is reached.

Note:

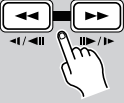
- Backward slow-motion playback does not work with Video CD.

Frame Advance/Frame Reverse

You can advance or reverse DVD-Video and DVD-R/RW discs frame-by-frame. With Video CD you can only use frame advance.

1 	During playback, press  (pause).
2 	Press /  or /  to reverse or advance a frame at a time.
3 	To resume normal playback, press  (play). <ul style="list-style-type: none">• Depending on the disc, normal playback may automatically resume when a new chapter is reached.

Note:

- Backward frame-by-frame playback does not work with Video CD.

Switching Audio Language/Channel

When playing a DVD-Video disc recorded with dialog in two or more languages, you can switch audio language during playback.

When playing a VR format DVD-RW disc recorded with dual-mono audio, you can switch between the main, sub, and mixed channels during playback.

When playing a DVD-Audio disc, you may be able to switch channels—see the disc box for details. (When you change the audio channel, playback restarts from the beginning of the current track.)

When playing a Video CD, you can switch between stereo, just the left channel or just the right channel.

1



Press AUDIO repeatedly to select an audio language/channel option.

The language/channel information is shown on-screen.

Notes:

- Some DVD discs only allow you to change audio language from the disc menu. Press TOP MENU or MENU to access.
- To set DVD audio language preferences, see “Language settings” on page 69.

Switching Camera Angles

Some DVD discs feature scenes shot from two or more angles—check the disc box for details.

When a multi-angle scene is playing, a  icon appears on screen to let you know that other angles are available (this can be switched off if you prefer—see “Display settings” on page 70).

1



During playback (or when paused), press ANGLE to switch angle.

Zooming the Screen

Using the zoom feature you can magnify a part of the screen by a factor of 2 or 4, while watching a DVD or Video CD or playing a JPEG disc.

1



During playback, use the ZOOM button to select the zoom factor (Normal, 2x or 4x).

- Since DVD, Video CD and JPEG pictures have a fixed resolution, picture quality will deteriorate, especially at 4x zoom. This is not a malfunction.

2

Use the cursor buttons to change the zoomed area.

You can change the zoom factor and the zoomed area freely during playback.

- If the navigation square at the top of the screen disappears, press ZOOM again to display it.

Note:

- If you are displaying subtitles, these will disappear when the screen is zoomed. They will reappear when you return the screen to normal.

Switching Subtitles

Some DVD-Video discs have subtitles in one or more languages; the disc box will usually tell you which subtitle languages are available. You can switch subtitle language during playback.

1



Press SUBTITLE repeatedly to select a subtitle option.

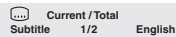

Notes:

- Some discs only allow you to change subtitle language from the disc menu. Press TOP MENU or MENU to access.
- To set subtitle preferences, see “Language settings” on page 69.

Playing Discs—Continued

Browsing Video Content with the Disc Navigator

Use the Disc Navigator to browse through the contents of a DVD-Video, DVD-RW or Video CD disc to find the part you want to play.

Important:

- You can't use the Disc Navigator with Video CD in PBC mode.

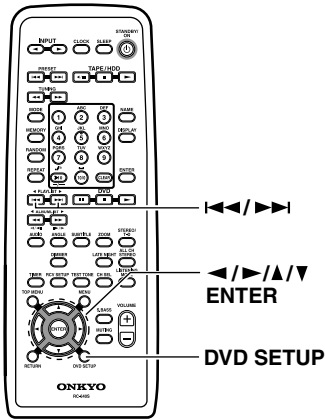

1 During playback, press **DVD SETUP** and select "Disc Navigator" from the on-screen menu.

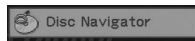

2

Select a view option.

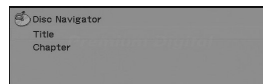

The options available depend on the kind of disc loaded and whether the disc is playing or not, but include:

- Title** – Titles from a DVD-Video disc.
- Chapter** – Chapters from the current title of a DVD-Video disc.
- Track** – Tracks from a Video CD disc.
- Time** – Thumbnails from a Video CD disc at 10 minute intervals.
- Original: Title** – Original titles from a VR mode DVD-RW disc.

3

Select the thumbnail image for what you want to play.

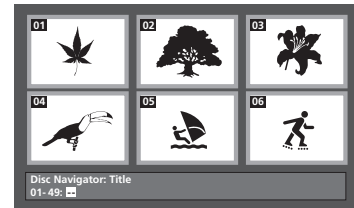

You can use either the cursor buttons (<</>>/▲/▼) and ENTER to select a thumbnail, or the number buttons. To select using the number buttons, enter a two-digit number then press ENTER.

Tip:

- Another way to find a particular place on a disc is to use one of the search modes. See "Searching a Disc" on page 39.

Browsing WMA, MP3 and JPEG files with the Disc Navigator

Use the Disc Navigator to find a particular file or folder by filename.

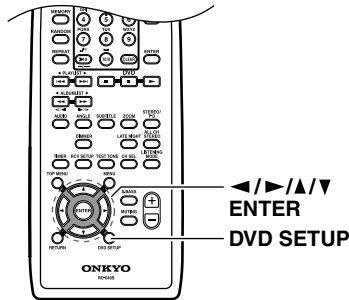

3



To play the highlighted track or display the highlighted JPEG file, press ENTER.

- When a WMA/MP3 file is selected, playback begins, starting with the selected track, and continues until the end of the folder.
- When a JPEG file is selected, a slide-show begins, starting with that file, and continues to the end of the folder.

Tip:

- To play the contents of the whole disc rather than just the current folder, exit the Disc Navigator and start playback using the ► (play) button.

1



Press DVD SETUP and select “Disc Navigator” from the on-screen menu.

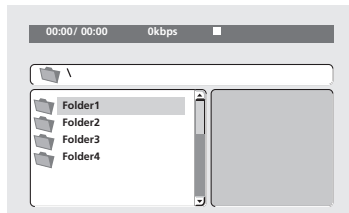

2



Use the cursor buttons (▲/▼/◀/▶) and ENTER to navigate.

Use the cursor up/down buttons (▲/▼) to move up and down the folder/file list. Use the cursor left button (◀) to return to the parent folder. Use ENTER or cursor right (▶) to open a highlighted folder.

- You can also return to the parent folder by going to the top of the list to the “..” folder, then pressing ENTER.
- When a JPEG file is highlighted, a thumbnail image is displayed on the right.

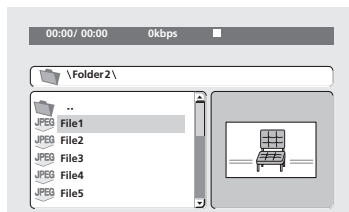

Playing Discs—Continued

Creating a Program List

This feature lets you program the play order of titles/chapters/tracks on a disc.

Important:

- You can't use Program play with VR format DVD-RW discs, Video CD playing in PBC mode, WMA/MP3 discs, or while a DVD disc menu is being displayed.
- When CD is loaded, no operation information is available on your TV; you can operate the control by viewing the display on the DVD receiver.

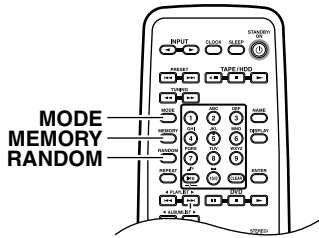

1 Press **MODE** and select “Program” from the list of functions on the left.

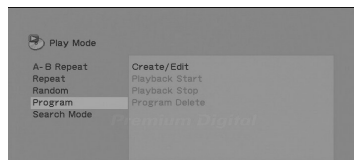
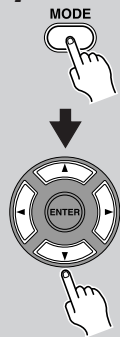

Select “Create/Edit” from the list of program options and press **ENTER**.

You can take a shortcut to display the screen by using **MEMORY** in stead of using both **MODE** and **▲/▼** (cursor).

2 Use the cursor buttons and **ENTER** to select a title, chapter or track for the current step in the program list.

For a DVD-Video disc, you can add a title or a chapter to the program list.

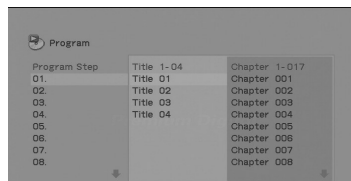

- For a DVD-Audio disc, you can add a whole group, or a track within a group to the program list.
- For a CD, SACD or Video CD, select a track to add to the program list.

After pressing **ENTER** to select the title/chapter/track, the step number automatically moves down one.

3 Repeat step 2 to build up a program list.

A program list can contain up to 24 titles/chapters/tracks.

- You can insert steps into the middle of a program list by just highlighting the position where you want the new step to appear and entering a title/chapter/track number.
- To delete a step, highlight it and press **CLEAR**.

4 To play the program list, press **▶** (play).

Program play remains active until you turn off program play (see below), erase the program list (see below), eject the disc or switch off the player.

Tip:

Use the following controls during program play:

Button	What it does
MODE	Save the program list and exit the program edit screen without starting playback (DVD SETUP does the same).
▶▶	Skip to the next step in the program list.

Creating a Program List for CD

- Press **MEMORY** while the DVD receiver is stopped.
- Select a track using the number buttons or **▲/▼** (cursor).
- Press **ENTER** to the lower left of the remote controller.
- Repeat steps 1 through 3.

If you press **CLEAR** here, the last memory will be cancelled.

- Press the **▶** (play) to start playback.

Pressing **■** will stop the DVD receiver and change the mode to **NORMAL**; if you press **CLEAR** here, you will see the “Mem.Clear” message, and all the settings stored in memory will get erased.

Other functions available from the program menu

There are a number of other options in the program menu in addition to Create/Edit.

- Playback Start** – Starts playback of a saved program list
- Playback Stop** – Turns off program play, but does not erase the program list
- Program Delete** – Erases the program list and turns off program play

Searching a Disc

You can search DVD-Video discs by title or chapter number, or by time; DVD-Audio discs can be searched by group or track number; SACDs by track number, CDs and Video CD by track number or time.

Important:

- Search functions are not available with Video CD in PBC mode, or with WMA/MP3 discs.

1 Press **MODE** and select “Search Mode” from the list of functions on the left.

The search options available depend on the kind of disc loaded.

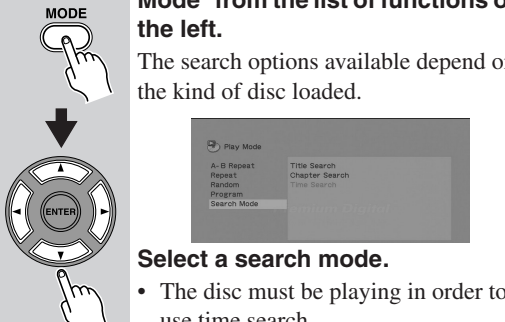

Select a search mode.

- The disc must be playing in order to use time search.

2 Use the number buttons to enter a title, chapter or track number, or a time.

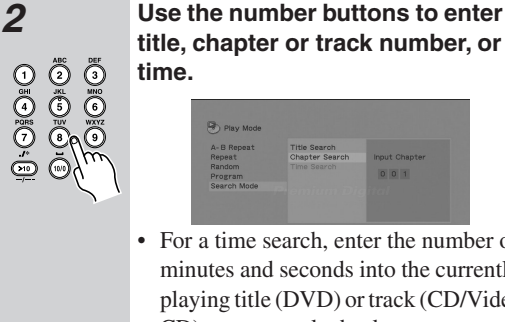

- For a time search, enter the number of minutes and seconds into the currently playing title (DVD) or track (CD/Video CD) you want playback to resume from. For example, press 4, 5, 0, 0 to have playback start from 45 minutes into the disc. For 1 hour, 20 minutes and 30 seconds, press 8, 0, 3, 0.
- Some DVD-Audio discs feature pages of browsable pictures. Enter the page number you want.

3 Press **ENTER** to start playback.



Using Random Play

Use the random play function to play titles or chapters (DVD-Video), Groups (DVD-Audio), or tracks (DVD-Audio, SACD, CD, Video CD) at random. (Note that the same track/title/chapter may play more than once.)

You can set the random play option when a disc is playing or stopped.

Important:

- Random play remains in effect until you select Random Off from the random play menu options.
- You can't use random play with VR format DVD-RW discs, Video CD playing in PBC mode, WMA/MP3 discs, or while a DVD disc menu is being displayed.
- You can't use random play together with program or repeat play.

1 Press **MODE** and select “Random” from the list of functions on the left.

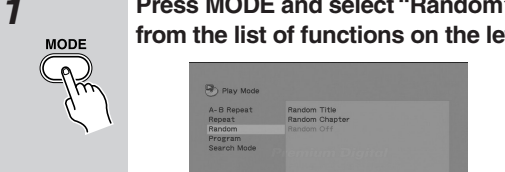

2 Select a random play option.

The random play options available depend on the kind of disc loaded. For example, for DVD-Video discs, you can select Random Title or Random Chapter, (or Random Off).

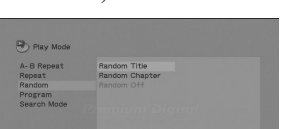



- For DVD-Audio discs, select Random Group or Random Track, (or Random Off).
- For CDs, SACDs and Video CD, select On or Off to switch random play on or off.
- If you press **■**, the NORMAL indicator lights up on the DVD receiver's display, indicating the Random mode has been disengaged and the mode is set to Normal.

You can select directly the Random mode by pressing **RANDOM**. Every time you press the button, you can change the available Random modes cyclically depending on the type of the loaded disc. When a DVD-Video disc is loaded, select any available Random mode by pressing **RANDOM**, and then set it by pressing **ENTER** on the lower left of the remote controller.

Tip:

- Use the following controls during random play:

Button	What it does
	Selects a new track/title/chapter at random.
	Returns to the beginning of the current track/title/chapter; further presses select another random track/title.

Playing Discs—Continued

Looping a Section of a Disc

The A-B Repeat function allows you to specify two points (A and B) within a track (CD, Video CD) or title (DVD-Video and DVD-RW) that form a loop which is played over and over.

- You can't use A-B Repeat with DVD-Audio, SACD, and Video CD in PBC mode, or WMA /MP3 files.
- You should configure this setting by viewing the On-Screen display. Therefore even for audio CD, any viewing device must be connected in order to set the two points (A and B) for looping.

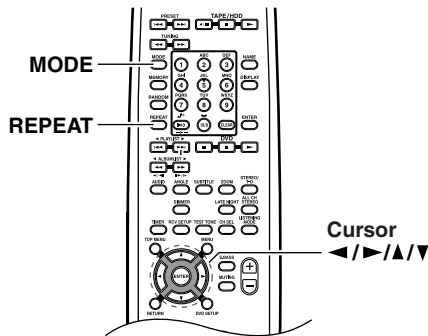

- 1** During playback, press **MODE** and select **"A-B Repeat"** from the list of functions on the left.

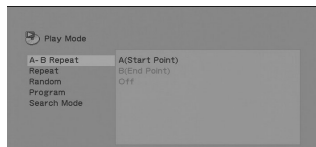

- 2** Select an A-B Repeat play option.

- 3** Press **ENTER** on **"A(Start Point)"** to set the loop start point.

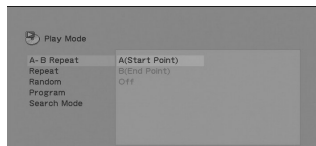

- 4** Press **ENTER** on **"B(End Point)"** to set the loop end point.



After pressing **ENTER**, playback jumps back to the start point and plays the loop.

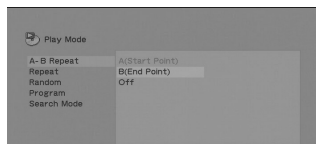

- 5** To resume normal playback, select **"Off"** from the menu.

Using Repeat Play

There are various repeat play options, depending on the kind of disc loaded. It's also possible to use repeat play together with program play to repeat the tracks/chapters in the program list (see "Creating a Program List" on page 38).

Important:

- You can't use Repeat play with Video CD in PBC mode, or with WMA/MP3 discs.
- You can't use repeat and random play at the same time.

- 1** During playback, press **MODE** and select **"Repeat"** from the list of functions on the left.

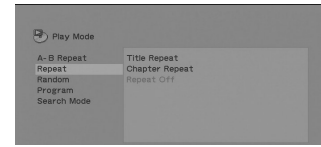

- 2** Select a repeat play option.

If program play is active, select Program Repeat to repeat the program list, or Repeat Off to cancel.

The repeat options available depend on the kind of disc loaded. For example, for DVD-Video and DVD-RW discs, you can select Title Repeat or Chapter Repeat (or Repeat Off).

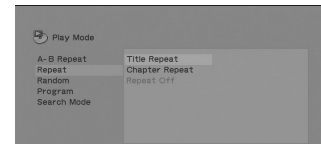

- For DVD-Audio discs, select Group Repeat or Track Repeat (or Repeat Off).
- For SACDs, CDs and Video CD, select Disc Repeat or Track Repeat (or Repeat Off).
- If you press **■**, the **NORMAL** indicator lights up on the DVD receiver's display, indicating the Repeat mode has been disengaged and the mode is set to Normal.

You can select directly the Repeat mode by pressing **REPEAT**. Every time you press the button, you can change the currently available Repeat modes cyclically. When A-B Repeat is set, it can be also selected as one of the Repeat modes.

Viewing a JPEG Slideshow

After loading a CD/CD-R/RW containing JPEG picture files, press ► (play) to start a slideshow from the first folder/picture on the disc. The player displays the pictures in each folder in alphabetical order.

Pictures are automatically adjusted so that they fill as much of the screen as possible (if the aspect ratio of the picture is different to your TV screen you may notice black bars at the sides, or at the top and bottom of the screen).

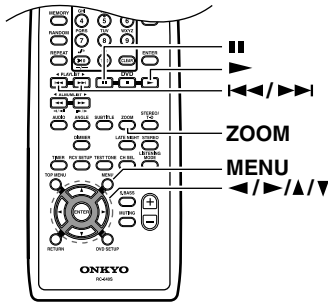

While the slideshow is running:

Button	What it does
	Pauses the slideshow; press again to restart.
◀◀	Displays the previous picture.
▶▶	Displays the next picture.
◀▶	Pauses the slideshow and rotates the displayed picture 90° (counter)clockwise. (Press ► (play) to restart slideshow.)
▲▼	Pauses the slideshow and flips the displayed picture horizontally or vertically. (Press ► (play) to restart slideshow.)
ZOOM	Pauses the slideshow and zooms the picture. Press again to toggle between 1x, 2x and 4x zoom. (Press ► (play) to restart slideshow.)
MENU	Displays the Disc Navigator screen (see below).

Notes:

- The time it takes for the player to load a file increases with large file sizes.
- Discs can contain up to 299 folders (groups) and up to 648 folders (groups) and files (tracks) combined.

Displaying Disc Information

Various track, chapter and title information, such as the elapsed and remaining playing time can be displayed on-screen while a disc is playing.

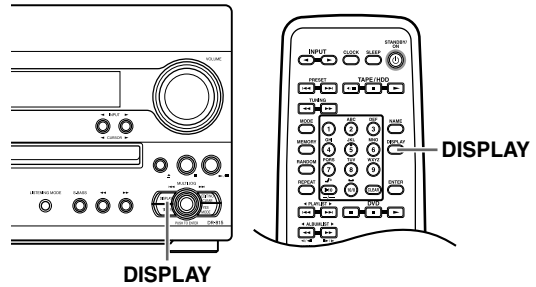

1



Remote controller
DISPLAY

To show/switch/hide the information displayed, press DISPLAY repeatedly.

- When a disc is playing, the information appears at the top of the screen.

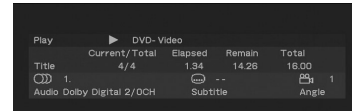

Listening to the Radio



Manually Tuning a FM/AM Broadcast Station

With the built-in tuner you can enjoy AM and FM radio stations. You can store your favorite stations as presets for quick selection.

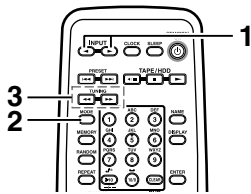
Turn on the power to the unit before you start the procedure.



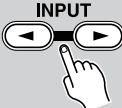

Auto Tuning Mode

1 	<p>Select FM or AM. Press the INPUT ◀ or ▶ button to select FM or AM. The channel selected most recently will be recalled.</p> <div style="border: 1px solid black; padding: 5px; text-align: center;"> <small>AUTO *** FM ST</small> FM 88.00MHz <small>Band Frequency</small> </div>
2 	<p>Press MODE so that the AUTO indicator appears on the display. Alternatively, you may press YES/ MODE on the DVD receiver to do so.</p>
3 	<p>Press TUNING ◀/▶. Searching stops when a station is found.</p>

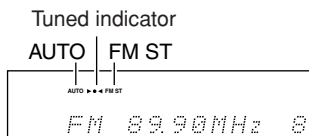
When tuned into a station, the Tuned ▶ ● ◀ indicator appears. When tuned into a stereo FM station, the FM ST indicator appears on the display, as shown.

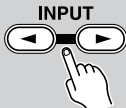

Manual Tuning Mode

1 	<p>Select FM or AM. Press the INPUT ◀ or ▶ button to select FM or AM. The channel selected most recently will be recalled.</p> <div style="border: 1px solid black; padding: 5px; text-align: center;"> <small>AUTO *** FM ST</small> FM 88.00MHz <small>Band Frequency</small> </div>
2 	<p>Press MODE so that the AUTO indicator disappears from the display. Alternatively, you may press YES/ MODE on the DVD receiver to do so.</p>
3 	<p>Press and hold TUNING ◀/▶. The frequency stops changing when you release the button. Press the buttons repeatedly to change the frequency one step at a time.</p>

The DVD receiver changes FM frequency in 0.05 MHz steps, 9 kHz steps for AM.

In Manual Tuning mode, FM stations will be in mono.

Tuning into weak FM stereo stations

If the signal from a stereo FM station is weak, it may be impossible to get good reception. In this case, switch to Manual Tuning mode and listen to the station in mono.

Adjusting the Antenna

Adjusting and installing the FM antenna

Adjust the location of the FM antenna while listening to an FM broadcast.

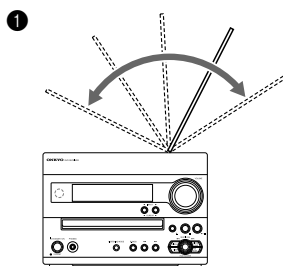

Change the direction of the antenna to determine the best reception.

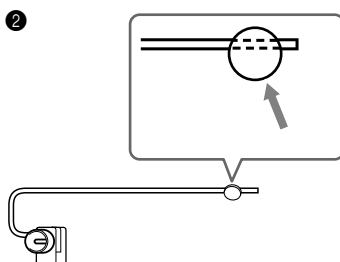

Affix the antenna using a thumbtack. (Do not press the thumbtack *through* the antenna.)

Caution: Be careful not to prick your finger!

Adjusting the AM antenna

Adjust the location and position of the AM antenna while listening to an AM broadcast to determine the best reception.

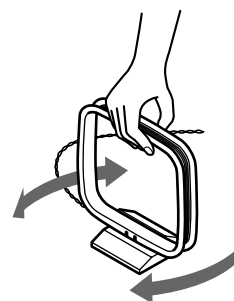

Listening to the Radio—Continued

Programming FM Stations Automatically – Auto Preset

Auto presets store the frequencies of radio stations into memory so you can select your favorite channels without tuning manually. Radio station signals can be automatically located and stored. This function does not apply to AM stations.

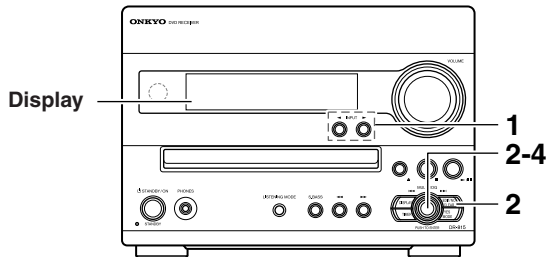







Before auto presetting

If any radio stations are preset before you start the auto preset procedure, they will be replaced with new presets.

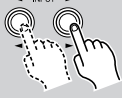
Turn on the power to the unit before you start the procedure.

Note:

Auto presetting may store noise instead of a station with a clear signal to some preset channels, depending on your location. In such cases, erase the preset manually (see page 49).

1  INPUT	Press INPUT ◀ / ▶ to display "FM".  FM To improve the FM reception, adjust the antenna position.
2  EDIT/NO/CLEAR ↓  MULTI JOG PUSH TO ENTER	Press EDIT/NO/CLEAR and turn MULTI JOG to display "AutoPreset?".  AutoPreset? The confirmation message "AutoPreset??" appears in the display.
3  MULTI JOG PUSH TO ENTER	Press MULTI JOG. The confirmation message "AutoPreset??" appears in the display.  AutoPreset?? To stop auto presetting, press EDIT/NO/CLEAR.

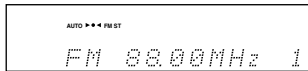
4  MULTI JOG PUSH TO ENTER	Press MULTI JOG. Auto presetting starts.  AUTO ▶▶▶ FM ST FM 88.00MHz 1 You can preset up to 20 stations. The preset stations will be automatically sorted in frequency order.
--	--

Customizing the Preset Channels

The following additional functions are available:

- Naming a preset channel (see page 50)
- Erasing a preset channel (see page 49)
- Copying the radio station in the selected channel to another (see page 48).

Programming FM/AM Stations One by One – Preset Write

You can store the frequencies of stations one by one manually into the preset memory channels. This is useful when you want to program the stations in your favorite order.

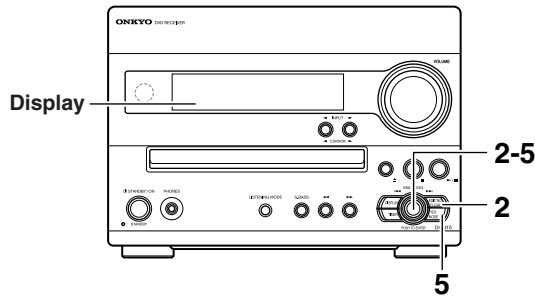

Before auto presetting

- You can preset up to 30 channels including both FM and AM stations. For example, if you have already stored FM stations to eight channels, you can use 22 channels to store preset AM stations.
- Programmed FM and AM stations are indicated separately. Therefore, one of the preset FM stations and one of the preset AM stations could use the same channel number.
- The Preset Write function enables you to store radio station frequencies to any channel number. For example, you could program three AM stations to channels 2, 5, and 9.

Turn on the power to the unit before you start the procedure.

1	<p>Tune into the FM/AM station that you want to store a preset.</p>
2	<p>Press EDIT/NO/CLEAR and turn MULTI JOG until “Preset Write?” appears in the display.</p> <div style="border: 1px solid black; padding: 5px; width: fit-content; margin: 10px auto;"> PresetWrite? </div>
3	<p>Press MULTI JOG.</p> <div style="border: 1px solid black; padding: 5px; width: fit-content; margin: 10px auto;"> ... AM 810kHz </div> <p>The channel number to be preset flashes. To cancel presetting, press EDIT/NO/CLEAR instead.</p>
4	<p>If you wish to change the channel number, turn MULTI JOG.</p> <div style="border: 1px solid black; padding: 5px; width: fit-content; margin: 10px auto;"> ... AM 810kHz </div>

5	<p>Press MULTI JOG to confirm.</p> <p>If “Complete” appears</p> <div style="border: 1px solid black; padding: 5px; width: fit-content; margin: 10px auto;"> ... Complete </div> <p>The radio station is registered to the preset channel.</p> <p>If “Overwrite?” appears</p> <div style="border: 1px solid black; padding: 5px; width: fit-content; margin: 10px auto;"> ... Overwrite? 4 </div> <p>The channel you’ve selected is registered already.</p> <ul style="list-style-type: none"> • To register the new radio station by deleting the existing radio station Press YES/MODE. • To cancel presetting Press EDIT/NO/CLEAR. <p>If “Memory Full” appears</p> <div style="border: 1px solid black; padding: 5px; width: fit-content; margin: 10px auto;"> Memory Full </div> <p>The FM/AM stations have already been programmed into all 30 channels. Delete unnecessary stations (page 49) and try again.</p>
6	<p>Repeat steps 2 to 5 to preset the next channel.</p>

Listening to the Radio—Continued

Customizing the preset channels

The following additional functions are available:

- Naming a preset channel (see page 50)
- Erasing a preset channel (see page 49)
- Copying the radio station in the selected channel to another (see page 48).

Selecting Preset Stations

First, program the stations into preset channels (see pages 44-45).

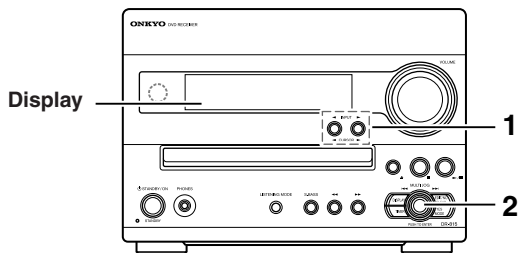

Turn on the power to the unit before you start the procedure.

1 	<p>Press the INPUT ◀ or ▶ button to select FM or AM.</p> <p>The channel selected most recently will be recalled.</p> <div style="border: 1px solid black; padding: 5px; text-align: center;"> <small>AUTO ▶ ◀ FM ST</small> FM 88.00MHz 1 </div>
2 	<p>Turn MULTI JOG or press the dial repeatedly to select the desired preset channel.</p> <p>Turn the dial counterclockwise to select a lower channel number, or turn it clockwise to select a higher channel number.</p> <div style="border: 1px solid black; padding: 5px; text-align: center;"> <small>AUTO ▶ ◀ FM ST</small> FM 89.90MHz 8 </div>

Using the remote controller

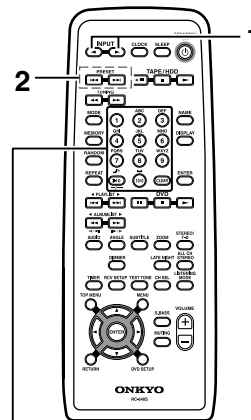

Press the number buttons as described in the examples below to select the desired preset channel.

Preset channel	Press
----------------	-------

8	
---	--

10	
----	--

22	
----	--

represents the tens digit.

Switching the Display Information

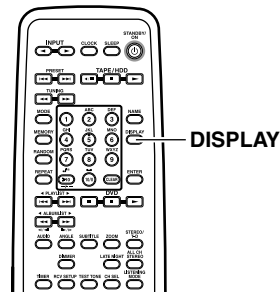
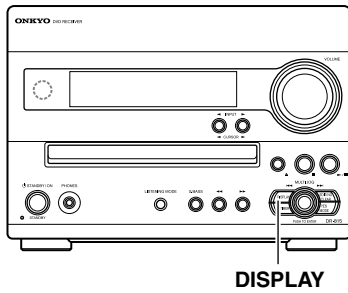

Repeatedly pressing DISPLAY on the remote controller or on the unit toggles between two types of information display.

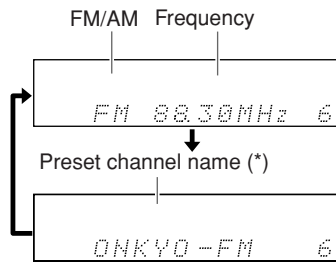

* If a given preset channel is not named, the unit displays “No Name,” then indicates the frequency. See “Naming a Preset Channel” on page 50.

Receiving RDS



Pressing DISPLAY repeatedly will change the display in the following order.

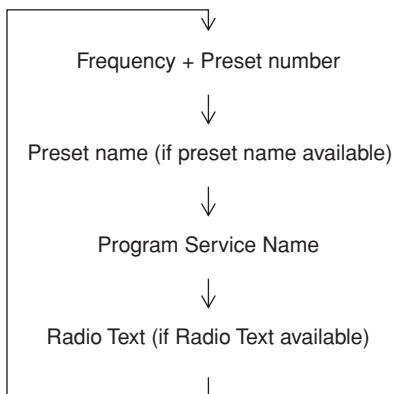

RDS reception is available only in areas where RDS broadcasts are available.

What is RDS?

RDS stands for Radio Data System and is a type of FM broadcasting. RDS was developed within the European Broadcasting Union (EBU) and is available in most European countries.

Many FM stations now transmit RDS signals which contain additional information. RDS provides you with various services so that you can choose a station broadcasting your favorite categories of music or other information. The information of Program Service Name and Radio Text is available for display on the DVD receiver.

The RDS indicator lights up when an RDS station is received.

Notes:

- If radio signals are weak, RDS may not be received.
- When tuning a station, “Waiting...” appears in the display.

Changing the Preset Channels

Using the delete and copy functions, you can delete preset stations, copy a preset station to another channel, or change the channel number.

Tips for Changing the Preset Channels

To change the channel number:

Use the copy and delete functions.

For example, if you wish to change channel 4 (which has an FM station programmed) to channel 6 (an empty channel):

- ❶ Copy the station in channel 4 to channel 6.
- ❷ Delete the station in channel 4.

Copying a Preset Channel – Preset Copy

If you copy a preset channel to another channel, the name of the preset channel (see page 50) is also copied to the other channel.

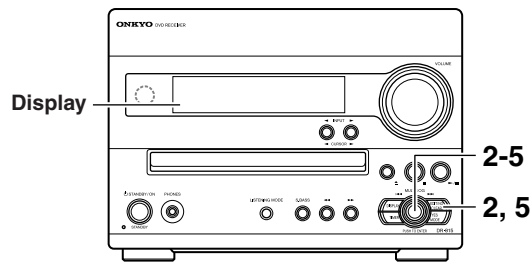

4



Turn MULTI JOG to select the preset channel number to which you wish to copy (destination).

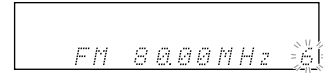

5



Press MULTI JOG to confirm.

If “Complete” appears:

The same radio station is copied to the preset channel.



If “Overwrite?” appears:

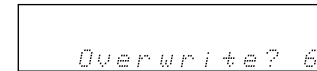

The channel you wish to copy to is registered already.

- **To register the new radio station by deleting the existing radio station:** Press MULTI JOG.
- **To cancel copying:** Press EDIT/NO/CLEAR.

1

Call the preset channel you wish to copy.



2



Press EDIT/NO/CLEAR and turn MULTI JOG until “PresetCopy?” appears in the display.

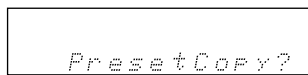

3

Press MULTI JOG.

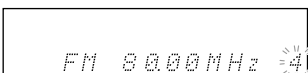

Erasing a Preset Channel – Preset Erase

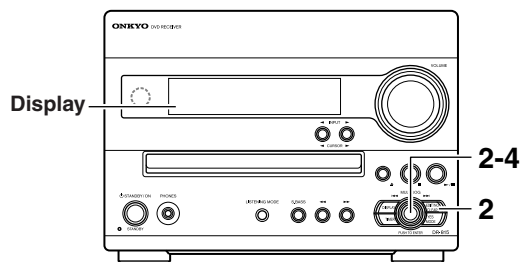

1 Call the preset channel you wish to erase.

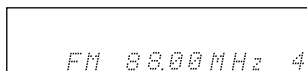

2 Press EDIT/NO/CLEAR and turn MULTI JOG until "PresetErase?" appears in the display.

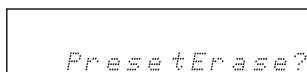

3 Press MULTI JOG. A message requesting confirmation appears in the display.



To stop erasing, press EDIT/NO/CLEAR.

4 Press MULTI JOG. "Complete" appears in the display. The preset channel is erased.



Naming Preset Channels

You can name FM/AM preset channels.

Naming a Preset Channel

After you select the preset channel to name, execute "Entering a Name" as described below.

You can enter up to eight characters per name.

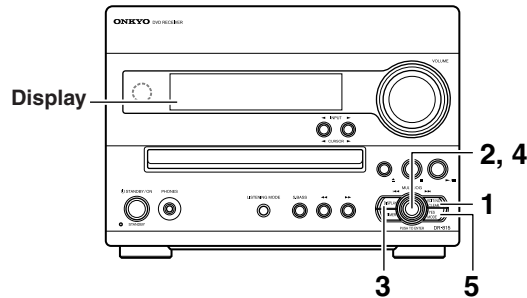

Entering a Name

	<p>1 Press EDIT/NO/CLEAR and turn MULTI JOG until "Name In?" appears in the display.</p> <div style="border: 1px solid black; padding: 5px; text-align: center; margin: 10px 0;">Name In?</div>
	<p>2 Press MULTI JOG.</p>
	<p>3 Press DISPLAY repeatedly until the character type you wish to enter appears in the display. You can select one of the following character entry modes:</p> <ul style="list-style-type: none"> • "A" for capital letters • "a" for small letters • "1" for numbers and symbols <div style="border: 1px solid black; padding: 5px; text-align: center; margin: 10px 0;"> </div> <p>The character type appears.</p>

4



Turn MULTI JOG to select the character, then press it to enter.

Repeat this step for the next character. If you wish to change the type of characters, repeat Step 3, then proceed with this step.

To cancel the entering name, press and hold EDIT/NO/CLEAR for more than two seconds.

5



Press YES/MODE after you enter all the characters.

You will see the "Complete" message that indicates the entry of characters is completed.

What Characters Can Be Entered?

You can enter the following characters:

A B C D E F G H I J K L M N O P Q R S T U V W X Y Z
 a b c d e f g h i j k l m n o p q r s t u v w x y z
 0 1 2 3 4 5 6 7 8 9
 _ @ ' < > # \$ % & * = ; : + - / () ?
 ! ' " , . _ (space) # (insert)

Correcting and Erasing a Character

If the unit is not in "Name In" mode, execute Steps 1 and 2 in "Entering a Name," then follow the steps below.

- 1** Press ◀/▶ repeatedly until the character you wish to correct or erase flashes.
- 2** *When correcting*
Enter the desired character following Steps 3 and 4 in "Entering a Name" in the left column.
When erasing
Press EDIT/NO/CLEAR on the unit or CLEAR on the remote controller.

Notes:

- If you press and hold EDIT/NO/CLEAR for more than two seconds, the DVD receiver returns to the previous indication without erasing characters.
- To continue entering characters, execute Step 3 in the left column. To complete the operation, execute Step 5.

Inserting a Character

If the unit is not in “Name In” mode, execute steps 1 and 2 in “Entering a Name,” then follow the steps below.

- 1 Press TUNING ◀▶ repeatedly until the character following the desired point of insertion flashes.



- 2 Turn MULTI JOG until “M” appears, then press MULTI JOG.

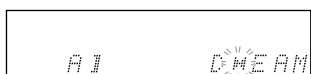

- 3 Enter the desired character as per Steps 3 and 4 in “Entering a Name”.



To continue entering characters, follow Step 3 in “Entering a Name” on the previous page. To complete the operation, follow Step 5.

Erasing the Name Assigned to a Preset Channel

- 1 Select AM or FM as the source.
- 2 Turn MULTI JOG to select the preset channel name you wish to erase.
- 3 Press EDIT/NO/CLEAR and turn MULTI JOG until “Name Erase?” appears in the display.
- 4 Press YES/MODE.
“Complete” appears and the name is erased.

Inputting Characters from the Remote Controller

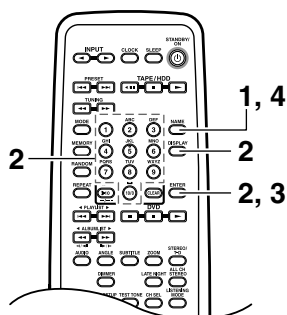

1



Press NAME.



2



Press DISPLAY repeatedly until the character type you wish to enter appears in the display.

Each press of the DISPLAY switches the type of characters.

- **Inputting alphabetical characters:**

Each press of a number button cycles through a few characters of the alphabets. For example, repeatedly pressing the 2ABC button displays A→B→C→A in this order. Display the desired character, then press ENTER.

- **Inputting numbers and symbols:**

Pressing a number button displays the corresponding number. Each press of the >10 (␣) button or the 10/0 (␣) button switches between the symbols labeled on the corresponding button. You can input “␣ → . → / → * → - → , → ! → ? → & → ’ → (→)” using the >10 button, and ␣ (space) using the 10/0 button. Display the desired number or symbol, then press ENTER.

Note:

You cannot input all symbols from the remote controller’s number buttons. To input symbols, use the remote controller’s PRESET ◀◀ or ▶▶ to select the desired symbols.

3



Press NAME to complete the naming process.

Enjoying Surround Sound

Configuring Subwoofer and Setting Up the Number of Speakers

The DVD receiver will provide you a full-fledged home theater, when it is added on extra speakers in addition to the two front speakers. (For information about how to add on, see page 23.)

The factory default settings support the two channels with only a left and a right front speakers; you must configure the settings according to the number of the speakers you have added on.

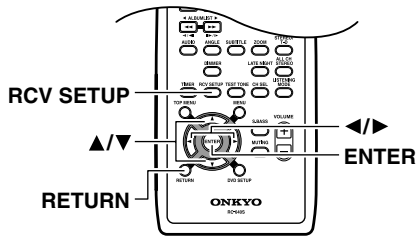

- 1** **Press RCV SETUP.**
The display will show "1.Sp Config".



1.Sp Config
- 2** **Press ENTER.**
The display will show "Subwfr :No".





Subwfr :No
- 3** **Press ◀/▶ to switch "Yes" and "No".**
Yes : Deep bass will be output from a subwoofer.
No : Deep bass will not be output from a subwoofer.
Configure the output setting for a subwoofer to "No" when the output from it is unneeded, even if it is connected.

- 4** **Press ▲/▼ to select "Speaker:".**



- 5** **Press ◀/▶ (repeatedly) to select the number of the connected speakers.**
2ch : Only a left and a right front speakers.
5ch : A center speaker and a left and a right surround speakers in addition to a left and a right front speakers.

- 6** **Press RETURN.**
Returns to the display shown in step 1. Go to "Setting Distance of Speakers" at page 53.



Notes:

- After you have changed the number of the connected speakers, you must configure the number, because the surround effect is subject to change according to the number of the combined speakers.
- If you want to abort the setting, press "RCV SETUP".

Setting Distance of Speakers

Set the distance from the listening position to the speakers.

With the distance set, the DVD receiver can keep constant the time to deliver the sound from each speaker to the listening position, thus providing more comfortable sound environment for movies and music. The settings are stored even when the DVD receiver is in the Standby mode.

7 Press **▼** to select “2.Distance,” and then press **ENTER**.

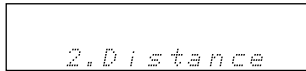

Press **DISPLAY** to switch between feet and meters.



8 Select a speaker using **▲/▼**, and set a distance using **◀/▶**.



You need to set the distance from the listening position to the L/R front speakers. You can set up to 9.0 m (30 ft) by an increment of 0.3 m (1 ft).

The Center and Subwoofer distances can be set between 1.5 m (5 ft) more or less than the Front distance.

The Surround speakers' distances can be set up to 1.5 m (5 ft) more and 4.5 m (15 ft) less than the Front distance.

9 Press **RETURN**.
Returns to the display shown in step 7. Then go to “Speaker Level Calibration”.



Speaker Level Calibration

For adjusting the sound balance, set the sound level for each speaker so that you may hear an equivalent sound volume of the test tone from each speaker.

10 Press **▼** to select “3.Level Cal,” and then press **ENTER**.

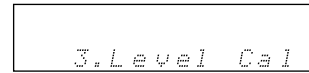

You may hear the burst of noise for the test tone from the left front speaker.

11 Select a speaker using **▲/▼**, and set volume using **◀/▶**.



You can adjust the tone within a range between -12 dB and +12 dB (-15 dB to +12 dB for the subwoofer).

The test tone will be output according to the number of the channels you set for the speakers in the previous page.

- If you set “No” for a subwoofer, the test tone will not be output from it.

Note:

If you have set the sound level greater than as usual, return it by using **VOLUME-** (minus).

12 Press **RETURN**.
Returns to the display shown in step 10. To exit the speaker setting, press it once again. You can also exit the setting by pressing “RCV SETUP”.

Adjusting Speakers with TEST TONE

You can take a shortcut for step 10 to 12 by following the direct steps below.

1 Press **TEST TONE**.
Adjust the sound level with **VOLUME +/-**, if necessary.



2 Switch over the speaker with **CH SEL**, and then adjust the test tone with **◀/▶**.



The test tone will be switched over to the next speaker in 2 seconds, even if you do not press **CH SEL**.

3 Press **TEST TONE**.
That exits the setting.

Enjoying Listening Modes

About the Listening Modes

Listening modes on the DVD receiver enable you to enjoy movie theater or concert hall quality sounds in your room. The DVD receiver provides the following listening modes. Before playing a source in optimal sound, be sure to complete the Speaker settings. (See pages 52-53.)

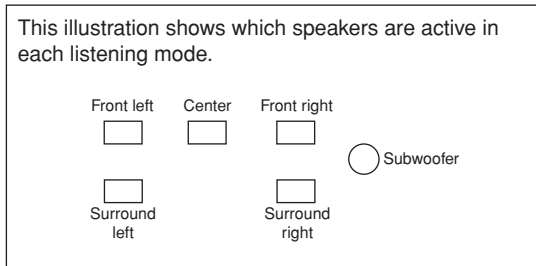

Direct

The selected input source is output directly with minimal processing for a pure sound.

Stereo

The selected input source is processed as a stereo signal and output by the front left and right speakers and the subwoofer if connected.

Mono

Use this mode when watching an old movie with a mono soundtrack, or to select multilingual soundtracks recorded in the left and right channels of some movies. It can also be used when playing a DVD or other source with multiplexed audio, such as a karaoke DVD.

Theater-Dimensional or

You can enjoy a virtual playback for 5.1ch even if you have 2 or 3 speakers.

You can enjoy the following surround modes by adding on a center and surround speakers and setting the correct number of speakers.

Dolby Digital

With this format you can experience the same superb sound that you get at a movie theater or concert hall. Use this mode with DVDs that bear the Dolby Digital logo.



DTS

This digital surround format offers a surround sound experience with exceptional fidelity. It uses compressed digital audio data, with six discrete channels (5.1), and the ability to handle large amounts of audio data while remaining faithful to the original. DTS provides very high-quality sound. You'll need a DTS compatible DVD player in order to enjoy DTS material. Use this mode with DVDs, LDs, or CDs that bear the DTS logo.



Dolby Pro Logic II Movie

Use this mode with DVDs and videos that bear the Dolby Surround logo or TV programs that feature Dolby Surround. You can also use this mode with stereo movies or TV programs and the DVD receiver will create a 5.1 surround mix from the 2-channel stereo.



Dolby Pro Logic II Music

Use this mode to add 5.1 surround to stereo sources such as music CDs and DVDs.

Dolby Pro Logic II Game

Use this mode when playing game discs.

Onkyo Original DSP Modes

Orchestra

Suitable for classical or operatic music. The surround channels are emphasized in order to widen the stereo image. In addition, it simulates the natural reverberation of a large hall.

Unplugged

Suitable for acoustic instrument sounds, vocals, and jazz music. By emphasizing the front stereo image, it simulates the stage-front experience.

Studio-Mix

Suitable for rock and pop music. Listening to music in this mode creates a lively sound field with a powerful acoustic image, like being at a club or rock concert.

TV Logic

Adds realistic acoustics to TV programs produced in a TV studio. In addition, it adds surround effects to the entire sound and adds clarity to voices.

Mono Movie

This mode is suitable for use with old movies and other mono sound sources. The center speaker outputs the sound as it is, while reverb is applied to the sound output by the other speakers, giving presence to even mono material.





All Ch Stereo

Ideal for background music. The front, surround, and surround back channels create a stereo image that fills the entire listening area.

Full Mono

In this mode, all speakers output mono audio, so the music sounds the same regardless of where you are.

Selecting Listening Mode

1		Play back the selected device.
2 DVD receiver Remote controller    		Select a listening mode. Press LISTENING MODE on the DVD receiver or on the remote controller to select a listening mode. Every time you press LISTENING MODE, the mode switches over. The selectable listening mode may vary depending on the playback signal. See the following list for the “Playback Sources and Corresponding Listening Modes”. For front speakers only (2ch): Press LISTENING MODE on the DVD receiver or on the remote controller to switch over Direct, Stereo, Mono and Theater-Dimensional. For center/surround speakers added on (5.1ch): Press LISTENING MODE on the DVD receiver or on the remote controller to switch over a listening mode. Tips: <ul style="list-style-type: none"> You can also switch over Stereo and Theater-Dimensional by pressing STEREO/T-D on the remote controller. If center/surround speakers are added on, you can switch to All Ch St by pressing ALL CH STEREO on the remote controller.

Playback Sources and Corresponding Listening Modes

Minimum required number of speakers	Signal format	Analog, PCM	Dolby D			DTS	Multich
			Monaural	Stereo	Others		
	Source	Cassette, CD, video, tuner	DVD			DVD, LD, CD	DVD-Audio, SACD
	Listening mode						
2 ch	Direct	●	●	●	●	●	●
	Stereo	●	●	●	●	●	
	Mono	●	●	●	●	●	
	Theater-Dimensional*1	●	●	●	●	●	
	Multich						●
If you add on a center speaker and the surround speakers, you can enjoy the following surround mode:							
5 ch	Dolby D				●		
	DTS					●	
	PLII Movie/Music/Game	●		●			
	Mono Movie	●	●	●	●	●	
	Orchestra	●	●	●	●	●	
	Unplugged	●	●	●	●	●	
	Studio-Mix	●	●	●	●	●	
	TV Logic	●	●	●	●	●	
	All Ch St	●	●	●	●	●	
Full Mono	●	●	●	●	●		

*1 You can not select it when using the headphones.

■ Tips for Listening to SACD and DVD Audio in 2ch

When enjoying SACD or DVD-Audio source with any of the 2ch modes is selected for the speaker setting, headphones used, or recording intended, you may improve the sound quality in the following ways:

- For SACD, select “2ch Area” (default setting) from the “Options” settings in the “Initial Setting” menu. (See page 70.)
- For DVD-Audio, select 2ch source whenever it is available.

Adjusting Sound

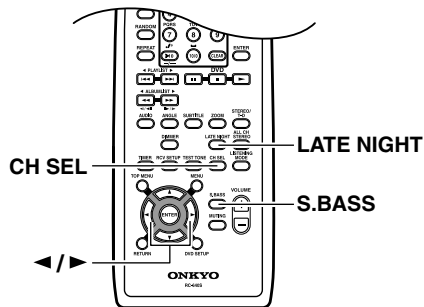

Adjusting Individual Speaker Levels

You can adjust the level of individual speakers during playback.

- These adjustments are temporary and will be cancelled when the DVD receiver is set to Standby.
- You cannot use this function while the DVD receiver is muted.

1



Use CH SEL to select each speaker.

Speakers are selected in the following order: Front Left → Center* → Front Right → Surr Right* → Surr Left* → Subwoofer*.

: appears when a center and surround speakers, and a subwoofer are added on.

2



Use the cursor ◀/▶ to adjust the volume.

You can adjust the volume of each speaker from -12 dB to +12 dB (-15 dB to +12 dB for the subwoofer). The name of the currently selected speaker and its volume appear on the display, as shown.

Left : 0dB

If you want the adjusted value to be stored during the standby mode, press TEST TONE.

Emphasizing the Low End Using the Remote Controller

This is available when the listening mode is set to other than “Direct”.

DVD receiver



Remote controller



Press S.BASS repeatedly.

Pressing S.BASS repeatedly will change the option in the following order.

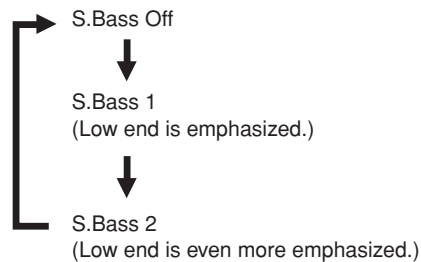

Note:

You may not optimize the effect when you use a subwoofer in combination.

In such cases, you can stress the deep bass by adjusting the volume level of the subwoofer. (See page 53.)

Using the Late Night Function (Dolby Digital only)

With the Late Night function, you can reduce the dynamic range of Dolby Digital material so that you can still hear quiet parts even when listening at low volume levels—ideal for watching movies late at night when you don’t want to disturb anyone.

1



Press the [LATE NIGHT] button repeatedly to select:

- Off:** Late Night function off.
- Low:** Small reduction in dynamic range.
- High:** Big reduction in dynamic range.

Notes:

- The effect of the Late Night function depends on the Dolby Digital material that you are playing, and with some material there will be little or no effect.
- The Late Night function is set to Off when the DVD receiver is set to Standby.

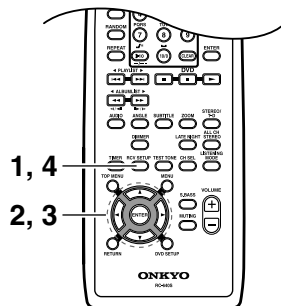

Audio Adjust Function

By using the following audio adjust function, you can fine adjust the tone and the precise settings for Mono, Multiplex and T-D.

1	<p>Press RCV SETUP. The display will show "1.Sp Config".</p>
2	<p>Press ▲/▼ (repeatedly) to select "4.Audio Adj".</p> <p>And then press ENTER.</p>
3	<p>Select an item you want to configure using ▲/▼, and select a value or a preference using ◀/▶.</p>
4	<p>Press RCV SETUP. That exits the setting. To return to a higher step, press RETURN.</p>

The Audio Adjust functions are explained below.

■ Bass

You can boost or cut low-frequency sounds output by the front speakers from -10 dB to +10 dB in 2 dB steps.

You can set a value when the listening mode is set to other than "Direct".

■ Treble

You can boost or cut high-frequency sounds output by the front speakers from -10 dB to +10 dB in 2 dB steps.

You can set a value when the listening mode is set to other than "Direct".

■ Mono (2ch)

This setting specifies the channel to be used for playing any 2-channel digital source such as Dolby Digital, or 2-channel analog/PCM source in the Mono listening mode.

LR: Both the left and right channels are output (default).

L: Only the left channel is output.

R: Only the right channel is output.

■ Multiplex

This setting determines which channel is output from a stereo multiplex source. Use it to select audio channels or languages with multiplex sources, multilingual TV broadcasts, and so on.

M: The main channel is output (default).

S: The sub channel is output.

MS: Both the main and sub channels are output.

■ LstnAngl (Listening Angle)

Select this to modify the Theater-Dimensional (T-D) listening modes.

The listening angle is the angle subtended by the front left and right speakers as seen from the listener. The processing for the virtual surround will be based on this angle. The setting of 20, 30 and 40 degrees are only for nominal purposes, so select the setting that is closest to your actual listening angle.

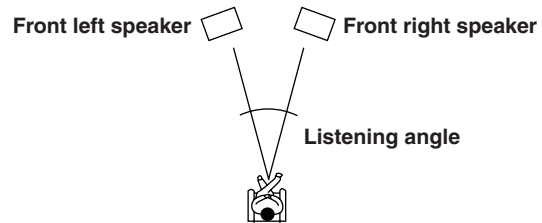

■ T-D mode

This is a setting for 5ch speaker composition with "T-D" (Theater-Dimensional) selected.

You can take advantage of the feature in the case where you have to place the surround speakers in front because of the restricted space availability or for other reason.







ALL: Select this setting when you use surround speakers but they can not be placed in the right place.

FRT: Select this setting in other cases than above.

Setting the Clock

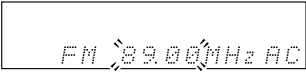
Setting ACCUCLOCK to Use a Specific Station

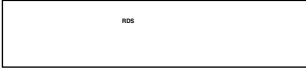
The ACCUCLOCK function normally uses the FM station with the strongest signal to set the clock. If the clock cannot be set properly using that station, you can specify which FM station the ACCUCLOCK function should use. This must be an FM station that supports RDS CT (Clock Time) information.

<p>1</p> 	<p>Press TIMER.</p> <p>“Clock” appears on the display.</p> <p>If the clock has already been set, a timer option appears instead. In this case, you’ll need to press TIMER repeatedly until “Clock” appears.</p>
<p>2</p> 	<p>Press MULTI JOG.</p> <p>“*AccuClock*” or “AccuClock” appears on the display. If “Manual Adjust” appears, turn MULTI JOG to select “*AccuClock*” or “AccuClock”.</p>
<p>3</p> 	<p>Press MULTI JOG.</p> <p>The display appears as shown.</p> 
<p>4</p> 	<p>Use ◀▶ to tune into the FM station.</p> <p>Tip:</p> <p>Pressing YES/MODE toggles the tuning mode between “Auto Tuning” and “Manual Tuning.”</p> <p>The RDS indicator appears when tuned into a station that supports RDS, as shown.</p> 
<p>5</p> 	<p>Press MULTI JOG.</p> <p>While the clock is being set, “Wait” flashes on the display. It may take a few minutes to set the clock. When the clock has been set, the message “Clock Adjusted” scrolls across the display, then the day and time are displayed for a while.</p> <p>Notes:</p> <ul style="list-style-type: none">• If the clock has not been set correctly, the message “No clock signal on RDS” scrolls across the display. Specify another FM station and try again, or set the clock manually (page 59).• If you don’t want the clock to be updated automatically, you can turn off the ACCUCLOCK function (page 25).

Tip:

You can also perform the operation by using the TIMER, ENTER, ◀▶, and MODE buttons on the remote controller.

Setting the Clock Manually

You can select either the 12-hour or 24-hour display. (This section explains how to set the time based on the 24-hour display.)

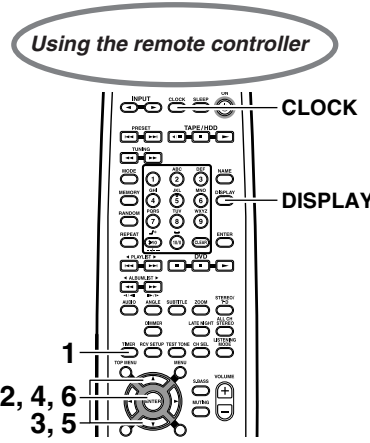
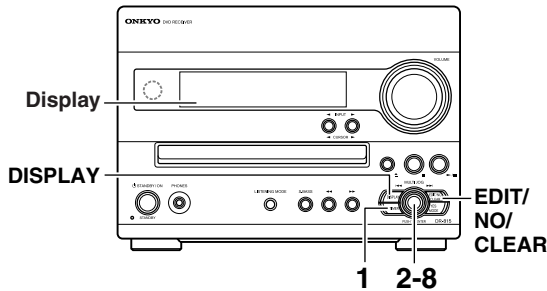

1	<p>Press TIMER repeatedly until “Clock” appears in the display.</p>								
2	<p>Press MULTI JOG.</p>								
3	<p>Turn MULTIJOG to select “ManualAdjust”.</p>								
4	<p>Press MULTI JOG.</p> <p>You can now set the day of the week.</p>								
5	<p>Turn MULTI JOG to select the current day of the week.</p> <table border="0"> <tr> <td>SUN - Sunday</td> <td>THU - Thursday</td> </tr> <tr> <td>MON - Monday</td> <td>FRI - Friday</td> </tr> <tr> <td>TUE - Tuesday</td> <td>SAT - Saturday</td> </tr> <tr> <td>WED - Wednesday</td> <td></td> </tr> </table>	SUN - Sunday	THU - Thursday	MON - Monday	FRI - Friday	TUE - Tuesday	SAT - Saturday	WED - Wednesday	
SUN - Sunday	THU - Thursday								
MON - Monday	FRI - Friday								
TUE - Tuesday	SAT - Saturday								
WED - Wednesday									

6	<p>Press MULTI JOG to confirm the setting.</p> <p>You can now set the time.</p>
7	<p>Turn MULTI JOG to set the current time.</p> <p>You can also use the number buttons on the remote controller.</p> <p>To switch between the am and pm indicators, press the >10 button on the remote controller.</p>
8	<p>Press MULTI JOG to start the clock.</p> <p>You can also use the ENTER button on the remote controller. It can be helpful to synchronize with an accurate time source.</p> <p>The clock starts operating and a dot indicating seconds starts to flash.</p>

To cancel the clock setting
Press **EDIT/NO/CLEAR** on the DVD receiver.

Setting the Clock—*Continued*

Checking the Time and the Day of the Week

To check the time and the day of the week, press CLOCK on the remote controller.

The clock appears for eight seconds in Standby mode.

To Switch between the 12-hour and 24-hour Displays

Press DISPLAY while the current time is indicated on the display.

Turning the Current Time Display On or Off while the Unit is in Standby Mode

First turn on the power to the unit, then press and hold down the STANDBY/ON button on the unit for more than two seconds.

Displaying the current time in Standby mode consumes more power than not displaying the current time.

Using the Timer Functions

The DVD receiver features three timer functions: Sleep, Once, and Every timer.

About the Once and Every Timers

Selecting a timer number

You can set up to four timers.

Timer operation types

- **Timer Play:** The specified component starts playback at the specified time.
- **Timer Rec:** The specified component starts recording at the specified time.

The Timer Rec operation is available for recording on an Onkyo cassette tape deck that features an **RI** connector connected to the DVD receiver. Select the correct input source.

Selecting media for timer operation

You can select any external device equipped with timer, including AM/FM tuner, DVD (only with disc loaded in the tray) and Onkyo cassette tape deck linked to the DVD receiver. (You must set the devices so that the component name is displayed correctly on the DVD receiver.)

For the Timer Rec operation, you can select AM, FM, or an external component that is connected to the LINE connector and features the Timer function.

Selecting the day(s) of the week

The Once timer operates only one time. The Every timer operates at the specified time on the specified day(s) of every week. For the Every timer, you can select any consecutive days of the week, such as everyday, every Monday through Friday, or every Saturday and Sunday.

i.e.,

- Timer 1: Used as an alarm clock every morning.
Timer Play — Every — Everyday — 7:00-7:30
- Timer 2: Records a radio program every week.
Timer Rec — Every — MON - SAT — 15:10-15:30
- Timer 3: Records a radio program only this Sunday.
Timer Rec — Once — SUN — 10:00-12:00

Notes:

- You cannot change the clock or the end time of the timer operation during Timer playback or recording.
- You cannot use the Timer function unless the clock is set. Be sure to set the clock first.
- If you program a timer on a connected external component, be sure to connect the component correctly and securely. You cannot use timer playback or recording with incomplete connection.
- During the Timer Rec operation, the muting function is activated and the audio level is minimized. To listen to the audio being recorded, press **MUTING** on the remote controller.

Timer indicators



If any of the timers is set, the **TIMER** indicator lights up. If a number indicator is lit, the corresponding timer has been programmed. If the number indicator is inside a square, the Timer Rec operation is programmed.

If the programmed time overlaps with another timer setting

- The timer with the earlier On time is enabled.
- If both timers start at the same time, the timer with the lower number is enabled.

Timer 1 9:00 - 10:00

Timer 2 8:00 - 10:00

↑ This timer (with the earlier On time) is enabled.

Timer 3 12:00 - 13:00

↑ This timer (with the lower number) is enabled.

Timer 4 12:00 - 12:30

Using the Timer Functions—Continued

Using the Sleep Timer

Using the remote controller

The Sleep timer can be set for 10 to 90 minutes, in intervals of 10 minutes.

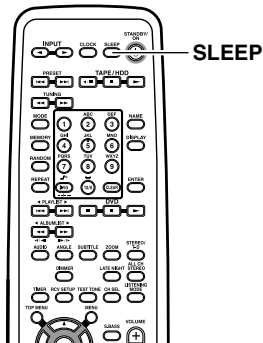

Using the unit

You can set the Sleep timer for 10 to 90 minutes, in intervals of 10 minutes. It is also possible to set the timer from 1 to 99 in one-minute increments is also possible using MULTI JOG.

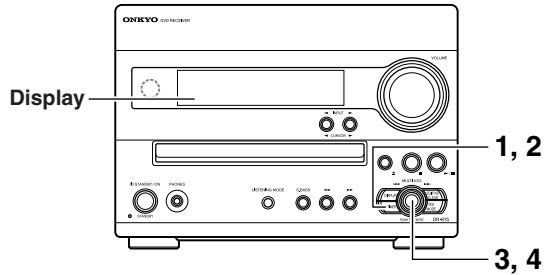

Press SLEEP.

“Sleep 90” appears in the display, indicating the unit will turn off in 90 minutes. Each press of the same button reduces the remaining time by 10 minutes.

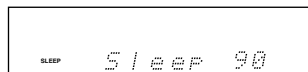

Press cursor ▲/▼ if you wish to set the remaining time in one-minute increments.

If you have finished the sleep time setting, press ENTER.

Checking the Remaining Time

Press SLEEP while the Sleep timer is on. If you press SLEEP while the remaining time is displayed, the remaining time is reduced by 10 minutes.

Canceling Sleep Timer

Press SLEEP repeatedly until “Sleep Off” appears in the display.

1



Press and hold TIMER for more than 1 second.

“Sleep 90” appears in the display window. The unit will turn off in 90 minutes.

2



Press TIMER if you wish to reduce the remaining time.

Each press reduces the remaining time by ten minutes:
90→80→...→10→off.



3



Turn MULTI JOG if you wish to set the remaining time in one-minute increments.

Turn MULTI JOG clockwise to increase the remaining time by up to 99 minutes, or counterclockwise to decrease the remaining time to one minute.

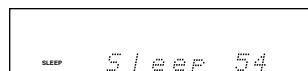

4



Press MULTI JOG.

The Sleep timer starts operating.
The SLEEP indicator lights.

Programming a Once / Every Timer

Before programming a timer for an AM/FM broadcast, program the desired broadcast stations to the preset channels. (See pages 44-45.)

Notes:

- You cannot use the timer functions unless the clock is set.
- If you do not operate the buttons for 60 seconds during the timer setting, the unit returns to its normal display.

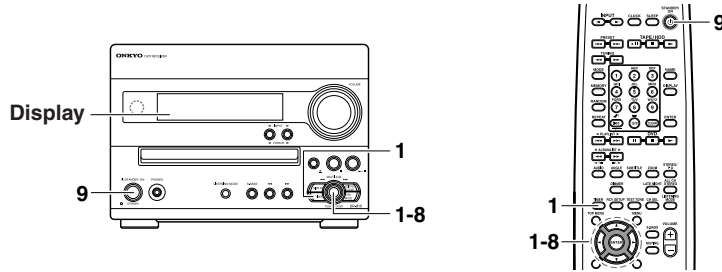

<p>1 DVD receiver</p>	<p>Repeatedly press TIMER to select the desired timer number. Select from Timer 1 to 4, then press MULTI JOG.</p> <div style="border: 1px solid black; padding: 5px; text-align: center;">Timer 1</div> <p>If only "Clock" is displayed, the day of the week and time have not been set. Set the day of the week and time.</p>
<p>2 DVD receiver</p>	<p>Turn MULTI JOG to select Timer Play or Timer Rec. When the desired timer operation is displayed, press MULTI JOG. The Timer Rec operation is performed on a connected tape deck. During recording, the muting function is activated.</p> <p>Note: When the selector name of TAPE is set to other than TAPE, you can not select TIMER recording.</p> <div style="border: 1px solid black; padding: 5px; text-align: center;">Play</div> <p style="text-align: center;">or</p> <div style="border: 1px solid black; padding: 5px; text-align: center;">Rec</div>
<p>3 DVD receiver</p>	<p>Turn MULTI JOG to select the source. When the desired source is displayed, press MULTI JOG. For the Timer Rec operation, you can select from FM, AM or LINE.</p> <p>FM/AM is selected</p> <p>Turn MULTI JOG to select the preset number. When the desired preset number is displayed, press MULTI JOG.</p> <div style="border: 1px solid black; padding: 5px; text-align: center;">F M</div> <div style="border: 1px solid black; padding: 5px; text-align: center;">FM 87.50MHz</div>

Using the Timer Functions—Continued

4 DVD receiver



Remote controller



Press **MULTI JOG**.

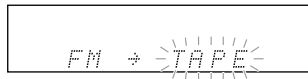

(Only for Timer Rec)

Check connections and settings to the recording component.

5 DVD receiver



Remote controller



Turn **MULTI JOG** to select “Once” or “Every”.

The Once timer operates only one time. The Every timer operates every week.

After selecting, press **MULTI JOG**.



If you selected “Once,” the timer operates only one time on the specified day.

Turn **MULTI JOG** to select the day(s) of the week.

When the desired day of the week is displayed, press **MULTI JOG**.



If you selected “Every,” the timer operates on the specified day(s) of every week.

Turn **MULTI JOG** to select the day(s) of the week.

When the desired day of the week is displayed, press **MULTI JOG**.

MON ⇔ TUE ⇔ WED ⇔ THU ⇔ FRI



SUN ⇔ Days Set ⇔ Everyday ⇔ SAT

Days Set (You can specify the range of days.)

If you selected “Days Set,” you can select any consecutive days of the week.

1. Turn MULTI JOG to select the first day.

When the desired day of the week is displayed, press **MULTI JOG**.



2. Turn MULTI JOG to select the last day.

When the desired day of the week is displayed, press **MULTI JOG**.

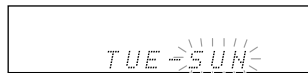

In this example, the timer operation is activated at the specified time, every Tuesday through Sunday.

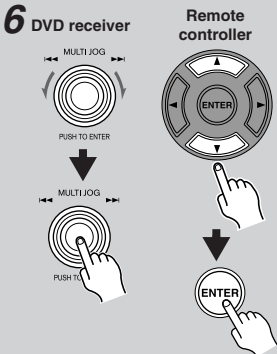
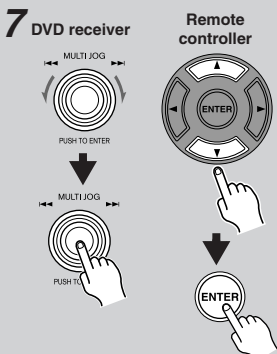
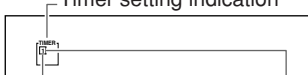
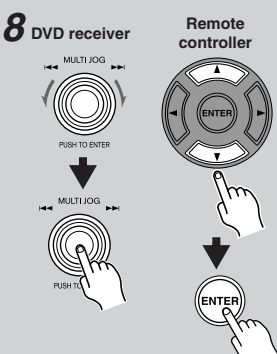
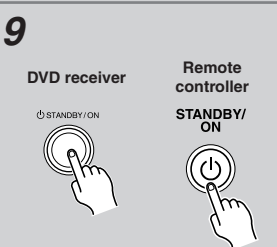
<p>6 DVD receiver</p> 	<p>Turn MULTI JOG to set the On time of the timer operation. You can also use the number buttons on the remote controller. When the desired time is displayed, press MULTI JOG.</p> <div style="border: 1px solid black; padding: 5px; text-align: center; width: fit-content; margin: 10px auto;"> On 7:29 </div> <p>For example, to set 7:29, press 10/0, 7, 2, then 9.</p> <p>Notes:</p> <ul style="list-style-type: none"> • When you set the On time, the Off time is automatically set to one hour later. • During timer recording, the first few seconds may not be recorded. Set the On time to one minute earlier.
<p>7 DVD receiver</p> 	<p>Turn MULTI JOG to set the Off time for the timer operation. When the desired time is displayed, press MULTI JOG.</p> <div style="border: 1px solid black; padding: 5px; text-align: center; width: fit-content; margin: 10px auto;"> Off 8:29 </div> <p style="text-align: center;">↓ Timer setting indication</p> <div style="border: 1px solid black; padding: 5px; width: fit-content; margin: 10px auto;">  </div> <p>A square appears if the Timer Rec operation is programmed. Selected timer number</p>
<p>8 DVD receiver</p> 	<p>Turn MULTI JOG to set the volume. (Only for Timer Play) The default value for the volume is 25. After selecting the desired volume, press MULTI JOG to confirm the current value.</p> <div style="border: 1px solid black; padding: 5px; text-align: center; width: fit-content; margin: 10px auto;"> TimerVol. 25 </div>
<p>9</p> <p>DVD receiver</p> 	<p>Place the unit in Standby mode. Press STANDBY/ON to place the unit in Standby mode.</p> <p>Notes:</p> <ul style="list-style-type: none"> • Even if you set Memory or Random mode for timer playback, the DVD receiver will perform normal playback at the timer On time. • If the unit is not in Standby mode, the programmed timer operation will not start at the timer on time. Be sure to place the unit in Standby mode to activate timer operation. • If you try to set the Sleep timer or press TIMER during timer operation, the current timer setting is cancelled. • During the Timer Rec operation, the muting function is activated and the audio level is minimized. To listen to the audio being recorded, press MUTING on the remote controller.



To reprogram the timers, press EDIT/NO/CLEAR and follow the procedure from the beginning.

Using the Timer Functions—Continued

Switching the Timer On and Off

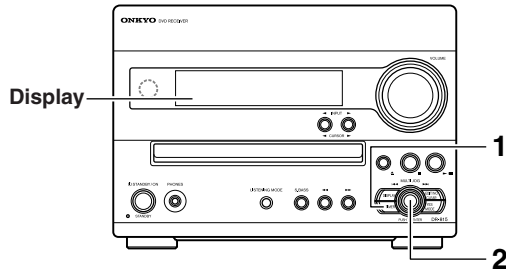
- You can use this function to cancel or resume the programmed timer operation.
- You cannot program the timers unless the clock is set.







1 	<p>Repeatedly press TIMER to display the desired timer number.</p> <div style="border: 1px solid black; padding: 5px; text-align: center; width: fit-content; margin: 10px auto;">Timer 1</div> <p>If the timer number is lit, the corresponding timer has been programmed.</p>
2 	<p>Turn MULTI JOG to switch the timer on or off.</p> <div style="border: 1px solid black; padding: 5px; text-align: center; width: fit-content; margin: 10px auto;">  Timer On </div> <p style="text-align: center;">or</p> <div style="border: 1px solid black; padding: 5px; text-align: center; width: fit-content; margin: 10px auto;">Timer Off</div> <p>After the timer is switched on or off, the unit displays the previous screen.</p>

Tip:

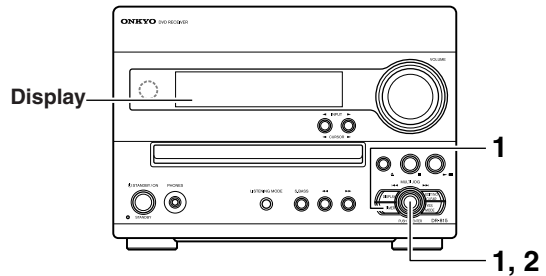
You can also perform the operation by using the TIMER and cursor ▲/▼ on the remote controller.

Viewing the Timer Settings



1 	<p>Repeatedly press TIMER to display the desired timer number, then press MULTI JOG.</p> <div style="border: 1px solid black; padding: 5px; text-align: center; width: fit-content; margin: 10px auto;">Timer 1</div>
2 	<p>Press MULTI JOG to view the subsequent timer settings.</p> <div style="border: 1px solid black; padding: 5px; text-align: center; width: fit-content; margin: 10px auto;">  </div> <p>Repeatedly pressing MULTI JOG enables you to view the subsequent settings.</p> <p>Notes:</p> <ul style="list-style-type: none"> • You can change the settings by turning MULTI JOG. • If the timer is turned off and you change the settings, the timer is automatically turned on. <p>Check all the settings. If you do not change any settings, the unit returns to the previous display. To return to the normal display, press EDIT/NO/CLEAR.</p>

Tip:

You can also perform the operation by using the TIMER, cursor ▲/▼ and ENTER on the remote controller.

Initial Settings menu

Using the Initial Settings menu

The Initial Settings menu provides audio and video output settings, parental lock settings, and display settings, among others.

If an option is grayed out it means that it cannot be changed at the current time. This is usually because a disc is playing. Stop the disc, then change the setting.

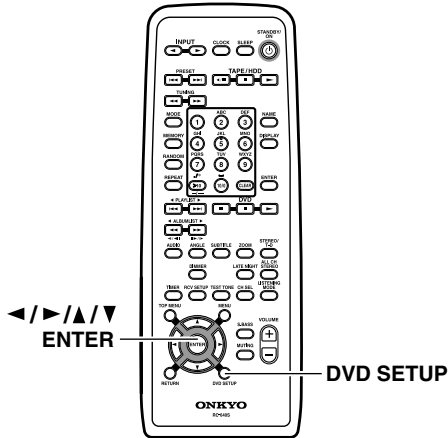

1



Press **DVD SETUP** and select “Initial Settings”.

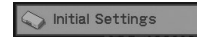

2

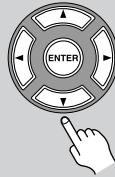

Use the cursor buttons and **ENTER** to select the setting and option you want to set.

All the settings and options are explained on the following pages.

Notes:

- In the following table, the default setting is shown in bold: other settings are shown in italics.
- Check the operating instructions supplied with your other equipment to see which digital audio formats it's compatible with.
- Some settings, such as TV Screen, Audio Language and Subtitle Language may be overridden by the DVD disc. Often these settings can also be made from the DVD disc menu.

Video Output settings

Setting	Option	What it means
TV Screen (See also “Screen sizes and disc formats” on page 73.)	4:3 (Letter Box)	Set if you have a conventional 4:3 TV. Widescreen movies are shown with black bars top and bottom.
	4:3 (Pan & Scan)	Set if you have a conventional 4:3 TV. Widescreen movies are shown with the sides cropped so that the image fills the screen.
	16:9 (Wide)	Set if you have a widescreen TV.
AV Connector Out	Video	Ordinary (composite) video output. Compatible with all TVs.
	S-Video	Almost the same quality as RGB, but can give better results if you're using a long SCART cable.
	RGB	If your TV is compatible, this gives the best picture quality.

Language settings

Setting	Option	What it means
Audio Language ^{*1}	English	If there is an English soundtrack on the disc then it will be played.
	Languages as displayed	If there is the language selected on the disc, then it will be played.
	Other Language	Select to choose a language other than the ones displayed (see page 74).
Subtitle Language ^{*2}	English	If there are English subtitles on the disc then they will be displayed.
	Languages as displayed	If there is the subtitle language selected on the disc, then it will be displayed.
	Other Language	Select to choose a language other than the ones displayed (see page 74).
DVD Menu Lang. ^{*3}	w/Subtitle Lang.	DVD disc menus will be displayed in the same language as your selected subtitle language, if possible.
	Languages as displayed	DVD disc menus will be displayed in the selected language, if possible.
	Other Language	Select to choose a language other than the ones displayed (see page 74).
Subtitle Display	On	Subtitles are displayed according to your selected subtitle language (see above).
	Off	Subtitles are always off by default when you play a DVD disc (note that some discs override this setting).

*1 This setting is your preferred audio language for DVD discs.

You can switch between the languages recorded on a DVD disc during playback using the AUDIO button.

Some DVD discs set the audio language automatically when loaded, overriding the “Audio Language” setting.

Discs with two or more audio languages usually allow you to select the audio language from the disc menu. Press MENU to access the disc menu.

*2 This setting is your preferred subtitle language for DVD discs.

You can change or switch off the subtitles on a DVD disc during playback using the SUBTITLE button.

Some DVD discs set the subtitle language automatically when loaded, overriding the “Subtitle Language” setting.

Discs with two or more subtitle languages usually allow you to select the subtitle language from the disc menu. Press MENU to access the disc menu.

*3 Some multilingual discs have disc menus in several languages. This setting specifies in which language the disc menus should appear. Leave on the default setting for menus to appear in the same language as your “Subtitle Language”.

Initial Settings menu—Continued

Display settings

Setting	Option	What it means
OSD Language	English	On-screen displays of the player are in English.
	Languages as displayed	On-screen displays are shown in the language selected.
Angle Indicator	On	A camera icon is displayed on-screen during multi-angle scenes on a DVD disc.
	Off	No multi-angle indication is shown.

Options settings

Setting	Option	What it means
Parental Lock	–	See “How to Use Parental Lock” on page 71.
DVD Playback Mode	DVD-Audio	All material on a DVD-Audio disc is playable.
	DVD-Video	Only the DVD-Video part of a DVD-Audio disc is playable.
SACD Playback	2ch Area	Selects the 2 channel (stereo) SACD audio area of the disc for playback.
	Multi-ch Area	Selects the multi-channel SACD audio area of the disc for playback.
	CD Area	Selects the standard CD audio area of an SACD/CD hybrid disc for playback.

How to Use Parental Lock

- Default level: Off; Default password: none; Default Country code: us (2119)

To give you some control over what your children watch on your DVD receiver, some DVD-Video discs feature a Parental Lock level. If your player is set to a lower level than the disc, the disc won't play.

Some discs also support the Country Code feature. The player does not play certain scenes on these discs, depending on the Country Code you set.

Notes:

- Not all discs use Parental Lock, and will play without requiring the password first.
- If you forget your password, you'll need to reset the player to register a new password. (See page 74.)

Registering a new password

You must register a password before you can change the Parental Lock level or enter a Country code.

- 1** Select "Password".

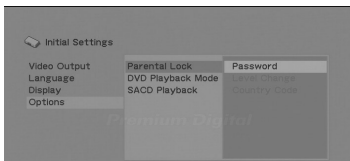
- 2** Use the number buttons to enter a 4-digit password. The numbers you enter show up as asterisks (*) on-screen.

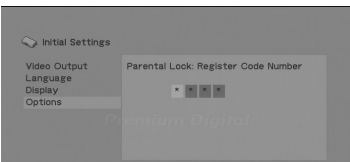

- 3** Press ENTER to register the password. You will return to the Options menu screen.



Changing your password

To change your password, confirm your existing password then enter a new one.

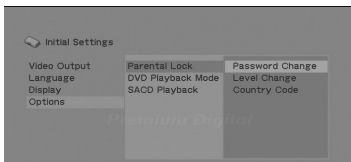
- 1** Select "Password Change".

- 2** Use the number buttons to enter your existing password, then press ENTER.
- 3** Enter a new password and press ENTER.

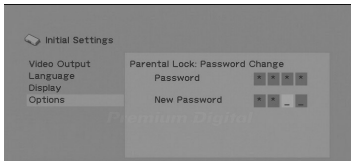



This registers the new password and you will return to the Options menu screen.

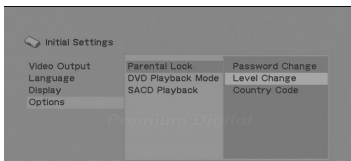

Setting/changing the Parental Lock

- 1** Select "Level Change".

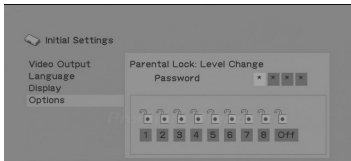
- 2** Use number buttons to enter your password, then press ENTER.

Initial Settings menu—Continued

3

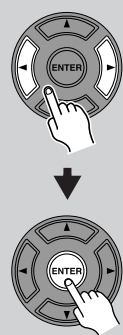

Select a new level and press ENTER.

- Press ◀ (cursor left) repeatedly to lock more levels (more discs will require the password); press ▶ (cursor right) to unlock levels. You can't lock level 1.

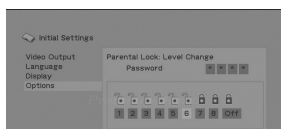

This sets the new level and you will return to the Options menu screen.

Setting/changing the Country code

You can find the Country code list in the adjacent column.

1

Select "Country Code".

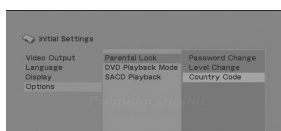

2

Use number buttons to enter your password, then press ENTER.

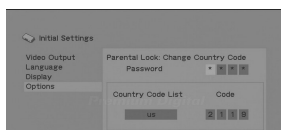

3

Select a Country code and press ENTER.

There are two ways you can do this:

- Select by code letter: Use ▲/▼ (cursor up/down) to change the Country code.
- Select by code number: Press ▶ (cursor right) then use the number buttons to enter the 4-digit Country code.



The new Country code is set and you will return to the Options menu screen. Note that the new Country code doesn't take effect until the next disc is loaded (or the current disc is reloaded).

Country code list

Country	Country code	Country code letter
Argentina	0118	ar
Australia	0121	au
Austria	0120	at
Belgium	0205	be
Brazil	0218	br
Canada	0301	ca
Chile	0312	cl
China	0314	cn
Denmark	0411	dk
Finland	0609	fi
France	0618	fr
Germany	0405	de
Hong Kong	0811	hk
India	0914	in
Indonesia	0904	id
Italy	0920	it
Japan	1016	jp
Korea, Republic of	1118	kr
Malaysia	1325	my
Mexico	1324	mx
Netherlands	1412	nl
New Zealand	1426	nz
Norway	1415	no
Pakistan	1611	pk
Philippines	1608	ph
Portugal	1620	pt
Russian Federation	1821	ru
Singapore	1907	sg
Spain	0519	es
Sweden	1905	se
Switzerland	0308	ch
Taiwan	2023	tw
Thailand	2008	th
United Kingdom	0702	gb
USA	2119	us

Additional information

Screen sizes and disc formats

DVD-Video discs come in several different screen aspect ratios, ranging from TV programs, which are generally 4:3, to Cinema- Scope widescreen movies, with an aspect ratio of up to about 7:3.

Televisions, too, come in different aspect ratios; “standard” 4:3 and widescreen 16:9.

Widescreen TV users

If you have a widescreen TV, the TV Screen setting (page 68) of this player should be set to “16:9 (Wide)”. When you watch discs recorded in 4:3 format, you can use the TV controls to select how the picture is presented. Your TV may offer various zoom and stretch options; see the instructions that came with your TV for details.

Please note that some movie aspect ratios are wider than 16:9, so even though you have a widescreen TV, these discs will still play in a “letter box” style with black bars at the top and bottom of the screen.

Standard TV users

If you have a standard TV, the “TV Screen” setting (page 68) of this player should be set to “4:3 (Letter Box)” or “4:3 (Pan&Scan),” depending on which you prefer.

Set to “4:3 (Letter Box),” widescreen discs are shown with black bars top and bottom.



Set to “4:3 (Pan&Scan),” widescreen discs are shown with the left and right sides cropped.

Although the picture looks larger, you don’t actually see the whole picture.



Please note that many widescreen discs override the player’s settings so that the disc is shown in letter box format regardless of the setting.

Note:

Using the “16:9 (Wide)” setting with a standard 4:3 TV, or either of the “4:3” settings with a widescreen TV, will result in a distorted picture.

Setting the TV system

The default setting of this player is Auto, and unless you notice that the picture is distorted when playing some discs, you should leave it set to Auto. If you experience picture distortion with some discs, set the TV system to match your country or region’s system. Doing this, however, may restrict the kinds of disc you can watch. The table below shows what kinds of disc are compatible with each setting (Auto, PAL and NTSC).

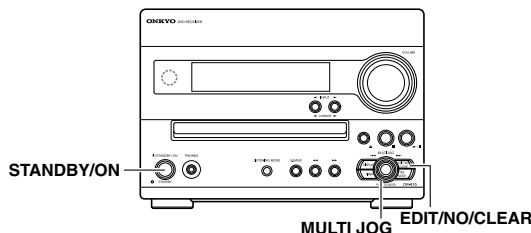

- 1 **Stop DVD playback.**
You can operate the control even when no disc is loaded.
- 2 **Press EDIT/NO/CLEAR.**
- 3 **Rotate MULTI JOG to select “TV System?”.**
- 4 **Press MULTI JOG.**

You will see the message “Waiting”. Then wait for a moment until initial display appears. And then you will see a new setting displayed. If the previous setting was either “Auto”, “NTSC” or “PAL”, it will be changed to “NTSC”, “PAL” or “Auto” respectively. The TV system changes as follows:

- Auto → NTSC
- NTSC → PAL
- PAL → Auto

Note:

You have to switch the player into standby (press STANDBY/ON) before each change.

Disc		Player setting		
Type	Format	NTSC	PAL	AUTO
DVD/ Super VCD	NTSC	NTSC	PAL	NTSC
	PAL	NTSC	PAL	PAL
Video CD	NTSC	NTSC	PAL	NTSC
	PAL	NTSC	PAL	PAL
CD/SACD no disc	–	NTSC	PAL	NTSC or PAL

Additional information—Continued

Resetting the DVD player

Use this procedure to reset all the player's settings to the factory default.

- 1 Stop DVD playback or unload any disc from the tray.
- 2 Press EDIT/NO/CLEAR.
- 3 Rotate MULTI JOG to select "DVD Init?".
- 4 Press MULTI JOG.
- 5 The "DVD Init??" message appears once again, then press MULTI JOG again. You will see the message "Waiting". The initial setting completes when you see the original display come back.

Titles, chapters and tracks

DVD discs are generally divided into one or more titles. Titles may be further subdivided into chapters.

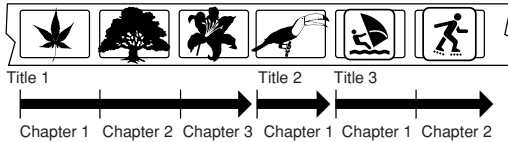

SACDs, CDs and Video CDs are divided into tracks.

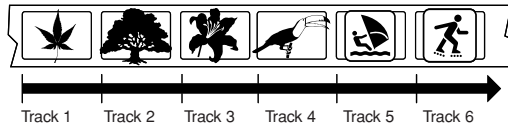

CD-ROMs contain folders and files. MP3 and WMA files are referred to as tracks. Folders may contain further folders.

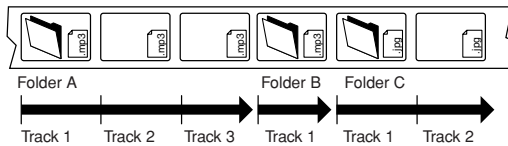

DVD-Video regions

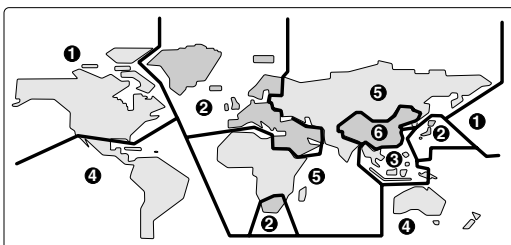

All DVD-Video discs carry a region mark on the case somewhere that indicates which region(s) of the world the disc is compatible with. Your DVD receiver also has a region mark, which you can find on the rear panel. Discs from incompatible regions will not play in this player. Discs marked "ALL" will play in any player. The diagram below shows the various DVD regions of the world.

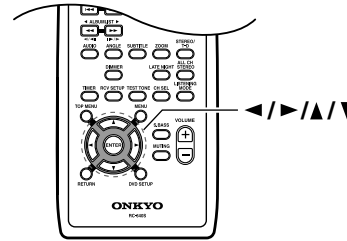

Selecting languages using the language code list

Some of the language options (such as "DVD Language" in the Setup Navigator) allow you to set your preferred language from any of the 136 languages listed in the language code list on page 75.



- 1 Select "Other Language".
- 2 Use ◀/▶ (cursor left/right) to select either a code letter or a code number.

- 3 Use ▲/▼ (cursor up/down) to select a code letter or a code number.
See "Language code list" on page 75 for a complete list of languages and codes.

Additional information—Continued

■ Language code list

Language	Language code letter	Language code
Japanese	ja	1001
English	en	0514
French	fr	0618
German	de	0405
Italian	it	0920
Spanish	es	0519
Chinese	zh	2608
Dutch	nl	1412
Portuguese	pt	1620
Swedish	sv	1922
Russian	ru	1821
Korean	ko	1115
Greek	el	0512
Afar	aa	0101
Abkhazian	ab	0102
Afrikaans	af	0106
Amharic	am	0113
Arabic	ar	0118
Assamese	as	0119
Aymara	ay	0125
Azerbaijani	az	0126
Bashkir	ba	0201
Byelorussian	be	0205
Bulgarian	bg	0207
Bihari	bh	0208
Bislama	bi	0209
Bengali	bn	0214
Tibetan	bo	0215
Breton	br	0218
Catalan	ca	0301
Corsican	co	0315
Czech	cs	0319
Welsh	cy	0325
Danish	da	0401
Bhutani	dz	0426
Esperanto	eo	0515
Estonian	et	0520
Basque	eu	0521
Persian	fa	0601
Finnish	fi	0609
Fiji	fj	0610
Faroese	fo	0615
Frisian	fy	0625
Irish	ga	0701
Scots-Gaelic	gd	0704
Galician	gl	0712
Guarani	gn	0714
Gujarati	gu	0721
Hausa	ha	0801
Hindi	hi	0809
Croatian	hr	0818
Hungarian	hu	0821

Language	Language code letter	Language code
Armenian	hy	0825
Interlingua	ia	0901
Interlingue	ie	0905
Inupiak	ik	0911
Indonesian	in	0914
Icelandic	is	0919
Hebrew	iw	0923
Yiddish	ji	1009
Javanese	jw	1023
Georgian	ka	1101
Kazakh	kk	1111
Greenlandic	kl	1112
Cambodian	km	1113
Kannada	kn	1114
Kashmiri	ks	1119
Kurdish	ku	1121
Kirghiz	ky	1125
Latin	la	1201
Lingala	ln	1214
Laothian	lo	1215
Lithuanian	lt	1220
Latvian	lv	1222
Malagasy	mg	1307
Maori	mi	1309
Macedonian	mk	1311
Malayalam	ml	1312
Mongolian	mn	1314
Moldavian	mo	1315
Marathi	mr	1318
Malay	ms	1319
Maltese	mt	1320
Burmese	my	1325
Nauru	na	1401
Nepali	ne	1405
Norwegian	no	1415
Occitan	oc	1503
Oromo	om	1513
Oriya	or	1518
Panjabi	pa	1601
Polish	pl	1612
Pashto, Push to	ps	1619
Quechua	qu	1721
Rhaeto-Romance	rm	1813
Kirundi	rn	1814
Romanian	ro	1815
Kinyarwanda	rw	1823
Sanskrit	sa	1901
Sindhi	sd	1904
Sangho	sg	1907
Serbo-Croatian	sh	1908
Sinhalese	si	1909

Language	Language code letter	Language code
Slovak	sk	1911
Slovenian	sl	1912
Samoan	sm	1913
Shona	sn	1914
Somali	so	1915
Albanian	sq	1917
Serbian	sr	1918
Siswati	ss	1919
Sesotho	st	1920
Sundanese	su	1921
Swahili	sw	1923
Tamil	ta	2001
Telugu	te	2005
Tajik	tg	2007
Thai	th	2008
Tigrinya	ti	2009
Turkmen	tk	2011
Tagalog	tl	2012
Setswana	tn	2014
Tonga	to	2015
Turkish	tr	2018
Tsonga	ts	2019
Tatar	tt	2020
Twi	tw	2023
Ukrainian	uk	2111
Urdu	ur	2118
Uzbek	uz	2126
Vietnamese	vi	2209
Volapük	vo	2215
Wolof	wo	2315
Xhosa	xh	2408
Yoruba	yo	2515
Zulu	zu	2621

Input Source Names and Available Buttons on Remote Controller

If you customized source names using the method described on page 28, you can use the following buttons:

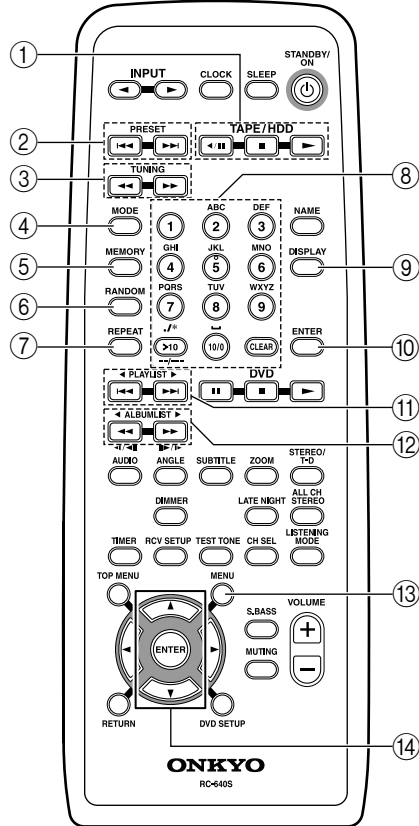

Input Source Names and Available Buttons on Remote Controller—Continued

Connecting Terminal		TAPE / HDD		
Selector Name		TAPE	HDD	CD-R
Buttons on the remote controller				
①	TAPE/HDD ►	►	►	►
	TAPE/HDD ■	■	■	■
	TAPE/HDD ◀/	◀		
②	PRESET ◀◀/▶▶	FF/FR ◀◀/▶▶	SKIP ◀◀/▶▶	SKIP ◀◀/▶▶
③	TUNING ◀◀/▶▶		◀◀/▶▶	◀◀/▶▶
④	MODE	DOLBY NR		MODE
⑤	MEMORY			MEMORY
⑥	RANDOM		SHUFFLE	RANDOM
⑦	REPEAT	REV MODE	REPEAT	REPEAT
⑧	1-9			1-9
	10/0			10/0
	>10			>10
	CLEAR			CLEAR
⑨	DISPLAY		BACK LIGHT	DISPLAY
⑩	ENTER		SELECT	ENTER
⑪	PLAYLIST ◀◀/▶▶		◀ PLAYLIST ▶	
⑫	ALBUMLIST ◀◀/▶▶		◀ ALBUM ▶	
⑬	MENU		MENU	
⑭	▲		▲	
	▼		▼	
	ENTER		SELECT	ENTER

Recording

The copyright laws prohibit using your recordings without consent of the copyright owner, except for the purpose of your personal entertainment.

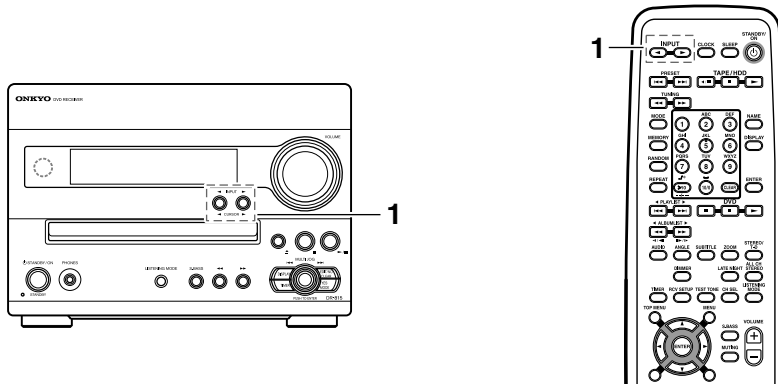

1

DVD receiver

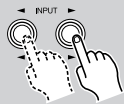

Remote controller

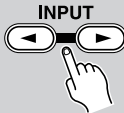

Press **INPUT** on the DVD receiver or the remote controller to select the recording source component.

2

Prepare the recording component.

- Place the recording component in record standby mode.
- Adjust the recording level on the recording component.

3

Start recording.

- Start playing the source component selected in Step 1.

Notes:

- Do not change the input selection during recording. Otherwise, the recording cannot be made correctly.
- Set the input source (page 28) to perform Synchro recording, or other system recording using Onkyo components that feature the **RI** connector.
- Select **STEREO** for the listening mode, when you record in analog form the signals from the built-in DVD.
- The recording level differs depending on the individual sources; you should adjust the level on the recording device.

Troubleshooting

Problems may be caused by any component connected to this unit. Please check the table below, cross-referencing the instruction manuals for the other components.

Power

The power to the system is not turned on.

- Make sure that the power cable is plugged into the AC outlet.
- Unplug the power cable from the AC outlet, wait for 10 seconds or more, then plug the cable in again.

The power is turned off during the operation.

- If the SLEEP indicator is lit on the display, the Sleep timer is functioning. Cancel the Sleep timer. (See page 62.)
- The DVD receiver enters Standby mode after the timer playback or recording is complete. (See page 65.)
- If the STANDBY indicator is blinking on and off, the built-in protection circuit is activated. Be careful not to short the positive and negative wires.

The DVD receiver turns itself on unexpectedly.

- The ACCUCLOCK function is updating the clock. This is not a malfunction. You can turn off ACCUCLOCK. (See page 25.)

Audio

The sound is not heard.

- Make sure the power cable is plugged into an AC outlet.
- Make sure that the speakers are connected correctly and the speaker cables' core wires touch only the speaker connectors. (See page 18.)
- Check to make sure that the volume level is not set to minimum. (See page 26.)
- Make sure that the input source is properly selected.
- Check to make sure the muting function is not engaged.
If the MUTING indicator is flashing, the sound is muted. Cancel the muting function. (See page 27.)
- When the headphones are connected, the speakers do not output any sound. Disconnect the headphones. (See page 27.)

Sound is not good.

- Make sure that the speaker cords are connected correctly. Check their polarity (+/-). (See page 18.)
- Connect the analog audio cables (RCA) firmly. (See page 19.)
- Sound quality could be affected by a strong magnetic field, such as a TV set. Locate such a device far from the DVD receiver.
- If you have any devices that emit high intensity radio waves near the DVD receiver, such as a cellular phone in operation (calling), noise may be generated.

- The DVD receiver uses a rotating unit whose precision instrument generates faint hissing sound while reading a disc during playing back or searching a track; you may hear it in a silent environment.

Sound breaks off due to vibration.

- The DVD receiver is designed for use as stationary type; place it in a location with limited influence of vibration.

Headphones makes noise or no sound.

- There may be a bad contact. Clean up the headphones terminal. For information on how to clean up, see the instruction manual attached to the headphones. Otherwise, verify the cord of the headphones which may be broken.

Sound Quality

- The sound quality becomes stable when 10 to 30 minutes have passed after the power was turned on. Using cable ties to bundle audio cables with speaker cables may degrade the audio performance, so don't do it.

Disc Playback

The disc won't play or is automatically ejected after loading.

- Make sure the disc is free from dirt and dust and is not damaged. (See page 9.)
- Make sure the disc is loaded with the label side face-up and aligned properly in the disc tray guide.
- Incompatible region number: If the region number on a DVD-Video disc does not match the number on the player, the disc cannot be used. (See page 74.)
- Condensation inside the player: Allow time for condensation to evaporate. Avoid using the player near an air-conditioning unit.
- If the Parental Lock function is active, defeat it or change the level. (See page 71.)

The disc doesn't play in the correct order

- Defeat special playback modes such as Repeat Play, Memory Playback, and Random Playback. (See pages 38-40.)

DVD-Audio playback stops.

- The disc may have been illegally copied.

Track numbers cannot be stored when setting MEMORY playback.

- Make sure that the disc has been loaded, and the track(s) you try to program are included on the disc.

It takes a long time until playback starts.

- It may take time for the DVD receiver to load and read a CD that contains many tracks.

Troubleshooting—Continued

New settings made in the Setup screen menus while a disc is playing are ineffective.

- Some settings can be changed while a disc is playing, but are not effective until the disc is stopped then restarted: Press **■**, then start playback again (**▶**).

No picture/No color.

- Incorrect video connections: Check that connections are correct and that plugs are inserted fully. Also check the video cable for damage.
- TV/monitor or AV amplifier settings are incorrect: Check the instruction manual of the connected equipment.

Screen is stretched or aspect does not change.

- The TV Screen setting in the Initial Settings menu is incorrect. See page 68 for how to set it correctly for your TV/monitor.

Picture disturbance during playback or the picture is dark.

- This player is compatible with Macro-Vision System copy guard. Some discs include a copy prevention signal, and when this type of disc is played back, stripes etc., may appear on some sections of the picture depending on the TV. This is not a malfunction.
- Due to the player's copy protection circuits, connection of this device through a VCR or an AV selector may prevent recording or cause picture problems. This is not a malfunction.

No sound, or sound is distorted.

- No sound is output during slow motion playback or when scanning discs other than audio CDs and SACDs.
- Check that the disc is free from dust and dirt, and that it is not damaged. (See page 9.)
- Check that all interconnects are firmly inserted.
- Check that the plugs and terminals are free of dirt, oxide, etc. and clean if necessary. Also check the cable for damage.

Noticeable difference in DVD and CD volume.

- This is due to differences in the audio format and is not a malfunction.

Tuner

Noise is heard during broadcast, or too much white noise is heard during an FM stereo broadcast. You cannot tune in the broadcast station using the Auto Preset function (for only FM stations). Or, the FM ST indicator does not light up during FM broadcast.

- Change the location of the antenna. (See page 43.)
- Locate the unit further from the TV or a computer.
- Cars or airplanes can create noisy interference.
- A broadcast radio signal may be weak if a concrete wall obstructs the signal path.
- Try setting FM mode to Monaural. (See page 42.)
- Noise may be heard when you operate the remote controller during AM reception.
- If nothing can improve the reception, install an outdoor antenna. (See page 17.)

If power outage occurs or the power plug is disconnected:

- The clock data is lost. Set the clock and timers again.

Radio frequency is not adjustable.

- Press **◀◀/▶▶** to adjust radio frequency.

Remote Controller

The remote controller does not function correctly.

- Make sure that the batteries have been installed in the correct direction (polarity +/-). (See page 10.)
- Replace both batteries with new ones. (Do not mix different types of batteries or new and old batteries.)
- The distance between the remote controller and the unit may be too great, or there may be an object between them.
- The remote control sensor on the unit may be subjected to bright light (inverter fluorescent light or sunlight).
- The unit is placed behind the tinted windows of an audio rack or entertainment center.

Connection with External Devices

The interoperability with other external Onkyo device is not available.

- Make sure that the **RI** cable and analog audio cables (RCA) are connected correctly. (See page 21.) Connecting only an **RI** cable won't work.
- Specify the source name in the display for the external Onkyo device. (See page 28.)

The turntable sounds still.

- Make sure if the turntable has built in phono equalizer.
- If the turntable has no phono equalizer built in, you must provide one separately.

The turntable makes no sound.

- If your turntable uses an MC cartridge, you must connect an MC transformer or an MC head amp.

Clock

The clock is wrong.

- CT (Clock Time) information may be taken from a radio station in another time zone. Set ACCUCLOCK to use a specific station. (See page 58.)

Timer Function

Timer playback or recording does not work.

- The clock should be set correctly.
If the clock is not set, playback or recording does not work. Make sure you program the current time. (See page 58.)
- Timer operation is not activated if the power to the unit is turned on before the timer On time. Be sure to place the unit in Standby mode before timer operation starts. (See page 65.)
- Programmed time may overlap with another timer. Be sure to set multiple timers such that time ranges do not overlap.
- If you try to set the Sleep timer or press TIMER during timer operation, the current timer setting is cancelled.
- The timer operation uses the volume level that was set before the unit was placed in Standby mode. Set an appropriate volume level before you place the unit in Standby mode. (See page 65.)
- Make sure that the **RI** cable and RCA/phono audio cables are connected correctly.
- If you selected an external Onkyo component for the timer operation, you must specify the source name.

Time display is not visible during Standby mode.

- Turn the current time display on while the unit is in Standby mode. (See page 60.)

The Colors of the TV Picture Bleed

- Locate the speakers far from the TV.

Onkyo is not responsible for damages (such as CD rental fees) due to unsuccessful recordings caused by unit's malfunction.

Before you record important data, make sure that the material will be recorded correctly.

This product uses a microcomputer to perform various advanced functions. However, noise, radio interference, or static electricity could occasionally cause the unit to malfunction. In this case, unplug the power cable from the AC outlet, then plug it in again in five seconds.

Specifications

General

Power Supply: AC 230 V, 50 Hz
Power Consumption: 75 W
Stand-by Power Consumption: 0.4 W
Dimensions (W x H x D): 8-1/16" x 5-13/16" x 13-7/8"
205 W x 147 H x 353 D mm
Weight: 5.4 kg, 11.9 lbs

■ Audio Inputs

Analog Inputs: LINE, TAPE

■ Audio Outputs

Analog Outputs: TAPE
Multichannel Pre Outputs: 3.1 ch
Speaker Terminals: Front Speakers
Phones: 1
Operation Condition: 5 °C–35 °C (41 F–95 F)/5 %–85 %
Temperature/Humidity:
Disc Compatibility: SACD, DVD-Audio, DVD-video, DVD-R/RW (VR, VIDEO), CD, CD-R/RW, Video CD, SVCD, WMA, MP3, JPEG
Disc that have not been properly finalized may only be partially playable or not playable at all.

Amplifier Section

Power Output: 2 ch x 18 W at 4 ohms, 1 kHz
2ch driven:
Dynamic power: 24 W + 24 W (3 Ω, Front)
21 W + 21 W (4 Ω, Front)
14 W + 14 W (8 Ω, Front)

Damping Factor: 70 (Front, 1 kHz, 8 Ω)
Input Sensitivity and Impedance: 150 mV/47 kΩ (LINE)

Output Level and Impedance: 120 mV/2.2 kΩ (REC OUT)
Frequency Response: 10 Hz–100 kHz/±3 dB (LINE)
±10 dB, 100 Hz (BASS)

Tone Control: ±10 dB, 10 kHz (TREBLE)
+4.5 dB, 80 Hz (S.BASS 1)
+7.5 dB, 80 Hz (S.BASS 2)
Signal to Noise Ratio: 100 dB (LINE, IHF-A)
Speaker Impedance: 4 Ω–16 Ω

Tuner Section

■ FM

Tuning Frequency Range: 87.5 MHz–108.0 MHz
Usable Sensitivity: Stereo: 22.2 dBf (75 Ω IHF)
Mono: 15.2 dBf (75 Ω IHF)
Signal to Noise Ratio: Stereo: 67 dB (IHF-A)
Mono: 73 dB (IHF-A)
THD: Stereo: 0.5 % (1 kHz)
Mono: 0.3 % (1 kHz)
Frequency response: 30 Hz–15 kHz/±1 dB
Stereo Separation: 40 dB (1kHz)

■ AM

Tuning Frequency Range: 522 kHz–1611 kHz
Usable Sensitivity: 300 μV
Signal to Noise Ratio: 40 dB
THD: 0.7 %

DVD

■ VIDEO

Signal System: PAL/NTSC
Composite Output/Impedance: 1.0 V (p-p)/75 Ω negative sync, RCA/phono
S Video Output/Impedance: Y: 0.7 V (p-p)/75 Ω negative sync, 4-pin mini DIN
C: 0.286 V (p-p)/75 Ω
AV Connector: 1.0 V (p-p)/75 Ω, Scart

Specifications and features are subject to change without notice.

Memo

ONKYO CORPORATION

Sales & Product Planning Div. : 2-1, Nisshin-cho, Neyagawa-shi, OSAKA 572-8540, JAPAN
Tel: 072-831-8023 Fax: 072-831-8124

ONKYO U.S.A. CORPORATION

18 Park Way, Upper Saddle River, N.J. 07458, U.S.A.
Tel: 201-785-2600 Fax: 201-785-2650 <http://www.us.onkyo.com/>

ONKYO EUROPE ELECTRONICS GmbH

Liegnitzerstrasse 6, 82194 Groebenzell, GERMANY
Tel: +49-8142-4401-0 Fax: +49-8142-4401-555 <http://www.eu.onkyo.com/>

ONKYO EUROPE UK Office

Suite 1, Gregories Court, Gregories Road, Beaconsfield, Buckinghamshire, HP9 1HQ
UNITED KINGDOM Tel: +44-(0)1494-681515 Fax: +44(0)-1494-680452

ONKYO CHINA LIMITED

Unit 1 & 12, 9/F, Ever Gain Plaza Tower 1, 88, Container Port Road, Kwai Chung,
N.T., HONG KONG Tel: 852-2429-3118 Fax: 852-2428-9039
<http://www.ch.onkyo.com/>



D0608-2

SN 29344307A

(C) Copyright 2006 ONKYO CORPORATION Japan. All rights reserved.



* 2 9 3 4 4 3 0 7 A *

Free Manuals Download Website

<http://myh66.com>

<http://usermanuals.us>

<http://www.somanuals.com>

<http://www.4manuals.cc>

<http://www.manual-lib.com>

<http://www.404manual.com>

<http://www.luxmanual.com>

<http://aubethermostatmanual.com>

Golf course search by state

<http://golfingnear.com>

Email search by domain

<http://emailbydomain.com>

Auto manuals search

<http://auto.somanuals.com>

TV manuals search

<http://tv.somanuals.com>