

**ONKYO®**

**DVD Player**

***DV-SP404***  
***DV-SP404E***

**Instruction Manual**

Thank you for purchasing an Onkyo DVD Player. Read this manual carefully before using your new DVD Player. A good understanding of its features and operation will allow you to achieve optimum performance and enjoyment.

Keep this manual for future reference.

**Contents**

<b>Overview .....</b>	<b>2</b>
<b>Connections .....</b>	<b>17</b>
<b>Getting Started and Setting up .....</b>	<b>24</b>
<b>Basic Playback .....</b>	<b>26</b>
<b>Playback Techniques .....</b>	<b>30</b>
<b>Detailed Settings .....</b>	<b>40</b>
<b>Miscellaneous Information .....</b>	<b>49</b>



**WARNING:**

TO REDUCE THE RISK OF FIRE OR ELECTRIC SHOCK, DO NOT EXPOSE THIS APPARATUS TO RAIN OR MOISTURE.

**CAUTION:**

TO REDUCE THE RISK OF ELECTRIC SHOCK, DO NOT REMOVE COVER (OR BACK). NO USER-SERVICEABLE PARTS INSIDE. REFER SERVICING TO QUALIFIED SERVICE PERSONNEL.



**CAUTION**  
RISK OF ELECTRIC SHOCK  
DO NOT OPEN

**AVIS**  
RISQUE DE CHOC ELECTRIQUE  
NE PAS OUVRIR



The lightning flash with arrowhead symbol, within an equilateral triangle, is intended to alert the user to the presence of uninsulated “dangerous voltage” within the product’s enclosure that may be of sufficient magnitude to constitute a risk of electric shock to persons.



The exclamation point within an equilateral triangle is intended to alert the user to the presence of important operating and maintenance (servicing) instructions in the literature accompanying the appliance.

# Important Safety Instructions

1. **Read Instructions** – All the safety and operating instructions should be read before the appliance is operated.
2. **Retain Instructions** – The safety and operating instructions should be retained for future reference.
3. **Heed Warnings** – All warnings on the appliance and in the operating instructions should be adhered to.
4. **Follow Instructions** – All operating and use instructions should be followed.
5. **Cleaning**—Unplug the appliance from the wall outlet before cleaning. The appliance should be cleaned only as recommended by the manufacturer.
6. **Attachments**—Do not use attachments not recommended by the appliance manufacturer as they may cause hazards.
7. **Water and Moisture**—Do not use the appliance near water—for example, near a bath tub, wash bowl, kitchen sink, or laundry tub; in a wet basement; or near a swimming pool; and the like.
8. **Accessories**—Do not place the appliance on an unstable cart, stand, tripod, bracket, or table. The appliance may fall, causing serious injury to a child or adult, and serious damage to the appliance. Use only with a cart, stand, tripod, bracket, or table recommended by the manufacturer, or sold with the appliance. Any mounting of the appliance should follow the manufacturer’s instructions, and should use a mounting accessory recommended by the manufacturer.
9. An appliance and cart combination should be moved with care. Quick stops, excessive force, and uneven surfaces may cause the appliance and cart combination to overturn.
10. **Ventilation**—Slots and openings in the cabinet are provided for ventilation and to ensure reliable operation of the appliance and to protect it from overheating, and these openings must not be blocked or covered. The openings should never be blocked by placing the appliance on a bed, sofa, rug, or other similar surface. The appliance should not be placed in a built-in installation such as a bookcase or rack

PORTABLE CART WARNING



S3125A

11. **Power Sources**—The appliance should be operated only from the type of power source indicated on the marking label. If you are not sure of the type of power supply to your home, consult your appliance dealer or local power company.
12. **Grounding or Polarization**—The appliance may be equipped with a polarized alternating current line plug (a plug having one blade wider than the other). This plug will fit into the power outlet only one way. This is a safety feature. If you are unable to insert the plug fully into the outlet, try reversing the plug. If the plug should still fail to fit, contact your electrician to replace your obsolete outlet. Do not defeat the safety purpose of the polarized plug.
13. **Power Cord Protection**—Power-supply cords should be routed so that they are not likely to be walked on or pinched by items placed upon or against them, paying particular attention to cords at plugs, convenience receptacles, and the point where they exit from the appliance.
14. **Lightning**—For added protection for the appliance during a lightning storm, or when it is left unattended and unused for long periods of time, unplug it from the wall outlet and disconnect the antenna or cable system. This will prevent damage to the appliance due to lightning and power-line surges.
15. **Overloading**—Do not overload wall outlets, extension cords, or integral convenience receptacles as this can result in a risk of fire or electric shock.
16. **Object and Liquid Entry**—Never push objects of any kind into the appliance through openings as they may touch dangerous voltage points or short-out parts that could result in a fire or electric shock. Never spill liquid of any kind on the appliance.
17. **Servicing**—Do not attempt to service the appliance yourself as opening or removing covers may expose you to dangerous voltage or other hazards. Refer all servicing to qualified service personnel.
18. **Damage Requiring Service**—Unplug the appliance from the wall outlet and refer servicing to qualified service personnel under the following conditions:
  - unless proper ventilation is provided. There should be free space of at least 5 cm (2 in.) and an opening behind the appliance.

## Important Safety Instructions—Continued

- A. When the power-supply cord or plug is damaged,
  - B. If liquid has been spilled, or objects have fallen into the appliance,
  - C. If the appliance has been exposed to rain or water,
  - D. If the appliance does not operate normally by following the operating instructions. Adjust only those controls that are covered by the operating instructions as an improper adjustment of other controls may result in damage and will often require extensive work by a qualified technician to restore the appliance to its normal operation,
  - E. If the appliance has been dropped or damaged in any way, and
  - F. When the appliance exhibits a distinct change in performance – this indicates a need for service.
19. **Replacement Parts**—When replacement parts are required, be sure the service technician has used replacement parts specified by the manufacturer or have the same characteristics as the original part. Unauthorized substitutions may result in fire, electric shock, or other hazards.
20. **Safety Check**—Upon completion of any service or repairs to the appliance, ask the service technician to perform safety checks to determine that the appliance is in proper operation condition.
21. **Wall or Ceiling Mounting**—The appliance should be mounted to a wall or ceiling only as recommended by the manufacturer.
22. **Heat**—The appliance should be situated away from heat sources such as radiators, heat registers, stoves, or other appliances (including amplifiers) that produce heat.
23. **Liquid Hazards**—The appliance should not be exposed to dripping or splashing and no objects filled with liquids, such as vases should be placed on the appliance.

## Precautions

1. **Recording Copyright**—Unless it's for personal use only, recording copyrighted material is illegal without the permission of the copyright holder.
2. **AC Fuse**—The AC fuse inside the unit is not user-serviceable. If you cannot turn on the unit, contact your Onkyo dealer.
3. **Care**—Occasionally you should dust the unit all over with a soft cloth. For stubborn stains, use a soft cloth dampened with a weak solution of mild detergent and water. Dry the unit immediately afterwards with a clean cloth. Don't use abrasive cloths, thinners, alcohol, or other chemical solvents, because they may damage the finish or remove the panel lettering.
4. **Power**  
**WARNING**  
**BEFORE PLUGGING IN THE UNIT FOR THE FIRST TIME, READ THE FOLLOWING SECTION CAREFULLY.**  
 AC outlet voltages vary from country to country. Make sure that the voltage in your area meets the voltage requirements printed on the unit's rear panel (e.g., AC 230 V, 50 Hz or AC 120 V, 60 Hz).  
 The power cord plug is used to disconnect this unit from the AC power source. Make sure that the plug is readily operable (easily accessible) at all times.  
 Pressing the [STANDBY/ON] button to select Standby mode does not fully shutdown the unit. If you do not intend to use the unit for an extended period, remove the power cord from the AC outlet.
5. **Never Touch this Unit with Wet Hands**—Never handle this unit or its power cord while your hands are wet or damp. If water or any other liquid gets inside this unit, have it checked by your Onkyo dealer.
6. **Handling Notes**
  - If you need to transport this unit, use the original packaging to pack it how it was when you originally bought it.
  - Do not leave rubber or plastic items on this unit for a long time, because they may leave marks on the case.
  - This unit's top and rear panels may get warm after prolonged use. This is normal.
  - If you do not use this unit for a long time, it may not work properly the next time you turn it on, so be sure to use it occasionally.
  - When you've finished using this unit, remove all discs and turn off the power.
7. **Installing this Unit**
  - Install this unit in a well-ventilated location.
  - Ensure that there's adequate ventilation all around this unit, especially if it's installed in an audio rack. If the ventilation is inadequate, the unit may overheat, leading to malfunction.
  - Do not expose this unit to direct sunlight or heat sources, because its internal temperature may rise, shortening the life of the optical pickup.
  - Avoid damp and dusty places, and places subject to vibrations from loudspeakers. Never put the unit on top of, or directly above a loudspeaker.
  - Install this unit horizontally. Never use it on its side or on a sloping surface, because it may cause a malfunction.
  - If you install this unit near a TV, radio, or VCR, the picture and sound quality may be affected. If this occurs, move this unit away from the TV, radio, or VCR.

## Precautions—Continued

**8. To Obtain a Clear Picture**—This unit is a high-tech, precision device. If the lens on the optical pickup, or the disc drive mechanism becomes dirty or worn, the picture quality may be affected. To maintain the best picture quality, we recommend regular inspection and maintenance (cleaning or worn part replacement) every 1,000 hours of use depending on the operating environment. Contact your Onkyo dealer for details.

### 9. Moisture Condensation



**Moisture condensation may damage this unit.**

Read the following carefully:

Moisture may condense on the lens of the optical pickup, one of the most important parts inside this unit.

- Moisture condensation can occur in the following situations:
  - The unit is moved from a cold place to a warm place.
  - A heater is turned on, or cold air from an air conditioner is hitting the unit.
  - In the summer, when this unit is moved from an air conditioned room to a hot and humid place.
  - The unit is used in a humid place.
- Do not use this unit when there's the possibility of moisture condensation occurring. Doing so may damage your discs and certain parts inside this unit.

If condensation does occur, remove all discs and leave this unit turned on for two to three hours. By this time, the unit will have warmed up and any condensation will have evaporated.

**10. Region Numbers**—The DVD standard uses region numbers to control how discs can be played around the world, the world being divided into six regions. This unit will only play DVD discs that match its region number, which can be found on its rear panel (e.g., , ).

**11. About this Manual**—This manual explains how to use all of this unit's functions. Although the DVD standard offers many special features, not all discs use them all, so depending on the disc being played, this unit may not respond to certain functions. See the disc's sleeve notes for supported features.

This unit contains a semiconductor laser system and is classified as a "CLASS 1 LASER PRODUCT". So, to use this model properly, read this Instruction Manual carefully. In case of any trouble, please contact the store where you purchased the unit.

To prevent being exposed to the laser beam, do not try to open the enclosure.

### DANGER:

VISIBLE AND/OR INVISIBLE LASER RADIATION WHEN OPEN AND INTERLOCK FAILED OR DEFEATED. DO NOT STARE INTO BEAM.

### CAUTION:

THIS PRODUCT UTILIZES A LASER. USE OF CONTROLS OR ADJUSTMENTS OR PERFORMANCE OF PROCEDURES OTHER THAN THOSE SPECIFIED HEREIN MAY RESULT IN HAZARDOUS RADIATION EXPOSURE.

The label on the right is applied on the rear panel.



1. This unit is a CLASS 1 LASER PRODUCT and employs a laser inside the cabinet.
2. To prevent the laser from being exposed, do not remove the cover. Refer servicing to qualified personnel.

## WARNING

**To prevent a fire hazard, do not place any naked flame sources (such as a lighted candle) on the equipment.**

**When disposing of used batteries, please comply with governmental regulations or environmental public instruction's rules that apply in your country/area.**

## Precautions—Continued

### For U.S. models

#### FCC Information for User

#### CAUTION:

The user changes or modifications not expressly approved by the party responsible for compliance could void the user's authority to operate the equipment.

#### NOTE:

This equipment has been tested and found to comply with the limits for a Class B digital device, pursuant to Part 15 of the FCC Rules. These limits are designed to provide reasonable protection against harmful interference in a residential installation.

This equipment generates, uses and can radiate radio frequency energy and, if not installed and used in accordance with the instructions, may cause harmful interference to radio communications. However, there is no guarantee that interference will not occur in a particular installation. If this equipment does cause harmful interference to radio or television reception, which can be determined by turning the equipment off and on, the user is encouraged to try to correct the interference by one or more of the following measures:

- Reorient or relocate the receiving antenna.
- Increase the separation between the equipment and receiver.
- Connect the equipment into an outlet on a circuit different from that to which the receiver is connected.
- Consult the dealer or an experienced radio/TV technician for help.

### For Canadian Models

**NOTE:** THIS CLASS B DIGITAL APPARATUS COMPLIES WITH CANADIAN ICES-003.

For models having a power cord with a polarized plug:

**CAUTION:** TO PREVENT ELECTRIC SHOCK, MATCH WIDE BLADE OF PLUG TO WIDE SLOT, FULLY INSERT.

### Modèle pour les Canadien

**REMARQUE:** CET APPAREIL NUMÉRIQUE DE LA CLASSE B EST CONFORME À LA NORME NMB-003 DU CANADA.

Sur les modèles dont la fiche est polarisée:

**ATTENTION:** POUR ÉVITER LES CHOCS ÉLECTRIQUES, INTRODUIRE LA LAME LA PLUS LARGE DE LA FICHE DANS LA BORNE CORRESPONDANTE DE LA PRISE ET POUSSER JUSQU'AU FOND.

### For British models

Replacement and mounting of an AC plug on the power supply cord of this unit should be performed only by qualified service personnel.

#### IMPORTANT

The wires in the mains lead are coloured in accordance with the following code:

Blue: Neutral  
Brown: Live

As the colours of the wires in the mains lead of this apparatus may not correspond with the coloured markings identifying the terminals in your plug, proceed as follows:

The wire which is coloured blue must be connected to the terminal which is marked with the letter N or coloured black.

The wire which is coloured brown must be connected to the terminal which is marked with the letter L or coloured red.

#### IMPORTANT

The plug is fitted with an appropriate fuse. If the fuse needs to be replaced, the replacement fuse must be approved by ASTA or BSI to BS1362 and have the same ampere rating as that indicated on the plug. Check for the ASTA mark or the BSI mark on the body of the fuse.

If the power cord's plug is not suitable for your socket outlets, cut it off and fit a suitable plug. Fit a suitable fuse in the plug.

### For European Models

Declaration of Conformity	
<p>We, ONKYO EUROPE ELECTRONICS GmbH LIEGNITZERSTRASSE 6, 82194 GROEBENZELL, GERMANY</p>	
<p>declare in own responsibility, that the ONKYO product described in this instruction manual is in compliance with the corresponding technical standards such as EN60065, EN55013, EN55020 and EN61000-3-2, -3-3.</p>	
<p>GROEBENZELL, GERMANY</p>	 K. MIYAGI
<p>ONKYO EUROPE ELECTRONICS GmbH</p>	

# Table of Contents

## Basic Operation

### Overview

Important Safety Instructions.....	2
Precautions .....	3
Introduction.....	7
Supplied Accessories .....	7
Features .....	7
Disc Notes .....	8
Before Using the DV-SP404/DV-SP404E .....	11
Installing the Batteries .....	11
Using the Remote Controller .....	11
Front & Rear Panels .....	12
Front Panel.....	12
Display.....	13
Rear Panel.....	14
Remote Controller .....	15

### Connections

Connecting the DV-SP404/DV-SP404E.....	17
Before Making Any Connections .....	17
AV Cables & Connectors.....	17
Basic Setup .....	18
Connecting Your TV .....	20
Connecting to an AV Receiver .....	22
Connecting the Power/Turning on the DV-SP404/DV-SP404E.....	23

### Getting Started and Setting up

Getting Started .....	24
Using the on-screen displays .....	24
Setting up the player for your TV .....	24
Setting the language of this player's on-screen displays .....	25

### Basic Playback

Playing discs.....	26
Basic playback controls .....	27
Resume and Last Memory .....	27
DVD-Video disc menus .....	28
Video CD PBC menus .....	28

## Advanced Operation

### Playback Techniques

Playing discs.....	30
Scanning discs .....	30
Playing in slow motion.....	30
Frame advance/frame reverse .....	31
Viewing a JPEG slideshow .....	31
Browsing video content with the Disc Navigator... ..	32
Browsing WMA, MP3, DivX Video and JPEG files with the Disc Navigator.....	33
Looping a section of a disc.....	34
Using repeat play .....	34
Using random play .....	35
Creating a program list.....	36
Other functions available from the program menu ..	37
Searching a disc.....	37
Switching subtitles.....	38
Switching audio language/channel.....	38
Zooming the screen .....	39
Switching camera angles .....	39
Displaying disc information .....	39

### Detailed Settings

Audio Settings and Video Adjust menus.....	40
Audio Settings menu .....	40
Dialog .....	40
Equalizer .....	40
Audio DRC .....	40
Virtual Surround .....	40
Video Adjust menu .....	41
Initial Settings menu.....	42
Using the Initial Settings menu.....	42
Digital Audio Out settings.....	43
Video Out settings.....	44
Language settings.....	45
Display settings .....	45
Optional settings .....	45
Parental Lock .....	46
Registering a new password .....	46
Changing your password .....	46
Setting/changing the Parental Lock .....	46
Setting/changing the Country/Area code .....	47
Country/Area code list.....	47
About DivX <sup>®</sup> VOD content .....	48
Displaying your DivX VOD registration code ..	48
Playing DivX <sup>®</sup> VOD content.....	48

### Miscellaneous Information

Additional information .....	49
Screen sizes and disc formats .....	49
Resetting the player .....	49
Setting the TV system (Not North American model) ..	49
Titles, chapters and tracks .....	50
DVD-Video regions .....	50
Selecting languages using the language code list ..	50
Language code list.....	51
Glossary.....	52
Troubleshooting .....	54
HDMI troubleshooting .....	57
Specifications.....	58

# Introduction

## Supplied Accessories

Make sure you have the following accessories:

RC-616DV

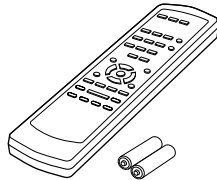

Remote controller & 2 batteries (AA)

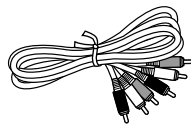

AV cable (RCA/phono)

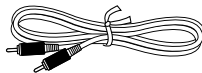

Coaxial cable

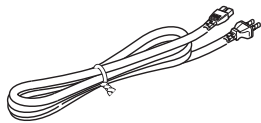

Power cord (Not North American model)  
(plug type varies from country to country)

The letter displayed at the end of the product name found in catalogs and on package represents the color of the DV-SP404/DV-SP404E DVD player. Though the color varies, the specifications and operations are the same.

## Features

### Highlights

- Dolby<sup>\*1</sup> Digital and DTS<sup>\*2</sup>
- DVD-Video/Video CD/Audio CD playback
- CD-R, CD-RW (Video CD, audio CD, MP3/WMA<sup>\*3</sup>/JPEG/DivX Video<sup>\*4</sup>)
- DVD-R (DVD-Video)
- DVD-RW (DVD-Video, VR format)

### Video

- Advanced 54 MHz/10-bit video D/A converter
- Progressive Scan Video (PAL/NTSC)
- Component video output
- HDMI<sup>\*5</sup> digital interface
- Frame-by-frame playback
- Slow motion playback
- Fast forward and reverse
- Repeat playback
- Random playback
- Supports 4:3 and 16:9 aspect ratio TVs
- Multiple camera angle support
- Parental Lock function
- Screen Saver function

### Audio

- 96 kHz/24-bit D/A converter
- Coaxial digital output
- Optical digital output (Oceanian model only)

### Others

- Dynamic Range Control setting
- Full-function remote controller

\*1. Manufactured under license from Dolby Laboratories.

"Dolby" and the double-D symbol are trademarks of Dolby Laboratories.

\*2. "DTS" and "DTS Digital Out" are trademarks of Digital Theater Systems, Inc.

\*3. Windows Media, and the Windows logo are trademarks, or registered trademarks of Microsoft Corporation in the United States and/or other countries.



\*4. DivX, DivX Certified, and associated logos are trademarks of DivX, Inc. and are used under license.









\*5. HDMI, the HDMI logo and High-Definition Multimedia Interface are trademarks or registered trademarks of HDMI licensing LLC.

## Introduction—Continued

### Disc Notes

#### Supported Discs

The DV-SP404/DV-SP404E supports the following discs.

Disc	Logo	Format or file type
DVD-Video		See page 50 for region information.
DVD-R		DVD-Video
DVD-RW		DVD-Video, VR format
Video CD		Including PBC
Audio CD		PCM and DTS
CD-R		Video CD, audio CD, MP3, WMA, JPEG, DivX Video
CD-RW		Video CD, audio CD, MP3, WMA, JPEG, DivX Video
JPEG CD		JPEG

- Some audio CDs feature copy protection that doesn't conform to the official CD standard. Since these are nonstandard discs, they may not play properly in the DV-SP404/DV-SP404E.
- The DV-SP404/DV-SP404E supports CD-R and CD-RW discs recorded in Video CD format, audio CD format, or ISO 9660 Level 1 or 2 format with MP3, WMA, and JPEG files. It also supports DVD-R and DVD-RW discs recorded in DVD-Video format. However, some CD-R, CD-RW, DVD-R, and DVD-RW discs may not work properly for any of the following reasons: incomplete disc finalization, disc burner characteristics, disc characteristics, the disc is damaged or dirty. See the manual supplied with your disc burner for more information. Condensation or dirt on the optical pickup lens can also affect playback.
- The DV-SP404/DV-SP404E supports 8 cm and 12 cm discs.
- The DV-SP404/DV-SP404E does not support disc types not listed.
- Don't use discs with an unusual shape, such as those shown below, because you may damage the DV-SP404/DV-SP404E.



- Don't use discs that have residue from adhesive tape, rental discs with peeling labels, or discs with custom-made labels or stickers. Doing so may damage the DV-SP404/DV-SP404E and you may not be able to remove the disc properly.

#### Discs Made on Personal Computers

Discs made on personal computers, including those of a compatible format, may not work properly in the DV-SP404/DV-SP404E because of incorrect settings in the disc burning software. Check the manuals supplied with your disc burning software for additional compatibility information.

#### CD-R/RW compatibility

- Compatible formats: CD-Audio, Video CD, ISO 9660 CD-ROM\* containing MP3, WMA or JPEG files, DivX video files
  - \* ISO 9660 Level 1 or 2 compliant. CD physical format: Mode1, Mode2 XA Form1. Romeo and Joliet file systems are both compatible with this player.
- Multi-session playback: No
- Unfinalized disc playback: No

#### DVD-R/RW compatibility

- Compatible formats: DVD-Video, Video Recording (VR)\*
  - \* Edit points may not play exactly as edited; screen may go momentarily blank at edited points.
- Unfinalized playback: No
- WMA/MP3/JPEG file playback on DVD-R/RW: No

#### DVD+R/DVD+RW compatibility

Only DVD+R/DVD+RW discs recorded in "Video Mode (DVD Video Mode)" which have been finalized, can be played back. However, some editing made during the recording may not be played back accurately.

#### Compressed audio compatibility

- Compatible formats: MPEG-1 Audio Layer 3 (MP3), Windows Media Audio (WMA)
- Sampling rates: 32, 44.1 or 48kHz
- Bit-rates: Any (128Kbps or higher recommended)
- VBR (variable bit rate) MP3 playback: No
- VBR WMA playback: No
- WMA lossless encoding compatible: No
- DRM (Digital Rights Management) compatible: Yes (DRM-protected audio files will not play in this player—see also DRM in the "Glossary" on page 52)
- File extensions: .mp3, .wma (these must be used for the player to recognize MP3 and WMA files – do not use for other file types)



## Introduction—Continued

### About WMA

WMA is an acronym for Windows Media Audio and refers to an audio compression technology developed by Microsoft Corporation. WMA content can be encoded by using Windows Media® Player version 7, 7.1, Windows Media® Player for Windows® XP, or Windows Media® Player 9 Series.

Microsoft, Windows Media, and the Windows logo are trademarks, or registered trademarks of Microsoft Corporation in the United States and/or other countries.

### About DivX

DivX is a compressed digital video format created by the DivX® video codec from DivX, Inc. This player can play DivX video files burned on CD-R/RW/ROM discs.

Keeping the same terminology as DVD-Video, individual DivX video files are called “Titles”. When naming files/titles on a CD-R/RW disc prior to burning, keep in mind that by default they will be played in alphabetical order.

### Displaying DivX subtitle files

The font sets listed below are available for DivX external subtitle files. You can see the proper font set on-screen by setting the Subtitle Language (in Language settings on page 45) to match the subtitle file.

This player supports the following language groups:

**Group 1:** Albanian (sq), Basque (eu), Catalan (ca), Danish (da), Dutch (nl), English (en), Faroese (fo), Finnish (fi), French (fr), German (de), Icelandic (is), Irish (ga), Italian (it), Norwegian (no), Portuguese (pt), Rhaeto-Romanic (rm), Scottish (gd), Spanish (es), Swedish (sv)

**Group 2:** Albanian (sq), Croatian (hr), Czech (cs), Hungarian (hu), Polish (pl), Romanian (ro), Slovak (sk), Slovenian (sl)

**Group 3:** Bulgarian (bg), Byelorussian (be), Macedonian (mk), Russian (ru), Serbian (sr), Ukrainian (uk)

**Group 4:** Hebrew (iw), Yiddish (ji)

**Group 5:** Turkish (tr)

DivX, DivX Certified, and associated logos are trademarks of DivX, Inc. and are used under license.

- Some external subtitle files may be displayed incorrectly or not at all.
- For external subtitle files the following subtitle format filename extensions are supported (please note that these files are not shown within the disc navigation menu): .srt, .sub, .ssa, .smi
- The filename of the movie file has to be repeated at the beginning of the filename for the external subtitle file.
- The number of external subtitle files which can be switched for the same movie file is limited to a maximum of 10.

### DivX video compatibility



- Official DivX® Certified product.
  - Plays all versions of DivX® video (including DivX® 6) with standard playback of DivX® media files.
  - File extensions: .avi and .divx (these must be used for the player to recognize DivX video files). Note that all files with the .avi extension are recognized as MPEG4, but not all of these are necessarily DivX video files and therefore may not be playable on this player.
- DivX, DivX Certified, and associated logos are trademarks of DivX, Inc. and are used under license.

### JPEG file compatibility

- Compatible formats: Baseline JPEG and EXIF 2.2\* still image files up to a resolution of 3072 x 2048.
  - \* File format used by digital still cameras
- Progressive JPEG compatible: No
- File extensions: .jpg (must be used for the player to recognize JPEG files – do not use for other file types)
- File structure: Up to 299 folders; up to 648 folders and files combined

### PC-created disc compatibility

Discs recorded using a personal computer may not be playable in this unit due to the setting of the application software used to create the disc. In these particular instances, check with the software publisher for more detailed information.

Discs recorded in packet write mode (UDF format) are not compatible with this player.

Check the DVD-R/RW or CD-R/RW software disc boxes for additional compatibility information.

### Copyright

It is forbidden by law to copy, broadcast, show, broadcast on cable, play in public, or rent copyrighted material without permission.

DVD-Video discs are copy-protected, and any recordings made from these discs will be distorted.

This product incorporates copyright protection technology that is protected by method claims of certain U.S. patents and other intellectual property rights owned by Macrovision Corporation and other rights owners. Use of this copyright-protection technology must be authorized by Macrovision Corporation, and is intended for home and other limited viewing uses only, unless otherwise authorized by Macrovision Corporation. Reverse engineering or disassembly is prohibited.

## Introduction—Continued

### Handling Discs

- Never touch the underside of a disc. Always hold discs by the edge, as shown.

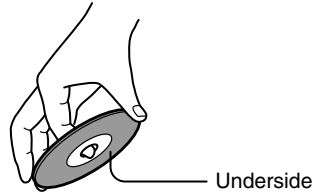

- Never attach adhesive tape or sticky labels to discs.



### Storing Discs

- Don't store discs in places subject to direct sunlight, or near heat sources.
- Don't store discs in places subject to moisture or dust, such as in a bathroom or near a humidifier.
- Always store discs in their cases and vertically. Stacking, or putting objects on unprotected discs may cause warping, scratches, or other damage.

### Cleaning Discs

- For best results, keep your discs clean. Fingerprints and dust can affect the sound and picture quality and should be removed as follows. Using a clean soft cloth, wipe from the center outwards, as shown. Never wipe in a circular direction.



- To remove stubborn dust or dirt, wipe the disc with a damp soft cloth, and then dry it with a dry cloth.
- Never use solvent-based cleaning fluids, such as thinner or benzine, commercially available cleaners, or antistatic sprays intended for vinyl records, because they may damage the disc.

## Before Using the DV-SP404/DV-SP404E

### Installing the Batteries

#### 1 Open the battery compartment, as shown.

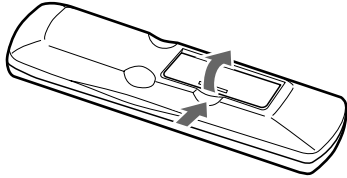

#### 2 Insert the two supplied batteries (AA) in accordance with the polarity diagram inside the battery compartment.

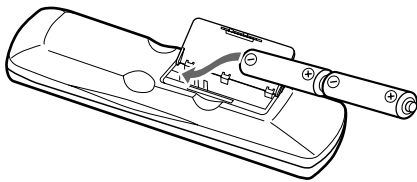

#### 3 Close the battery compartment.

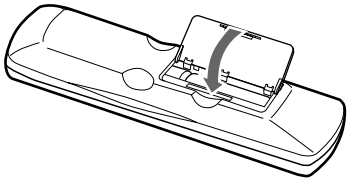

#### Notes:

- If the remote controller doesn't work reliably, try replacing both batteries.
- Don't mix new and old batteries, or different types of batteries.
- If you intend not to use the remote controller for a long time, remove the batteries to prevent possible leakage and corrosion.
- Flat batteries should be removed as soon as possible to prevent possible leakage and corrosion.

### Using the Remote Controller

To use the remote controller, point it at the DV-SP404/DV-SP404E's remote control sensor, as shown below.

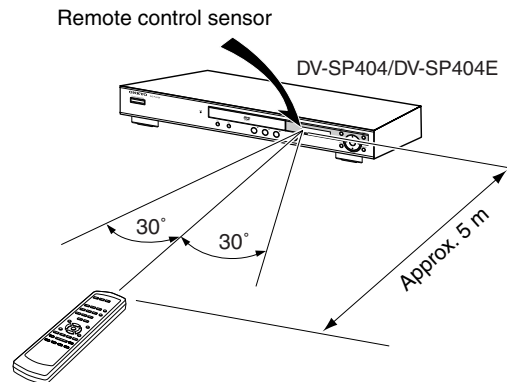

#### Notes:

- The remote controller may not work reliably if the DV-SP404/DV-SP404E is subjected to bright light, such as direct sunlight or inverter-type fluorescent lights. Keep this in mind when installing the DV-SP404/DV-SP404E.
- If another remote controller of the same type is used in the same room, or the DV-SP404/DV-SP404E is installed close to equipment that uses infrared rays, the remote controller may not work reliably.
- Don't put anything, such as a book, on the remote controller, because the buttons may be pressed inadvertently, thereby draining the batteries.
- The remote controller may not work reliably if the DV-SP404/DV-SP404E is installed in a rack behind colored glass doors. Keep this in mind when installing the DV-SP404/DV-SP404E.
- The remote controller will not work if there's an obstacle between it and the DV-SP404/DV-SP404E's remote control sensor.

# Front & Rear Panels

For detailed information, refer to the pages in brackets.

## Front Panel

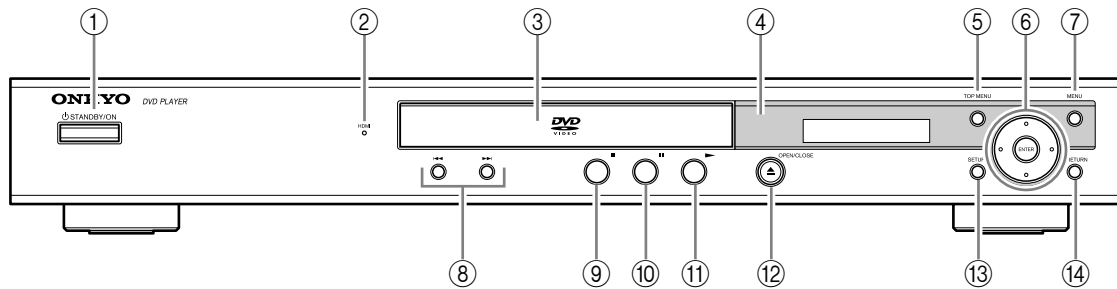

- ① **STANDBY/ON button [23, 26]**  
This button is used to set the DV-SP404/DV-SP404E to On or Standby.
- ② **HDMI indicator**  
Lights when the DV-SP404/DV-SP404E is recognized by another HDMI or DVI/HPCP compatible component.
- ③ **Disc tray [26]**  
Discs are loaded here.
- ④ **Remote control sensor [11]**  
This sensor receives control signals from the remote controller.
- ⑤ **TOP MENU button [28]**  
This button is used to display the top menu on a DVD-Video disc.
- ⑥ **Cursor & ENTER button [24]**  
These buttons are used to navigate onscreen menus.
- ⑦ **MENU button [28]**  
This button is used to display the menu on a DVD-Video disc or to open the Disc Navigator when using a Video CD, audio CD, DivX Video, WMA/MP3/JPEG disc, or VR format DVD-RW disc.
- ⑧ **◀◀/▶▶ (previous/next) buttons [27]**  
The Previous button is used to select the previous chapter or track. During playback it selects the beginning of the current chapter or track. The Next button is used to select the next chapter or track.
- ⑨ **■ (stop) button [27]**  
This button is used to stop playback.
- ⑩ **|| (pause) button [27]**  
This button is used to pause playback.
- ⑪ **▶ (PLAY) button [26, 27]**  
This button is used to start playback.
- ⑫ **▲ (OPEN/CLOSE) button [26]**  
This button is used to open and close the disc tray.
- ⑬ **SETUP button [24]**  
This button is used to open and close the onscreen setup menus.
- ⑭ **RETURN button [24]**  
This button is used to return to the main menu without saving your changes.

## Front & Rear Panels—Continued

### Display

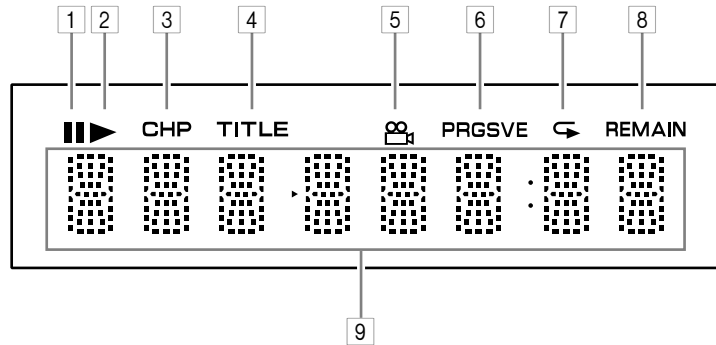

**1 Pause || indicator**

This indicator appears when playback is paused.

**2 Play ► indicator**

This indicator is shown during playback.

**3 CHP indicator**

This indicator appears while the number of the current chapter is being displayed.

**4 TITLE indicator**

While stopped, the total number of titles on the current DVD-Video disc is displayed here. During playback, the number of the current title is displayed.

**5 Camera angle  indicator**

This indicator appears if the DVD-Video disc being played features multiple camera angles.

**6 PRGSVE (Progressive) indicator**

This indicator appears when the component video output is outputting progressive video.

**7 Repeat  indicator**

This indicator appears when A-B playback or repeat playback is used.

**8 REMAIN indicator**

This indicator appears while the remaining time is being displayed.

**9 Message & time area**

Time information, such as total time, remaining time, and so on, is displayed here in hours, minutes, and seconds. Other messages are also displayed.

## Front & Rear Panels—Continued

### Rear Panel

#### DV-SP404 North American model

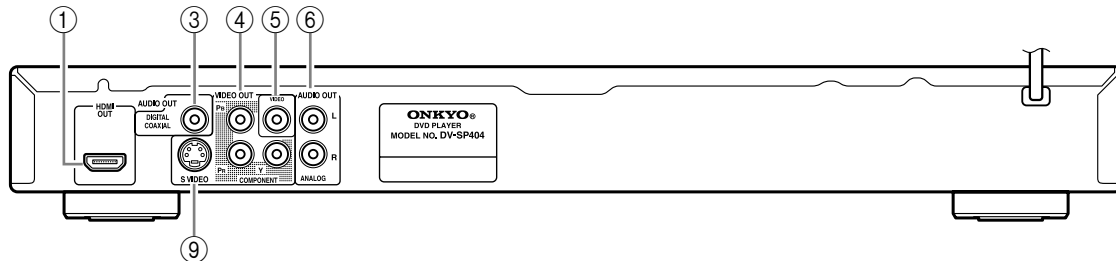

#### DV-SP404 Oceanian model

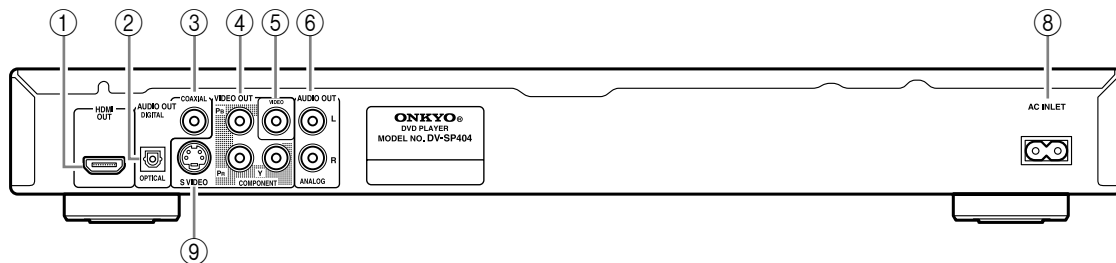

#### DV-SP404E European model

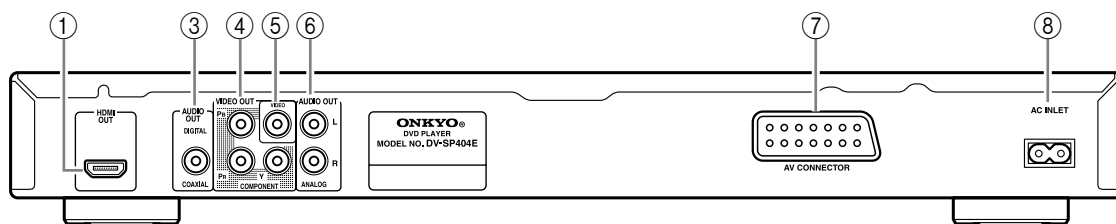

- ① **HDMI OUT [21]**  
This connector can be used to connect a TV or projector with an HDMI input. This connector outputs digital audio and digital video.
- ② **OPTICAL DIGITAL AUDIO OUT [22] (not North American and European models)**  
This optical digital audio output can be connected to an optical digital audio input on a hi-fi amp, AV receiver, or surround sound decoder (Dolby Digital, DTS).
- ③ **COAXIAL DIGITAL AUDIO OUT [22]**  
This coaxial digital audio output can be connected to a coaxial digital audio input on a hi-fi amp, AV receiver, or surround sound decoder (Dolby Digital, DTS).
- ④ **COMPONENT VIDEO OUT [20]**  
These sockets output component video and can be connected to a component video input on a TV or projector.
- ⑤ **VIDEO OUT [18]**  
This RCA/phono connector can be used to connect a TV or projector with a composite video input.
- ⑥ **ANALOG AUDIO OUT [18]**  
These RCA/phono connectors can be connected to analog audio inputs on your TV, hi-fi amp, or AV receiver.
- ⑦ **AV CONNECTOR [20] (European model only)**  
This SCART output can be connected to a TV or projector with a SCART input. This SCART connector outputs 2-channel stereo audio, composite video, and RGB video.
- ⑧ **AC INLET [23] (not North American model)**  
The supplied power cord is connected here. The other of the power cord should be connected to a suitable wall outlet.
- ⑨ **S VIDEO VIDEO OUT [20] (not European model)**  
This connector can be used to connect a TV or projector with an S-Video input.

## Front & Rear Panels—Continued



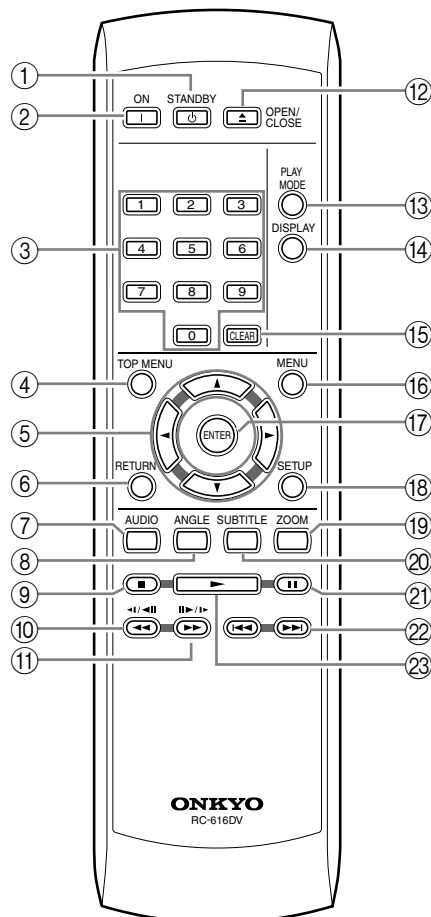

### Remote Controller



- ① **STANDBY button [23]**  
This button is used to set the DV-SP404/DV-SP404E to Standby.
- ② **ON button [23]**  
This button is used to turn on the DV-SP404/DV-SP404E.  
Don't turn on the DV-SP404/DV-SP404E until you've completed, and double checked all connections (pages 17–22).
- ③ **Number buttons [27–28, 37, 46]**  
These buttons are used to enter title, chapter, and track numbers and to enter times for locating specific points in time.
- ④ **TOP MENU button [28]**  
This button is used to display the top menu on a DVD-Video disc.
- ⑤ **Cursor ◀/▶/▲/▼ buttons [24]**  
These buttons are used to navigate onscreen menus.
- ⑥ **RETURN button [24, 28]**  
This button is used to return to the main menu without saving your changes.
- ⑦ **AUDIO button [38]**  
This button is used to select foreign language soundtracks and audio formats (e.g., Dolby Digital or DTS) on DVD-Video discs.  
For Video CDs you can select left-channel, right-channel, or stereo.
- ⑧ **ANGLE button [39]**  
This button is used to select camera angles on DVD-Video discs.
- ⑨ **Stop ■ button [27]**  
This button is used to stop playback.
- ⑩ **Fast Reverse ◀◀/(◀/◀◀) button [27, 30, 31]**  
This button is used for fast reverse, reverse slow motion, and reverse frame-by-frame playback.

## Front & Rear Panels—Continued

---

- ⑪ **Fast Forward**  **button [27, 30, 31]**  
This button is used for fast forward, slow motion, and frame-by-frame playback.
- ⑫ **OPEN/CLOSE**  **button [26]**  
This button is used to open and close the disc tray.
- ⑬ **PLAY MODE** **button [34–37]**  
This button is used to open and close the Play Mode menu.
- ⑭ **DISPLAY** **button [39]**  
This button is used to display information about the current disc, title, chapter, or track, including the elapsed time, remaining time, total time, and so on. Press it repeatedly to display more information.
- ⑮ **CLEAR** **[36]**  
This button is used to cancel various functions.
- ⑯ **MENU** **button [28]**  
This button is used to display the menu on a DVD-Video disc or to open the Disc Navigator when using a Video CD, audio CD, DivX Video, WMA/MP3/JPEG disc, or VR format DVD-RW disc.
- ⑰ **ENTER** **button [24]**  
This button is used to start playback of the selected title, chapter, or track, and to confirm settings.
- ⑱ **SETUP** **button [24, 40–42]**  
This button is used to open and close the onscreen setup menus.
- ⑲ **ZOOM** **button [39]**  
This button is used with the Zoom function.
- ⑳ **SUBTITLE** **button [38]**  
This button is used to select subtitles on DVD-Video discs.
- ㉑ **Pause**  **button [27, 30, 31]**  
This button is used to pause playback.
- ㉒ **Previous/Next**  **buttons [27]**  
The Previous button is used to select the previous chapter or track. During playback it selects the beginning of the current chapter or track.  
The Next button is used to select the next chapter or track.
- ㉓ **Play**  **button [27]**  
This button is used to start playback.



# Connecting the DV-SP404/DV-SP404E

## Before Making Any Connections

- Read the manuals supplied with your AV components.
- Don't connect the power cord until you've completed all audio and video connections.

## Optical Digital Output (not North American and European models)

The optical digital connector is fitted with protective cap. Before connecting a cable, remove the cap and keep it safely. When you disconnect the cable, put the cap back in.

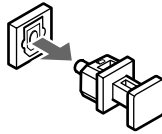

## RCA/phono AV Connection Color Coding

RCA/phono AV connections are usually color coded: red, white, and yellow. Use red plugs to connect right-channel audio inputs and outputs (typically labeled "R"). Use white plugs to connect left-channel audio inputs and outputs (typically labeled "L"). And use yellow plugs to connect composite video inputs and outputs.

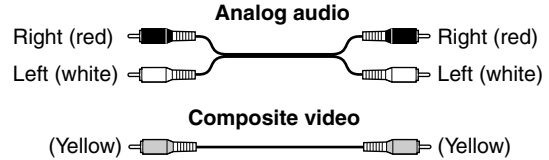

- Push each plug in all the way to make a good connection (loose connections can cause noise or malfunctions).
- To prevent interference, keep audio and video cables away from power cords and speaker cables.

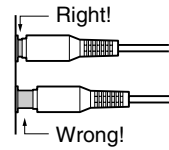

## AV Cables & Connectors

Video			
<b>Component video</b>			Component video separates the luminance (Y) and color difference signals (PR, PB), providing the best picture quality. Some TV manufacturers label their component video inputs differently.
<b>S-Video (not European model)</b>			S-Video provides better picture quality than composite video.
<b>Composite video</b>			Composite video can be found on virtually all TVs, VCRs, and video equipment.
<b>Scart (European model only)</b>			SCART connections carry audio and video (composite, S-Video, RGB) all in one cable.

Audio			
<b>Optical digital (Oceanian model only)</b>			Optical digital audio connections provide better audio quality than analog connections.
<b>Coaxial digital</b>			Coaxial digital audio connections provide better audio quality than analog connections.
<b>Analog</b>			RCA/phono analog audio connectors can be found on virtually all AV components.

## Connecting the DV-SP404/DV-SP404E—Continued

### Basic Setup

The setup described here is a basic setup that allows you to play discs using just the supplied AV cable (RCA/phono). In this setup, stereo audio is played through the speakers in your TV.

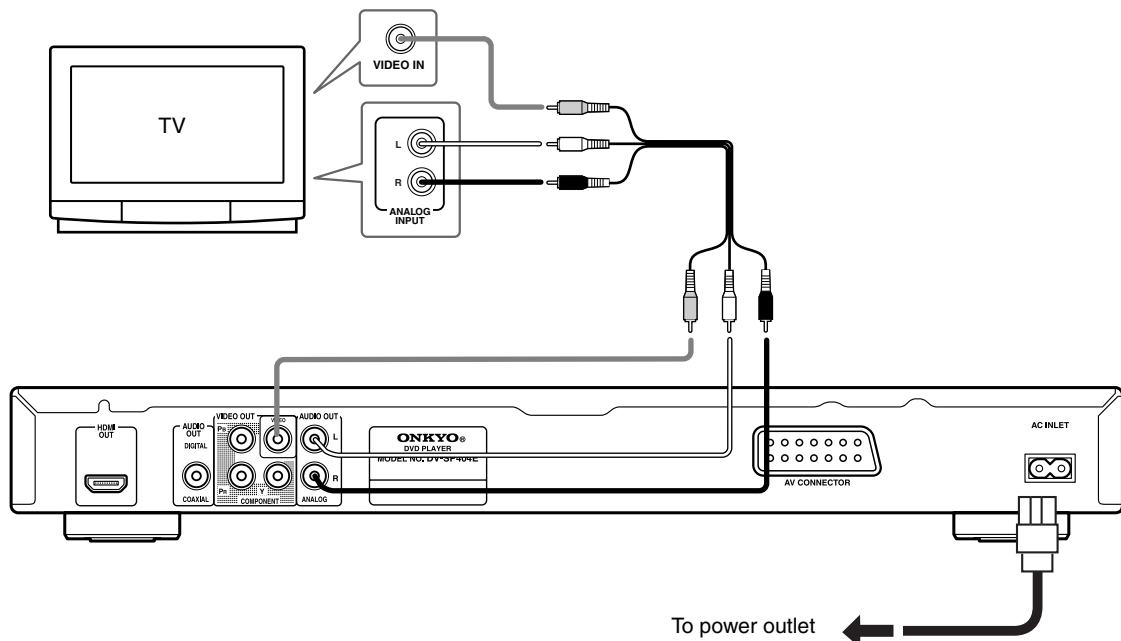

#### Important:

- This player is equipped with copy protection technology. Do not connect this player to your TV via a VCR using AV cables, as the picture from this player will not appear properly on your TV. (This player may also not be compatible with some combination TV/VCRs for the same reason; refer to the manufacturer for more information.)
- When connecting to your TV as shown above, do not set the “Component Out” setting (page 44) to “Progressive.”

#### Notes:

- Before unplugging the player from the power outlet, make sure you first switch it into standby using either the front panel STANDBY/ON button, or the remote controller, and wait of the “OFF” message to disappear from the player’s display.
- For the above reasons, do not plug this player into a switched power supply found on some amplifiers and AV receivers.

#### 1. Connect the VIDEO OUT and AUDIO OUT ANALOG L/R jacks to a set of A/V inputs on your TV.

Use the supplied AV cable (RCA/phono), connecting the red and white plugs to the audio outputs and the yellow plug to the video output. Make sure you match up the left and right audio outputs with their corresponding inputs for correct stereo sound. See page 20 if you want to use a component, S-Video cable or SCART cable for the video connection.

#### 2. Oceanian and European models: Connect the supplied AC power cord to the AC INLET, then plug into a power outlet.

**North American model:**  
Connect the power cord to power outlet.

## Connecting the DV-SP404/DV-SP404E—Continued

### Switching the video output to interlace using the front panel controls

Switch the player to standby then, using the front panel controls, press STANDBY/ON while pressing **◀▶** to switch the player back to Interlace.

- If the player is connected using HDMI, disconnect the HDMI cable before resetting the player to interlace output. (If left connected, the HDMI output resolution will be reset to its default—see Resetting the output resolution to the default setting with HDMI connection on page 21.)

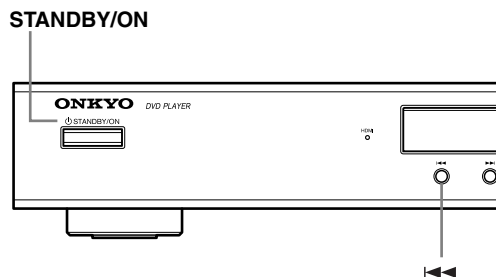

#### Note:

- If you connect a TV that is not compatible with a progressive scan signal and switch the player to progressive, you will not be able to see any picture at all. In this case, switch everything off and reconnect using the supplied video cable, then switch back to Interlace.

#### Notes for North American model:

- When Component Out (page 44) is set to Progressive, there is no video output from the VIDEO OUT (composite) and S VIDEO OUT jacks.
- If you want to display video on more than one monitor simultaneously, make sure the player is set to Interlace.

### Compatibility of this player with progressive-scan and high-definition TVs

This player is compatible with progressive video Macro Vision System Copy Guard.

Consumers should note that not all high-definition television sets are fully compatible with this product and may cause artifacts to be displayed in the picture. In case of 525 progressive scan picture problems, it is recommended that the user switch the connection to the “standard definition” output (Interlace). If there are questions regarding our TV set compatibility with this model, please contact our customer service center.

## Connecting the DV-SP404/DV-SP404E—Continued

### Connecting Your TV

- Connect the DVD Player to the TV directly. If you connect the DVD Player to a VCR, TV/VCR combination, or video selector, the playback picture may be distorted as DVD videos are copy protected.

### Using S-Video (not European model)

If your TV (or other equipment) has an S-Video input, you can use this instead of the standard (composite) output for a better quality picture.

- Use an S-Video cable (not supplied) to connect the S VIDEO OUT to an S-Video input on your TV (or monitor or AV receiver).

Line up the small triangle above the jack with the same mark on the plug before plugging in.

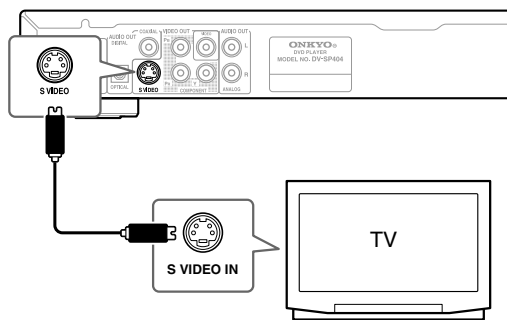

### Using Component Video

You can use the component video output instead of the standard video out jack to connect this player to your TV (or other equipment).

This should give you a better quality picture than an S-Video connection.

- Use a component video cable (not supplied) to connect the COMPONENT VIDEO OUT jacks to a component video input on your TV, monitor or AV receiver.

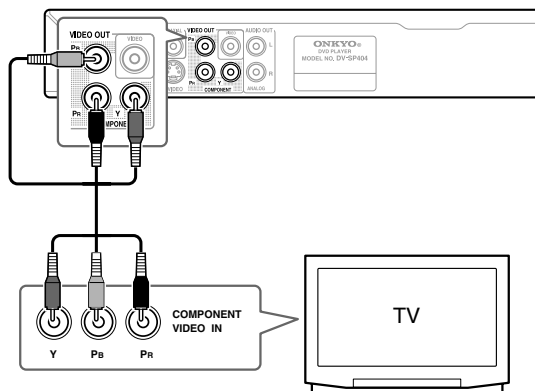

### Note:

- To set up the player for use with a progressive scan TV, see “Video Out settings – Component Out” on page 44.

### Using SCART (European model only)

If your TV has a SCART-type AV input, you can use a SCART cable to connect this player to your TV. This type of connection carries both the sound and the picture, so there’s no need to connect up the AUDIO OUT L/R and VIDEO OUT jacks.

- Use a SCART cable (not supplied) to connect the AV CONNECTOR to an AV input on your TV.

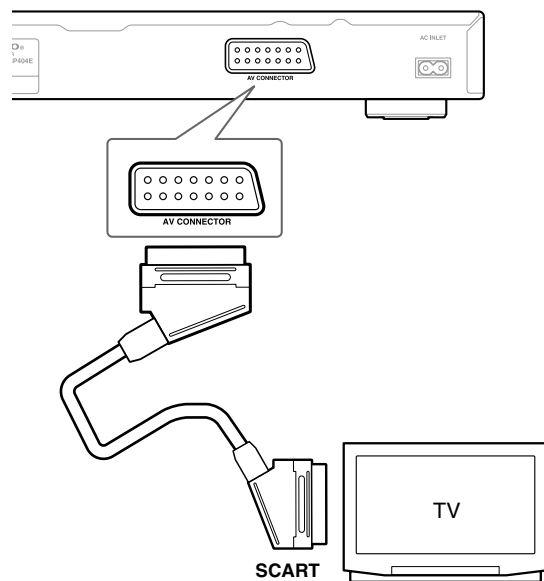

This connector can output composite video, or RGB video. The default setting is composite, which should work with all TVs. Consult the manual that came with your TV to see if you can use one of the higher quality settings. See page 44 for how to change the video output.

## Connecting the DV-SP404/DV-SP404E—Continued

### Using HDMI

If you have a HDMI equipped monitor or display, you can connect it to this player using a commercially available HDMI cable.

The HDMI connector outputs uncompressed digital video, as well as almost every kind of digital audio that the player is compatible with, including DVD-Video, Video CD, CD and MP3.

- Use an HDMI cable to connect the HDMI OUT interconnect on this player to an HDMI interconnect on a HDMI-compatible monitor.

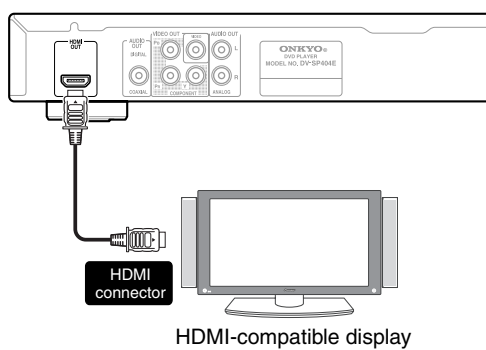

- The arrow on the cable connector body should be face up for correct alignment with the connector on the player.

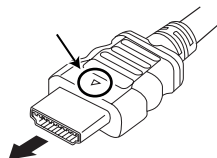

#### Notes:

- The player has been designed to be compliant with HDMI (High Definition Multimedia Interface). Depending on the component you have connected, using a DVI connection may result in unreliable signal transfers.
- When you change the component connected to the HDMI output, you will also need to change the HDMI settings to match the new component (see HDMI Out on page 43, HDMI Resolution on page 44 and HDMI Color on page 44 to do this). However, the settings for each component are then stored in memory (for up to 2 components).
- The HDMI connection is compatible with 44.1 kHz/48 kHz, 16 bit/20 bit/24 bit 2 channel linear PCM signals, as well as Doldy Digital, DTS and MPEG audio bitstream.

### About HDMI

HDMI (High Definition Multimedia Interface) supports both video and audio on a single digital connection for use with DVD players, DTV, set-top boxes, and other AV components. HDMI was developed to provide the technologies of High Bandwidth Digital Content Protection (HDCP) as well as Digital Visual Interface (DVI) in one specification. HDCP is used to protect digital content transmitted and received by DVI-compliant displays.

HDMI has the capability to support standard, enhanced, or high-definition video plus standard to multi-channel surround-sound audio. HDMI features include uncompressed digital video, a bandwidth of up to 2.2 gigabytes per second (with HDTV signals), one connector (instead of several cables and connectors), and communication between the AV source and AV components such as DTVs.

HDMI, the HDMI logo and High-Definition Multimedia Interface are trademarks or registered trademarks of HDMI licensing LLC.

### Resetting the output resolution to the default setting with HDMI connection

Switch the player to standby then, using the front panel controls, press STANDBY/ON while pressing **◀◀** to switch the player back to 576P/480P.

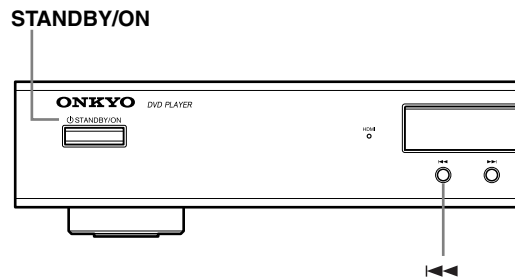

## Connecting the DV-SP404/DV-SP404E—Continued

### Connecting to an AV Receiver

Although you can reproduce the DVD Player's sound from the TV speakers with the connections on page 18, connecting with an amplifier provides you high quality dynamic sounds.

To reproduce Dolby Digital surround and DTS surround sound, you need to connect to an amplifier with a Dolby Digital and DTS decoder respectively.

#### Before connecting

- When you connect the DVD Player to the amplifier, be sure to turn off the power and unplug both units from the mains before making any connections. Otherwise, the speakers may be damaged.
- Connect the plugs securely.

To enjoy surround sound you need to connect this player to an AV receiver using a digital output.

Oceanian model has both coaxial and optical digital jacks; use whichever is convenient.

North American and European models have only coaxial digital jack.

In addition to a digital connection, we recommend also connecting using the stereo analog connection.

To record the audio from a CD-R disc etc. to a cassette or CDR recorder that's connected to the AV receiver, and when your AV receiver has Zone2, you must connect the DV-SP404/DV-SP404E's analog audio outputs to the AV receiver.

You'll probably also want to connect a video output to your AV receiver. You can use any of the video outputs available on this player (the illustration shows a standard (composite) connection).

#### 1. Connect the DIGITAL AUDIO OUT jack on this player to a digital input on your AV receiver.

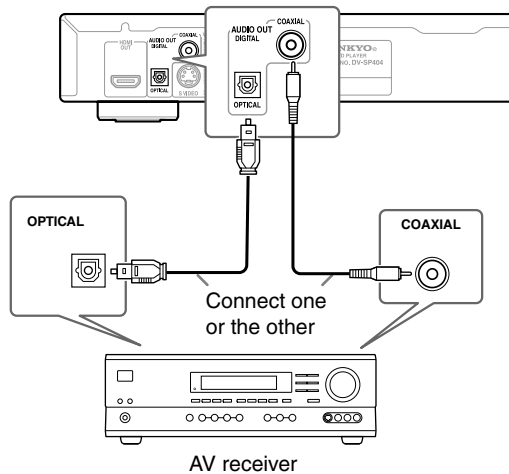

#### Note:

- North American and European models have only coaxial digital jack.

This enables you to listen to surround sound.

For a coaxial connection, use a coaxial cable (supplied) to connect the "COAXIAL DIGITAL AUDIO OUT" jack to a coaxial input on your AV receiver.

For an optical connection (Oceanian model only), use an optical cable (not supplied) to connect the "OPTICAL DIGITAL AUDIO OUT" jack to an optical input on your AV receiver.

#### 2. Connect the ANALOG AUDIO OUT L/R and VIDEO OUT jacks on this player to a set of analog audio and video inputs on your AV receiver.

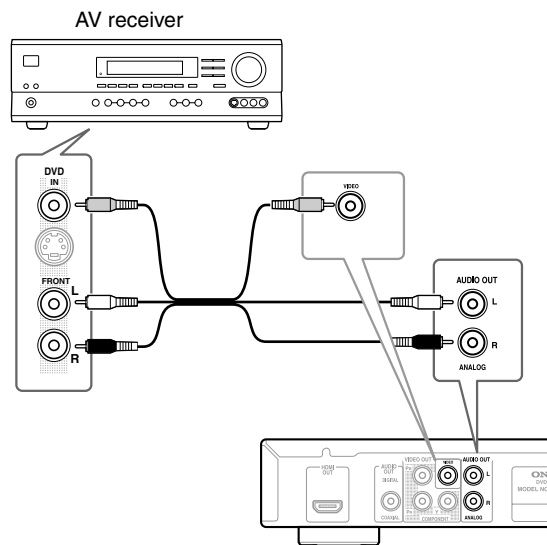

The diagram shows standard video connections, but you can alternatively use the S-Video or component video connections if they're available.

#### 3. Connect the AV receiver's video output to a video input on your TV.

#### Tip:

- You usually have to connect the same kind of video cable between your DVD player and AV receiver, and between your AV receiver and TV.

# Connecting the Power/Turning on the DV-SP404/ DV-SP404E

## Before connecting

- Make sure that all the connections on pages 17 – 22 are complete (the connection to a TV is required).

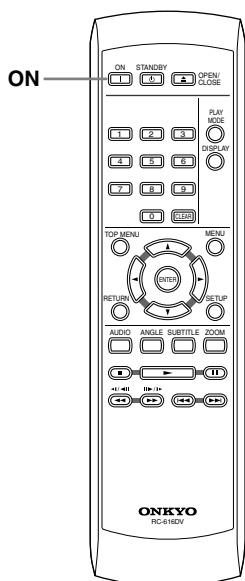
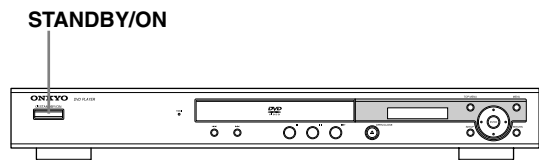

## 1

**North American model:**  
Connect the power cord into the power outlet on the wall.

**Oceanian and European model;**  
Plug the supplied power cord into the AC INLET and then into the power outlet on the wall.

- Do not use a power cord other than the one supplied with the DV-SP404/DV-SP404E. The power cord supplied is designed for use with the DV-SP404/DV-SP404E and should not be used with any other device.
- Never have the power cord disconnected from the DV-SP404/DV-SP404E while the other end is plugged into the wall outlet. Doing so may cause an electric shock. Always connect by plugging into the wall outlet last and disconnect by unplugging from the wall outlet first.

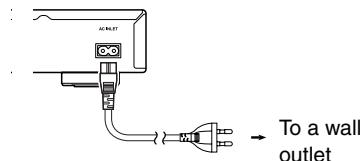

## 2

Press **STANDBY/ON** on the DV-SP404/DV-SP404E or **ON** on the remote controller.

The DVD Player turns on.

- To put the DV-SP404/DV-SP404E in the standby mode, press **STANDBY/ON** on the DV-SP404/DV-SP404E, or **STANDBY** on the remote controller. Be sure to set the volume to minimum before putting the DV-SP404/DV-SP404E in the standby mode for the next use to avoid sudden loud sound reproduction.
- Setting the **STANDBY/ON** button to standby does not shut off the power completely.

## Note:

- This player features a screen saver and an auto power off function. If the player is stopped and no button is pressed for five minutes, the screen saver starts. If the disc tray is closed but no disc is playing and no control is pressed for 30 minutes, the player automatically goes into standby.

# Getting Started

## Using the on-screen displays

For ease of use, this player makes extensive use of graphical on-screen displays (OSDs). All the screens are navigated in basically the same way, using the cursor (◀/▶/▲/▼) buttons to change the highlighted item and pressing ENTER to select it.

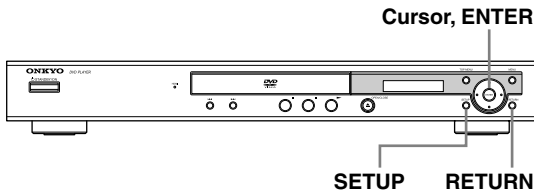
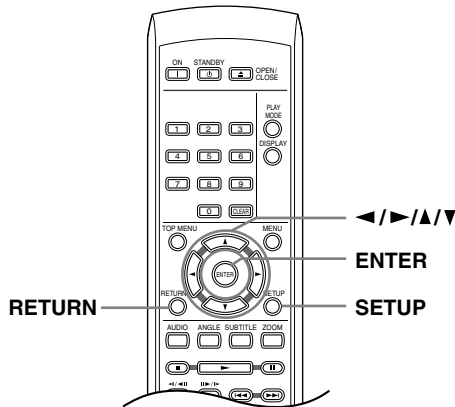

**Note:**

- From here on in this manual, the word “select” generally means use the cursor buttons to highlight an item on-screen, then press ENTER.

Button		What it does
Front Panel	Remote Controller	
		Display/exit the on-screen display.
		Changes the highlighted menu item.
		Selects the highlighted menu item (both ENTER buttons on the remote work in exactly the same way).
		Returns to the main menu without saving changes.

## Setting up the player for your TV

If you have a widescreen (16:9) TV, you should setup the player so that the picture will be presented correctly. If you have a conventional (4:3) TV, you can leave the player on the default setting and move on to the next section.

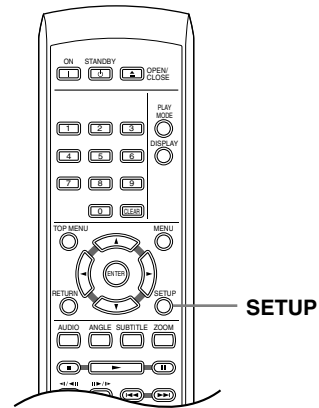

- 1 Press SETUP and select “Initial Settings”.**
- 2 Select “TV Screen” from the “Video Output” settings.**
- 3 If you have a widescreen (16:9) TV, select “16:9 (Wide)”.**

If you have a conventional (4:3) TV, you can change the setting from 4:3 (Letter Box) to 4:3 (Pan & Scan) if you prefer. See “Video Out settings” on page 44 for more details.
- 4 Press SETUP to exit the menu screen.**





## Getting Started—Continued

### Setting the language of this player's on-screen displays

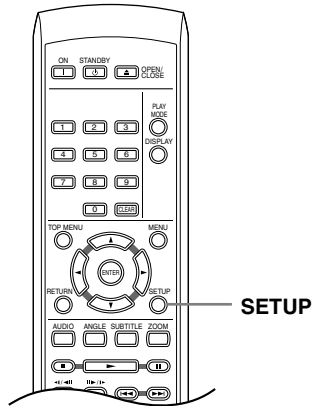
This sets the language of this system's on-screen displays.

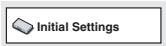
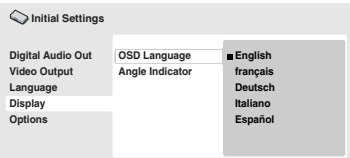

<p><b>1</b></p> 	<p><b>Press SETUP and select "Initial Settings".</b></p> 
<p><b>2</b></p>	<p><b>Select "OSD Language" from the "Display" settings.</b></p> 
<p><b>3</b></p>	<p><b>Select a language.</b> The on-screen language will change according to your selection.</p>
<p><b>4</b></p> 	<p><b>Press SETUP to exit the menu screen.</b></p>

## Getting Started—Continued

### Playing discs

The basic playback controls for playing DVD, CD, Video CD, DivX Video and MP3/WMA discs are covered here. Further functions are detailed in the next chapter.

For details on playing JPEG picture discs, see “Viewing a JPEG slideshow” on page 31.

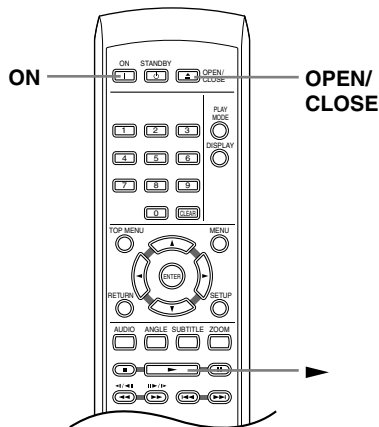
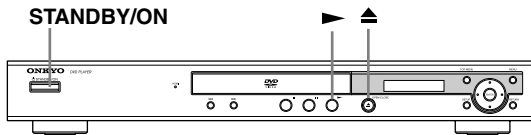

**1**

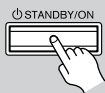

Remote controller

ON



**If the player isn't already on, press STANDBY/ON to switch it on.**

If you're playing a DVD disc containing DivX video files or Video CD, also turn on your TV and make sure that it is set to the correct video input.

**2**



Remote controller

OPEN/CLOSE



**Press ▲ OPEN/CLOSE to open the disc tray.**

**3**

### Load a disc.

Load a disc with the label side facing up, using the disc tray guide to align the disc (if you're loading a double-sided DVD disc, load it with the side you want to play face down).

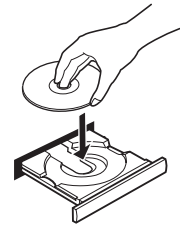

**4**

### Press ► (play) to start playback.



Remote controller

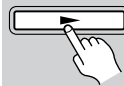

If you're playing a DVD or Video CD, an on-screen menu may appear. See “DVD-Video disc menus” on page 28 and “Video CD PBC menus” on page 28 for more on how to navigate these.

- If you're playing a containing DivX video files or MP3/WMA audio files, it may take a few seconds before playback starts. This is normal.

#### Notes:

- You may find with some DVD discs that some playback controls don't work in certain parts of the disc. This is not a malfunction.
- If a disc contains a mixture of DivX video and other media file types (MP3, for example), first select whether to play the DivX video files (DivX) or the other media file types (MP3/WMA/JPEG) from the on-screen display.

## Getting Started—Continued

### Basic playback controls

The table below shows the basic controls on the remote for playing discs. The following chapter covers other playback features in more detail.

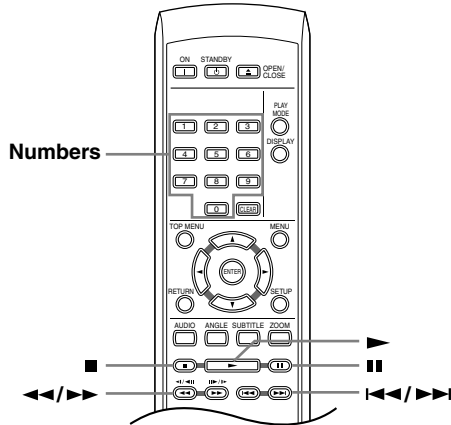

Button	What it does
	Starts playback. If the display shows RESUME or LAST MEM playback starts from the resume or last memory point (see also "Resume and Last Memory" on the adjacent column.)
	Pauses a disc that's playing, or restarts a paused disc.
	Stops playback. See also "Resume and Last Memory" on the adjacent column.
 (remote controller only)	Press to start fast reverse scanning. Press  (play) to resume normal playback.
 (remote controller only)	Press to start fast forward scanning. Press  (play) to resume normal playback.
	Skips to the start of the current track or chapter, then to previous tracks/chapters.
	Skips to the next track or chapter.
<b>Numbers</b> (remote controller only)	Use to enter a title/chapter/track number. Press ENTER to select. <ul style="list-style-type: none"> <li>• If the disc is stopped, playback starts from the selected title (for DVD) or track (for CD/Video CD).</li> <li>• If the disc is playing, playback jumps to the start of the selected title (VR mode DVD-RW), chapter (DVD-Video) or track (CD/Video CD)</li> </ul>

### Resume and Last Memory

When you stop playback of a disc, RESUME is shown in the display indicating that you can resume playback again from that point.

If the disc tray is not opened, the next time you start playback the display shows RESUME and playback resumes from the resume point.

With DVDs and Video CDs, if you take the disc out of the player, the play position is stored in memory. If the next disc you load is the same one, the display shows LAST MEM and playback will resume.

If you want to clear the resume point, press (stop) while RESUME is displayed.

#### Notes:

- The Last Memory function doesn't work with VR format DVD-RW discs.
- If you don't need the Last Memory function when you stop a disc, you can press (stop) button again to stop playback and then press OPEN/CLOSE to open the disc tray.

## Getting Started—Continued

### DVD-Video disc menus

Many DVD-Video discs feature menus from which you can select what you want to watch. They may also give access to additional features, such as subtitle and audio language selection, or special features such as slide-shows. See the disc packaging for details.

Sometimes DVD-Video menus are displayed automatically when you start playback; others only appear when you press MENU or TOP MENU.

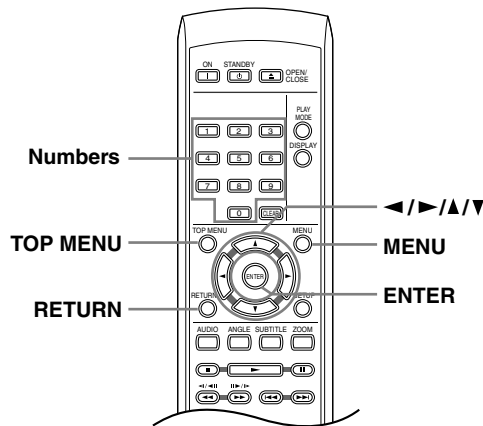

Button	What it does
<b>TOP MENU</b>	Displays the “top menu” of a DVD disc—this varies with the disc.
<b>MENU</b>	Displays a DVD disc menu—this varies with the disc and may be the same as the “top menu”.
◀/▶/▲/▼	Moves the cursor around the screen.
<b>ENTER</b>	Selects the current menu option.
<b>RETURN</b>	Returns to the previously displayed menu screen.
<b>Numbers (remote controller only)</b>	Highlights a numbered menu option (some discs only). Press ENTER to select.

### Video CD PBC menus

Some Video CD have menus from which you can choose what you want to watch. These are called PBC (Playback control) menus.

You can play a PBC Video CD without having to navigate the PBC menu by starting playback using a number button to select a track, rather than the ▶ (play) button.

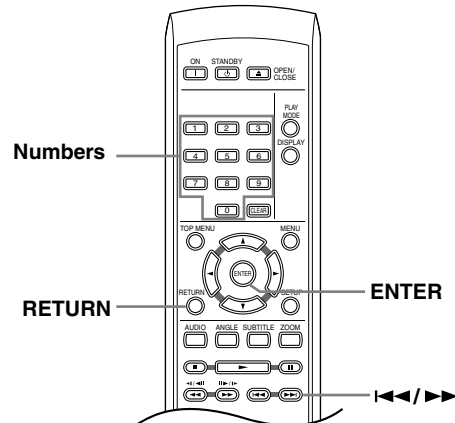

Button	What it does
<b>RETURN</b>	Displays the PBC menu.
<b>Numbers (remote controller only)</b>	Use to enter a numbered menu option. Press ENTER to select.
◀◀	Displays the previous menu page (if there is one).
▶▶	Displays the next menu page (if there is one).

## Getting Started—Continued

---

### Hint:

- After I load a DVD disc, it ejects automatically after a few seconds!
  - Most likely, the disc is the wrong region for your player. The region number should be printed on the disc; check it against the region number of the player (which you can find on the rear panel). See also DVD-Video regions on page 50.
  - If the region number is OK, it may be that the disc is damaged or dirty. Clean the disc and look for signs of damage. See also Taking care of your player and discs on page 10.
- Why won't the disc I loaded play?
  - First check that you loaded the disc the right way up (label side up), and that it's clean and undamaged. See Taking care of your player and discs on page 10 for information on cleaning discs.
  - If a disc loaded correctly won't play, it's probably an incompatible format or disc type, such as DVD-Audio or DVD-ROM. See Supported Discs on page 8 for more on disc compatibility.
- I have a widescreen TV so why are there black bars at the top and bottom of the screen when I play some discs?
  - Some movie formats are such that even when played on a widescreen TV, black bars are necessary at the top and bottom of the screen. This is not a malfunction.
- I have a standard (4:3) TV and set the player to show widescreen DVDs in pan & scan format, so why do I still get black bars top and bottom with some discs?
  - Some discs override the display preferences of the player, so even if you have 4:3 (Pan & Scan) selected, those discs will still be shown in letter box format.  
This is not a malfunction.
- I've connected to a HDMI compatible component but I can't get any signal and the front panel HDMI indicator won't light!
  - Make sure that you've selected this player as the HDMI input in the settings for the component you're using. You may need to refer to the instruction manual of the component to do this. See Connecting using HDMI on page 21 for more on HDMI compatibility.
- There's no picture from the HDMI output!
  - This player cannot display pictures from DVI compatible sources. See Connecting using HDMI on page 21 for more on HDMI compatibility. Make sure the resolution on this player matches that of the component you have connected using HDMI. See HDMI Resolution on page 44 to change the HDMI resolution.

# Playing discs

**Notes:**

- Many of the functions covered in this chapter apply to DVD discs, Video CDs, CDs, DivX Video and MP3/JPEG discs, although the exact operation of some varies slightly with the kind of disc loaded.
- Some DVDs restrict the use of some functions (random or repeat, for example) in some or all parts of the disc. This is not a malfunction.
- When playing Video CD, some of the functions are not available during PBC playback. If you want to use them, start the disc playing using a number button to select a track.

## Scanning discs

You can fast-scan discs forward or backward at four different speeds (DivX video only one speed).

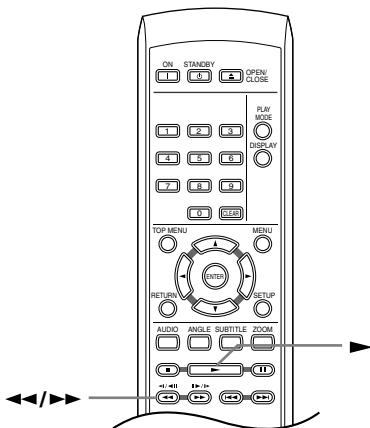

<b>1</b>	<p><b>During playback, press ◀◀ or ▶▶ to start scanning.</b></p> <ul style="list-style-type: none"> <li>• There is no sound while scanning DVDs, DivX Video and Video CDs.</li> </ul>
<b>2</b>	<p><b>Press repeatedly to increase the scanning speed.</b></p> <ul style="list-style-type: none"> <li>• The scanning speed is shown on-screen.</li> </ul>
<b>3</b>	<p><b>To resume normal playback, press ▶ (play).</b></p> <ul style="list-style-type: none"> <li>• When scanning a Video CD playing in PBC mode or a WMA/MP3 track, playback automatically resumes at the end or beginning of the track.</li> <li>• Depending on the disc, normal playback may automatically resume when a new chapter is reached on a DVD disc.</li> </ul>

## Playing in slow motion

You can play DVDs at four different slow motion speeds, forwards and backwards. Video CD and DivX Video can be played at four different forward slow motion speeds.

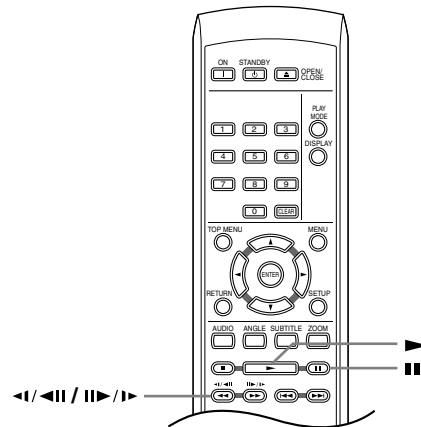

<b>1</b>	<p><b>During playback, press    (pause).</b></p>
<b>2</b>	<p><b>Press and hold ◀◀/◀   or   /▶▶ until slow motion playback starts.</b></p> <ul style="list-style-type: none"> <li>• The slow motion speed is shown on-screen.</li> <li>• There is no sound during slow motion playback.</li> </ul>
<b>3</b>	<p><b>Press repeatedly to change the slow motion speed.</b></p>
<b>4</b>	<p><b>To resume normal playback, press ▶ (play).</b></p> <ul style="list-style-type: none"> <li>• Depending on the disc, normal playback may automatically resume when a new chapter is reached.</li> </ul>

**Note:**



- Backward slow-motion playback does not work with Video CD and DivX Video.

## Playing discs—Continued

### Frame advance/frame reverse

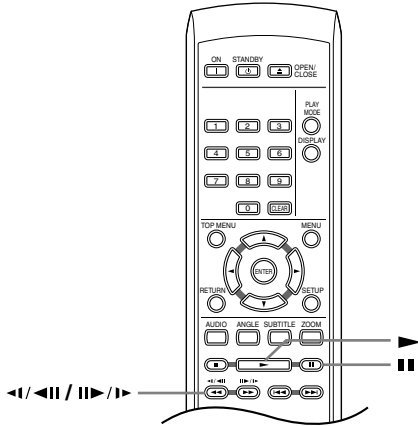
You can advance or back up DVD discs frame-by-frame. With Video CD and DivX Video you can only use frame advance.

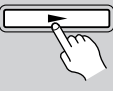

- 1** During playback, press **||** (pause).
 
- 2** Press **<|/|>** or **||>|/|>** to reverse or advance a frame at a time.
 
- 3** To resume normal playback, press **▶** (play).
  - Depending on the disc, normal playback may automatically resume when a new chapter is reached.

**Note:**

- Backward frame-by-frame playback does not work with Video CD and DivX Video.

### Viewing a JPEG slideshow

After loading a CD/CD-R/RW containing JPEG picture files, press **▶** (play) to start a slideshow from the first folder/picture on the disc. The player displays the pictures in each folder in alphabetical order.

- If the folder contains WMA/MP3 files, playback of the slideshow and WMA/MP3 files repeats. During the audio playback, you can still use the skip (**<<<|/|>>>**), scan (**<<<|/|>>>**) and pause (**||**) functions.

Pictures are automatically adjusted so that they fill as much of the screen as possible (if the aspect ratio of the picture is different to your TV screen you may notice black bars at the sides, or at the top and bottom of the screen).

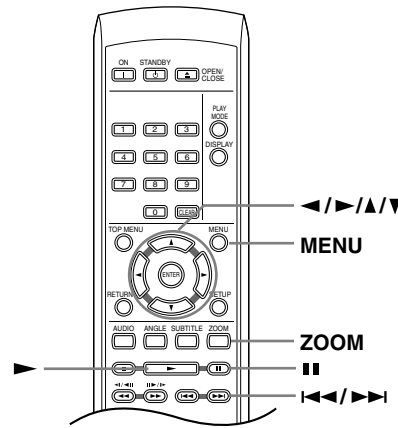

**While the slideshow is running:**

Button	What it does
<b>  </b>	Pauses the slideshow; press again to restart.
<b>&lt;&lt;&lt; / &gt;&gt;&gt;</b>	Displays the previous picture.
<b>&gt;&gt;&gt; / &lt;&lt;&lt;</b>	Displays the next picture.
<b>&lt; / &gt;</b>	Pauses the slideshow and rotates the displayed picture 90° (counter)clockwise. (Press <b>▶</b> (play) to restart slideshow).
<b>▲/▼</b>	Pauses the slideshow and flips the displayed picture horizontally or vertically. (Press <b>▶</b> (play) to restart slideshow).
<b>ZOOM</b>	Pauses the slideshow and zooms the picture. Press again to toggle between 1x, 2x and 4x zoom. (Press <b>▶</b> (play) to restart slideshow).
<b>MENU</b>	Displays the Disc Navigator screen (see below).

**Notes:**

- The time it takes for the player to load a file increases with large file sizes.

## Playing discs—Continued

### Browsing video content with the Disc Navigator

Use the Disc Navigator to browse through the contents of a DVD or Video CD disc to find the part you want to play.

**Important:**

- You can't use the Disc Navigator with Video CD in PBC mode.

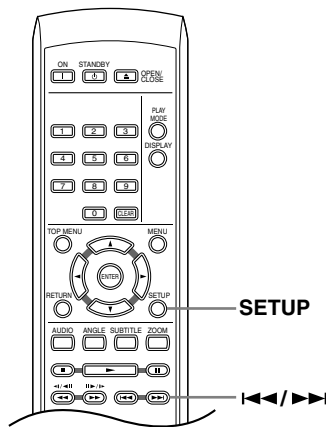

**1**



During playback, press **SETUP** and select "Disc Navigator" from the on-screen menu.



**2**

Select a view option.

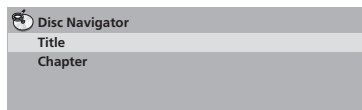

The options available depend on the kind of disc loaded and whether the disc is playing or not, but include:

- Title** – Titles from a DVD-Video disc.
- Chapter** – Chapters from the current title of a DVD-Video disc.
- Track** – Tracks from a Video CD disc.
- Time** – Thumbnails from a Video CD disc at 10 minute intervals.
- Original: Title** – Original titles from a VR mode DVD-RW disc.

- Play List: Title** – Playlist titles from a VR mode DVD-RW disc.
- Original: Time** – Thumbnails from the Original content at 10 minute intervals.
- Play List: Time** – Thumbnails from the Playlist at 10 minute intervals.

The screen shows up to six moving thumbnail images displayed one after another. To display the previous/next six thumbnails, press **◀/▶** (you don't have to wait for all the thumbnails to finish playing to display the previous/next page).

**3**



Select the thumbnail image for what you want to play.

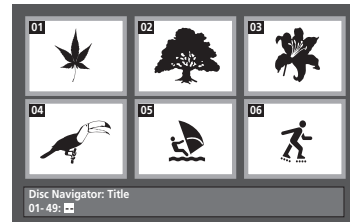

You can use either the cursor (**◀/▶/▲/▼**) buttons and **ENTER** to select a thumbnail, or the number buttons.

To select using the number buttons, enter a two-digit number then press **ENTER**.

**Tip:**

- Another way to find a particular place on a disc is to use one of the search modes. See "Searching a disc" on page 37.



## Playing discs—Continued

### Browsing WMA, MP3, DivX Video and JPEG files with the Disc Navigator

Use the Disc Navigator to find a particular file or folder by filename. Note that if there are other types of files on the same disc, these will not be displayed in the Disc Navigator.

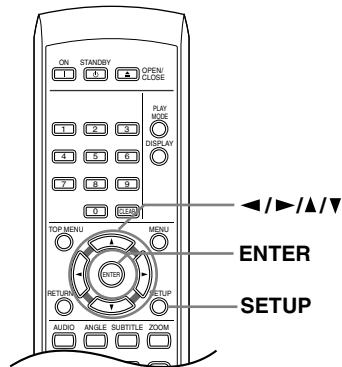

3



To play the highlighted track or DivX Video file, or to display the highlighted JPEG file, press **ENTER**.

- When a WMA/MP3 or DivX Video file is selected, playback begins, starting with the selected track, and continues until the end of the folder.
- When a JPEG file is selected, a slideshow begins, starting with that file, and continues to the end of the folder.

**Tip:**

- To play the contents of the whole disc rather than just the current folder, exit the Disc Navigator and start playback using the ► (play) button.
- You can also play a JPEG slideshow while listening to WMA/MP3 playback. Simply select the audio file you want to listen to followed by the JPEG from which you want the slideshow to start. Playback of both the slideshow and the audio files repeats. Playback controls are effective for the JPEG slideshow only.

1



Press **SETUP** and select “Disc Navigator” from the on-screen menu.

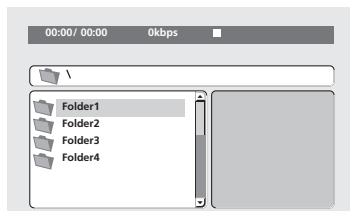

2



Use the cursor (▲/▼/◀/▶) buttons and **ENTER** to navigate.

Use the cursor up/down (▲/▼) buttons to move up and down the folder/file list. Use the cursor left (◀) button to return to the parent folder. Use **ENTER** or cursor right (▶) button to open a highlighted folder.

- You can also return to the parent folder by going to the top of the list to the “..” folder, then pressing **ENTER**.
- When a JPEG file is highlighted, a thumbnail image is displayed on the right.

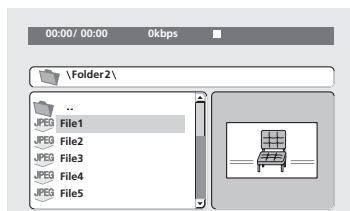

## Playing discs—Continued

### Looping a section of a disc

The A-B Repeat function allows you to specify two points (A and B) within a track (CD, Video CD) or title (DVD) that form a loop which is played over and over.

- You can't use A-B Repeat with Video CD in PBC mode, or WMA/MP3/DivX Video files.

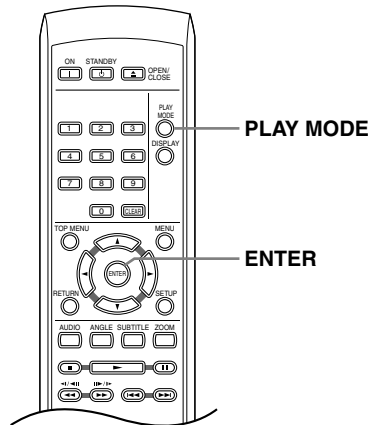

### Using repeat play

There are various repeat play options, depending on the kind of disc loaded. It's also possible to use repeat play together with program play to repeat the tracks/chapters in the program list (see "Creating a program list" on page 36).

#### Important:

- You can't use Repeat play with Video CD in PBC mode, or with WMA/MP3 discs.
- You can't use repeat and random play at the same time.

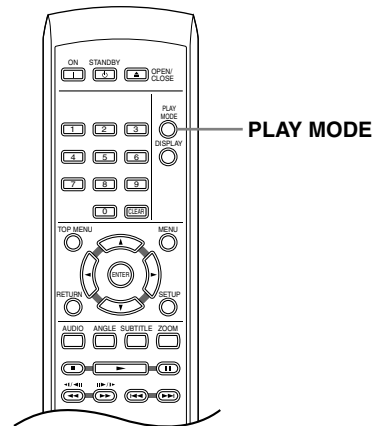

- 1** During playback, press **PLAY MODE** and select "A-B Repeat" from the list of functions on the left.

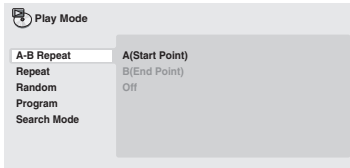

- 2** Press **ENTER** on "A(Start Point)" to set the loop start point.

- 3** Press **ENTER** on "B(End Point)" to set the loop end point.  
After pressing ENTER, playback jumps back to the start point and plays the loop.

- 4** To resume normal playback, select "Off" from the menu.

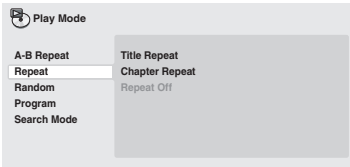
- 1** During playback, press **PLAY MODE** and select "Repeat" from the list of functions on the left.

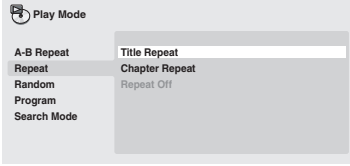

- 2** Select a repeat play option.  
If program play is active, select Program Repeat to repeat the program list, or Repeat Off to cancel.  
The repeat options available depend on the kind of disc loaded. For example, for DVD discs, you can select Title Repeat or Chapter Repeat (or Repeat Off).

  - For CDs and Video CD, select Disc Repeat or Track Repeat (or Repeat Off).
  - For DivX video discs, select Title Repeat (or Repeat Off).

## Playing discs—Continued

### Using random play

Use the random play function to play titles or chapters (DVD-Video) or tracks (CD, Video CD) at random. (Note that the same track/title/chapter may play more than once.)

You can set the random play option when a disc is playing or stopped.

**Important:**

- Random play remains in effect until you select Random Off from the random play menu options.
- You can't use random play with VR format DVD-RW discs, Video CD playing in PBC mode, WMA/MP3 discs, or while a DVD disc menu is being displayed.
- You can't use random play together with program or repeat play.

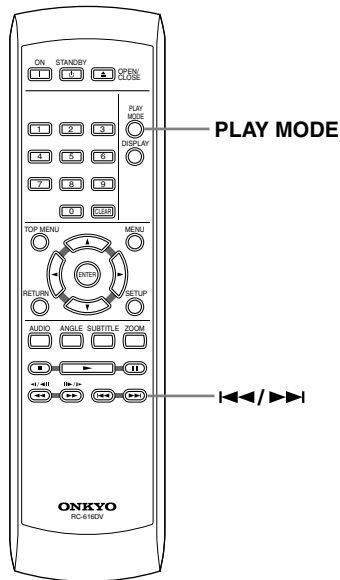

**1**

Press **PLAY MODE** and select **"Random"** from the list of functions on the left.



**2**

Select a random play option.

The random play options available depend on the kind of disc loaded. For example, for DVD discs, you can select Random Title or Random Chapter, (or Random Off).



- For CDs and Video CD, select On or Off to switch random play on or off.

**Tip:**

- Use the following controls during random play:

Button	What it does
	Selects a new track/title/chapter at random.
	Returns to the beginning of the current track/title/chapter; further presses select another random track/title/chapter.

## Playing discs—Continued

### Creating a program list

This feature lets you program the play order of titles/chapters/tracks on a disc.

**Important:**

- You can't use Program play with VR format DVD-RW discs, Video CD playing in PBC mode, WMA/MP3 discs, or while a DVD disc menu is being displayed.

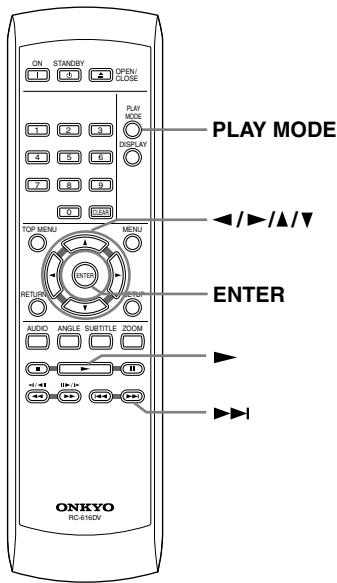

**1**

PLAY MODE

**Press PLAY MODE and select "Program" from the list of functions on the left.**

Play Mode

A-B Repeat	Create/Edit
Repeat	Playback Start
Random	Playback Stop
Program	Program Delete
Search Mode	

---

**2**

**Select "Create/Edit" from the list of program options.**

**3** Use the cursor (▲/▼/◀/▶) buttons and ENTER to select a title, chapter or track for the current step in the program list.

For a DVD disc, you can add a title or a chapter to the program list.

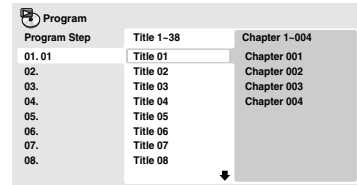

- For a CD or Video CD, select a track to add to the program list.

After pressing ENTER to select the title/chapter/track, the step number automatically moves down one.

**4** Repeat step 3 to build up a program list.

A program list can contain up to 24 titles/chapters/tracks.

- You can insert steps into the middle of a program list by just highlighting the position where you want the new step to appear and entering a title/chapter/track number.
- To delete a step, highlight it and press CLEAR.

**5** To play the program list, press ► (play).

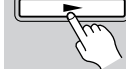

Program play remains active until you turn off program play (see below), erase the program list (see below), eject the disc or switch off the player.

**Tip:**

- Use the following controls during program play:

Button	What it does
PLAY MODE	Save the program list and exit the program edit screen without starting playback (SETUP does the same).
▶▶	Skip to the next step in the program list.

## Playing discs—Continued

### Other functions available from the program menu

There are a number of other options in the program menu in addition to Create/Edit.

- **Playback Start** – Starts playback of a saved program list
- **Playback Stop** – Turns off program play, but does not erase the program list
- **Program Delete** – Erases the program list and turns off program play

### Searching a disc

You can search DVD discs by title or chapter number, or by time; CDs and Video CD by track number or time; DivX Video discs by time.

#### Important:

- Search functions are not available with Video CD in PBC mode, or with WMA/MP3 discs.

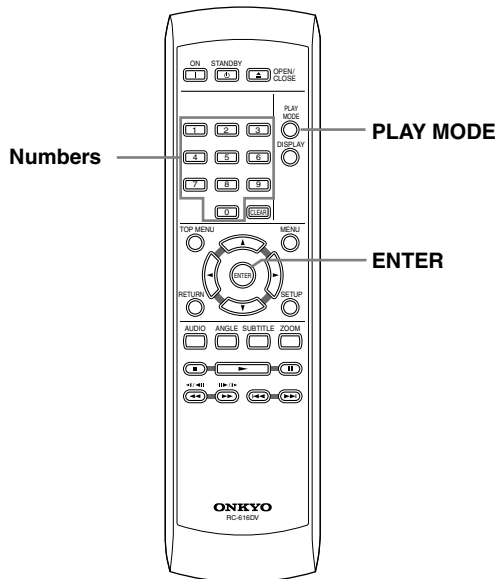

**3**

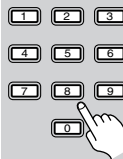

Use the number buttons to enter a title, chapter or track number, or a time.

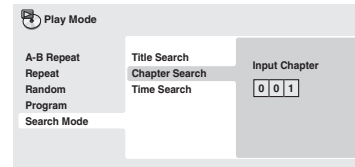

- For a time search, enter the number of minutes and seconds into the currently playing title (DVD) or track (CD/Video CD) you want playback to resume from. For example, press 4, 5, 0, 0 to have playback start from 45 minutes into the disc. For 1 hour, 20 minutes and 30 seconds, press 8, 0, 3, 0.

**4**



Press ENTER to start playback.

**1**

PLAY MODE



Press **PLAY MODE** and select **“Search Mode”** from the list of functions on the left.

The search options available depend on the kind of disc loaded.

**2**

Select a search mode.

- The disc must be playing in order to use time search.

## Playing discs—Continued

### Switching subtitles

Some DVD or DivX Video discs have subtitles in one or more languages; the disc box will usually tell you which subtitle languages are available. You can switch subtitle language during playback.

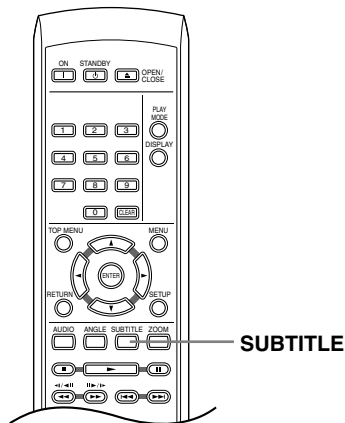

**1**

SUBTITLE



**Press SUBTITLE repeatedly to select a subtitle option.**

Current / Total  
Subtitle 1/2 English

**Notes:**

- Some discs only allow you to change subtitle language from the disc menu. Press TOP MENU or MENU to access.
- To set subtitle preferences, see “Language settings” on page 45.

- See Displaying DivX subtitle files on page 9 for more on DivX subtitle.

### Switching audio language/channel

When playing a DVD or DivX Video disc recorded with dialog in two or more languages, you can switch audio language during playback.

When playing a VR format DVD-RW disc recorded with dual-mono audio, you can switch between the main, sub, and mixed channels during playback.

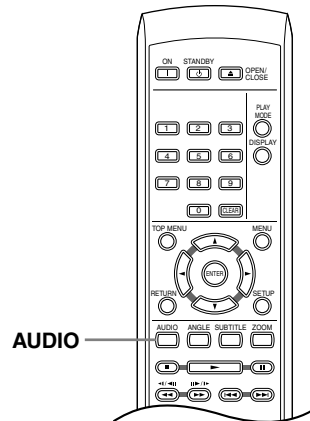

When playing a Video CD, you can switch between stereo, just the left channel or just the right channel.

**1**

AUDIO



**Press AUDIO repeatedly to select an audio language/channel option.**

The language/channel information is shown on-screen.

**Notes:**

- Some DVD discs only allow you to change audio language from the disc menu. Press TOP MENU or MENU to access.
- To set DVD audio language preferences, see “Language settings” on page 45.

## Playing discs—Continued

### Zooming the screen

Using the zoom feature you can magnify a part of the screen by a factor of 2 or 4, while watching a DVD, DivX Video title or Video CD, or playing a JPEG disc.

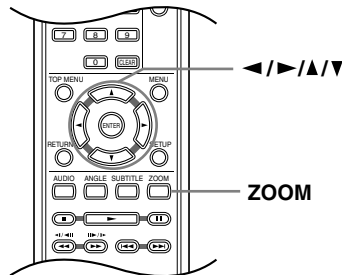

**1**



**During playback, use the ZOOM button to select the zoom factor (Normal, 2x or 4x).**

- Since DVD, DivX Video title, Video CD and JPEG pictures have a fixed resolution, picture quality will deteriorate, especially at 4x zoom. This is not a malfunction.

**2**

**Use the cursor (▲/▼/◀/▶) buttons to change the zoomed area.**

You can change the zoom factor and the zoomed area freely during playback.

- If the navigation square at the top of the screen disappears, press ZOOM again to display it.

### Switching camera angles

Some DVD discs feature scenes shot from two or more angles—check the disc box for details.

When a multi-angle scene is playing, a  icon appears on screen to let you know that other angles are available (this can be switched off if you prefer—see “Display settings” on page 45).

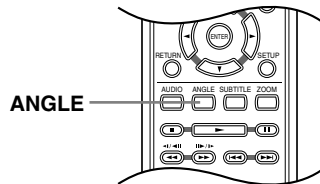

**1**



**During playback, press ANGLE to switch angle.**

### Displaying disc information

Various track, chapter and title information, such as the elapsed and remaining playing time can be displayed on-screen while a disc is playing.

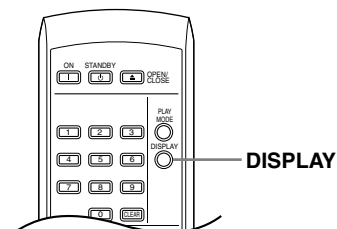

**1**



**To show/switch/hide the information displayed, press DISPLAY repeatedly.**

- When a disc is playing, the information appears at the top of the screen.



# Audio Settings and Video Adjust menus

## Audio Settings menu

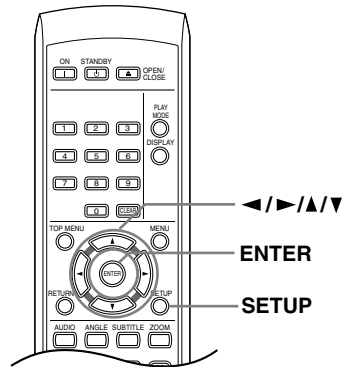

The Audio Settings menu offers features for adjusting the way discs sound.



**1** Press **SETUP** and select “Audio Settings” from the on-screen display.

**2** Select and change settings using the cursor (▲/▼/◀/▶) buttons, and **ENTER**.

## Dialog

- Settings: High, Medium, Low, Off (default)

The Dialog feature is designed to make the dialog stand out from other background sounds in the soundtrack.

## Equalizer

- Settings: Rock, Pop, Live, Dance, Techno, Classic, Soft, Off (default)

The various preset EQ curves are designed to suit various styles of music.

**Note:**

- 96kHz linear PCM audio is automatically downsampled to 48kHz if the Equalizer is switched on.

## Audio DRC

- Settings: High, Medium, Low, Off (default)

When watching Dolby Digital DVDs at low volume, it's easy to lose the quieter sounds completely—including some of the dialog. Switching Audio DRC (Dynamic Range Control) to on can help by bringing up the quieter sounds, while controlling loud peaks.

How much of a difference you hear depends on the material you're listening to. If the material doesn't have wide variations in volume, you may not notice much change.

**Notes:**

- Audio DRC is only effective with Dolby Digital audio sources.
- Audio DRC is only effective through the digital output when Digital Out is set to On, and Dolby Digital Out is set to Dolby Digital > PCM (see “Digital Audio Out settings” on page 43).
- The effect of Audio DRC depends on your speakers and AV receiver settings.

## Virtual Surround

- Settings: On, Off (default)

Switch on Virtual Surround to enjoy realistic surround sound effects from just two speakers.

**Notes:**

- Virtual Surround doesn't work with DTS, through either the analog or digital outputs.
- 96kHz linear PCM audio is automatically downsampled to 48kHz if Virtual Surround is switched on.
- If the player is outputting Dolby Digital, DTS or MPEG bitstream audio (in other words, no conversion to PCM), Virtual Surround has no effect on the audio from the digital output. See Digital Audio Out settings on page 43 for how to set up the digital output formats.
- How good the surround effect is varies with the disc.





# Initial Settings menu

## Using the Initial Settings menu

The Initial Settings menu provides audio and video output settings, parental lock settings, and display settings, among others.

If an option is grayed out it means that it cannot be changed at the current time. This is usually because a disc is playing. Stop the disc, then change the setting.

- The Digital Audio Out, Component Out and AV Connector Out settings cannot be set if the player is connected to an HDMI compatible component using the HDMI connector.

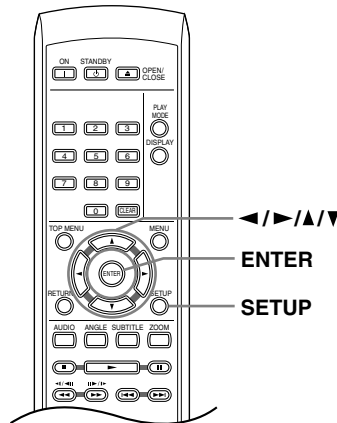

<p><b>1</b></p>	<p><b>Press SETUP and select "Initial Settings".</b></p>
<p><b>2</b></p>	<p><b>Use the cursor (▲/▼/◀/▶) buttons and ENTER to select the setting and option you want to set.</b></p> <p>All the settings and options are explained on the following pages.</p>

**Notes:**

- In the table on next pages, the default setting is shown in bold: other settings are shown in italics.
- The Digital Audio Out settings only need to be set if you have connected the digital output of this player to an AV receiver, or other equipment.
- Check the operating instructions supplied with your other equipment to see which digital audio formats it's compatible with.
- Some settings, such as TV Screen, Audio Language and Subtitle Language may be overridden by the DVD disc. Often these settings can also be made from the DVD disc menu.
- The HDMI Out, HDMI Resolution and HDMI Color settings only need to be set if you connected this player to an HDMI compatible component using the HDMI connector.

## Initial Settings menu—Continued

### Digital Audio Out settings

Setting	Option	What it means
<b>Digital Out</b>	<b>On</b>	Digital audio is output from the digital outputs.
	Off	No digital audio output.
<b>Dolby Digital Out</b>	<b>Dolby Digital</b>	Dolby Digital encoded digital audio is output when playing a Dolby Digital DVD disc.
	Dolby Digital > PCM	Dolby Digital audio is converted to PCM audio before being output.
<b>DTS Out</b>	<b>DTS</b>	DTS encoded digital audio is output when playing a DTS disc. (Noise will be output if your amplifier/receiver is not compatible with DTS audio.)
	Off	No digital audio is output when playing a DTS disc.
<b>96 kHz PCM Out</b>	<b>96kHz &gt; 48kHz</b>	96kHz digital audio is converted to 48kHz for digital output.
	96kHz	96kHz digital audio is output as is at 96kHz.
<b>MPEG Out</b>	<b>MPEG &gt; PCM</b>	MPEG encoded digital audio is converted to PCM audio for digital output.
	MPEG	MPEG encoded digital audio is output as is.
<b>HDMI Out</b>	<b>LPCM (2 CH)</b>	Set if your monitor or device only accepts stereo input. On this setting multichannel audio is downmixed to 2 channels for stereo linear PCM output. (In case of DTS source, the HDMI audio output is turned off.)
	Auto	Dolby Digital, DTS and MPEG sources are processed according to how they were encoded, but if your amplifier/monitor is not compatible with DTS audio, DTS audio output from HDMI is turned off. Linear PCM sources are heard as is.
	Off	No digital audio output.

## Initial Settings menu—Continued

### Video Out settings

Setting	Option	What it means
<b>TV Screen</b> (This setting effective for analog and HDMI video output. See also "Screen sizes and disc formats" on page 49.)	<b>4:3 (Letter Box)</b>	Set if you have a conventional 4:3 TV. Widescreen movies are shown with black bars top and bottom.
	4:3 (Pan & Scan)	Set if you have a conventional 4:3 TV. Widescreen movies are shown with the sides cropped so that the image fills the screen.
	16:9 (Wide)	Set if you have a widescreen TV.
<b>Component Out</b>	<b>Interlace</b>	Set if your TV is not compatible with progressive scan video.
	Progressive	Set if your TV is compatible with progressive scan video (see your TV's instruction manual for details). See also "Switching the video output to interlace using the front panel controls" on page 19. Note that progressive scan video is only output from the component video jacks and that there is no output from the composite and S-video jacks when this setting is selected.
<b>AV Connector Out</b> (European model only)	<b>Video</b>	Ordinary (composite) video output, compatible with all TVs.
	RGB	If your TV is compatible, this setting gives the best picture quality. Note that there is no output from the component jacks when this setting is selected.
<b>HDMI Resolution</b> (Default changes with TV format (PAL/NTSC).)	1920x1080i	Set if your TV supports 1920 x 1080 pixel interlace video.
	1280x720p	Set if your TV supports 1280 x 720 pixel progressive-scan video.
	<b>720x480p (NTSC)/ 720x576p (PAL)</b>	Set if your TV supports 720 x 480 pixel (NTSC)/720 x 576 pixel (PAL) progressive-scan video.
	720x480i (NTSC)/ 720x576i (PAL)	Set if your TV supports 720 x 480 pixel (NTSC)/720 x 576 pixel (PAL) interlace video.
<b>HDMI Color</b> (Default changes depending on device connected.)	Full range RGB	If colors are weak, this gives brighter colors and deeper black.
	RGB	Use this setting if colors appear overly rich on the Full Range RGB setting.
	Component	Outputs component video format (default setting for HDMI-compatible devices).

## Initial Settings menu—Continued

### Language settings

Setting	Option	What it means
<b>Audio Language</b> *1	<b>English</b>	If there is an English soundtrack on the disc then it will be played.
	Languages as displayed	If there is the language selected on the disc, then it will be played.
	Other Language	Select to choose a language other than the ones displayed (see page 50).
<b>Subtitle Language</b> *2 (See also Displaying DivX subtitle files on page 9.)	<b>English</b>	If there is an English subtitles on the disc then they will be displayed.
	Languages as displayed	If there is the subtitle language selected on the disc, then it will be displayed.
	Other Language	Select to choose a language other than the ones displayed (see page 50).
<b>DVD Menu Lang.</b> *3	<b>w/Subtitle Lang.</b>	DVD disc menus will be displayed in the same language as your selected subtitle language, if possible.
	Languages as displayed	DVD disc menus will be displayed in the selected language, if possible.
	Other Language	Select to choose a language other than the ones displayed (see page 50).
<b>Subtitle Display</b>	<b>On</b>	Subtitles are displayed according to your selected subtitle language (see above).
	<b>Off</b>	Subtitles are always off by default when you play a DVD disc (note that some discs override this setting).

\*1 This setting is your preferred audio language for DVD discs.

You can switch between the languages recorded on a DVD disc during playback using the AUDIO button.

Some DVD discs set the audio language automatically when loaded, overriding the “Audio Language” setting.

Discs with two or more audio languages usually allow you to select the audio language from the disc menu. Press MENU to access the disc menu.

\*2 This setting is your preferred subtitle language for DVD discs.

You can change or switch off the subtitles on a DVD disc during playback using the SUBTITLE button.

Some DVD discs set the subtitle language automatically when loaded, overriding the “Subtitle Language” setting.

Discs with two or more subtitle languages usually allow you to select the subtitle language from the disc menu. Press MENU to access the disc menu.

\*3 Some multilingual discs have disc menus in several languages. This setting specifies in which language the disc menus should appear. Leave on the default setting for menus to appear in the same language as your “Subtitle Language”.

### Display settings

Setting	Option	What it means
<b>OSD Language</b>	<b>English</b>	On-screen displays of the player are in English.
	Languages as displayed	On-screen displays are shown in the language selected.
<b>Angle Indicator</b>	<b>On</b>	A camera icon is displayed on-screen during multi-angle scenes on a DVD disc.
	<b>Off</b>	No multi-angle indication is shown.

### Optional settings

Setting	Option	What it means
<b>Parental Lock</b>	-	See Parental Lock on page 46.
<b>DivX VOD</b>	Display	See About DivX® VOD content on page 48.

## Initial Settings menu—Continued

### Parental Lock

- Default level: Off; Default password: none; Default Country/Area code: us (2119)

To give you some control over what your children watch on your DVD player, some DVD-Video discs feature a Parental Lock level. If your player is set to a lower level than the disc, the disc won't play.



Some discs also support the Country/Area Code feature. The player does not play certain scenes on these discs, depending on the Country/Area code you set.

#### Notes:

- Not all discs use Parental Lock, and will play without requiring the password first.
- If you forget your password, you'll need to reset the player to register a new password. (see page 49)

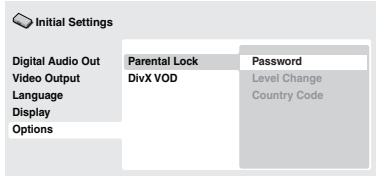

### Registering a new password

You must register a password before you can change the Parental Lock level or enter a Country/Area code.



<b>1</b>	<p>Select "Password".</p> 
<b>2</b>	<p>Use the number buttons to enter a 4-digit password.</p> <p>The numbers you enter show up as asterisks (*) on-screen.</p> 
<b>3</b>	<p>Press ENTER to register the password.</p> <p>You will return to the Options menu screen.</p> 

### Changing your password

To change your password, confirm your existing password then enter a new one.

<b>1</b>	Select "Password Change".
<b>2</b>	<p>Use the number buttons to enter your existing password, then press ENTER.</p> 
<b>3</b>	<p>Enter a new password and press ENTER.</p> <p>This registers the new password and you will return to the Options menu screen.</p> 

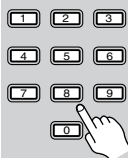
### Setting/changing the Parental Lock

<b>1</b>	Select "Level Change".
<b>2</b>	<p>Use number buttons to enter your password, then press ENTER.</p> 
<b>3</b>	<p>Select a new level and press ENTER.</p> <ul style="list-style-type: none"> <li>• Press the cursor left (◀) button repeatedly to lock more levels (more discs will require the password); press the cursor right (▶) button to unlock levels. You can't lock level 1.</li> </ul> <p>This sets the new level and you will return to the Options menu screen.</p> 

## Initial Settings menu—Continued

### Setting/changing the Country/Area code

You can find the Country/Area code list in the adjacent column.

<b>1</b>	<b>Select "Country Code".</b>
<b>2</b>	<b>Use number buttons to enter your password, then press ENTER.</b>
<b>3</b>	<b>Select a Country/Area code and press ENTER.</b>

There are two ways you can do this:

- Select by code letter: Use the cursor up/down (▲/▼) buttons to change the Country/Area code.
- Select by code number: Press the cursor right (▶) button then use the number buttons to enter the 4-digit Country/Area code.

The new Country/Area code is set and you will return to the Options menu screen. Note that the new Country/Area code doesn't take effect until the next disc is loaded (or the current disc is reloaded).

### Country/Area code list

Country/Area	Country/Area code	Country/Area code letter
Argentina	0118	ar
Australia	0121	au
Austria	0120	at
Belgium	0205	be
Brazil	0218	br
Canada	0301	ca
Chile	0312	cl
China	0314	cn
Denmark	0411	dk
Finland	0609	fi
France	0618	fr
Germany	0405	de
Hong Kong	0811	hk
India	0914	in
Indonesia	0904	id
Italy	0920	it
Japan	1016	jp
Korea, Republic of	1118	kr
Malaysia	1325	my
Mexico	1324	mx
Netherlands	1412	nl
New Zealand	1426	nz
Norway	1415	no
Pakistan	1611	pk
Philippines	1608	ph
Portugal	1620	pt
Russian Federation	1821	ru
Singapore	1907	sg
Spain	0519	es
Sweden	1905	se
Switzerland	0308	ch
Taiwan	2023	tw
Thailand	2008	th
United Kingdom	0702	gb
USA	2119	us

## Initial Settings menu—Continued

### About DivX® VOD content

In order to play DivX VOD (video on demand) content on this player, you first need to register the player with your DivX VOD content provider. You do this by generating a DivX VOD registration code, which you submit to your provider.

#### Important:

- DivX VOD content is protected by a DRM (Digital Rights Management) system. This restricts playback of content to specific, registered devices.
- If you load a disc that contains DivX VOD content not authorized for your player, the message Authorization Error is displayed and the content will not play.
- Resetting the player (as described in Resetting the player in the main Operating Instructions) will not cause you to lose your registration code.

### Playing DivX® VOD content

Some DivX VOD content may only be playable a fixed number of times. When you load a disc containing this type of DivX VOD content, the remaining number of plays is shown on-screen and you then have the option of playing the disc (thereby using up one of the remaining plays), or stopping. If you load a disc that contains expired DivX VOD content (for example, content that has zero remaining plays), the message Rental Expired is displayed.

If your DivX VOD content allows an unlimited number of plays, then you may load the disc into your player and play the content as often as you like, and no message will be displayed.

### Displaying your DivX VOD registration code

**1**



Press **SETUP** and select “Initial Settings”.

**2**

Select “Options”, then “DivX VOD”.

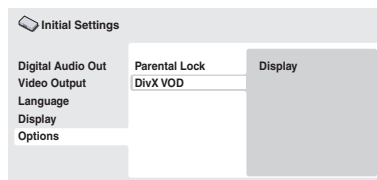

**3**

Select “Display”.

Your 8-digit registration code is displayed.

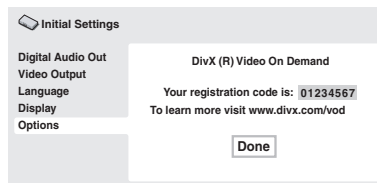

Make a note of the code as you will need it when you register with a DivX VOD provider.



## Additional information

### Screen sizes and disc formats

DVD-Video discs come in several different screen aspect ratios, ranging from TV programs, which are generally 4:3, to Cinema-Scope widescreen movies, with an aspect ratio of up to about 7:3.

Televisions, too, come in different aspect ratios; “standard” 4:3 and widescreen 16:9.

#### Widescreen TV users

If you have a widescreen TV, the TV Screen setting (page 44) of this player should be set to “16:9 (Wide)”. When you watch discs recorded in 4:3 format, you can use the TV controls to select how the picture is presented. Your TV may offer various zoom and stretch options; see the instructions that came with your TV for details.

Please note that some movie aspect ratios are wider than 16:9, so even though you have a widescreen TV, these discs will still play in a “letter box” style with black bars at the top and bottom of the screen.

#### Standard TV users

If you have a standard TV, the “TV Screen” setting (page 44) of this player should be set to “4:3 (Letter Box)” or “4:3 (Pan&Scan)”, depending on which you prefer.

Set to “4:3 (Letter Box)”, widescreen discs are shown with black bars top and bottom.



Set to “4:3 (Pan&Scan)”, widescreen discs are shown with the left and right sides cropped.

Although the picture looks larger, you don’t actually see the whole picture.



Please note that many widescreen discs override the player’s settings so that the disc is shown in letter box format regardless of the setting.

#### Note:

- Using the “16:9 (Wide)” setting with a standard 4:3 TV, or either of the “4:3” settings with a widescreen TV, will result in a distorted picture.

### Resetting the player

Use this procedure to reset all the player’s settings to the factory default.

- Switch the player into standby.**
- Using the front panel buttons, hold down the  button and press STANDBY/ON to switch the player back on.**  
All the player’s settings are now reset.

### Setting the TV system (Not North American model)

The default setting of this player is “AUTO”, and unless you notice that the picture is distorted when playing some discs, you should leave it set to “AUTO”. If you experience picture distortion with some discs, set the TV system to match your country or region’s system. Doing this, however, may restrict the kinds of disc you can watch. The table below shows what kinds of disc are compatible with each setting (“AUTO”, “PAL” and “NTSC”).

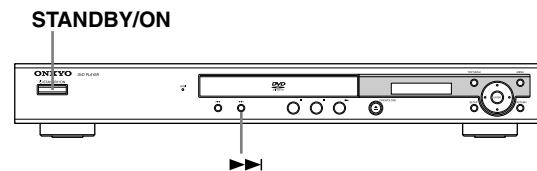

- If the player is on, press STANDBY/ON to switch it to standby.**
- Using the front panel controls, hold down  then press STANDBY/ON to switch the TV system.**  
The TV system changes as follows:  

→	AUTO	→	NTSC	→	PAL	→
---	------	---	------	---	-----	---

## Additional information—Continued

**Note:**

- You have to switch the player into standby (press STANDBY/ON) before each change.

Disc		Player setting		
Type	Format	NTSC	PAL	AUTO
DVD, Video CD, DivX video	NTSC	NTSC	PAL	NTSC
	PAL	NTSC	PAL	PAL
CD/MP3/WMA/JPEG/no disc	—	NTSC	PAL	NTSC or PAL

### Titles, chapters and tracks

DVD discs are generally divided into one or more titles. Titles may be further subdivided into chapters.

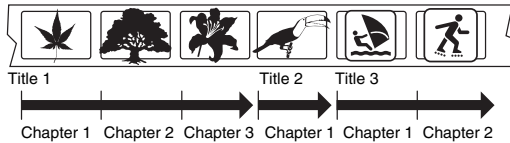

CDs and Video CDs are divided into tracks.

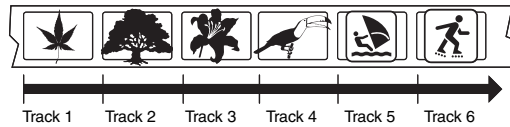

CD-ROMs contain folders and files. MP3 and WMA files are referred to as tracks. Folders may contain further folders.

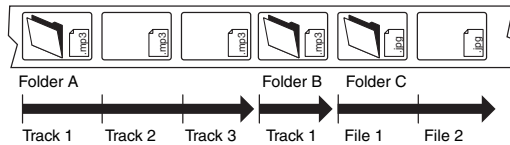

### DVD-Video regions

All DVD-Video discs carry a region mark on the case somewhere that indicates which region(s) of the world the disc is compatible with. Your DVD player also has a region mark, which you can find on the rear panel. Discs from incompatible regions will not play in this player. Discs marked “ALL” will play in any player.

The diagram below shows the various DVD regions of the world.

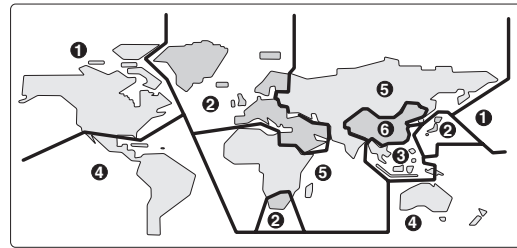

### Selecting languages using the language code list

Some of the language options (such as “DVD Language” in the Setup Navigator) allow you to set your preferred language from any of the 136 languages listed in the language code list on page 51.

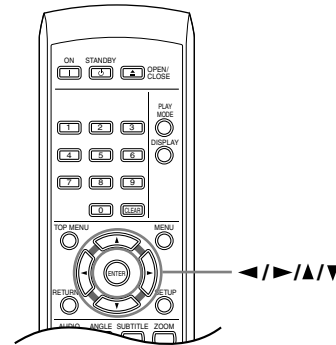

- Select “Other Language”.**
- Use the cursor left/right (◀/▶) buttons to select either a code letter or a code number.**
- Use the cursor up/down (▼/▲) buttons to select a code letter or a code number.**  
See “Language code list” on page 51 for a complete list of languages and codes.

**Additional information—Continued**

**Language code list**

Language	Language code letter	Language code	Language	Language code letter	Language code	Language	Language code letter	Language code
Japanese	ja	1001	Hungarian	hu	0821	Sangho	sg	1907
English	en	0514	Armenian	hy	0825	Serbo-Croatian	sh	1908
French	fr	0618	Interlingua	ia	0901	Sinhalese	si	1909
German	de	0405	Interlingue	ie	0905	Slovak	sk	1911
Italian	it	0920	Inupiak	ik	0911	Slovenian	sl	1912
Spanish	es	0519	Indonesian	in	0914	Samoan	sm	1913
Chinese	zh	2608	Icelandic	is	0919	Shona	sn	1914
Dutch	nl	1412	Hebrew	iw	0923	Somali	so	1915
Portuguese	pt	1620	Yiddish	ji	1009	Albanian	sq	1917
Swedish	sv	1922	Javanese	jw	1023	Serbian	sr	1918
Russian	ru	1821	Georgian	ka	1101	Siswati	ss	1919
Korean	ko	1115	Kazakh	kk	1111	Sesotho	st	1920
Greek	el	0512	Greenlandic	kl	1112	Sundanese	su	1921
Afar	aa	0101	Cambodian	km	1113	Swahili	sw	1923
Abkhazian	ab	0102	Kannada	kn	1114	Tamil	ta	2001
Afrikaans	af	0106	Kashmiri	ks	1119	Telugu	te	2005
Amharic	am	0113	Kurdish	ku	1121	Tajik	tg	2007
Arabic	ar	0118	Kirghiz	ky	1125	Thai	th	2008
Assamese	as	0119	Latin	la	1201	Tigrinya	ti	2009
Aymara	ay	0125	Lingala	ln	1214	Turkmen	tk	2011
Azerbaijani	az	0126	Laothian	lo	1215	Tagalog	tl	2012
Bashkir	ba	0201	Lithuanian	lt	1220	Setswana	tn	2014
Byelorussian	be	0205	Latvian	lv	1222	Tonga	to	2015
Bulgarian	bg	0207	Malagasy	mg	1307	Turkish	tr	2018
Bihari	bh	0208	Maori	mi	1309	Tsonga	ts	2019
Bislama	bi	0209	Macedonian	mk	1311	Tatar	tt	2020
Bengali	bn	0214	Malayalam	ml	1312	Twi	tw	2023
Tibetan	bo	0215	Mongolian	mn	1314	Ukrainian	uk	2111
Breton	br	0218	Moldavian	mo	1315	Urdu	ur	2118
Catalan	ca	0301	Marathi	mr	1318	Uzbek	uz	2126
Corsican	co	0315	Malay	ms	1319	Vietnamese	vi	2209
Czech	cs	0319	Maltese	mt	1320	Volapük	vo	2215
Welsh	cy	0325	Burmese	my	1325	Wolof	wo	2315
Danish	da	0401	Nauru	na	1401	Xhosa	xh	2408
Bhutani	dz	0426	Nepali	ne	1405	Yoruba	yo	2515
Esperanto	eo	0515	Norwegian	no	1415	Zulu	zu	2621
Estonian	et	0520	Occitan	oc	1503			
Basque	eu	0521	Oromo	om	1513			
Persian	fa	0601	Oriya	or	1518			
Finnish	fi	0609	Panjabi	pa	1601			
Fiji	fj	0610	Polish	pl	1612			
Faroese	fo	0615	Pashto,Push to	ps	1619			
Frisian	fy	0625	Quechua	qu	1721			
Irish	ga	0701	Rhaeto-Romance	rm	1813			
Scots-Gaelic	gd	0704	Kirundi	rn	1814			
Galician	gl	0712	Romanian	ro	1815			
Guarani	gn	0714	Kinyarwanda	rw	1823			
Gujarati	gu	0721	Sanskrit	sa	1901			
Hausa	ha	0801	Sindhi	sd	1904			
Hindi	hi	0809						
Croatian	hr	0818						

# Glossary

## Analog audio

An electrical signal that directly represents sound. Compare this to digital audio which can be an electrical signal, but is an indirect representation of sound. See also "Digital audio".

## Aspect ratio

The width of a TV screen relative to its height. Conventional TVs are 4:3 (in other words, the screen is almost square); widescreen models are 16:9 (the screen is almost twice as wide as it is high).

## Digital audio

An indirect representation of sound by numbers. During recording, the sound is measured at discrete intervals (44,100 times a second for CD audio) by an analog-to-digital converter, generating a stream of numbers.

On playback, a digital-to-analog converter generates an analog signal based on these numbers. See also "Sampling frequency" and "Analog audio".

## DivX<sup>\*1</sup>



DivX is a media technology created by DivX, Inc. DivX media files contain compressed video. DivX files can also include advanced media features like menus, subtitles, and alternate audiotracks.

## Dolby Digital<sup>\*2</sup>



Using a maximum of 5.1 channels of audio, this high quality surround system is used in many of the finer movie theaters around the world.

The on-screen display shows which channels are active, for example showing 3/2.1. The 3 being the two front channels and the center channel; the 2 being the surround channels, and the .1 being the LFE channel.

## DRM

DRM (digital rights management) is a type of server software developed to enable secure distribution of paid content over the web, recently incorporated by WMA (Windows Media Audio).

## DTS<sup>\*3</sup>



DTS stands for Digital Theater Systems. DTS is a surround system different from Dolby Digital that has become a popular surround sound format for movies.

## Dynamic range

The difference between the quietest and loudest sounds possible in an audio signal (without distorting or getting lost in noise).

Dolby Digital and DTS soundtracks are capable of a very wide dynamic range, delivering dramatic cinematic effects.

## EXIF (Exchangeable Image File)

A file format developed by Fuji Photo Film for digital still cameras. Digital cameras from various manufacturers use this compressed file format which carries date, time and thumbnail information, as well as the picture data.

## File extension

A tag added to the end of a filename to indicate the type of file. For example, ".mp3" indicates an MP3 file.

## HDMI<sup>\*4</sup>

HDMI (High-Definition Multimedia Interface) is a high-speed digital interface which has the capability to support standard, enhanced, or highdefinition video plus standard to multichannel surround-sound audio on a single digital connection. HDMI features include uncompressed digital video, a bandwidth of up to 5 gigabytes per second and communication between the AV source and AV devices such as DTVs.

## ISO 9660 format

International standard for the volume and file structure of CD-ROM discs.

## JPEG

A file format used for still images, such as photographs and illustrations. JPEG files are identified by the file extension ".jpg" or ".JPG". Most digital cameras use this format.

## MP3

MP3 (MPEG1 audio layer 3) is a compressed audio file format. Files are recognized by their file extension ".mp3" or ".MP3".

## MPEG audio

An audio format used on Video CDs and some DVD discs. This unit can convert MPEG audio to PCM format for wider compatibility with digital recorders and AV amplifiers. See also "PCM (Pulse Code Modulation)".

## MPEG video

The video format used for Video CDs and DVDs. Video CD uses the older MPEG-1 standard, while DVD uses the newer and much better quality MPEG-2 standard.

## PBC (PlayBack Control) (Video CD only)

A system of navigating a Video CD through on-screen menus recorded onto the disc. Especially good for discs that you would normally not watch from beginning to end all at once—karaoke discs, for example.

## PCM (Pulse Code Modulation)

The most common system of encoding digital audio, found on CDs and DAT. Excellent quality, but requires a lot of data compared to formats such as Dolby Digital and MPEG audio. For compatibility with digital audio recorders (CD, MD and DAT) and AV amplifiers with digital inputs, this unit can convert Dolby Digital, DTS and MPEG audio to PCM. See also "Digital audio".

\*1. DivX, DivX Certified, and associated logos are trademarks of DivX, Inc. and are used under license.

\*2. Manufactured under license from Dolby Laboratories. "Dolby" and the double-D symbol are trademarks of Dolby Laboratories.

\*3. "DTS" and "DTS Digital Out" are registered trademarks of Digital Theater Systems, Inc.

\*4. HDMI, the HDMI logo and High-Definition Multimedia Interface are trademarks or registered trademarks of HDMI licensing LLC.

## Glossary—Continued

---

### **Progressive scan video**

All the lines that make up a video picture are updated in one pass (compared to interlace which takes two passes to update the whole picture).

### **Regions (DVD-Video only)**

These associate discs and players with particular areas of the world. This unit will only play discs that have compatible region codes. You can find the region code of your unit by looking on the rear panel. Some discs are compatible with more than one region (or all regions).

### **Sampling frequency**

The rate at which sound is measured to be turned into digital audio data. The higher the rate, the better the sound quality, but the more digital information is generated. Standard CD audio has a sampling frequency of 44.1kHz, which means 44,100 samples (measurements) per second. See also “Digital audio”.

### **WMA**

WMA is short for Windows Media Audio and refers to an audio compression technology developed by Microsoft Corporation. WMA data can be encoded by using Windows Media Player version 8 or Windows Media Player for Windows XP.

# Troubleshooting

If you have any trouble using your DV-SP404/DV-SP404E, check the following table for possible causes and remedies. If you still can't resolve the issue yourself, please contact your Onkyo dealer.

	Symptoms	Causes	Remedies
DVD Player	<b>Can't turn on the DV-SP404/DV-SP404E?</b>	The power cord is not connected.	Connect the power cord to a suitable wall outlet (page 23).
		External interference is affecting the DV-SP404/DV-SP404E's digital circuitry.	Turn off the DV-SP404/DV-SP404E, wait five seconds, then try turning it on again. If that fails, disconnect the power cord from the wall outlet, wait five seconds, reconnect it, then try turning it on again.
	<b>The disc tray won't close properly?</b>	The disc is not centered in the disc tray.	Place the disc in the center of the disc tray (page 26).
		The disc is dirty.	Remove the disc and clean it (page 10).
	<b>Can't start playback?</b>	No disc is loaded.	Load a disc (page 26).
		The disc cannot be played because it's incompatible.	Use only compatible discs (page 8).
		The disc is upside down.	Load the disc the correct way up (page 26).
		The disc is not centered in the disc tray.	Place the disc in the center of the disc tray (page 26).
		The disc is dirty.	Remove the disc and clean it (page 10).
		The disc uses parental lock and the Parental Lock function is on.	Turn off the Parental Lock function (page 46).
		The DVD-Video disc is intended for use in another region.	If the region number on the disc does not match the region number on the DV-SP404/DV-SP404E, the disc can't be played (page 50).
	<b>The picture distorts occasionally?</b>	The disc is dirty.	Remove the disc and clean it (page 10).
		You're using the Fast Forward or Fast Reverse function.	A little picture distortion may occur when using these functions. This is normal.
	<b>Picture instability or noise?</b>	The DV-SP404/DV-SP404E is connected to your TV via a VCR or other video equipment and a copy-protection system is affecting the picture.	Connect the DV-SP404/DV-SP404E directly to your TV (page 18).
	<b>No picture?</b>	The wrong input source is selected on your TV.	On your TV, select the input to which the DV-SP404/DV-SP404E is connected.
		The video cable is not connected properly.	Check the video cable and correct as necessary (page 18).
<b>Settings are not saved?</b>	If there's a power failure, or the power cord is disconnected inadvertently, any settings are lost.	Before you disconnect the power cord, set the DV-SP404/DV-SP404E to Standby by pressing the [STANDBY/ON] button, and wait until "OFF" has disappeared from the display.	
<b>Brightness is unstable or the picture is noisy?</b>	The DV-SP404/DV-SP404E is connected to your TV via a VCR or other video equipment and a copy-protection system is affecting the picture.	Connect the DV-SP404/DV-SP404E directly to your TV (page 18).	
	Your TV doesn't support progressive scanning.	Reset the DV-SP404/DV-SP404E to its initial settings (page 42).	
<b>Chapters or tracks don't play in the correct order?</b>	You are using repeat playback, program playback, or random playback.	Select normal playback (pages 34–36).	
<b>Buttons on the DV-SP404/DV-SP404E and remote controller don't work?</b>	Power supply voltage fluctuations and other anomalies, such as static electricity, can interfere with normal operation.	Turn off the DV-SP404/DV-SP404E, wait five seconds, then turn it on again. If that doesn't resolve the issue, disconnect the power cord from the wall outlet, wait five seconds, reconnect it, then try again.	

## Troubleshooting—Continued

<b>DVD Player</b>	<b>No sound?</b>	The 96 kHz PCM Out setting is set to "96 kHz."	Change the 96 kHz PCM Out setting to "96 kHz > 48 kHz," or use analog connections (page 43).
		The Digital Out setting is set to "Off."	Change the Digital Out setting to "On" (page 43).
		The wrong input source is selected on your TV, hi-fi amp, or AV receiver.	On your TV, hi-fi amp, or AV receiver, select the input to which the DV-SP404/DV-SP404E is connected.
		The audio cable is not connected properly.	Check the audio cable and correct as necessary.
		The TV, hi-fi amp, or AV receiver connected to the DV-SP404/DV-SP404E's audio outputs is either not on or its volume is turned down.	Turn on the TV, hi-fi amp, or AV receiver and set its volume as appropriate.
		A DV-SP404/DV-SP404E Digital Audio Out setting is set incorrectly.	Check the Digital Audio Out settings and correct as necessary (page 43).
		Playback is paused.	Resume playback (page 27).
		The DVD-Video disc or CD uses the DTS audio format and you are using the analog outputs.	DTS audio is only output by the digital outputs. To play DTS material you need to connect one of the DV-SP404/DV-SP404E's digital outputs to a digital input on a hi-fi amp or AV receiver that has a DTS decoder built-in (page 22).
	<b>The picture appears stretched or the wrong shape?</b>	The TV Screen setting is wrong.	Set the TV Screen setting to match the aspect ratio of your TV (page 44).
	<b>Audio CD playback skips or jumps or is noisy?</b>	The loaded audio CD uses copy control.	Copy-controlled CDs are special discs that don't conform to the audio CD standard and, therefore, may not work properly with the DV-SP404/DV-SP404E.
	<b>An audio CD is loaded but the DV-SP404/DV-SP404E displays "NO DISC"?</b>		
	<b>The first track doesn't play?</b>		
	<b>Locating a specific point takes longer than usual?</b>		
<b>Playback starts in the middle of a track?</b>			
<b>Some sections of a track are skipped?</b>			
<b>Playback stops in the middle of a track?</b>			
<b>The DV-SP404/DV-SP404E displays the wrong messages?</b>			
<b>Some MP3 files don't play?</b>	MP3 files without a ".mp3" or ".MP3" filename extension are not recognized.	Use the correct filename extension (page 8).	
	The MP3 disc is a multisession disc.	The DV-SP404/DV-SP404E doesn't fully support multisession discs. Only files in the first session can be played (page 8).	

## Troubleshooting—Continued

<b>DVD Player</b>	<b>Can't play MP3/WMA/JPEG discs?</b>	The disc is not ISO 9660 Level 1 or 2 format.	Correct format should be used when recording is ISO 9660 and closed session (page 8).
		The disc has not been finalized.	Finalize the disc (page 8).
	<b>Can't select MP3 files?</b>	MP3 files without a ".mp3" or ".MP3" filename extension are not recognized.	Use the correct filename extension (page 8).
	<b>Can't play WMA files?</b>	WMA files without a ".wma" or ".WMA" filename extension are not recognized.	Use the correct filename extension (page 8).
		The WMA file's copyright option is on.	Don't use the copyright option (page 9).
<b>Can't view JPEG files?</b>	JPEG files without a ".jpg" or ".JPG" filename extension are not recognized.	Use the correct filename extension (page 8).	
	Only Baseline JPEG files are supported. Progressive JPEG files are not.	Use Baseline JPEG files (page 9).	
<b>Remote Controller</b>	<b>Buttons on the DV-SP404/DV-SP404E work OK but those on the remote controller don't?</b>	There are no batteries in the remote controller.	Install new batteries (page 11).
		The batteries are flat.	Replace with new batteries (page 11).
		The batteries are installed incorrectly.	Check the batteries and correct as necessary (page 11).
		You're not pointing the remote controller at the DV-SP404/DV-SP404E's remote sensor.	Point the remote controller at the DV-SP404/DV-SP404E's remote sensor (page 11).
		You're too far away from the DV-SP404/DV-SP404E.	Use the remote controller closer to the DV-SP404/DV-SP404E (page 11). The remote controller has a range of approximately 5 meters.
		A strong light source is interfering with the DV-SP404/DV-SP404E's remote sensor.	Make sure that the DV-SP404/DV-SP404E is not subjected to direct sunshine or inverter-type fluorescent lights. Relocate if necessary.
		If the DV-SP404/DV-SP404E is installed in a cabinet with colored glass doors, the remote controller may not work reliably when the doors are closed.	Open the doors, or use a cabinet without colored glass.



## Troubleshooting—Continued

### HDMI troubleshooting

Incorrect operation is often mistaken for trouble or malfunction. If you think that there is something wrong with this component, check the points below. Sometimes the trouble may lie in another component. Inspect the other components and electrical appliances being used. If the trouble cannot be rectified after checking the items below, ask our customer center or your dealer to carry out repair work.

Problem	Remedy
<b>No HDMI audio output.</b>	<ul style="list-style-type: none"> <li>• This unit has been designed to be compliant with HDMI (High Definition Multimedia Interface). Depending on the component you have connected, unreliable signal transfers may result.</li> <li>• If the front panel HDMI indicator is lit:                             <ul style="list-style-type: none"> <li>→ You won't hear any sound from the HDMI output if the source component is only DVI/HDCP-compatible.</li> </ul> </li> <li>• If the front panel HDMI indicator is unlit then:                             <ul style="list-style-type: none"> <li>→ Make sure that you've selected this player as the HDMI input in the settings for the component you're using. You may need to refer to the instruction manual of the component to do this.</li> <li>→ Check that the HDMI cable is connected properly and that the cable isn't damaged.</li> <li>→ Check that components connected using the HDMI interface are switched on and HDMI compatible.</li> </ul> </li> </ul>
<b>No HDMI video output</b>	<ul style="list-style-type: none"> <li>• Make sure that you've selected this player as the HDMI input in the settings for the component you're using. You may need to refer to the instruction manual of the component to do this.</li> <li>• Check that the HDMI cable is connected properly and that the cable isn't damaged.</li> <li>• Check that components connected using the HDMI interface are switched on and HDMI compatible.</li> <li>• This unit has been designed to be compliant with HDMI (High Definition Multimedia Interface). Depending on the component you have connected, using a DVI connection may result in unreliable signal transfers.</li> <li>• Make sure the resolution on this player matches that of the component you have connected using HDMI. See HDMI Resolution on page 44 to change the HDMI resolution. See Resetting the output resolution to the default setting with HDMI connection on page 21 if you want to reset the output resolution.</li> </ul>
<b>No multichannel HDMI audio.</b>	<ul style="list-style-type: none"> <li>• Make sure the HDMI OUT setting is set to Auto (see HDMI Out on page 43 to do this).</li> </ul>
<b>A connected DVI component (with HDCP) doesn't work with this player.</b>	<ul style="list-style-type: none"> <li>• This unit has been designed to be compliant with HDMI (High Definition Multimedia Interface). Depending on the component you have connected, using a DVI connection may result in unreliable signal transfers.</li> </ul>

**Note:**

- Static electricity or other external influences may cause malfunctioning of this unit. In this case, unplug the power cord and then plug back in. This will usually reset the unit for proper operation. If this does not correct the problem, please consult your nearest our customer center.

The DV-SP404/DV-SP404E contains a microcomputer for signal processing and control functions. In very rare situations, severe interference, noise from an external source, or static electricity may cause it to lockup. In the unlikely even that this should happen, unplug the power cord from the wall outlet, wait at least five seconds, and then plug it back in again.

# Specifications

<b>Signal System</b>		NTSC/PAL/AUTO
<b>Composite Video Output/Impedance</b>		1.0 V (p-p)/75 $\Omega$ negative sync, RCA/phono
<b>S-Video Output/Impedance (not European model)</b>		Y: 1.0 V (p-p)/75 $\Omega$ negative sync, 4-pin mini DIN C: 0.286 V (p-p)/75 $\Omega$
<b>Component Video Output/Impedance</b>		Y: 1.0 V (p-p)/75 $\Omega$ PB/PR: 0.7 V (p-p)/75 $\Omega$ RCA/phono
<b>HDMI Out</b>		19 pin connector
<b>AV Connector (European model only)</b>		1.0 V (p-p)/75 $\Omega$ , 21 pin connector
<b>Frequency response</b>	DVD Linear Sound	4 Hz–44 kHz (96 kHz) 4 Hz–22 kHz (48 kHz)
	Audio CD	4 Hz–20 kHz (44.1 kHz)
<b>S/N Ratio</b>		115 dB
<b>Audio Dynamic Range</b>		88 dB
<b>THD (Total Harmonic Distortion)</b>		0.0065 % (1 kHz)
<b>Wow and Flutter</b>		Below threshold of measurability
<b>Audio Output (Digital Optical)</b>		–22.5 dBm (Oceanian model only)
<b>Audio Output/Impedance (Digital Coaxial)</b>		0.5 V (p-p)/75 $\Omega$
<b>Audio Output/Impedance (Analog)</b>		2.0 V (rms)/440 $\Omega$

## ■ General

<b>Power Supply</b>	AC 120 V, 60 Hz (North American model) AC 110–240 V, 50 Hz/60 Hz (Oceanian model) AC 220–240 V, 50 Hz/60 Hz (European model)
<b>Power Consumption</b>	7 W
<b>Stand-by Power Consumption</b>	0.5 W (North American model) 0.7 W (European and Oceanian models)
<b>Dimensions (W x H x D)</b>	435 W x 61 H x 215.5 D mm
<b>Weight</b>	1.9 kg
<b>Operation Condition Temperature</b>	+5° C to +40° C
<b>Disc Compatibility</b>	DVD-video, DVD-R/RW, DVD+R/RW, Audio CD, CD-R/RW, Video CD, MP3, WMA, JPEG, DivX Video Disc that have not been property finalized may only be partially playable or not playable at all

Specifications and features subject to change without notice.

# Memo

---

---

## **ONKYO CORPORATION**

Sales & Product Planning Div. : 2-1, Nisshin-cho, Neyagawa-shi, OSAKA 572-8540, JAPAN  
Tel: 072-831-8023 Fax: 072-831-8124

### **ONKYO U.S.A. CORPORATION**

18 Park Way, Upper Saddle River, N.J. 07458, U.S.A.  
Tel: 201-785-2600 Fax: 201-785-2650 <http://www.us.onkyo.com/>

### **ONKYO EUROPE ELECTRONICS GmbH**

Liegnitzerstrasse 6, 82194 Groebenzell, GERMANY  
Tel: +49-8142-4401-0 Fax: +49-8142-4401-555 <http://www.eu.onkyo.com/>

### **ONKYO EUROPE UK Office**

Suite 1, Gregories Court, Gregories Road, Beaconsfield, Buckinghamshire, HP9 1HQ  
UNITED KINGDOM Tel: +44-(0)1494-681515 Fax: +44(0)-1494-680452

### **ONKYO CHINA LIMITED**

Unit 1&12, 9/F, Ever Gain Plaza Tower 1, 88, Container Port Road, Kwai Chung,  
N.T., HONG KONG Tel: 852-2429-3118 Fax: 852-2428-9039  
<http://www.ch.onkyo.com/>



I0606-2

SN 29344272A

(C) Copyright 2006 ONKYO CORPORATION Japan. All rights reserved.

## Free Manuals Download Website

<http://myh66.com>

<http://usermanuals.us>

<http://www.somanuals.com>

<http://www.4manuals.cc>

<http://www.manual-lib.com>

<http://www.404manual.com>

<http://www.luxmanual.com>

<http://aubethermostatmanual.com>

Golf course search by state

<http://golfingnear.com>

Email search by domain

<http://emailbydomain.com>

Auto manuals search

<http://auto.somanuals.com>

TV manuals search

<http://tv.somanuals.com>