

ONKYO®

Phantom Cinema

PHC-5

Virtual Surround Unit PHC-5

Instruction Manual (for European model)

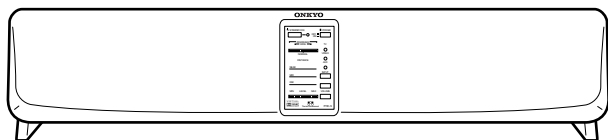

Thank you for purchasing the Onkyo Phantom Cinema.

Please read this manual thoroughly before making connections and turning on the power.

Following the instructions in this manual will enable you to obtain optimum performance and listening enjoyment from your new Phantom Cinema.

Please retain this manual for future reference.

Contents

Important Safeguards.....	2
Precautions.....	3
Features.....	3
Package Contents.....	4
Checking the package contents.....	4
Installing batteries.....	4
Installation.....	5
Installation Precautions.....	6
Connections.....	7
Connecting to the TV (IPM system).....	7
Connecting the subwoofer, SKW-320, SKW-310, etc.	8
Connecting to VIDEO/AUX INPUT jacks.....	8
Connecting the power cord.....	9
Turning on the power to the PHC-5 system	9
Before Operating the PHC-5 System.....	10
Using the remote controller.....	10
Adjusting the angle of the unit.....	10
Operating the PHC-5 System.....	11
Compatible recordings and media.....	11
Using the Virtual Surround system for TV sound.....	11
Other functions.....	14
Programmable Remote Controller..	15
Notes on programming the remote con- troller:.....	15
Buttons used for programming.....	15
Programming the other remote controller's function.....	16
Checking the programmed functions...	17
Erasing all programmed functions.....	17
Parts and Names.....	18
Virtual Surround Unit PHC-5 (front panel).....	18
Virtual Surround Unit PHC-5 (rear panel).....	18
Remote controller RC-382M.....	19
Troubleshooting.....	20
Specifications.....	20

WARNING:

TO REDUCE THE RISK OF FIRE OR ELECTRIC SHOCK, DO NOT EXPOSE THIS APPLIANCE TO RAIN OR MOISTURE.

CAUTION:

TO REDUCE THE RISK OF ELECTRIC SHOCK, DO NOT REMOVE COVER (OR BACK). NO USER-SERVICEABLE PARTS INSIDE. REFER SERVICING TO QUALIFIED SERVICE PERSONNEL.



WARNING
RISK OF ELECTRIC SHOCK
DO NOT OPEN

AVIS
RISQUE DE CHOC ELECTRIQUE
NE PAS OUVRIR



The lightning flash with arrowhead symbol, within an equilateral triangle, is intended to alert the user to the presence of uninsulated "dangerous voltage" within the product's enclosure that may be of sufficient magnitude to constitute a risk of electric shock to persons.



The exclamation point within an equilateral triangle is intended to alert the user to the presence of important operating and maintenance (servicing) instructions in the literature accompanying the appliance.

Important Safeguards

- 1. Read Instructions** – All the safety and operating instructions should be read before the appliance is operated.
- 2. Retain Instructions** – The safety and operating instructions should be retained for future reference.
- 3. Heed Warnings** – All warnings on the appliance and in the operating instructions should be adhered to.
- 4. Follow Instructions** – All operating and use instructions should be followed.
- 5. Water and Moisture** – The appliance should not be used near water – for example, near a bathtub, washbowl, kitchen sink, laundry tub, in a wet basement, or near a swimming pool, and the like.
- 6. Carts and Stands** – The appliance should be used only with a cart or stand that is recommended by the manufacturer.
PORTABLE CART WARNING

S3125A
- 6A.** An appliance and cart combination should be moved with care. Quick stops, excessive force, and uneven surfaces may cause the appliance and cart combination to overturn.
- 7. Wall or Ceiling Mounting** – The appliance should be mounted to a wall or ceiling only as recommended by the manufacturer.
- 8. Ventilation** – The appliance should be situated so that its location or position does not interfere with its proper ventilation. For example, the appliance should not be situated on a bed, sofa, rug, or similar surface that may block the ventilation openings; or if placed in a built-in installation, such as a bookcase or cabinet that may impede the flow of air through the ventilation openings, there should be free space of at least 20 cm (8 in.) and an opening behind the appliance.
- 9. Heat** – The appliance should be situated away from heat sources such as radiators, heat registers, stoves, or other appliances (including amplifiers) that produce heat.
- 10. Power Sources** – The appliance should be connected to a power supply only of the type described in the operating instructions or as marked on the appliance.
- 11. Polarization** – If the appliance is provided with a polarized plug having one blade wider than the other, please read the following information:
The polarization of the plug is a safety feature. The polarized plug will only fit the outlet one way. If the plug does not fit fully into the outlet, try reversing it. If there is still trouble, the user should seek the services of a qualified electrician. Under no circumstances should the user attempt to defeat the polarization of the plug.
- 12. Power-Cord Protection** – Power-supply cords should be routed so that they are not likely to be walked on or pinched by items placed upon or against them, especially near plugs, convenience receptacles, and the point where they exit from the appliance.
- 13. Cleaning** – The appliance should be cleaned only as recommended by the manufacturer.
- 14. Nonuse Periods** – The power cord of the appliance should be unplugged from the outlet when left unused for a long period of time.
- 15. Object and Liquid Entry** – Care should be taken so that objects do not fall and liquids are not spilled into the enclosure through openings.
- 16. Damage Requiring Service** – The appliance should be serviced by qualified service personnel when:
A. The power-supply cord or the plug has been damaged; or
B. Objects have fallen, or liquid has been spilled into the appliance; or
C. The appliance has been exposed to rain; or
D. The appliance does not appear to operate normally or exhibits a marked change in performance; or
E. The appliance has been dropped, or the enclosure damaged.
- 17. Servicing** – The user should not attempt to service the appliance beyond that described in the operating instructions. All other servicing should be referred to qualified service personnel.

Memory Preservation

This unit does not require memory preservation batteries. A built-in memory power back-up system preserves the contents of the memory during power failures and even when the unit is unplugged. The unit must be plugged in order to charge the back-up system.

The memory preservation period after the unit has been unplugged varies depending on climate and placement of the unit. On the average, memory contents are protected over a period of a few weeks after the last time the unit has been unplugged. This period is shorter when the unit is exposed to a highly humid climate.

Precautions

1. Warranty Claim

You can find the serial number on the rear panel of this unit. In case of warranty claim, please report this number.

2. AC Fuse

The fuse is located inside the chassis and is not user-serviceable. If power does not come on, contact your Onkyo authorized service station.

3. Care

From time to time you should wipe the front and rear panels and the cabinet with a soft cloth. For heavier dirt, dampen a soft cloth in a weak solution of mild detergent and water, wring it out dry, and wipe off the dirt. Following this, dry immediately with a clean cloth. Do not use rough material, thinners, alcohol or other chemical solvents or cloths since these could damage the finish or remove the panel lettering.

4. Power

WARNING

BEFORE PLUGGING IN THE UNIT FOR THE FIRST TIME, READ THE FOLLOWING SECTION CAREFULLY.

- The voltage of the available power supply differs according to country or region. Be sure that the power supply voltage in the area where this unit will be used meets the required voltage (e.g., AC 230 V, 50 Hz) written on the rear panel.

For British model

Replacement and mounting of an AC plug on the power supply cord of this unit should be performed only by qualified service personnel.

IMPORTANT

The wires in the mains lead are coloured in accordance with the following code:

- Blue : Neutral
- Brown : Live

As the colours of the wires in the mains lead of this apparatus may not correspond with the coloured markings identifying the terminals in your plug, proceed as follows:

The wire which is coloured blue must be connected to the terminal which is marked with the letter N or coloured black.

The wire which is coloured brown must be connected to the terminal which is marked with the letter L or coloured red.

IMPORTANT

A 5 amp fuse is fitted in this plug. Should the fuse need to be replaced, please ensure that the replacement fuse has a rating of 5 amps and that it is approved by ASTA or BSI to BS1362. Check for the ASTA mark or the BSI mark on the body of the fuse.

IF THE FITTED MOULDED PLUG IS UNSUITABLE FOR THE SOCKET OUTLET IN YOUR HOME THEN THE FUSE SHOULD BE REMOVED AND THE PLUG CUT OFF AND DISPOSED OF SAFELY. THERE IS A DANGER OF SEVERE ELECTRICAL SHOCK IF THE CUT OFF PLUG IS INSERTED INTO ANY 13 AMP SOCKET.

If in any doubt, please consult a qualified electrician.

Features

■ Onkyo's Theater-Dimensional Sound

Theater-Dimensional Virtual Surround system developed by Onkyo creates the optimum home theater environment by adjusting the listening distance and the width of the sound output from the front speakers.

■ Onkyo's Intelligent Power Management System (IPM)

Onkyo's intelligent power management system (IPM) turns on/off the complete system, automatically (audio triggered), simply by turning on/off the television.

■ OMF cone

Onkyo Micro Fiber (OMF) Speaker Cones, a major advancement in speaker design developed exclusively by Onkyo, use a light-weight silk fiber to greatly improve the damping coefficient — the result is clearly separated fundamental second and third harmonics, superior ambience and a much more accurate, natural sound.

■ Easy-to-setup and Easy-to-use home theater system

Connecting this unit to your TV enables you to enjoy home theater environment. Program the remote controller functions of your TV or VCR into the PHC-5's remote controller (included in the package) for much easier operation.

Declaration of Conformity

We, ONKYO EUROPE
ELECTRONICS GmbH
INDUSTRIESTRASSE 20
82110 GERMERING,
GERMANY



declare in own responsibility, that the ONKYO product described in this instruction manual is in compliance with the corresponding technical standards such as EN55013, EN55020, EN61000-3-2, -3-3 and EN60065

GERMERING, GERMANY

K. OTSU

ONKYO EUROPE ELECTRONICS GmbH

Package Contents

Checking the package contents

Before using this product, make sure that the package includes the following items:

● Remote controller (RC-382M) × 1

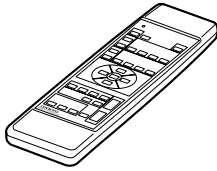

● Batteries (AA) × 2

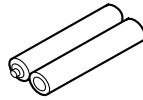

● Stereo audio connection cable × 1

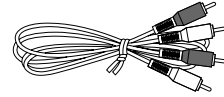

● Monaural audio connection cable × 1



● Anti-slipage pad (black) × 1



● Dual-side fixing tape (white) × 1

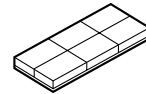

● Instruction manual (this book) × 1

● Quick guide × 1

Installing batteries

Insert two batteries (included in the package) into the remote controller as shown below.

1

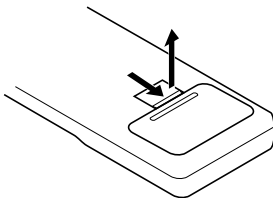

Pull up the battery compartment cover in the direction of the arrow to remove it.

2

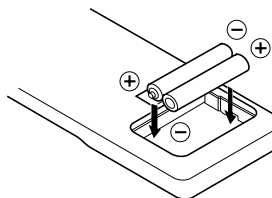

Insert two AA-size batteries into the battery compartment. Carefully follow the polarity diagram (positive (+) and negative (-) symbols) inside the battery compartment.

3

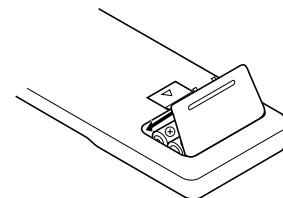

Replace the battery compartment cover.

NOTE

- Do not mix battery types. Do not use a new battery and an old battery at the same time.
- If you do not plan to use the remote controller for a long period of time, remove the batteries from the compartment to prevent battery liquid from leaking.
- Leaving dead batteries inside the compartment for an extended period may cause corrosion, which may damage the remote controller. If the unit does not respond well to remote control operation, replace the old batteries with new ones immediately.
- The life of the included manganese batteries is about six months, although it depends on how often you use the remote controller. Onkyo recommends that you use alkaline AA (LR6 or AM-3)-size batteries for replacement.

Installation

We can usually identify the source of a sound based on its loudness and the time difference (delay) between the sound reaching our left ear and right ear. The Virtual Surround system of this unit uses this characteristic of human hearing. This system, along with the DSP (Digital Signal Processor) technology, creates an effect that makes you think the sound is coming from all around you, even though the sound is output from only two front speakers. The Virtual Surround system limits the sweet spot (effective listening position) due to its nature. That is, the Virtual Surround system of this unit sets an optimum listening position at any point on the center axis when you face the unit. Any position not on the axis will have less effect. Also, if the room has many objects that reflect sound or that cause uneven reflection, the optimum effect may not be obtained. The effect of the subwoofer varies significantly depending on its location. Generally, placing the subwoofer in the corner of the room would be the most effective.

Installation example

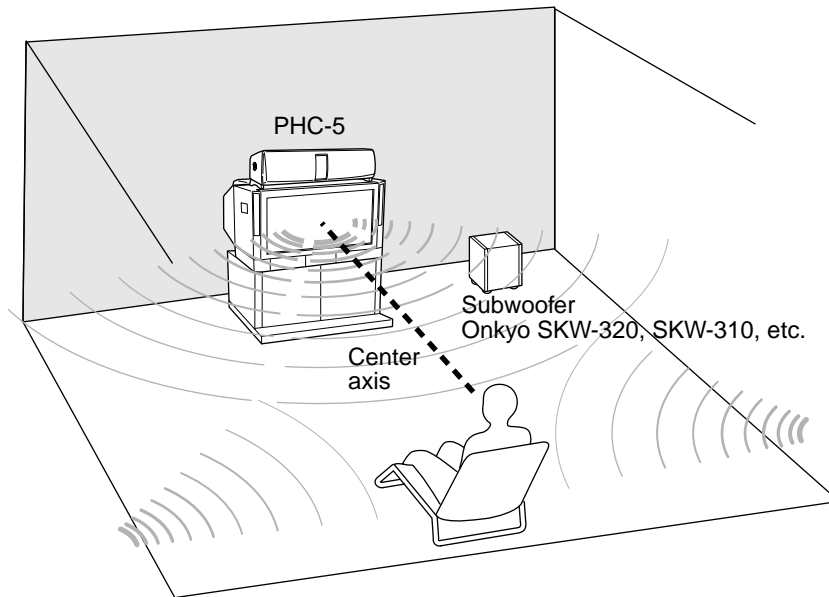

NOTE

- To prevent the cabinet from deforming or discoloration, avoid locations which are exposed to direct sunlight or much humidity, or close to an air conditioning unit or heater.

Placing the unit on the TV

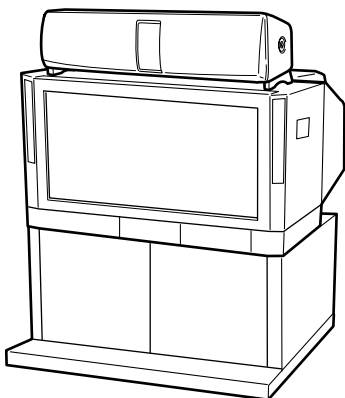

Placing the unit under the TV

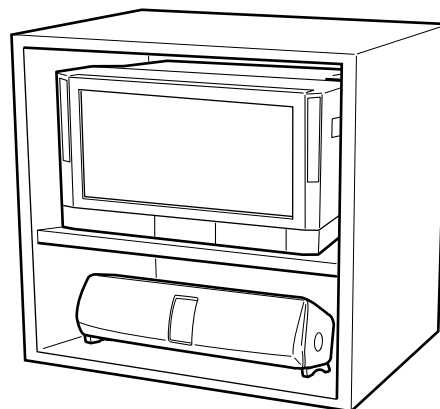

Installation (continued)

Installation Precautions

Install the unit on a level, stable surface. The unit may fall if you install it on a tilted or unstable surface. Follow the requirements below to place the unit on top of a TV:

- **The TV surface on the top side is larger than the bottom surface of the unit.**
- **The TV surface is level and not tilted.**
- **The TV is not on an unstable surface.**

To prevent the PHC-5 from falling, be sure to attach the anti-slipage pads (included in the package) on the bottom of the unit, and use a strong rope to fix the unit against the wall for safety, as shown in the figure.

If you cannot fix the unit using a rope, attach the dual-sided fixing tape (included in the package) to the bottom of the PHC-5 to fix the unit to the TV.

Note 1: The dual-sided fixing tape (white) uses strong adhesive. It will be very difficult to remove the tape once it is attached to the surface.

Note 2: Make sure that the surface on which you wish to attach the anti-slipage pad or tape is not dirty or wet. Otherwise, the pad or tape will not be fixed to the surface.

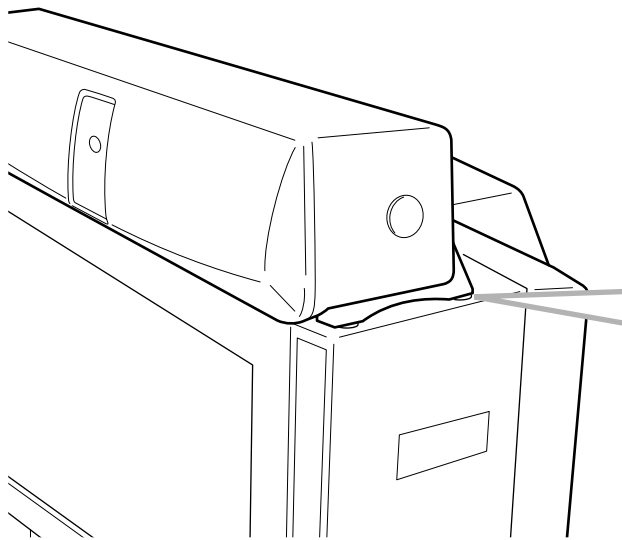

●Attaching anti-slipage pads or dual-sided fixing tape

Anti-slipage pads (black)



Dual-sided fixing tape (white)

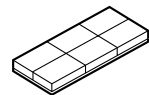

Anti-slipage pads

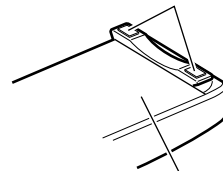

Bottom of the unit

Attach the included anti-slipage pads in the left and right corners on the bottom of the unit as shown in the figure. If the unit can not be secured with the pads, attach the dual-sided fixing tape on top of the pads.

Do not place the unit in the following locations:

Where the width of the TV is narrower than the unit.

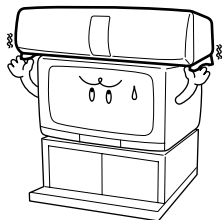

Where the top surface of the TV is tilted.

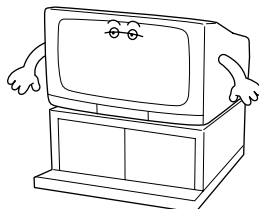

Where the vent holes on the bottom of the unit are blocked.

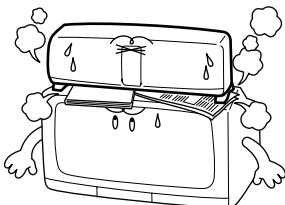

Secure the unit against the wall using a strong rope to prevent the unit from falling. (Be sure to secure the unit against the wall at two places.)

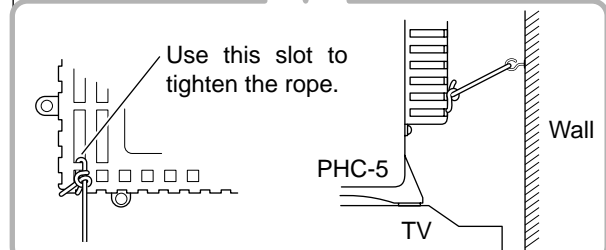
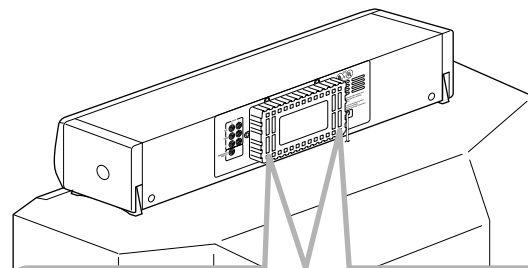



Connections

Do not plug the power cord into the AC outlet until all connections are completed.

Connecting to the TV (IPM system)

- Use the cable included in the package for connection. Connect the stereo audio connection cable as follows:

To TV's audio output L ch. jack...white  white...PHC-5's TV input L ch. jack
To TV's audio output R ch. jack...red  red...PHC-5's TV input R ch. jack

- Plug the cables securely. Incomplete connection may cause noise or malfunction.
- Refer to the manual for your TV or VCR for more information on AV output connections.

CAUTION

- Be sure to connect fixed output to the "Fixed" audio output jacks. For variable output, refer to the manual for your TV to turn the internal speakers off.
Lower the volume level on the PHC-5 before you change an input source using the INPUT SELECTOR, since the input level of a device connected to the VIDEO or AUX input jacks may be different from the input level of the TV and selecting a different input source may produce a loud sound.
- Some TVs may output audio signals even if the power is turned off. If such a TV is connected to a VCR that is programmed for recording, the IPM system may be enabled. To make sure that the IPM system is disabled, turn off the POWER switch on the PHC-5 or connect the TV output to the VIDEO or AUX input jacks. Refer to the "Connecting to VIDEO/AUX INPUT jacks" section on the next page.

What is IPM (Intelligent Power Management) system?

If the TV audio output is connected to the unit's TV in jacks, turning on (off) the power to the TV will automatically turn on (off) the power to the unit. This is called the "IPM system."

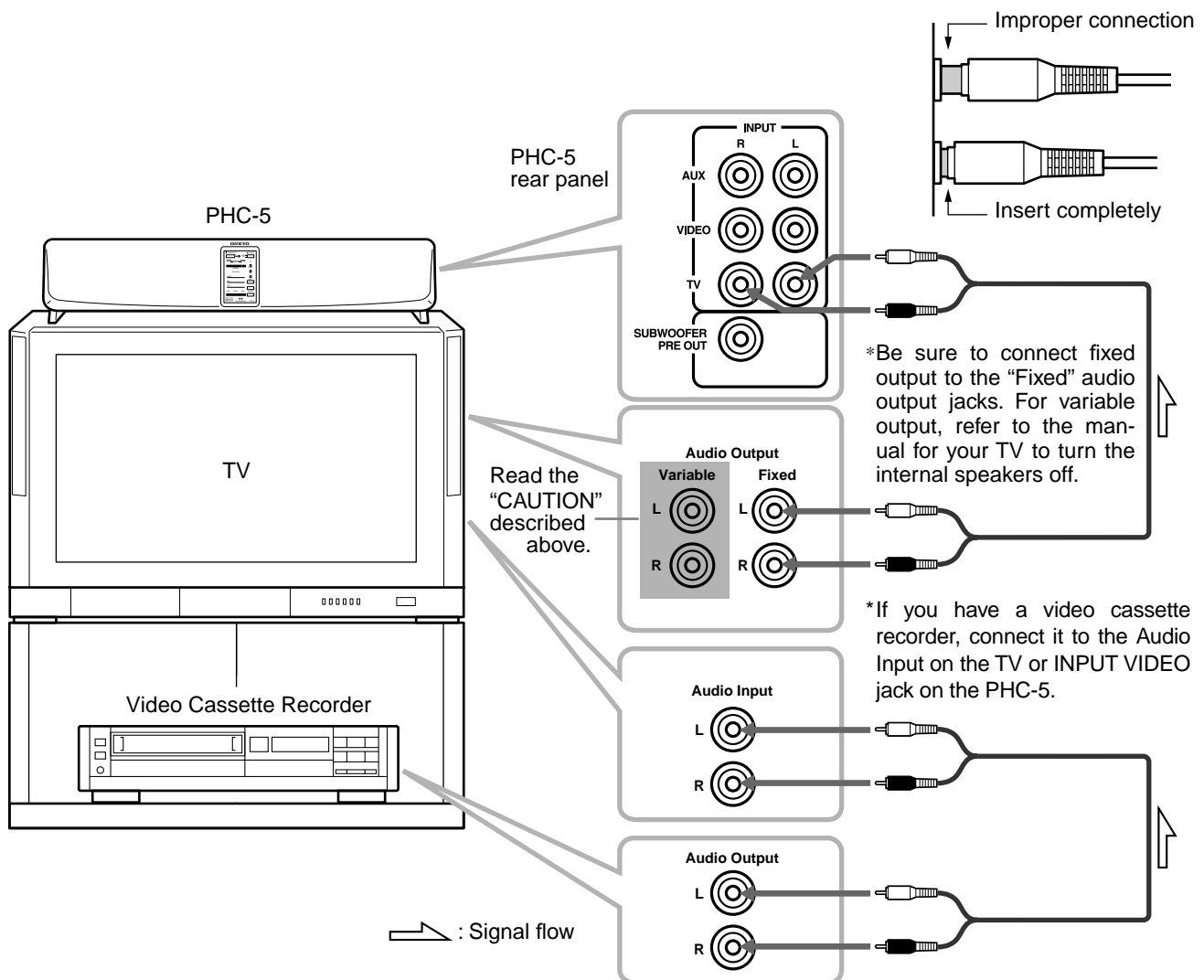

NOTE

- When you listen to the TV sound through the unit, turn down the TV volume to minimum. Sound coming from the TV itself may reduce the surround effect.

Connections (continued)

Connecting the subwoofer, SKW-320, SKW-310, etc.

Connect the subwoofer Optional Onkyo subwoofer SKW-320, SKW-310, etc. to the SUBWOOFER PREOUT jack on the PHC-5.

We recommend you connect a subwoofer to take the best advantage of the virtual surround effects.

Subwoofer with built-in amplifier (active)
(SKW-320, SKW-310, etc.)

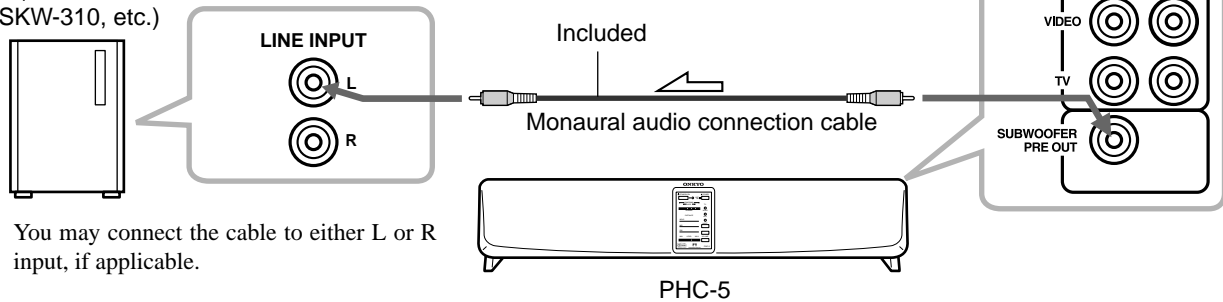

- You may connect the cable to either L or R input, if applicable.

TIP

- You can connect any subwoofer with a crossover frequency between 100Hz and 200Hz. Place the subwoofer in the optimum position.
- The location of the subwoofer significantly changes the effects. In most cases, place it in the corner of the room to get the best results.
- Refer to the instruction manual that came with the subwoofer for more information.

Connecting to VIDEO/AUX INPUT jacks

Use the VIDEO or AUX input jacks for connection in the following cases:

- To connect another audio or video device.
Lower the volume level on the PHC-5 before you change an input source using the INPUT SELECTOR, since the input level of a device such as CD player connected to the VIDEO or AUX input jacks may be different from the input level of the TV and selecting a different input source may produce a loud sound.
- To connect your VCR directly to the PHC-5, since your TV does not have audio output jacks.
- To connect your VCR directly to the PHC-5, since your TV has "variable" audio output jacks. (Refer to the "CAUTION" on page 7.)
- To connect your VCR directly to the PHC-5, since your TV outputs audio signals during programmed recording on the VCR even if the power to the TV is turned off. (Refer to the "CAUTION" on page 7.)

- Use the cable included in the device for connection. Connect the stereo audio connection cable as follows:

To the audio output L ch. jack of the device...white
To the audio output R ch. jack of the device...red

white...PHC-5's AUX or VIDEO input L ch. jack
red...PHC-5's AUX or VIDEO input R ch. jack

- Plug the cables securely. Incomplete connection may cause noise or malfunction.
- Refer to the manual for your AV device for more information on AV output connections.

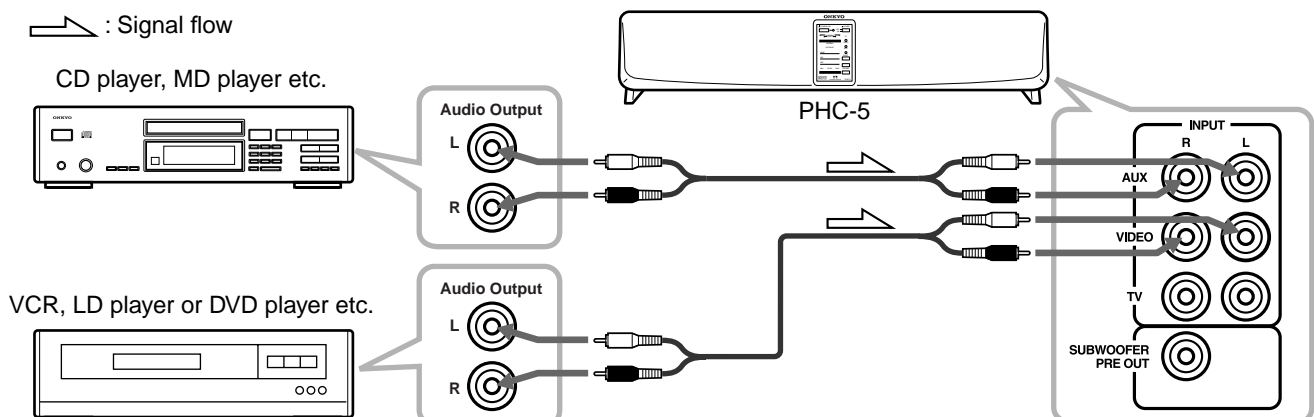

Connecting the power cord

Follow the instructions below to connect the power cord:

- Make sure that all connections other than the power cord for the PHC-5 system have already been made.
- Turning on the power to the PHC-5 system may cause a very brief current surge that might affect other devices, such as a computer, if they are on the same circuit. Connect those devices to another circuit of the AC outlet.

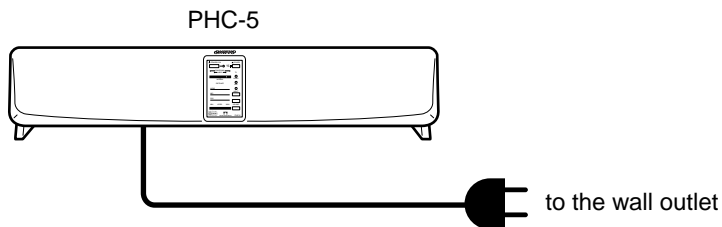

Turning on the power to the PHC-5 system

Press the **POWER** switch on the PHC-5 to turn the power on.

The **STANDBY/ON** indicator lights up.

Press the **POWER** switch again to turn the power off.

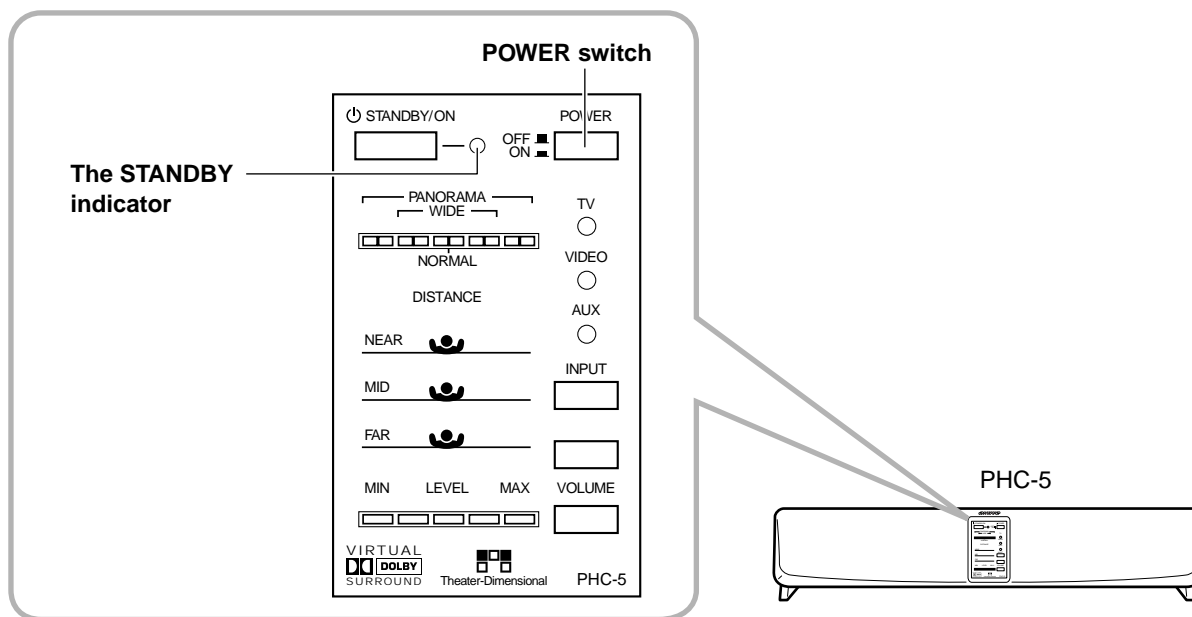

NOTE

Turn off the power to the PHC-5 if you do not use them for a long period of time.

Before Operating the PHC-5 System

Using the remote controller

Point the remote controller toward the remote control sensor panel on the unit. Operate the remote controller within the angle and distance specified in the figure below.

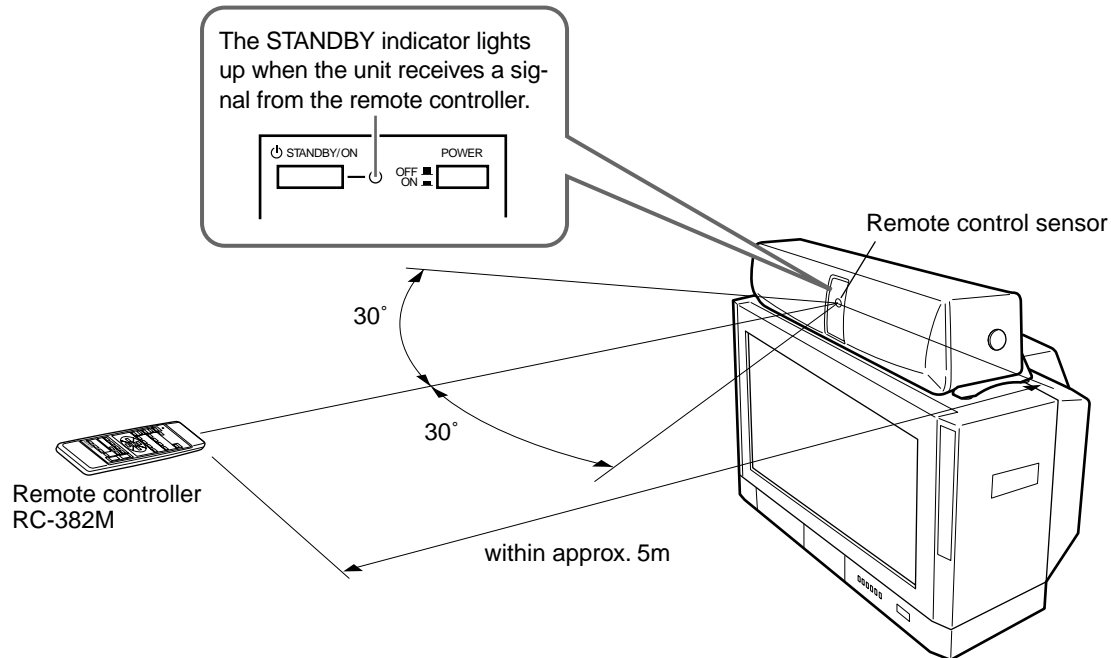

NOTE

- Do not let strong light, such as direct sunlight or an inverter fluorescent light, strike the remote control sensor panel.
- Do not use the unit with a different remote controller. Otherwise, a malfunction may occur.
- Do not place any object, such as a book, on the remote controller. Otherwise, a button on the remote controller may be held down, which will waste the batteries.
- An object between the remote controller and the sensor panel on the unit may prevent the remote controller from working.

Adjusting the angle of the unit

You can adjust the angle of the PHC-5 vertically (upward: about 20 degrees; downward: about 10 degrees). Adjust the angle according to the height of your ears.

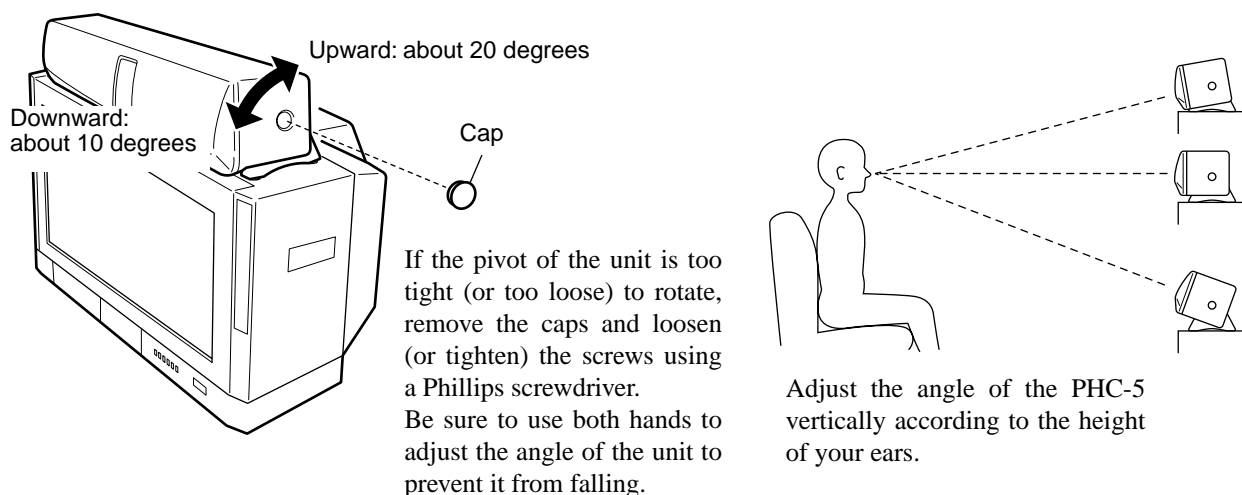

Operating the PHC-5 System

Compatible recordings and media

- The Virtual Surround system on the PHC-5 system produces the best effect with recordings (media) that use the “Dolby* Surround” system. These media include Hi-Fi VHS, laser discs, and DVD video, which carry the  mark. The Virtual Surround system also produces a great effect with normal stereo recordings, although some of them may seem to have a narrower stereo image or produce unnatural sound. In this case, use Stereo mode.
- Some stereo recordings use special recording techniques or special processing, such as virtual processing. The Virtual Surround system may sometimes over-enhance or reduce the effect too greatly with these recordings. In this case, use Stereo mode.
- The Virtual Surround system produces no effect with monaural recordings.

*Manufactured under license from Dolby Laboratories.

“Dolby” and the double-D symbol are trademarks of Dolby Laboratories.

Using the Virtual Surround system for TV sound

Lower the TV volume level to minimum and turn on the power to the PHC-5

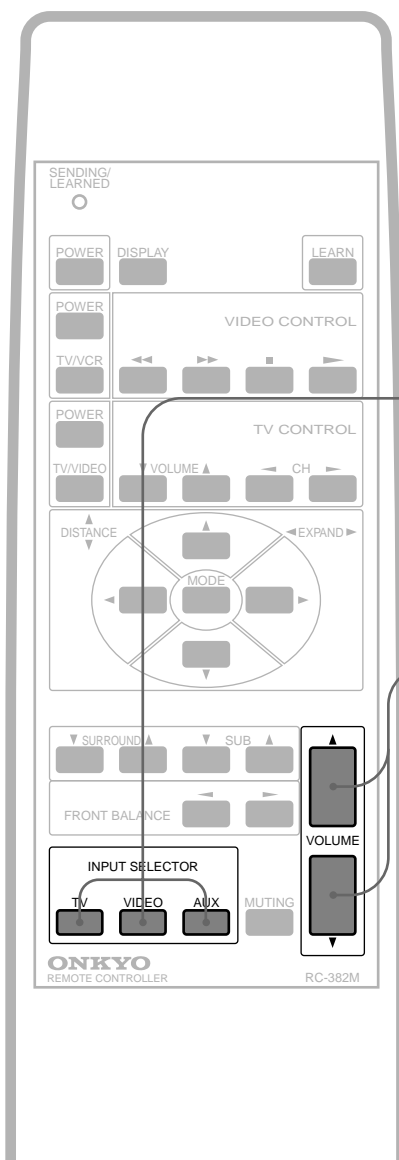

1 Turn on the power to the TV.

About three seconds after the TV sends out the audio signal, the power is turned on to the PHC-5 (IPM function), and the STANDBY/ON indicator turns off. The “TV” indicator in the “TV/VIDEO/AUX” section lights up.

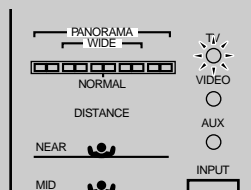

TIP

To listen to the audio of a device connected to the VIDEO/AUX jack, press the STANDBY/ON button on the unit or the POWER button on the remote controller, then press the INPUT button on the unit or the INPUT SELECTOR button on the remote controller to turn the “VIDEO” or “AUX” indicator on.

PHC-5

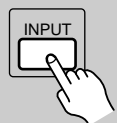

2 Adjust the volume level.

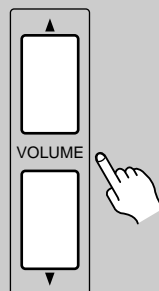

PHC-5

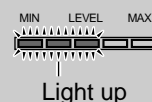
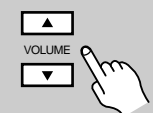

▲ : Raise the volume level.

▼ : Lower the volume level.

When you operate one of the VOLUME buttons (either on the unit or on the remote controller), the LEVEL meter lights up, indicating the current level. The LEVEL meter turns off five seconds after you release the button.

(Continued to the next page)

Operating the PHC-5 System (continued)

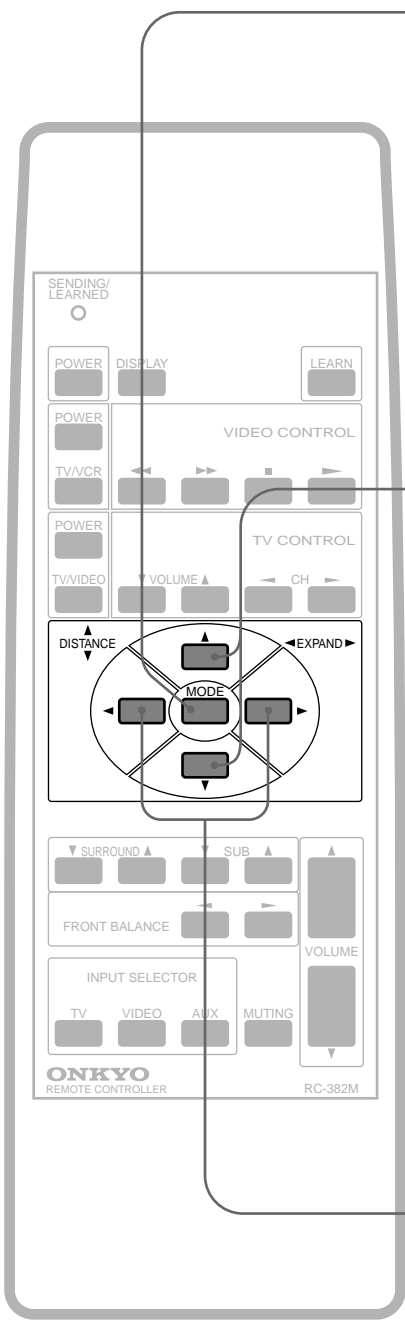

3 On the remote controller, select Virtual mode by pressing the **MODE** button.

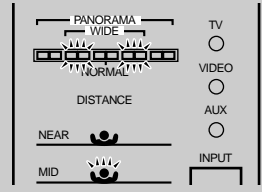

Pressing the **MODE** button repeatedly toggles between Virtual mode and Stereo mode.
If you select Stereo mode, skip to Step 7 on the next page.

4 Set the listening distance (distance between the listener and the unit) using the **DISTANCE** ▲/▼ buttons.

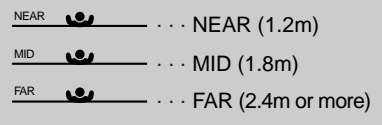
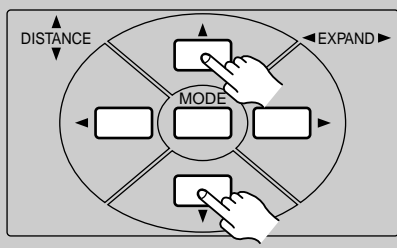

▲ : Press this button when the listening position is closer to the unit.
▼ : Press this button when the listening position is far from the unit.

NEAR (1.2m) ↔ MID (1.8m) ↔ FAR (2.4m or more)
(short) (medium) (long)

* This distance is a guideline. Adjust the distance while listening to the sound.

The mark lights up on the display of the unit, indicating the distance.

5 Use the **EXPAND** ◀/▶ buttons on the remote controller to adjust the width of the sound.

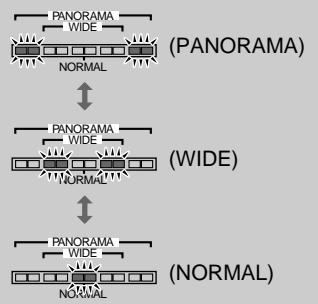
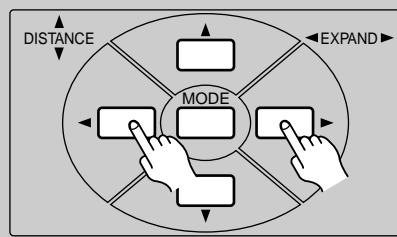

◀ : Press this button to reduce the width.
▶ : Press this button to expand the sound field.

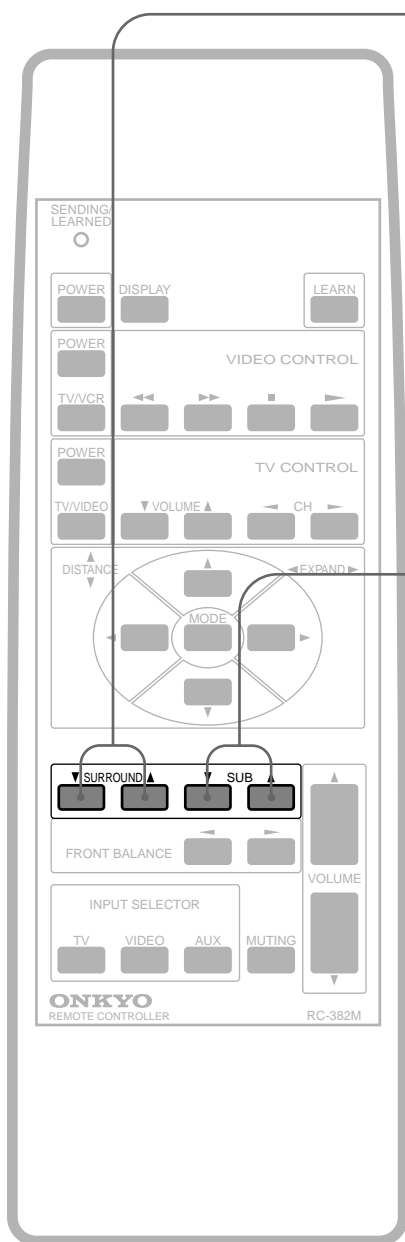

6 Adjust the volume level of the surround sound.

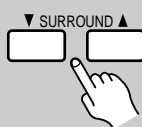

- ▲: Press this button to raise the surround sound.
- ▼: Press this button to lower the surround sound.

When you press the ▼SURROUND▲ button, the LEVEL meter lights up, indicating the current volume level. The meter turns off about five seconds after you release the button.

If a subwoofer has been connected:

7 Adjust the volume level of the subwoofer.

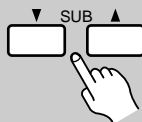

- ▲: Press this button to raise the sound from the subwoofer.
- ▼: Press this button to lower the sound from the subwoofer.

When you press the ▼SUB▲ button, the LEVEL meter lights up, indicating the current volume level. The meter turns off about five seconds after you release the button.

After watching the TV, turn off the power to the TV.

About five minutes after you turn off the power to the TV, the power to the unit is turned off, and the STANDBY indicator lights up.

NOTE

- If you press the INPUT button on the unit or the INPUT SELECTOR button on the remote controller to select an input source other than the TV after you turn off the power to the TV, the IPM function will be cancelled and the power to the PHC-5 will not be turned off after five minutes. (If you have selected VIDEO or AUX, the IPM function will be also cancelled and the power to the PHC-5 will remain turned on.)
- If you do not use the unit for a long period of time, turn off the POWER switch on the unit. (See page 9.)

To turn on/off the power to the unit without turning on/off the power to TV:



Press the POWER button on the remote controller.

Operating the PHC-5 System (continued)

Other functions

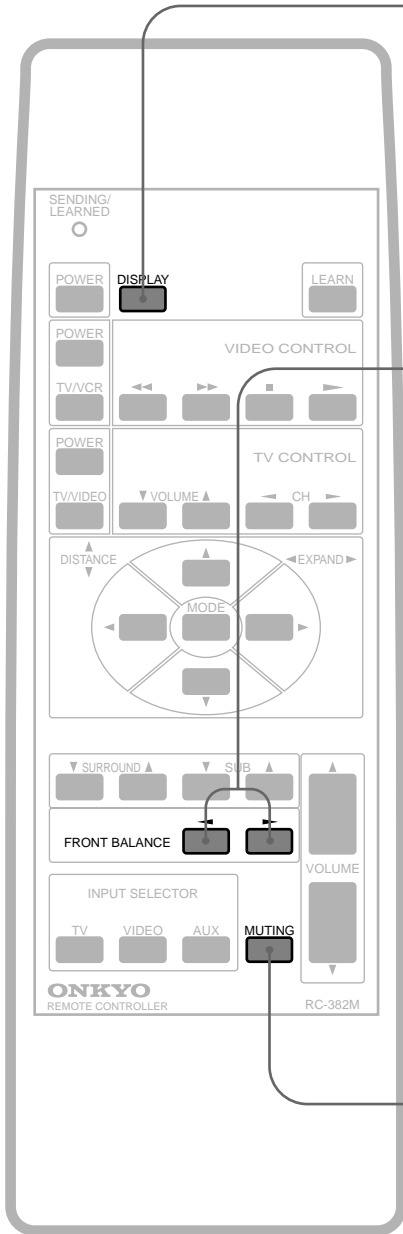

Turning off the light on the display



Pressing the DISPLAY button turns on/off the light on the display of the unit. This button is disabled in Stereo mode.

Adjusting the balance

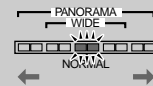
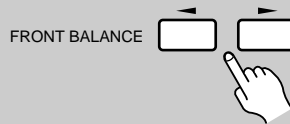

The sound pans to the left.

The sound pans to the right.

- ◀: Press this button to shift the sound to the left.
- ▶: Press this button to shift the sound to the right.

Note on adjusting the balance:

In Virtual Surround mode, set the balance in the center position and do not adjust it. Shifting the sound in this mode may impair the Virtual Surround effect.

- The PHC-5 remembers the balance setting in Stereo mode after you turn off the power to the unit. However, if you change to Virtual Surround mode, the balance setting is automatically reset to the center. Also, any balance setting made in Virtual Surround mode will be reset to the center after you turn off the power to the unit.

Muting the sound

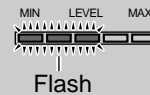

Press the MUTING button to mute the sound. Press the button again or press the VOLUME buttons (VOLUME ▼/▲) to cancel muting.

- The LEVEL meter flashes during mute.

Programmable Remote Controller

You can use the remote controller RC-382M to remotely control a TV or VCR by programming the functions of the remote controller for the device into the RC-382M.

Notes on programming the remote controller:

- Use new batteries for the RC-382M and the remote controller for a TV or VCR. Using old batteries may result in a failure in programming or cause the programmed remote controller buttons to work incorrectly.
- The RC-382M uses infrared rays, like most other remote controllers. The RC-382M may be unable to program other remote controllers that use different technology.
- The RC-382M has twelve buttons for programming. The number of items you can store in these buttons depends on the manufacturer of the remote controller and the type of the devices you wish to program into the RC-382M. (Some remote controllers allow you to program only one or two functions.) Program the desired functions to suit your preference.
- When you are programming the functions of the other device into the remote controller, the device may accidentally respond to the operation of the remote controller. To avoid this, turn off the power to the device.

Buttons used for programming

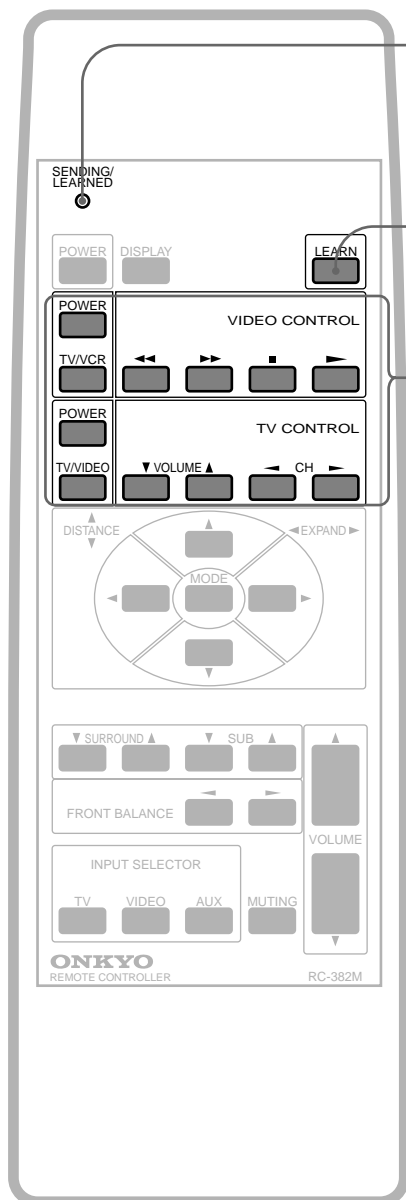

SENDING/LEARNED indicator

This indicator is a guide for programming the remote controller. It also tells you if an error occurs or if the battery voltage is low.

LEARN button

Press this button to program the functions of another remote controller into the RC-382M.

Programmable buttons

Use these twelve buttons to program the functions of another remote controller.
VCR: Power (POWER), TV/VIDEO switch (TV/VCR), Rewind (◀◀), Fast Forward (▶▶), Stop (■), Play (▶)
TV: Power (POWER), TV/VIDEO switch (TV/VIDEO), Volume level (▼ VOLUME ▲), Channel Up/Down (◀ CH ▶)

Programmable Remote Controller (continued)

Programming the other remote controller's function

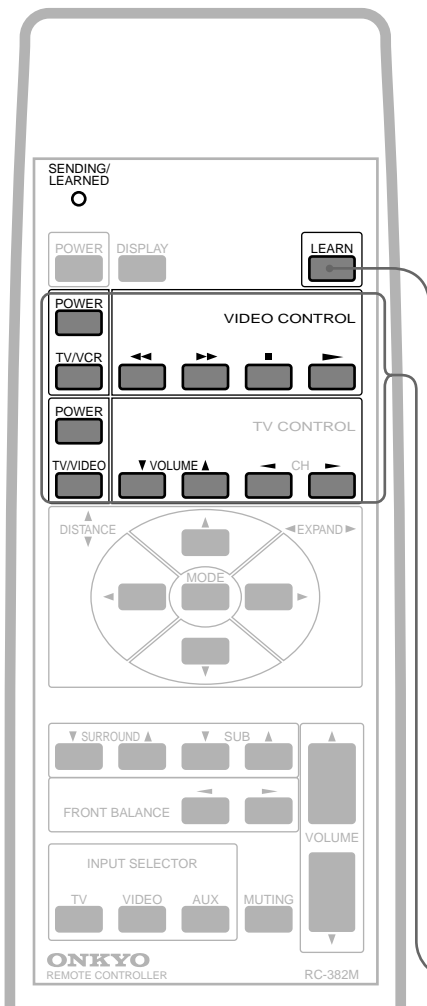

NOTE

- In the unlikely event that an infrared command cannot be learned by RC-382M, the SENDING/LEARNED indicator flashes for five seconds, meaning that the command is not "learnable." The RC-382M has been tested for compatibility with a very wide range of infrared remote control frequencies and data word lengths, but in some very rare instances, it may be unable to learn a particular remote control command.
- If programming fails or if the data size exceeds the capacity of the programmable buttons, the SENDING/LEARNED indicator flashes for five seconds.
- Refer to the instruction manual for the corresponding device for operational information on operating the device.
- Store the remote controller for the device in a safe place after programming is complete. If the programmed signals are erased due to dead batteries in the RC-382M or for other reasons, you will need the remote controller for the device to re-program the RC-382M.

- 1 Place both remote controllers on a level surface, such as on the table.**

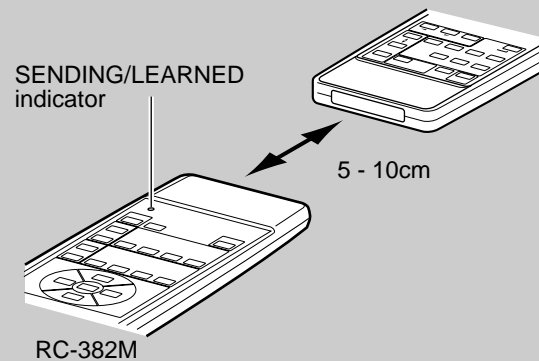

Point the tip of both remote controllers at each other at a distance of (5 - 10cm).

- 2 Press the LEARN button.**



Perform the next step within fifteen seconds.

- 3 Press one of the programmable buttons on the RC-382M you wish to program.**

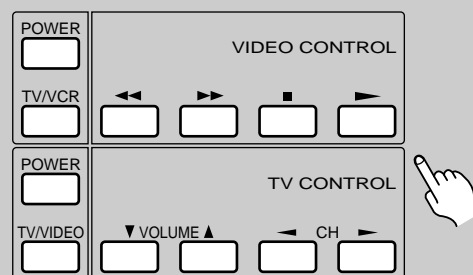

The SENDING/LEARNED indicator lights up.

- 4 While the SENDING/LEARNED indicator is lit, press the button on the other remote controller that corresponds to the function you wish to program into the RC-382M.**

When the RC-382M finishes learning, the SENDING/LEARNED indicator turns off. Repeat Steps 2 - 4 to program the desired functions.

Checking the programmed functions

Check to see if the programmed buttons operate the corresponding device correctly. If pressing one of the programmed buttons does not cause the **SENDING/LEARNED** indicator on the remote controller to light up, re-program again.

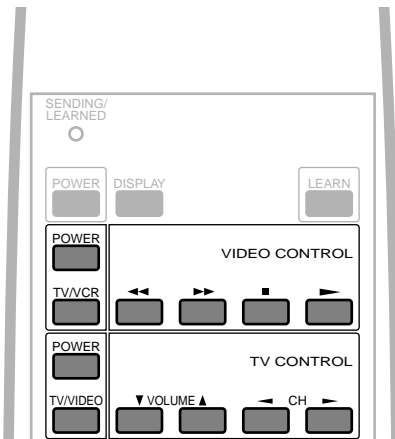

Press one of the programmable button to operate the corresponding device.

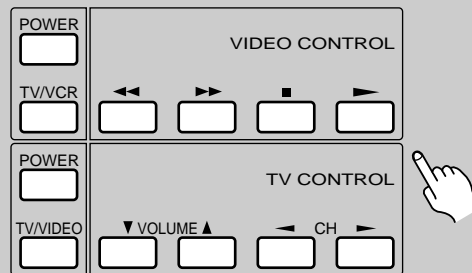

If the device does not respond correctly, refer to page 15.

If the programmed buttons do not enable you to operate the device correctly, review the following:

- **The remote controller does not work unless it is close to the device, or the device has a slow response to remote controller operation.**
The remote controller signal may not be programmed properly. Re-program the signal again. If the problem persists, check to see if the battery voltage is low.
- **The programmed signal has been erased.**
The programmed remote controller signals will be erased if the batteries have been removed for more than 30 minutes. You need to re-program the signals.

Erasing all programmed functions

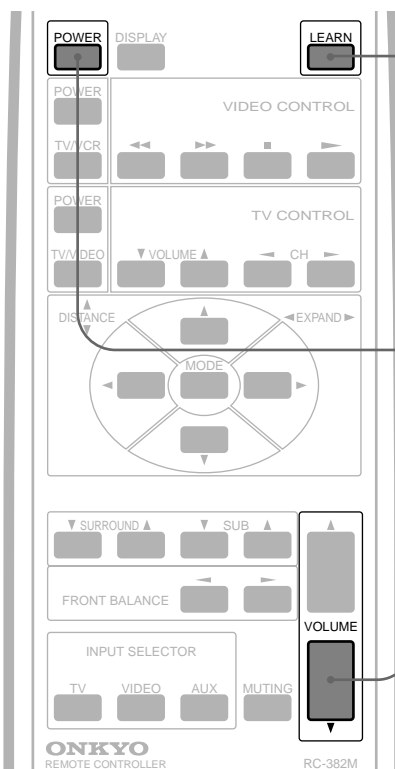

1 Press the LEARN button.



Perform the next step within fifteen seconds.

2 Press and hold the POWER button and press the VOLUME ▼ button.

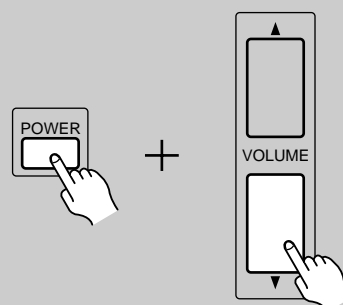

Hold down both buttons until the **SENDING/LEARNED** indicator turns off. All programmed functions will be erased.

Parts and Names

Virtual Surround Unit PHC-5 (front panel)

The numerals in parentheses indicate reference pages.

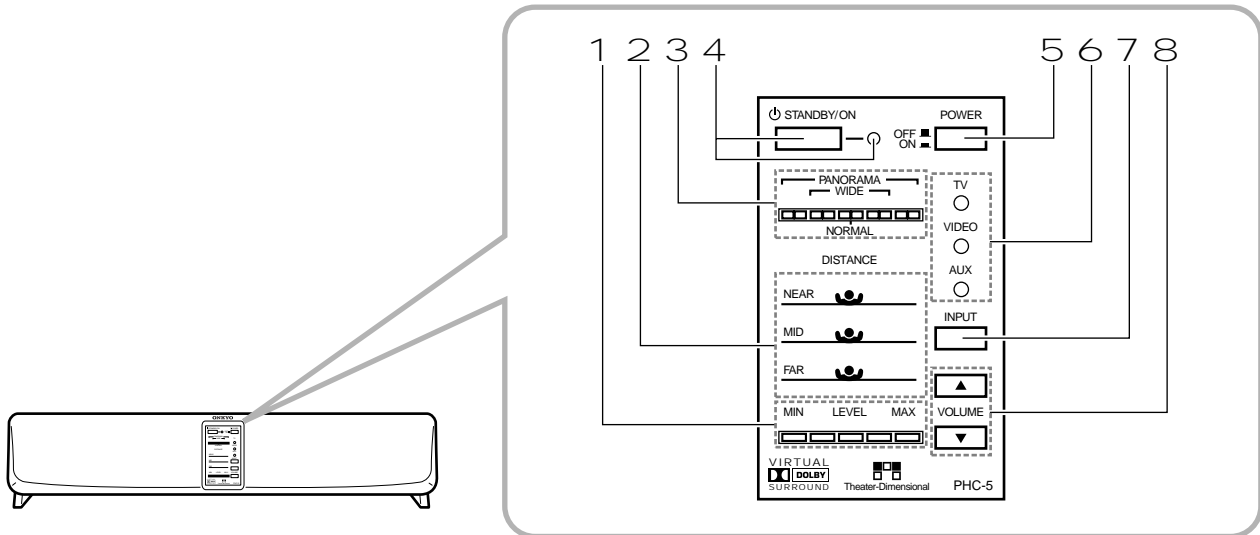

- | | |
|--|--------------------------------------|
| A LEVEL meter [11] | E POWER switch [9] |
| B DISTANCE indicator [12] | F TV/VIDEO/AUX indicator [11] |
| C EXPAND indicator [12] | G INPUT selector [11] |
| D STANDBY/ON button and indicator [9] | H VOLUME buttons [11] |

Virtual Surround Unit PHC-5 (rear panel)

The numerals in parentheses indicate reference pages.

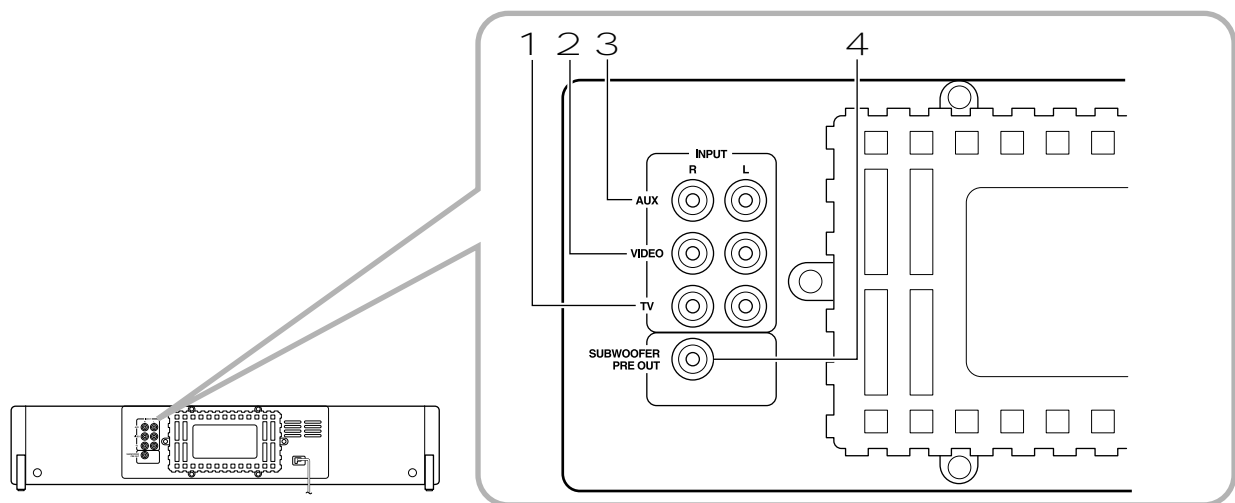

- | | |
|-------------------------------------|------------------------------------|
| A TV audio input jack [7] | C AUX input jack [8] |
| B VIDEO audio input jack [8] | D SUBWOOFER PREOUT jack [8] |

Remote controller RC-382M

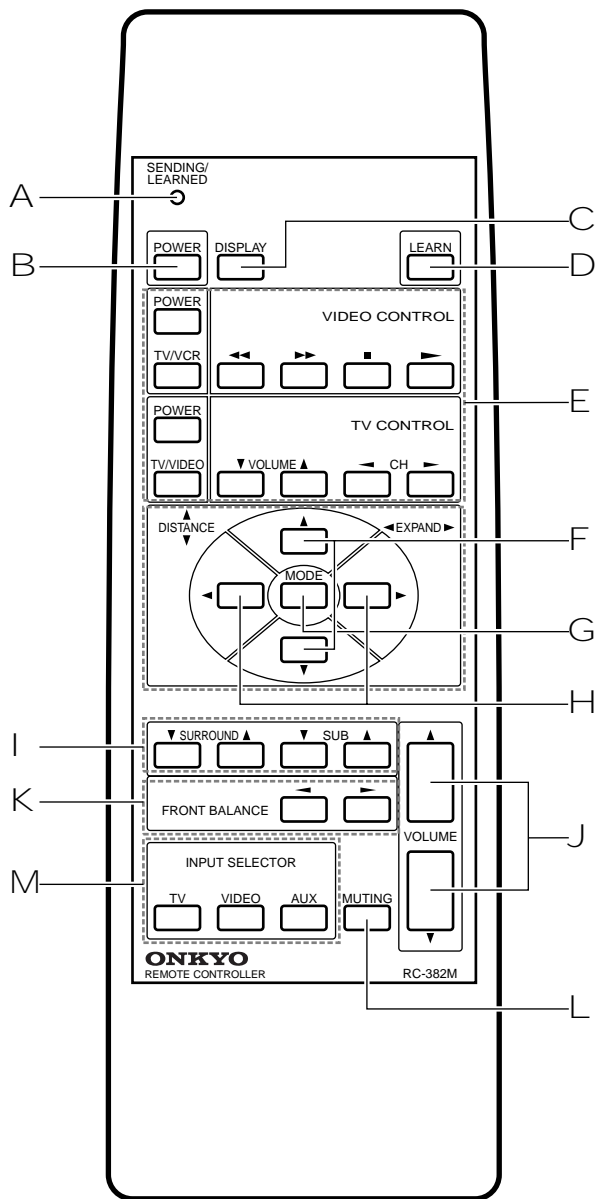

The numerals in parentheses indicate reference pages.

- A **SENDING/LEARNED** indicator [15~17]
- B **POWER** button [13, 17]
- C **Display light on/off button (DISPLAY)** [14]
- D **LEARN** button [15~17]
- E **Programmable buttons** [15~17]
- F **Listening distance adjustment buttons (DISTANCE)** [12]
- G **MODE** button [12]
- H **Sound width adjustment buttons (EXPAND)** [12]
- I **▼SURROUND▲ and ▼SUB▲ volume buttons** [13]
- J **VOLUME** buttons [11]
- K **Front speaker balance buttons (FRONT BALANCE)** [14]
- L **MUTING** button [14]
- M **INPUT SELECTOR** buttons [11]

Troubleshooting

If you have any problem operating the PHC-5 system, check the items listed below. If the problem persists, remove the power cord from the AC outlet, and contact your dealer or the nearest Onkyo Service Center with your name, address, phone number, the product name PHC-5, and a detailed description of the problem.

The problem may be caused by a connected device. Refer to the instruction manual for such a device.

Symptom	Cause	Action	Reference page
The power is not turned on.	<ul style="list-style-type: none">• The power cord is not connected securely.	<ul style="list-style-type: none">• Connect the power cord to the AC outlet securely.	9
The TV is turned on, but the PHC-5 is not turned on.	<ul style="list-style-type: none">• No sound is produced from TV broadcast or video sources.• Connection is incorrect.	<ul style="list-style-type: none">• When the TV sends audio signals to the PHC-5, the IPM function will turn on the power to the unit.• Check the connection.	7 7
The power is turned on, but no sound is heard.	<ul style="list-style-type: none">• The stereo audio connection cable is not connected correctly.• The muting function is turned on.	<ul style="list-style-type: none">• Check the cable connections.• Press the MUTING button on the remote controller.	7, 8 14
The buttons on the main unit works, but the unit does not respond to the remote controller operation.	<ul style="list-style-type: none">• Batteries are not installed in the remote controller.• The batteries in the remote controller are dead.	<ul style="list-style-type: none">• Install batteries in the remote controller.• Replace old batteries with new ones.	4 4

Because the unit contains a microcomputer to provide advanced functions, it may malfunction due to external noise or static electricity. If this happens, press the POWER switch on the unit and then press it in again after about five seconds.

Specifications

Virtual Surround Unit PHC-5

ELECTRICAL SECTION

Power Output: **Continuous Average Power Output**
24 W × 2 at 6 ohms min. RMS. both
channel driven from 100 Hz to
20 kHz no more than 0.5% THD.
25 W × 2 at 6 ohms (DIN)

Input Sensitivity and Impedance
LINE (TV, VIDEO, AUX): 300 mV, 50 kohms

GENERAL

OMF cone speaker size: 10 cm × 2
Power supply: AC 230 V, 50 Hz
Dimensions (W×H×D): 635 × 131 × 206 mm
Weight: 6.6 kg

Specifications and features are subject to change without notice.

ONKYO CORPORATION

Sales & Product Planning Div. : 2-1, Nisshin-cho, Neyagawa-shi, OSAKA 572-8540, JAPAN
Tel: 0720-31-8111 Fax: 0720-33-5222

ONKYO U.S.A. CORPORATION

200 Williams Drive, Ramesy, N.J. 07446, U.S.A.
Tel: 201-825-7950 Fax: 201-825-8150 E-mail: onkyousa.com

ONKYO EUROPE ELECTRONICS GmbH

Industriestrasse 20, 82110 Germering, GERMANY
Tel: 089 84 93 20 Fax: 089 84 93 226 E-mail: info@onkyo.de

ONKYO EUROPE FRANCE BRANCH

Domaine Technologique de Saclay 4, Rue René Razel, SACLAY-91892
ORSAY CEDEX, FRANCE Tel: (1) 69 33 14 00 Fax: (1) 69 41 35 84

ONKYO CHINA LIMITED

Units 2102-7, Metroplaza Tower I, 223 Hing Fong Road, Kwai Chung,
N.T., HONG KONG Tel: 852 2429 3118 Fax: 852 2428 9039



Free Manuals Download Website

<http://myh66.com>

<http://usermanuals.us>

<http://www.somanuals.com>

<http://www.4manuals.cc>

<http://www.manual-lib.com>

<http://www.404manual.com>

<http://www.luxmanual.com>

<http://aubethermostatmanual.com>

Golf course search by state

<http://golfingnear.com>

Email search by domain

<http://emailbydomain.com>

Auto manuals search

<http://auto.somanuals.com>

TV manuals search

<http://tv.somanuals.com>