

ONKYO®

7.1ch Home Theater Speaker Package

HTP-750X

Front Speakers (SKF-750XF L/R)

Center Speaker (SKC-750XC)

Surround Speakers (SKM-750XS L/R)

Surround Back Speakers (SKB-750X L/R)

Subwoofer (SKW-750X)

Speaker Stand

AS-140

Instruction Manual

Thank you for purchasing an Onkyo home theater speaker package. Please read this manual thoroughly before using your new speakers. Following the instructions in this manual will enable you to obtain optimum performance and listening enjoyment from your speaker package.

Please retain this manual for future reference.

Contents

Getting Started

Important Safety Instructions	2
Precautions	3
Speaker Precautions	3
Package Contents	5
Getting to know Your Speaker Package	6

Installing & Using

Connecting the Speakers	10
-------------------------------	----

Appendix

Troubleshooting	11
Specifications	

WARNING:

TO REDUCE THE RISK OF FIRE OR ELECTRIC SHOCK, DO NOT EXPOSE THIS APPARATUS TO RAIN OR MOISTURE.

CAUTION:

TO REDUCE THE RISK OF ELECTRIC SHOCK, DO NOT REMOVE COVER (OR BACK). NO USER-SERVICEABLE PARTS INSIDE. REFER SERVICING TO QUALIFIED SERVICE PERSONNEL.



WARNING
RISK OF ELECTRIC SHOCK
DO NOT OPEN

AVIS
RISQUE DE CHOC ELECTRIQUE
NE PAS OUVRIR



The lightning flash with arrowhead symbol, within an equilateral triangle, is intended to alert the user to the presence of uninsulated “dangerous voltage” within the product’s enclosure that may be of sufficient magnitude to constitute a risk of electric shock to persons.



The exclamation point within an equilateral triangle is intended to alert the user to the presence of important operating and maintenance (servicing) instructions in the literature accompanying the appliance.

Important Safety Instructions

1. Read these instructions.
2. Keep these instructions.
3. Heed all warnings.
4. Follow all instructions.
5. Do not use this apparatus near water.
6. Clean only with dry cloth.
7. Do not block any ventilation openings. Install in accordance with the manufacturer’s instructions.
8. Do not install near any heat sources such as radiators, heat registers, stoves, or other apparatus (including amplifiers) that produce heat.
9. Do not defeat the safety purpose of the polarized or grounding-type plug. A polarized plug has two blades with one wider than the other. A grounding type plug has two blades and a third grounding prong. The wide blade or the third prong are provided for your safety. If the provided plug does not fit into your outlet, consult an electrician for replacement of the obsolete outlet.
10. Protect the power cord from being walked on or pinched particularly at plugs, convenience receptacles, and the point where they exit from the apparatus.
11. Only use attachments/accessories specified by the manufacturer.
12. Use only with the cart, stand, tripod, bracket, or table specified by the manufacturer, or sold with the apparatus. When a cart is used, use caution when moving the cart/apparatus combination to avoid injury from tip-over.

PORTABLE CART WARNING
S3125A
13. Unplug this apparatus during lightning storms or when unused for long periods of time.
14. Refer all servicing to qualified service personnel. Servicing is required when the apparatus has been damaged in any way, such as power-supply cord or plug is damaged, liquid has been spilled or objects have fallen into the apparatus, the apparatus has been exposed to rain or moisture, does not operate normally, or has been dropped.
15. Damage Requiring Service
Unplug the apparatus from the wall outlet and refer servicing to qualified service personnel under the following conditions:
 - A. When the power-supply cord or plug is damaged,
 - B. If liquid has been spilled, or objects have fallen into the apparatus,
 - C. If the apparatus has been exposed to rain or water,
 - D. If the apparatus does not operate normally by following the operating instructions. Adjust only those controls that are covered by the operating instructions as an improper adjustment of other controls may result in damage and will often require extensive work by a qualified technician to restore the apparatus to its normal operation,
 - E. If the apparatus has been dropped or damaged in any way, and
 - F. When the apparatus exhibits a distinct change in performance this indicates a need for service.
16. Object and Liquid Entry
Never push objects of any kind into the apparatus through openings as they may touch dangerous voltage points or short-out parts that could result in a fire or electric shock.
The apparatus shall not be exposed to dripping or splashing and no objects filled with liquids, such as vases shall be placed on the apparatus.
Don’t put candles or other burning objects on top of this unit.
17. Batteries
Always consider the environmental issues and follow local regulations when disposing of batteries.
18. If you install the apparatus in a built-in installation, such as a bookcase or rack, ensure that there is adequate ventilation.
Leave 20 cm (8") of free space at the top and sides and 10 cm (4") at the rear. The rear edge of the shelf or board above the apparatus shall be set 10 cm (4") away from the rear panel or wall, creating a flue-like gap for warm air to escape.

Precautions

1. AC Fuse—The AC fuse inside the unit is not user-serviceable. If you cannot turn on the unit, contact your Onkyo dealer.

2. Care—Occasionally you should dust the unit all over with a soft cloth. For stubborn stains, use a soft cloth dampened with a weak solution of mild detergent and water. Dry the unit immediately afterwards with a clean cloth. Don't use abrasive cloths, thinners, alcohol, or other chemical solvents, because they may damage the finish or remove the panel lettering.

3. Power

WARNING

BEFORE PLUGGING IN THE UNIT FOR THE FIRST TIME, READ THE FOLLOWING SECTION CAREFULLY.

AC outlet voltages vary from country to country. Make sure that the voltage in your area meets the voltage requirements printed on the unit's rear panel (e.g., AC 230 V, 50 Hz or AC 120 V, 60 Hz).

The power cord plug is used to disconnect this unit from the AC power source. Make sure that the plug is readily operable (easily accessible) at all times.

Auto standby function does not fully shutdown the SKW-750X. If you do not intend to use the SKW-750X, remove the power cord from the AC outlet.

For Canadian models

For models having a power cord with a polarized plug:

CAUTION: TO PREVENT ELECTRIC SHOCK, MATCH WIDE BLADE OF PLUG TO WIDE SLOT, FULLY INSERT.

Modèle pour les Canadiens

Sur les modèles dont la fiche est polarisée:

ATTENTION: POUR ÉVITER LES CHOCS ÉLECTRIQUES, INTRODUIRE LA LAME LA PLUS LARGE DE LA FICHE DANS LA BORNE CORRESPONDANTE DE LA PRISE ET POUSSER JUSQU'AU FOND.

Speaker Precautions

Placement

- The subwoofer cabinet is made out of wood and is therefore sensitive to extreme temperatures and humidity, do not put it in locations subject to direct sunlight or in humid places, such as near an air conditioner, humidifier, bathroom, or kitchen.
- Do not put water or other liquids close to the speakers. If liquid is spilled over the speakers, the drive units may be damaged.
- Speakers should only be placed on sturdy, flat surfaces that are free from vibration. Putting them on uneven or unstable surfaces, where they may fall and cause damage, will affect the sound quality.
- Subwoofer is designed to be used in the upright vertical position only. Do not use it in the horizontal or tilted position.
- If the unit is used near a turntable, CD player or DVD player, howling or slipping of sound may occur. To prevent this, move the unit away from the turntable, CD player or DVD player, otherwise lower the unit's output level.

Using Close to a TV or Computer

TVs and computer monitors are magnetically sensitive devices and as such are likely to suffer discoloration or picture distortion when conventional speakers are placed nearby. To prevent this, the SKF-750XF and SKC-750XC feature internal magnetic shielding. In some situations, however, discoloration may still be an issue, in which case you should turn off your TV or monitor, wait 15 to 30 minutes, and then turn it back on again. This normally activates the degaussing function, which neutralizes the magnetic field, thereby removing any discoloration effects. If discoloration problems persist, try moving the speakers away from your TV or monitor. Note that discoloration can also be caused by a magnet or demagnetizing tool that's too close to your TV or monitor.

Do not place SKM-750XS/SKB-750X close to TV or a computer monitor because they have no magnetic shield.

Input Signal Warning

The speakers can handle the specified input power when used for normal music reproduction. If any of the following signals are fed to them, even if the input power is within the specified rating, excessive current may flow in the speaker coils, causing burning or wire breakage:

1. Interstation noise from an untuned FM radio.
2. Sound from fast-forwarding a cassette tape.
3. High-pitched sounds generated by an oscillator, electronic musical instrument, and so on.
4. Amplifier oscillation.
5. Special test tones from audio test CDs and so on.
6. Thumps and clicks caused by connecting or disconnecting audio cables (Always turn off your amplifier before connecting or disconnecting cables.)
7. Microphone feedback.

Speaker care

Wipe the cabinet occasionally with a dry silica or soft cloth. For heavier dirt, after dampening a soft cloth in a weak solution of mild detergent and water and wringing it out dry, wipe off the dirt. Then, dry immediately with a clean cloth. Do not use rough material, thinners, alcohol or other chemical solvents or cloths since these could damage the finish, remove the panel lettering, or cause discoloration. If you are using a chemical cloth, always follow the instructions that come with the cloth. For dust accumulated on grilles, use a vacuum cleaner or brush it off.

Power Cord Precautions

- Before connecting the power cord, connect all of your speakers and AV components.
- Turning on the SKW-750X may cause a momentary power surge that might interfere with other electrical equipment on the same circuit. If this is a problem, plug the SKW-750X into a different branch circuit.

Speaker Stand AS-140 Precautions

1. Be sure to tighten the screws when you assemble the speaker stands and attach the brackets to the speakers.
2. The speaker stands are tall. Install the stands in a manner that will not allow the speakers to tip over. You may want to use commercially available chains to prevent the stands from falling in the event of an earthquake.
3. Do not place the stands on an unstable table, slope, or thick carpet. Otherwise, the stands may fall, causing injury.
4. Place the stands in a location in which they would not cause injury if they accidentally fell.
5. Do not place the stands in an area at risk of fire or damage, such as near a fireplace, heater, glass window, etc.

Package Contents

Make sure your box contains all of the items below. If anything is missing, contact the nearest Onkyo dealer.

Speaker Package HTP-750X

- Front speakers (SKF-750XF)

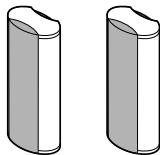

Speaker cables for the left and right front speakers have been attached to the speaker stand AS-140.

- Center speaker (SKC-750XC)

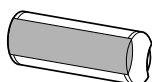

- Speaker cable for center speaker 10 ft. (3 m)



(Green)

- Surround and Surround back speakers (SKM-750XS/SKB-750X)

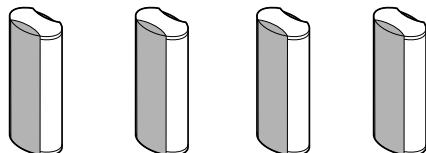

- Speaker cables for surround and surround back speakers 30 ft. (9 m)



(Blue)

(Gray)

(Brown)

(Tan)

- Subwoofer (SKW-750X)

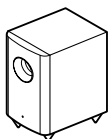

- RCA cable for subwoofer connection 10 ft. (3 m)



- 4 floor pads for the subwoofer

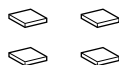

- Rubber spacers [20 pcs.] (For the speakers)



- Base for horizontal mounting (For the center speaker)

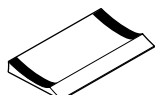

Speaker Stand AS-140

- Screws (large) [2]
- Screws (small) [4]

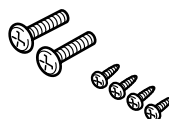

- Pipe stands [2] (with the speaker cables wired)
- Base panels [2]

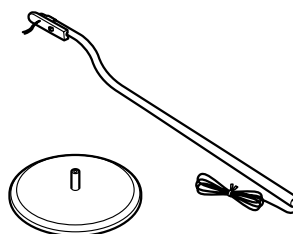

The alphabet displayed at the end of the product name found in catalogs and on package represents the color of the system. Though the color varies, the specifications and operations are the same.

Getting to know Your Speaker Package

Front, Center, Surround, and Surround back speakers (SKF-750XF, SKC-750XC, SKM-750XS, SKB-750X)

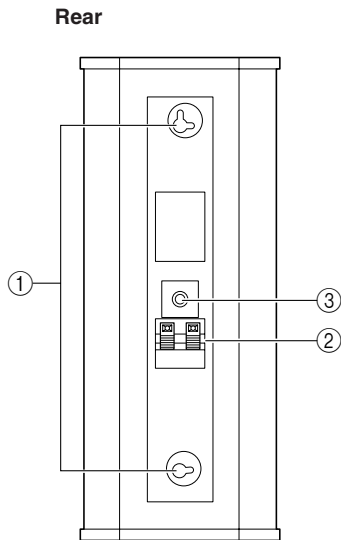

① Keyhole slots

These keyhole slots can be used to wall-mount the speaker.

They can also be used to install the speaker on the stand.

② Speaker terminals

These push terminals are for connecting the speaker to your AV Receiver with the supplied speaker cables. The supplied speaker cables are color-coded for easy identification. Simply connect each cable to the same-colored positive speaker terminal.

③ Speaker mount/bracket inserts

These threaded inserts can be used to attach the speaker either horizontally or vertically to a speaker mount or bracket.

Note:

Use commercially available 1/4" screws to attach the speaker to a speaker mount or bracket.

Speaker Stand

Follow the steps below to install each front speaker onto a speaker stand.

- 1 Loosen the bundled speaker cable, insert the cable into the hole of the base panel from the top, then pull the cable out and downward.**

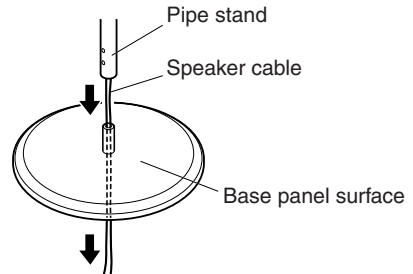

Do not pull the speaker cable too hard, as it may break.

- 2 Attach the pipe stand to the base panel in the correct orientation so that the screw holes on the pipe stand and the holes in the base panel will align. Tighten the screws firmly.**

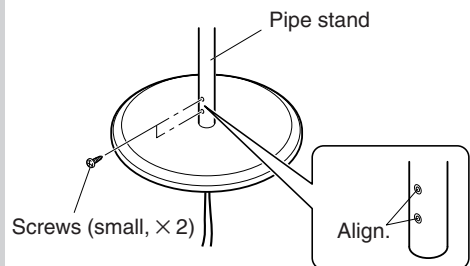

- 3 Guide the speaker cable along the arrow on the base panel bottom, and snap the cable into the notch on the perimeter of the base panel bottom.**

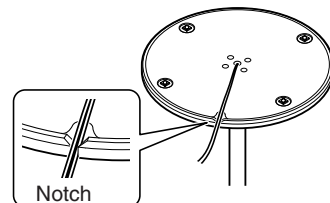

4 While pressing in the lever on the speaker terminal on the rear panel of the speaker, connect the speaker cable to the terminal.

The supplied speaker cables are color-coded for easy identification. Simply connect each cable to the same-colored positive speaker terminal.

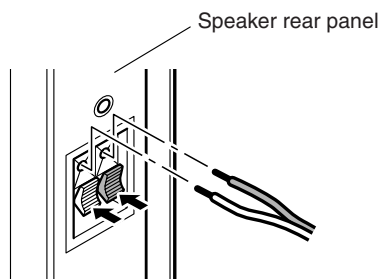

5 (1) Insert the hook on the pipe stand into the key hole on the speaker's rear panel, then (2) press and slide the speaker downward.

(2) Press and slide the speaker downward.

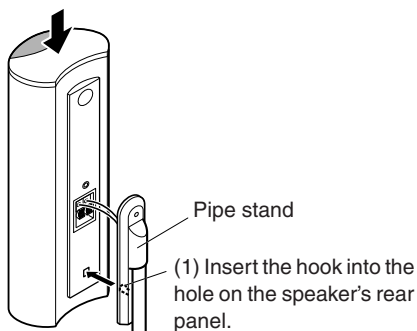

Note:

Be careful not to pinch the speaker cable between the pipe stand cover and the speaker's rear panel.

6 Attach the pipe stand to the speaker securely using the included screw (large).

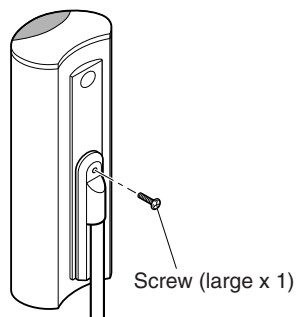

7 Completed.



Caution:

To remove the speaker from the stand, remove the screw, slide the speaker upward to release the hook, and reverse the steps for installing the speaker to the stand.

Center Speaker Base

The center speaker base is for mounting the center speaker horizontally. If you put it on a TV stand or AV stand, aim it toward the listening position. The center speaker should sit securely on the base. If it's loose, try resetting it.

The cradle surface of the base features two stoppers to prevent the speaker from moving. Therefore, you can tilt the speaker toward the front by up to 11 degrees.

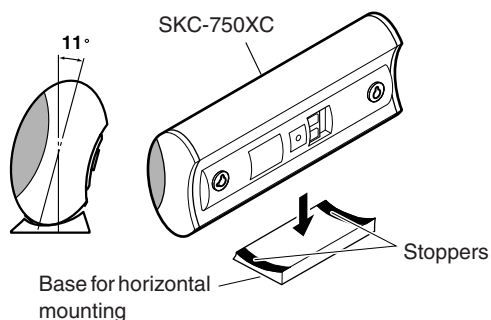

■ Using the included rubber spacers

We recommend using the supplied rubber spacers to achieve the best possible sound from your speakers. The rubber spacers prevent the speakers from moving, providing a more stable setup.

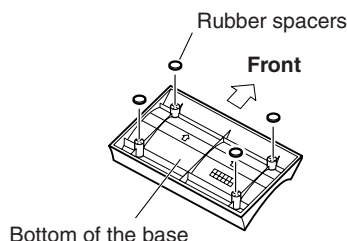

Wall Mounting

The speakers can easily be wall mounted by using the keyhole slots. To prevent the speaker from vibrating against the wall, attach four of the supplied spacers to the keyhole fins on the rear of each speaker.

■ Mounting vertically

To mount the front speakers vertically, use the keyhole slot shown to hang each speaker on a screw that's securely screwed into the wall.

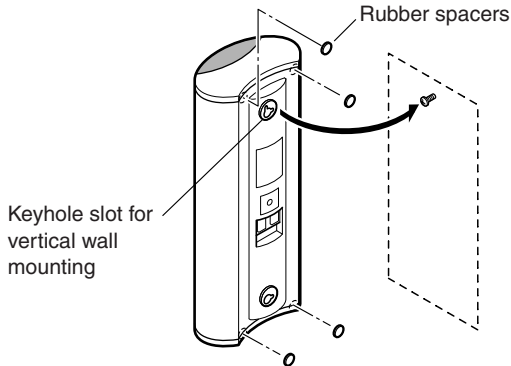

■ Mounting horizontally

To mount the center speaker horizontally, use the two keyhole slots shown to hang each speaker on two screws that are securely screwed into the wall.

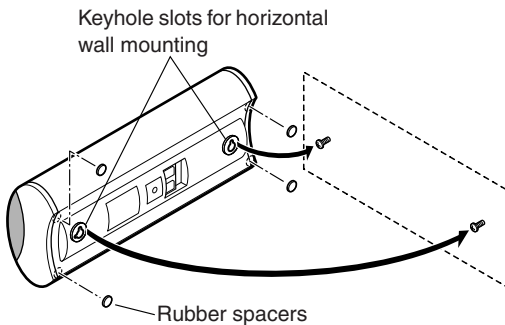

Caution:

A mounting screw's ability to support a speaker depends on how well it's anchored to the wall. If you have hollow walls, screw each mounting screw into a stud. If there are no studs, or the walls are solid, use suitable wall anchors. Use screws with a head diameter of 3/8" (9 mm) or less and a shank diameter of 1/8" (3.5 mm) or less. With hollow walls, use a cable/pipe detector to check for any power cables or water pipes before making any holes. Leave a gap of between 1/4" and 5/16" (6–8 mm) between the wall and the base of the screw head, as shown.

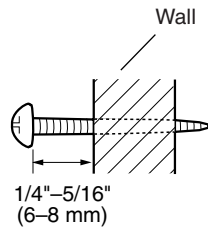

(We recommend that you consult a home installation professional.)

■ Using Rubber Spacers with the Speakers

We recommend using the supplied rubber spacers to achieve the best possible sound from your speakers. The rubber spacers prevent the speakers from moving, providing a more stable setup.

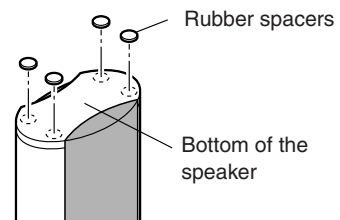

Subwoofer (SKW-750X)

■ Front

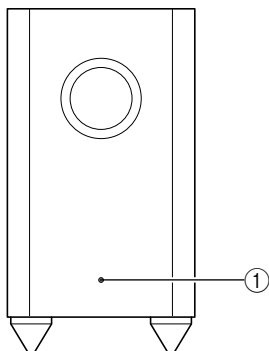

If the subwoofer is placed on a hard floor (wood, vinyl, tile, etc.) and playback is very loud, the subwoofer's feet may damage the flooring. To prevent this, place the supplied pads underneath the subwoofer's feet. The pads also provide a stable base for the subwoofer.

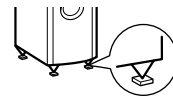

Setting the Subwoofer Level

To set the level of the subwoofer, use the **OUTPUT LEVEL** control. Set it so that bass sounds are evenly balanced with the treble sounds from the other speakers. Because our ears are less sensitive to very low bass sounds, there's a temptation to set the level of the subwoofer too high. As a rule of thumb, set the subwoofer level to what you think is the optimal level, and then back it off slightly.

■ Rear

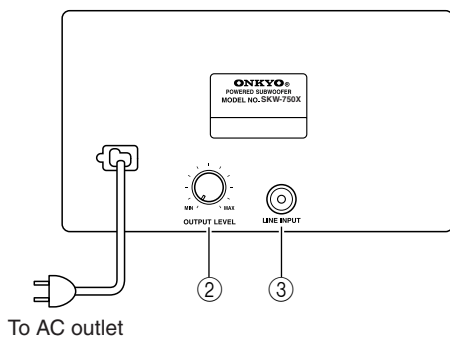

① **STANDBY/ON indicator**

Red: Subwoofer in standby mode

Blue: Subwoofer on

With the Auto Standby function, the SKW-750X automatically turns on when an input signal is detected in Standby mode. When there's no input signal for a while, the SKW-750X automatically enters Standby mode.

② **OUTPUT LEVEL control**

This control is used to adjust the volume of the subwoofer.

③ **LINE INPUT**

This RCA input should be connected to the subwoofer pre out on your AV receiver with supplied RCA cable.

Note:

The Auto Standby function turns the subwoofer on when the input signal exceeds a certain level. If the Auto Standby function does not work reliably, try slightly increasing or decreasing the subwoofer output level on the AV receiver.

Connecting the Speakers

Read the following before connecting your speakers:

- Turn off your receiver or amp before making any connections.
- Disconnect the power cord from the wall outlet before making any connections.
- Pay close attention to speaker wiring polarity. Connect positive (+) terminals to only positive (+) terminals, and negative (–) terminals to only negative (–) terminals. If the speakers are wired incorrectly, the sound will be out of phase and will sound unnatural.
- Be careful not to short the positive and negative wires. Doing so may damage your amp.



For more information, please refer to the TX-SR606 Instruction Manual.

Connecting the Speaker Cables

Use the supplied cables to connect each speaker's input terminals to the corresponding speaker output terminals on your receiver.

Match the color of each cable to the corresponding speaker terminal.

To make a connection, while pressing the terminal lever, insert the wire into the hole, and then release the lever.

Make sure that the terminals are gripping the bare wires, not the insulation.

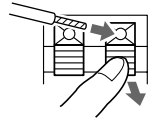

Connecting the Subwoofer

Using the supplied RCA cable, connect the subwoofer's LINE INPUT to your receiver's SUBWOOFER PRE OUT.

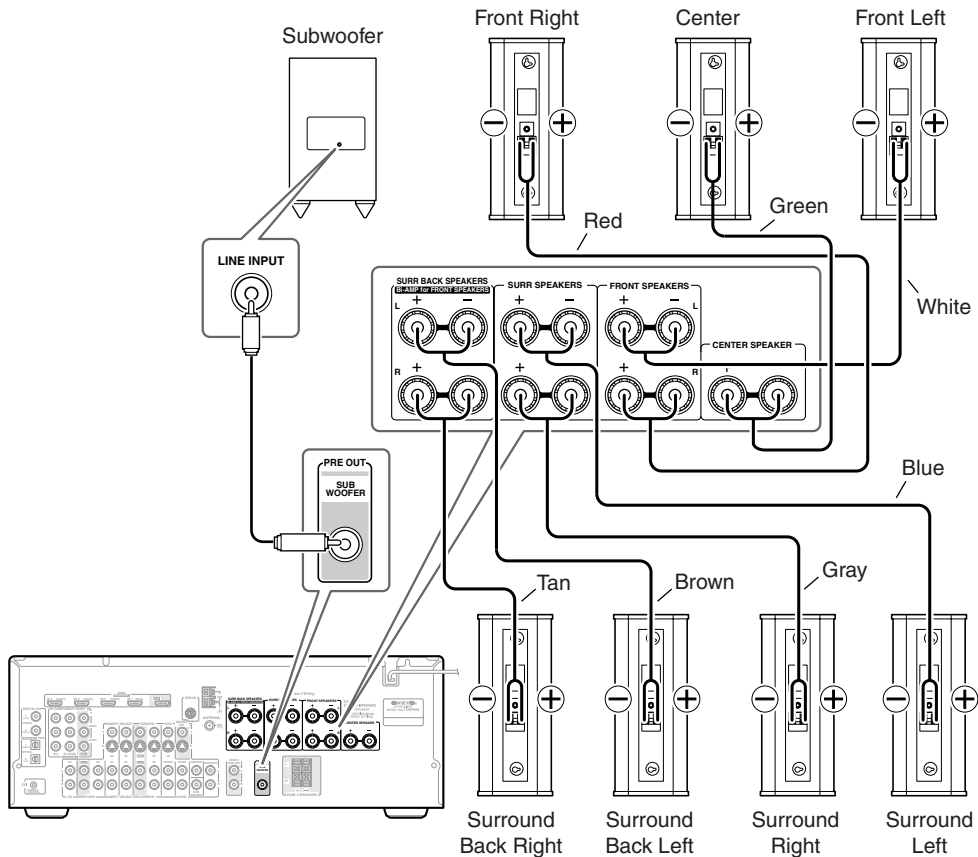

Troubleshooting

Symptom	Possible cause	Remedy
There's no sound coming from certain speakers?	The speaker cables are not connected properly.	Check the speaker cables and correct as necessary.
	The speaker configuration is not set correctly.	Check the speaker configuration.
The subwoofer does not turn on?	The power plug is not fully inserted into the wall outlet.	Insert the power plug fully into the wall outlet.
The subwoofer produces no sound?	The OUTPUT LEVEL control is set to minimum.	Turn up the OUTPUT LEVEL control.
	The RCA cable is not properly connected to the subwoofer's LINE INPUT.	Make sure that the RCA cable is properly connected to the subwoofer's LINE INPUT.
	The level of the input signal was too low and the subwoofer entered Standby mode.	Slightly increase the subwoofer pre out output level on your AV receiver.
	The Subwoofer configuration is not set correctly.	Check the subwoofer setting in the speaker configuration on your AV receiver.
The subwoofer produces hardly any sound?	The source material contain little or no bass content.	Choose source material with more bass content.
A humming sound can be heard from the subwoofer?	The RCA cable is not properly connected to the subwoofer's LINE INPUT.	Make sure that the RCA cable is properly connected to the subwoofer's LINE INPUT.
	External interference from a TV or other electronic device is being picked up.	Move the subwoofer and RCA cable away from the interference source. Make sure your audio system is grounded properly.

Specifications

■ Powered Subwoofer (SKW-750X)

Type: Bass-reflex
Input sensitivity/impedance: 140 mV / 20 k Ω
Maximum output power: 290 W (Dynamic Power)
Frequency response: 25 Hz–150 Hz
Cabinet capacity: 1.3 cubic feet (37 L)
Dimensions (W × H × D): 10-13/16" × 19-15/16" × 16-3/16"
(275 × 507 × 411 mm)
Weight: 25.6 lbs. (11.2 kg)
Drivers unit: 10" (25 cm) Cone Woofer × 1
Power supply: AC 120 V, 60 Hz
Power consumption: 163 W
Other: Auto Standby function

■ Front/Center Speaker (SKF-750XF/SKC-750XC)

Type: 2 Way Closed Type
Impedance: 8 Ω
Maximum input power: 110 W
Output sound pressure level: 79 dB/W/m
Frequency response: 60 Hz–50 kHz
Crossover frequency: 3 kHz
Cabinet capacity: 0.07 cubic feet (2 L)
Front speaker (SKF-750XF)
Dimensions (W × H × D): 5-1/2" × 14" × 3-11/16"
(140 × 355 × 93 mm)
Center speaker (SKC-750XC)
Dimensions (W × H × D): 14" × 5-1/2" × 3-11/16"
(355 × 140 × 93 mm)
Weight: 4.0 lbs. (1.8 kg)
Drivers unit: 3-1/8" (8 cm) Cone Woofer × 2
1 inch (2.5 cm) Balanced Dome Tweeter × 1
Spring Type Color Coded
Terminal: 2
Keyhole slots: 2
Grille: Fixed
Other: Magnetic shielding

■ Surround/Surround Back Speaker (SKM-750XS/SKB-750X)

Type: 2 Way Closed Type
Impedance: 8 Ω
Maximum input power: 110 W
Output sound pressure level: 76 dB/W/m
Frequency response: 60 Hz–50 kHz
Crossover frequency: 3 kHz
Cabinet capacity: 0.07 cubic feet (2 L)
Dimensions (W × H × D): 5-1/2" × 14" × 3-11/16"
(140 × 355 × 93 mm)
Weight: 2.9 lbs. (1.3 kg)
Drivers unit: 3-1/8" (8 cm) Cone Woofer × 1
1 inch (2.5 cm) Balanced Dome Tweeter × 1
Spring Type Color Coded
Terminal: 2
Keyhole slots: 2
Grille: Fixed
Other: Magnetic shielding

■ Speaker Stand (AS-140)

Dimensions (W × H × D): 10-5/8" × 35-3/16" × 10-5/8"
(270 × 894 × 270 mm)
Assembly height (with supplied speaker SKF-750XF): 41-5/16" (1050 mm)
Weight: 6.0 lbs. (2.7 kg)

Specifications and appearance are subject to change without prior notice.

ONKYO CORPORATION

Sales & Product Planning Div. : 2-1, Nisshin-cho, Neyagawa-shi, OSAKA 572-8540, JAPAN
Tel: 072-831-8023 Fax: 072-831-8124

ONKYO U.S.A. CORPORATION

18 Park Way, Upper Saddle River, N.J. 07458, U.S.A.
Tel: 201-785-2600 Fax: 201-785-2650 <http://www.us.onkyo.com/>

ONKYO EUROPE ELECTRONICS GmbH

Liegnitzerstrasse 6, 82194 Groebenzell, GERMANY
Tel: +49-8142-4401-0 Fax: +49-8142-4401-555 <http://www.eu.onkyo.com/>

ONKYO EUROPE UK Office

Suite 1, Gregories Court, Gregories Road, Beaconsfield, Buckinghamshire, HP9 1HQ
UNITED KINGDOM Tel: +44-(0)1494-681515 Fax: +44(0)-1494-680452

ONKYO CHINA LIMITED

Unit 1&12, 9/F, Ever Gain Plaza Tower 1, 88, Container Port Road, Kwai Chung,
N.T., HONG KONG Tel: 852-2429-3118 Fax: 852-2428-9039
<http://www.ch.onkyo.com/>



10806-1



Free Manuals Download Website

<http://myh66.com>

<http://usermanuals.us>

<http://www.somanuals.com>

<http://www.4manuals.cc>

<http://www.manual-lib.com>

<http://www.404manual.com>

<http://www.luxmanual.com>

<http://aubethermostatmanual.com>

Golf course search by state

<http://golfingnear.com>

Email search by domain

<http://emailbydomain.com>

Auto manuals search

<http://auto.somanuals.com>

TV manuals search

<http://tv.somanuals.com>