

ONKYO®

Integrated Amplifier

A-9755/A-9555

Instruction Manual

Thank you for purchasing an Onkyo Integrated Amplifier. Please read this manual thoroughly before making connections and plugging in the unit.

Following the instructions in this manual will enable you to obtain optimum performance and listening enjoyment from your new Integrated Amplifier.

Please retain this manual for future reference.

Contents

Introduction 2

Connections 10

Enjoying Audio Sources..... 14

Troubleshooting 18

Specifications Back cover page



WARNING:

TO REDUCE THE RISK OF FIRE OR ELECTRIC SHOCK, DO NOT EXPOSE THIS APPARATUS TO RAIN OR MOISTURE.

CAUTION:

TO REDUCE THE RISK OF ELECTRIC SHOCK, DO NOT REMOVE COVER (OR BACK). NO USER-SERVICEABLE PARTS INSIDE. REFER SERVICING TO QUALIFIED SERVICE PERSONNEL.



WARNING
RISK OF ELECTRIC SHOCK
DO NOT OPEN

AVIS
RISQUE DE CHOC ELECTRIQUE
NE PAS OUVRIR



The lightning flash with arrowhead symbol, within an equilateral triangle, is intended to alert the user to the presence of uninsulated “dangerous voltage” within the product’s enclosure that may be of sufficient magnitude to constitute a risk of electric shock to persons.



The exclamation point within an equilateral triangle is intended to alert the user to the presence of important operating and maintenance (servicing) instructions in the literature accompanying the appliance.

Important Safety Instructions

1. Read these instructions.
2. Keep these instructions.
3. Heed all warnings.
4. Follow all instructions.
5. Do not use this apparatus near water.
6. Clean only with dry cloth.
7. Do not block any ventilation openings. Install in accordance with the manufacturer’s instructions.
8. Do not install near any heat sources such as radiators, heat registers, stoves, or other apparatus (including amplifiers) that produce heat.
9. Do not defeat the safety purpose of the polarized or grounding-type plug. A polarized plug has two blades with one wider than the other. A grounding type plug has two blades and a third grounding prong. The wide blade or the third prong are provided for your safety. If the provided plug does not fit into your outlet, consult an electrician for replacement of the obsolete outlet.
10. Protect the power cord from being walked on or pinched particularly at plugs, convenience receptacles, and the point where they exit from the apparatus.
11. Only use attachments/accessories specified by the manufacturer.
12. Use only with the cart, stand, tripod, bracket, or table specified by the manufacturer, or sold with the apparatus. When a cart is used, use caution when moving the cart/apparatus combination to avoid injury from tip-over.  PORTABLE CART WARNING
S3125A
13. Unplug this apparatus during lightning storms or when unused for long periods of time.
14. Refer all servicing to qualified service personnel. Servicing is required when the apparatus has been damaged in any way, such as power-supply cord or plug is damaged, liquid has been spilled or objects have fallen into the apparatus, the apparatus has been exposed to rain or moisture, does not operate normally, or has been dropped.
15. Damage Requiring Service
Unplug the apparatus from the wall outlet and refer servicing to qualified service personnel under the following conditions:
 - A. When the power-supply cord or plug is damaged,
 - B. If liquid has been spilled, or objects have fallen into the apparatus,
 - C. If the apparatus has been exposed to rain or water,
 - D. If the apparatus does not operate normally by following the operating instructions. Adjust only those controls that are covered by the operating instructions as an improper adjustment of other controls may result in damage and will often require extensive work by a qualified technician to restore the apparatus to its normal operation,
 - E. If the apparatus has been dropped or damaged in any way, and
 - F. When the apparatus exhibits a distinct change in performance this indicates a need for service.
16. Object and Liquid Entry
Never push objects of any kind into the apparatus through openings as they may touch dangerous voltage points or short-out parts that could result in a fire or electric shock.
The apparatus shall not be exposed to dripping or splashing and no objects filled with liquids, such as vases shall be placed on the apparatus.
Don’t put candles or other burning objects on top of this unit.
17. Batteries
Always consider the environmental issues and follow local regulations when disposing of batteries.
18. If you install the apparatus in a built-in installation, such as a bookcase or rack, ensure that there is adequate ventilation.
Leave 20 cm (8") of free space at the top and sides and 10 cm (4") at the rear. The rear edge of the shelf or board above the apparatus shall be set 10 cm (4") away from the rear panel or wall, creating a flue-like gap for warm air to escape.

Precautions

- 1. Recording Copyright**—Unless it's for personal use only, recording copyrighted material is illegal without the permission of the copyright holder.
- 2. AC Fuse**—The AC fuse inside the unit is not user-serviceable. If you cannot turn on the unit, contact your Onkyo dealer.
- 3. Care**—Occasionally you should dust the unit all over with a soft cloth. For stubborn stains, use a soft cloth dampened with a weak solution of mild detergent and water. Dry the unit immediately afterwards with a clean cloth. Don't use abrasive cloths, thinners, alcohol, or other chemical solvents, because they may damage the finish or remove the panel lettering.
- 4. Power**
WARNING
BEFORE PLUGGING IN THE UNIT FOR THE FIRST TIME, READ THE FOLLOWING SECTION CAREFULLY.
AC outlet voltages vary from country to country. Make sure that the voltage in your area meets the voltage requirements printed on the unit's rear panel (e.g., AC 230 V, 50 Hz or AC 120 V, 60 Hz).
Some models have a voltage selector switch for compatibility with power systems around the world. Before you plug in such a model, make sure that the voltage selector is set to the correct voltage for your area.
- 5. Never Touch this Unit with Wet Hands**—Never handle this unit or its power cord while your hands are wet or damp. If water or any other liquid gets inside this unit, have it checked by your Onkyo dealer.
- 6. Handling Notes**
 - If you need to transport this unit, use the original packaging to pack it how it was when you originally bought it.
 - Do not leave rubber or plastic items on this unit for a long time, because they may leave marks on the case.
 - This unit's top and rear panels may get warm after prolonged use. This is normal.
 - If you do not use this unit for a long time, it may not work properly the next time you turn it on, so be sure to use it occasionally.

For British models

Replacement and mounting of an AC plug on the power supply cord of this unit should be performed only by qualified service personnel.

IMPORTANT

The wires in the mains lead are coloured in accordance with the following code:

Blue: Neutral

Brown: Live

As the colours of the wires in the mains lead of this apparatus may not correspond with the coloured markings identifying the terminals in your plug, proceed as follows:

The wire which is coloured blue must be connected to the terminal which is marked with the letter N or coloured black.

The wire which is coloured brown must be connected to the terminal which is marked with the letter L or coloured red.

IMPORTANT

The plug is fitted with an appropriate fuse. If the fuse needs to be replaced, the replacement fuse must be approved by ASTA or BSI to BS1362 and have the same ampere rating as that indicated on the plug. Check for the ASTA mark or the BSI mark on the body of the fuse.

If the power cord's plug is not suitable for your socket outlets, cut it off and fit a suitable plug. Fit a suitable fuse in the plug.

For European Models



Declaration of Conformity	
We, ONKYO EUROPE ELECTRONICS GmbH LIEGNITZERSTRASSE 6, 82194 GROEBENZELL, GERMANY	
declare in own responsibility, that the ONKYO product described in this instruction manual is in compliance with the corresponding technical standards such as EN60065, EN55013, EN55020 and EN61000-3-2, -3-3.	
GROEBENZELL, GERMANY	 K. MIYAGI
ONKYO EUROPE ELECTRONICS GmbH	

Table of Contents

Introduction

Important Safety Instructions	2
Precautions	3
Table of Contents	4
Features	4
Supplied Accessories	5
Connecting the Supplied Power Cord.....	5
Installing the Remote Controller's Batteries	5
Front & Rear Panels	6
Front Panel	6
Rear Panel	7
Remote Controller	8
Using the Remote Controller	9

Connections

Connecting the A-9755/A-9555	10
Connecting Your Speakers	10
Before Making any Connections	11
Audio Components	11
Connecting a Turntable	11
Connecting a CD Player.....	11
Connecting a Tuner.....	12
Connecting a Cassette Deck.....	12
Connecting an MD Recorder.....	12
Connecting a Remote Interactive Dock (RI Dock)	12
Connecting a TV or Other Component with an Audio Output	12
Connecting a Preamp (A-9755 only)	13
Connecting RI Components	13

Enjoying Audio Sources

Turning On the A-9755/A-9555.....	14
Selecting Speaker.....	14
Listening to Components	15
Muting the A-9755/A-9555 (remote controller only)	15
Using Headphones.....	15
Using the Tone Controls	16
Setting the PURE DIRECT Function....	16
Adjusting the Bass	16
Adjusting the Treble	16
Loudness Control.....	16
Using the MAIN IN Function (A-9755 only)	17
Recording	17

Others

Troubleshooting	18
Specifications	20

Features

A-9755 Integrated Digital Amplifier

- ❑ 150 W/Ch into 8 ohms, DIN/300 W/Ch into 4 ohms, JEITA
- ❑ Exclusive Onkyo VL Digital Technology
- ❑ Pure Stream Power Supply (2 Transformers)
- ❑ All Discrete Output Stage Circuitry
- ❑ Low-Impedance, Thick Bus Plate
- ❑ Optimum Gain Volume Circuitry
- ❑ Audiophile-Grade Capacitor
- ❑ Precision Motor Volume Control
- ❑ Tone Control (Bass, Treble, Loudness On/Off)
- ❑ Pure Direct Mode
- ❑ Discrete Phono Equalizer
- ❑ 7 Gold-Plated Audio Inputs and 2 Outputs
- ❑ Main In Terminal
- ❑ Blue Illuminated Volume Control
- ❑ Hi-Rigidity, Anti-Resonant Chassis and Brass Stabilizers
- ❑ Gold-Plated, Banana Plug-Compatible Transparent Speaker Terminals
- ❑ Heavy-Duty Power Cord
- ❑ Compatible with RI Dock for the iPod
- ❑ **RI (Remote Interactive) Remote Control**

A-9555 Integrated Digital Amplifier

- ❑ 100 W/Ch into 8 ohms, DIN/200 W/Ch into 4 ohms, JEITA
- ❑ Exclusive Onkyo VL Digital Technology
- ❑ Pure Stream Power Supply
- ❑ Discrete Output Stage Circuitry
- ❑ Low-Impedance, Thick Bus Plate
- ❑ Optimum Gain Volume Circuitry
- ❑ Precision Motor Volume Control
- ❑ Tone Control (Bass, Treble, Loudness On/Off)
- ❑ Pure Direct Mode
- ❑ Discrete Phono Equalizer
- ❑ 7 Audio Inputs and 2 Outputs
- ❑ Hi-Rigidity, Anti-Resonant Chassis
- ❑ Aluminum Volume and Selector Knob
- ❑ Banana Plug-Compatible Speaker Terminals
- ❑ Compatible with RI Dock for the iPod
- ❑ **RI (Remote Interactive) Remote Control**

Supplied Accessories

Make sure you have the following accessories:

Remote controller & two batteries (AA/R6)

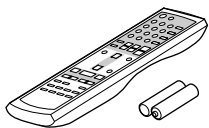

A-9755: RC-636S
A-9555: RC-627S

Power cord

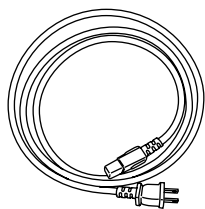

(Power cord varies from country to country)

In catalogs and on packaging, the letter added to the end of the product name indicates the color of the A-9755/A-9555. Specifications and operation are the same regardless of color.

Connecting the Supplied Power Cord

Plug the supplied power cord into this AC INLET.

- Do not use a power cord other than the one supplied with the A-9755/A-9555. The power cord supplied is designed for use with the A-9755/A-9555 and should not be used with any other device.
- Never have the power cord disconnected from the A-9755/A-9555 while the other end is plugged into the wall outlet. Doing so may cause an electric shock. Always connect by plugging into the wall outlet last and disconnect by unplugging from the wall outlet first.

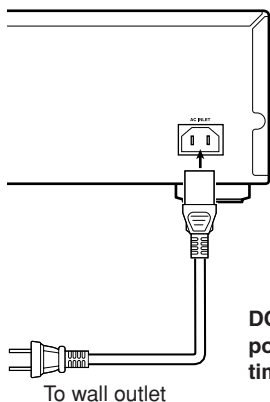

DO NOT connect the power cord at this time.

To wall outlet

Installing the Remote Controller's Batteries

- 1** To open the battery compartment, press the small hollow and slide open the cover.

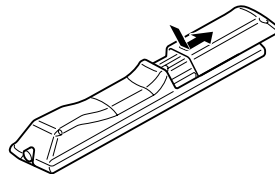

- 2** Insert the two supplied batteries (AA/R6) in accordance with the polarity diagram inside the battery compartment.

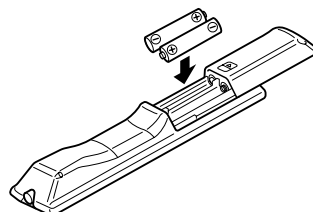

- 3** Slide the cover shut.

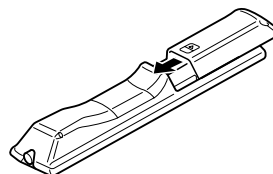

Notes:

- If the remote controller doesn't work reliably, try replacing the batteries.
- Don't mix new and old batteries or different types of batteries.
- If you intend not to use the remote controller for a long time, remove the batteries to prevent damage from leakage or corrosion.
- Flat batteries should be removed as soon as possible to prevent damage from leakage or corrosion.

Front & Rear Panels

Front Panel

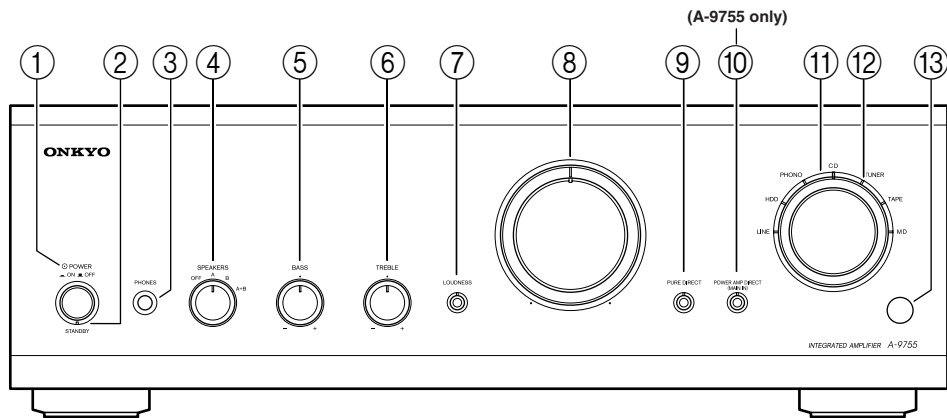

This illustration is for A-9755.

For detailed information, refer to the pages in parentheses.

① **POWER switch (14)**

This is the main power switch. When set to OFF, the A-9755/A-9555 is completely shutdown. When set to ON, the A-9755/A-9555 can be set to On or Standby.

② **STANDBY indicator (14)**

This indicator lights up when the A-9755/A-9555 is in Standby mode (Only the remote controller can be used to set the A-9755/A-9555 to Standby).

③ **PHONES jack (15)**

This phone jack is for connecting a standard pair of stereo headphones for private listening.

④ **SPEAKERS selector (14)**

This control is used to select which speaker set outputs sound. You can switch the output speaker set between four options: OFF, A, B and A+B.

⑤ **BASS control (16)**

This control is for adjusting the level of bass sounds.

⑥ **TREBLE control (16)**

This control is for adjusting the level of treble sounds.

⑦ **LOUDNESS button and indicator (16)**

This button is for reinforcing both treble and bass when the volume is turned down low. Pressing the button turns the LOUDNESS function on and off. The indicator lights up when the LOUDNESS function is on.

⑧ **Volume control and indicator (15)**

This control is used to adjust the volume of the A-9755/A-9555.

The indicator flashes while the sound is muted. It flashes more quickly if any of the speakers is left unconnected.

⑨ **PURE DIRECT button and indicator (16)**

This button turns the PURE DIRECT function on and off. The indicator lights up when the PURE DIRECT function is on.

⑩ **POWER AMP DIRECT (MAIN IN) button and indicator (17) (A-9755 only)**

When the A-9755 is used as a power amplifier with a separate preamp, this button is used to set the MAIN IN function. The indicator lights up while the MAIN IN function is on.

⑪ **Input selector (15)**

This control is used to select from the following input sources: LINE, HDD, PHONO, CD, TUNER, TAPE, or MD.

⑫ **Input selector indicator (15)**

These indicators show the currently selected input source.

⑬ **Remote control sensor (9)**

This sensor receives control signals from the remote controller.

Rear Panel

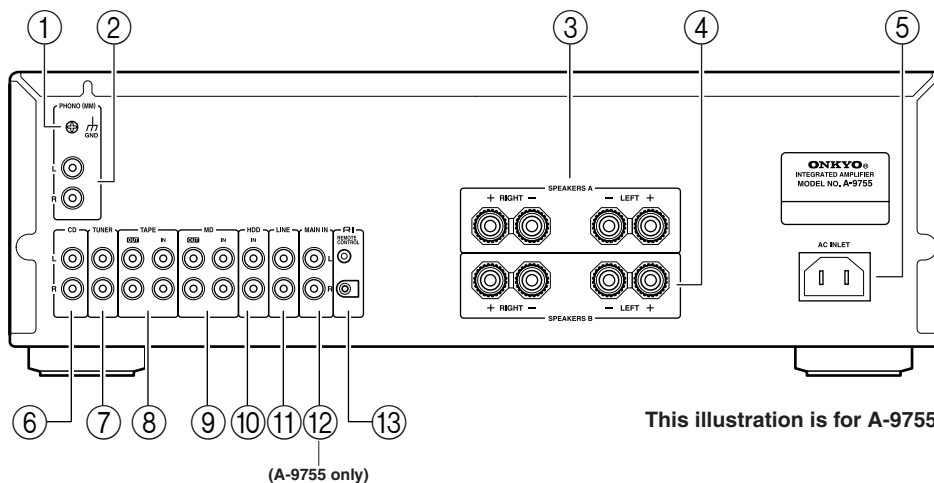

This illustration is for A-9755.

- ① **Grounding terminal**
This terminal is for connecting a turntable's ground wire.
- ② **PHONO (MM) input**
This analog audio input is for connecting a turntable with a moving-magnet cartridge.
- ③ **SPEAKERS A**
These terminal posts are for connecting speaker set A.
- ④ **SPEAKERS B**
These terminal posts are for connecting speaker set B.
- ⑤ **AC INLET**
This connector is for connecting the supplied power cord (see page 5).
- ⑥ **CD input**
This analog audio input is for connecting a CD player's analog audio output.
- ⑦ **TUNER input**
This analog audio input is for connecting a tuner's analog audio output.
- ⑧ **TAPE IN/OUT**
This analog audio input and output are for connecting a cassette deck with an analog audio input and output.
- ⑨ **MD IN/OUT**
This analog audio input and output are for connecting an MD recorder with an analog audio input and output.
- ⑩ **HDD IN**
This analog audio input is for connecting a component's analog audio output (RI Dock, etc.).

- ⑪ **LINE input**
This analog audio input is for connecting a component's analog audio output (TV, etc.).
- ⑫ **MAIN IN (A-9755 only)**
This analog audio input is for connecting a separate preamp when you want to use the A-9755 as a power amplifier.

Caution:

Do not connect a component that does not have an output volume control, such as a CD player, because the sound will be output at maximum volume and may damage the A-9755 and your speakers.

- ⑬ **RI REMOTE CONTROL jacks**
These **RI** (Remote Interactive) jacks can be connected to the **RI** jacks on your other Onkyo audio components. The A-9755/A-9555's remote controller can then be used to control all of your components. To use **RI**, you must make an analog audio connection between the A-9755/A-9555 and each component.

See pages 10–13 for connection information.

Remote Controller

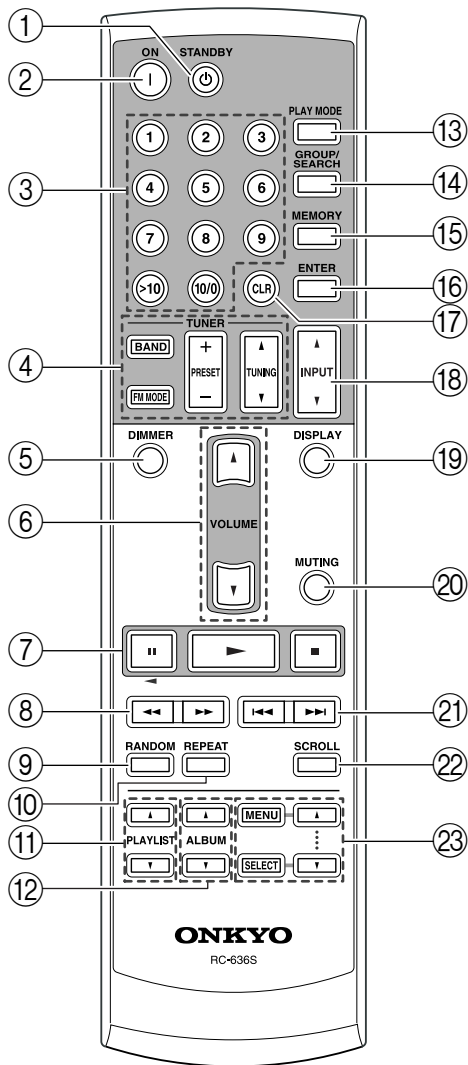

Note that the buttons with parenthesized numbers control the A-9755/A-9555, while the buttons without parenthesized numbers control other Onkyo products connected to the A-9755/A-9555 via **RI** connection. Note also that some of the **RI** connected products may not be controlled with these buttons. For detailed information, refer to the relevant manuals provided for the individual products.

① STANDBY button (14)

This button is used to set the A-9755/A-9555 to Standby.

② ON button (14)

This button is used to turn on the A-9755/A-9555.

③ Number buttons

These buttons are used to enter track numbers on a CD or MD component. To enter a single-digit number, simply press the corresponding button. The [10/0] button is used to enter either 10 or 0. The [>10] button is used when entering 2-digit numbers above 10.

See the instruction manual supplied with each component for more information.

④ TUNER buttons

BAND button: Selects the band (ex. AM or FM) for the tuner.

FM MODE button: Selects the FM listening mode (stereo or mono) for the tuner.

PRESET +/- button: Selects radio presets.

TUNING [▲]/[▼] button: Determine the listening frequency for the tuner.

⑤ DIMMER button

The button is used to adjust the display brightness on a CD component.

⑥ VOLUME [▲]/[▼] buttons (15)

These buttons adjust the volume of the A-9755/A-9555.

⑦ Pause [||], Play [▶], Stop [■] buttons

Pause [||] button: Pauses playback on a CD, MD, or HDD component; starts reverse playback on a cassette deck.

Play [▶]: Starts playback on a CD, MD, HDD or cassette component.

Stop [■]: Stops playback on a CD, MD, HDD or cassette component.

Note:

If you have connected any Onkyo double cassette deck, you can control deck B.

⑧ Reverse and Fast Forward [◀◀]/[▶▶] buttons

These buttons are used for reverse and fast forward on a CD, MD, or HDD component.

⑨ RANDOM button

This button is used to set the random playback function on a CD, MD, or HDD component. On a cassette deck, the button is used to switch the DOLBY mode.

- ⑩ **REPEAT button**
This button is used to set the repeat playback functions on a CD, MD, or HDD component. On a cassette deck, the button is used to switch the repeat playback mode (single side only/both sides).
- ⑪ **PLAYLIST [▲]/[▼] buttons**
Selects a playlist stored on the player on an HDD component.
- ⑫ **ALBUM [▲]/[▼] buttons**
Selects an album stored on the player on an HDD component.
- ⑬ **PLAY MODE button**
This button sets the playback mode on an MD component.
- ⑭ **GROUP/SEARCH button**
This button selects groups on an MD component. On a CD player, it is used to search and select a track number.
- ⑮ **MEMORY button**
This button is used to set the memory playback function on a CD or MD component. With memory playback, you can make a custom program.
- ⑯ **ENTER button**
This button is used to confirm the settings on a CD or MD component.
- ⑰ **CLR button**
This button is used to remove the last track from the memory function program, etc., on a CD or MD component.
- ⑱ **INPUT [▲]/[▼] buttons (15)**
These buttons are used to select from the following input sources: LINE, HDD, PHONO, CD, TUNER, TAPE or MD.
- ⑲ **DISPLAY button**
This button is used to change the information displayed on a CD or MD component. When the input source is "HDD," this button turns on the display backlight on the HDD component.
- ⑳ **MUTING button (15)**
This button is used to mute the A-9755/A-9555.
- ㉑ **Previous and Next [◀◀]/[▶▶] buttons**
These buttons are used to select the previous or next track on a CD, MD, or HDD component. Pressing them repeatedly selects earlier or later tracks. On a cassette deck, they're used for rewind and fast forward.
- ㉒ **SCROLL button**
This button is used to scroll text displayed on an MD component. When the input source is "HDD," this button turns on the display backlight on the HDD component.
- ㉓ **MENU, SELECT, [▲]/[▼] buttons**
MENU button: Displays the HDD component menu.

SELECT button: Confirms the option on the HDD component menu.

[▲]/[▼] buttons: Selects the option on the HDD component menu.

Using the Remote Controller

Point the remote controller toward the remote control sensor.

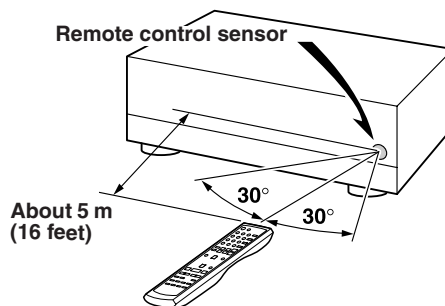

Notes:

- The remote controller may not work reliably if the A-9755/A-9555 is subjected to bright light, such as direct sunlight or inverter-type fluorescent lights. Keep this in mind when installing.
- If another remote controller of the same type is used in the same room, or the A-9755/A-9555 is installed close to equipment that uses infrared rays, the remote controller may not work reliably.
- Don't put anything, such as a book, on the remote controller, because the buttons may be pressed inadvertently, thereby draining the batteries.
- The remote controller may not work reliably if the A-9755/A-9555 is installed in a rack behind colored glass doors. Keep this in mind when installing.
- The remote controller will not work if there's an obstacle between it and the A-9755/A-9555's remote control sensor.

Connecting the A-9755/A-9555

Connecting Your Speakers

Speaker Connection Precautions

You can connect one or two sets of speakers (A/B) to the A-9755/A-9555, and select which set outputs sound, or use both sets at the same time.

For both speakers A and B, make sure to connect them with Left and Right in pairs. If you connect either Left or Right channel alone, no sound output will be available. If the electrical contact is poor for the connection, the Volume indicator will flash quickly when the power is supplied.

- **Connecting one set of speakers (A or B):** Only connect speakers with an impedance of 4 ohms or more but less than 16 ohms. If you use speakers with a lower impedance, and use the A-9755/A-9555 at high volume levels for a long period of time, the built-in protection circuit may be activated.
- **Connecting two sets of speakers (A and B):** Only connect speakers with an impedance of 8 ohms or more but less than 16 ohms. If you use speakers with a lower impedance, and use the A-9755/A-9555 at high volume levels for a long period of time, the built-in protection circuit may be activated.
- Disconnect the power cord from the wall outlet before making any connections.
- Read the instructions supplied with your speakers.
- Pay close attention to speaker wiring polarity. In other words, connect positive (+) terminals only to positive (+) terminals, and negative (-) terminals only to negative (-) terminals. If you get them the wrong way around, the sound will be out of phase and will sound unnatural.
- Unnecessarily long or very thin speaker cables may affect the sound quality and should be avoided.
- Be careful not to short the positive and negative wires. Doing so may damage the A-9755/A-9555.
- Don't connect more than one cable to each speaker terminal. Doing so may damage the A-9755/A-9555.
- Don't connect a speaker to more than one pair of speaker terminals.

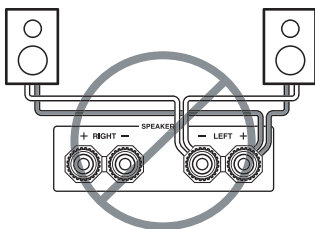
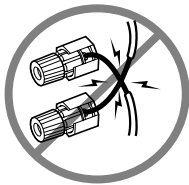

Connecting the Speaker Cables

- 1 Strip about 15 mm (5/8 inch) of insulation from the ends of the speaker cables, and twist the bare wires tightly, as shown.**

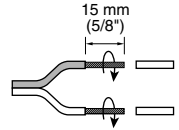

- 2 Unscrew the terminal.**



- 3 Fully insert the bare wires.**

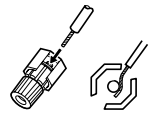

- 4 Screw the terminal tight.**



The following illustration shows which speaker should be connected to each pair of terminals.

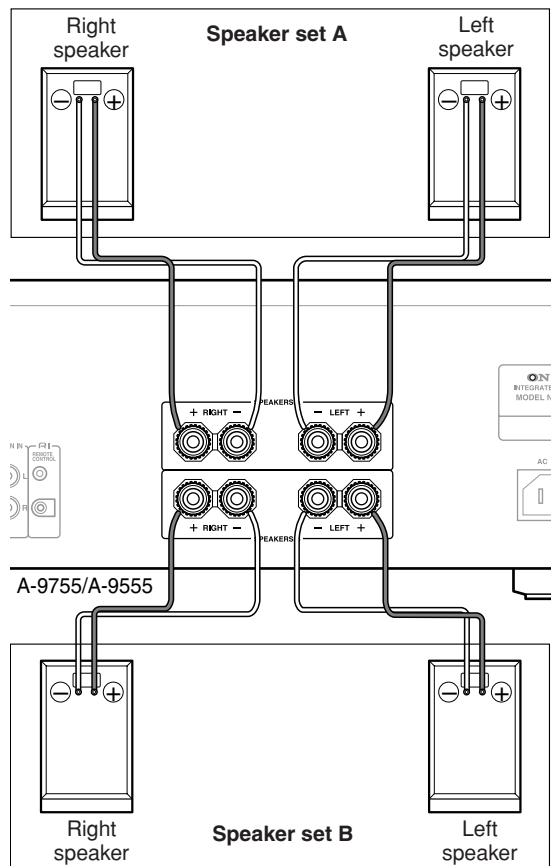

Before Making any Connections

- Always refer to the instructions that came with the component that you are connecting.
- Do not plug in the power cord until all connections have been properly made.
- Do not bind audio cables with power cords and speaker cables. Doing so may adversely affect the sound quality.
- To prevent interference, keep power cords and speaker cables away from the tuner's antenna.

RCA Audio Connection Color Coding

- Red connectors are used for the right channel, and white connectors are used for the left channel.

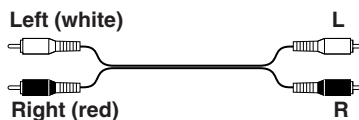

- Push each plug in all the way to make a good connection (loose connections can cause noise or malfunctions).

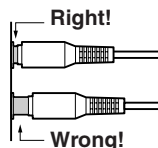

Audio Components

Connecting a Turntable

The A-9755/A-9555's PHONO input jacks are for use with moving-magnet (MM) type cartridges. Use an analog audio cable to connect the A-9755/A-9555's PHONO L/R jacks to the audio output jacks on the turntable, as shown.

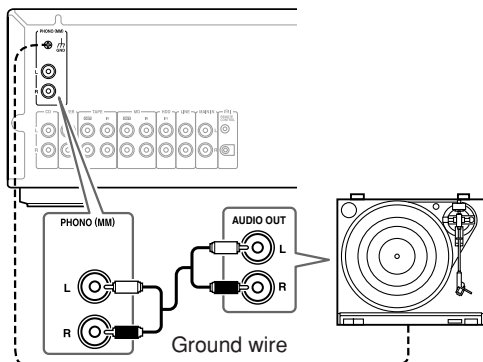

Notes:

- If the turntable has a ground wire, connect it to A-9755/A-9555's GND terminal. With some turntables, connecting the ground wire may cause hum, in which case it should be disconnected.
- If the turntable has a moving-coil (MC) type cartridge, you'll need a commercially available MC phono preamp. In this case, connect the turntable to the phono preamp's input, and connect the phono preamp's output to the A-9755/A-9555's PHONO L/R jacks.

Connecting a CD Player

Use an analog audio cable to connect the A-9755/A-9555's CD L/R jacks to the analog audio output jacks on the CD player, as shown.

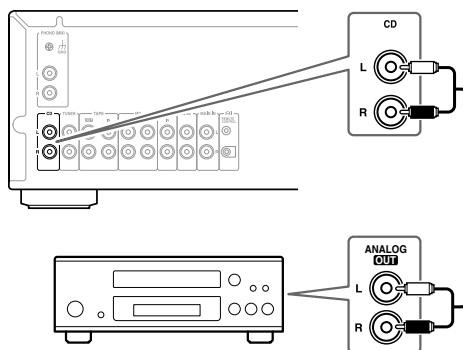

Connecting a Tuner

Use an analog audio cable to connect the A-9755/A-9555's TUNER L/R jacks to the analog audio output jacks on the tuner, as shown.

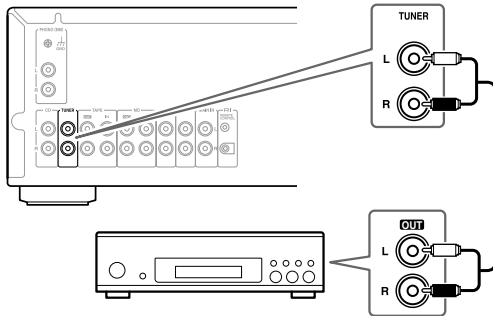

Connecting a Cassette Deck

Use an analog audio cable to connect the A-9755/A-9555's TAPE IN L/R jacks to the cassette deck's analog audio output jacks, and use another analog audio cable to connect the A-9755/A-9555's TAPE OUT L/R jacks to the cassette deck's analog audio input jacks, as shown.

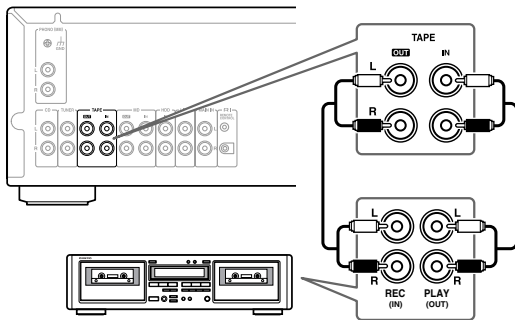

Connecting an MD Recorder

Use an analog audio cable to connect the A-9755/A-9555's MD IN L/R jacks to the MD recorder's analog audio output jacks, and use another analog audio cable to connect the A-9755/A-9555's MD OUT L/R jacks to the MD recorder's analog audio input jacks, as shown.

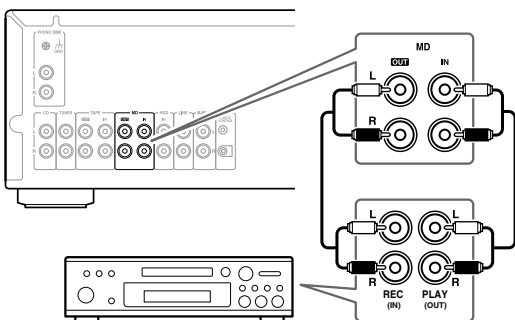

Connecting a Remote Interactive Dock (RI Dock)

Use an analog audio cable to connect the A-9755/A-9555's HDD IN L/R jacks to the RI Dock's analog audio output jacks, and use an RI cable to connect the A-9755/A-9555's RI jack to the RI Dock's RI jack, as shown.

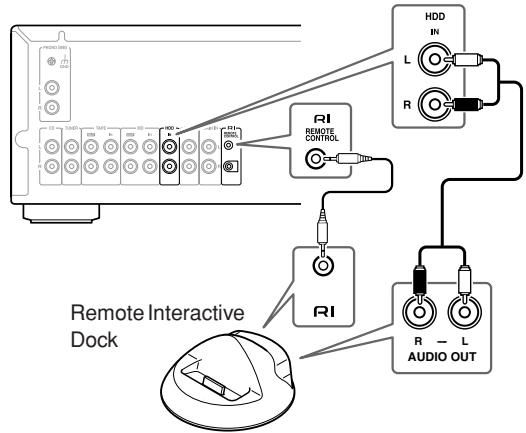

Note:

If you use the Onkyo Remote Interactive Dock (DS-A1), flip the RI MODE switch to "HDD" which is located on the underside.

Connecting a TV or Other Component with an Audio Output

Use an analog audio cable to connect the A-9755/A-9555's LINE L/R jacks to the analog audio output jacks on the TV or other component, as shown.

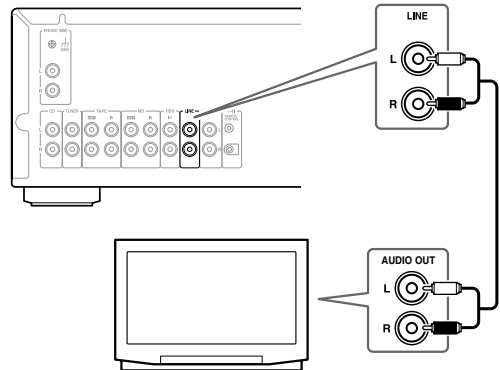

Note:

If your TV has no audio output, you can connect the A-9755/A-9555 to an audio output on your VCR and use its tuner.

Connecting a Preamp (A-9755 only)

The A-9755 can be used as a power amplifier with a separate preamp.

In this case, use an analog audio cable to connect the A-9755's MAIN IN jacks to the preamp's output jacks. Connect the speakers to the A-9755, and connect the playback components to the preamp.

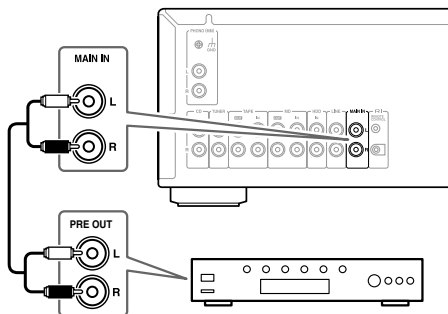

Notes:

- Do not connect a component that does not have an output volume control, because the sound will be output at maximum volume and may damage the A-9755 and your speakers.
- To turn on the MAIN IN function, press the [POWER AMP DIRECT (MAIN IN)] button for 3 seconds until the indicator lights up (page 17).

Connecting RI Components

If you connect other Onkyo components to the A-9755/A-9555 with the appropriate **RI** and audio cables, you can use the following system functions. **RI** cables are special cables solely for use with Onkyo products (no **RI** cables are supplied with the A-9755/A-9555).

Auto Power On

When you turn on the power or start playback on a component that's connected to the A-9755/A-9555, the A-9755/A-9555 will turn on automatically. And when you set the A-9755/A-9555 to Standby, all connected components will go on Standby as well (the A-9755/A-9555's POWER switch must be set to ON for this to work).

Direct Change

When playback is started on an audio component connected via **RI**, the A-9755/A-9555 will automatically select that component as the input source.

Remote Control Operation

You can control all components in your system by using the A-9755/A-9555's remote controller. See page 8 for more information.

With **RI** (Remote Interactive), you can control your **RI**-compatible Onkyo CD player, Tuner, and so on with the A-9755/A-9555's remote controller.

- To use **RI**, you must make an analog audio connection between the A-9755/A-9555 and each audio component.

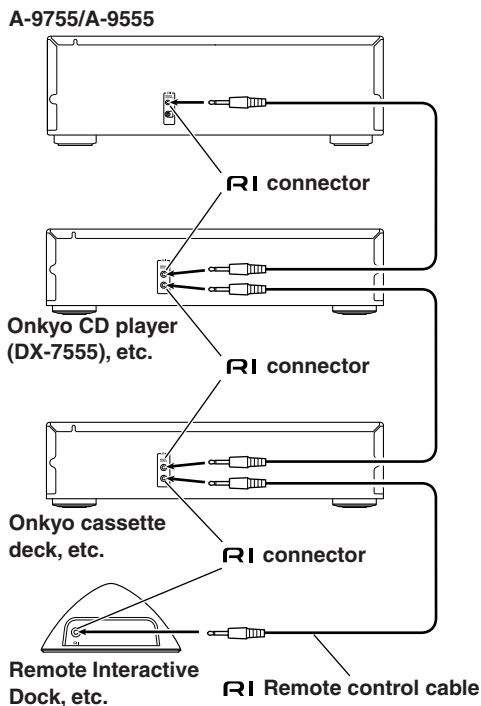

Notes:

- Push each plug in all the way to make a good connection.
- Use only dedicated **RI** cables for **RI** connections (no **RI** cables are supplied with the A-9755/A-9555).
- The A-9755/A-9555 has two **RI** jacks. They're all the same, so you can use either of them.
- **RI** jacks should be connected only to Onkyo components. Connecting them to another manufacturer's component may cause the A-9755/A-9555 to malfunction.
- Some components may not support all **RI** functions. See the manuals supplied with your other Onkyo components for more information.
- When using the A-9755 as a power amplifier (MAIN IN function), the **RI** system functions are unavailable.

Enjoying Audio Sources

Turning On the A-9755/A-9555

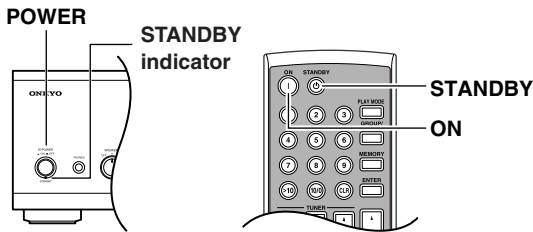

1

A-9755/
A-9555



Press the [POWER] switch.

The A-9755/A-9555 retains the power mode (on/standby) in which the amplifier was the last time you turned off the system.

Notes:

- The A-9755/A-9555 is shipped with the [POWER] switch in the OFF position (■). When the power cord is connected for the very first time or the [POWER] switch is set to ON (■) position, the A-9755/A-9555 will turn on.
- When it's turned on, the A-9755/A-9555 outputs no sound for about five seconds. This allows the circuits to stabilize.

2

Remote
controller



To set the A-9755/A-9555 to Standby, press the [STANDBY] button on the remote controller.

The STANDBY indicator lights up.

To turn the A-9755/A-9555 on, press the [ON] button on the remote controller.

The STANDBY indicator goes off.

If the A-9755/A-9555 is connected to other components via **RI**, press the remote controller's [ON] button once to turn on the A-9755/A-9555, and press it again to turn on the other components.

Turning on all system components simultaneously:

You can set the A-9755/A-9555 so that all connected **RI** components are turned on with just one press of the remote controller's [ON] button. To do this, turn on the A-9755/A-9555, and then press and hold the remote controller's [ON] button for 16 seconds until the A-9755/A-9555 switches to Standby mode. You will then be able to turn on the A-9755/A-9555 and all system components with just one press of the remote controller's [ON] button.

If you want to restore the setting to the original state, reset the A-9755/A-9555. For information about how to reset, see "How to reset" on page 19.

Note:

To shut down the A-9755/A-9555 completely, set the [POWER] switch to the OFF position (■).

Selecting Speaker

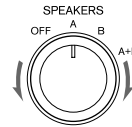

You can select which set of speakers outputs sound.

OFF: Select "OFF;" if you do not connect any speaker.

A: To output sound from the speakers connected to the SPEAKERS A terminals, turn the SPEAKERS selector to the "A" position.

B: To output sound from the speakers connected to the SPEAKERS B terminals, turn the SPEAKERS selector to the "B" position.

A+B: To output sound from all connected speakers, turn the SPEAKERS selector to the "A+B" position.

Note:

If the Volume indicator flashes quickly, make sure that the speakers are connected correctly.

Listening to Components

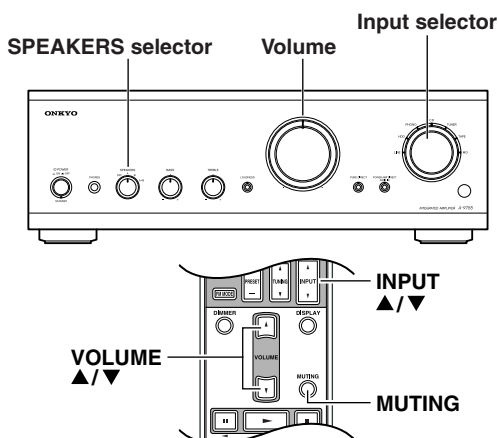

1

A-9755/
A-9555

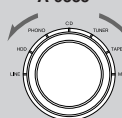

Remote
controller

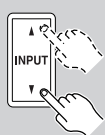

Turn the input selector to select the component that you want to listen to.

LINE: Select to listen to the component connected to the LINE jacks.

HDD: Select to listen to the component connected to the HDD jacks.

PHONO: Select to listen to the turntable connected to the PHONO jacks.

CD: Select to listen to the component connected to the CD jacks.

TUNER: Select to listen to the component connected to the TUNER jacks.

TAPE: Select to hear the component connected to the TAPE IN jacks.

MD: Select to listen to the component connected to the MD IN jacks.

When selecting with the remote controller, use the INPUT [▲]/[▼] buttons.

2

Start playback on the selected component.

3

A-9755/
A-9555

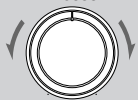

Remote
controller



VOLUME



To adjust the volume, use the A-9755/A-9555's Volume control, or the remote controller's VOLUME [▲]/[▼] buttons.

Turn Volume control clockwise to increase the volume or counterclockwise to decrease the volume.

Note:

When using the A-9755 as a power amplifier (MAIN IN function), the Volume control has no effect.

Muting the A-9755/A-9555 (remote controller only)

You can temporarily mute the output of the A-9755/A-9555.

1 MUTING



Press the remote controller's [MUTING] button.

The A-9755/A-9555 is muted. The Volume indicator flashes.



To unmute the A-9755/A-9555, press the [MUTING] button again.

Notes:

- The Mute function will be cancelled if the remote controller's VOLUME buttons are pressed or the A-9755/A-9555 is set to Standby.
- When using the A-9755 as a power amplifier (MAIN IN function), the Muting function is disabled.

Using Headphones

You can connect a pair of stereo headphones (1/4-inch phone plug) to the A-9755/A-9555's PHONES jack for private listening.

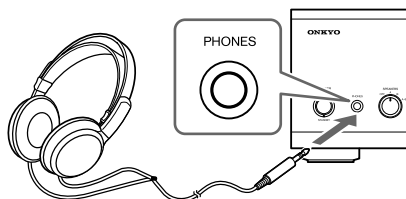

Notes:

- Always turn down the volume before connecting your headphones.
- All connected speakers are turned off while the headphones plug is inserted in the PHONES jack.
- The headphones output no sound while the MAIN IN function is on.

Using the Tone Controls

While the MAIN IN function is on, the A-9755's tone controls have no effect.

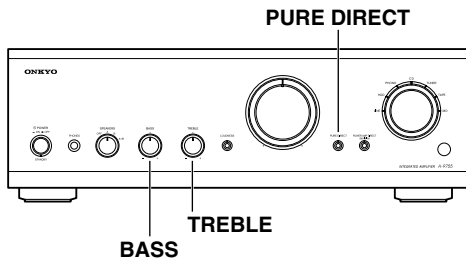

Setting the PURE DIRECT Function

The [PURE DIRECT] button turns the PURE DIRECT function on and off.

When the PURE DIRECT function is off, the tone controls can be used to adjust the sound, and the PURE DIRECT indicator goes off.

When the PURE DIRECT function is on, the tone controls are bypassed, so you can enjoy a pure sound. The PURE DIRECT indicator lights up.



Adjusting the Bass

The BASS control adjusts bass sounds. Turn it up to make them louder. Turn it down to make them quieter. Normally, it should be set midway.

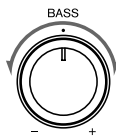

Adjusting the Treble

The TREBLE control adjusts treble sounds. Turn it up to make them louder. Turn it down to make them quieter. Normally, it should be set midway.

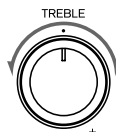

Loudness Control

By pressing the [LOUDNESS] button, both treble and bass are reinforced when the volume is turned down low.

Use this button according to the music source and according to the listening area. Its purpose is to enrich the natural sound effects of both the treble and bass.

The indicator lights up when the LOUDNESS function is on.

- When using the A-9755 as a power amplifier (MAIN IN function), the Loudness control doesn't work.
- When the PURE DIRECT function is on, the Loudness control is disabled.



Using the MAIN IN Function (A-9755 only)

You can use the A-9755 as power amplifier with a separate preamp. See page 13 for connection information.

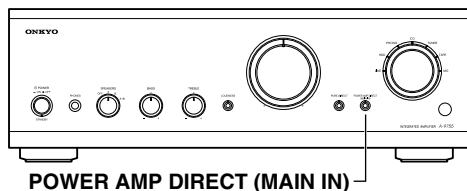

1

POWER AMP DIRECT (MAIN IN)



Press the [POWER AMP DIRECT (MAIN IN)] button for 3 seconds until the MAIN IN indicator lights up.

The MAIN IN function comes on and the MAIN IN indicator lights up.

While the MAIN IN function is on, only audio from components connected to the preamp can be output.

To turn the MAIN IN function off, press the [POWER AMP DIRECT (MAIN IN)] button for 3 seconds until the MAIN IN indicator goes off.

Notes:

- Do not connect a component that does not have an output volume control to the MAIN IN jacks and use the MAIN IN function, because the sound will be output at maximum volume and may damage the A-9755 and your speakers.
- While the MAIN IN function is on, the A-9755's Volume control has no effect. Before you turn off the MAIN IN function, make sure that the Volume control is not turned up high, to prevent any loud surprises.
- While the MAIN IN function is on, the following A-9755 functions are disabled:
 - Volume control
 - Input selector
 - Remote control operation
 - **RI** function
 - LOUDNESS control
 - Recording
 - Muting

Operate the connected preamp for some of these functions including controlling volume, selecting input, and muting. The [STANDBY] and [ON] buttons on the remote controller will work even when the MAIN IN function is on.

Recording

Unless you have the full consent of the copyright holder, copyright laws prohibit using your recordings for anything other than personal enjoyment!

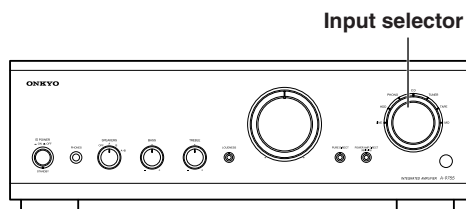

1

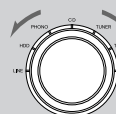

Use the input selector to select the component that you want to record from.

2

Prepare the recorder:

- Set the recorder so that it's ready for recording.
- If necessary, adjust the recording level on the recorder.
- See the recorder's manual for more information.

3

Start playback on the component selected in step 1.

Note:

If you select another input source during recording, the newly selected input source will be recorded.

Notes:

- You can record on a recorder that's connected to the MD OUT or TAPE OUT L/R jacks.
- The tone controls have no effect on the signal being recorded.
- When using the A-9755 as a power amplifier (MAIN IN function), recording is not possible.

Troubleshooting

If you have any trouble using the A-9755/A-9555, look for a solution here. If you can't resolve the issue yourself, contact your Onkyo dealer.

Power

Can't turn on the A-9755/A-9555.

- Make sure that the power cord is properly plugged into the wall outlet. (page 5)
- Unplug the power cord from the wall outlet, wait ten seconds or more, then plug it in again.
- By default, pressing the remote controller's [ON] button once does not turn on all of the system components. You need to press the remote controller's [ON] button again. Alternatively, you can set the A-9755/A-9555 so that all components do turn on simultaneously (page 14).

The STANDBY indicator is flashing.

- The amp protection circuit has been activated. Remove the power cord from the wall outlet immediately and contact your Onkyo dealer.

Audio

There's no sound or it's very quiet.

- When the A-9755 is used as a power amplifier (MAIN IN indicator lights up), the sound from components connected to the preamp is output. To output the sound from a component that's connected to the A-9755, or to use the A-9755 as a preamp, press the [POWER AMP DIRECT (MAIN IN)] button for 3 seconds until the MAIN IN indicator goes off. (page 17)
- Make sure that all audio plugs are pushed in all the way (page 11).
- Make sure that the inputs and outputs of all components are connected properly.
- Make sure that the polarity of the speaker cables is correct and that the bare wires are in contact with the metal part of each speaker terminal (page 10).
- Make sure that the correct input source is selected (page 15).
- If the Volume indicator flashes slowly, press the remote controller's [MUTING] button to unmute the A-9755/A-9555 (page 15).
- Make sure that none of the cables are bent, twisted, or damaged.
- To use a turntable with a moving-coil (MC) type cartridge, you need a commercially available MC phono preamp (page 11).
- If the Volume indicator flashes quickly, any speakers may not be connected to the A-9755/A-9555. Make sure that the required connection is performed appropriately, and set the [POWER] switch to the ON position again (pages 10, 14).
- Verify if the SPEAKERS selector is configured correctly. If "OFF" is selected, no sound will be output from any of the speakers (page 14).

Noise can be heard.

- Using cable ties to bundle audio cables with power cords, speaker cables, and so on may degrade the audio performance, so don't bundle them together.
- An audio cable may be picking up interference. Try repositioning your cables.

The tone controls have no effect.

- If the PURE DIRECT indicator lights up, the PURE DIRECT function is on and the tone controls have no effect. Press the [PURE DIRECT] button to turn the function off. The PURE DIRECT indicator will go off (page 16).

Remote Controller

The remote controller doesn't work.

- Make sure that the batteries are installed with the correct polarity (page 5).
- Install new batteries. Don't mix different types of batteries or old and new batteries (page 5).
- Make sure that the remote controller is not too far away from the A-9755/A-9555 and that there's no obstruction between the remote controller and the A-9755/A-9555's remote control sensor (page 9).
- Make sure that the A-9755/A-9555 is not subjected to direct sunshine or inverter-type fluorescent lights. Relocate if necessary (page 9).
- If the A-9755/A-9555 is installed in a rack or cabinet with colored glass doors, the remote controller may not work reliably when the doors are closed (page 9).

Can't control other components?

- If it's an Onkyo component, make sure that the **RI** cable and analog audio cable are connected properly. Connecting only an **RI** cable won't work. (page 13)

Recording

Can't record.

- The component connected to the MAIN IN jacks cannot be recorded.
- When using the A-9755 as a power amplifier (MAIN IN function), recording is not possible.

Others

The Volume control has no effect.

- When using the A-9755 as a power amplifier (MAIN IN function), the Volume control has no effect. Adjust the volume on the connected preamp instead.

The Muting function doesn't work.

- When using the A-9755 as a power amplifier (MAIN IN function), the Muting function does not work. Use the muting function on the connected preamp instead.

The A-9755/A-9555 contains a microcomputer for signal processing and control functions. In very rare situations, severe interference, noise from an external source, or static electricity may cause it to lock up. In the unlikely event that this happens, unplug the power cord from the wall outlet, wait at least ten seconds, and then plug it back in again.

Onkyo is not responsible for damages (such as CD rental fees) due to unsuccessful recordings caused by the unit's malfunction. Before you record important data, make sure that the material will be recorded correctly.

How to reset:

To reset the A-9755/A-9555 to its factory defaults, while holding down the [PURE DIRECT] button, press the [LOUDNESS] button, and then release both buttons. The input selector indicators light up for one second, and then the A-9755/A-9555 enters On mode.

A-9755/A-9555 BLOCK DIAGRAM

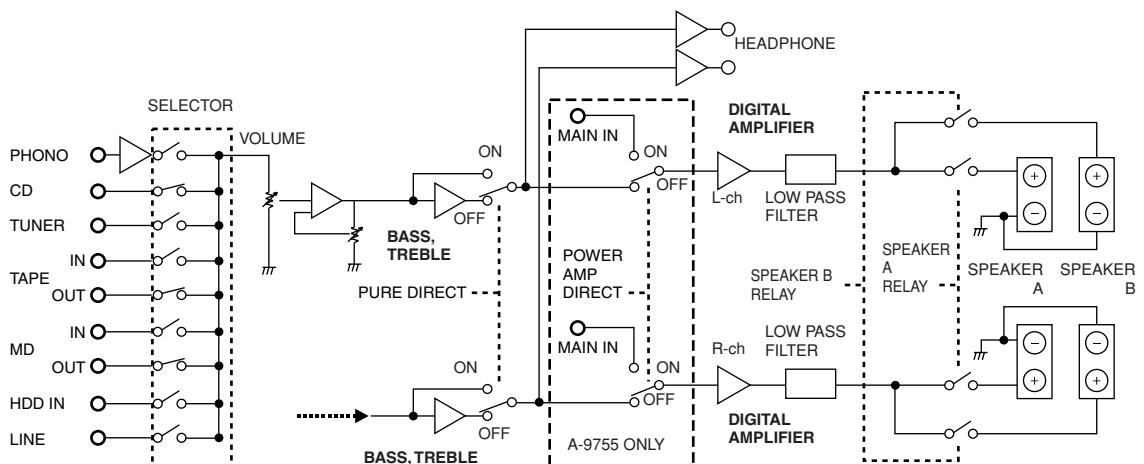

Specifications

	<u>A-9755</u>	<u>A-9555</u>
Power output:	150 W + 150 W (8 Ω, 1 kHz, DIN) 300 W + 300 W (4 Ω, 1 kHz, JEITA)	100 W + 100 W (8 Ω, 1 kHz, DIN) 200 W + 200 W (4 Ω, 1 kHz, JEITA)
Dynamic power:	330 W + 330 W (3 Ω, Front) 270 W + 270 W (4 Ω, Front) 170 W + 170 W (8 Ω, Front)	230 W + 230 W (3 Ω, Front) 200 W + 200 W (4 Ω, Front) 120 W + 120 W (8 Ω, Front)
THD (total harmonic distortion):	0.08 % (1 kHz, 1 W)	0.08 % (1 kHz, 1 W)
Damping factor:	25 (Front, 1 kHz, 8 Ω)	25 (Front, 1 kHz, 8 Ω)
Input sensitivity and impedance:	200 mV, 50 kΩ (CD) 2.5 mV, 50 kΩ (PHONO MM)	200 mV, 50 kΩ (CD) 2.5 mV, 50 kΩ (PHONO MM)
Output level and impedance:	200 mV, 2.2 kΩ (REC OUT)	200 mV, 2.2 kΩ (REC OUT)
Phono overload:	70 mV (MM, 1 kHz, 0.5 %)	70 mV (MM, 1 kHz, 0.5 %)
Frequency response:	10 Hz–60 kHz, +1 dB–3 dB (CD)	10 Hz–60 kHz, +1 dB–3 dB (CD)
Tone control:	+10 dB, –10 dB, 100 Hz (BASS) +10 dB, –10 dB, 20 kHz (TREBLE) +10 dB, 50 Hz (LOUDNESS) +2 dB, 10 kHz (LOUDNESS)	+10 dB, –10 dB, 100 Hz (BASS) +10 dB, –10 dB, 20 kHz (TREBLE) +10 dB, 50 Hz (LOUDNESS) +2 dB, 10 kHz (LOUDNESS)
SN ratio:	100 dB (CD, IHF-A) 70 dB (PHONO, IHF-A)	100 dB (CD, IHF-A) 70 dB (PHONO, IHF-A)
Speaker impedance:	4–16 Ω	4–16 Ω
Power supply:	AC 230-240 V, 50 Hz AC 220-230 V, 50/60 Hz	AC 230-240 V, 50 Hz AC 220-230 V, 50/60 Hz AC 120 V, 60 Hz
Power consumption:	125 W	120 W
Stand-by power consumption:	0.3 W	0.3 W
Dimensions (W × H × D):	435 × 144 × 431 mm	435 × 148 × 431 mm
Weight:	17.6 kg	13.0 kg
Analog inputs:	PHONO, CD, TUNER, TAPE, MD, HDD, LINE, MAIN IN	PHONO, CD, TUNER, TAPE, MD, HDD, LINE,
Analog outputs:	MD, TAPE	MD, TAPE
Speaker outputs:	2 (A, B)	2 (A, B)
Phones:	1	1

Specifications and features are subject to change without notice.

ONKYO CORPORATION

Sales & Product Planning Div. : 2-1, Nisshin-cho, Neyagawa-shi, OSAKA 572-8540, JAPAN
Tel: 072-831-8023 Fax: 072-831-8124

ONKYO U.S.A. CORPORATION

18 Park Way, Upper Saddle River, N.J. 07458, U.S.A.
Tel: 201-785-2600 Fax: 201-785-2650 <http://www.us.onkyo.com/>

ONKYO EUROPE ELECTRONICS GmbH

Liegnitzerstrasse 6, 82194 Groebenzell, GERMANY
Tel: +49-8142-4401-0 Fax: +49-8142-4401-555 <http://www.eu.onkyo.com/>

ONKYO EUROPE UK Office

Suite 1, Gregories Court, Gregories Road, Beaconsfield, Buckinghamshire, HP9 1HQ
UNITED KINGDOM Tel: +44-(0)1494-681515 Fax: +44(0)-1494-680452

ONKYO CHINA LIMITED

Units 2102-2107, Metroplaza Tower I, 223 Hing Fong Road, Kwai Chung,
N.T., HONG KONG Tel: 852-2429-3118 Fax: 852-2428-9039
<http://www.ch.onkyo.com/>



Printed in Japan
D0510-1

SN 29344108

(C) Copyright 2005 ONKYO CORPORATION Japan. All rights reserved.

Download from www.Somanuals.com. All Manuals Search And Download.



* 2 9 3 4 4 1 0 8 *

Free Manuals Download Website

<http://myh66.com>

<http://usermanuals.us>

<http://www.somanuals.com>

<http://www.4manuals.cc>

<http://www.manual-lib.com>

<http://www.404manual.com>

<http://www.luxmanual.com>

<http://aubethermostatmanual.com>

Golf course search by state

<http://golfingnear.com>

Email search by domain

<http://emailbydomain.com>

Auto manuals search

<http://auto.somanuals.com>

TV manuals search

<http://tv.somanuals.com>