

FM STEREO/AM TUNER AMPLIFIER R-805X

Before using

Connections

Preparations

Operation

Other Information

Instruction Manual

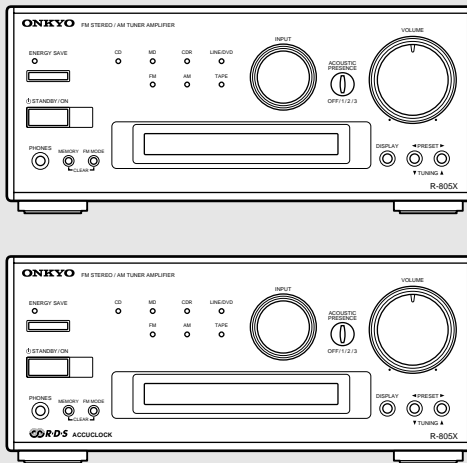

Thank you for purchasing the ONKYO R-805X FM Stereo/AM Tuner Amplifier. Please read this manual thoroughly before making any connection or turning on the power.

Follow these instructions to obtain optimum performance and maximum listening enjoyment from your new R-805X. Please retain this manual for future reference.

WARNING:

TO REDUCE THE RISK OF FIRE OR ELECTRIC SHOCK, DO NOT EXPOSE THIS APPLIANCE TO RAIN OR MOISTURE.

CAUTION:

TO REDUCE THE RISK OF ELECTRIC SHOCK, DO NOT REMOVE COVER (OR BACK). NO USER-SERVICEABLE PARTS INSIDE. REFER SERVICING TO QUALIFIED SERVICE PERSONNEL.



The lightning flash with arrowhead symbol, within an equilateral triangle, is intended to alert the user to the presence of uninsulated "dangerous voltage" within the product's enclosure that may be of sufficient magnitude to constitute a risk of electric shock to persons.

The exclamation point within an equilateral triangle is intended to alert the user to the presence of important operating and maintenance (servicing) instructions in the literature accompanying the appliance.

Important Safeguards

- 1. Read Instructions** – All the safety and operating instructions should be read before the appliance is operated.
- 2. Retain Instructions** – The safety and operating instructions should be retained for future reference.
- 3. Heed Warnings** – All warnings on the appliance and in the operating instructions should be adhered to.
- 4. Follow Instructions** – All operating and use instructions should be followed.
- 5. Cleaning** – Unplug the appliance from the wall outlet before cleaning. The appliance should be cleaned only as recommended by the manufacturer.
- 6. Attachments** – Do not use attachments not recommended by the appliance manufacturer as they may cause hazards.
- 7. Water and Moisture** – Do not use the appliance near water—for example, near a bath tub, wash bowl, kitchen sink, or laundry tub; in a wet basement; or near a swimming pool; and the like.
- 8. Accessories** – Do not place the appliance on an unstable cart, stand, tripod, bracket, or table. The appliance may fall, causing serious injury to a child or adult, and serious damage to the appliance. Use only with a cart, stand, tripod, bracket, or table recommended by the manufacturer, or sold with the appliance. Any mounting of the appliance should follow the manufacturer's instructions, and should use a mounting accessory recommended by the manufacturer.
- 9. An appliance and cart combination should be moved with care. Quick stops, excessive force, and uneven surfaces may cause the appliance and cart combination to overturn.**
- 10. Ventilation** – Slots and openings in the cabinet are provided for ventilation and to ensure reliable operation of the appliance and to protect it from overheating, and these openings must not be blocked or covered. The openings should never be blocked by placing the appliance on a bed, sofa, rug, or other similar surface. The appliance should not be placed in a built-in installation such as a bookcase or rack unless proper ventilation is provided. There should be free space of at least 20 cm (8 in.) and an opening behind the appliance.
- 11. Power Sources** – The appliance should be operated only from the type of power source indicated on the marking label. If you are not sure of the type of power supply to your home, consult your appliance dealer or local power company.
- 12. Grounding or Polarization** – The appliance may be equipped with a polarized alternating current line plug (a plug having one blade wider than the other). This plug will fit into the power outlet only one way. This is a safety feature. If you are unable to insert the plug fully into the outlet, try reversing the plug. If the plug should still fail to fit, contact your electrician to replace your obsolete outlet. Do not defeat the safety purpose of the polarized plug.
- 13. Power-Cord Protection** – Power-supply cords should be routed so that they are not likely to be walked on or pinched by items placed upon or against them, paying particular attention to cords at plugs, convenience receptacles, and the point where they exit from the appliance.

PORTABLE CART WARNING



S3125A

14. **Outdoor Antenna Grounding** – If an outside antenna or cable system is connected to the appliance, be sure the antenna or cable system is grounded so as to provide some protection against voltage surges and built-up static charges. Article 810 of the National Electrical Code, ANSI/NFPA 70, provides information with regard to proper grounding of the mast and supporting structure, grounding of the lead-in wire to an antenna-discharge unit, size of grounding conductors, location of antenna-discharge unit, connection to grounding electrodes, and requirements for the grounding electrode. See Figure 1.
15. **Lightning** – For added protection for the appliance during a lightning storm, or when it is left unattended and unused for long periods of time, unplug it from the wall outlet and disconnect the antenna or cable system. This will prevent damage to the appliance due to lightning and power-line surges.
16. **Power Lines** – An outside antenna system should not be located in the vicinity of overhead power lines or other electric light or power circuits, or where it can fall into such power lines or circuits. When installing an outside antenna system, extreme care should be taken to keep from touching such power lines or circuits as contact with them might be fatal.
17. **Overloading** – Do not overload wall outlets, extension cords, or integral convenience receptacles as this can result in a risk of fire or electric shock.
18. **Object and Liquid Entry** – Never push objects of any kind into the appliance through openings as they may touch dangerous voltage points or short-out parts that could result in a fire or electric shock. Never spill liquid of any kind on the appliance.
19. **Servicing** – Do not attempt to service the appliance yourself as opening or removing covers may expose you to dangerous voltage or other hazards. Refer all servicing to qualified service personnel.
20. **Damage Requiring Service** – Unplug the appliance from the wall outlet and refer servicing to qualified service personnel under the following conditions:
 - A. When the power-supply cord or plug is damaged,
 - B. If liquid has been spilled, or objects have fallen into the appliance,
 - C. If the appliance has been exposed to rain or water,
 - D. If the appliance does not operate normally by following the operating instructions. Adjust only those controls that are covered by the operating instructions as an improper adjustment of other controls may result in damage and will often require extensive work by a qualified technician to restore the appliance to its normal operation,
 - E. If the appliance has been dropped or damaged in any way, and
 - F. When the appliance exhibits a distinct change in performance – this indicates a need for service.
21. **Replacement Parts** – When replacement parts are required, be sure the service technician has used replacement parts specified by the manufacturer or have the same characteristics as the original part. Unauthorized substitutions may result in fire, electric shock, or other hazards.
22. **Safety Check** – Upon completion of any service or repairs to the appliance, ask the service technician to perform safety checks to determine that the appliance is in proper operation condition.
23. **Wall or Ceiling Mounting** – The appliance should be mounted to a wall or ceiling only as recommended by the manufacturer.
24. **Heat** – The appliance should be situated away from heat sources such as radiators, heat registers, stoves, or other appliances (including amplifiers) that produce heat.

FIGURE 1:
EXAMPLE OF ANTENNA GROUNDING AS PER
NATIONAL ELECTRICAL CODE, ANSI/NFPA 70

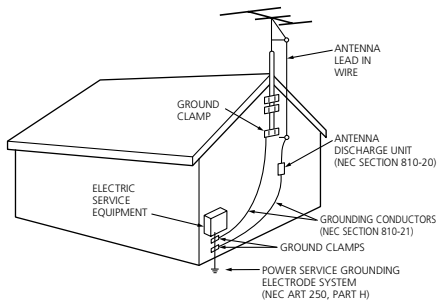

NEC – NATIONAL ELECTRICAL CODE

S2898A

Precautions

1. Warranty Claim

You can find the serial number on the rear panel of this unit. In case of warranty claim, please report this number.

2. Recording Copyright

Recording of copyrighted material for other than personal use is illegal without permission of the copyright holder.

3. AC Fuse

The fuse is located inside the chassis and is not user-serviceable. If power does not come on, contact your Onkyo authorized service station.

4. Care

From time to time you should wipe the front and rear panels and the cabinet with a soft cloth. For heavier dirt, dampen a soft cloth in a weak solution of mild detergent and water, wring it out dry, and wipe off the dirt. Following this, dry immediately with a clean cloth. Do not use rough material, thinners, alcohol or other chemical solvents or cloths since these could damage the finish or remove the panel lettering.

5. Power

WARNING

BEFORE PLUGGING IN THE UNIT FOR THE FIRST TIME, READ THE FOLLOWING SECTION CAREFULLY.

The voltage of the available power supply differs according to country or region. Be sure that the power supply voltage of the area where this unit will be used meets the required voltage (e.g., AC 230 V, 50 Hz or AC 120 V, 60 Hz) written on the rear panel.

Setting the STANDBY button to standby does not shut off the power completely. So the power cord should be removed from the AC outlet when the unit is not used for a prolonged time.

For British model

Replacement and mounting of an AC plug on the power supply cord of this unit should be performed only by qualified service personnel.

IMPORTANT

The wires in the mains lead are coloured in accordance with the following code:

Blue : Neutral

Brown : Live

As the colours of the wires in the mains lead of this apparatus may not correspond with the coloured markings identifying the terminals in your plug, proceed as follows:

The wire which is coloured blue must be connected to the terminal which is marked with the letter N or coloured black.

The wire which is coloured brown must be connected to the terminal which is marked with the letter L or coloured red.

IMPORTANT

A 5 ampere fuse is fitted in this plug. Should the fuse need to be replaced, please ensure that the replacement fuse has a rating of 5 amperes and that it is approved by ASTA or BSI to BS1362. Check for the ASTA mark or the BSI mark on the body of the fuse.

IF THE FITTED MOULDED PLUG IS UNSUITABLE FOR THE SOCKET OUTLET IN YOUR HOME THEN THE FUSE SHOULD BE REMOVED AND THE PLUG CUT OFF AND DISPOSED OF SAFELY. THERE IS A DANGER OF SEVERE ELECTRICAL SHOCK IF THE CUT OFF PLUG IS INSERTED INTO ANY 13 AMPERE SOCKET.

If in any doubt, please consult a qualified electrician.

For U.S. model

Note to CATV system installer:

This reminder is provided to call the CATV system installer's attention to Article 820-40 of the NEC, ANSI/NFPA 70, which provides guidelines for proper grounding and, in particular, specifies that the cable ground shall be connected to the grounding system of the building, as close to the point of cable entry as practical.

FCC Information for User

CAUTION:

The user changes or modifications not expressly approved by the party responsible for compliance could void the user's authority to operate the equipment.

NOTE:

This equipment has been tested and found to comply with the limits for a Class B digital device, pursuant to Part 15 of the FCC Rules. These limits are designed to provide reasonable protection against harmful interference in a residential installation. This equipment generates, uses and can radiate radio frequency energy and, if not installed and used in accordance with the instructions, may cause harmful interference to radio communications. However, there is no guarantee that interference will not occur in a particular installation. If this equipment does cause harmful interference to radio or television reception, which can be determined by turning the equipment off and on, the user is encouraged to try to correct the interference by one or more of the following measures:

- Reorient or relocate the receiving antenna.
- Increase the separation between the equipment and receiver.
- Connect the equipment into an outlet on a circuit different from that to which the receiver is connected.
- Consult the dealer or an experienced radio/TV technician for help.

For Canadian model

NOTE:

THIS CLASS B DIGITAL APPARATUS COMPLIES WITH CANADIAN ICES-003.

For models having a power cord with a polarized plug:

CAUTION: TO PREVENT ELECTRIC SHOCK, MATCH WIDE BLADE OF PLUG TO WIDE SLOT, FULLY INSERT.

Modele pour les Canadien

REMARQUE:

CET APPAREIL NUMÉRIQUE DE LA CLASSE B EST CONFORME À LA NORME NMB-003 DU CANADA.

Sur les modèles dont la fiche est polarisée:

ATTENTION: POUR ÉVITER LES CHOCS ÉLECTRIQUES, INTRODUIRE LA LAME LA PLUS LARGE DE LA FICHE DANS LA BORNE CORRESPONDANTE DE LA PRISE ET POUSSER JUSQU'AU FOND.

Memory Preservation

This unit does not require memory preservation batteries. A built-in memory power back-up system preserves the contents of the memory during power failures and even when the unit is unplugged. The unit must be plugged in order to charge the back-up system.

The memory preservation period after the unit has been unplugged varies depending on climate and placement of the unit. On the average, memory contents are protected over a period of a few weeks after the last time the unit has been unplugged. This period is shorter when the unit is exposed to a highly humid climate.

Main Features

- 20 Watts per channel into 4 ohms DIN
- Low impedance drive discrete output stage
- Accoustic Presence
- RDS (Radio Data System) PS only (European model)
- FM/AM random 30 Stations Preset Tuning
- Timer Play (Weekday,Weekend),Sleep & Timer Rec
- Automatic Scan Tuning (FM only)
- Subwoofer Pre Out (U.S. & Canadian models)
- FM TUNED Indicator
- Audio Muting (operable via remote control)
- Battery-free Backup System to Protect Memory Contents
- Motor driven Volume control
- Head phone Jack
- R I Compatible Remote Control Included
- Blushed Alminume Front Panel
- Processor In/Out (other than U.S. & Canadian models)

Supplied accessories

Check that the following accessories are supplied with this unit.

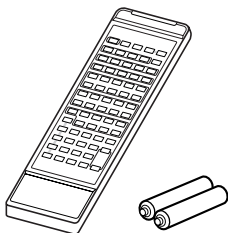

Remote controller x 1
(RC-456S)
Batteries x 2
(Size AA, R6, or UM-3)

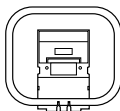

AM loop antenna x 1



FM indoor antenna x 1

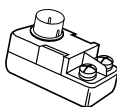

75/300 ohm antenna adapter x 1
(Available on the models
other than U.S., Canadian,
and European models)

Declaration of Conformity

We, ONKYO EUROPE
ELECTRONICS GmbH
INDUSTRIESTRASSE 20
82110 GERMERING,
GERMANY



declare in own responsibility, that the ONKYO product described in this instruction manual is in compliance with the corresponding technical standards such as EN60065, EN55013, EN55020 and EN61000-3-2, -3-3.

GERMERING, GERMANY

A. HORIUCHI

ONKYO EUROPE ELECTRONICS GmbH

Table of contents

Before using

Supplied accessories	6
----------------------------	---

Connections

Connecting to the ONKYO Separate Collection Series components	8
Connecting to components other than the Separate Collection Series	13
Connecting speaker systems.....	16
Antenna connections	17
Connecting the AC power cord (mains lead)	20

Preparations

Preparing the remote controller	21
---------------------------------------	----

Operation

Setting the Clock	22
Choosing the required source	26
Adjusting the sound.....	27
Muting/Listening with the headphones	28
Recording.....	29
Receiving stations.....	30
Naming a preset station	33
Receiving RDS (European models only)	36
Using the timer.....	37

Other Information

Troubleshooting.....	44
Specifications.....	46
Index to parts and controls.....	48

Connecting to the ONKYO Separate Collection Series components

This section introduces you to the other Separate Collection Series system components and their convenient system functions, followed by connecting instructions.

The following Separate Collection Series components are commercially available:

- K-505X Stereo Cassette Tape Deck (Not available in U.S. and Canada)
- C-705X Compact Disc (CD) Player (Not available in U.S. and Canada)
- C-707CH Compact Disc (CD) Changer (Only available in U.S. and Canada)
- MD-105X Minidisc (MD) Recorder (Not available in U.S. and Canada)
- CD-recorder Compact Disc (CD) Recorder (Not available in U.S. and Canada)

Note that the available components may vary according to the area.

Combination use of the unit with the above system components enables you to operate the following convenient functions:

- **Auto Power On**

- You can turn on the unit by pressing the STANDBY/ON switch on one of the system components.
- You can turn on all the system components at the same time by pressing the STANDBY/ON switch on the unit.
You can turn off each component not in use independently afterwards.

- **Direct Change**

Press the following button on the component you want to operate to switch the unit's input selector automatically to that component:

- The play button on the CD player (or changer), MD recorder or stereo cassette tape deck.

- **Remote Control Operation**

All the system components can be operated using the supplied remote controller.

- **Program Timer**

You can operate timer playback and recording using this unit.

- **Sleep Timer**

You can fall asleep to a music/radio program using this unit.

- **CD Dubbing**

Simple CD dubbing using a stereo cassette tape deck or MD recorder is possible with the pressing of a single button (CD dubbing function using an MD recorder is not available on the C-707CH). (Refer to the K-505X or MD-105X Instruction Manual for more information).

- **CD/MD Synchro Recording**

When using a stereo cassette tape deck or MD recorder to record from the CD player or when using a stereo cassette tape deck to record from an MD recorder, you can record with simply starting on a CD player or MD recorder. (Refer to the K-505X or MD-105X instruction manual for more information.)

- **Dubbing a specific track from CD**

You can specify a track on a CD and easily dub it to a connected MD recorder. (Refer to the MD-105X instruction manual for more information.)

Arranging the system components

Combination example 1

Select the CD player C-705X (or CD changer C-707CH), CD recorder, and stereo cassette tape deck K-505X in addition to this unit. When you arrange these components, stack them as shown below.

Vertical way stacking

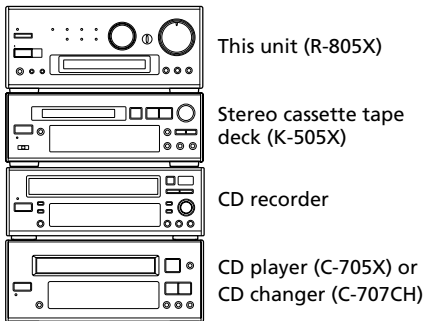

Horizontal way stacking

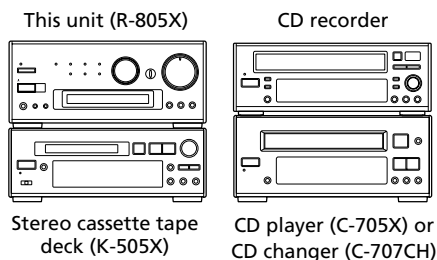

Combination example 2

Select the CD player C-705X, CD recorder and MD recorder MD-105X in addition to this unit. When you arrange these components, stack them as shown below.

Vertical way stacking

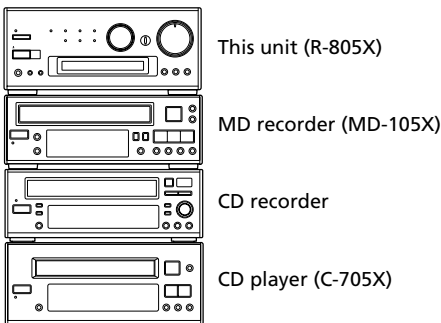

Horizontal way stacking

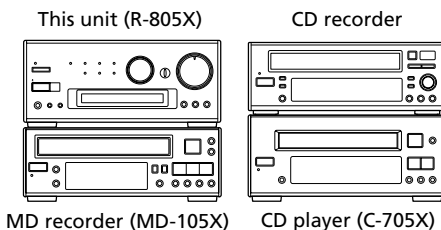

Tip

In addition to the above combination examples, you can also connect both the MD recorder MD-105X and stereo cassette tape deck K-505X with the CD recorder, CD player C-705X, and this unit.

Connecting to the ONKYO Separate Collection Series components

Connecting to the audio connector

Before connecting

- Do not connect the unit's AC power cord (mains lead) to a wall outlet (the mains) until you have completed all the other connections, including **RI** and AC OUTLET connections on page 12 and "Connecting speaker systems" on page 16.
- On each pair of connectors, a red connector (marked R) corresponds to the right channel, and a white connector (marked L) to the left channel. Connect white plugs of audio connection cables to L connectors and connect red plugs of audio connection cables to R connectors.
- Please refer to the instruction manual for each component when you make any connections.

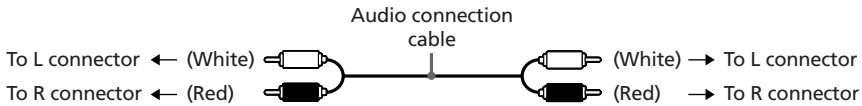

- Insert the plug securely. If the connection is incomplete, noise or malfunction may result.

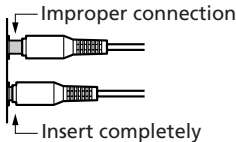

- When you use a digital audio optical cable, do not bend it sharply nor coil it tightly.
- Bundling an audio connection cable with the power cord or speaker cord may degrade the sound quality.
- Be sure to use the **RI** cable, supplied with each component (except for the R-805X) to connect to the **RI** remote control connector. If the connection is incomplete, you will be unable to operate the device using the remote controller.
- CD players and MD recorders use heat-sensitive parts. Do not place them on top of the amplifier.

Note:

To connect both the MD recorder MD-105X and stereo cassette tape deck K-505X to the unit: Connect the MD recorder to the unit following the "Connections for combination example 2" on the next page and connect the stereo cassette tape deck to the unit following the "Connections for combination example 1."

The 230 V model is shown in the following illustrations.

Connections for combination example 1

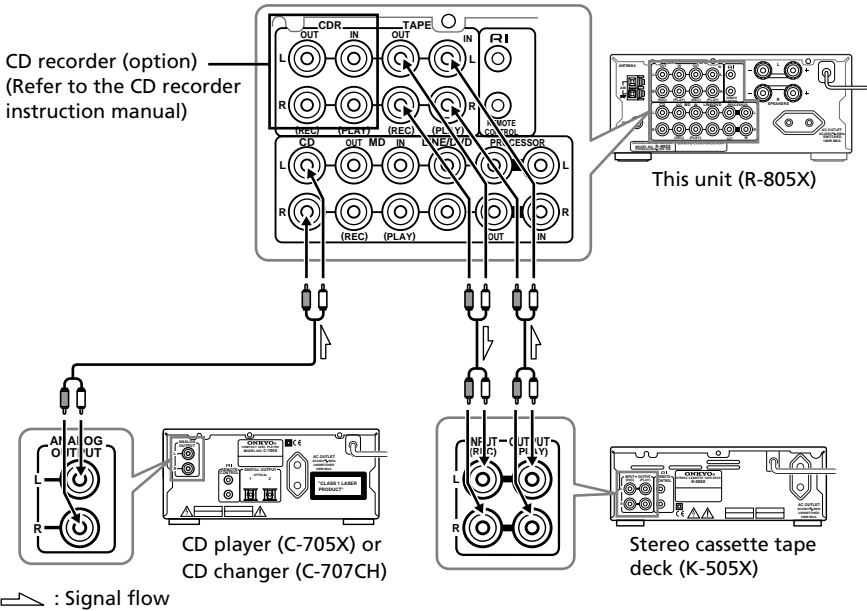

Connections for combination example 2

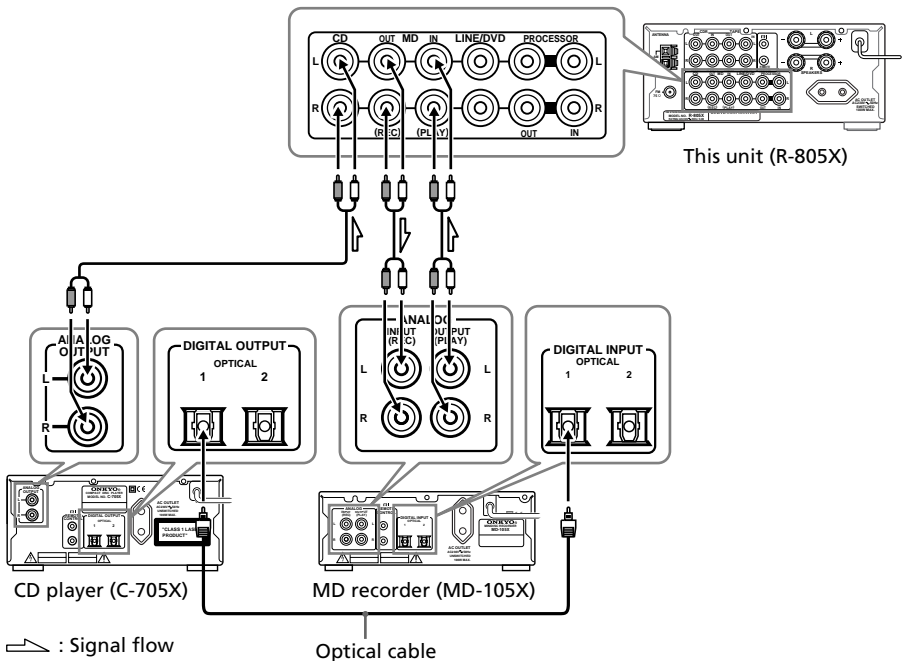

Connecting to the ONKYO Separate Collection Series components

Connecting the **RI** connectors and AC OUTLETS

Before connecting

- The hookups on page 11 is needed in addition to the **RI** (for remote control operations) and AC OUTLET (for power supply to each component) hookups on this page.
- Each component has two **RI** connectors. There is no difference between those connectors. The components may be connected in any order.
- The **RI** remote control cable for connecting the **RI** connectors is supplied with each component (not supplied with the unit).

Connections

To use the Clock/Timer function of this unit's, connect the power cord as shown below and connect the **RI** remote control cable and audio connection cables (see page 11). Be sure to connect the power cord of this unit to an AC outlet that supplies continuous power.

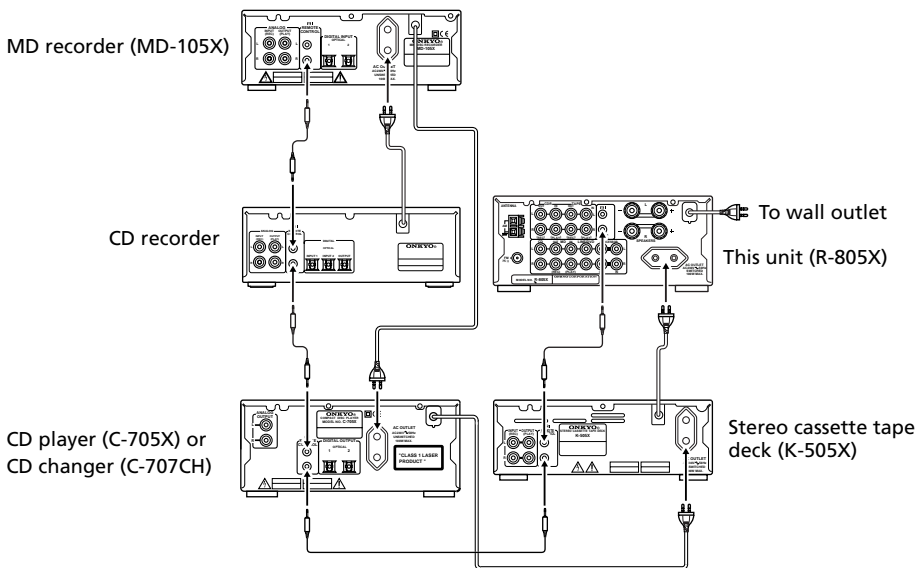

- If the R-805X is in Standby mode (only the display is lit) in the system, a small amount of power (for standby mode) is being supplied to the connected devices. If you do not wish to supply this power to the connected devices to save energy, press the ENERGY SAVE button on the R-805X. (See page 20.)

Connecting to components other than the Separate Collection Series

Connecting audio/video equipment to audio connectors

Before connecting

- Do not connect the AC power cord (mains lead) to the wall outlet (the mains) until you have completed all the other connections including the sound processor connections on the next page, the **RI** connections on page 15, and the speaker connections on page 16.
- On each pair of connectors, a red connector (marked R) corresponds to the right channel, and a white connector (marked L) to the left channel. Connect white plugs of audio connection cables to L connectors and connect red plugs of audio connection cables to R connectors.

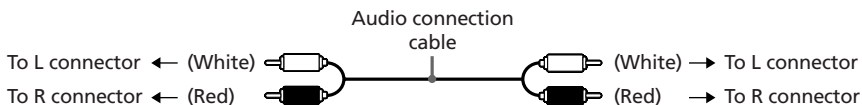

- Please refer to the instruction manual for each component when you make any connections.
- Insert the plug securely. If the connection is incomplete, noise or malfunction may result.

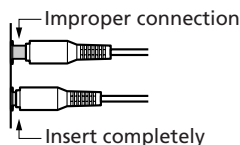

Connections

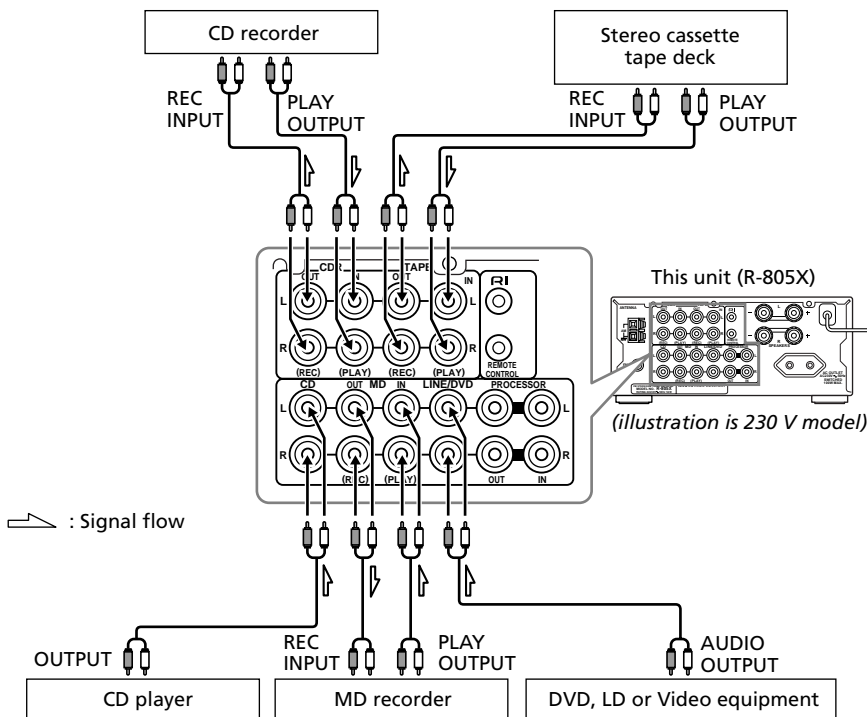

- Refer to page 14 for more information on how to connect a processing device such as a surround processor.

Connecting to components other than the Separate Collection Series

Connecting a subwoofer (U.S. & Canadian models only)

Before connecting

- If your subwoofer isn't equipped with an amplifier, connect a separate amplifier to the unit first, then connect the subwoofer to that amplifier.
- The SUBWOOFER PRE OUT connector supplies the left and right mixed monaural signals to the subwoofer.

Connections

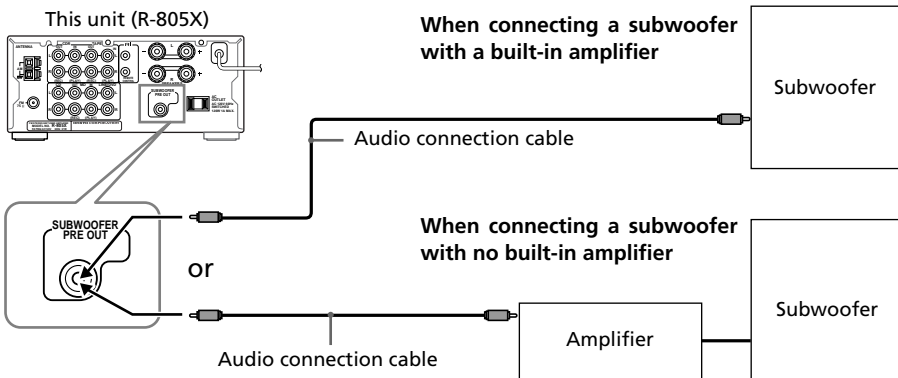

Connecting a sound processor (other than U.S. & Canadian models)

You can connect a sound processor (e.g. surround processor, graphic equalizer, etc.) to the unit.

Before connecting

- Disconnect the jumper plugs using the PROCESSOR connectors.
 - Please retain them for future use.
 - Never connect the jumper plugs to the other connectors, as this may cause the unit to malfunction, so that the sound is not reproduced.
 - If you do not use the PROCESSOR connectors, connect two jumper plugs horizontally to the IN and OUT jacks firmly.

Connections

1 Remove the jumper plugs.

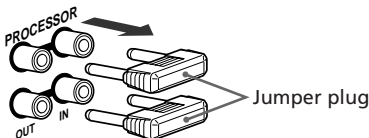

2 Connect the sound processor to the unit.

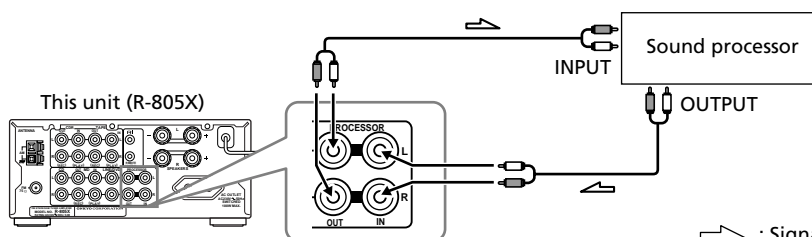

➔ : Signal flow

Connecting the **RI** remote control cables

If your other components are made by ONKYO and those components are equipped with **RI** connectors, you can control the **RI**-connected components with the supplied remote controller.

Before connecting

- The unit must be connected in the **RI** system hookups for **RI** control operations.
- Each component has two **RI** connectors. There is no difference between these connectors.
- The components may be connected in any order.
- The hookups on the previous page are necessary independently of the **RI** system hookups.

The illustration below is an example of a **RI** hookup.

Connections

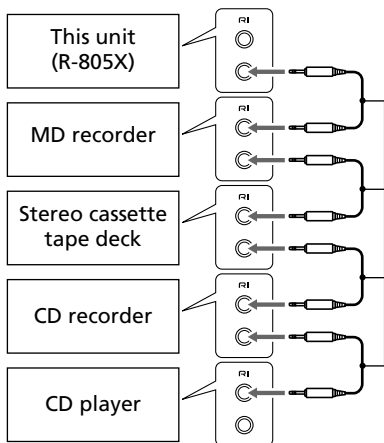

RI remote control cable (supplied with every ONKYO component that has **RI** connectors except for the amplifier and receiver)

- This is not an example of stacking the components. For the example, refer to page 9.

AC outlet connection

You can connect the power cord from another audio device to the rear of the R-805X.

If the R-805X is connected via an **RI** remote control cable to another Onkyo audio device that has a **STANDBY/ON** button, you can use the **STANDBY/ON** button on the R-805X to turn on and off the power to both R-805X and connected device, or place both devices in standby mode. When the R-805X is turned on or placed in standby mode, electric current is always supplied to the AC connector on the rear panel.

If you press the **ENERGY SAVE** button while the R-805X is in standby mode, the power to the connected audio device will be turned off one minute later. (See page 20.)

The shape and capacity of the AC outlet may differ depending on the area of purchase. Make sure that the capacity of other components connected to this unit does not exceed the capacity that is printed on the rear panel.

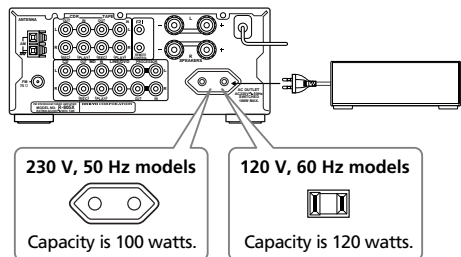

Connecting speaker systems

Connecting left and right speakers

Before connecting

- The load impedance of each speaker must be at least 4 ohms.
- Do not use unnecessarily long or extremely thin speaker cords. Otherwise, the DC resistance of the speaker cords may become too high, lowering the damping factor and causing the sound quality to deteriorate.
- Do not connect the speaker cord to the L and R connectors at the same time and do not connect two or more speakers to the same speaker connectors.

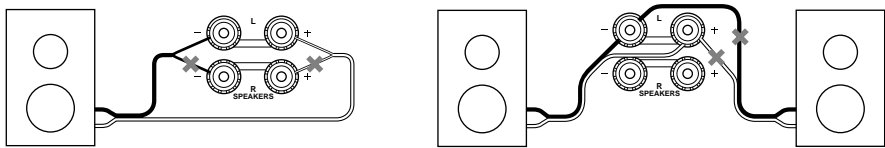

Preparing the speaker cords for connection

- ① Strip 15 mm from the end of each cord.
- ② Twist the stripped end of the cord.

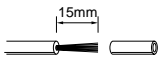

Note
To prevent damage to circuits never short-circuit the positive (+) and negative (-) speaker wires.

Connecting the speaker cords to the speaker connectors

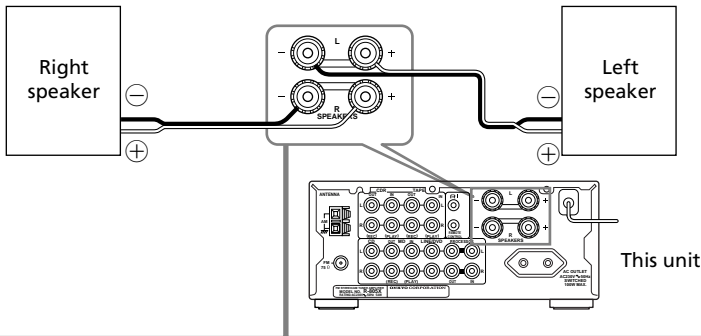

- ① Turn the knob counter-clockwise to loosen.
- ② Insert the stripped end of the cord.
- ③ Turn the knob clockwise to tighten.

Antenna connections

Connecting the AM antenna

Assembling the AM loop antenna

Assemble the loop antenna as shown in the illustration.

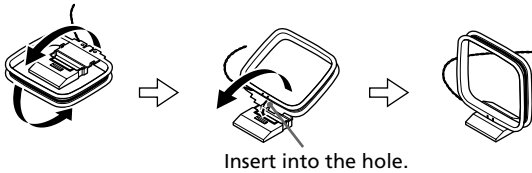

Connecting the antenna cable

1. Press down the lever.
2. Insert the wire into the hole.
3. Release the lever to replace it.

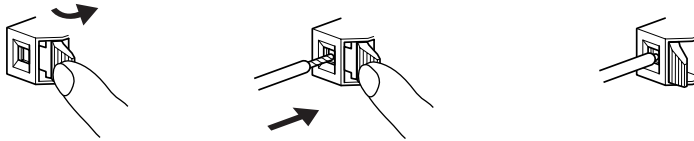

Connecting the AM loop antenna

The AM loop antenna is for indoor use only. Set it in the direction and position where you receive the clearest sound. Put it as far as possible away from this unit, TV, speaker cables, and power cords.

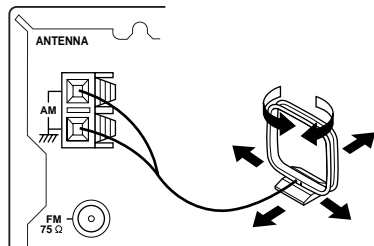

Connecting an AM outdoor antenna

When reception is not satisfactory with the supplied AM loop antenna alone, connection of an outdoor antenna is recommended. The outdoor antenna will be more effective if it is stretched horizontally above a window or outside.

- Do not remove the AM loop antenna.
- To avoid the risk of lightning and electrical shock, grounding is necessary. Follow item 14 of the "Important Safeguards" on page 3 when you install the outdoor antenna.

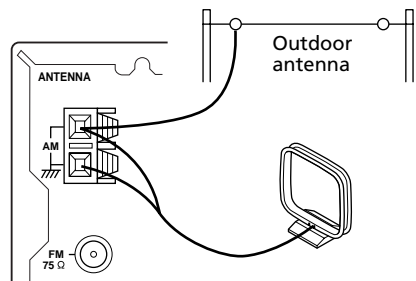

Antenna connections

Connecting the FM antenna

FM indoor antenna

The supplied FM antenna is for indoor use only. Move the antenna in various directions until the clearest signal is received. Fix it with push pins or similar implements in the position that will cause the least amount of distortion.

U.S. and Canadian models

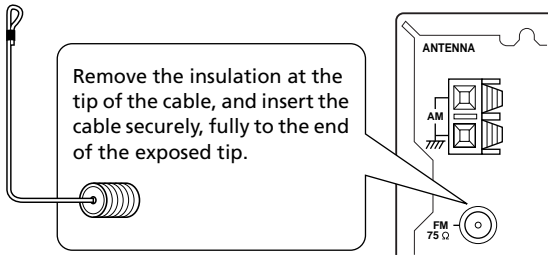

Other models

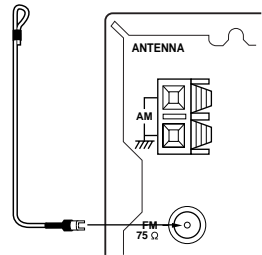

FM outdoor antenna

If the reception is not very clear with the supplied FM antenna, the use of an outdoor antenna is recommended.

Please make sure that you follow the considerations below regarding the location.

- Keep the antenna away from noise sources (neon signs, busy roads etc.).
- It is dangerous to put the antenna close to power lines. Keep it well away from power lines, etc.
- To avoid the risk of lightning and electrical shock, grounding is necessary. Follow item 14 of the "Important Safeguards" on page 3 when you install the outdoor antenna.

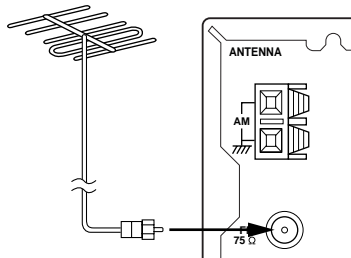

Connecting the antenna cable to the 75/300 ohm antenna adapter (Non-U.S., Canadian and European models)

Connecting the 300 ohm ribbon wire:

Loosen the screws and wrap the wire around these screws. Then tighten the screws with a screwdriver.

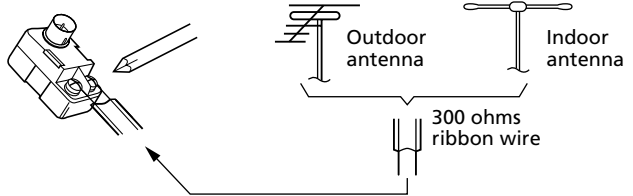

Connecting the coaxial cable:

1. With your fingernail or a small screwdriver, press the stoppers outward and remove the cover.

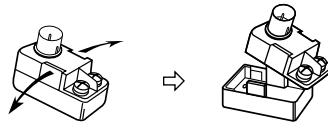

2. Remove the transformer wire A from slit B and insert it into slit C.

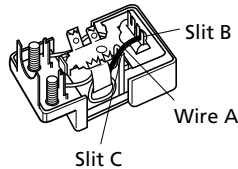

3. Prepare the coaxial cable as shown in the diagram.

Connect the 75/300 ohm antenna adapter to the coaxial cable.

- ① Insert the end of the cable.
- ② Clamp it in place with pliers.

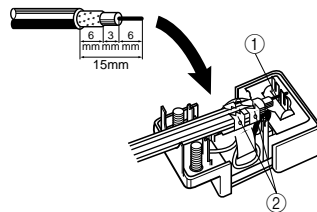

4. Re-install the cover.

Directional linkage

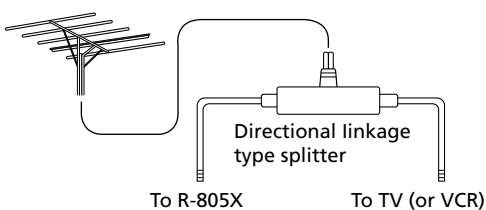

Do not use the same antenna for both FM and TV (or VCR) reception since the FM and TV (or VCR) signals can interfere with each other. If you must use a common FM/TV (or VCR) antenna, use a directional linkage type splitter.

Connecting the AC power cord (mains lead)

ENERGY SAVE indicator

ENERGY SAVE

STANDBY/ON

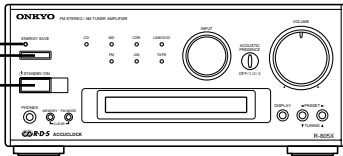

STANDBY/
ON

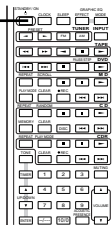

1 Connect the AC power cord (mains lead) to the wall outlet (the mains).

"-:-:-" appears on the display.

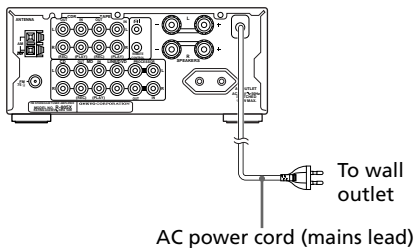

(illustration is 230 V models)

2 Press the STANDBY/ON button.

The indicator of the selected input source lights up.

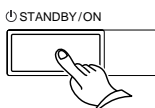

Notes

- If the AC power cord (mains lead) is connected to the AC outlet of another component, that component's AC power cord (mains lead) must be connected to the wall outlet (the mains) to supply power to the unit. If the component has a power switch, it must be set to On.
- If you do not use the unit for a long time, remove the power cord of the R-805X from the AC outlet.
- The unit may cause a power surge on your home circuit when you turn it on. If this interferes with any other devices connected to the same circuit, plug this unit into another outlet on a separate circuit.

About the ENERGY SAVE button:

The power to all devices connected to the R-805X will be turned off one minute after you press the ENERGY SAVE button while the unit is in Standby mode.

When you press the ENERGY SAVE button:

- The ENERGY SAVE indicator starts flashing. After one minute, it lights up steadily.
- The display scrolls words "ENERGY SAVE," then turns off. However, the timer on the R-805X is still functioning.

When the power to other components is turned off, the Direct Play function is disabled. To turn on the power to the components again, press the STANDBY/ON button on the R-805X. (With a slight delay, the power to the components connected to the R-805X will be turned on.)

Energy Save mode is cancelled when you press the ENERGY SAVE button while the ENERGY SAVE indicator is flashing.

Preparing the remote controller

Installing the remote controller batteries

- 1 Remove the battery compartment cover by pressing and sliding it away from the remote controller unit.

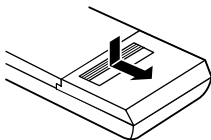

- 2 Insert two AA-size batteries into the battery compartment.

Carefully follow the polarity diagram (positive ⊕ and negative ⊖ symbols) inside the battery compartment.

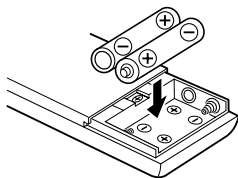

- 3 After batteries are installed and seated correctly, replace the compartment cover.

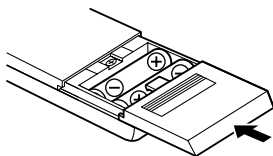

Notes

- Do not mix new batteries with old batteries or different kinds of batteries.
- To avoid corrosion, remove the batteries if the remote controller is not to be used for a long time.
- Remove dead batteries immediately to avoid damage from corrosion. If the remote controller doesn't operate smoothly, replace both the batteries at the same time.
- The life of the batteries supplied is about six months but this will vary depending on usage.

Using the remote controller

Point the remote controller toward the remote control sensor.

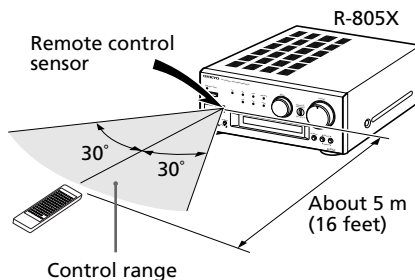

Notes

- Place the unit away from strong light such as direct sunlight or inverted fluorescent light which can prevent proper operation of the remote controller.
- Using another remote controller of the same type in the same room or using the unit near equipment which uses infrared rays may cause operational interference.
- Do not put any object such as a book on the remote controller. The buttons of the remote controller may be pressed by mistake and drain the batteries.
- Make sure the audio rack doors do not have colored glass. Placing the unit behind such doors may prevent proper remote controller operation.
- If there is any obstacle between the remote controller and the remote control sensor, the remote controller will not operate.

Setting the Clock

The "ACCUCLOCK" features an automatic clock adjusting function automatically sets the clock time by means of RDS broadcast signals.

- The "ACCUCLOCK" feature is available only on the European model, and only in areas where RDS broadcasts are available.
- Adjust the clock as explained in "Setting the clock manually" on page 24 if you are using U.S. or Canadian models or if you are using the unit in the area where RDS broadcasts are unavailable.

Setting the clock automatically (European models only)

ACCUCLOCK starts operating as soon as the power cord is plugged in. It then searches for an RDS broadcasting station which regularly sends time signals and waits to receive such time information. Do not operate any buttons until the clock setting is complete. The R-805X retains the clock setting until you unplug the power cord.

The following steps describe how to set the clock automatically:

1. Plug in the power cord.

"AUTO" flashes slowly on the display.



- ### 2. Once an RDS station that sends time signals is detected, the indicator flashes more rapidly.



- ### 3. Once the time signal is received from the RDS station, "CLOCK ADJUSTED" will scroll on the display.

- ### 4. The received time information (the day of the week and the time) appears.

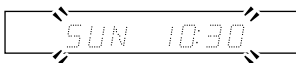

- ### 5. The clock starts running.

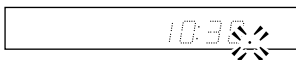

- It may take about 5 minutes for the time information to be received and displayed after you plug in the power cord.
- ### 6. After the clock is initially set, it will be adjusted periodically when the R-805X is in Standby mode (all input source indicators are turned off) or in ENERGY SAVE mode (the ENERGY SAVE indicator is lit).

Notes on using the "ACCUCLOCK" function:

- Make sure that your FM antenna has been properly connected as explained on page 18. It is strongly recommended that you install an outdoor FM antenna since the FM indoor antenna may not receive RDS broadcasts well enough to allow ACCUCLOCK to function properly.
- The clock will display the time in a 24 hour cycle. For example, 5:30 pm will be displayed as "17:30". (You can select a 12 hour cycle display setting. For more information, see page 25.)
- If RDS signals cannot be received, no RDS station will be found.

Or if an RDS signal is present but the signal is not strong enough to allow the ACCUCLOCK to automatically set the time, "- -:--" will lit on the display as shown below. If this occurs, set the clock manually. (See page 24.)

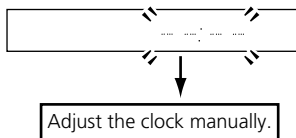

- You may wish to adjust the clock manually because the time information may differ depending on the RDS station detected. If so, follow the manual clock adjustment procedure described on page 24.
- There may be cases in which you can listen to radio broadcasts but cannot use the ACCUCLOCK function.
- Once activated, ACCUCLOCK will remember the RDS station it uses for several weeks even if the power cord of this unit is unplugged. If you move outside the service area of the memorized RDS station and find out that ACCUCLOCK is not functioning, see "Confirming/changing the RDS Station used by ACCUCLOCK" on page 23 to change the memorized RDS station.

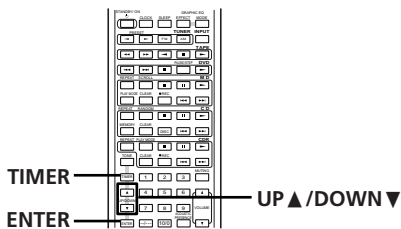

Confirming/changing the RDS station used by ACCUCLOCK

If you wish to know which RDS station has been used to set the clock by ACCUCLOCK, or to use a different RDS station signal to set the clock, follow the steps below:

- 1 Press the **TIMER** button repeatedly until **"ADJUST"** is selected on the display, then press the **ENTER** button.

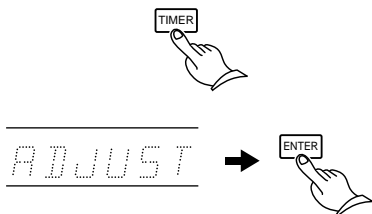

"AUTO" or "MANUAL" appears on the display.

- 2 If **"AUTO"** appears on the display, press the **ENTER** button. If **"MANUAL"** appears on the display, press the **UP ▲** or **DOWN ▼** button to select **"AUTO,"** then press the **ENTER** button.

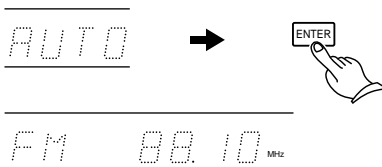

The example shown above indicates that the ACCUCLOCK function uses the RDS station whose information appears on the display (FM 88.10 MHz). If the frequency of the RDS station has not been specified, "--:--" appears instead of the frequency of the station. If you wish to change the selected RDS station or if no RDS station is selected, choose the desired RDS station by using the **UP ▲** or **DOWN ▼** button, then press the **ENTER** button.

Setting the Clock

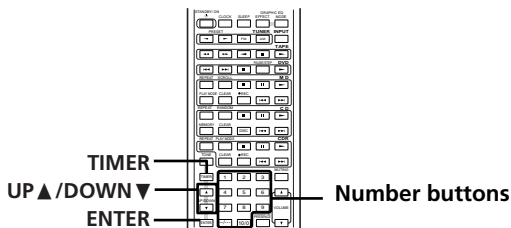

Setting the clock manually

1 Press the **TIMER** button until "ADJUST" is selected on the display, then press the **ENTER** button.

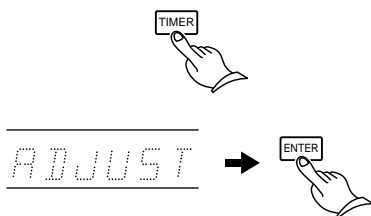

The day of the week will flash on the display.

Non-U.S. and non-Canadian models:

"AUTO" or "MANUAL" appears on the display in Standby mode.

If "MANUAL" appears on the display, press the **ENTER** button. If "AUTO" appears on the display, press the **UP ▲** or **DOWN ▼** button to select "MANUAL," then press the **ENTER** button.

The day of the week will flash on the display.

2 Press the **UP ▲** or **DOWN ▼** button or the number buttons until the desired day of the week is selected, then press the **ENTER** button.

The time will flash on the display.

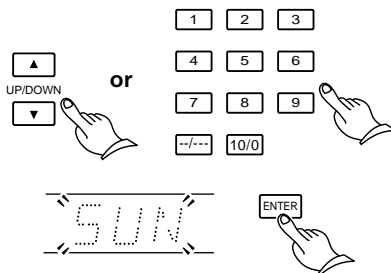

The number buttons on the remote controller:

1: SUN 3: TUE 5: THU 7: SAT
2: MON 4: WED 6: FRI

3 Use the **UP ▲** or **DOWN ▼** button or the number buttons to set the desired time.

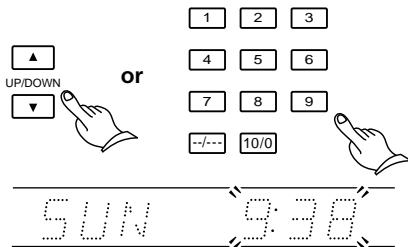

Entering the time value using the number buttons on the remote controller:

To set 9:38 am, press 10/0, 9, 3, 8, then **ENTER**.

To set 11:00 am, press 1, 1, 10/0, 10/0, then **ENTER**.

* "10/0" stands for "0."

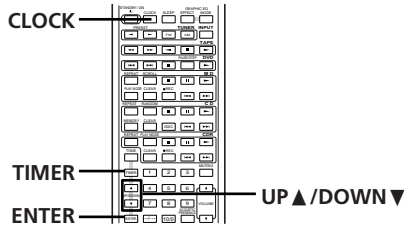

4 Press the ENTER button.



The clock will start operating.



Tip

Switching between the 24 hour and 12 hour display settings:

1. Press the **TIMER** button repeatedly to display "24H/12H."
2. Press the **ENTER** button.
3. Use the **UP ▲** or **DOWN ▼** button to select 24H (24 hour display) or 12H (12 hour display).
4. Press the **ENTER** button to confirm the setting.

Notes

- To use the number buttons instead of the **UP ▲** or **DOWN ▼** button to set the desired day of the week and time, select the 24-hour display. If you select the 12-hour display, you cannot use the number buttons to set the day and time.
- The ACCUCLOCK function is disabled if you set the clock manually. If you wish to enable the ACCUCLOCK function, refer to the previous section "Confirming/changing the RDS station used by ACCUCLOCK".

Clock Call function

- 1 Press the **CLOCK** button to display the time, press again to cancel the time display.



Note

If the time has not been set, "ADJUST" will flash on the display.

Choosing the required source

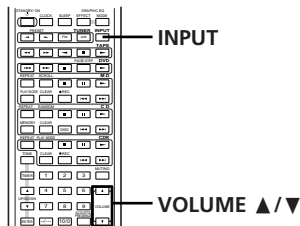
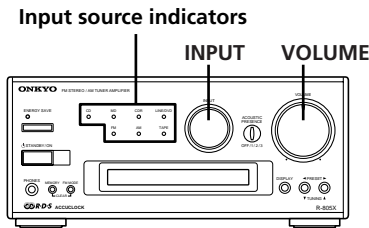

1 Turn the **INPUT** selector clockwise or counterclockwise until the input indicator of the source you wish to listen to lights.

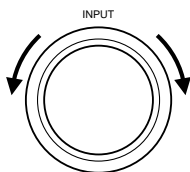

The indicators light in the following order:

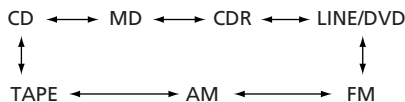

e.g. The CD player is selected.

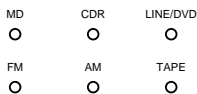

Or press the **INPUT** button on the remote controller.

If you press the **INPUT** button on the remote controller repeatedly, the indicators light up sequentially left-to-right as reflected in the figure.

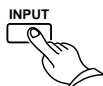

2 Start playing the source you selected in step 1.

3 Set the volume to appropriate level using the **VOLUME** control or the **VOLUME ▲ (up)/ ▼ (down)** buttons on the remote controller.

Turn the **VOLUME** control clockwise to increase the volume or counterclockwise to decrease the volume.

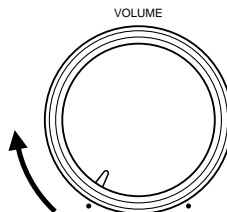

or

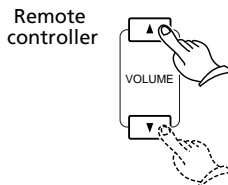

Adjusting the sound

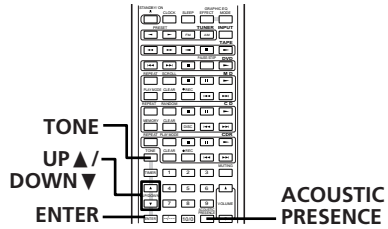
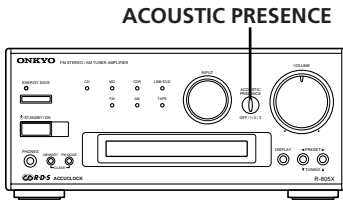

Adjusting the tone (remote controller only)

Adjusting the bass:

1. Press the **TONE** button repeatedly until "BAS" is displayed.
2. Press the **UP ▲** or **DOWN ▼** button to adjust the bass.
The bass can be adjusted from -10 to +10.

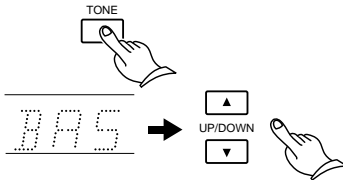

3. Press the **ENTER** button to return to the previous display.



Adjusting the treble:

1. Press the **TONE** button repeatedly until "TRE" is displayed.
2. Press the **UP ▲** or **DOWN ▼** button to adjust the treble.
The treble can be adjusted from -10 to +10.

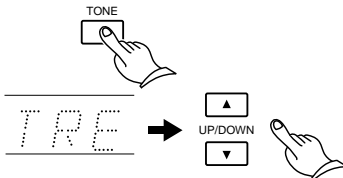

3. Press the **ENTER** button to return to the previous display.



ACQUSTIC PRESENCE

Acoustic Presence adds realness to music through the use of exclusive Onkyo circuitry. Presence settings 1, 2 and 3 are ideally suited for use with compact speakers.

Press the **ACQUSTIC PRESENCE** on the unit or the remote controller.

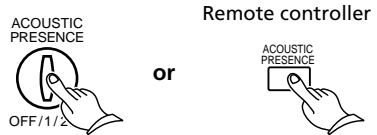

Each press changes the mode as follows:

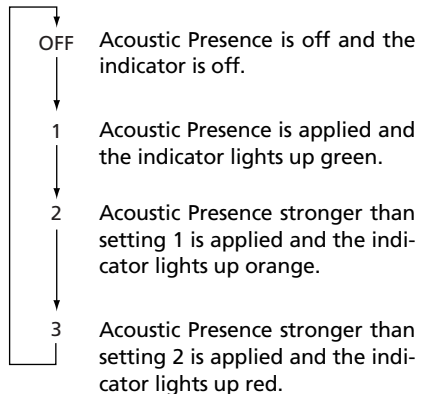

Muting/Listening with the headphones

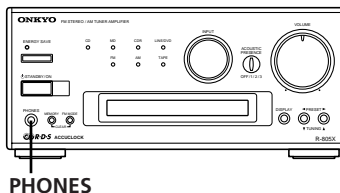
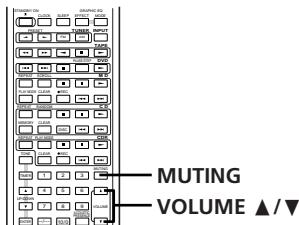

Muting the sound

Press the **MUTING** button on the remote controller to mute the sound.

The **MUTING** indicator flashes on the display. To restore the sound, press the **MUTING** button again.

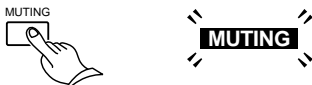

Tip

During muting:

- if you press the **VOLUME ▲** or **▼** button on the remote controller, the **MUTING** indicator disappears then the sound will be restored, and
- if you turn off the unit, and turn it on again, the sound will be restored.

Listening with the headphones

Connect the stereo headphones mini plug to the **PHONES** jack.

The speakers will reproduce no sound while the headphones are connected.

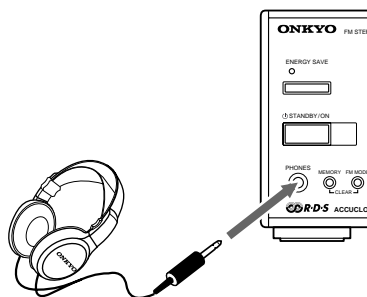

Tip

You can adjust the sound through the headphones as well as through the speakers. See "Adjusting the sound" on the previous page for operations.

Recording

Input source indicators

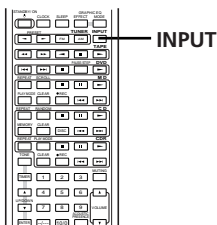
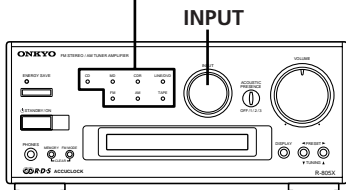

Before recording

Refer to the instruction manuals of the related components for detailed recording operations.

Note

Do not turn the INPUT selector during recording.

- Turn the INPUT selector clockwise or counterclockwise until the input indicator of the source you wish to record from lights.
Or press the INPUT button on the remote controller.

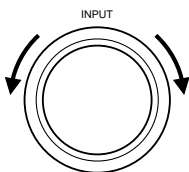

or

Remote controller

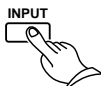

The indicators light in the following order:

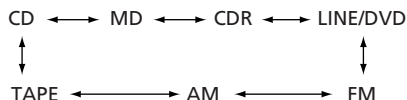

e.g. The CD player is selected.



2 Prepare the playing source.

e.g. Insert the CD you want to record from into the CD player.

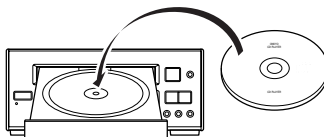

3 Prepare the recording component.

e.g. 1 Insert an MD into the MD recorder.

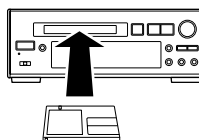

e.g. 2 Insert a cassette into the stereo cassette tape deck.

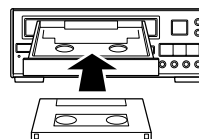

e.g. 3 Insert a CD-R into the CD recorder.

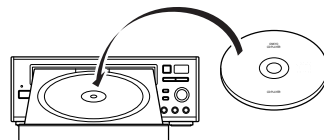

4 Start recording with the component prepared in step 3, then start playing the source prepared in step 2.

Note

If you press the INPUT button on the remote controller repeatedly, the indicators light up sequentially left-to-right as reflected in the figure.

Receiving stations

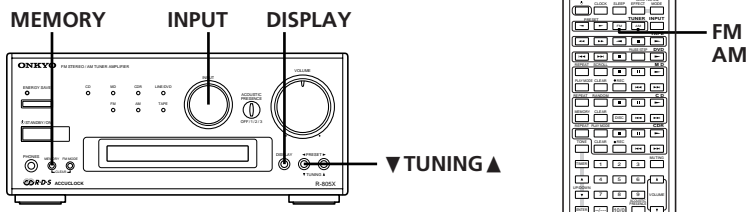

Tuning the radio

- 1 Select FM or AM using the INPUT selector or the FM or AM button on the remote controller.

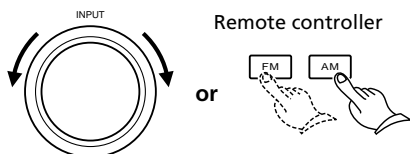

- 2 Use the TUNING ▼ or ▲ button to change the frequency.



The indoor antenna should be installed on a wall or other surface in the position which gives the best reception. For more information on how to install the antenna, refer to page 17, 19.

Display Options:

When you are listening to radio broadcasts, the display usually shows the radio frequency of the selected station. You can, however, change to the current time or character information for the selected station. To do so, press the DISPLAY button repeatedly until the desired indication appears. For more information on how to enter character information, see "Naming a preset station" on page 33.

Using Auto Memory (FM only)

This function enables you to store the frequencies into memory automatically, without having to go through and store each frequency manually.

- 1 In FM mode, hold down the MEMORY button for a few seconds. The MEMORY indicator appears on the display and "AUTO" will start flashing on the display. Keep holding down the button for a few more seconds to start the Auto Memory function.

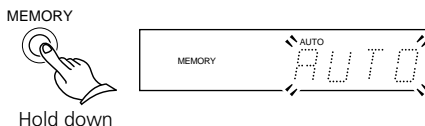

The frequencies are scanned from low to high. Up to 30 FM stations with the best signal quality are selected, sorted in order from low to high frequency, and stored into the preset memory.

Note

All stations previously stored in memory will be replaced with new Auto Memory stations.

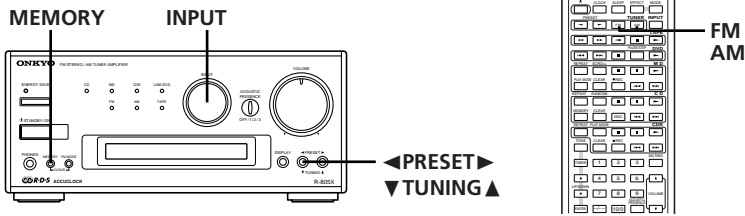

Presetting your favorite stations

You can store your favorite stations in the preset memory. Follow the procedure below:

1 Select FM or AM using the INPUT selector, or FM or AM button on the remote controller.

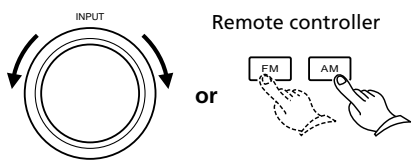

2 Use the TUNING ▼ or ▲ button to select the frequency of your favorite station.

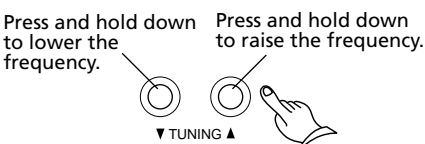

The ►◀ indicator lights up on the display when the broadcasting station is properly tuned in. The frequency is changed in 200kHz (or 50kHz) steps in FM and 10kHz (or 9kHz) steps in AM.

To automatically scan the FM stations, hold down the TUNING ▼ or ▲ button for more than 0.5 seconds, then release the button, scanning will stop when a station is tuned in.

3 Press the MEMORY button. The MEMORY indicator lights up and "....." will flash.

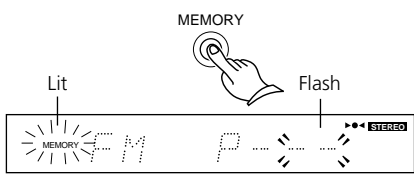

4 While "....." is flashing, use the PRESET ◀ or ▶ button to select the preset number into which to store the station frequency. The preset number will flash on the display.

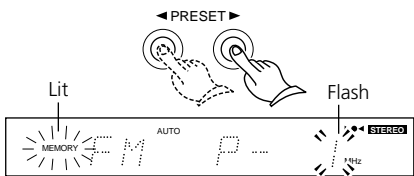

Note
If you select a preset number into which a station has already been programmed, the number will flash rapidly. If you proceed with this number, the original station will be replaced by a new station.

5 While the number is flashing, press the MEMORY button. The frequency will be stored into the selected preset.

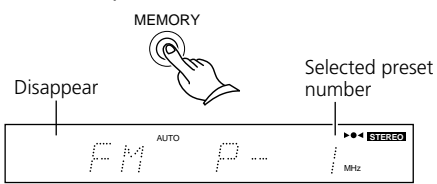

- Notes**
- Up to 30 stations can be stored in the preset memory.
 - If you try to store more than 30 stations, "FULL" appears on the display and you cannot store any more.
 - If the FM station received is an RDS station that has a PS (Program Service Name), the frequency display will change to the PS display. (Refer to page 36 for more information on the RDS function.) RDS reception is available only on the European models.

Receiving stations

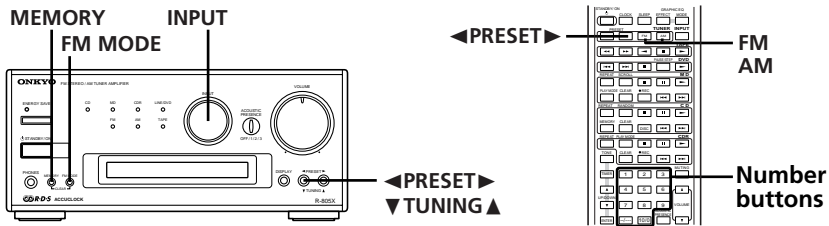

Listening to a stereo radio station

When you tune in a stereo FM station, the STEREO indicator lights up if the signal is sufficiently strong.

If the signal is weak, you can still listen to the station in mono mode. In this case, tune in as follows.

- 1 Press the **FM MODE** button. The **MONO** indicator lights up.



Displayed

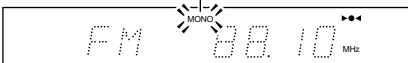

- 2 Select the station you would like to listen to using the **TUNING ▼** or **▲** button.



Selecting preset stations

Follow the procedure below to select a preset station stored in memory.

- 1 Select **FM** or **AM** using the **INPUT** selector or **FM** or **AM** button on the remote controller.

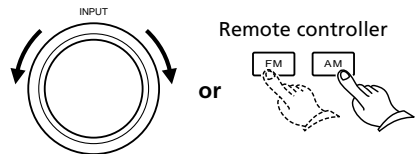

- 2 Use the **PRESET ◀** or **▶** button or the number buttons on the remote controller to select the desired preset station.

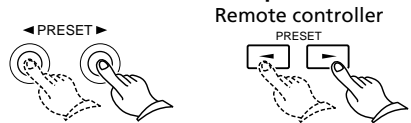

The number buttons on the remote controller:

5:

12: + +

25: + +

Clearing preset stations

You can clear preset stations from the preset memory.

- 1 Select the station as explained in the previous section.

- 2 Press and hold the **MEMORY** button and press the **FM MODE** button within a second.

"....." appears on the display.

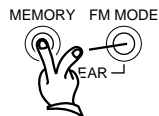

Note

If you fail to press the **FM MODE** button while holding down the **MEMORY** button immediately, the **AUTO MEMORY** function will start operating.

Naming a preset station

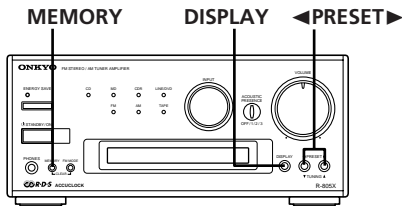

The following 54 characters can be used:
 _ A B C D E F G H I J K L M N O P Q R S
 T U V W X Y Z " & ' () * + , - . / = ? [\] | 0
 1 2 3 4 5 6 7 8 9

Naming a preset station

You can name the preset stations so that the name, instead of the frequency, appears on the display when you press the DISPLAY button. (For more information, see "Display options" on page 30.)

Note

You cannot enter characters for an RDS station that has a program service (PS) name, since the PS name has priority over other character information. (For more information on RDS stations, see page 36.)

- RDS reception is available only on the European models.

1 Select the station you wish to name. (See "Selecting preset stations" on page 32.)

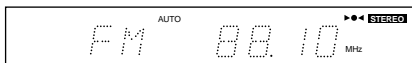

2 Press and hold down the DISPLAY button for more than two seconds.

The R-805X enters character input mode, and "....." flashes on the display.

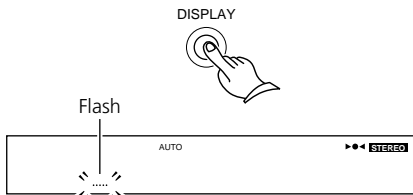

3 Use the PRESET ◀ or ▶ button to select a character.

The character flashes on the display.

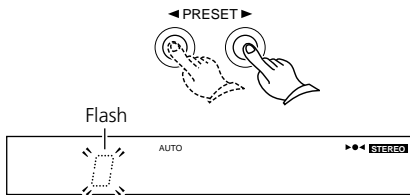

4 Press the MEMORY button to store the character.

Flashing "....." mark appears next to the stored character.

Repeat the steps 3 and 4 to store more characters. You can store up to 8 characters.

To enter a space between characters, press the MEMORY button. The bar cursor moves on to the next position.

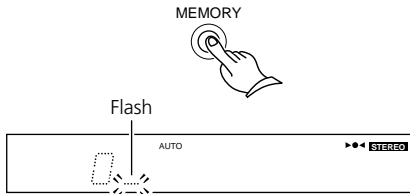

(continued on the next page)

Naming preset stations

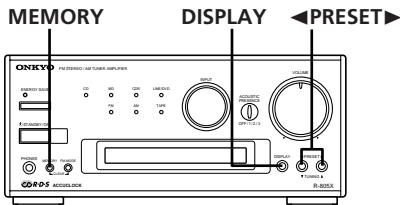

5 When you finish entering all necessary characters, press and hold down the **DISPLAY** button for more than two seconds to complete the operation.

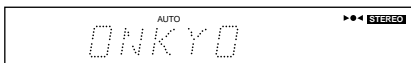
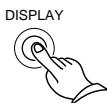

Note

If you have not pressed any button for 16 seconds during the procedure, the operation will complete automatically.

Changing the existing characters

Follow the procedure below to change the existing characters or rename the preset station.

1 Select the station you wish to modify. (See "Selecting preset stations" on page 32.)



2 Press and hold the **DISPLAY** button for a few seconds.

The R-805X enters character input mode, and the first character flashes.

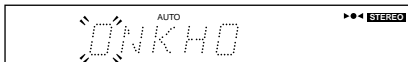

3 Press the **MEMORY** button repeatedly until the character that you want to change flashes.

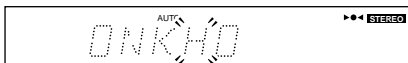
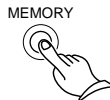

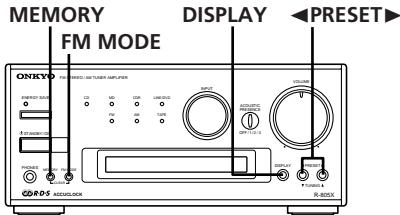

4 Use the PRESET ◀ or ▶ button to change the character.

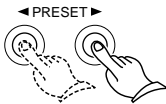

5 Press the MEMORY button to store the character.



6 Press and hold down the DISPLAY button for more than two seconds to complete the operation.



Clearing all names stored in memory

Follow the procedure below to delete the name of the selected preset station.

1 Press and hold the DISPLAY button for a few seconds.



2 While holding down the MEMORY button, press and hold the FM MODE button for a few seconds.

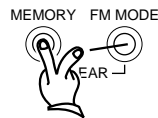

The name will be deleted.

Using the timer

The R-805X features a Timer function that enables you to start playing or recording a specified component at a specified time. To use this function, you need to connect this unit to other components via **RI** REMOTE CONTROL jacks. Refer to "Connecting the **RI** connectors and AC OUTLETS" through "Connecting the **RI** remote control cables" on pages 12 – 15 for more information on making the connections. The timer function can be performed only by using the remote controller.

Buttons and modes for the Timer function (remote controller only)

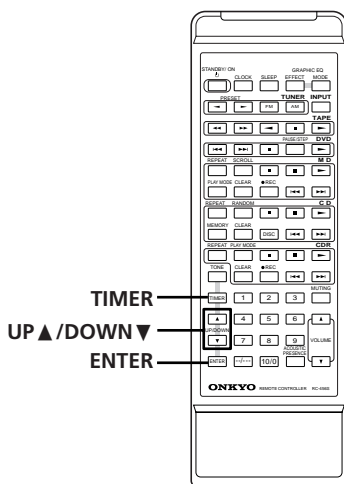

The following buttons and setting modes are used to operate the Timer function.

TIMER button

Use this button to select a timer mode. The timer mode will change each time you press this button.

UP/DOWN (▲ / ▼) buttons

Use these buttons to select the details of the mode or to change values.

ENTER button

Use this button to enter the selected mode or numbers.

Timer setting modes:

- **WEEKDAY**: This mode enables you to listen to a specified component at a designated time on weekdays. You can change the day of the week in DAY SET mode.
- **WEEKEND**: This mode enables you to listen to a specified component at a designated time on weekends. You can change the day of the week in DAY SET mode. You can define the same day of the week as both WEEKDAY and WEEKEND. To set two programs for one day, specify the same day of the week as WEEKDAY and WEEKEND and set the time for each program.
- **REC**: This mode enables you to record your favorite broadcasting program(s) starting at a designated time.
- **DAY SET**: This mode enables you to change the day setting (definition) of WEEKDAY or WEEKEND.
- **ADJUST**: This mode enables you to set and adjust the clock. If you have adjusted the clock, you do not need to set it again.

Using the timer

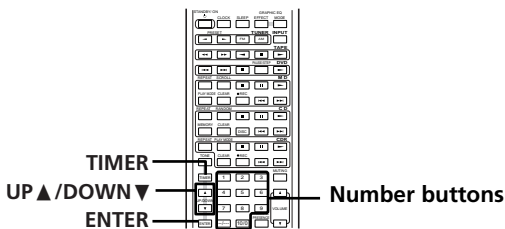

Changing the WEEKDAY and WEEKEND settings

You can define or change which day is WEEKDAY or WEEKEND. You can also define the day as both WEEKDAY and WEEKEND in order to program two timer settings on the same day.

The initial factory settings are:

WEEKDAY : Monday – Friday

WEEKEND : Saturday and Sunday

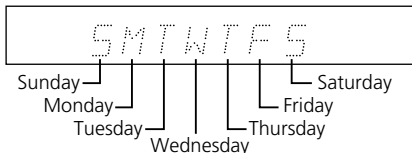

1 Press the **TIMER** button repeatedly until "DAY SET" appears on the display, then press the **ENTER** button.

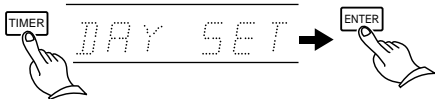

2 Press the **UP ▲** or **DOWN ▼** button to select "WEEKEND" or "WEEKDAY". "END" or "DAY" flashes.



3 Press the **ENTER** button.

The current WEEKDAY or WEEKEND setting will be displayed.

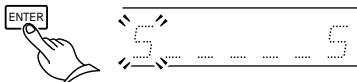

4 Press the **ENTER** button repeatedly to display the flashing bar cursor of the day you wish to select, or simply press the corresponding number buttons.

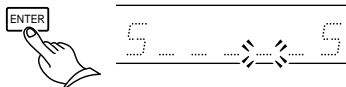

The number button on the remote controller:

- 1:S (Sunday) 5:T (Thursday)
- 2:M (Monday) 6:F (Friday)
- 3:T (Tuesday) 7:S (Saturday)
- 4: W (Wednesday)

Note

To use the number buttons, select the 24-hour display. If you select the 12-hour display, you cannot use the number buttons to set the day.

5 Press the **UP ▲** or **DOWN ▼** button to display the desired day of the week, and press the **ENTER** button.

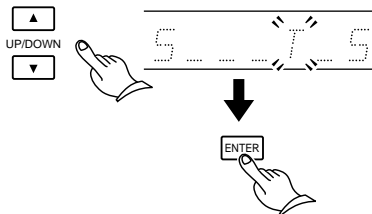

Pressing the **UP ▲** or **DOWN ▼** button repeatedly toggles between the day indication and the bar cursor (.....).

6 Press the **ENTER** button repeatedly to display the flashing character or bar cursor at the right end and press the **ENTER** button, the unit completes the setting.

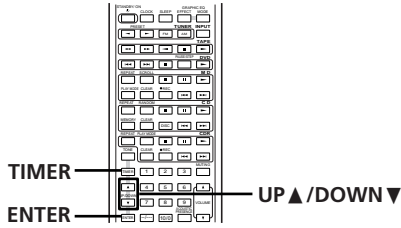

Programming to play at a specified time

Before using the timer for listening to or recording broadcast programs, you need to store the preset stations. (Refer to "Receiving stations" on page 30, 31 for information how to preset stations.)

- 1 Press the **TIMER** button repeatedly until "WEEKDAY" or "WEEKEND" is displayed, and press the **ENTER** button.

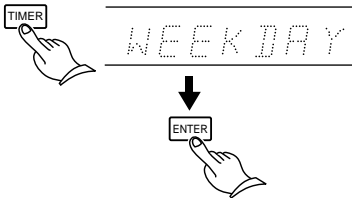

- When you store the ON time, the display automatically indicates that the OFF time is one hour after the ON time you specified.

- 3 Press the **UP ▲** or **DOWN ▼** button to select the OFF time, and press the **ENTER** button.

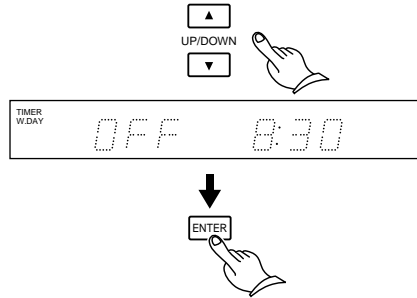

- 2 Press the **UP ▲** or **DOWN ▼** button to set the ON time, and press the **ENTER** button.

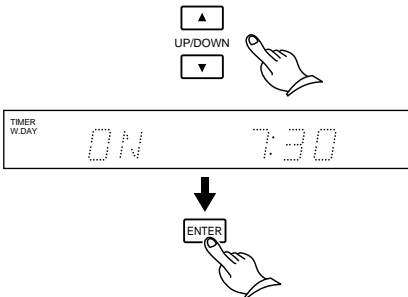

- 4 Press the **UP ▲** or **DOWN ▼** button to select the source (CD, MD, CDR, LINE/DVD, FM, AM, TAPE), and press the **ENTER** button.

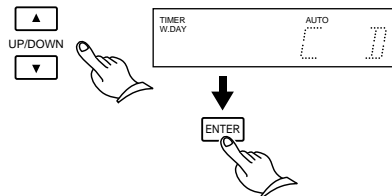

Notes

- You can also use the number buttons instead of the **UP ▲** or **DOWN ▼** button to set the desired playing ON and OFF times. To do so, refer to step 3 on page 24 and select the 24-hour display. You cannot use the number buttons if you select the 12-hour display.

If you select "FM" or "AM", press the **UP ▲** or **DOWN ▼** button again to select the preset number and press the **ENTER** button.

(continued on the next page)

Using the timer

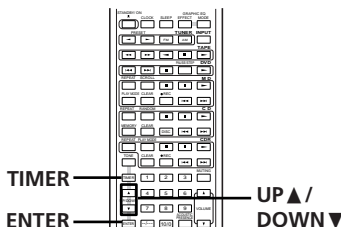
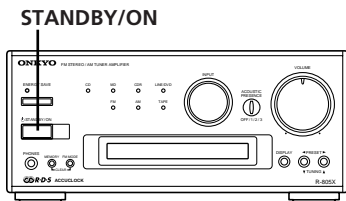

5 Press the **STANDBY/ON** button on this unit to set the Standby mode.

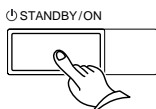

Notes

- The clock of this unit must be set correctly before programming the timer.
- Make sure that the specified source component is connected to this unit, and that the CD, MD, CDR, or cassette tape has been inserted into the appropriate component.
- The timer playback function still works while the ENERGY SAVE is on.

Programming to record at a specified time

REC mode of the Timer function enables you to record a specified source at a specified time.

Notes

- To perform timer recording to a tape, you need to use a cassette tape deck that features the **RI** mark, such as the K-505X.
- To perform timer recording to a mini disc, you need to use an MD recorder that features the **RI** mark, such as the MD-105X.

1 Press the **TIMER** button repeatedly until "REC" appears on the display, then press the **ENTER** button.

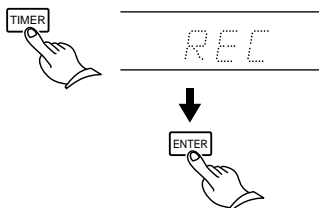

2 Press the **UP ▲** or **DOWN ▼** button to select the day of the week when you wish to start recording, then press the **ENTER** button.

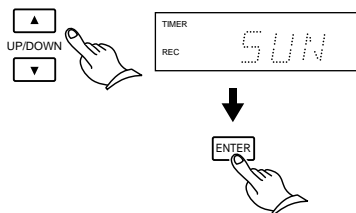

You can select "NEXT" instead of the day of the week. If you do so, recording will start at the next occurrence of the indicated time.

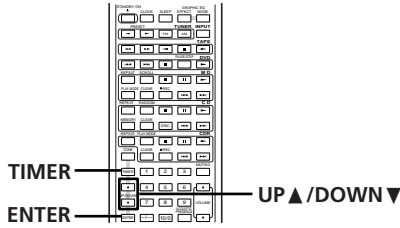

3 Press the UP ▲ or DOWN ▼ button to set the ON time, and press the ENTER button.

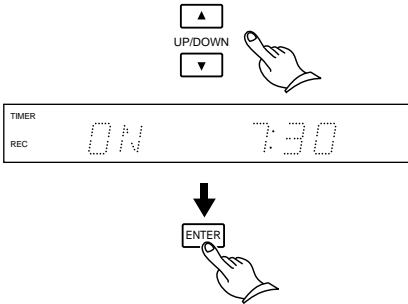

5 Press the UP ▲ or DOWN ▼ button to select the source (FM, AM, LINE/DVD), and press the ENTER button.

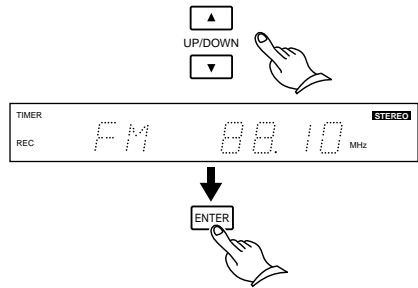

Notes

- You can also use the number buttons instead of the UP ▲ or DOWN ▼ button to set the desired recording ON and OFF time. To do so, refer to step 3 on page 24 and select the 24-hour display. You cannot use the number buttons if you select the 12-hour display.
- When you store the ON time, the display automatically indicates that the OFF time is one hour after the ON time you specified.

If you select "FM" or "AM", press the UP ▲ or DOWN ▼ buttons again to select the pre-set number, then press the ENTER button.

4 Press the UP ▲ or DOWN ▼ button to set the OFF time, then press the ENTER button.

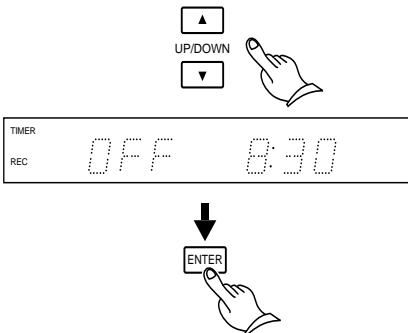

6 Press the UP ▲ or DOWN ▼ button to select the recording component (TAPE REC, MD REC, or MD/TAPE), and press the ENTER button.

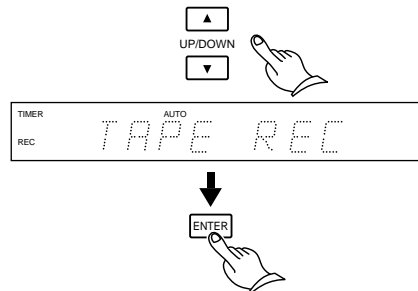

- When you record analog FM or AM signals to an MD recorder, be sure to use Analog In on the MD recorder.

(continued on the next page)

Using the timer

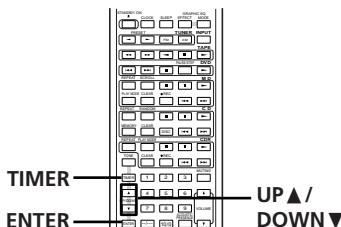
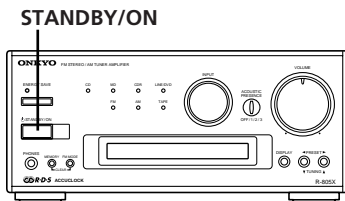

7 Press the **STANDBY/ON** button on this unit to set the Standby mode.

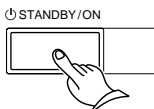

Notes

- Since muting is automatically turned on when the timer is used to record, the sound cannot be heard during recording. To monitor recording, press the **MUTING** button on the remote controller to cancel muting.
- Timer recording is activated once. After recording, the **REC** mode setting will be cancelled.
- Timer recording functions even while the unit is in Energy Save mode.

Switching the timer ON/OFF

You can switch the timer **ON/OFF** to cancel the timer setting, to enable the timer again, or to perform timer recording again.

When the Timer function is enabled, the selected timer mode such as "W.DAY", "W.END", and "REC" appears in the upper left corner of the display.

Note

To switch the timer **ON**, first you need to program the time value.

1 Press the **TIMER** button repeatedly until the timer mode (**WEEKDAY**, **WEEKEND** or **REC**) that you wish to enable or disable appears on the upper left corner of the display.



2 Press the **UP ▲** or **DOWN ▼** button to switch the selected mode **ON** or **OFF**.

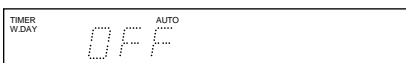
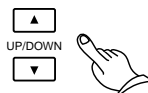

3 Press the **ENTER** button to confirm the selection.



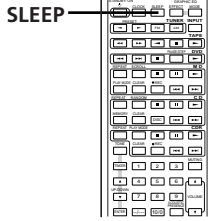

Sleep function

The Sleep function can be performed only by using remote controller.

The SLEEP timer automatically sets the entire system to Standby mode after a specified period of time.

1 Start playing something you would like to listen to.

(CD, tape, MD or radio broadcast).

2 Press the SLEEP button repeatedly to set the desired sleep time.

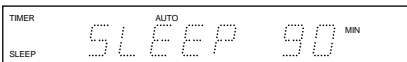

The time value will decrease from 90 minutes to 10 minutes in steps of 10 minutes. After a specified period of time, the unit will be automatically placed in Standby mode.

- To check the remaining time while the SLEEP function is active, press the SLEEP button.
- After CD dubbing is complete, the unit will be placed in Standby mode.

Cancelling the SLEEP setting

Press the SLEEP button repeatedly until the SLEEP indicator on the display disappears.

Notes for timer setting

- Make sure that the clock has been set correctly before setting the timer.
- After setting the timer, be sure to set this unit in Standby mode. If this unit is not in Standby mode, the timer will not work.
- When the power is turned on by one of the timer mode settings, the other timer modes may not be activated at their ON time. The power will be switched off by the first timer mode at its OFF time. Set a gap of one minute or more between the OFF time and ON time for each timer setting. (See the figure below.)
- If you press the SLEEP button during timer play or timer recording, the power will be switched off at the SLEEP timer's OFF time.
- If more than two timer mode settings are made at the same time, the "WEEKDAY" setting has the priority over the "WEEK-END" setting. The "REC" mode setting has no priority.
- The timer recording setting will be cancelled if the recording does not start at the ON time (for example, if the power is already on).

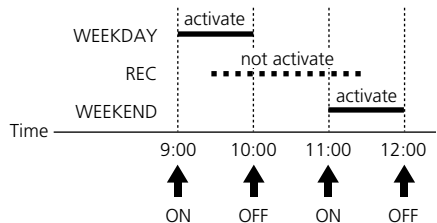

Troubleshooting

If you have any problems with the unit, please check the troubleshooting table below first. For any problems not covered in the table, please consult your nearest ONKYO authorized service center.

Symptom	Cause	Remedy
The unit doesn't turn on.	<ul style="list-style-type: none">• The AC power cord is not fully inserted into the wall outlet.	<ul style="list-style-type: none">• Insert the AC power cord (mains lead) plug into the wall outlet (the mains) securely.
Sound is reproduced from neither left or right speaker.	<ul style="list-style-type: none">• The wire of the speaker cord is touching the other jacks, connectors, or metal parts.• The volume level is turned down to the minimum.• The sound is muted with the muting function.• The headphones are connected to the PHONES jack.• Jumper plugs are not connected to the PROCESSOR connectors.	<ul style="list-style-type: none">• Check the speaker connections (see page 16).• Adjust the volume level (see page 26).• Press MUTING button on the remote controller to restore the sound (see page 28).• Turn down the volume level first, then disconnect the headphones. Then, readjust the volume level.• Connect the jumper plugs to PROCESSOR connectors.
Sound is reproduced from only one speaker.	<ul style="list-style-type: none">• The speaker cord is not connected properly or firmly, or is disconnected.• Jumper plug is not connected to the PROCESSOR connectors.	<ul style="list-style-type: none">• Check the speaker connections (see page 16).• Connect the jumper plug to PROCESSOR connectors.
No sound is reproduced when the (wake-up) timer operates.	<ul style="list-style-type: none">• The volume level is turned down to the minimum.	<ul style="list-style-type: none">• Adjust the volume to the proper level when you set the timer (see page 26).
The remote control doesn't operate.	<ul style="list-style-type: none">• The batteries in the remote controller are dead.• The remote controller is out of the control range.• There is some obstruction between the remote controller and the unit.	<ul style="list-style-type: none">• Replace the batteries with new ones (see page 21).• Operate the remote controller within the control range (see page 21).• Try to operate the remote controller from a different angle, or remove the obstruction.

Symptom	Cause	Remedy
AM stations cannot be received.	<ul style="list-style-type: none"> • AM loop antenna is not attached. 	<ul style="list-style-type: none"> • Connect the supplied AM loop antenna to the AM antenna terminals.
Buzzing noise on AM (particularly conspicuous at night or with weak stations).	<ul style="list-style-type: none"> • Noise from electrical apparatus such as fluorescent lamp. 	<ul style="list-style-type: none"> • Move the AM loop antenna to different position. • Set up an outdoor AM antenna.
High-pitched noise or buzzing noise on AM.	<ul style="list-style-type: none"> • Noise from TV set. 	<ul style="list-style-type: none"> • Place the AM loop antenna as far as possible from the TV. • Move unit away from TV set.
Crackling noise on AM, FM.	<ul style="list-style-type: none"> • Noise caused by turning a fluorescent lamp on and off. • Noise from automobile ignition. 	<ul style="list-style-type: none"> • Move the antenna as far away as possible from the fluorescent lamp. • Install an outdoor FM antenna as far away as possible from the road.
Tuning indicators and stereo indicator light but sound is distorted and separation is bad.	<ul style="list-style-type: none"> • Station is too strong. • Multiple reflection of the radio waves because of tall buildings or mountains. 	<ul style="list-style-type: none"> • Change to FM indoor antenna. • Use antenna that has better directivity and select a point with the least distortion.
Tuning indicators and stereo indicator flicker and hiss is heard on FM.	<ul style="list-style-type: none"> • Station is too weak. • Stereo FM broadcasts cover only about half the distance of an ordinary broadcast. 	<ul style="list-style-type: none"> • Install an outdoor FM antenna. • Change the position or direction of the outdoor antenna. • Switch to mono reception. (Even stereo broadcasts will be heard in mono.)
No station or undesired station is recalled when a Pre-set button is pressed.	<ul style="list-style-type: none"> • The power cord has been unplugged for a long time. 	<ul style="list-style-type: none"> • The memory contents are lost if the power is not turned on and off a few times each month. Store all stations in the memory again and remember to turn the power on and off a few times each month.
The RDS function does not work.	<ul style="list-style-type: none"> • The station is not an RDS station. • The reception station signal is too weak. • Too much interference. 	<ul style="list-style-type: none"> • Receive an RDS station. • Install an outdoor FM antenna. • Change the position or direction of the outdoor antenna. • Move the antenna as far away as possible from fluorescent lamps. • Install an outdoor FM antenna.
ACCUCLOCK function does not work.	<ul style="list-style-type: none"> • The station is not an RDS station, or received signal is too weak. • RDS broadcasts cannot be received. 	<ul style="list-style-type: none"> • See the remedies for the RDS function problem above. • Set and adjust according to instructions above.

- Excessive electrical interference may temporarily render this system's sensitive microcomputer inoperable. If this happens, unplug the system for at least five seconds.

Specifications

Amplifier Section

Power output

20 watts per channel, min RMS, at 4 ohms, both channels driven 1 kHz, with no more than 0.6% THD

15 watt per channel, min RMS, at 8 ohms, both channels driven 1 kHz, with no more than 0.6% THD

2 X 20 watts at 4 ohms, 1 kHz, DIN

2 X 17 watts at 6 ohms, 1 kHz, DIN

2 X 15 watts at 8 ohms, 1 kHz, DIN

2 X 29 watts at 4 ohms, 1 kHz, EIAJ

Dynamic power output

2 X 24 watts at 4 ohms

2 X 17 watts at 8 ohms

Total harmonic distortion

0.6% at rated power

IM distortion

0.6% at rated power

Damping factor

30 at 8 ohms

Input Sensitivity and Impedance

TAPE/MD PLAY: 150 mV, 50 kohms

LINE IN: 150 mV, 50 kohms

Frequency and response

10 to 50,000 Hz +0 / -3 dB

Tone control

ACOUSTIC PRESENCE 1

+4 dB at 82 Hz

ACOUSTIC PRESENCE 2

+3 dB at 20.5 Hz, + 3 dB at 82 Hz

ACOUSTIC PRESENCE 3

+3 dB at 20.5 Hz, + 6 dB at 82 Hz

BASS

±8 dB at 100 Hz

TREBLE

±8 dB at 10 kHz

Signal to noise ratio

TAPE: 100 dB (IHF-A)

Muting

-∞ dB

Tuner Section

Tuning range

FM: 87.9 to 107.9 MHz (200 kHz steps)
(U.S. & Canadian models)

87.5 to 108.00 MHz (50 kHz steps)
(Other area models)

AM: 530 to 1710 kHz (10 kHz steps)
(U.S. & Canadian models)

522 to 1611 kHz (9 kHz steps)
(Other area models)

Usable sensitivity

FM: Mono 11.2 dBf,

1.0 μV (75 ohms IHF)

0.9 μV (75 ohms DIN)

Stereo 17.2 dBf,

2.0 μV (75 ohms IHF)

23.0 μV (75 ohms DIN)

AM: 30 μV

50 dB Quieting sensitivity

FM: Mono 17.2 dBf, 2.0 μV (75 ohms)

Stereo 37.2 dBf, 20.0 μV (75 ohms)

Capture ratio

FM: 2.0 dB

Image rejection ratio

FM: 40 dB (U.S. & Canadian models)

85 dB (Other area models)

AM: 40 dB

IF rejection ratio

FM: 90 dB

AM: 40 dB

Signal to noise ratio

FM: Mono 73 dB, IHF

Stereo 67 dB, IHF

AM: 40 dB

Selectivity

FM: 50 dB DIN

(±300 kHz at 40 kHz Devi.)

AM Suppression Ratio

50 dB

Harmonic distortion

FM: Mono 0.2%

Stereo 0.3%

AM: 0.7 %

Frequency response

FM: 30 to 15,000 Hz (±1.5 dB)

Stereo separation

FM: 45 dB at 1,000 Hz

30 dB at 100 to 10,000 Hz

Stereo threshold

FM: 17.2 dBf, 2.0 μV (75 ohms)

General**Clock precision**

monthly error: +/-30 seconds
(at 25 degrees Celsius)

Power supply

AC 120 V, 60 Hz

AC 230 V, 50 Hz

Power consumption

61 W (120 V, 60 Hz)

54 W (230 V, 50 Hz)

Dimensions (W X H X D)

205 X 91 X 302 mm

8-1/16" X 3-9/16" X 11-7/8"

Weight

3.4 kg, 7.5 lbs

Specifications and external appearance are subject to change without notice as a result of product improvement.

Index to parts and controls

Front panel

For more information about buttons, turn to the page number in the brackets [].

STANDBY/ON button [20, 40, 42]

Input source indicators [26, 29]

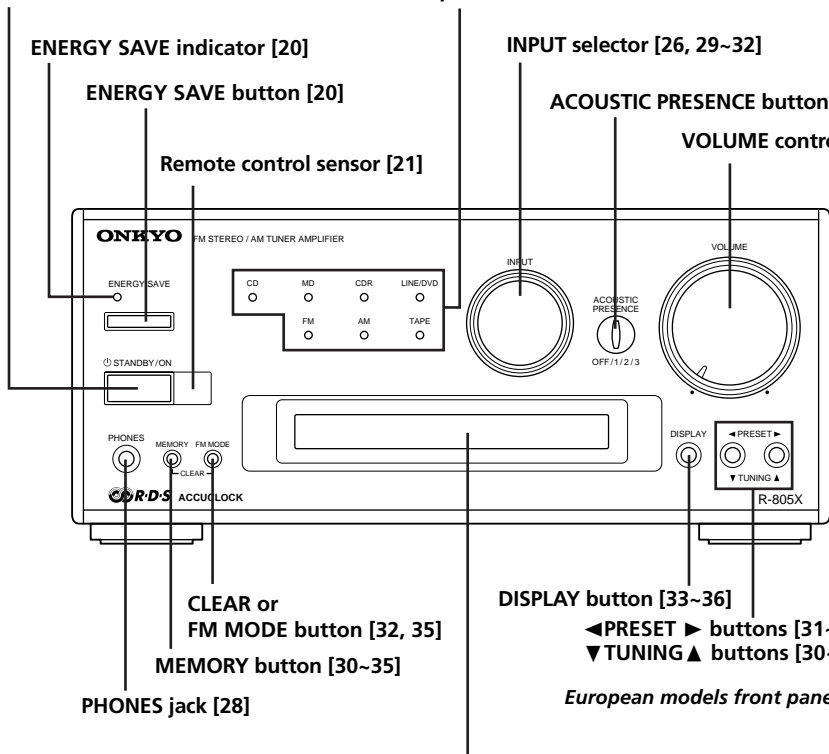

PHONES jack [28]

CLEAR or FM MODE button [32, 35]
MEMORY button [30~35]

DISPLAY button [33~36]

◀PRESET ▶ buttons [31~33, 35]
▼TUNING▲ buttons [30~32]

European models front panel shown.

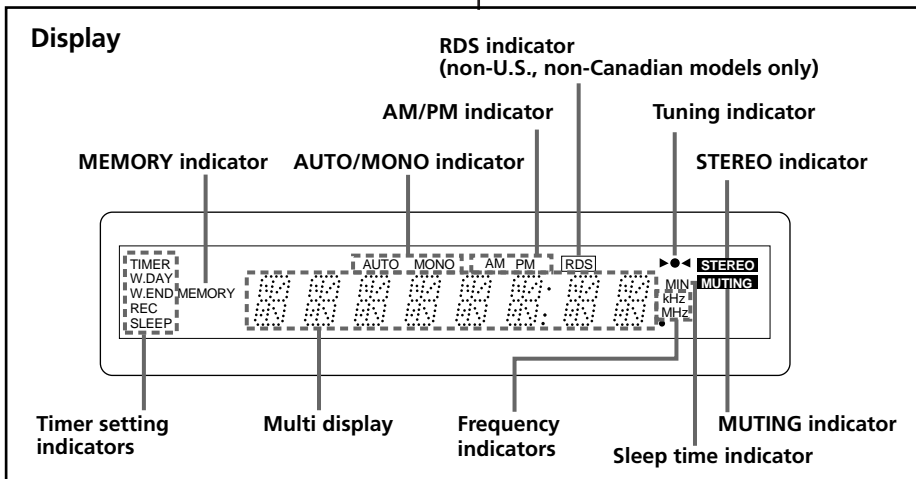

Remote controller

- You can control the other **RI**-connected components with the supplied remote controller.
- The remote controller buttons operate in the same way as the buttons on each component with the same indication.
- For actual operations, please refer to the Instruction Manual for each component.

STANDBY/ON button [20, 40, 42]

Tuner control [31~33, 35]

◀PRESET▶ :Tuner preset select buttons

FM : FM band select button

AM : AM band select button

STONE button [27]

Enables you to set the tone.

Mode Select buttons

[23, 24, 38~42]

TIMER :Pressing this button repeatedly to select one of the following eight settings.

WEEKDAY: Timer playback on the specified day(s) of the week.

WEEKEND: Timer playback on the specified day(s) of the week.

REC: Timer record setting

DAYSET: Sets the day of the week (WEEKDAY & WEEKEND).

ADJUST: Sets the current time and the day of the week.

24H/12H:Enables you to select 24-hour display or 12-hour display by pressing the ENTER button and using the UP ▲/DOWN ▼ buttons.

UP ▲/DOWN ▼ : Enables you to select a parameter after you press the TIMER or TONE button. Press the ENTER button to confirm the selection.

ENTER:Press this button to confirm the selection made via the TIMER, TONE, UP ▲, or DOWN ▼ button.

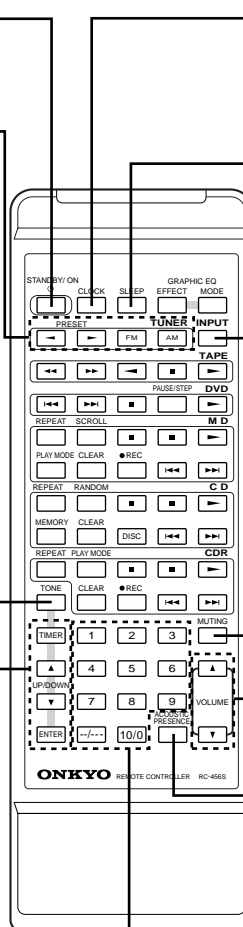

CLOCK button [25]
Press this button to display the current time.

SLEEP button [43]
Enables you to make the Sleep time setting.

INPUT button [26, 29]
Enables you to select a listening source.

MUTING button [28]
Mutes the sound temporarily.

VOLUME ▲/▼ buttons [26]
Enables you to increase or decrease the volume level.

ACOUSTIC PRESENCE button [27]
Switches acoustic presence off and types.

Number buttons [24, 32, 38]
Used to set the time/day and select the PRESET stations.

Remote controller

- Use the following buttons to control components that are connected to the **RI**-system.

Stereo cassette tape deck control

- ◀ : Reverse play button
- : Stop button
- ▶ : Play button
- ◀◀ : Rewind button
- ▶▶ : Fast-forward button

DVD player control

- ◀◀ : Chapter/track down button
- ▶▶ : Chapter/track up button
- : Stop button
- PAUSE/STEP : Pause/Step forward button
- ▶ : Play button

CD player (or changer) control

- REPEAT : Repeat mode button
- RANDOM : Random play button
- : Stop button
- || : Pause button
- ▶ : Play button
- MEMORY : Memory button
- CLEAR : Clear button
- DISC : Disc button for CD changer
- ◀◀ : Track down button
- ▶▶ : Track up button

Graphic equalizer control

- EFFECT : Effect select button
- MODE : Mode select button

MD recorder control

- REPEAT : Repeat mode button
- SCROLL : Scroll button
- : Stop button
- || : Pause button
- ▶ : Play button
- PLAY MODE : Play mode selection button
- CLEAR : Clear button
- REC : Recording button
- ◀◀ : Track down button
- ▶▶ : Track up button

CD recorder control

- REPEAT : Repeat mode button
- PLAY MODE : Play mode selection button
- : Stop button
- || : Pause button
- ▶ : Play button
- CLEAR : Clear button
- REC : Recording button
- ◀◀ : Track down button
- ▶▶ : Track up button

CD player (or changer) / MD recorder / CD recorder control

- 1~9, 10/0 : Number buttons
- /-- : Ten's hold button

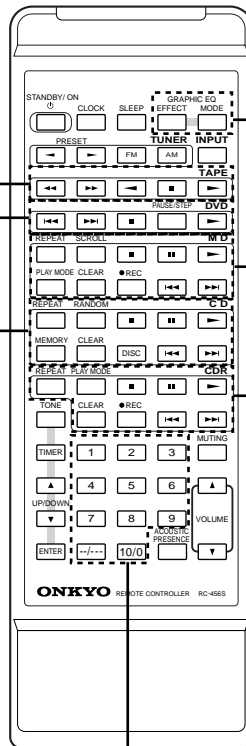

MEMO

ONKYO CORPORATION

Sales & Product Planning Div. : 2-1, Nisshin-cho, Neyagawa-shi, OSAKA 572-8540, JAPAN
Tel: 072-831-8111 Fax: 072-833-5222 <http://www.onkyo-intl.com>

ONKYO U.S.A. CORPORATION

18 Park Way, Upper Saddle River, N.J. 07458, U.S.A.
Tel: 201-785-2600 Fax: 201-785-2650 <http://www.onkyousa.com>

ONKYO EUROPE ELECTRONICS GmbH

Liegnitzerstrasse 6, 82194 Groebenzell, GERMANY
Tel: +49-8142-4401-0 Fax: +49-8142-4401-555 <http://www.onkyo.net>

ONKYO CHINA LIMITED

Units 2102-2107, Metroplaza Tower I, 223 Hing Fong Road, Kwai Chung,
N.T., HONG KONG Tel: 852-2429-3118 Fax: 852-2428-9039



SN 29342838B

Printed in Japan
I0104-3



Free Manuals Download Website

<http://myh66.com>

<http://usermanuals.us>

<http://www.somanuals.com>

<http://www.4manuals.cc>

<http://www.manual-lib.com>

<http://www.404manual.com>

<http://www.luxmanual.com>

<http://aubethermostatmanual.com>

Golf course search by state

<http://golfingnear.com>

Email search by domain

<http://emailbydomain.com>

Auto manuals search

<http://auto.somanuals.com>

TV manuals search

<http://tv.somanuals.com>