

# ONKYO®

## AV Receiver

# HT-RC160

## Instruction Manual

Thank you for purchasing an Onkyo AV Receiver. Please read this manual thoroughly before making connections and plugging in the unit. Following the instructions in this manual will enable you to obtain optimum performance and listening enjoyment from your new AV Receiver. Please retain this manual for future reference.

## Contents

**Introduction .....2**

**Connection ..... 15**

**Turning On & First Time Setup .....37**

**Basic Operations.....50**

**Using the Listening Modes .....59**

**Advanced Setup ..... 66**

**Zone 2 .....82**

**Controlling Other Components .... 86**

**Others.....97**



## WARNING:

TO REDUCE THE RISK OF FIRE OR ELECTRIC SHOCK, DO NOT EXPOSE THIS APPARATUS TO RAIN OR MOISTURE.

## CAUTION:

TO REDUCE THE RISK OF ELECTRIC SHOCK, DO NOT REMOVE COVER (OR BACK). NO USER-SERVICEABLE PARTS INSIDE. REFER SERVICING TO QUALIFIED SERVICE PERSONNEL.



**WARNING**  
RISK OF ELECTRIC SHOCK  
DO NOT OPEN

**AVIS**  
RISQUE DE CHOC ELECTRIQUE  
NE PAS OUVRIR



The lightning flash with arrowhead symbol, within an equilateral triangle, is intended to alert the user to the presence of uninsulated "dangerous voltage" within the product's enclosure that may be of sufficient magnitude to constitute a risk of electric shock to persons.



The exclamation point within an equilateral triangle is intended to alert the user to the presence of important operating and maintenance (servicing) instructions in the literature accompanying the appliance.

## Important Safety Instructions

1. Read these instructions.
2. Keep these instructions.
3. Heed all warnings.
4. Follow all instructions.
5. Do not use this apparatus near water.
6. Clean only with dry cloth.
7. Do not block any ventilation openings. Install in accordance with the manufacturer's instructions.
8. Do not install near any heat sources such as radiators, heat registers, stoves, or other apparatus (including amplifiers) that produce heat.
9. Do not defeat the safety purpose of the polarized or grounding-type plug. A polarized plug has two blades with one wider than the other. A grounding type plug has two blades and a third grounding prong. The wide blade or the third prong are provided for your safety. If the provided plug does not fit into your outlet, consult an electrician for replacement of the obsolete outlet.
10. Protect the power cord from being walked on or pinched particularly at plugs, convenience receptacles, and the point where they exit from the apparatus.
11. Only use attachments/accessories specified by the manufacturer.
12. Use only with the cart, stand, tripod, bracket, or table specified by the manufacturer, or sold with the apparatus. When a cart is used, use caution when moving the cart/apparatus combination to avoid injury from tip-over.  

PORTABLE CART WARNING  
S3125A
13. Unplug this apparatus during lightning storms or when unused for long periods of time.
14. Refer all servicing to qualified service personnel. Servicing is required when the apparatus has been damaged in any way, such as power-supply cord or plug is damaged, liquid has been spilled or objects have fallen into the apparatus, the apparatus has been exposed to rain or moisture, does not operate normally, or has been dropped.
15. Damage Requiring Service  
Unplug the apparatus from the wall outlet and refer servicing to qualified service personnel under the following conditions:
  - A. When the power-supply cord or plug is damaged,
  - B. If liquid has been spilled, or objects have fallen into the apparatus,
  - C. If the apparatus has been exposed to rain or water,
  - D. If the apparatus does not operate normally by following the operating instructions. Adjust only those controls that are covered by the operating instructions as an improper adjustment of other controls may result in damage and will often require extensive work by a qualified technician to restore the apparatus to its normal operation,
  - E. If the apparatus has been dropped or damaged in any way, and
  - F. When the apparatus exhibits a distinct change in performance this indicates a need for service.
16. Object and Liquid Entry  
Never push objects of any kind into the apparatus through openings as they may touch dangerous voltage points or short-out parts that could result in a fire or electric shock.  
The apparatus shall not be exposed to dripping or splashing and no objects filled with liquids, such as vases shall be placed on the apparatus.  
Don't put candles or other burning objects on top of this unit.
17. Batteries  
Always consider the environmental issues and follow local regulations when disposing of batteries.
18. If you install the apparatus in a built-in installation, such as a bookcase or rack, ensure that there is adequate ventilation.  
Leave 20 cm (8") of free space at the top and sides and 10 cm (4") at the rear. The rear edge of the shelf or board above the apparatus shall be set 10 cm (4") away from the rear panel or wall, creating a flue-like gap for warm air to escape.

# Precautions

---

1. **Recording Copyright**—Unless it's for personal use only, recording copyrighted material is illegal without the permission of the copyright holder.
2. **AC Fuse**—The AC fuse inside the unit is not user-serviceable. If you cannot turn on the unit, contact your Onkyo dealer.
3. **Care**—Occasionally you should dust the unit all over with a soft cloth. For stubborn stains, use a soft cloth dampened with a weak solution of mild detergent and water. Dry the unit immediately afterwards with a clean cloth. Don't use abrasive cloths, thinners, alcohol, or other chemical solvents, because they may damage the finish or remove the panel lettering.
4. **Power**

## **WARNING**

**BEFORE PLUGGING IN THE UNIT FOR THE FIRST TIME, READ THE FOLLOWING SECTION CAREFULLY.**

AC outlet voltages vary from country to country. Make sure that the voltage in your area meets the voltage requirements printed on the unit's rear panel (e.g., AC 230 V, 50 Hz or AC 120 V, 60 Hz).

The power cord plug is used to disconnect this unit from the AC power source. Make sure that the plug is readily operable (easily accessible) at all times.

Pressing the [ON/STANDBY] button to select Standby mode does not fully shutdown the unit. If you do not intend to use the unit for an extended period, remove the power cord from the AC outlet.

5. **Preventing Hearing Loss**

## **Caution**

Excessive sound pressure from earphones and headphones can cause hearing loss.

6. **Batteries and Heat Exposure**

## **Warning**

Batteries (battery pack or batteries installed) shall not be exposed to excessive heat as sunshine, fire or the like.

7. **Never Touch this Unit with Wet Hands**—Never handle this unit or its power cord while your hands are wet or damp. If water or any other liquid gets inside this unit, have it checked by your Onkyo dealer.

8. **Handling Notes**

- If you need to transport this unit, use the original packaging to pack it how it was when you originally bought it.
- Do not leave rubber or plastic items on this unit for a long time, because they may leave marks on the case.
- This unit's top and rear panels may get warm after prolonged use. This is normal.
- If you do not use this unit for a long time, it may not work properly the next time you turn it on, so be sure to use it occasionally.

## **For U.S. models**

### **FCC Information for User**

#### **CAUTION:**

The user changes or modifications not expressly approved by the party responsible for compliance could void the user's authority to operate the equipment.

#### **NOTE:**

This equipment has been tested and found to comply with the limits for a Class B digital device, pursuant to Part 15 of the FCC Rules. These limits are designed to provide reasonable protection against harmful interference in a residential installation.

This equipment generates, uses and can radiate radio frequency energy and, if not installed and used in accordance with the instructions, may cause harmful interference to radio communications. However, there is no guarantee that interference will not occur in a particular installation. If this equipment does cause harmful interference to radio or television reception, which can be determined by turning the equipment off and on, the user is encouraged to try to correct the interference by one or more of the following measures:

- Reorient or relocate the receiving antenna.
- Increase the separation between the equipment and receiver.
- Connect the equipment into an outlet on a circuit different from that to which the receiver is connected.
- Consult the dealer or an experienced radio/TV technician for help.

## **For Canadian Models**

**NOTE:** THIS CLASS B DIGITAL APPARATUS COMPLIES WITH CANADIAN ICES-003.

For models having a power cord with a polarized plug:

**CAUTION:** TO PREVENT ELECTRIC SHOCK, MATCH WIDE BLADE OF PLUG TO WIDE SLOT, FULLY INSERT.

## **Modèle pour les Canadien**

**REMARQUE:** CET APPAREIL NUMÉRIQUE DE LA CLASSE B EST CONFORME À LA NORME NMB-003 DU CANADA.

Sur les modèles dont la fiche est polarisée:

**ATTENTION:** POUR ÉVITER LES CHOCS ÉLECTRIQUES, INTRODUIRE LA LAME LA PLUS LARGE DE LA FICHE DANS LA BORNE CORRESPONDANTE DE LA PRISE ET POUSSER JUSQU'AU FOND.

# Supplied Accessories

---

Make sure you have the following accessories:

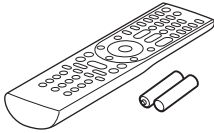

**Remote controller & two batteries (AA/R6)**

---



**Speaker setup microphone**

---



**Indoor FM antenna**

---



**AM loop antenna**

---

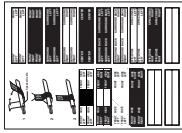

**Speaker cable labels**  
(not supplied with the HT-S7200 Home Theater System.)

---

\* In catalogs and on packaging, the letter at the end of the product name indicates the color. Specifications and operations are the same regardless of color.



# Contents

<b>Introduction</b>	
Important Safety Instructions .....	2
Precautions .....	3
Supplied Accessories .....	4
Features .....	6
Multiroom Capability .....	7
Front & Rear Panels .....	8
Front Panel .....	8
Display .....	9
Rear Panel .....	10
Remote Controller .....	12
Installing the Batteries .....	12
Aiming the Remote Controller .....	12
Controlling the AV Receiver .....	13
About Home Theater .....	14
Enjoying Home Theater .....	14

<b>Connection</b>	
Connecting the AV Receiver .....	15
Connecting Your Speakers .....	15
Bi-amping the Front Speakers .....	18
Connecting Antenna .....	19
About AV Connections .....	21
Connecting Components with HDMI .....	22
Connecting Both Audio & Video .....	24
Which Connections Should I Use? .....	24
Connecting a TV or Projector .....	26
Connecting a DVD/BD Player .....	27
Connecting a VCR or DVD/BD Recorder for Playback .....	28
Connecting a VCR or DVD/BD Recorder for Recording .....	29
Connecting a Satellite, Cable, Terrestrial Set-top box, or Other Video Source .....	30
Connecting a Game Console .....	31
Connecting a Camcorder or Other Device .....	32
Connecting a Portable Audio player .....	32
Connecting a CD Player or Turntable .....	33
Connecting a Cassette, CDR, MiniDisc, or DAT Recorder .....	34
Connecting an RI Dock .....	35
Connecting a Dock with the Universal Port connector .....	35
Connecting Onkyo <b>RI</b> Components .....	36
Connecting the Power Cord .....	36

<b>Turning On &amp; First Time Setup</b>	
Turning On the AV Receiver .....	37
Turning On and Standby .....	37
First Time Setup .....	38
Using the Onscreen Setup Menus .....	38
Using the Display to change the settings .....	38
Video Input Setup .....	39
Digital Input Setup .....	41
Speaker Settings .....	42
FM/AM Frequency Step Setup .....	43
Changing the Input Display .....	44
Audyssey 2EQ™ Room Correction and Speaker Setup .....	45

<b>Basic Operations</b>	
Basic Operations .....	50
Selecting the Input Source .....	50
Adjusting the Bass & Treble .....	51
Displaying Source Information .....	51
Setting the Display Brightness .....	51
Muting the AV receiver .....	52
Using the Sleep Timer .....	52
Using Headphones .....	52

Listening to the Radio .....	53
Using the Tuner .....	53
Presetting AM/FM Stations .....	54
UP-A1 series Dock for iPod .....	55
About the UP-A1 series Dock .....	55
Compatible iPod models .....	55
Putting Your iPod in the Dock .....	55
Function Overview .....	55
Controlling iPod .....	56
Recording .....	58

<b>Using the Listening Modes</b>	
Using the Listening Modes .....	59
Selecting Listening Modes .....	59
Listening Modes Available for Each Source Format .....	60
About the Listening Modes .....	64

<b>Advanced Setup</b>	
Advanced Setup .....	66
Onscreen Setup Menus .....	66
Common Procedures in Setup Menu .....	67
Speaker Setup .....	67
Audio Adjust .....	70
Using the Audio Settings .....	72
Assigning Listening Modes to Input Sources .....	74
Source Setup .....	75
Miscellaneous (Volume/OSD) Setup .....	77
Hardware Setup .....	78
Lock Setup .....	80
Using the Video Settings .....	80
Digital Input Signal Formats .....	81

<b>Zone 2</b>	
Zone 2 .....	82
Connecting Zone 2 .....	82
Setting the Powered Zone 2 .....	83
Using Zone 2 .....	84

<b>Controlling Other Components</b>	
Controlling Other Components .....	86
Preprogrammed Remote Control Codes .....	86
Looking up for Remote Control Code .....	86
Entering Remote Control Codes .....	88
Remote Control Codes for Onkyo Components	
Connected via <b>RI</b> .....	89
Resetting REMOTE MODE Buttons .....	89
Resetting the Remote Controller .....	89
Controlling a TV .....	90
Controlling a DVD/BD Player, or DVD/BD Recorder .....	91
Controlling a VCR or PVR .....	92
Controlling a Satellite Receiver or Cable Receiver .....	93
Controlling a CD Player .....	94
Controlling an RI Dock .....	95
Controlling a Cassette Recorder .....	96

<b>Others</b>	
Troubleshooting .....	97
Specifications .....	101
Video Resolution Chart .....	102

\* To reset the AV receiver to its factory defaults, turn it on and, while holding down the [VCR/DVR] button, press the [ON/STANDBY] button (see page 97).

# Features

## Amplifier

- 80 Watts/Channel @ 8 ohms
- 130 Watts/Channel @ 6 ohms
- WRAT-Wide Range Amplifier Technology
- Optimum Gain Volume Circuitry
- H.C.P.S. (High Current Power Supply) Massive High Power Transformer

## Processing

- HDMI Video Upscaling (to 1080i Compatible) with Faroudja DCDi Edge Enhancement
- HDMI ver.1.3a with Repeater System (Deep Color, x.v.Color, Lip Sync, DTS<sup>\*1</sup>-HD Master Audio, DTS-HD High Resolution Audio, Dolby TrueHD<sup>\*2</sup>, Dolby Digital Plus, DSD and Multi-CH PCM)
- Dolby Pro Logic IIz<sup>\*2</sup> (with “Front High” Direction Mode)
- Non-Scaling Configuration
- A-Form Listening Mode Memory
- Direct Mode
- Music Optimizer<sup>\*3</sup> for Compressed Music
- 192 kHz/24-bit D/A Converters
- Powerful and Highly Accurate 32-bit DSP Processing

## Connections

- 5 HDMI<sup>\*4</sup> Inputs and 1 Output
- Onkyo **RIHD** for System Control
- 4 Digital Inputs (2 Optical / 2 Coaxial)
- Component Video Switching (2 Inputs/1 Output)
- Front “Portable” Input for iPod and MP3 Players
- Universal Port for the Dock for the iPod/HD Radio<sup>TM\*5</sup> Dock
- Dual Subwoofer Pre Out
- Banana Plug-Compatible Speaker Posts
- Powered Zone 2 and Zone 2 Line Out
- Bi-Amp Capability for Music and Movie Sound Effects

## Miscellaneous

- 40 AM/FM Presets
- Audyssey 2EQ<sup>TM\*6</sup> to Correct Room Acoustic Problems
- Audyssey Dynamic EQ<sup>TM\*6</sup> for Loudness Correction
- Audyssey Dynamic Volume<sup>TM\*6</sup> to Maintain Optimal Listening Level and Dynamic Range
- Crossover Adjustment (40/50/60/70/80/90/100/120/150/200 Hz)
- A/V Sync Control Function (up to 100 ms in 10 ms steps)
- On-Screen Display via HDMI
- Aluminum Front Panel
- Preprogrammed (with On-Screen Display Set-up) **RI**-Compatible Remote

\*1.  **DTS-HD Master Audio**  
Manufactured under license under U.S. Patent #'s: 5,451,942; 5,956,674; 5,974,380; 5,978,762; 6,226,616; 6,487,535; 7,212,872; 7,333,929; 7,392,195; 7,272,567 & other U.S. and worldwide patents issued & pending. DTS is a registered trademark and the DTS logos, Symbol, DTS-HD and DTS-HD Master Audio are trademarks of DTS, Inc. ©1996-2008 DTS, Inc. All Rights Reserved.

\*2.  **DOLBY TRUEHD PRO LOGIC IIz**  
Manufactured under license from Dolby Laboratories. “Dolby”, “Pro Logic” and the double-D symbol are trademarks of Dolby Laboratories.

\*3. Music Optimizer<sup>TM</sup> is a trademark of Onkyo Corporation.

\*4. **HDMI**  
HDMI, the HDMI logo and High Definition Multimedia Interface are trademarks or registered trademarks of HDMI Licensing, LLC.

\*5.  **HD Radio Ready**  
HD Radio<sup>TM</sup> and the HD Radio Ready logo are proprietary trademarks of iBiquity Digital Corporation. To receive HD Radio broadcasts, you must install an Onkyo UP-HT1 HD Radio tuner module (sold separately).

\*6.  **AUDYSSEY 2EQ DYNAMIC VOLUME**  
Manufactured under license from Audyssey Laboratories. U.S. and foreign patents pending. Audyssey 2EQ<sup>TM</sup>, Audyssey Dynamic Volume<sup>TM</sup> and Audyssey Dynamic EQ<sup>TM</sup> are trademarks of Audyssey Laboratories.

\* Apple and iPod are trademarks of Apple Inc., registered in the U.S. and other countries.

\* “x.v.Color” is a trademark of Sony Corporation.

# Multiroom Capability

You can use two speaker systems with this AV receiver—a surround-sound speaker system (up to 7.1 channels) in your main listening room, a stereo speaker system in a second room, or Zone 2, as we call it. And, you can select a different audio source for each room.

**Main Room:** In your main listening room, you can enjoy up to 7.1-channel playback (see page 14).

You can enjoy the various listening modes such as Dolby and DTS (see pages 59-65).

\* While Powered Zone 2 is being used, playback is reduced to 5.1-channels (see page 82).

**Zone 2:** In your Zone 2 room, you can enjoy 2-channel stereo playback (see page 82).

\* The listening modes cannot be used with Zone 2.

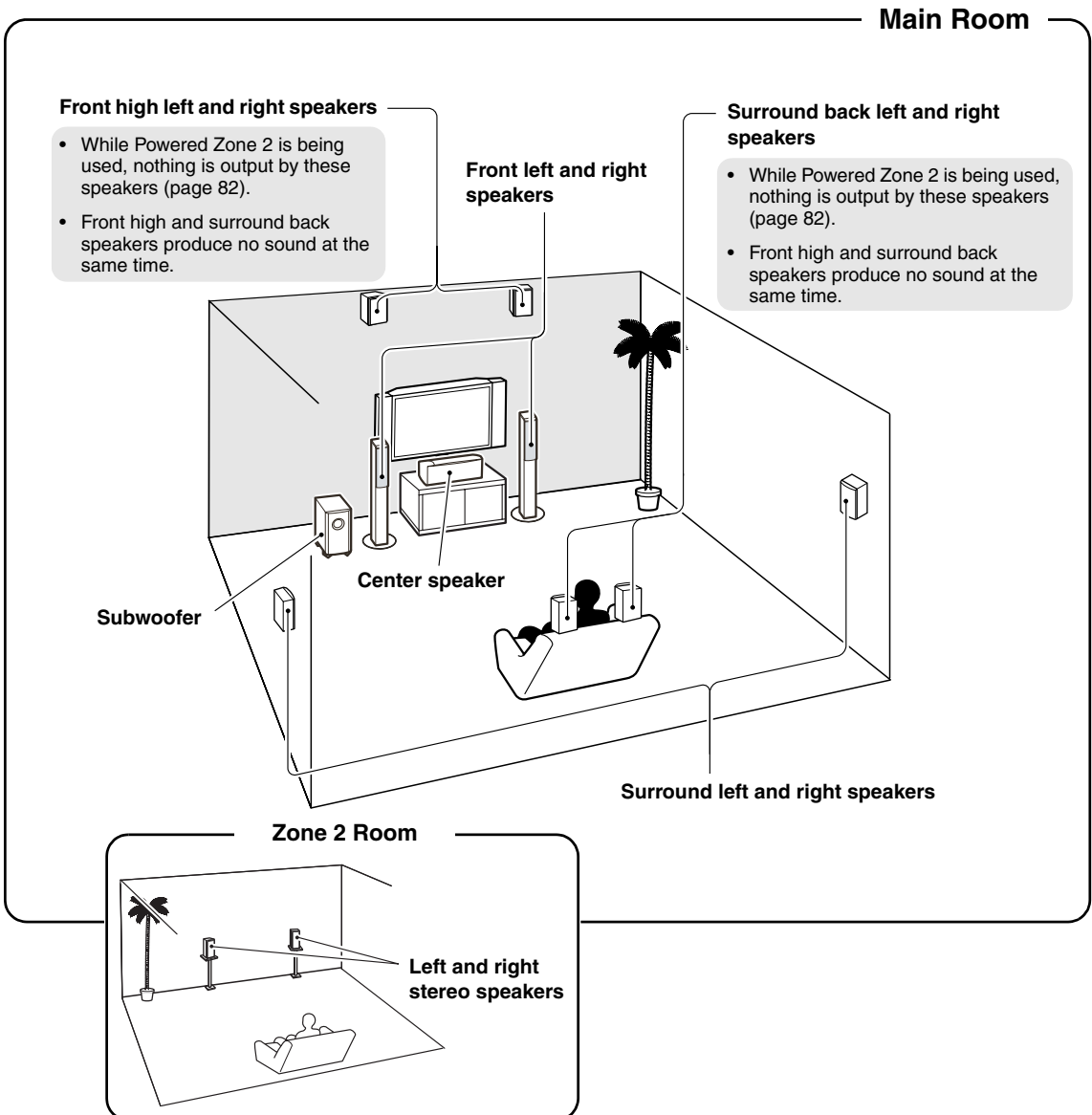

# Front & Rear Panels

## Front Panel

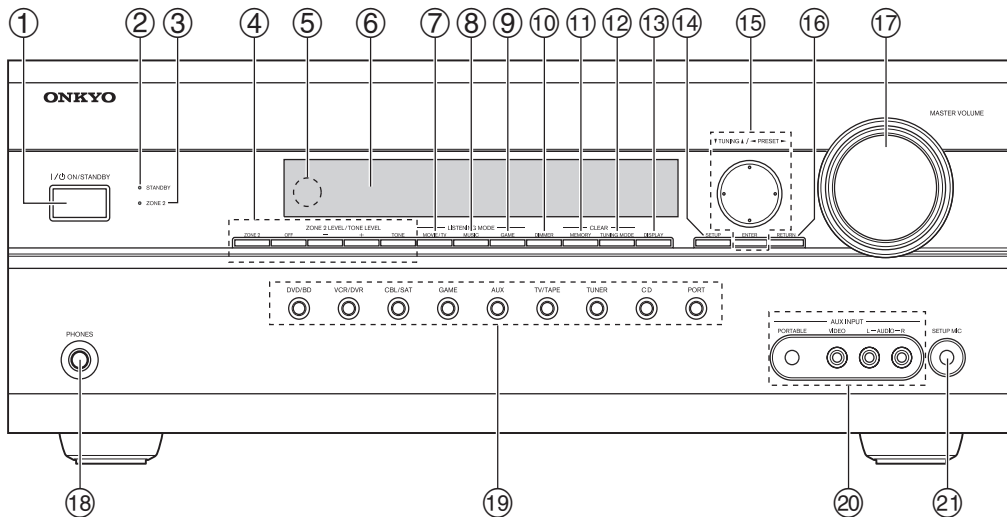

The actual front panel has various logos printed on it. They are not shown here for clarity.

The page numbers in parentheses show where you can find the main explanation for each item.

- ① **ON/STANDBY button (37)**  
This button is used to set the AV receiver to On or Standby.
- ② **STANDBY indicator (37)**  
This indicator lights up when the AV receiver is in Standby mode, and it flashes while a signal is being received from the remote controller.
- ③ **ZONE 2 indicator (84)**  
This indicator lights up when Zone 2 is selected.
- ④ **ZONE 2 LEVEL/TONE LEVEL buttons**  
**ZONE 2 and OFF buttons (84)**  
The [ZONE 2] button is used to turn on the output of Zone 2.  
The [OFF] button is used to turn off the output of Zone 2.  
**[-] & [+] buttons (51, 85)**  
Used to adjust the tone (bass and treble), and the level of Zone 2.  
**TONE button (51)**  
Used to select either bass or treble.
- ⑤ **Remote control sensor (12)**  
This sensor receives control signals from the remote controller.
- ⑥ **Display**  
See "Display" on page 9.
- ⑦ **MOVIE/TV button (59)**  
Selects the listening modes intended for use with movies and TV.
- ⑧ **MUSIC button (59)**  
Selects the listening modes intended for use with music.
- ⑨ **GAME button (59)**  
Selects the listening modes intended for use with video games.
- ⑩ **DIMMER button (51)**  
This button is used to adjust the display brightness.
- ⑪ **MEMORY button (54)**  
This button is used when storing or deleting radio presets.
- ⑫ **TUNING MODE button (53)**  
This button is used to select the Auto or Manual tuning mode.
- ⑬ **DISPLAY button (51)**  
This button is used to display various information about the currently selected input source.
- ⑭ **SETUP button**  
This button is used to access the onscreen setup menus that appear on the connected TV.
- ⑮ **Arrow, TUNING, PRESET and ENTER buttons**  
When the AM or FM input source is selected, the TUNING [▲]/[▼] buttons are used to tune the tuner, and the PRESET [◀]/[▶] buttons are used to select radio presets (see pages 53, 54).  
When the onscreen setup menus are used, they work as arrow buttons and are used to select and set items. The [ENTER] button is also used with the onscreen setup menus.
- ⑯ **RETURN button**  
This button is used to return to the previously displayed onscreen setup menu.

## Front & Rear Panels—Continued

### 17 MASTER VOLUME control (50)

This control is used to adjust the volume of the AV receiver to Min, 1 through 79 or Max.

### 18 PHONES jack (52)

This 1/4-inch phone jack is for connecting a standard pair of stereo headphones for private listening.

### 19 Input selector buttons (50)

These buttons are used to select from the following input sources: DVD/BD, VCR/DVR, CBL/SAT, GAME, AUX, TV/TAPE, TUNER, CD, PORT.

### 20 AUX INPUT (32)

This input can be used to connect a camcorder, game console, and so on. There are jacks for composite video, and analog audio.

### PORTABLE (32):

Used to connect a portable Audio Player.

### 21 SETUP MIC jack (46)

The Audyssey 2EQ™ Room Correction and Speaker Setup microphone connects here.

## Display

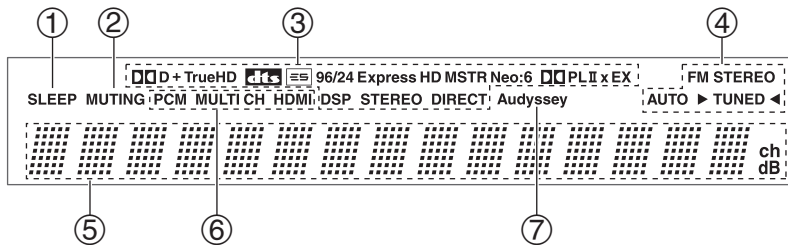

For detailed information, see the pages in parentheses.

### 1 SLEEP indicator (52)

Lights up when the Sleep function has been set.

### 2 MUTING indicator (52)

Flashes while the AV receiver is muted.

### 3 Listening mode and format indicators (59)

Show the selected listening mode and audio input signal format.

### 4 Tuning indicators (53)

#### AUTO (53):

Lights up when Auto Tuning mode is selected for AM or FM radio. Goes off when Manual Tuning mode is selected.

#### TUNED (53):

Lights up when tuned to a radio station.

#### FM STEREO (53):

Lights up when tuned to a stereo FM station.

### 5 Message area

Displays various information.

### 6 Audio input indicators

Indicate the type of audio input that's selected as the audio source: PCM, MULTI CH, or HDMI.

### 7 Audyssey indicator (45, 69)

Flashes during Audyssey 2EQ™ Room Correction and Speaker Setup. Lights up when the "Equalizer Settings" is set to "Audyssey".

## Rear Panel

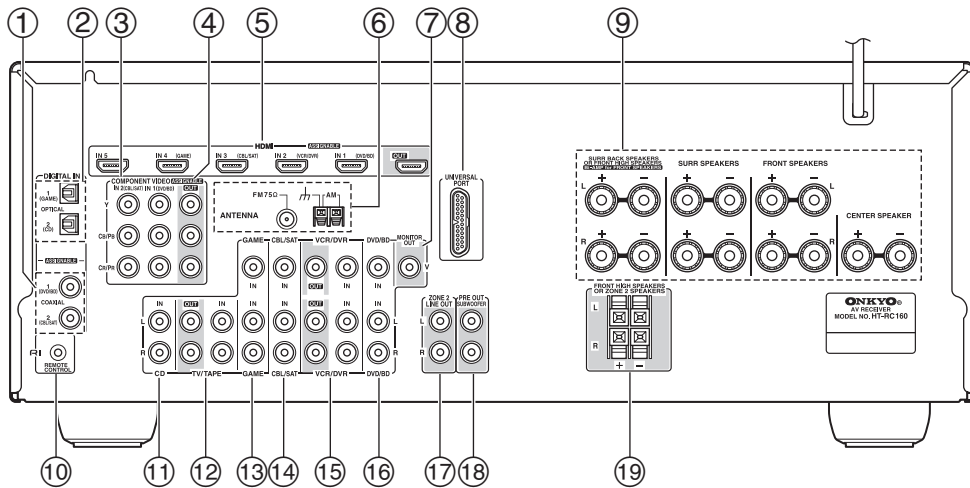

**① DIGITAL IN COAXIAL 1 and 2**

These coaxial digital audio inputs are for connecting components with coaxial digital audio outputs, such as CD and DVD/BD players. They're assignable, which means you can assign each one to an input selector to suit your setup. See "Digital Input Setup" on page 41.

**② DIGITAL IN OPTICAL 1 and 2**

These optical digital audio inputs are for connecting components with optical digital audio outputs, such as CD and DVD/BD players. They're assignable, which means you can assign each one to an input selector to suit your setup. See "Digital Input Setup" on page 41.

**③ COMPONENT VIDEO IN 1 and 2**

These RCA component video inputs are for connecting components with a component video output, such as a DVD/BD player, DVD/BD recorder, or DVR (digital video recorder). They're assignable, which means you can assign each one to an input selector to suit your setup. See "Component Video Setup" on page 40.

**④ COMPONENT VIDEO OUT**

This RCA component video output is for connecting a TV or projector with a component video input.

**⑤ HDMI IN 1–5 and OUT**

HDMI (High Definition Multimedia Interface) connections carry digital audio and digital video. The HDMI inputs are for connecting components with an HDMI output, such as a DVD/BD player, DVD/BD recorder, or DVR (digital video recorder). They're assignable, which means you can assign each one to an input selector to suit your setup. See "HDMI Input Setup" on page 39. The HDMI output is for connecting a TV or projector with an HDMI input.

**⑥ FM ANTENNA**

This jack is for connecting an FM antenna.

**AM ANTENNA**

These push terminals are for connecting an AM antenna.

**⑦ MONITOR OUT V**

The composite video jack should be connected to a video input on your TV or projector.

**⑧ UNIVERSAL PORT**

This jack is for connecting the component with the Universal Port connector such as UP-A1 series Dock.

**⑨ FRONT L/R, CENTER, SURR L/R, and SURR BACK L/R speakers**

These terminal posts are for connecting the front L/R, center, surround L/R, surround back L/R, and front high L/R speakers.

The FRONT L/R and SURR BACK L/R terminal posts can be used with front speakers and surround back speakers respectively, or used to bi-amp the front speakers. See "Bi-amping the Front Speakers" on page 18".

The SURR BACK L/R terminals can be used to connect the front high L/R speakers. See "Speaker Settings" on page 42.

**⑩ RI REMOTE CONTROL**

This **RI** (Remote Interactive) jack can be connected to an **RI** jack on another Onkyo AV component. The AV receiver's remote controller can then be used to control that component. To use **RI**, you must make an analog audio connection (RCA) between the AV receiver and the other AV component, even if they are connected digitally.

## Front & Rear Panels—Continued

---

- ⑪ **CD IN**  
This analog audio input is for connecting a CD player's analog audio output.
- ⑫ **TV/TAPE IN/OUT**  
This analog audio input and output are for connecting a recorder with an analog audio input and output (cassette, Mini Disc, etc.).
- ⑬ **GAME IN**  
Here you can connect a game console, etc. Input jacks include composite video and analog audio.
- ⑭ **CBL/SAT IN**  
Here you can connect a cable/satellite receiver, set-top box, etc. Input jacks include composite video and analog audio.
- ⑮ **VCR/DVR IN/OUT**  
Here you can connect a VCR or DVR (digital video recorder). Input and output jacks include composite video and analog audio.
- ⑯ **DVD/BD IN**  
Here you can connect a DVD/BD player. Input jacks include composite video and analog audio.  
You can connect a DVD/BD player's 2-channel analog audio output.
- ⑰ **ZONE 2 LINE OUT L/R**  
This analog audio output can be connected to a line input on an integrated amplifier in Zone 2. See "Connecting Zone 2" on page 82.
- ⑱ **PRE OUT: SUBWOOFER**  
This analog audio outputs can be connected to a powered subwoofer. The same signal is output from each jack. You can connect the powered subwoofer with two SUBWOOFER PREOUT jacks respectively.
- ⑲ **FRONT HIGH L/R speakers**  
These terminals are for connecting the front high L/R speakers.  
The FRONT HIGH L/R terminal can be used with front high speakers respectively, or used to connect the speakers in Zone 2.  
See "Connecting Zone 2" on page 82.

See pages 15-36 for connection information.

# Remote Controller

## Installing the Batteries

- 1 To open the battery compartment, press the small lever and remove the cover.**

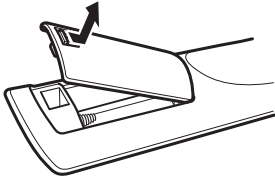

- 2 Insert the two supplied batteries (AA/R6) in accordance with the polarity diagram inside the battery compartment.**

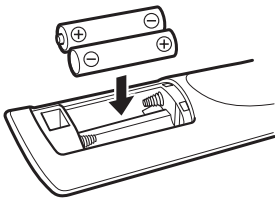

- 3 Replace the cover and push it shut.**

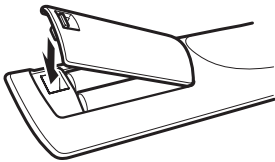

### Notes:

- If the remote controller doesn't work reliably, try replacing the batteries.
- Don't mix new and old batteries or different types of batteries.
- If you intend not to use the remote controller for a long time, remove the batteries to prevent damage from leakage or corrosion.
- Expired batteries should be removed as soon as possible to prevent damage from leakage or corrosion.

## Aiming the Remote Controller

To use the remote controller, point it at the AV receiver's remote control sensor, as shown below.

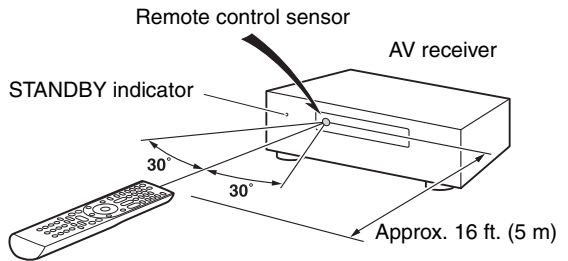

### Notes:

- The remote controller may not work reliably if the AV receiver is subjected to bright light, such as direct sunlight or inverter-type fluorescent lights. Keep this in mind when installing.
- If another remote controller of the same type is used in the same room, or the AV receiver is installed close to equipment that uses infrared rays, the remote controller may not work reliably.
- Don't put anything, such as a book, on the remote controller, because the buttons may be pressed inadvertently, thereby draining the batteries.
- The remote controller may not work reliably if the AV receiver is installed in a rack behind colored glass doors. Keep this in mind when installing.
- The remote controller will not work if there's an obstacle between it and the AV receiver's remote control sensor.
- When the remote control codes have been registered and you want to operate another component (page 86), or when you want to operate an Onkyo component without **RI** connection, point the remote controller at the other component to use it.
- When you want to operate an Onkyo component with **RI** connection or an **RIHD**-compatible component connected via HDMI (pages 90, 91), point the remote controller at the AV receiver's remote control sensor.



## Controlling the AV Receiver

To control the AV receiver, press the **[RECEIVER]** button to select Receiver mode. You can also use the remote controller to control your DVD/BD player, CD player, and other components. See page 88 for more details.

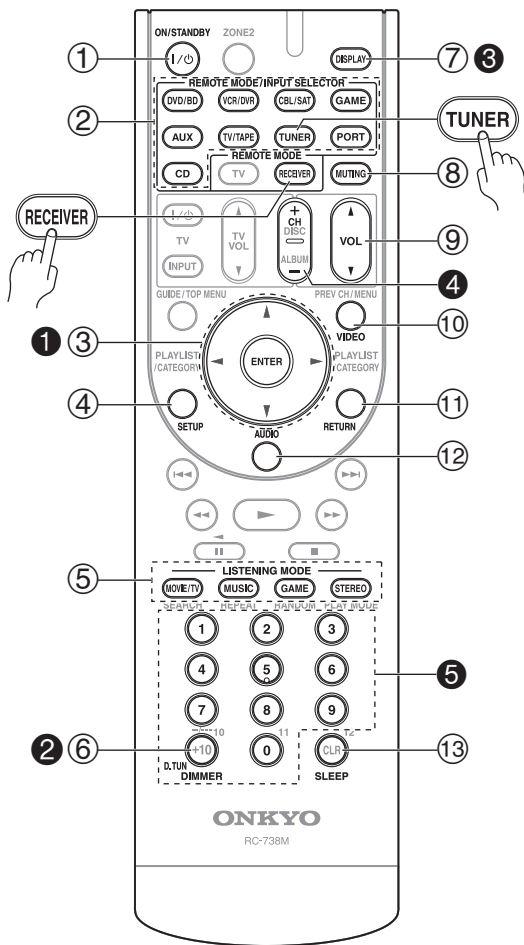

For detailed information, see the pages in parentheses.

- ① **ON/STANDBY button (37)**  
Sets the AV receiver to On or Standby.
- ② **REMOTE MODE/INPUT SELECTOR buttons (50, 90–96)**  
Selects the remote controller modes and the input sources.
- ③ **Arrow [▲]/[▼]/[◀]/[▶] and ENTER buttons**  
Used to select and adjust settings.
- ④ **SETUP button**  
Used to change settings.

- ⑤ **LISTENING MODE buttons (59)**  
Used to select the listening modes.
- ⑥ **DIMMER button (51)**  
Adjusts the display brightness.
- ⑦ **DISPLAY button (51)**  
Displays information about the current input source.
- ⑧ **MUTING button (52)**  
Mutes or unmutes the AV receiver.
- ⑨ **VOL [▲]/[▼] button (50)**  
Adjusts the volume of the AV receiver regardless of the currently selected remote controller mode.
- ⑩ **VIDEO button (80)**  
Used to change video settings.
- ⑪ **RETURN button**  
Returns to the previous display when changing settings.
- ⑫ **AUDIO button (72)**  
Used to change audio settings.  
When the “Audio TV Out” setting is set to “On” (page 78), this button is disabled.
- ⑬ **SLEEP button (52)**  
Used with the Sleep function.

### ■ Controlling the tuner

To control the AV receiver’s tuner, press the **[TUNER]** (or **[RECEIVER]**) button.

You can select AM or FM by pressing the **[TUNER]** button repeatedly.

- ① **Arrow [▲]/[▼] buttons**  
Used to tune into radio stations.
- ② **D.TUN button (53)**  
Selects the Direct tuning mode.
- ③ **DISPLAY button**  
Displays information about the band, frequency, preset number, and so on.
- ④ **CH +/- button (54)**  
Used to select radio presets.
- ⑤ **Number buttons (53)**  
Used to select radio stations directly in the Direct tuning mode. Also you can select a preset directly.

### Note:

An Onkyo cassette recorder connected via **RI** can also be controlled in Receiver mode (see page 96).

# About Home Theater

## Enjoying Home Theater

Thanks to the AV receiver's superb capabilities, you can enjoy surround sound with a real sense of movement in your own home—just like being in a movie theater or concert hall. With DVDs you can enjoy DTS and Dolby Digital. With analog or digital TV, you can enjoy Dolby Pro Logic IIx, DTS Neo:6, or Onkyo's original DSP listening modes.

### Front left and right speakers

These output the overall sound. Their role in a home theater is to provide a solid anchor for the sound image. They should be positioned facing the listener at about ear level, and equidistant from the TV. Angle them inward so as to create a triangle, with the listener at the apex.

### Front high left and right speakers

These speakers are necessary to enjoy Dolby Pro Logic IIz Height, etc. They enhance significantly the spatial experience.

Position them at least 3.3 feet (100 cm) above the front left and right speakers (and as high as possible). Although it is acceptable to place left and right at an angle slightly wider than the front left and right speakers. Ideally they should be positioned directly above the front left and right speakers. Front high and surround back speakers produce no sound at the same time.

### Center speaker

This speaker enhances the front left and right speakers, making sound movements distinct and providing a full sound image. In movies it's used mainly for dialog.

Position it close to your TV facing forward at about ear level, or at the same height as the front left and right speakers.

### Subwoofer

The subwoofer handles the bass sounds of the LFE (Low-Frequency Effects) channel. The volume and quality of the bass output from your subwoofer will depend on its position, the shape of your listening room, and your listening position. In general, a good bass sound can be obtained by installing the subwoofer in a front corner, or at one-third the width of the wall, as shown.

You can connect the powered subwoofer with two SUBWOOFER PREOUT jacks respectively.

**Tip:** To find the best position for your subwoofer, while playing a movie or some music with good bass, experiment by placing your subwoofer at various positions within the room, and choose the one that provides the most satisfying results.

### Surround back left and right speakers

These speakers are necessary to enjoy Dolby Digital EX, DTS-ES Matrix, DTS-ES Discrete, etc. They enhance the realism of surround sound and improve sound localization behind the listener. Position them behind the listener about 2–3 feet (60–100 cm) above ear level. Front high and surround back speakers produce no sound at the same time.

### Surround left and right speakers

These speakers are used for precise sound positioning and to add realistic ambience.

Position them at the sides of the listener, or slightly behind, about 2–3 feet (60–100 cm) above ear level. Ideally they should be equidistant from the listener.

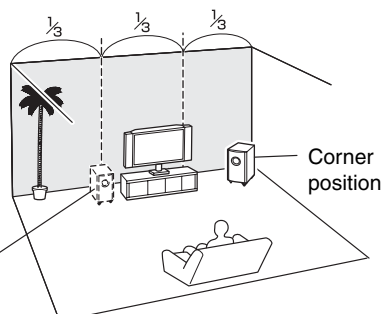
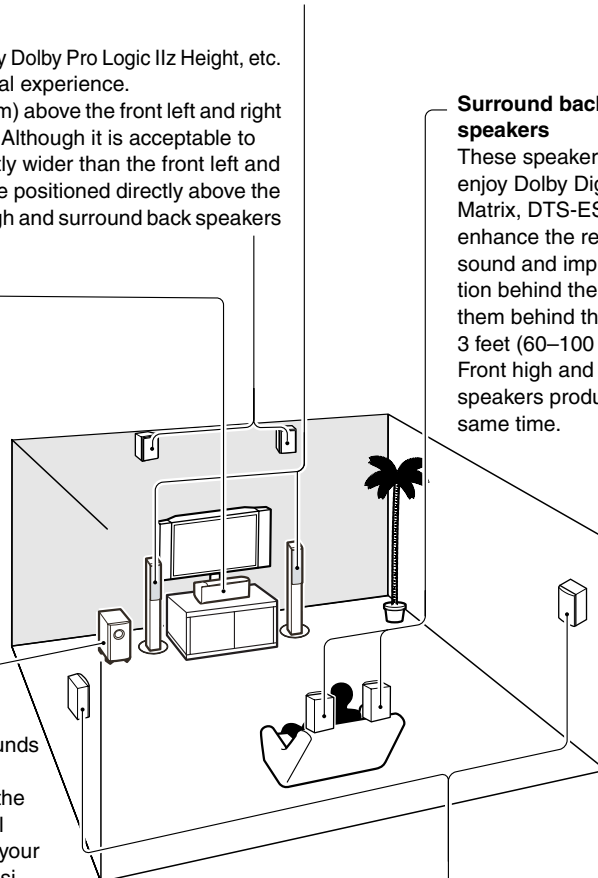

# Connecting the AV Receiver

## Connecting Your Speakers

### Speaker Configuration

For 7.1-channel surround-sound playback, you need seven speakers and a powered subwoofer.

The following table indicates the channels you should use depending on the number of speakers that you have.

Number of speakers:	2	3	4	5	6	7	7	8	9
Front left	✓	✓	✓	✓	✓	✓	✓	✓	✓
Front right	✓	✓	✓	✓	✓	✓	✓	✓	✓
Center		✓		✓	✓	✓	✓	✓	✓
Surround left			✓	✓	✓	✓	✓	✓	✓
Surround right			✓	✓	✓	✓	✓	✓	✓
Surround back*					✓			✓	
Surround back left						✓			✓
Surround back right						✓			✓
Front high left							✓	✓	✓
Front high right							✓	✓	✓

\* If you're using only one surround back speaker, connect it to the SURR BACK L terminals.

No matter how many speakers you use, a powered subwoofer is recommended for a really powerful and solid bass.

To get the best from your surround sound system, you need to set the speaker settings. You can do this automatically (see page 45) or manually (see page 67).

#### Note:

Front high and surround back speakers produce no sound at the same time.

### Attaching the Speaker Labels

The AV receiver's positive (+) speaker terminals are all red (the negative (-) speaker terminals are all black).

Speaker	Color
Front left, Zone 2 left	White
Front right, Zone 2 right	Red
Center	Green
Surround left	Blue
Surround right	Gray
Surround back left	Brown
Surround back right	Tan
Front high left	White
Front high right	Red

The supplied speaker cable labels are also color-coded and you should attach them to the positive (+) side of each speaker cable in accordance with the above table. Then all you need to do is to match the color of each label to the corresponding speaker terminal.



- Speaker cable labels is not supplied with the HT-S7200 Home Theater System.
- If you are using banana plugs, tighten the speaker terminal before inserting the banana plug.
- Do not insert the speaker code directly into the center hole of the speaker terminal.

### Using Dipole Speakers

You can use dipole speakers for the surround left and right, surround back left and right and front high left and right speakers. Dipole speakers output the same sound in two directions.

Dipole speakers typically have an arrow printed on them to indicate how they should be positioned. The surround left and right dipole speakers should be positioned so that their arrows point toward the TV/screen, while the surround back left and right and front high left and right dipole speakers should be positioned so that their arrows point toward each other, as shown.

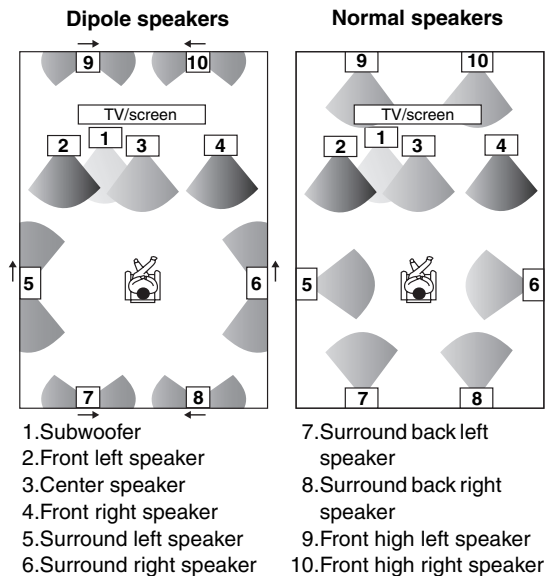

## Connecting the AV Receiver—Continued

### Connecting a Powered Subwoofer

Using a suitable cable, connect the AV receiver's PRE OUT: SUBWOOFER to an input on your powered subwoofer, as shown. If your subwoofer is unpowered and you're using an external amplifier, connect the PRE OUT: SUBWOOFER to an input on the amp.

You can connect the powered subwoofer with two SUBWOOFER PREOUT jacks respectively.

The same signal is output from each jack.

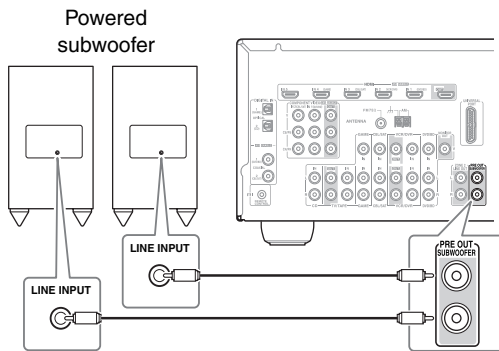

### Speaker Connection Precautions

Read the following before connecting your speakers:



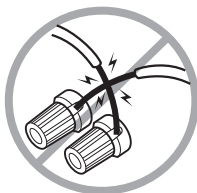

- You can connect speakers with an impedance of between 6 and 16 ohms. If you use speakers with a lower impedance, and use the amplifier at high volume levels for a long period of time, the built-in amp protection circuit may be activated.
- Disconnect the power cord from the wall outlet before making any connections.
- Read the instructions supplied with your speakers.
- Pay close attention to speaker wiring polarity. In other words, connect positive (+) terminals only to positive (+) terminals, and negative (-) terminals only to negative (-) terminals. If you get them the wrong way around, the sound will be out of phase and will sound unnatural.
- Unnecessarily long, or very thin speaker cables may affect the sound quality and should be avoided.
- If you use 4 or 5 speakers, connect each of the two surround speakers to the SURR L/R terminals. Do not connect them to the SURR BACK L/R or FRONT HIGH L/R terminals.
- Be careful not to short the positive and negative wires. Doing so may damage the AV receiver.
- Make sure the metal core of the wire does not have contact with the AV receiver's rear panel. Doing so may damage the AV receiver.

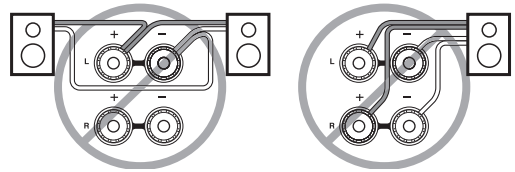

- Don't connect more than one cable to each speaker terminal. Doing so may damage the AV receiver.
- Don't connect one speaker to several terminals.

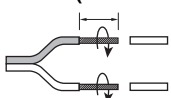

### Connecting the Speaker Cables

- Strip 1/2"-5/8" (12-15 mm) of insulation from the ends of the speaker cables, and twist the bare wires tightly, as shown.** 
- Unscrew the terminal.** 
- Fully insert the bare wires.** 
- Screw the terminal tight.** 

#### FRONT HIGH L/R, ZONE 2 L/R

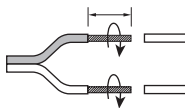
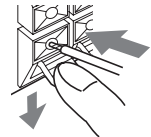
- Strip 3/8"-1/2" (10-12 mm) of insulation from the ends of the speaker cables, and twist the bare wires tightly, as shown.** 
- While pressing the lever, insert the wire into the hole, and then release the lever. Make sure that the terminals are gripping the bare wires, not the insulation.** 

## Connecting the AV Receiver—Continued

The following illustration shows which speaker should be connected to each pair of terminals. If you're using only one surround back speaker, connect it to the left (L) SURR BACK SPEAKERS terminals.

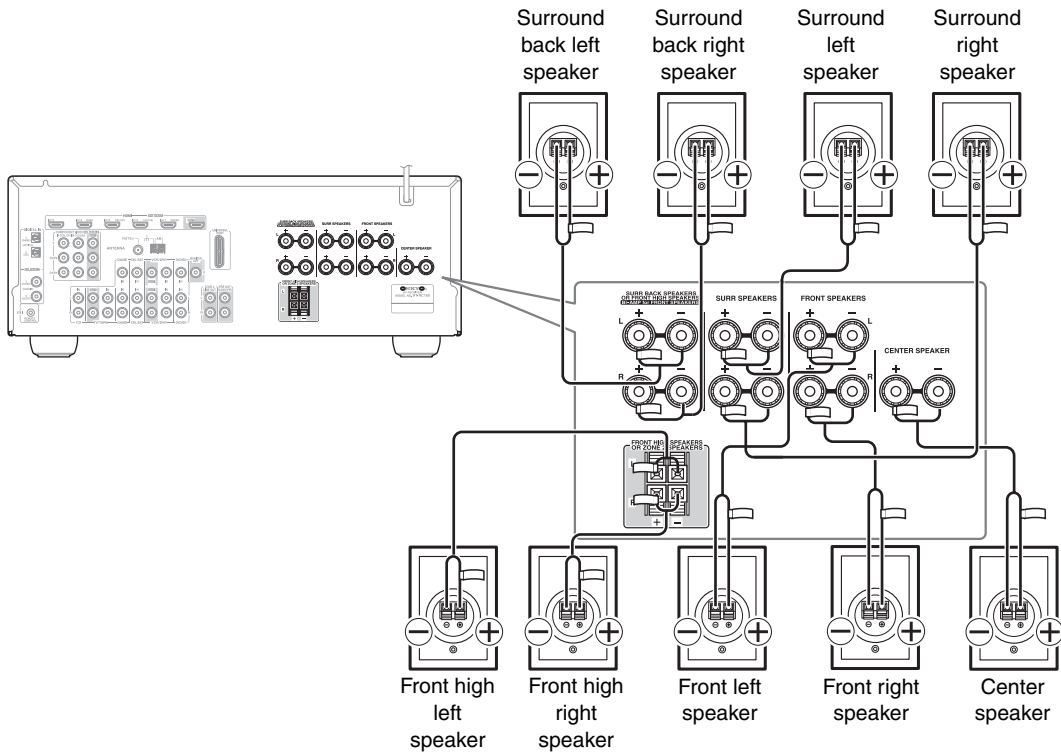

## Bi-amping the Front Speakers

The FRONT L/R and SURR BACK L/R terminal posts can be used with front speakers and surround back speakers respectively, or bi-amped to provide separate tweeter and woofer feeds for a pair of front speakers that support bi-amping, providing improved bass and treble performance.

- When bi-amping is used, the AV receiver is able to drive up to 5.1 speakers in the main room.
- For bi-amping, the FRONT L/R terminal posts connect to the front speakers' woofer terminals. And the SURR BACK L/R terminal posts connect to the front speakers' tweeter terminals.
- Once you've completed the bi-amping connections shown below and turned on the AV receiver, you must set the "Speaker Type" setting to "Bi-Amp" to enable biamping (see page 42).

### Important:

- **When making the bi-amping connections, be sure to remove the jumper bars that link the speakers' tweeter (high) and woofer (low) terminals.**
- Bi-amping can only be used with speakers that support bi-amping. Refer to your speaker manual.

## Bi-amping Speaker Hookup

- 1 Connect the AV receiver's FRONT R positive (+) terminal to the right speaker's positive (+) Woofer (low) terminal. And connect the AV receiver's FRONT R negative (-) terminal to the right speaker's negative (-) Woofer (low) terminal.
- 2 Connect the AV receiver's SURR BACK R positive (+) terminal to the right speaker's positive (+) Tweeter (high) terminal. And connect the AV receiver's SURR BACK R negative (-) terminal to the right speaker's negative (-) Tweeter (high) terminal.
- 3 Connect the AV receiver's FRONT L positive (+) terminal to the left speaker's positive (+) Woofer (low) terminal. And connect the AV receiver's FRONT L negative (-) terminal to the left speaker's negative (-) Woofer (low) terminal.
- 4 Connect the AV receiver's SURR BACK L positive (+) terminal to the left speaker's positive (+) Tweeter (high) terminal. And connect the AV receiver's SURR BACK L negative (-) terminal to the left speaker's negative (-) Tweeter (high) terminal.

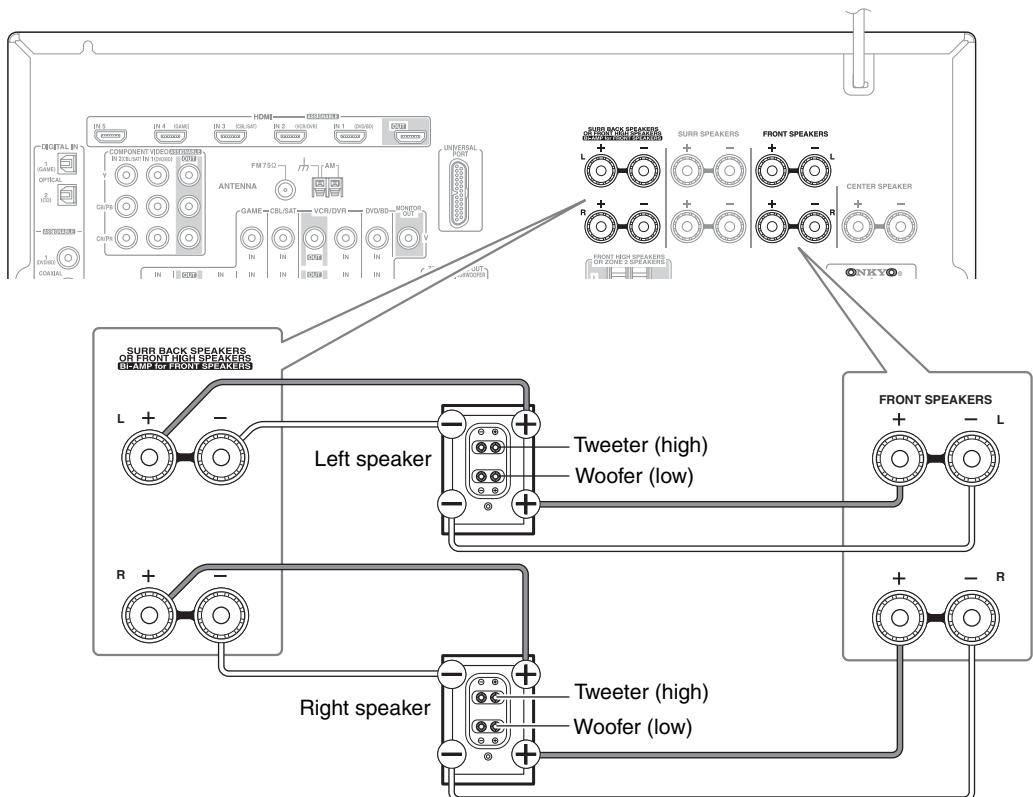

## Connecting the AV Receiver—Continued

### Connecting Antenna

This section explains how to connect the supplied indoor FM antenna and AM loop antenna, and how to connect commercially available outdoor FM and AM antennas. The AV Receiver won't pick up any radio signals without any antenna connected, so you must connect the antenna to use the tuner.

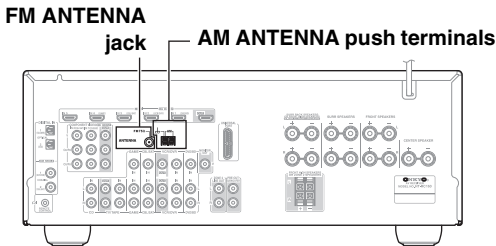

### Connecting the Indoor FM Antenna

The supplied indoor FM antenna is for indoor use only.

#### 1 Attach the FM antenna, as shown.

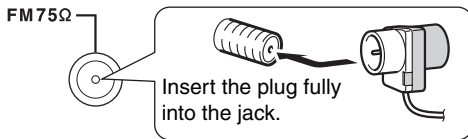

Once your AV Receiver is ready for use, you'll need to tune into an FM radio station and adjust the position of the FM antenna to achieve the best possible reception.

#### 2 Use thumbtacks or something similar to fix the FM antenna into position.

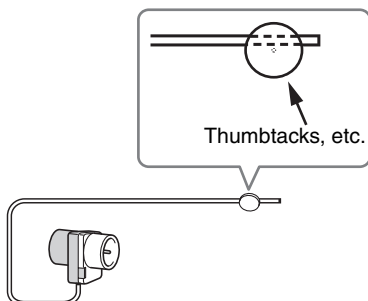

#### Caution:

Be careful that you don't injure yourself when using thumbtacks.

If you cannot achieve good reception with the supplied indoor FM antenna, try a commercially available outdoor FM antenna instead (see page 20).

### Connecting the AM Loop Antenna

The supplied indoor AM loop antenna is for indoor use only.

#### 1 Assemble the AM loop antenna, inserting the tabs into the base, as shown.

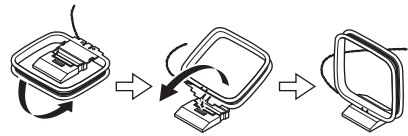

#### 2 Connect both wires of the AM loop antenna to the AM antenna push terminals, as shown.

(The antenna's wires are not polarity sensitive, so they can be connected either way around.) Make sure that the wires are attached securely and that the push terminals are gripping the bare wires, not the insulation.

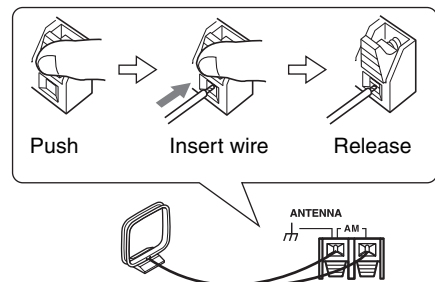

Once your AV Receiver is ready for use, you'll need to tune into an AM radio station and adjust the position of the AM antenna to achieve the best possible reception.

Keep the antenna as far away as possible from your AV Receiver, TV, speaker cables, and power cords.

If you cannot achieve good reception with the supplied indoor AM loop antenna, try using it with a commercially available outdoor AM antenna (see page 20).



## Connecting the AV Receiver—Continued

### Connecting an Outdoor FM Antenna

If you cannot achieve good reception with the supplied indoor FM antenna, try a commercially available outdoor FM antenna instead.

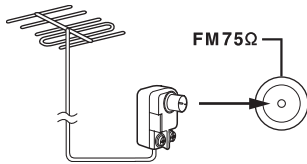

#### Notes:

- Outdoor FM antennas work best outside, but usable results can sometimes be obtained when installed in an attic or loft.
- For best results, install the outdoor FM antenna well away from tall buildings, preferably with a clear line of sight to your local FM transmitter.
- Outdoor antenna should be located away from possible noise sources, such as neon signs, busy roads, etc.
- For safety reasons, outdoor antenna should be situated well away from power lines and other high-voltage equipment.
- Outdoor antenna must be grounded in accordance with local regulations to prevent electrical shock hazards.

### ■ Using a TV/FM Antenna Splitter

It's best not to use the same antenna for both FM and TV reception, as this can cause interference problems. If circumstances demand it, use a TV/FM antenna splitter, as shown.

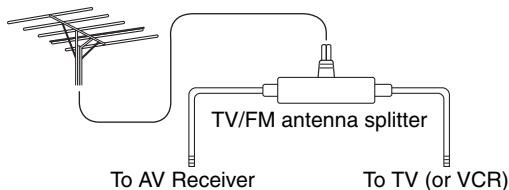

### Connecting an Outdoor AM Antenna

If good reception cannot be achieved using the supplied AM loop antenna, an outdoor AM antenna can be used in addition to the loop antenna, as shown.

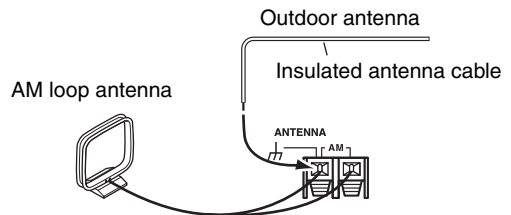

Outdoor AM antennas work best when installed outside horizontally, but good results can sometimes be obtained indoors by mounting horizontally above a window. Note that the AM loop antenna should be left connected. Outdoor antenna must be grounded in accordance with local regulations to prevent electrical shock hazards.



# Connecting the AV Receiver—Continued

## About AV Connections

- Before making any AV connections, read the manuals supplied with your other AV components.
- Don't connect the power cord until you've completed and double-checked all AV connections.

## Optical Digital Jacks

The AV receiver's optical digital jacks have shutter-type covers that open when an optical plug is inserted and close when it's removed. Push plugs in all the way.

### Caution:

To prevent shutter damage, hold the optical plug straight when inserting and removing.

## AV Connection Color Coding

RCA-type AV connections are usually color-coded: red, white, and yellow. Use red plugs to connect right-channel audio inputs and outputs (typically labeled "R"). Use white plugs to connect left-channel audio inputs and outputs (typically labeled "L"). And use yellow plugs to connect composite video inputs and outputs.

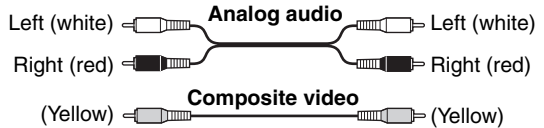

- Push plugs in all the way to make good connections (loose connections can cause noise or malfunctions).
- To prevent interference, keep audio and video cables away from power cords and speaker cables.

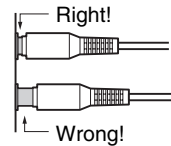

## AV Cables & Jacks

### Video / Audio

	Cable	Jack	Description
HDMI			HDMI connections can carry uncompressed standard- or high-definition digital video and audio and offer the best picture and sound quality.

### Video

Component video cable		  	Component video separates the luminance (Y) and color difference signals (PR, PB), providing the best picture quality (some TV manufacturers label their component video sockets slightly differently).
Composite video cable			Composite video is commonly used on TVs, VCRs, and other video equipment.

### Audio

Optical digital audio cable			Offers the best sound quality and allows you to enjoy surround sound (e.g., Dolby Digital, DTS). The audio quality is the same as for coaxial.
Coaxial digital audio cable			Offers the best sound quality and allows you to enjoy surround sound (e.g., Dolby Digital, DTS). The audio quality is the same as for optical.
Analog audio cable (RCA)		 	This cable carries analog audio. It's the most common connection format for analog audio, and can be found on virtually all AV components.
Stereo mini plug cable			This cable carries analog audio.

The AV receiver does not support SCART plugs.

### Connecting Components with HDMI

#### About HDMI

Designed to meet the increased demands of digital TV, HDMI (High Definition Multimedia Interface) is a new digital interface standard for connecting TVs, projectors, DVD/BD players, set-top boxes, and other video components. Until now, several separate video and audio cables have been required to connect AV components. With HDMI, a single cable can carry control signals, digital video, and up to eight channels of digital audio (2-channel PCM, multichannel digital audio, and multichannel PCM).

The HDMI video stream (i.e., video signal) is compatible with DVI (Digital Visual Interface)<sup>\*1</sup>, so TVs and displays with a DVI input can be connected by using an HDMI-to-DVI adapter cable. (This may not work with some TVs and displays, resulting in no picture.)

The AV receiver uses HDCP (High-bandwidth Digital Content Protection)<sup>\*2</sup>, so only HDCP-compatible components can display the picture.

The AV receiver's HDMI interface is based on the following standard:

**x.v.Color, Deep Color, Lip Sync, DTS-HD Master Audio, DTS-HD High Resolution Audio, Dolby TrueHD, Dolby Digital Plus, DSD, and Multichannel PCM**

#### Supported Audio Formats

- 2-channel linear PCM (32–192 kHz, 16/20/24 bit)
- Multichannel linear PCM (up to 7.1 ch, 32–192 kHz, 16/20/24 bit)
- Bitstream (DSD, Dolby Digital, Dolby Digital Plus, Dolby TrueHD, DTS, DTS-HD High Resolution Audio, DTS-HD Master Audio)

Your DVD/BD player must also support HDMI output of the above audio formats.

#### ■ Onkyo **RIHD** for System Control

**RIHD**, which stands for Remote Interactive over HDMI, is the name of the system control function found on Onkyo components. The AV receiver can be used with CEC (Consumer Electronics Control), which allows system control over HDMI and is part of the HDMI standard. CEC provides interoperability between various components, however, operation with components other than **RIHD**-compatible components cannot be guaranteed.

- Set “HDMI Control (RIHD)” to “On” (page 79).
- See “Controlling a TV” (page 90) and “Controlling a DVD/BD Player, or DVD/BD Recorder” (page 91) for operation.

#### Note:

Do not connect the **RIHD**-compatible component more than the following number to the HDMI input terminal so that the linked operations work properly.

- DVD/BD player is up to three.
- DVD/BD recorder is up to three.
- Cable/Satellite Set-top box is up to four.

Do not connect the AV receiver to the other AV receiver /AV amplifier via HDMI.

When the **RIHD**-compatible component more than the above-mentioned is connected, the linked operations are not guaranteed.

#### About Copyright Protection

The AV receiver supports HDCP (High-bandwidth Digital Content Protection)<sup>\*2</sup>, a copy-protection system for digital video signals. Other devices connected to the AV receiver via HDMI must also support HDCP.

\*1 DVI (Digital Visual Interface): The digital display interface standard set by the DDWG<sup>\*3</sup> in 1999.

\*2 HDCP (High-bandwidth Digital Content Protection): The video encryption technology developed by Intel for HDMI/DVI. It's designed to protect video content and requires a HDCP-compatible device to display the encrypted video.

\*3 DDWG (Digital Display Working Group): Lead by Intel, Compaq, Fujitsu, Hewlett Packard, IBM, NEC, and Silicon Image, this open industry group's objective is to address the industry's requirements for a digital connectivity specification for high-performance PCs and digital displays.

## Connecting the AV Receiver—Continued

### Making HDMI Connections

#### Step 1:

Use HDMI cables to connect the AV receiver's HDMI jacks to your HDMI-compatible Blu-ray player/DVD player, TV, projector, and so on.

#### Step 2:

Assign each HDMI IN to an input selector in the HDMI Input Setup (see page 39).

#### ■ Video Signals

Digital video signals received by the HDMI IN jacks are normally output by the HDMI OUT for display on your TV. Composite video and component video sources can be upconverted for the HDMI output. See “Video Connection Formats” on page 24 for more information.

#### ■ Audio Signals

Digital audio signals received by the HDMI IN jacks are output by the speakers and headphones connected to the AV receiver. Normally, they are not output by the HDMI OUT, unless the “Audio TV Out” setting is set to “On” (see page 78).



To listen to audio received by the HDMI IN jacks through your TV's speakers, set the “Audio TV Out” setting to “On” (see page 78), and set your DVD/BD player's HDMI audio output setting to PCM.

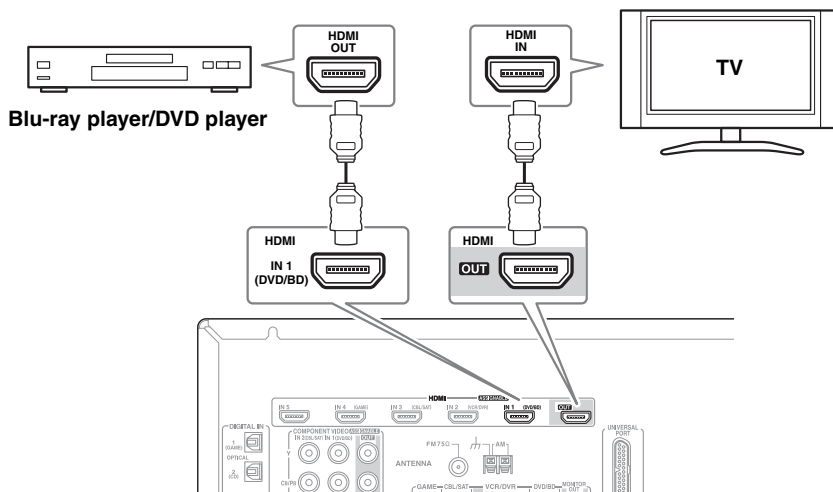

#### Notes:

- The HDMI video stream is compatible with DVI (Digital Visual Interface), so TVs and displays with a DVI input can be connected by using an HDMI-to-DVI adapter cable. (Note that DVI connections only carry video, so you'll need to make a separate connection for audio.) However, reliable operation with such an adapter is not guaranteed. In addition, video signals from a PC are not supported.
- When listening to an HDMI component through the AV receiver, set the HDMI component so that its video can be seen on the TV screen (on the TV, select the input of the HDMI component connected to the AV receiver). If the TV power is off or the TV is set to another input source, this may result in no sound from the AV receiver or the sound may be cut off.
- When the “Audio TV Out” setting is set to “On” (see page 78), or “TV Control” is set to “On” (see page 79) and you're listening through your TV's speakers, if you turn up the AV receiver volume control, the sound will be output by the AV receiver's speakers. To stop the AV receiver's speakers producing sound, change the settings, change your TV's settings, or turn down the AV receiver's volume.
- The HDMI audio signal (sampling rate, bit length, etc.) may be restricted by the connected source component. If the picture is poor or there's no sound from a component connected via HDMI, check its setup. Refer to the connected component's instruction manual for details.

## Connecting the AV Receiver—Continued

### Connecting Both Audio & Video

By connecting both the audio and video outputs of your DVD/BD player and other AV components to the AV receiver, you can select both the audio and video simultaneously simply by selecting the appropriate input source on the AV receiver.

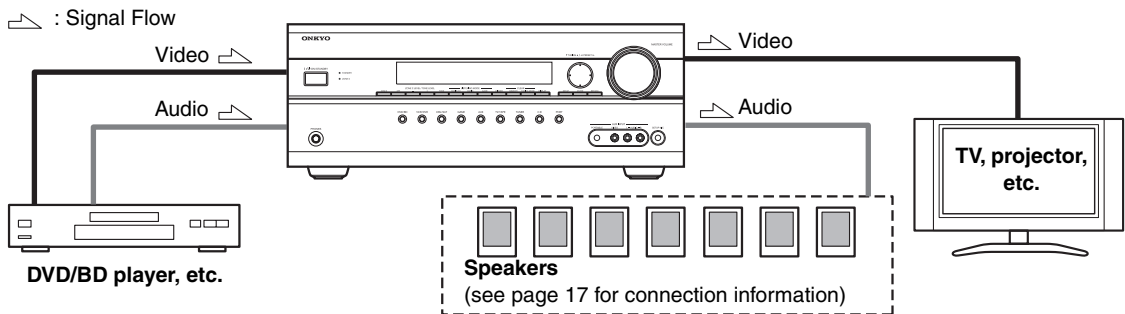

### Which Connections Should I Use?

The AV receiver supports several connection formats for compatibility with a wide range of AV equipment. The format you choose will depend on the formats supported by your other components. Use the following sections as a guide.

#### Video Connection Formats

Video equipment can be connected to the AV receiver by using any one of the following video connection formats: composite video, component video, or HDMI, the latter offering the best picture quality.

Video input signals flow through the AV receiver as shown, with composite video and component video sources all being upconverted for the HDMI output.

The composite video and component video outputs pass through their respective input signals as they are.

When you connect audio equipment to an HDMI or COMPONENT input, you must assign that input to an input selector (see pages 39 and 40).

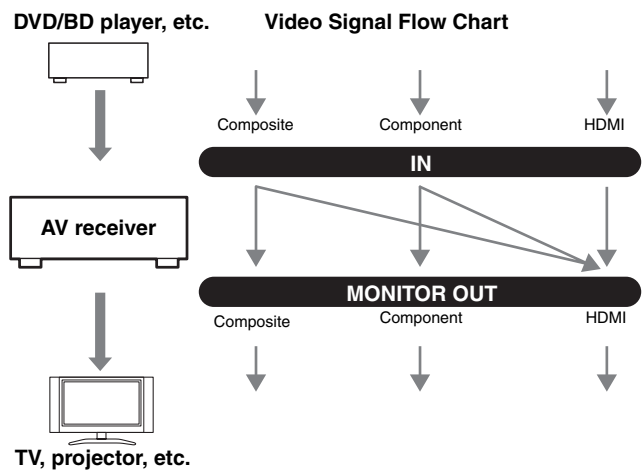

## Connecting the AV Receiver—Continued

### ■ Signal Selection

If signals are present at more than one input, the inputs will be selected automatically in the following order of priority: HDMI, component video, composite video.

However, for component video only, regardless of whether a component video signal is actually present, if a component video input is assigned to the input selector, that component video input will be selected. And if no component video input is assigned to the input selector, this will be interpreted as no component video signal being present.

In the Signal Selection Example shown on the right, video signals are present at both the HDMI and composite video inputs, however, the HDMI signal is automatically selected as the source and video is output by the HDMI outputs.

A video signal from the Composite Video In jack is output from the Composite Video Out jack regardless of the output priority.

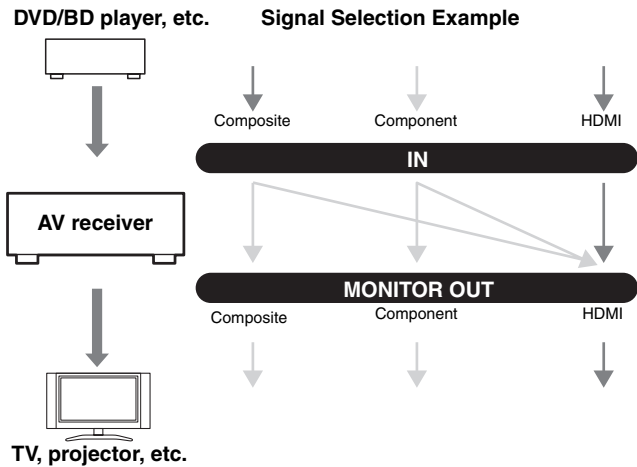

The onscreen setup menus appear only on a TV that is connected to the HDMI OUT. If your TV is connected to the MONITOR OUT V, or the COMPONENT VIDEO OUT, use the AV receiver's display when changing settings.

### Audio Connection Formats

Audio equipment can be connected to the AV receiver by using any of the following audio connection formats: analog, optical, coaxial, or HDMI.

When choosing a connection format, bear in mind that the AV receiver does not convert digital input signals for analog line outputs and vice versa. For example, audio signals connected to an optical or coaxial digital input are not output by the analog TV/TAPE OUT.

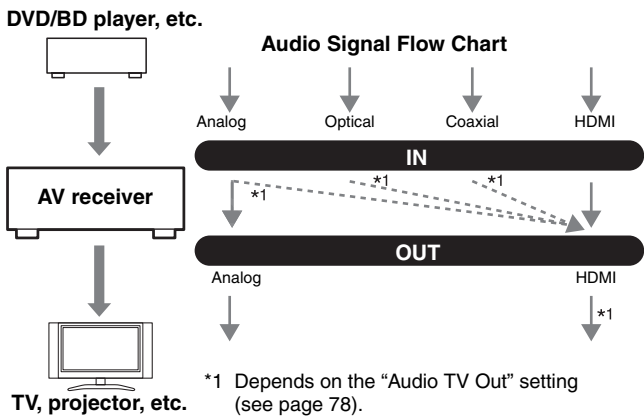

If signals are present at more than one input, the inputs will be selected automatically in the following order of priority: HDMI, digital, analog.

# Connecting the AV Receiver—Continued

## Connecting a TV or Projector

See “Connecting Components with HDMI” on page 22 for HDMI connection information.

### Step 1: Video Connection

Choose a video connection that matches your TV (**A** or **B**), and then make the connection.

### Step 2: Audio Connection

Choose an audio connection that matches your TV (**a**, **b**, or **c**), and then make the connection.

The onscreen setup menus appear only on a TV that is connected to the HDMI OUT. If your TV is connected to the MONITOR OUT V, or the COMPONENT VIDEO OUT, use the AV receiver’s display when changing settings.

- With connection **a**, you can listen to and record audio from your TV and listen in Zone 2.
- To enjoy Dolby Digital and DTS, use connection **b** or **c**. (To record or listen in Zone 2 as well, use **a** and **b**, or **a** and **c**.)

Connection	AV receiver	Signal flow	TV
<b>A</b>	COMPONENT VIDEO OUT	⇒	Component video input
<b>B</b>	MONITOR OUT V	⇒	Composite video input
<b>a</b>	TV/TAPE IN L/R	⇐	Analog audio L/R output
<b>b</b>	DIGITAL IN COAXIAL 2 (CBL/SAT)	⇐	Digital coaxial output
<b>c</b>	DIGITAL IN OPTICAL 1 (GAME)	⇐	Digital optical output

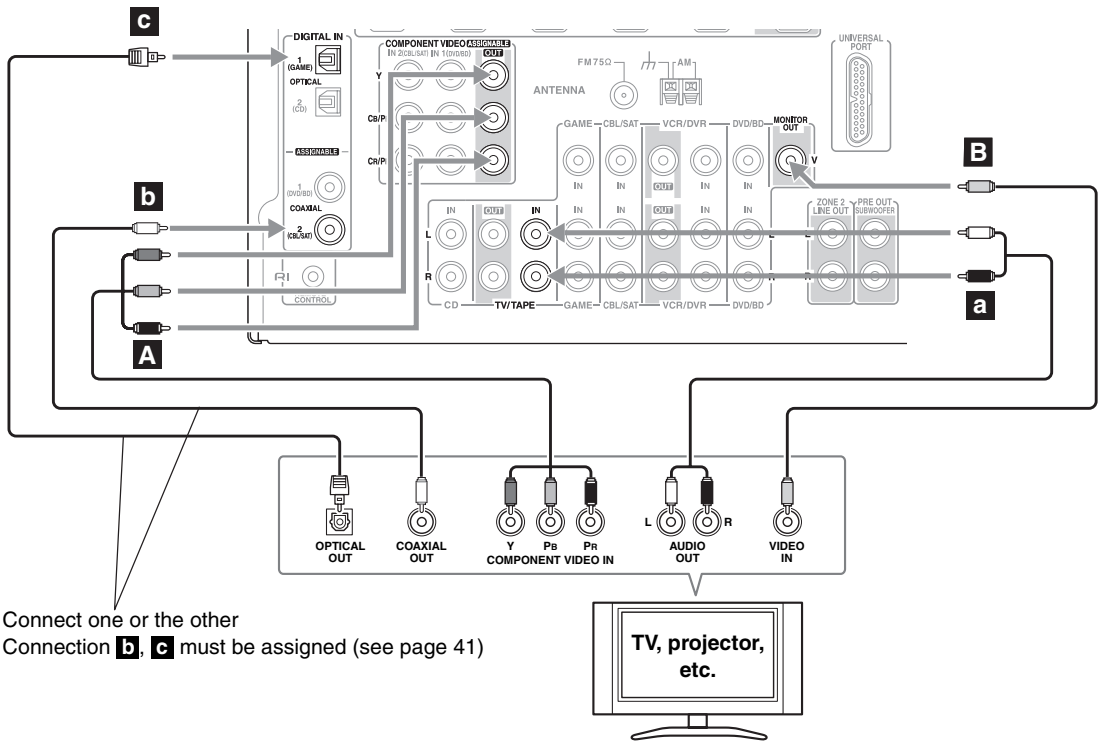

**Hint!**

If your TV has no audio outputs, connect an audio output from your VCR or cable or satellite receiver to the AV receiver and use its tuner to listen to TV programs through the AV receiver (see pages 28 and 30).

# Connecting the AV Receiver—Continued

## Connecting a DVD/BD Player

See “Connecting Components with HDMI” on page 22 for HDMI connection information.

### Step 1: Video Connection

Choose a video connection that matches your DVD/BD player (**A** or **B**), and then make the connection. You must connect the AV receiver to your TV via the same type of connection.

### Step 2: Audio Connection

Choose an audio connection that matches your DVD/BD player (**a**, **b**, or **c**), and then make the connection.

- With connection **a**, you can listen to and record audio from a DVD/BD and listen in Zone 2.
- To enjoy Dolby Digital and DTS, use connection **b** or **c**. (To record or listen in Zone 2 as well, use **a** and **b**, or **a** and **c**.)
- If your DVD/BD player has main left and right outputs and multichannel left and right outputs, be sure to use the main left and right outputs for connection **a**.

Connection	AV receiver	Signal flow	DVD/BD player
<b>A</b>	COMPONENT VIDEO IN 1 (DVD/BD)	←	Component video output
<b>B</b>	DVD/BD IN V	←	Composite video output
<b>a</b>	DVD/BD IN L/R	←	Analog audio L/R output
<b>b</b>	DIGITAL IN COAXIAL 1 (DVD/BD)	←	Digital coaxial output
<b>c</b>	DIGITAL IN OPTICAL 1 (GAME)	←	Digital optical output

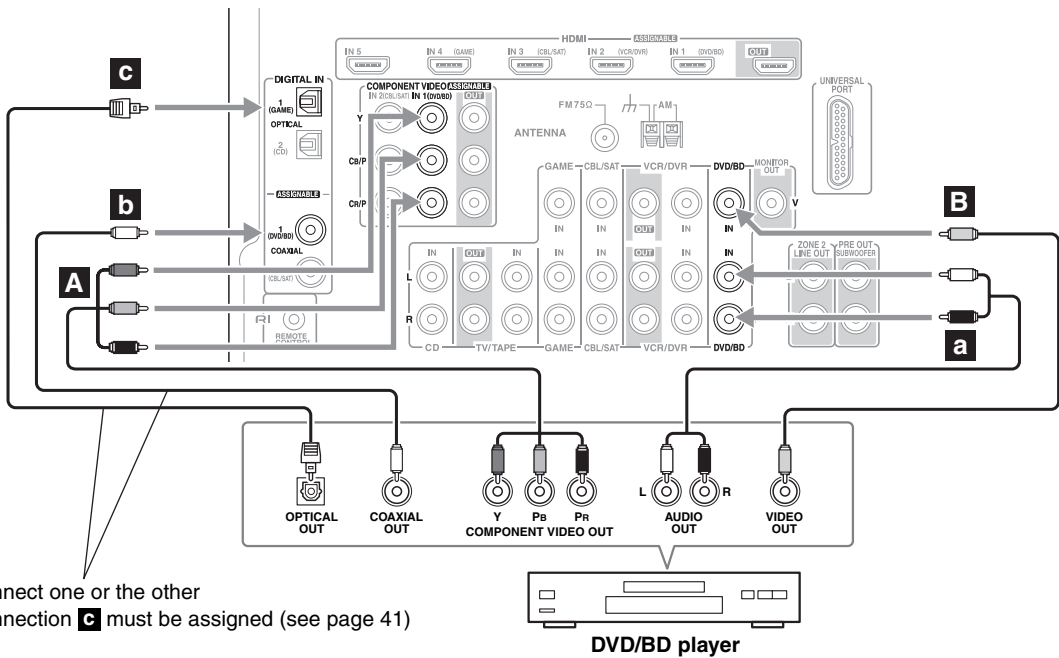

## Connecting the AV Receiver—Continued

### Connecting a VCR or DVD/BD Recorder for Playback



With this hookup, you can use your VCR's tuner to listen to your favorite TV programs via the AV receiver, useful if your TV has no audio outputs.

#### Step 1: Video Connection

Choose a video connection that matches your VCR or DVD/BD recorder (**A** or **B**), and then make the connection. You must connect the AV receiver to your TV via the same type of connection.

#### Step 2: Audio Connection

Choose an audio connection that matches your VCR or DVD/BD recorder (**a**, **b**, or **c**), and then make the connection.

- With connection **a**, you can listen to the VCR or DVD/BD recorder even in Zone 2.
- To enjoy Dolby Digital and DTS, use connection **b** or **c**. (To listen in Zone 2 as well, use **a** and **b**, or **a** and **c**.)

Connection	AV receiver	Signal flow	VCR or DVD/BD recorder
<b>A</b>	COMPONENT VIDEO IN 1 (DVD/BD)	←	Component video output
<b>B</b>	VCR/DVR IN V	←	Composite video output
<b>a</b>	VCR/DVR IN L/R	←	Analog audio L/R output
<b>b</b>	DIGITAL IN COAXIAL 1 (DVD/BD)	←	Digital coaxial output
<b>c</b>	DIGITAL IN OPTICAL 1 (GAME)	←	Digital optical output

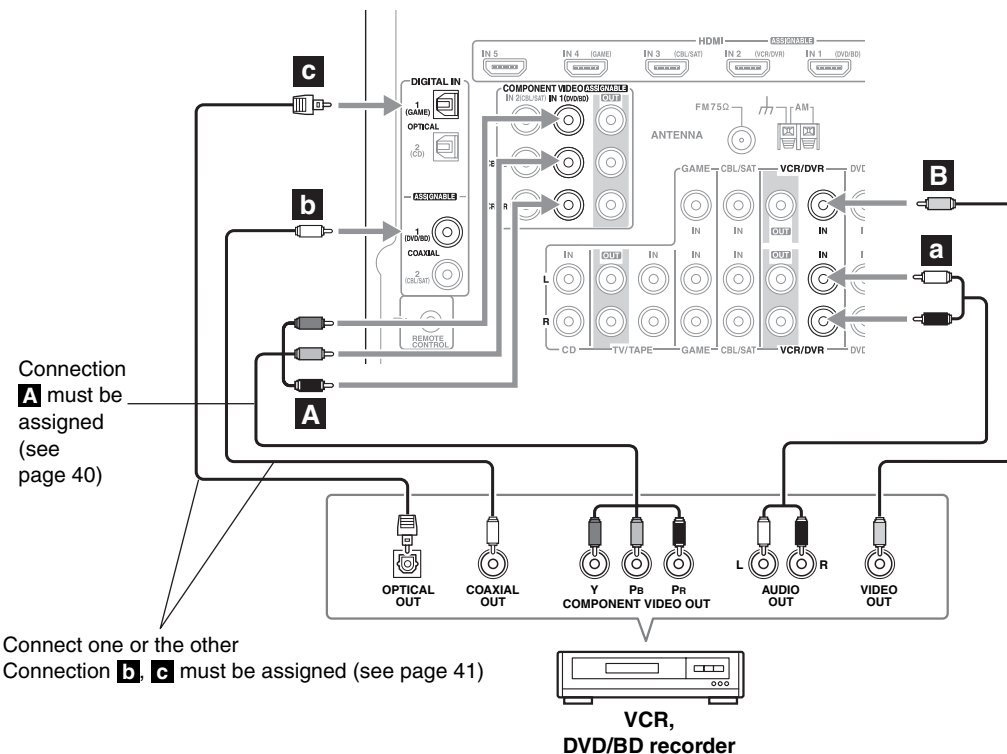



## Connecting the AV Receiver—Continued

### Connecting a VCR or DVD/BD Recorder for Recording

#### Step 1: Video Connection

Make the video connection **A**. The video source to be recorded must be connected to the AV receiver via the same type of connection.

#### Step 2: Audio Connection

Make the audio connection **a**.

Connection	AV receiver	Signal flow	VCR or DVD/BD recorder
<b>A</b>	VCR/DVR OUT V	⇒	Composite video input
<b>a</b>	VCR/DVR OUT L/R	⇒	Analog audio L/R input

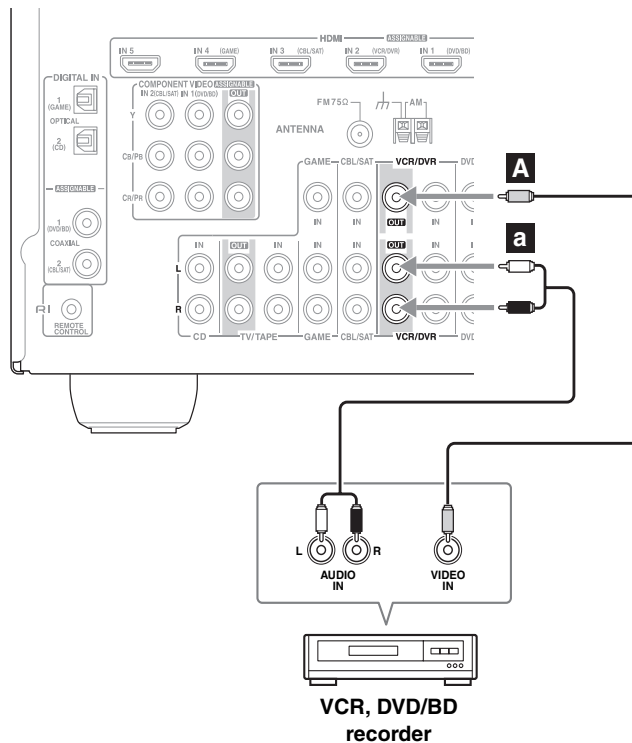

#### Notes:

- The AV receiver must be turned on for recording. Recording is not possible while it's in Standby mode.
- If you want to record directly from your TV or playback VCR to the recording VCR without going through the AV receiver, connect the TV/VCR's audio and video outputs directly to the recording VCR's audio and video inputs. See the manuals supplied with your TV and VCR for details.
- Video signals connected to composite video inputs can only be recorded via composite video outputs. If your TV/VCR is connected to a composite video input, the recording VCR must be connected to a composite video output.

# Connecting the AV Receiver—Continued

## Connecting a Satellite, Cable, Terrestrial Set-top box, or Other Video Source



With this hookup, you can use your satellite or cable receiver to listen to your favorite TV programs via the AV receiver, useful if your TV has no audio outputs.

### Step 1: Video Connection

Choose a video connection that matches the video source (**A** or **B**), and then make the connection. You must connect the AV receiver to your TV via the same type of connection.

### Step 2: Audio Connection

Choose an audio connection that matches the video source (**a**, **b**, or **c**), and then make the connection.

- With connection **a**, you can listen to and record audio from the video source and listen in Zone 2.
- To enjoy Dolby Digital and DTS, use connection **b** or **c**. (To listen in Zone 2 as well, use **a** and **b**, or **a** and **c**.)

Connection	AV receiver	Signal flow	Video source
<b>A</b>	COMPONENT VIDEO IN 2 (CBL/SAT)	←	Component video output
<b>B</b>	CBL/SAT IN V	←	Composite video output
<b>a</b>	CBL/SAT IN L/R	←	Analog audio L/R output
<b>b</b>	DIGITAL IN COAXIAL 2 (CBL/SAT)	←	Digital coaxial output
<b>c</b>	DIGITAL IN OPTICAL 2 (CD)	←	Digital optical output

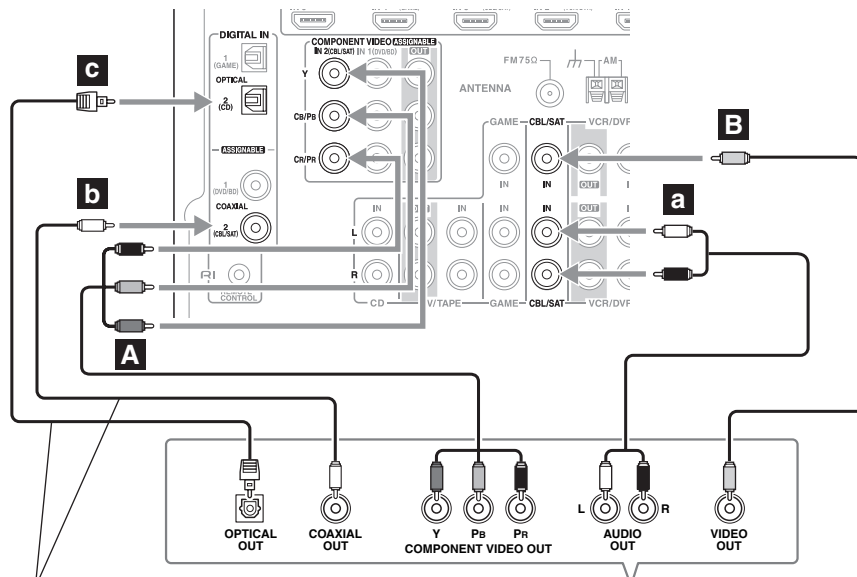

Connect one or the other  
Connection **c** must be assigned (see page 41)

Satellite, cable, set-top box, etc.

# Connecting the AV Receiver—Continued

## Connecting a Game Console

### Step 1: Video Connection

Choose a video connection that matches the game console (**A** or **B**), and then make the connection. You must connect the AV receiver to your TV with the same type of connection.

### Step 2: Audio Connection

Choose an audio connection that matches the game console (**a** or **b**), and then make the connection.

- With connection **a**, you can listen to and record audio from the game console or listen in Zone 2.
- To enjoy Dolby Digital and DTS, use connection **b**. (To record or listen in Zone 2 as well, use **a** and **b**.)

Connection	AV receiver	Signal flow	Game console
<b>A</b>	COMPONENT VIDEO IN 2 (CBL/SAT)	←	Component video output
<b>B</b>	GAME IN V	←	Composite video output
<b>a</b>	GAME IN L/R	←	Analog audio L/R output
<b>b</b>	DIGITAL IN OPTICAL 1 (GAME)	←	Digital optical output

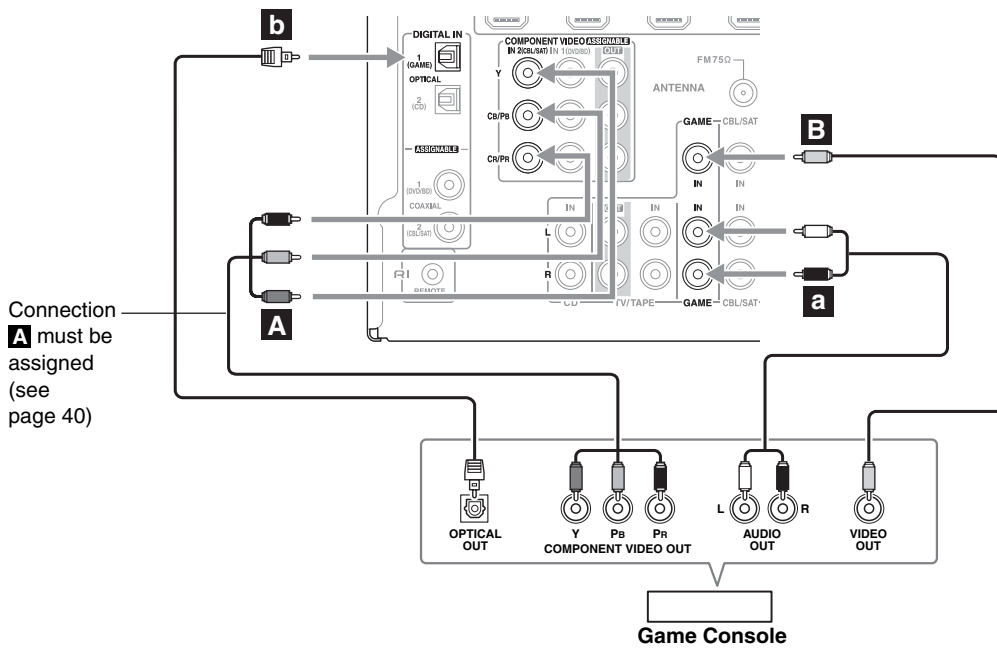

## Connecting the AV Receiver—Continued

### Connecting a Camcorder or Other Device

#### Step 1: Video Connection

Make the connection **A**.

#### Step 2: Audio Connection

Make the connection **a**.

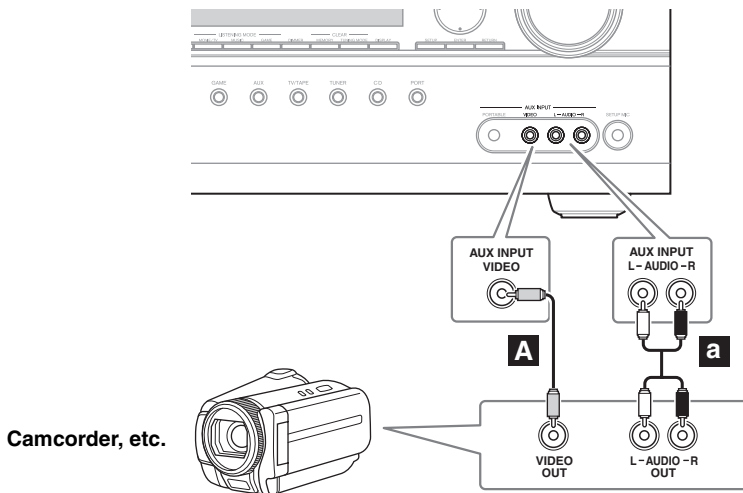

Connection	AV receiver	Signal flow	Camcorder etc.
<b>A</b>	AUX INPUT VIDEO	←	Composite video output
<b>a</b>	AUX INPUT L-AUDIO-R	←	Analog audio L/R output

### Connecting a Portable Audio player

Step 1: Make the audio connection **a**.

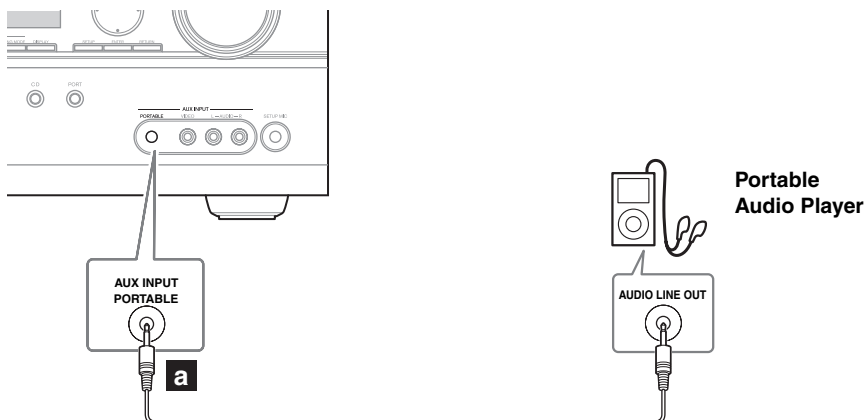

Connection	AV receiver	Signal flow	Portable Audio Player
<b>a</b>	AUX INPUT PORTABLE	←	Analog audio line output

#### Note:

When it is connected at the same time as AUX INPUT AUDIO L/R terminal, the input of PORTABLE is given priority to and outputted.

# Connecting the AV Receiver—Continued

## Connecting a CD Player or Turntable

### ■ CD Player or Turntable (MM) with Built-in Phono Preamp

#### Step 1:

Choose a connection that matches your CD player (**a**, **b**, or **c**). Use connection **a** for a turntable with a built-in phono preamp.

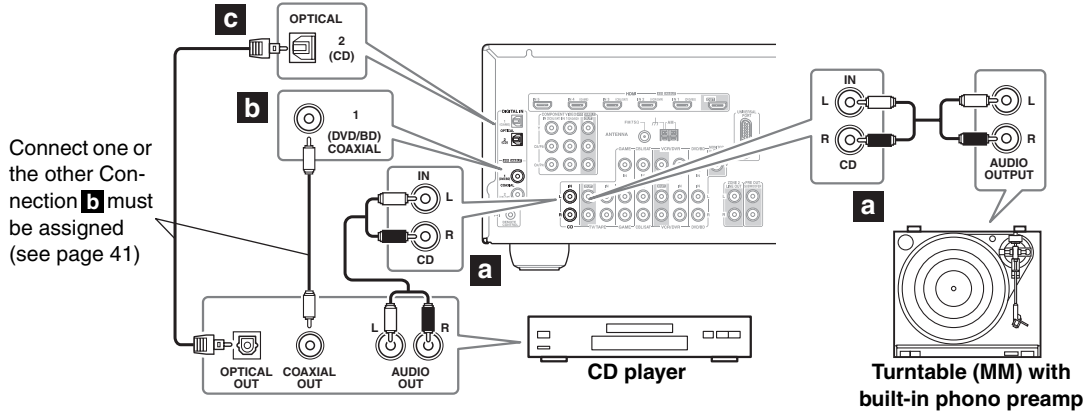

- With connection **a**, you can listen to and record audio from the CD player and listen in Zone 2.
- To connect the CD player digitally, use connection **b** or **c**. (To record or listen in Zone 2 as well, use **a** and **b**, or **a** and **c**.)

Connection	AV receiver	Signal flow	CD or turntable
<b>a</b>	CD IN L/R	←	Analog audio L/R output
<b>b</b>	DIGITAL IN COAXIAL 1 (DVD/BD)	←	Digital coaxial output
<b>c</b>	DIGITAL IN OPTICAL 2 (CD)	←	Digital optical output

### ■ Turntable (MM) with no Phono Preamp Built-in

A phono preamp is necessary to connect a turntable that doesn't have a phono preamp built-in.

### ■ Turntable with an MC (Moving Coil) Cartridge

An MC head amp and phono preamp are necessary to connect a turntable with an MC (Moving Coil) cartridge.

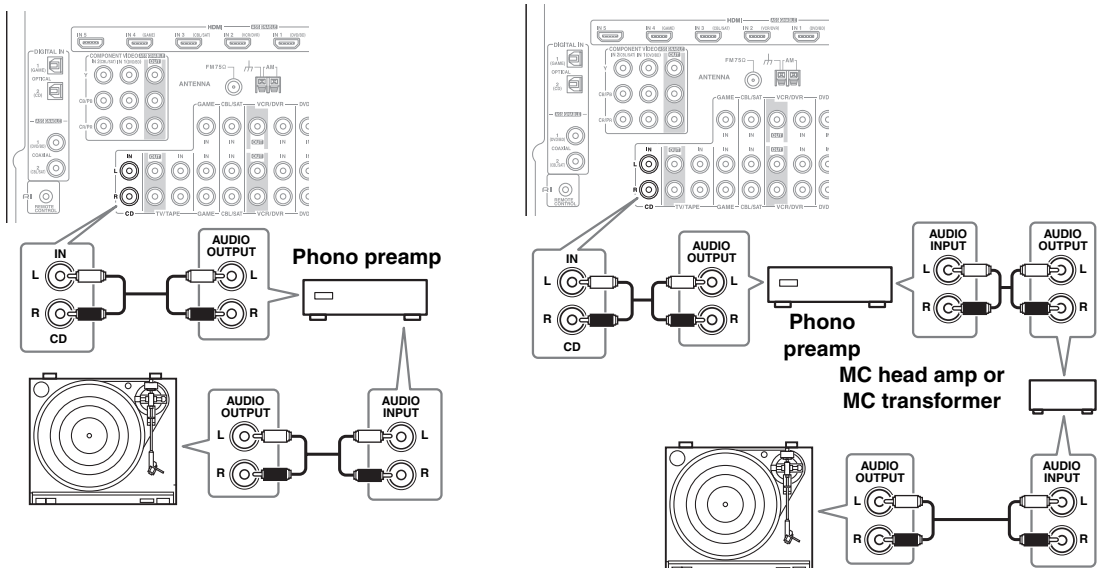

## Connecting a Cassette, CDR, MiniDisc, or DAT Recorder

### Step 1:

Choose a connection that matches the recorder (**a**, **b** or **c**), and then make the connection.

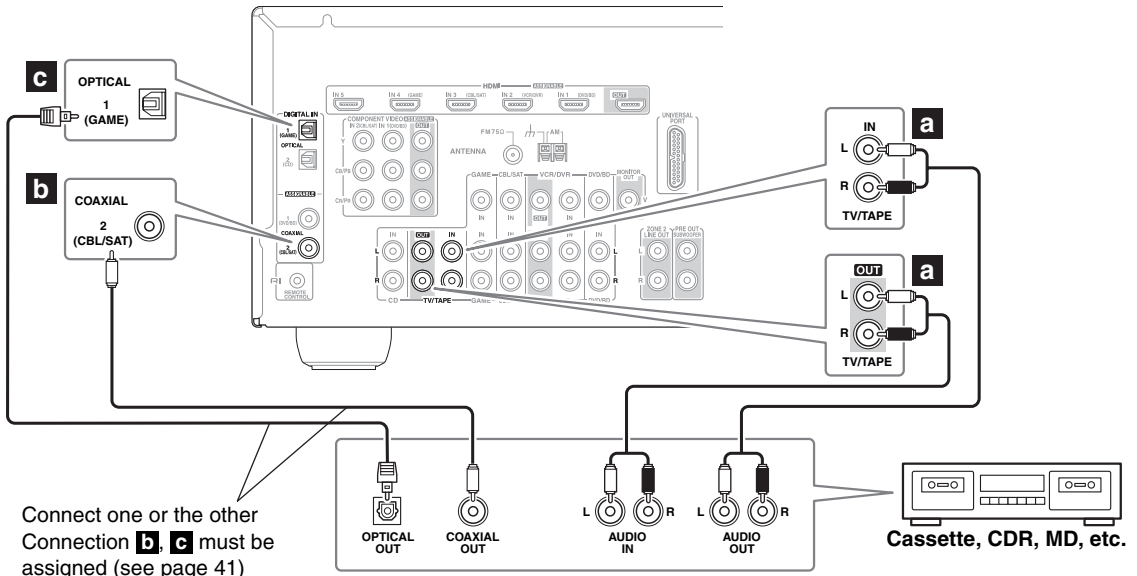

- With connection **a**, you can play and record and listen in Zone 2.
- To connect the recorder digitally for playback, use connections **a** and **b**, or **a** and **c**.

Connection	AV receiver	Signal flow	Cassette, CDR, MD, or DAT recorder
<b>a</b>	TV/TAPE IN L/R TV/TAPE OUT L/R	← →	Analog audio L/R output Analog audio L/R input
<b>b</b>	DIGITAL IN COAXIAL 2 (CBL/SAT)	←	Digital coaxial output
<b>c</b>	DIGITAL IN OPTICAL 1 (GAME)	←	Digital optical output

## Connecting the AV Receiver—Continued

### Connecting an RI Dock

Not all iPod models output video. For information about which iPod models are supported by the RI Dock, see the RI Dock's instruction manual.

#### ■ If Your iPod Supports Video:

Connect your RI Dock's audio output jacks to the AV receiver's GAME IN or VCR/DVR IN L/R jacks, and connect its video output jack to the AV receiver's GAME IN or VCR/DVR IN V jacks. (Onkyo DS-A2 hookup shown below.)

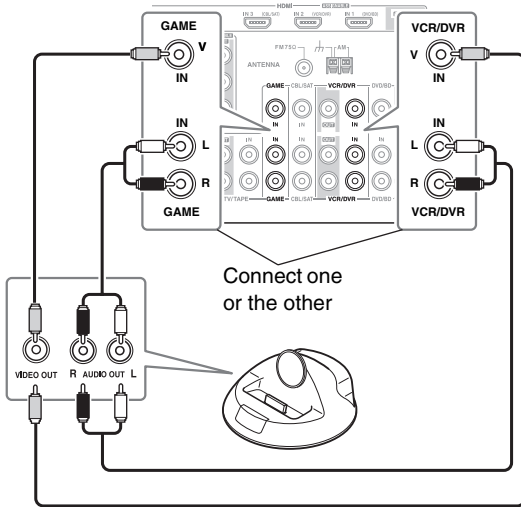

#### ■ If Your iPod Doesn't Support Video:

Connect your RI Dock's analog audio output jacks to the AV receiver's TV/TAPE IN L/R jacks. (Onkyo DS-A2 hookup shown below.)

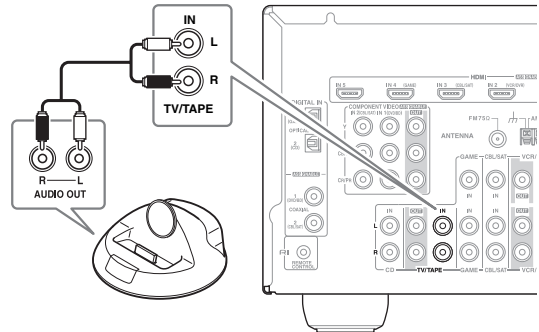

#### Notes:

- Enter the appropriate remote control code before using the AV receiver's remote controller for the first time (see page 88).
- Connect the RI Dock to the AV receiver with an **RI** cable (see page 36).
- Set the RI Dock's RI MODE switch to "HDD" or "HDD/DOCK".
- Set the AV receiver's Input Display to "DOCK" (see page 44).
- See the RI Dock's instruction manual for more information.

### Connecting a Dock with the Universal Port connector

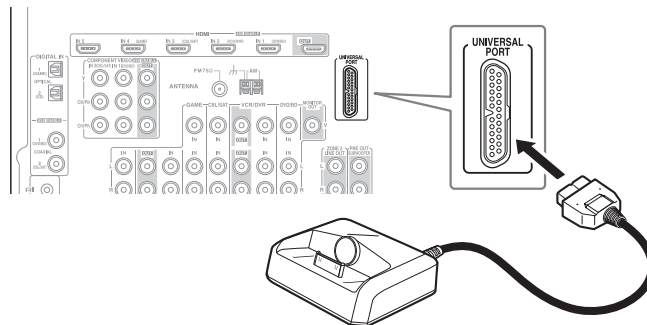

#### Note:

When UP-A1 series Dock that seated iPod is connected, the power consumption on standby mode slightly increases.

### Connecting Onkyo RI Components

#### Step 1:

Make sure that each Onkyo component is connected to the AV receiver with an analog audio cable (connection **a** in the hookup examples) (see pages 26 to 35).

#### Step 2:

Make the **RI** connection (see illustration below).

#### Step 3:

If you're using an RI Dock, change the Input Display (see page 44).

With **RI** (Remote Interactive), you can use the following special functions:

#### ■ Auto Power On/Standby

When you start playback on a component connected via **RI**, if the AV receiver is on Standby, it will automatically turn on and select that component as the input source. Similarly, when the AV receiver is set to Standby, all components connected via **RI** will also go on Standby.

#### ■ Direct Change

When playback is started on a component connected via **RI**, the AV receiver automatically selects that component as the input source.

#### ■ Remote Control

You can use the AV receiver's remote controller to control your other **RI**-capable Onkyo components, pointing the remote controller at the AV receiver's remote control sensor instead of the component. You must enter the appropriate remote control code first (see page 89).

#### Notes:

- Use only **RI** cables for **RI** connections. **RI** cables are supplied with Onkyo players (DVD, CD, etc.).
- Some components have two **RI** jacks. You can connect either one to the AV receiver. The other jack is for connecting additional **RI**-capable components.
- Connect only Onkyo components to **RI** jacks. Connecting other manufacturer's components may cause a malfunction.
- Some components may not support all **RI** functions. Refer to the manuals supplied with your other Onkyo components.
- While Zone 2 is on, the Auto Power On/Standby and Direct Change **RI** functions do not work.

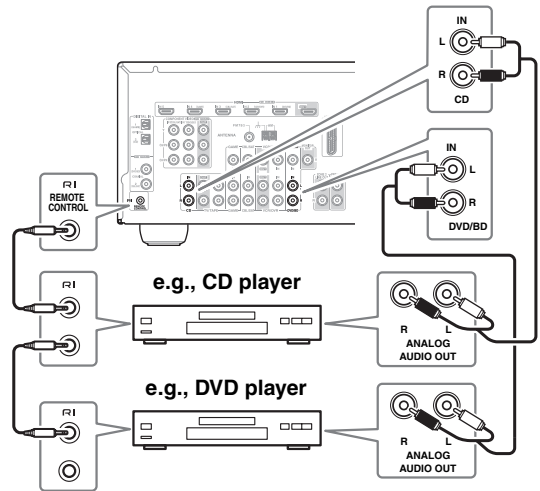

### Connecting the Power Cord

#### Notes:

- **Before connecting the power cord, connect all your speakers and AV components.**
- Plug the end of the power cord into a suitable wall outlet.
- Turning on the AV receiver may cause a momentary power surge that might interfere with other electrical equipment on the same circuit. If this is a problem, plug the AV receiver into a different branch circuit.



# Turning On the AV Receiver

ON/STANDBY  
STANDBY indicator

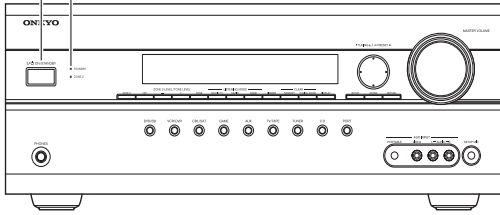

ON/STANDBY

RECEIVER

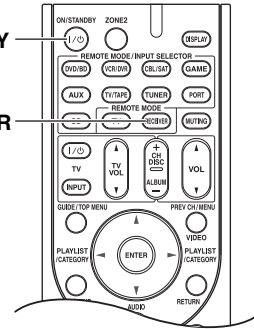

## Turning On and Standby

AV receiver



or

Remote controller



Press the [ON/STANDBY] button.

Alternatively, press the remote controller's [RECEIVER] button, followed by the [ON/STANDBY] button.

The AV receiver comes on, the display lights up, and the STANDBY indicator goes off.

To turn the AV receiver off, press the [ON/STANDBY] button, or press the remote controller's [ON/STANDBY] button. The AV receiver will enter Standby mode. To prevent any loud surprises when you turn on the AV receiver, always turn down the volume before you turn it off.

## Smooth Operation in a Few Easy Steps

To ensure smooth operation, here's a few easy steps to help you configure the AV receiver before you use it for the very first time. These settings only need to be made once.

### ■ Do the 2EQ Room Correction and Speaker Setup—this is essential!

See "Audyssey 2EQ™ Room Correction and Speaker Setup" on page 45.



### ■ Have you connected a component to an HDMI input, component video input, or digital audio input?

If you have, see "HDMI Input Setup" on page 39, "Component Video Setup" on page 40, or "Digital Input Setup" on page 41 respectively.

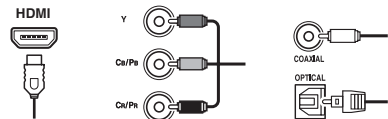

### ■ Have you connected an Onkyo RI Dock?

If you have, see "Changing the Input Display" on page 44.

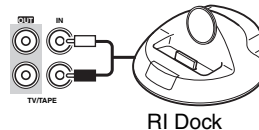

# First Time Setup

This section explains the settings that you need to make before using the AV receiver for the very first time.

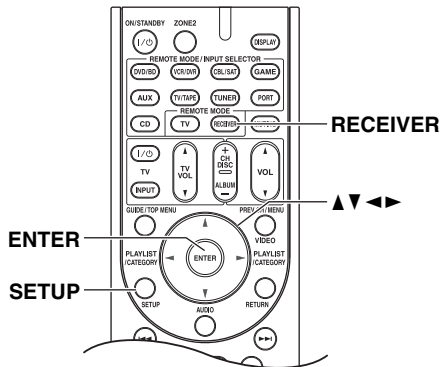

## Using the Onscreen Setup Menus

Carry out the settings for the AV receiver by using the Onscreen Setup Menu.

The onscreen setup menus appear only on a TV that is connected to the HDMI OUT. If your TV is connected to the composite video MONITOR OUT, or the COMPONENT VIDEO OUT, use the AV receiver's display when changing settings.

- 1** Press the [RECEIVER] button followed by the [SETUP] button. The main menu appears onscreen. If the main menu doesn't appear, make sure the appropriate external input is selected on your TV.

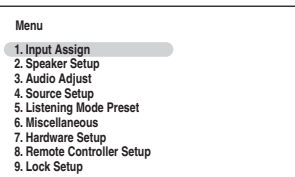

**Tip:** On several functions, the explanation will be displayed under the screen.

- 2** Use the Up and Down [▲]/[▼] buttons to select main menu item and then press [ENTER]. The submenu appears. Press the [SETUP] button to close the menu. Press the [RETURN] button to return to the previous menu.

## Using the Display to change the settings

The settings of the AV receiver can be changed using the Display.

- 1** Press the [RECEIVER] button followed by the [SETUP] button. The main menu item appears on the display.

*1. Input Assign*

- 2** Use the Up and Down [▲]/[▼] buttons to select main menu item and then press [ENTER]. The submenu item appears on the display. Press the [SETUP] button to close the menu. Press the [RETURN] button to return to the previous menu.

## Onscreen Setup Menus and Display

As each item in the Onscreen Setup Menu is selected, the selected items will be displayed one by one.

### Onscreen Setup Menus

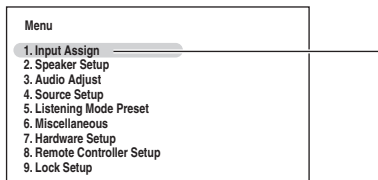

### Display

*1. Input Assign*

**Note:** During the Audyssey 2EQ™ Room Correction and Speaker Setup, messages, etc., that are displayed on the TV screen will appear in the Display.

**Video Input Setup**

**HDMI Input Setup**

If you connect a video component to HDMI IN, you must assign that input to an input selector. For example, if you connect your DVD/BD player to HDMI IN1, you must assign HDMI IN1 to the DVD/BD input selector.

If you've connected your TV to the AV receiver with an HDMI cable, you can set the AV receiver so that composite video and component video sources are upconverted\* and output by the HDMI OUT. You can set this for each input selector by selecting the “-----” option.

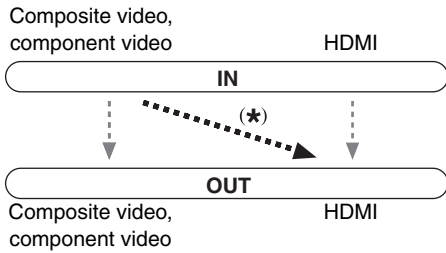

**1 Press the [RECEIVER] button followed by the [SETUP] button.**  
The main menu appears onscreen. If the main menu doesn't appear, make sure the appropriate external input is selected on your TV.



**2 Use the Up and Down [▲]/[▼] buttons to select “Input Assign”, and then press [ENTER].**  
The “Input Assign” menu appears.

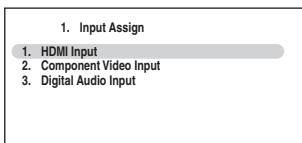

**3 Use the Up and Down [▲]/[▼] buttons to select “1. HDMI Input”, and then press [ENTER].**  
The “HDMI Input” menu appears.

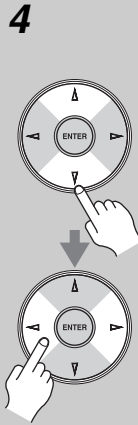
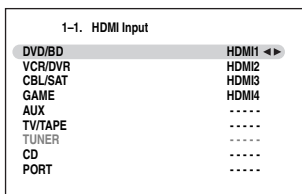

**4 Use the Up and Down [▲]/[▼] buttons to select an input selector, and use the Left and Right [◀]/[▶] buttons to select:**

**HDMI1, HDMI2, HDMI3, HDMI4, HDMI5:**

Select the HDMI IN to which the video component has been connected.

-----: Output composite video and component video sources from the HDMI OUT. The video output signal from the HDMI OUT is the one configured in “Component Video Setup” (see page 40).

Each HDMI IN cannot be assigned to more than one input selector. When HDMI1 - HDMI5 have already been assigned, you must set first any unused input selectors to “-----” or you will be unable to assign HDMI1 - HDMI5 to input selector.



**5 Press the [SETUP] button.**

The setup menu closes.

**Notes:**

- For composite video and component video upconversion for the HDMI OUT, the HDMI Input setting must be set to “-----”. See page 24 for more information on video signal flow and upconversion.
- When an HDMI IN is assigned to an input selector as explained here, the digital audio input for that input selector is automatically set to the same HDMI IN. See “Digital Input Setup” on page 41.
- The TUNER input selector cannot be assigned and is fixed at the “-----” option.
- If you connect an input component (such as UP-A1 series Dock that seated iPod) to the UNIVERSAL PORT jack, you cannot assign any input to PORT selector.
- Do not assign the component connected with the HDMI input to the TV/TAPE selector when you set “TV Control” setting to “On” (see page 79). Otherwise, appropriate CEC (Consumer Electronics Control) operation is not guaranteed.
- This procedure can also be performed on the AV receiver by using its [SETUP] button, arrow buttons, and [ENTER] button.

**Component Video Setup**

If you connect to a COMPONENT VIDEO IN, you must assign it to an input selector. For example, if you connect your DVD/BD player to COMPONENT VIDEO IN 2, you should assign it to the DVD/BD input selector.

Input selector	Default assignment
DVD/BD	IN1
VCR/DVR	-----
CBL/SAT	IN2
GAME	-----
AUX	-----
TV/TAPE	-----
TUNER	----- (Fixed)
CD	-----
PORT	-----

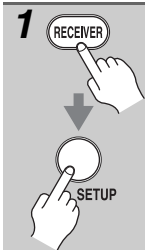

**1 Press the [RECEIVER] button followed by the [SETUP] button.**  
The main menu appears onscreen.  
If the main menu doesn't appear, make sure the appropriate external input is selected on your TV.

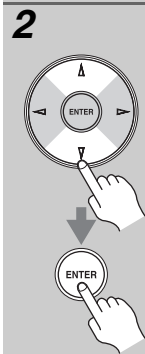

**2 Use the Up and Down [▲]/[▼] buttons to select "1. Input Assign", and then press [ENTER].**  
The "Input Assign" menu appears.

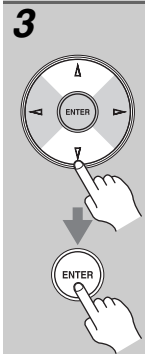
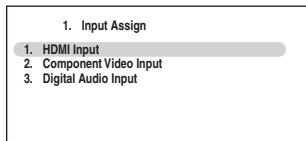

**3 Use the Up and Down [▲]/[▼] buttons to select "2. Component Video Input", and then press [ENTER].**  
The "Component Video Input" menu appears.

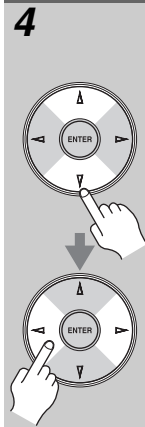
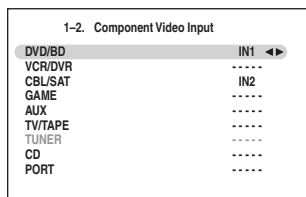

**4 Use the Up and Down [▲]/[▼] buttons to select an input selector, and then use the Left and Right [◀]/[▶] buttons to select:**  
**IN1:** Select if the video component is connected to COMPONENT VIDEO IN 1.  
**IN2:** Select if the video component is connected to COMPONENT VIDEO IN 2.  
**-----:** Select if you are using the HDMI OUT, rather than the COMPONENT VIDEO OUT, for the output from composite video and component video sources.

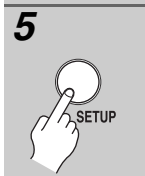

**5 Press the [SETUP] button.**  
The setup menu closes.

**Notes:**

- If you connect an input component (such as UP-A1 series Dock that seated iPod) to the UNIVERSAL PORT jack, you cannot assign any input to PORT selector.
- This procedure can also be performed on the AV receiver by using its [SETUP] button, arrow buttons, and [ENTER] button.

**Digital Input Setup**

If you connect a component to a digital input jack, you must assign that jack to an input selector. For example, if you connect your CD player to the OPTICAL IN1 jack, you should assign that jack to the CD input selector. By default, the COAXIAL IN1 jack is assigned to the DVD/BD input selector, although this can be changed. Here are the default assignments.

Input selector	Default assignment
DVD/BD	COAX1
VCR/DVR	-----
CBL/SAT	COAX2
GAME	OPT1
AUX	-----
TV/TAPE	-----
TUNER	----- (Fixed)
CD	OPT2
PORT	-----

**1** Press the [RECEIVER] button followed by the [SETUP] button.

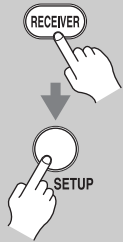

The main menu appears onscreen. If the main menu doesn't appear, make sure the appropriate external input is selected on your TV.

**2** Use the Up and Down [▲]/[▼] buttons to select "1. Input Assign", and then press [ENTER].

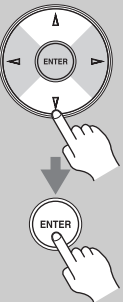

The "Input Assign" menu appears.

1. Input Assign	
1. HDMI Input	-----
2. Component Video Input	-----
3. Digital Audio Input	-----

**3** Use the Up and Down [▲]/[▼] buttons to select "3. Digital Audio Input", and then press [ENTER].

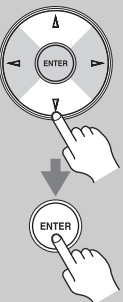

The "Digital Audio Input" menu appears.

1-3. Digital Audio Input	
DVD/BD	COAX 1 ◀▶
VCR/DVR	-----
CBL/SAT	COAX 2
GAME	OPT 1
AUX	-----
TV/TAPE	-----
TUNER	-----
CD	OPT 2
PORT	-----

**4**

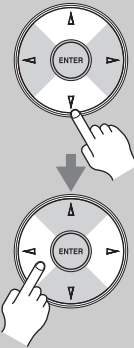

Use the Up and Down [▲]/[▼] buttons to select an input selector, and use the Left and Right [◀]/[▶] buttons to select "COAX1", "COAX2", "OPT1", "OPT2", or "----- (analog)".

- When an HDMI IN is assigned to an input selector in "HDMI Input Setup" on page 39, this input assignment is automatically set to the same HDMI IN. And in addition to the usual inputs (e.g., COAX1, COAX2, etc.), you can also select HDMI inputs.
- Press the [ENTER] button when you do not use the signal of audio from the HDMI IN. The "\*" mark is displayed like "COAX1 \*".

**Examples:**

If you connect your DVD/BD player to the OPTICAL IN 1 jack, set "DVD/BD" to "OPT1".

If you want to listen to audio from the component connected to the OPTICAL IN 2 jack when the VCR/DVR input selector is selected, set "VCR/DVR" to "OPT2".

If you want to listen to audio from the component connected to the COAXIAL IN 1 jack when the CBL/SAT input selector is selected, set "CBL/SAT" to "COAX1".

For the input selector that you want to listen the analog audio, set to "-----" in the Digital Audio Input setting and HDMI Input setting (see page 39).

**5**



Press the [SETUP] button.

The setup menu closes.

**Notes:**

- If you connect an input component (such as UP-A1 series Dock that seated iPod) to the UNIVERSAL PORT jack, you cannot assign any input to PORT selector.
- This procedure can also be performed on the AV receiver by using its [SETUP] button, arrow buttons, and [ENTER] button.

## Speaker Settings

If you change these settings, you must run the Audyssey 2EQ™ Room Correction and Speaker Setup again (see page 45).

If you've connected your front speakers to the FRONT L/R and SURR BACK L/R terminal posts for bi-amping, you must change the "Speaker Type" setting. For hookup information, see "Bi-amping the Front Speakers" on page 18.

**Notes:**

- When bi-amping is used, the AV receiver is able to drive up to 5.1 speakers in the main room.
- Before you change these settings, turn down the volume.

**1**

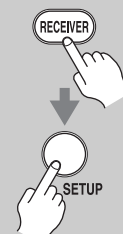

**Press the [RECEIVER] button, followed by the [SETUP] button.**  
The main menu appears onscreen. If the main menu doesn't appear, make sure the appropriate external input is selected on your TV.

**2**



**Use the Up and Down [▲]/[▼] buttons to select "2. Speaker Setup", and then press [ENTER].**  
The "Speaker Setup" menu appears.

2. Speaker Setup

1. Speaker Settings

2. Speaker Configuration

3. Speaker Distance

4. Level Calibration

5. Equalizer Settings

**3**



**Use the Up and Down [▲]/[▼] buttons to select "1. Speaker Settings", and then press [ENTER].**  
The "Speaker Settings" menu appears.

2-1. Speaker Settings

Speaker Type	Normal
Powered Zone 2	Not Act
Surr Back/Front High	Surr Back

**4**

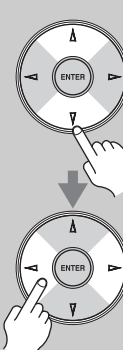

**Use the Up and Down [▲]/[▼] buttons to select "Speaker Type", and then use the Left and Right [◀]/[▶] buttons to select:**

**Normal:** Select this if you've connected your front speakers normally.

**Bi-Amp:** Select this if you've connected your front speakers for bi-amped operation.

**Note:**  
Powered Zone 2 cannot be used if "Speaker Type" is set to "Bi-Amp".

**5**



**Use the Up and Down [▲]/[▼] buttons to select "Surr Back/Front High", and then use the Left and Right [◀]/[▶] buttons to select:**

**Front High:**  
Select this if you've connected your front high speakers to the SURR BACK L/R terminal posts.

**Surr Back:**  
Select this if you've connected your surround back speakers to the SURR BACK L/R terminal posts.

**Note:**  
If the "Speaker Type" setting is set to "Bi-Amp", or "Powered Zone 2" is set to "Not Act", this setting cannot be selected.

**6**



**Press the [SETUP] button.**  
The setup menu closes.

### Powered Zone 2

See "Zone 2" on page 82.

**Note:**

This procedure can also be performed on the AV receiver by using its [SETUP] button, arrow buttons, and [ENTER] button.

## FM/AM Frequency Step Setup

For FM/AM tuning to work properly, you must specify the FM/AM frequency step used in your area. Note that when this setting is changed, all radio presets are deleted.

**1**



**Press the [RECEIVER] button, followed by the [SETUP] button.**  
The main menu appears onscreen.  
If the main menu doesn't appear, make sure the appropriate external input is selected on your TV.

**2**

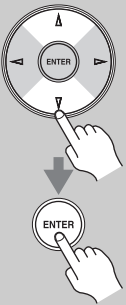

**Use the Up and Down [▲]/[▼] buttons to select “7. Hardware Setup”, and then press [ENTER].**  
The “Hardware Setup” menu appears.

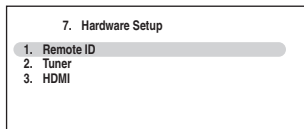

**3**

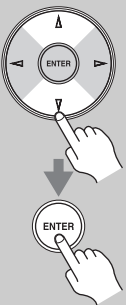

**Use the Up and Down [▲]/[▼] buttons to select “2. Tuner”, and then press [ENTER].**  
The “Tuner” menu appears.

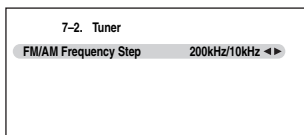

**4**

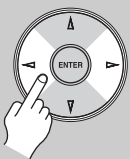

**Use the Left and Right [◀]/[▶] buttons to select:**

**200kHz/10kHz:**  
Select if 200 kHz/10 kHz steps are used in your area.

**50kHz/9kHz:**  
Select if 50 kHz/9 kHz steps are used in your area.

**5**



**Press the [SETUP] button.**  
The setup menu closes.

**Note:**

This procedure can also be performed on the AV receiver by using its [SETUP] button, arrow buttons, and [ENTER] button.

## Changing the Input Display

If you connect an **RI**-capable Onkyo RI Dock to the TV/TAPE IN, GAME IN or VCR/DVR IN jacks, for **RI** to work properly, you must change this setting. This setting can only be changed on the AV receiver.

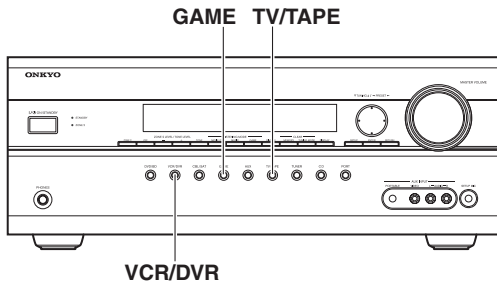

### Notes:

- DOCK can be selected for the TV/TAPE or GAME or VCR/DVR input selector, but not at the same time.
- Enter the appropriate remote control code before using the AV receiver's remote controller for the first time (see page 88).

### 1

TV/TAPE



or

GAME



or

VCR/DVR



Press the [TV/TAPE], [GAME] or [VCR/DVR] input selector button so that "TV/TAPE", "GAME" or "VCR/DVR" appears on the display.

TV/TAPE

GAME

VCR/DVR

### 2

TV/TAPE



or

GAME



or

VCR/DVR



Press and hold down the [TV/TAPE], [GAME] or [VCR/DVR] input selector button (about 3 seconds) to change the setting.

Repeat this step to select DOCK.  
For the TV/TAPE input selector, the setting changes in this order:

TV/TAPE → MD → CDR  
 ↑ DOCK ←

For the GAME input selector, the setting changes in this order:  
GAME ↔ DOCK

For the VCR/DVR input selector, the setting changes in this order:  
VCR/DVR ↔ DOCK



### Audyssey 2EQ™ Room Correction and Speaker Setup

With the supplied calibrated microphone, Audyssey 2EQ automatically determines the number of speakers connected, their size for purposes of bass management, optimum crossover frequencies to the subwoofer (if present), and distances from the primary listening position.

Audyssey 2EQ then removes the distortion caused by room acoustics by capturing room acoustical problems over the listening area in both the frequency and time domain. The result is clear, well-balanced sound for everyone. Enabling Audyssey 2EQ allows you to also use Audyssey Dynamic EQ™, which maintains the proper octave-to-octave balance at any volume level (see page 71).

Before using this function, connect and position all of your speakers.

If Audyssey Dynamic EQ is set to “On”, Audyssey Dynamic Volume™ becomes available.

#### About Audyssey Dynamic EQ

Audyssey Dynamic EQ solves the problem of deteriorating sound quality as volume is decreased by taking into account human perception and room acoustics. Dynamic EQ selects the correct frequency response and surround levels moment-by-moment at any user-selected volume setting. The result is bass response, tonal balance, and surround impression that remain constant despite changes in volume. Dynamic EQ combines information from incoming source levels with actual output sound levels in the room, a prerequisite for delivering a loudness correction solution. Audyssey Dynamic EQ works in tandem with Audyssey 2EQ to provide well-balanced sound for every listener at any volume level.

#### About Audyssey Dynamic Volume

Audyssey Dynamic Volume solves the problem of large variations in volume level between television programs, commercials, and between the soft and loud passages of movies. Dynamic Volume looks at the preferred volume setting by the user and then monitors how the volume of program material is being perceived by listeners in real time to decide whether an adjustment is needed. Whenever necessary, Dynamic Volume makes the necessary rapid or gradual adjustments to maintain the desired playback volume level while optimizing the dynamic range. Audyssey Dynamic EQ is integrated into Dynamic Volume so that as the playback volume is adjusted automatically, the perceived bass response, tonal balance, surround impression, and dialog clarity remain the same whether watching movies, flipping between television channels, or changing from stereo to surround sound content.

### Measurement Positions

To create a listening environment in your home theater that all listeners will enjoy, Audyssey 2EQ takes measurements at up to three positions within the listening area.

① **First measurement point**

Also referred to as the Main Listening Position this refers to the most central position where one would normally sit within the listening environment. 2EQ uses the measurements from this position to calculate speaker distance, level, polarity, and the optimum crossover value for the subwoofer.

② **Second measurement point**

The right side of the listening area.

③ **Third measurement point**

The left side of the listening area.

The distances between points ① and ② and points ① and ③ must be at least 1 meter.

From the examples below, choose the listening area that best matches yours and place the microphone accordingly when prompted.

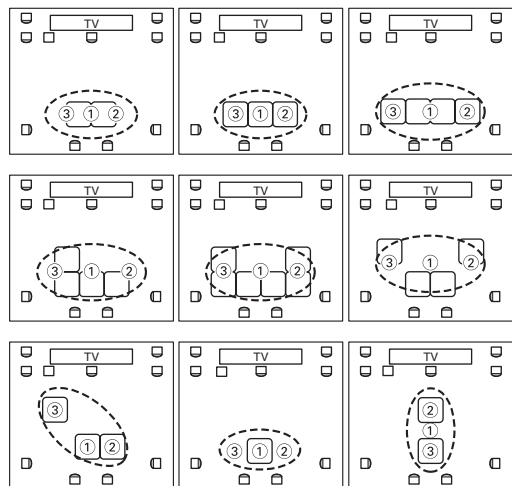

○: Listening area

□: Listening position

## Using Audyssey 2EQ™

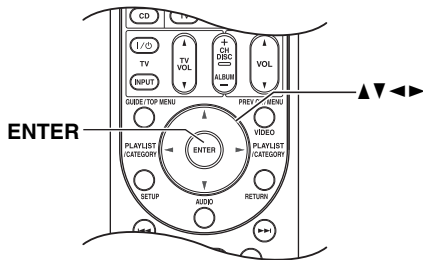
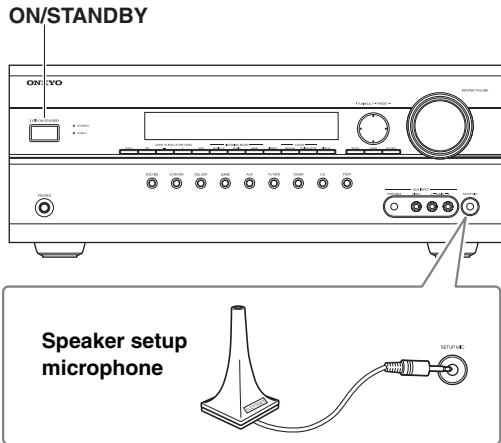

### Notes:

- If the AV receiver is muted, it will be unmuted automatically when the Audyssey 2EQ Room Correction and Speaker Setup starts.
- Room correction and speaker setup cannot be performed while a pair of headphones is connected.
- It takes about 15 minutes to complete the room correction and speaker setup for three positions. Total measurement time varies depending on the number of speakers.
- Do not disconnect the speaker setup microphone during the room correction and speaker setup, unless you want to cancel the setup.
- Do not connect or disconnect any speakers during the room correction and speaker setup.

The onscreen setup menus appear only on a TV that is connected to the HDMI OUT. If your TV is connected to the MONITOR OUT V or the COMPONENT VIDEO OUT, use the AV receiver's display when changing settings.

**1**

### Turn on the AV receiver and the connected TV.

On the TV, select the input to which the AV receiver is connected.

**2**



### Set the speaker setup microphone at the Main Listening Position ① (page 45), and connect it to the SETUP MIC jack.

The speaker setting menu appears.

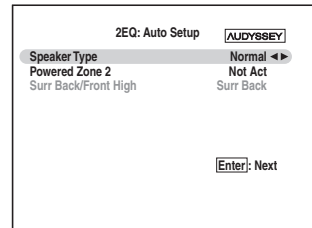

If you change these settings, refer to step 5 on “Speaker Settings” (page 42) or step 4 on “Setting the Powered Zone 2” (page 83).

**3**



### When you've finished, press the [ENTER] button.

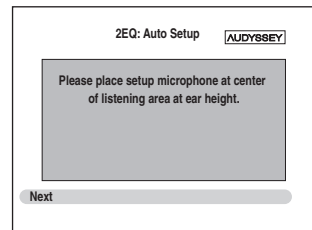

### Notes:

- Before starting Audyssey 2EQ™ Room Correction and Speaker Setup, arrange the room and connect the speakers as you would for enjoying movies. Changes to the room after auto setup requires you run the auto setup again, as room EQ characteristics may have changed.
- When starting the room correction and speaker setup, do not stand between the speakers and microphone, and avoid obstacles blocking the path between speakers and microphone. This will produce inaccurate results.
- Position the microphone at ear height of a seated listener with the microphone tip pointed directly at the ceiling using a tripod. Do not hold the microphone in your hand during measurements as this will produce inaccurate results.

- Make the room as quiet as possible. Background noise can disrupt the room measurements. Close windows, silence cell phones, televisions, radios, air conditioners, fluorescent lights, home appliances, light dimmers, or other devices.
- Cell phones should be turned off or placed away from all audio electronics during the measurement process as Radio Frequency Interference (RFI) may cause measurement disruptions (even if the cell phone is not in use).

**4**



**Press [ENTER].**

The room correction and speaker setup starts.

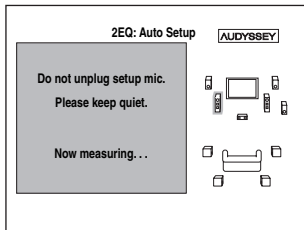

Test tones are played through each speaker as Audyssey 2EQ™ Room Correction and Speaker Setup runs. This process takes a few minutes. Please refrain from talking during measurements and do not stand between speakers and the microphone.

**5**

**The following screen appears.**

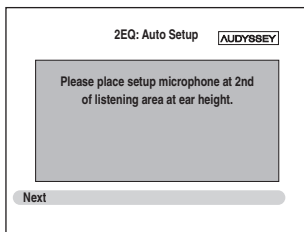

**Place the setup microphone at the next position (page 45), and then press [ENTER].**

Audyssey 2EQ performs more measurements. This takes a few minutes.

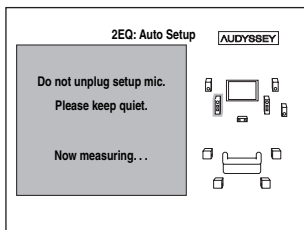

**6**

**When prompted, place the setup microphone at the next position, and repeat step 5.**

**7**

**When the measurements are complete, the following screen appears.**

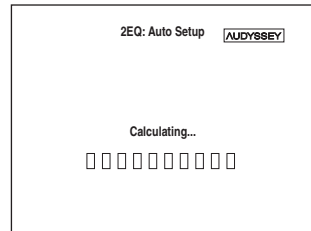

**8**

**When the calculations are complete, the following screen appears.**

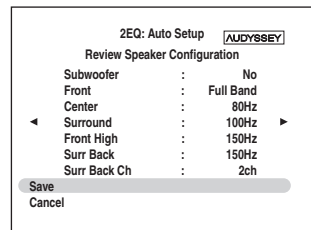

**Use the Up and Down [▲]/[▼] buttons to select an option, and then press [ENTER].**

The options are:

**Save:**

Save the calculated settings and exit the room correction and speaker setup.

**Cancel:**

Cancel the room correction and speaker setup.

**Note:**

You can view the calculated settings for the speaker configuration, speaker distances, and speaker levels by using the Left and Right [◀]/[▶] buttons.

**9**

If you selected “Save”, the results are saved, and the following screen appears.

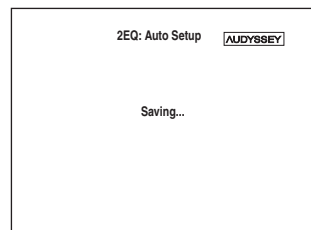

10

**Disconnect the speaker setup microphone.**

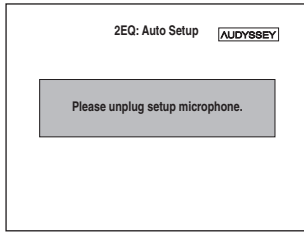

**Notes:**

- When the room correction and speaker setup is complete, the “Equalizer Settings” (page 69) will be set to “Audyssey” and the “Dynamic EQ” (page 71) will be set to “On”.
- You can cancel the Room Correction and Speaker Setup at any point in this procedure simply by disconnecting the setup microphone.

**Error Messages**

While the room correction and speaker setup is in progress, one of the following error messages may appear:

**❑ Ambient noise is too high.**

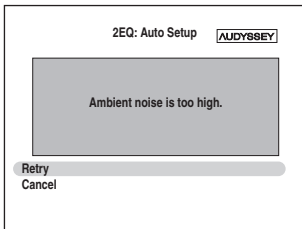

This message appears if the background noise is too loud and the measurements cannot be performed properly.

Remove the source of the noise and try again.

**Retry:** Return to the measured point immediately before and start set up again.

**Cancel:** Cancel the room correction and speaker setup.

**❑ Speaker Detect Error**

This message appears if a speaker is not detected. “Yes” means that a speaker was detected. “No” means that no speaker was detected.

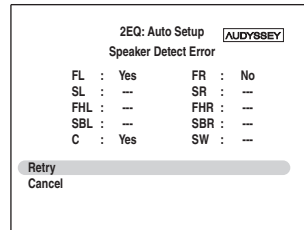

One of the front speakers has not been detected.

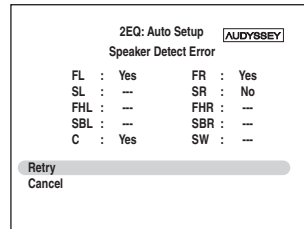

One of the surround speakers has not been detected.

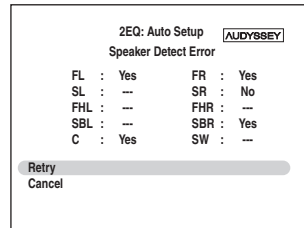

The surround back speakers have been detected but the surround speakers haven't.

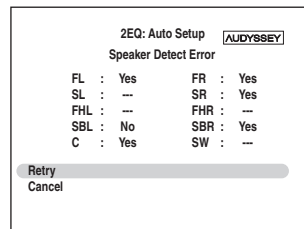

The right surround back speaker has been detected but the left surround back speaker hasn't.

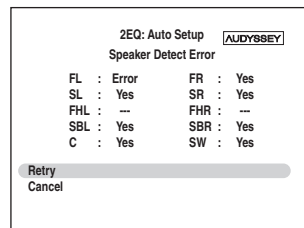

The speaker type detected does not match what was expected. The speaker may be or incorrect type or broken. Please check that it is the correct speaker type, or that all drivers are working.

### ❑ Speaker matching error!

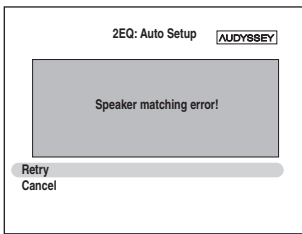

The number of speakers detected on the second or third measurement was different to the number detected on the first measurement.

Make sure speakers that cannot be detected are connected properly.

**Retry:** Return to step 2 and try again.

**Cancel:** Cancel the room correction and speaker setup.

### ❑ Writing Error!

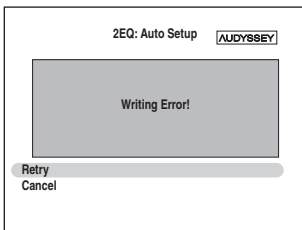

This message appears if saving fails.

Try saving again. If this message appears after 2 or 3 attempts, the AV receiver is probably malfunctioning. Contact your Onkyo dealer.

**Retry:** Return to step 2 and try again.

**Cancel:** Cancel the room correction and speaker setup.

## ***Changing the Speaker Settings Manually***

---

If you wish to make changes to the settings found during the room correction and speaker setup, follow the directions on pages 67–69.

## ***Using a Powered Subwoofer***

---

If you're using a powered subwoofer and it outputs very low-frequency sound at a low volume level, it may not be detected by the Audyssey 2EQ™ Room Correction and Speaker Setup.

If the “Subwoofer” appears on the “Review Speaker Configuration” screen as “No”, increase the subwoofer’s volume to the half-way point, set it to its highest crossover frequency, and then try running the Audyssey 2EQ Room Correction and Speaker Setup again. Note that if the volume is set too high and the sound distorts, detection issues may occur, so use an appropriate volume level. If the subwoofer has a low-pass filter switch, set it to Off or Direct. Refer to your subwoofer’s instruction manual for details.

# Basic Operations

## Selecting the Input Source

This section explains how to select the input source (i.e., the AV component that you want to listen to or watch).

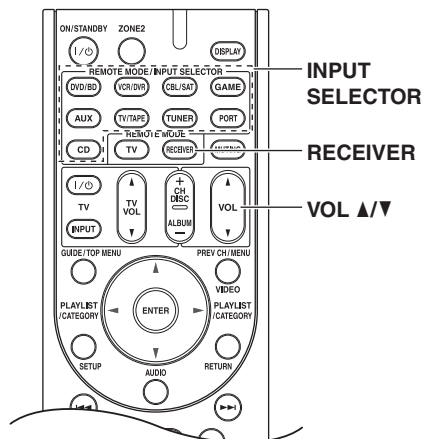
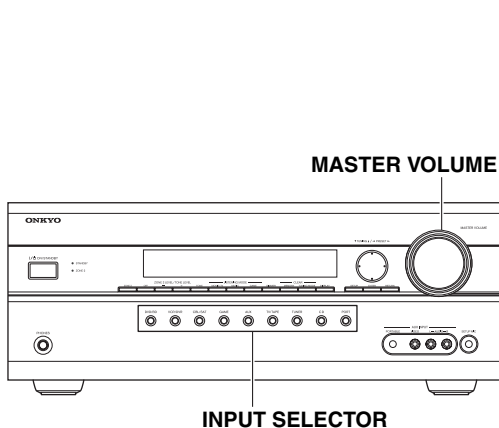

**1**

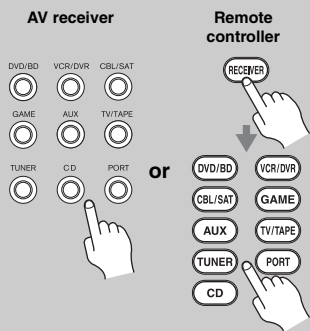

Use the AV receiver's input selector buttons to select the input source.

To select the input source with the remote controller, press the [RECEIVER] button, and then press the INPUT SELECTOR buttons.

**2**

**Start playback on the source component.**

When you select DVD/BD or another video component, on your TV, you'll need to select the video input that's connected to the AV receiver's HDMI OUT, COMPONENT VIDEO OUT or MONITOR OUT. On some DVD/BD players, you may need to turn on the digital audio output.

**3**

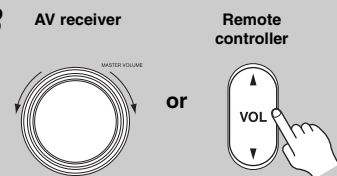

**To adjust the volume, use the MASTER VOLUME control, or the remote controller's VOL [▲]/[▼] button.**

The volume can be set to Min, 1 through 79, or Max.

The AV receiver is designed for home theater enjoyment. It has a wide volume range, allowing precise adjustment.

**4**

**Select a listening mode and enjoy!**

See "Using the Listening Modes" on page 59.

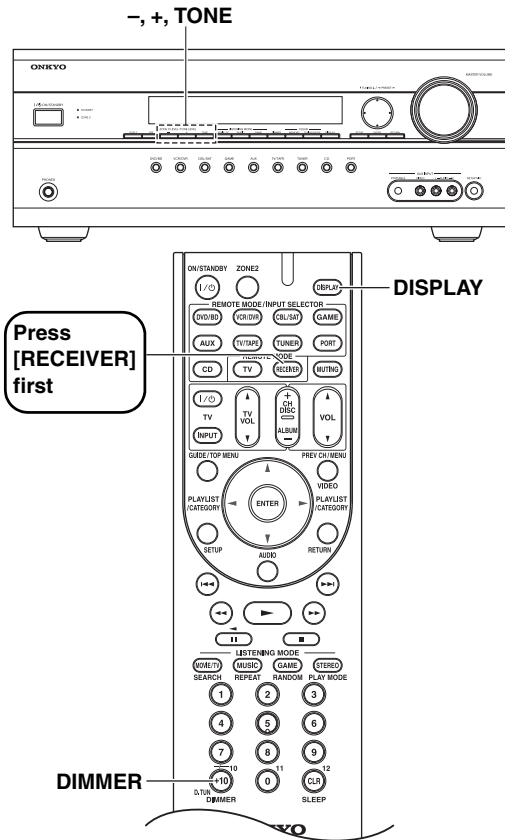

## Adjusting the Bass & Treble

You can adjust the bass and treble for the front speakers, except when the Direct listening mode is selected.

<b>1</b> AV receiver 	<b>Press the [TONE] button repeatedly to select either “Bass” or “Treble”.</b>
<b>2</b> 	<b>Use the TONE [-]/[+] buttons to adjust.</b>

■ **Bass**  
 You can boost or cut low-frequency sounds output by the front speakers from -10 dB to +10 dB in 2 dB steps.

■ **Treble**  
 You can boost or cut high-frequency sounds output by the front speakers from -10 dB to +10 dB in 2 dB steps.

**Note:**  
 This procedure can also be performed on the remote controller by using [AUDIO] button (see page 72).

## Displaying Source Information

You can display various information about the current input source as follows.

Remote controller 	<b>Press the [RECEIVER] button, and then press the [DISPLAY] button repeatedly to cycle through the available information.</b>
-----------------------	--

**Note:**  
 This procedure can also be performed on the AV receiver by using its [DISPLAY] button.

The following information can typically be displayed for input sources.

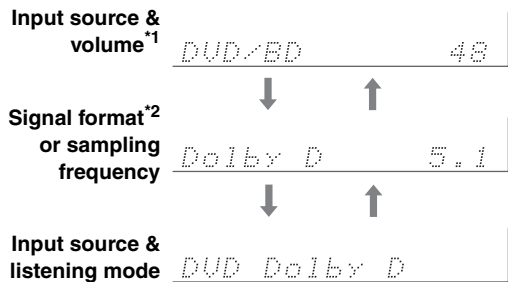

\*1 When AM or FM radio is used, the band, preset number, and frequency are displayed.  
 \*2 If the input signal is analog, no format information is displayed. If the input signal is PCM, the sampling frequency is displayed. If the input signal is digital but not PCM, the signal format is displayed.  
 Information is displayed for about three seconds, then the previously displayed information reappears.

## Setting the Display Brightness

You can adjust the brightness of the AV receiver’s display.

Remote controller 	<b>Press the [RECEIVER] button, and then press the [DIMMER] button repeatedly to select: dim, dimmer, or normal brightness.</b> Alternatively, you can use the AV receiver’s [DIMMER] button.
-----------------------	--

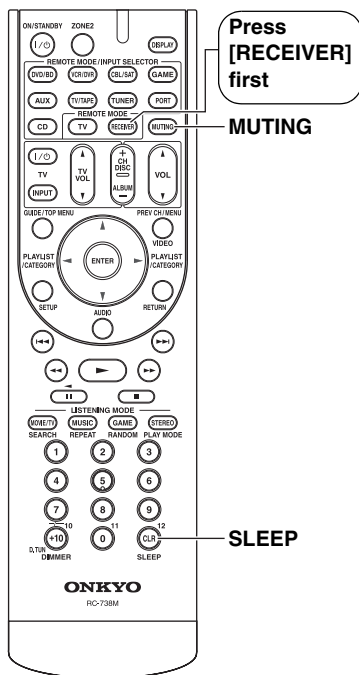

### Muting the AV receiver

You can temporarily mute the output of the AV receiver.



**Press the [RECEIVER] button, and then press the [MUTING] button.**

The output is muted and the MUTING indicator flashes on the display, as shown.



To unmute the AV receiver, press the [MUTING] button again, or adjust the volume.

The Mute function is cancelled when the AV receiver is set to Standby.

### Using the Sleep Timer

With the sleep timer, you can set the AV receiver to turn off automatically after a specified period.



**Press the [RECEIVER] button, and then press the [SLEEP] button repeatedly to select the required sleep time.**

The sleep time can be set from 90 to 10 minutes in 10 minute steps.

The SLEEP indicator appears on the display when the sleep timer has been set. The specified sleep time appears on the display for about five seconds, then the previous display reappears.

If you need to cancel the sleep timer, press the [SLEEP] button repeatedly until the SLEEP indicator disappears.

To check the time remaining until the AV receiver sleeps, press the [SLEEP] button. Note that if you press the [SLEEP] button while the sleep time is being displayed, you'll shorten the sleep time by 10 minutes.

### Using Headphones

You can connect a pair of stereo headphones (1/4-inch phone plug) to the AV receiver's PHONES jack for private listening, as shown.

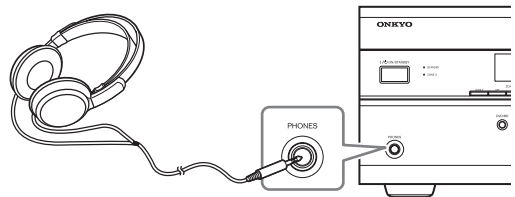

#### Notes:

- Always turn down the volume before connecting your headphones.
- While the headphones plug is inserted in the PHONES jack, the speakers are turned off. (The Powered Zone 2 speakers are not turned off.)
- When you connect a pair of headphones, the listening mode is set to Stereo, unless it's already set to Stereo, Mono, or Direct.
- Only the Stereo, Direct, and Mono listening modes can be used with headphones (the listening modes available also depend on the currently selected input source).



# Listening to the Radio

## Using the Tuner

With the built-in tuner you can enjoy AM and FM radio stations. You can store your favorite stations as presets for quick selection.

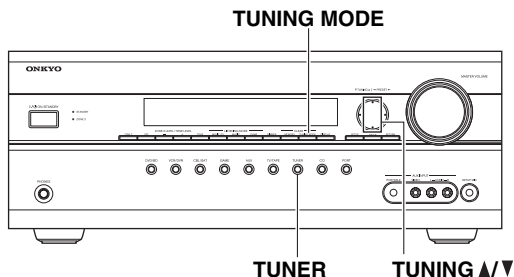

## Listening to the Radio

TUNER



**Use the [TUNER] input selector button to select either AM or FM.** In this example, FM has been selected. Each time you press the [TUNER] button, the input source changes between AM and FM.

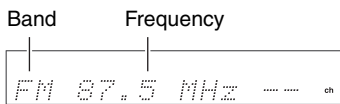

(Actual display depends on country.)

## Tuning into Radio Stations

### Auto Tuning Mode

1

TUNING MODE



**Press the [TUNING MODE] button so that the AUTO indicator appears on the display.**

2

TUNING ▲ / ▼ PRESET



**Press the TUNING Up or Down [▲]/[▼] buttons.** Searching stops when a station is found.

When tuned into a station, the TUNED indicator appears. When tuned into a stereo FM station, the FM STEREO indicator appears on the display, as shown.

FM STEREO

AUTO

FM STEREO  
AUTO ▶ TUNED ◀

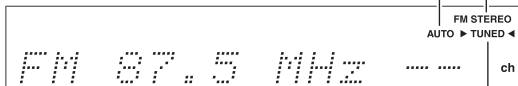

TUNED

### Manual Tuning Mode

1

TUNING MODE



**Press the [TUNING MODE] button so that the AUTO indicator disappears from the display.**

2

TUNING ▲ / ▼ PRESET



**Press and hold the TUNING Up or Down [▲]/[▼] buttons.**

The frequency stops changing when you release the button.

Press the buttons repeatedly to change the frequency one step at a time.

This model changes FM/AM frequency in 200k/10k (or 50k/9k) Hz steps.

In Manual Tuning mode, FM stations will be in mono.

### Tuning into weak FM stereo stations

If the signal from a stereo FM station is weak, it may be impossible to get good reception. In this case, switch to Manual Tuning mode and listen to the station in mono.

### Tuning into Stations by Frequency

You can tune into AM and FM stations directly by entering the appropriate frequency.

1

Remote controller

TUNER



**Press the [TUNER] button repeatedly to select AM or FM, followed by the [D.TUN] button.**

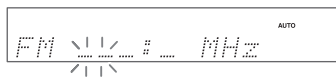

(Actual display depends on country.)

2

D.TUN





**Within 8 seconds, use the number buttons to enter the frequency of the radio station.**

For example, to tune to 87.5 (FM), press 8, 7, 5.

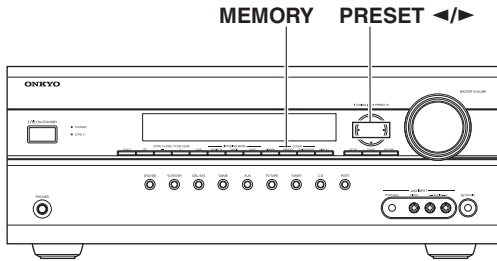
## Presetting AM/FM Stations

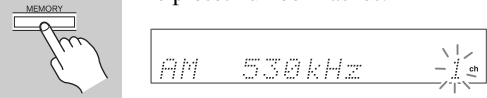

You can store a combination of up to 40 of your favorite AM/FM radio stations as presets.

- 1** Tune into the AM/FM station that you want to store as a preset.
- 2** Press the [MEMORY] button. The preset number flashes.
 
- 3** While the preset number is flashing (about 8 seconds), use the PRESET [<|/>] buttons to select a preset from 1 through 40.
 
- 4** Press the [MEMORY] button again to store the station or channel. The station or channel is stored and the preset number stops flashing. Repeat this procedure for all of your favorite AM/FM radio stations.
 

### Note:

You can name your radio presets for easy identification (see page 76). Its name is displayed instead of the band and frequency.

## Selecting Presets

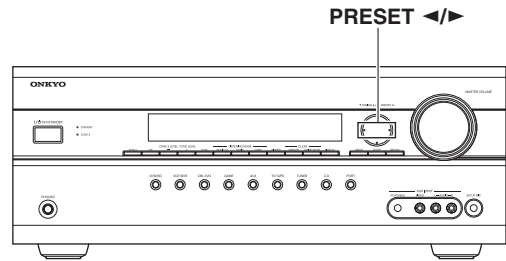

**AV receiver**  
T TUNING & / → PRESET ←



**Remote controller**



**You can also use the remote controller's number buttons to select a preset directly.**



## Deleting Presets

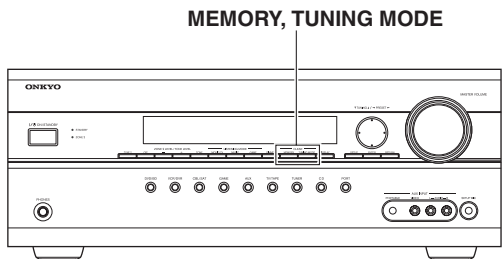

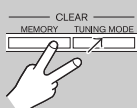
- 1** Select the preset that you want to delete. See the previous section.
- 2** While holding down the [MEMORY] button, press the [TUNING MODE] button. The preset is deleted and its number disappears from the display.
 

# UP-A1 series Dock for iPod

## About the UP-A1 series Dock

With the UP-A1 series Dock, you can easily play the music, photo, or movie stored on your Apple iPod through the AV receiver and enjoy great sound. You can use the AV receiver's remote controller to operate your iPod.

For the latest information on the Dock, see the Onkyo Web site at: [www.onkyo.com](http://www.onkyo.com)

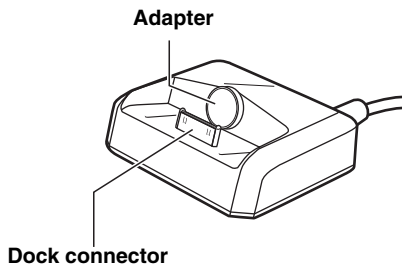

## Compatible iPod models

For information about which iPod models are supported by the UP-A1 series Dock, see the UP-A1 series Dock's instruction manual.

### Note:

Before using the UP-A1 series Dock, update your iPod with the latest software, available from the Apple Web site.

## Putting Your iPod in the Dock

- 1 Turn on the AV receiver, and select the [PORT] selector.
- 2 Align your iPod with the Dock connector and push it down so that it's fully seated.



## Adjusting the Adapter

The adapter needs to be adjusted to match your particular iPod. If there's a gap between the back of your iPod and the adapter, turn the adapter counterclockwise to close the gap. Turning the adapter counterclockwise moves it forward. Turning it clockwise moves it backward.

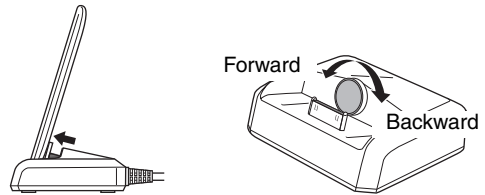

### Notes:

- Make sure that the output level of the AV receiver is set to minimum.
- To prevent damage to the dock connector, don't twist your iPod when inserting or removing it, and be careful not to knock over the dock while your iPod is inserted.
- Do not take off your iPod from the Dock when you play back the music, photo, or movie stored on your iPod.
- Don't use the UP-A1 with any other iPod accessories, such as FM transmitters and microphones, because they may cause a malfunction.
- It is recommended that you update your iPod software before using it with this unit. The updater for the iPod software is available at the Apple website.

## Function Overview

### Basic Operation

#### Note:

The AV receiver may take several seconds to startup, so you might not hear the first few seconds of the first song.

#### Auto Power On Function

If you start iPod playback while the AV receiver is on Standby, the AV receiver will automatically turn on and select your iPod as the input source. Then, your iPod will start playback.

#### Direct Change Function

If you start iPod playback while listening to another input source, the AV receiver will automatically select your iPod as the input source.

#### Using the AV receiver's Remote Controller

You can use the AV receiver's remote controller to control basic iPod functions.

### Operating Notes:

- Before selecting a different input source, stop iPod playback to prevent the AV receiver from selecting the iPod input source by mistake.
- If any accessories are connected to your iPod, the AV receiver may not be able to select the input source properly.
- While your iPod is in the UP-A1 series Dock, its volume control has no effect. If you adjust your iPod models volume control while it's in the UP-A1 series Dock, make sure it's not set too high before you reconnect your headphones.

### ■ Using Your iPod models Alarm Clock

You can use your iPod models Alarm Clock function to automatically turn on your iPod and the AV receiver at a specified time. The AV receiver's input source will automatically be set to the [PORT] selector.

#### Notes:

- To use this function, your iPod must be in the UP-A1 series Dock, and the UP-A1 series Dock must be connected to the AV receiver.
- When you use this function, be sure to set the AV receiver's volume control to a suitable level.
- The AV receiver may take several seconds to startup, so you might not hear the first few seconds of the first song.

### ■ Charging Your iPod models Battery

The UP-A1 series Dock charges your iPod models battery while your iPod is in the UP-A1 series Dock and connected to the UNIVERSAL PORT jacks on the AV receiver. While your iPod is seated in the UP-A1 series Dock, its battery will be charged when the AV receiver is set to "On" or "Standby".

#### Note:

When UP-A1 series Dock that seated iPod is connected, the power consumption on standby mode slightly increases.

## Controlling iPod

By pressing the REMOTE MODE button that's been programmed with the remote control code for your Dock, you can control your iPod in the Dock with the following buttons.

The [PORT] button is preprogrammed with the remote control code for controlling a Dock with Universal Port connector.

For details on entering a remote control code, see page 88.

### When Using a Dock with Universal Port connector:

- Connect the Dock to the UNIVERSAL PORT jack.
- See to the Dock's instruction manual for more information.

You can control your iPod when "PORT" is selected as the input source.

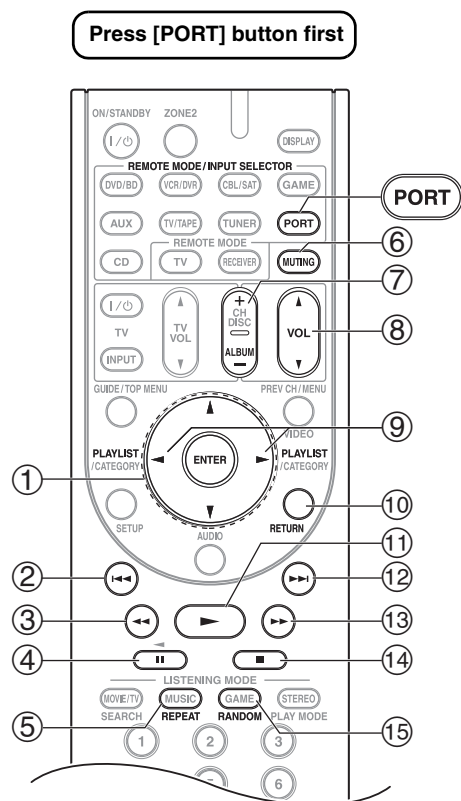

#### Note:

For detailed operation of the iPod, please refer to the instruction manual.

## UP-A1 series Dock for iPod—Continued

- ① **Arrow [▲]/[▼] and ENTER buttons**  
Used to navigate menus and select items.
- ② **Previous [◀◀] button**  
Restarts the current song. Press it twice to select the previous song.
- ③ **Rewind [◀◀] button**  
Press and hold to rewind.
- ④ **Pause [⏸] button**  
Pauses playback.
- ⑤ **REPEAT button**  
Used with the repeat function.
- ⑥ **MUTING button (52)**  
Mutes or unmutes the AV receiver.
- ⑦ **ALBUM +/- button**  
Selects the next or previous album.
- ⑧ **VOL [▲]/[▼] button (50)**  
Adjusts the volume of the AV receiver.
- ⑨ **PLAYLIST [◀]/[▶] buttons**  
Selects the previous or next playlist on the iPod.
- ⑩ **RETURN button**  
Exits the menu or returns to the previous menu.
- ⑪ **Play [▶] button**  
Starts playback. If the component is off, it will turn on automatically.
- ⑫ **Next [▶▶] button**  
Selects the next song.
- ⑬ **Fast Forward [▶▶▶] button**  
Press and hold to fast forward.
- ⑭ **Stop [■] button**  
Stops playback and displays a menu.
- ⑮ **RANDOM button**  
Used with the shuffle function.

### Status messages

- The AV receiver is checking the connection with the dock**



PORT Reading

- The AV receiver does not support the connected dock**



PORT NotSupport

- UP-A1 series Dock is connected**



PORT UP-A1

Your iPod is properly stationed in a UP-A1 series Dock connected to the UNIVERSAL PORT jack of this unit, and the connection between your iPod and this unit is complete.

When connection is confirmed, “UP-A1” is displayed for about 8 seconds.

- Dock is not connected**



PORT

Your iPod was removed from a UP-A1 series Dock connected to the UNIVERSAL PORT jack of this unit.

#### Note:

When the status message is not displayed on the AV receiver’s display, check the connection to your iPod.

# Recording

This section explains how to record the selected input source to a component with recording capability, and how to record audio and video from different sources.

## Notes:

- The surround sound and DSP listening modes cannot be recorded.
- Copy-protected DVDs cannot be recorded.
- Only analog inputs can be recorded.
- DTS signals will be recorded as noise, so don't attempt analog recording of DTS CDs or LDs.

## AV Recording

Audio sources can be recorded to a recorder (e.g., cassette deck, CDR, MD) connected to the TV/TAPE OUT jack. Video sources can be recorded to a video recorder (e.g., VCR, DVD recorder) connected to the VCR/DVR OUT jack. See page 29 or 34 for hookup information.

<b>1</b>	<p><b>Use the input selector buttons to select the source that you want to record.</b></p> <p>You can watch the source while recording. The AV receiver's MASTER VOLUME control has no effect on recording.</p> 
<b>2</b>	<p><b>On your recorder, start recording.</b></p>
<b>3</b>	<p><b>On the source component, start playback.</b></p> <p>If you select another input source during recording, that input source will be recorded.</p>

## Recording Separate AV Sources

Here you can record audio and video from completely separate sources, allowing you to overdub audio onto your video recordings. This function takes advantage of the fact that when an audio-only input source (i.e., TV/TAPE, CD) is selected, the video input source remains unchanged.

In the following example, audio from the CD player connected to the CD IN, and video from the camcorder connected to the AUX INPUT VIDEO jack are recorded by the VCR connected to the VCR/DVR OUT jacks.

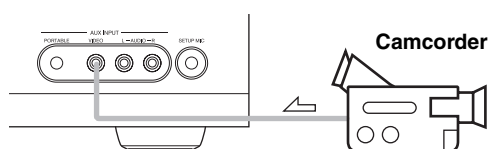

↙ : video signal  
↘ : audio signal

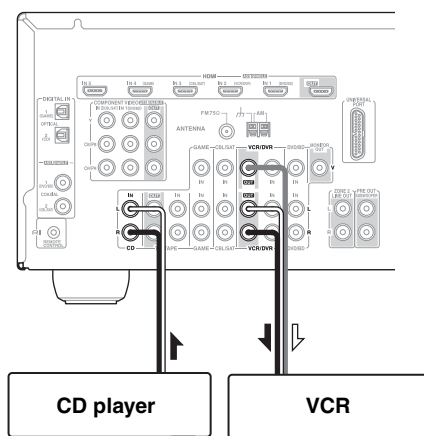

- 1 Prepare the camcorder and CD player for playback.**
- 2 Prepare the VCR for recording.**
- 3 Press the [AUX] input selector button.**
- 4 Press the [CD] input selector button.**  
This selects the CD player as the audio source, but leaves the camcorder as the video source.
- 5 Start recording on the VCR and start playback on the camcorder and CD player.**  
The video from the camcorder and the audio from the CD player are recorded by the VCR.

# Using the Listening Modes

## Selecting Listening Modes

See “About the Listening Modes” on page 64 for detailed information about the listening modes.

- The Dolby Digital and DTS listening modes can only be selected if your DVD/BD player is connected to the AV receiver with a digital audio connection (coaxial, optical, or HDMI).
- The listening modes you can select depends on the format of the input signal. To check the format, see “Displaying Source Information” on page 51.
- While a pair of headphones is connected, you can only select the Mono, Direct, or Stereo listening mode.

## Selecting on the AV receiver

LISTENING MODE buttons

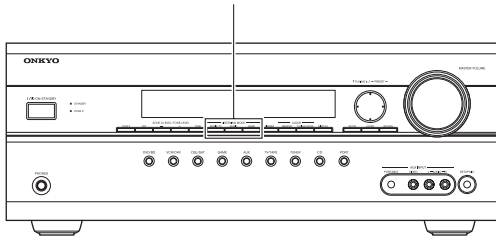

### ■ LISTENING MODE buttons

#### [MOVIE/TV] button

This button selects the listening modes intended for use with movies and TV.

#### [MUSIC] button

This button selects the listening modes intended for use with music.

#### [GAME] button

This button selects the listening modes intended for use with video games.

## Selecting with the Remote Controller

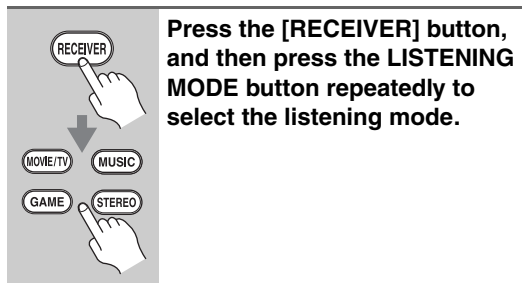
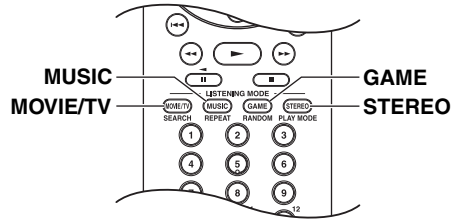

Press the [RECEIVER] button, and then press the LISTENING MODE button repeatedly to select the listening mode.

### ■ LISTENING MODE buttons

#### [MOVIE/TV] button

This button selects the listening modes intended for use with movies and TV.

#### [MUSIC] button

This button selects the listening modes intended for use with music.

#### [GAME] button

This button selects the listening modes intended for use with video games.

#### [STEREO] button

This button selects the Stereo listening mode and All Channel Stereo listening mode.

**Listening Modes Available for Each Source Format**

The Speaker layout illustration shows which speakers are set to active in the “Speaker Configuration” setting (see page 67) and the “Speaker Type” setting (see page 42).

The LISTENING MODE button illustration shows that listening modes can be selected.

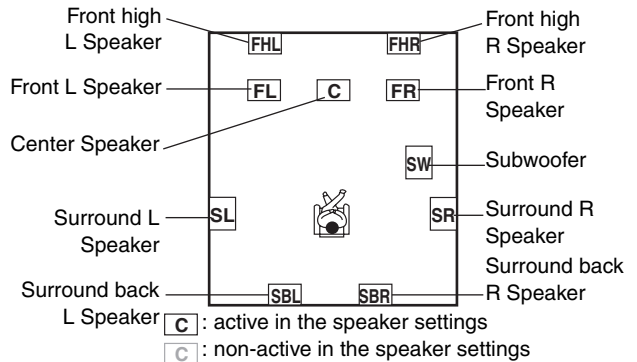

**Mono/Multiplex Sources**

✓: Available Listening Modes

Listening Mode	Button	Speaker layout			
Direct	MOVIE/TV MUSIC GAME	✓	✓	✓	✓
Stereo	STEREO MUSIC	✓	✓	✓	✓
Mono	MOVIE/TV	✓	✓	✓	✓
Orchestra	MUSIC			✓	✓ <sup>*1</sup>
Unplugged	MUSIC			✓	✓ <sup>*1</sup>
Studio-Mix	MUSIC			✓	✓ <sup>*1</sup>
TV Logic	MOVIE/TV			✓	✓ <sup>*1</sup>
Game-RPG	GAME			✓	✓ <sup>*1</sup>
Game-Action	GAME			✓	✓ <sup>*1</sup>
Game-Rock	GAME			✓	✓ <sup>*1</sup>
Game-Sports	GAME			✓	✓ <sup>*1</sup>
AllChStereo	MOVIE/TV MUSIC GAME STEREO		✓	✓	✓ <sup>*1</sup>
FullMono	MOVIE/TV MUSIC GAME		✓	✓	✓ <sup>*1</sup>
T-D (Theater-Dimensional)	MOVIE/TV GAME	✓	✓	✓	✓

**Notes:**

\*1 Which Front high speakers or Surround back speakers outputs the sound is switched by the “SpLayout” setting on page 73.

- Available sampling rate for PCM input signal is 32/44.1/48/88.2/96/176.4/192kHz.
- The listening modes cannot be selected with some source formats.



# Using the Listening Modes—Continued

## Stereo Source

✓: Available Listening Modes

Listening Mode	Button	Speaker layout			
Direct		✓	✓	✓	✓
Stereo		✓	✓	✓	✓
Mono		✓	✓	✓	✓
PLII/PLIIX Movie*2			✓	✓	✓ (Surround Back)
PLII/PLIIX Music*2			✓	✓	✓ (Surround Back)
PLII/PLIIX Game*2			✓	✓	✓ (Surround Back)
PLIIZ Height					✓ (Front High)
Neo:6 Cinema			✓	✓	✓ (Surround Back)
Neo:6 Music			✓	✓	✓ (Surround Back)
Orchestra				✓	✓*1
Unplugged				✓	✓*1
Studio-Mix				✓	✓*1
TV Logic				✓	✓*1
Game-RPG				✓	✓*1
Game-Action				✓	✓*1
Game-Rock				✓	✓*1
Game-Sports				✓	✓*1
AllChStereo	 		✓	✓	✓*1
FullMono			✓	✓	✓*1
T-D (Theater-Dimensional)		✓	✓	✓	✓

**Notes:**

\*1 Which Front high speakers or Surround back speakers outputs the sound is switched by the “SpLayout” setting on page 73.

\*2 If there are no surround back speakers, or Powered Zone 2 is being used, Dolby Pro Logic II is used.

- Available sampling rate for PCM input signal is 32/44.1/48/88.2/96/176.4/192kHz.
- The listening modes cannot be selected with some source formats.

# Using the Listening Modes—Continued

## 5.1 channel Sources

✓: Available Listening Modes

Listening Mode	Button	Speaker layout			
<b>Direct</b>		✓	✓	✓	✓
<b>Stereo</b>		✓	✓	✓	✓
<b>Mono</b>		✓	✓	✓	✓
<b>DolbyDigital/ DolbyDigital Plus/TrueHD/ Multichannel/ DTS/DTS-HD High Resolution Audio/DTS-HD Master Audio/ DTS Express/ DSD*2</b>			✓	✓	✓
<b>Neo:6</b>					✓ (Surround Back)
<b>PLIIx Movie</b>					✓ (Surround Back)
<b>PLIIx Music</b>					✓ (Surround Back)
<b>PLIIz Height</b>					✓ (Front High)
<b>DolbyEX</b>					✓ (Surround Back)
<b>Orchestra</b>				✓	✓*1
<b>Unplugged</b>				✓	✓*1
<b>Studio-Mix</b>				✓	✓*1
<b>TV Logic</b>				✓	✓*1
<b>Game-RPG</b>				✓	✓*1
<b>Game-Action</b>				✓	✓*1
<b>Game-Rock</b>				✓	✓*1
<b>Game-Sports</b>				✓	✓*1
<b>AllChStereo</b>	 		✓	✓	✓*1
<b>FullMono</b>			✓	✓	✓*1
<b>T-D (Theater- Dimensional)</b>		✓	✓	✓	✓

### Notes:

\*1 Which Front high speakers or Surround back speakers outputs the sound is switched by the “SpLayout” setting on page 73.

\*2 AV receiver can input the DSD signal from HDMI IN. Setting the output setting on the player side to PCM might obtain a better sound according to the player. In that case, set the output setting on the player side to PCM.

- Available sampling rate for PCM input signal is 32/44.1/48/88.2/96/176.4/192kHz.
- The listening modes cannot be selected with some source formats.

# Using the Listening Modes—Continued

## 7.1 channel Sources

✓: Available Listening Modes

Listening Mode	Button	Speaker layout			
Direct		✓	✓	✓	✓ <sup>*2</sup> (Surround Back)
Stereo		✓	✓	✓	✓
Mono		✓	✓	✓	✓
Multichannel/ DolbyDigital Plus/TrueHD/ DTS-HD High Resolution Audio/DTS-HD Master Audio			✓	✓	✓ <sup>*2</sup> (Surround Back)
PLIIz Height					✓ (Front High)
Orchestra				✓	✓ <sup>*1</sup>
Unplugged				✓	✓ <sup>*1</sup>
Studio-Mix				✓	✓ <sup>*1</sup>
TV Logic				✓	✓ <sup>*1</sup>
Game-RPG				✓	✓ <sup>*1</sup>
Game-Action				✓	✓ <sup>*1</sup>
Game-Rock				✓	✓ <sup>*1</sup>
Game-Sports				✓	✓ <sup>*1</sup>
AllChStereo			✓	✓	✓ <sup>*1</sup>
FullMono			✓	✓	✓ <sup>*1</sup>
T-D (Theater- Dimensional)		✓	✓	✓	✓

## DTS-ES Discrete/Matrix Sources

DTS-ES Discrete					✓ (Surround Back)
DTS-ES Matrix					✓ (Surround Back)

### Notes:

\*1 Which Front high speakers or Surround back speakers outputs the sound is switched by the “SpLayout” setting on page 73.

\*2 When the input source contains the encoded front high channel, front high speakers output the sound.

- Available sampling rate for PCM input signal is 32/44.1/48/88.2/96/176.4/192kHz.
- The listening modes cannot be selected with some source formats.

### About the Listening Modes

The AV receiver's listening modes can transform your listening room into a movie theater or concert hall, with high fidelity and stunning surround sound.

#### Direct

In this mode, audio from the input source is output directly with minimal processing, providing high-fidelity reproduction. All of the source's audio channels are output as they are.

#### Stereo

Sound is output by the front left and right speakers and subwoofer.

#### Mono

Use this mode when watching an old movie with a mono soundtrack, or use it with the foreign language soundtracks recorded in the left and right channels of some movies. It can also be used with DVDs or other sources containing multiplexed audio, such as karaoke DVDs.

#### Multichannel

This mode is for use with PCM multichannel sources.

#### Dolby Pro Logic IIx

##### Dolby Pro Logic II

**Dolby Pro Logic IIx** expands any 2-channel source for 7.1-channel playback. It provides a very natural and seamless surround-sound experience that fully envelops the listener. As well as music and movies, video games can also benefit from the dramatic spatial effects and vivid imaging. If you're not using any surround back speakers, **Dolby Pro Logic II** will be used instead of Dolby Pro Logic IIx.

- **Dolby PLIIx Movie**  
Use this mode with any stereo or Dolby Surround (Pro Logic) movie (e.g., TV, DVD, VHS).
- **Dolby PLIIx Music**  
Use this mode with any stereo or Dolby Surround (Pro Logic) music source (e.g., CD, radio, cassette, TV, VHS, DVD).
- **Dolby PLIIx Game**  
Use this mode with video games, especially those that bear the Dolby Pro Logic II logo.

#### Dolby Pro Logic IIz Height

**Dolby Pro Logic IIz Height** is designed to more effectively use existing program material when height channel speaker outputs are present. **Dolby Pro Logic IIz Height** can be used to upmix a variety of sources from movies and music, but are particularly well-suited to upmix game content.

#### Dolby Digital

Use this mode with DVDs that bear the Dolby Digital logo, and Dolby Digital TV broadcasts. This is the most common digital surround-sound format, and it'll put you right in the middle of the action, just like being in a movie theater or concert hall.

#### 5.1-channel source + Dolby EX

These modes expand 5.1-channel sources for 6.1/7.1-channel playback. They're especially suited to Dolby EX soundtracks that include a matrix-encoded surround back channel. The additional channel adds an extra dimension and provides an enveloping surround sound experience, perfect for rotating and fly-by sound effects.

#### Dolby Digital Plus

Developed for use with HDTV, including the new video disc formats Blu-ray and HD DVD, this is the latest multichannel audio format from Dolby. It supports up to 7.1 channels with 48 kHz sampling rate.

#### Dolby TrueHD

Designed to take full advantage of the additional storage space offered by the new Blu-ray and HD DVD disc formats, this new Dolby format offers up to 7.1 discrete channels of digital audio with 48/96 kHz, up to 5.1-channels with 192 kHz sampling rate.

#### 5.1-channel source + Dolby PLIIx Music

These modes use the Dolby Pro Logic IIx Music mode to expand 5.1-channel sources for 6.1/7.1-channel playback.

#### 5.1-channel source + Dolby PLIIx Movie

These modes use the Dolby Pro Logic IIx Movie mode to expand 5.1-channel sources for 7.1-channel playback.

#### DTS

The DTS digital surround-sound format supports up to 5.1 discrete channels and uses less compression for high-fidelity reproduction. Use it with DVDs and CDs that bear the DTS logo.

#### DTS 96/24

This mode is for use with DTS 96/24 sources. This is high-resolution DTS with a 96 kHz sampling rate and 24-bit resolution, providing superior fidelity. Use it with DVDs that bear the DTS 96/24 logo.

#### DTS-ES Discrete

This mode is for use with DTS-ES Discrete soundtracks, which use a discrete surround back channel for true 6.1/7.1-channel playback. The seven totally separate audio channels provide better spatial imaging and 360-degree sound localization, perfect for sounds that pan across the surround channels. Use it with DVDs that bear the DTS-ES logo, especially those with a DTS-ES Discrete soundtrack.

#### DTS-ES Matrix

This mode is for use with DTS-ES Matrix soundtracks, which use a matrix-encoded back-channel for 6.1/7.1-channel playback. Use it with DVDs that bear the DTS-ES logo, especially those with a DTS-ES Matrix soundtrack.

### **DTS Neo:6**

This mode expands any 2-channel source for up to 7.1-channel playback. It uses seven full-bandwidth channels of matrix decoding for matrix-encoded material, providing a very natural and seamless surround sound experience that fully envelops the listener.

- **Neo:6 Cinema**

Use this mode with any stereo movie (e.g., TV, DVD, VHS).

- **Neo:6 Music**

Use this mode with any stereo music source (e.g., CD, radio, cassette, TV, VHS, DVD).

### **5.1-channel source + Neo:6**

This mode uses Neo:6 to expand 5.1-channel sources for 6.1/7.1-channel playback.

### **DTS-HD High Resolution Audio**

Developed for use with HDTV, including the new video disc formats Blu-ray and HD DVD, this is the latest multichannel audio format from DTS. It supports up to 7.1 channels with 96 kHz sampling rate.

### **DTS-HD Master Audio**

Designed to take full advantage of the additional storage space offered by the new Blu-ray and HD DVD disc formats, this new DTS format offers up to 7.1 discrete channels of digital audio with 48/96 kHz, up to 5.1-channels with 192 kHz sampling rate.

### **DTS Express**

This format supports up to 5.1 channels and a lower sampling rate of 48 kHz. Applications include interactive audio and commentary encoding for HD DVD Sub Audio and Blu-ray Secondary Audio. Also broadcast and media servers.

### **DSD**

DSD stands for Direct Stream Digital and is the format used to store digital audio on Super Audio CDs (SACD). This mode can be used with SACDs that feature multichannel audio.

## **Onkyo Original DSP Modes**

---

### **Orchestra**

Suitable for classical or operatic music, this mode emphasizes the surround channels in order to widen the stereo image, and simulates the natural reverberation of a large hall.

### **Unplugged**

Suitable for acoustic instruments, vocals, and jazz, this mode emphasizes the front stereo image, giving the impression of being right in front of the stage.

### **Studio-Mix**

Suitable for rock or pop music, listening to music in this mode creates a lively sound field with a powerful acoustic image, like being at a club or rock concert.

### **TV Logic**

This mode adds realistic acoustics to TV shows produced in a TV studio, surround effects to the entire sound, and clarity to voices.

### **Game-RPG**

Use this mode when playing role playing game discs.

### **Game-Action**

Use this mode when playing action game discs.

### **Game-Rock**

Use this mode when playing rock game discs.

### **Game-Sports**

Use this mode when playing sports game discs.

### **All Ch Stereo**

Ideal for background music, this mode fills the entire listening area with stereo sound from the front, surround, and surround back speakers.

### **Full Mono**

In this mode, all speakers output the same sound in mono, so the sound you hear is the same regardless of where you are within the listening room.

### **T-D (Theater-Dimensional)**

With this mode you can enjoy a virtual surround sound even with only two or three speakers. This works by controlling how sounds reach the listener's left and right ears. Good results may not be possible if there's too much reverb, so we recommend that you use this mode in an environment with little or no natural reverb.

# Advanced Setup

## Onscreen Setup Menus

The onscreen setup menus appear on the connected TV and provide a convenient way to change the AV receiver's various settings. Settings are organized into nine categories on the **main menu**, most containing a **submenu**.

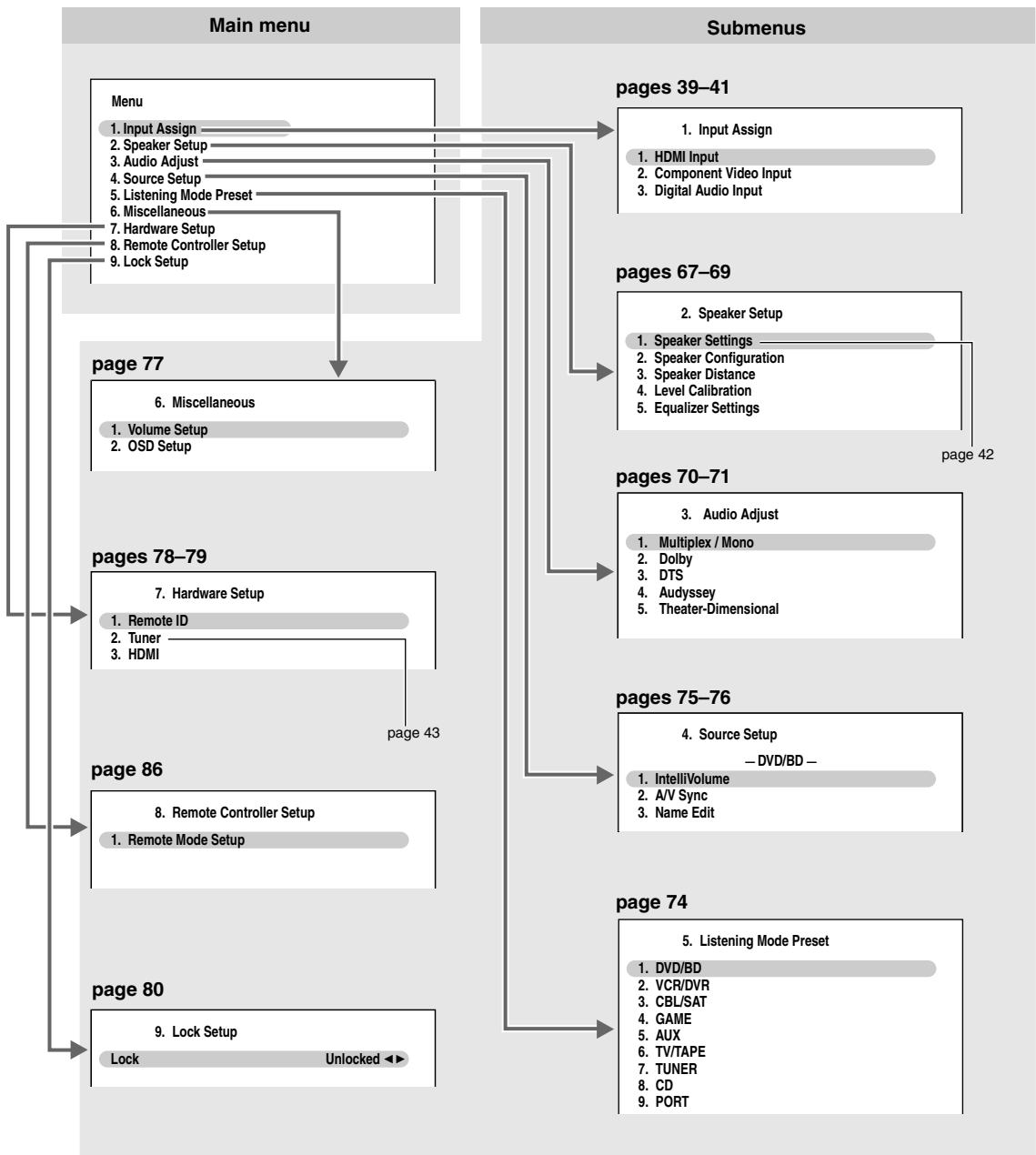

**Common Procedures in Setup Menu**

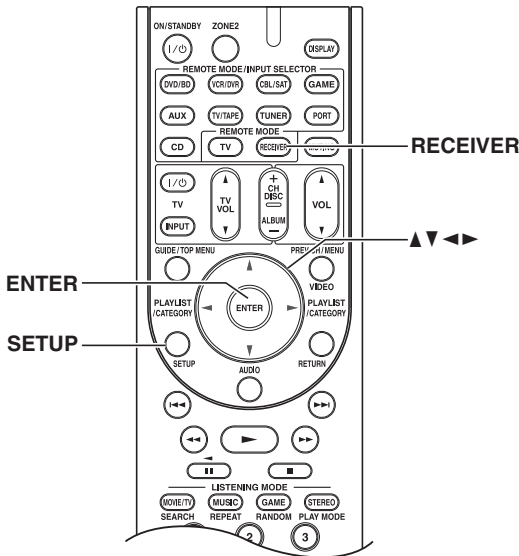

- 1** Press the [RECEIVER] button followed by the [SETUP] button.  
The main menu appears onscreen.  
If the main menu doesn't appear, make sure the appropriate external input is selected on your TV.

---

- 2** Use the Up and Down [▲]/[▼] buttons to select main menu, and then press [ENTER].

---

- 3** Use the Up and Down [▲]/[▼] buttons to select the function, and then press [ENTER].

---

- 4** Use the Up and Down [▲]/[▼] buttons to select setting, and then use the Left and Right [◀]/[▶] buttons to set them.

---

- 5** When you've finished, press the [SETUP] button.  
The setup menu closes.

**Speaker Setup**

Some of the settings in this section are set automatically by the Audyssey 2EQ™ Room Correction and Speaker Setup function (see page 45).

Here you can check the settings made by the Audyssey 2EQ Room Correction and Speaker Setup function, or set them manually, which is useful if you change one of the connected speakers after using the Audyssey 2EQ Room Correction and Speaker Setup function.

**Note:**

The Speaker Setup cannot be carried out while headphones are connected to the AV receiver.

**Speaker Settings**

See "Speaker Settings" on page 42.

**Speaker Configuration**

With these settings, you can specify which speakers are connected and a crossover frequency for each speaker. Specify "Full Band" for speakers that can output low frequency bass sounds adequately, for example, speakers with a good sized woofer. For smaller speakers, specify a crossover frequency. Sounds below the crossover frequency will be output by the subwoofer instead of the speaker. Refer to your speaker's manuals to determine the optimum crossover frequencies.

<b>Subwoofer</b>	<b>Yes:</b> Select if a subwoofer is connected (default). <b>No:</b> Select if no subwoofer is connected.
<b>Front<sup>*1</sup></b>	<b>Full Band, 40Hz to 100Hz (default), 120Hz, 150Hz, 200Hz</b>
<b>Center<sup>*2</sup></b>	<b>Full Band, 40Hz to 100Hz, 120Hz, 150Hz, 200Hz</b>
<b>Surround<sup>*2</sup></b>	<b>None:</b> Select if no speaker is connected.
<b>Front High<sup>*2*3*5*6</sup></b>	
<b>Surr Back<sup>*3*4*5*7</sup></b>	
<b>Surr Back CH<sup>*8</sup></b>	<b>1ch:</b> Select if only one surround back L speaker is connected. <b>2ch:</b> Select if two (left and right) surround back speakers are connected (default).

---

**LPF of LFE**                    **80Hz, 90Hz, 100Hz (default), 120Hz**

(Low-Pass Filter for the LFE Channel)

This setting is not set automatically by the Audyssey 2EQ™ Room Correction and Speaker Setup function (see page 45).

With this setting, you can specify the cutoff frequency of the LFE channel's low-pass filter (LPF), which can be used to filter out unwanted hum. The LPF only applies to sources that use the LFE channel.

---

**Double Bass**<sup>\*9</sup>

This setting is not set automatically by the Audyssey 2EQ Room Correction and Speaker Setup function (see page 45).

With the Double Bass function, you can boost bass output by feeding bass sounds from the front left, right, and center channels to the subwoofer.

**On:** Double Bass function on (default).

**Off:** Double Bass function off.

---

**Notes:**

- \*1 If the "Subwoofer" setting is set to "No", the "Front" setting is fixed at "Full Band".
  - \*2 If the "Front" setting is set to anything other than "Full Band", "Full Band" cannot be selected here.
  - \*3 If the "Surround" setting is set to "None", this setting cannot be selected.
  - \*4 If the "Surround" setting is set to anything other than "Full Band", "Full Band" cannot be selected here.
  - \*5 If the "Speaker Type" setting is set to "Bi-Amp" (page 42), or Powered Zone 2 is being used (page 83), this setting cannot be selected.
  - \*6 If the "SurrBack/FrontHigh" setting is set to "SurrBack" (page 42), this setting cannot be selected.
  - \*7 If the "SurrBack/FrontHigh" setting is set to "FrontHigh" (page 42), this setting cannot be selected.
  - \*8 If the "Surr Back" Setting is set to "None" (page 67), this setting cannot be selected.
  - \*9 This function can be set only if the "Subwoofer" setting is set to "Yes", and the "Front" setting is set to "Full Band".
- 

**Speaker Distance**

This setting is set automatically by the Audyssey 2EQ Room Correction and Speaker Setup function (see page 45). Here you can specify the distance from each speaker to the listening position so that the sound from each speaker arrives at the listener's ears as the sound designer intended.

---

**Unit**                                    **feet:** Distances can be set in feet. Range: 1 to 30 feet in 1-foot steps.

**meters:** Distances can be set in meters. Range: 0.3 to 9 meters in 0.3-meter steps.

---

**Left, Front High Left, Center, Front High Right, Right, Surr Right, Surr Back R,  
Surr Back L, Surr Left, Subwoofer**

Specify the distance from the each speaker to your listening position.

**Note:**

Speakers that you set to "No" or "None" in the Speaker Configuration (page 67) cannot be selected.

---

**Notes:**

- The Center, Subwoofer and Front High distances can be set up to 5 ft. (1.5 m) more or less than the Left distance. For example, if the Left distance is set to 20 ft. (6 m), the Center, Subwoofer, Front High Left and Front High Right distances can be set between 15 and 25 ft. (4.5 and 7.5 m).
- The Surround and Surround Back distances can be set up to 5 ft. (1.5 m) more or 15 ft. (4.5 m) less than the Left distance. For example, if the Left distance is set to 20 ft. (6 m), the Surr Right, Surr Left, Surr Back R, and Surr Back L distances can be set between 5 and 25 ft. (1.5 and 7.5 m).



### Level calibration

This setting is set automatically by the Audyssey 2EQ™ Room Correction and Speaker Setup function (see page 45). Here you can adjust the level of each speaker with the built-in test tone so that the volume of each speaker is the same at the listening position.

**Left, Front High Left, Center, Front High Right, Right, Surr Right, Surr Back R,  
Surr Back L, Surr Left, Subwoofer**

The levels can be adjusted from -12 to +12 dB in 1 dB steps (-15 to +12 dB for the subwoofer).

**Note:**

Speakers that you set to “No” or “None” in the “Speaker Configuration” (page 67) do not output the test tone.

**Note:**

The speakers cannot be calibrated while the output of the AV receiver is muted.

**Tip:**

If you’re using a handheld sound level meter, adjust the level of each speaker so that it reads 75 dB SPL at the listening position, measured with C-weighting and slow reading.

### Equalizer Settings

This setting is set automatically by the Audyssey 2EQ Room Correction and Speaker Setup function (see page 45). With the Equalizer settings, you can adjust the tone of speakers individually with a 5-band equalizer. The volume of each speaker can be set on page 69.

**Notes:**

- You can select: “63Hz”, “250Hz”, “1000Hz”, “4000Hz”, or “16000Hz”. And for the subwoofer, “25Hz”, “40Hz”, “63Hz”, “100Hz”, or “160Hz”.
- While the Direct listening mode is selected, the equalizer settings have no effect.

**Equalizer**      **Manual:** You can adjust the equalizer for each speaker manually. If you selected “Manual”, continue with this procedure.

<b>1</b>	<b>Press the Down [▼] button to select “Channel”, and then use the Left and Right [◀]/[▶] buttons to select a speaker.</b>
<b>2</b>	<b>Use the Up and Down [▲]/[▼] buttons to select a frequency, and then use the Left and Right [◀]/[▶] buttons to adjust the level at that frequency.</b> The volume at each frequency can be adjusted from -6 to +6 dB in 1 dB steps. <b>Tip:</b> Low frequencies (e.g., 63Hz) affect bass sounds; high frequencies (e.g., 16000Hz) affect treble sounds.
<b>3</b>	<b>Use the Up [▲] button to select “Channel”, and then use the Left and Right [◀]/[▶] buttons to select another speaker.</b> Repeat steps 1 and 2 for each speaker. Speakers that you set to “No” or “None” in the Speaker Configuration (page 67) cannot be selected.

**Audyssey:** The tone for each speaker is set automatically by the Audyssey 2EQ Room Correction and Speaker Setup function. Be sure to select this setting after having performed the Room Correction and Speaker Setup. “Dynamic EQ” and “Dynamic Volume” become available (see page 71).

**Off:** Tone off, response flat (default).

### Audio Adjust

With the Audio Adjust functions and settings, you can adjust the sound and listening modes as you like.

#### Multiplex/Mono Settings

##### Multiplex

**Input Channel**      **Main:** The main channel is output (default).  
                                 **Sub:** The sub channel is output.  
                                 **Main/Sub:** Both the main and sub channels are output.

This setting determines which channel of a stereo multiplex source is output. Use it to select audio channels or languages with multiplex sources, multilingual TV broadcasts, and so on.

##### Mono

**Input Channel**      **L+R:** Both the left and right channels are output (default).  
                                 **Left:** Only the left channel is output.  
                                 **Right:** Only the right channel is output.

This setting specifies the channel to be used for playing any 2-channel digital source such as Dolby Digital, or 2-channel analog/PCM source in the Mono listening mode.

#### Dolby Settings

##### PLIIx Music (2ch Input)

These settings apply to only 2-channel stereo sources.

If you're not using any surround back speakers, these settings apply to Dolby Pro Logic II, not Dolby Pro Logic IIx.

**Panorama**              **On:** Panorama function on.  
                                 **Off:** Panorama function off (default).

With this setting, you can broaden the width of the front stereo image when using the Dolby Pro Logic IIx Music listening mode.

**Dimension**          **-3 to +3 (default: 0)**

With this setting, you can move the sound field forward or backward when using the Dolby Pro Logic IIx Music listening mode. Higher settings move the sound field backward. Lower settings move it forward.

If the stereo image feels too wide, or there's too much surround sound, move the sound field forward to improve the balance. Conversely, if the stereo image feels like it's in mono, or there's not enough surround sound, move it backward.

**Center Width**      **0 to 7 (default: 3)**

With this setting, you can adjust the width of the sound from the center speaker when using the Dolby Pro Logic IIx Music listening mode. Normally, if you're using a center speaker, the center channel sound is output by only the center speaker. (If you're not using a center speaker, the center channel sound will be distributed to the front left and right speakers to create a phantom center.) This setting controls the front left, right, and center mix, allowing you to adjust the weight of the center channel sound.

##### Dolby EX

**Dolby EX**              **Auto:** If the source signal contains a Dolby EX flag, the Dolby EX listening mode is used.  
                                 **Manual:** You can select any available listening mode (default).

This setting determines how Dolby EX encoded signals are handled. This setting is unavailable if no surround back speakers are connected. This setting is effective with Dolby Digital, Dolby Digital Plus and Dolby TrueHD only.

##### Notes:

- If the "Surr Back" Setting is set to "None" (page 67), this setting cannot be selected.
- If the "Front High" Setting is set to other than "None", this setting is fixed at "Manual" (page 67).

### DTS Setting

#### Neo:6 Music

**Center Image**    **0 to 5 (default: 2)**

The DTS Neo:6 Music listening mode creates 6-channel surround sound from 2-channel stereo sources. With this setting, you can specify by how much the front left and right channel output is attenuated in order to create the center channel.

Setting a value [0] in the middle is set to hear a sound. Sound is spread in left and right (the outside) so that the set value is made big. Please adjust by liking.

### Audyssey Settings

When the room correction and speaker setup is complete, the “Equalizer Settings” (page 69) will be set to “Audyssey” and the “Dynamic EQ” will be set to “On”.

**Dynamic EQ**        **Off:** Audyssey Dynamic EQ off (default).  
**On:** Audyssey Dynamic EQ on.

With Audyssey Dynamic EQ, you can enjoy great sound even when listening at low volume levels. Audyssey Dynamic EQ solves the problem of deteriorating sound quality as volume is decreased by taking into account human perception and room acoustics. It does so by selecting the correct frequency response and surround volume levels moment-by-moment so that the content sounds the way it was created at any volume level—not just at reference level.

#### Dynamic Volume (see page 45)

**Off:** Audyssey Dynamic Volume™ off.  
**Light:** Light Compression Mode becomes active.  
**Medium:** Medium Compression Mode becomes active.  
**Heavy:** Heavy Compression Mode becomes active. This setting affects volume the most, causing all sounds to be of equal loudness.

#### Note:

After the room correction and speaker setup is completed, even if Equalizer Setting is set to other than “Audyssey”, when Dynamic EQ is set to “On”, Equalizer Settings is set to “Audyssey”.

When Dynamic Volume is set to effective, Equalizer Setting is set to “Audyssey” and Dynamic EQ is set to “On”. When Dynamic EQ is set to “Off”, Dynamic Volume becomes “Off” automatically.

### Theater-Dimensional Setting

**Listening Angle**    **Wide:** Select if the listening angle is 40 degrees (default).  
**Narrow:** Select if the listening angle is 20 degrees.

With this setting, you can optimize the Theater-Dimensional listening mode by specifying the angle of the front left and right speakers relative to the listening position. Ideally, the front left and right speakers should be equidistant from the listening position and at an angle close to one of the two available settings.

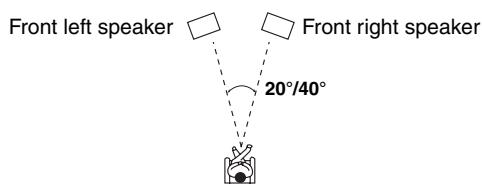

### Using the Audio Settings

You can change various audio settings by pressing the [AUDIO] button.

**Note:**

When the “Audio TV Out” setting is set to “On” (page 78), the [AUDIO] button is disabled.

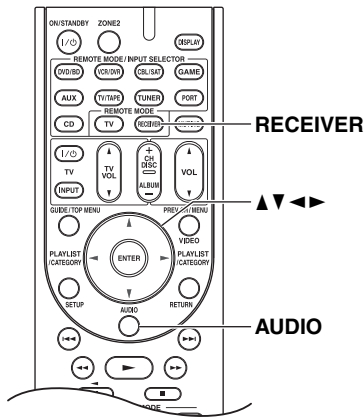

- 1** Press the [RECEIVER] button followed by the [AUDIO] button.
- 2** Use the Up and Down [▲]/[▼] buttons to select an item.
- 3** Use the Left and Right [◀]/[▶] buttons to change the setting.  
Repeat this step for the other settings.

### Tone Control Settings

You can adjust the bass and treble for the front speakers, except when the Direct listening mode is selected.

**Bass**                      **–10 dB to +10 dB in 2 dB steps (default: 0 dB)**

You can boost or cut low-frequency sounds output by the front speakers.

**Treble**                     **–10 dB to +10 dB in 2 dB steps (default: 0 dB)**

You can boost or cut high-frequency sounds output by the front speakers.

**Notes:**

- To bypass the bass and treble tone circuits, select the Direct listening mode.
- This procedure can also be performed on the AV receiver by using its [TONE], [–], and [+ ] buttons.

### Late Night Function

With the Late Night function, you can reduce the dynamic range of Dolby Digital material so that you can still hear quiet parts even when listening at low volume levels—ideal for watching movies late at night when you don’t want to disturb anyone.

- Late Night**                For **Dolby Digital and Dolby Digital Plus** sources, the options are:
- Off:** Late Night function off (default).
  - Low:** Small reduction in dynamic range.
  - High:** Large reduction in dynamic range.
- For **Dolby TrueHD** sources, the options are:
- Auto:** The Late Night function is set to “On” or “Off” automatically (default).
  - Off:** Late Night function off.
  - On:** Late Night function on.

**Notes:**

- The effect of the Late Night function depends on the material that you are playing and the intention of the original sound designer, and with some material there will be little or no effect when you select the different options.
- The Late Night function can be used only when the input source is Dolby Digital, Dolby Digital Plus, or Dolby TrueHD.
- The Late Night function is set to Off when the AV receiver is set to Standby. For Dolby TrueHD sources, it will be set to Auto.

### CinemaFILTER

With the CinemaFILTER, you can soften overly bright movie soundtracks, which are typically mixed for reproduction in a movie theater.

CinemaFILTER can be used with the following listening modes: Dolby Digital, Dolby Digital EX, Dolby Digital Plus, TrueHD, Dolby Pro Logic IIx Movie, Dolby Pro Logic II Movie, Multichannel, DTS, DTS-ES, DTS Neo:6 Cinema, DTS 96/24, Neo:6, DTS-HD High Resolution, DTS-HD Master and DTS Express.

---

<b>Cinema Fltr</b>	<b>Off:</b> CinemaFILTER off (default).
	<b>On:</b> CinemaFILTER on.

#### Note:

The CinemaFILTER may not work when used with certain input sources.

---

### Audyssey Dynamic Volume™

---

<b>Dyn Vol</b>	See “Dynamic Volume” of “Audio Adjust” on page 71.
----------------	--

---

### Music Optimizer

The Music Optimizer function enhances the sound quality of compressed music files. Use it with music files that use “lossy” compression, such as MP3. The setting is stored individually for each input selector.

---

<b>M.Optimizer</b>	<b>Off:</b> Music Optimizer off (default).
	<b>On:</b> Music Optimizer on.

#### Note:

The Music Optimizer function only works with PCM digital audio input signals with a sampling rate below 48kHz and analog audio input signals. The Music Optimizer is disabled when the Direct listening mode is selected.

---

### Speaker Layout

You can select the priority of the use of SurrBack speakers or FrontHigh speakers.

---

<b>SpLayout</b>	<b>SurrBk:</b> The sound from surround back speakers is output by priority.
	<b>FrontH:</b> The sound from front high speakers is output by priority.

#### Notes:

- If the “Speaker Type” setting is set to “Bi-Amp” (page 42), or Powered Zone 2 is being used (page 83), this setting cannot be selected.
- When the listening mode that doesn’t correspond to the switch of the speakers is used, the setting cannot be selected.
- This setting can also be selected on the remote controller by using [GUIDE/TOP MENU] button.

---

### Speaker Levels

You can adjust the volume of each speaker while listening to an input source.

These temporary adjustments are cancelled when the AV receiver is set to Standby.

---

<b>Subwfr (Subwoofer)</b>	<b>–15 dB to +12 dB (default: 0 dB)</b>
<b>Center</b>	<b>–12 dB to +12 dB (default: 0 dB)</b>

#### Notes:

- You cannot use this function while the AV receiver is muted.
- Speakers that are set to “No” or “None” in the Speaker Configuration cannot be adjusted (see page 67).
- This setting is not available when the Direct listening mode is used with an analog input signal.

---

### A/V Sync

When using progressive scanning on your DVD/BD player, you may find that the picture and sound are out of sync. With this setting, you can correct this by delaying the audio signals.

---

<b>A/V Sync</b>	<b>0 ms to 100 ms in 10 ms steps</b>
-----------------	--------------------------------------

#### Notes:

- A/V Sync is disabled when the Direct listening mode is used with an analog input source.
- This setting is stored individually for each input selector.

## Assigning Listening Modes to Input Sources

You can assign a default listening mode to each input source that will be selected automatically when you select each input source. For example, you can set the default listening mode to be used with Dolby Digital input signals. You can select other listening modes during playback, but the mode specified here will be resumed once the AV receiver has been set to Standby.

### 1 Press the [RECEIVER] button followed by the [SETUP] button.

The main menu appears onscreen.  
If the main menu doesn't appear, make sure the appropriate external input is selected on your TV.

### 2 Use the Up and Down [▲]/[▼] buttons to select "5. Listening Mode Preset", and then press [ENTER].

The "Listening Mode Preset" menu appears.

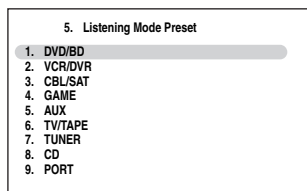

### 3 Use the Up and Down [▲]/[▼] buttons to select the input source that you want to set, and then press [ENTER].

The signal format selection menu appears.

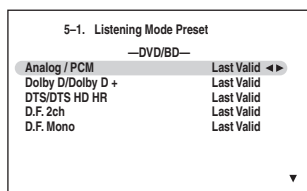

For TUNER input selector only "Analog" will be available.

### 4 Use the Up and Down [▲]/[▼] buttons to select the signal format that you want to set, and then use the Left and Right [◀]/[▶] buttons to select a listening mode.

Only listening modes that can be used with each input signal format can be selected (see pages 60–63).

The Last Valid option means that the listening mode selected last will be used.

**Analog / PCM:** With this setting, you can specify the listening mode to be used when an analog (CD, TV, LD, VHS, MD, turntable, radio, cassette, cable, satellite, etc.) or PCM digital (CD, DVD, etc.) audio signal is played.

**Dolby D/Dolby D +:** With this setting, you can specify the listening mode to be used when a Dolby Digital or Dolby Digital Plus format digital audio signal is played (DVD, etc.).

**DTS/DTS HD HR:** With this setting, you can specify the listening mode to be used when a DTS or DTS-HD High Resolution format digital audio signal is played (DVD, LD, CD, etc.).

**D.F. 2ch:** Specifies the default listening mode for 2-channel (2/0) stereo sources in a digital format, such as Dolby Digital or DTS.

**D.F. Mono:** With this setting, you can specify the listening mode to be used when a mono digital audio signal is played (DVD, etc.).

**Multich PCM:** Specifies the default listening mode for multichannel PCM sources input via a HDMI IN, such as DVD-Audio.

**Dolby TrueHD:** Specifies the default listening mode for Dolby TrueHD sources, such as Blu-ray or HD DVD (input via HDMI).

**DTS-HD Master Audio:** Specifies the default listening mode for DTS-HD Master Audio sources, such as Blu-ray or HD DVD (input via HDMI).

**DSD:** Specifies the default listening mode for DSD multichannel sources, such as SACD.

### 5 When you've finished, press the [SETUP] button.

The setup menu closes.

#### Notes:

- If you connect an input component (such as UP-A1 series Dock that seated iPod) to the UNIVERSAL PORT jack, you can assign only "Analog" listening mode to PORT selector.
- This procedure can also be performed on the AV receiver by using its [SETUP] button, arrow buttons, and [ENTER] button.

## Source Setup

This section explains items on the “Source Setup” menu. Items can be set individually for each input selector.

**1 Press the input selector buttons to select an input source, and then press the [RECEIVER] button.**

**2 Press the [SETUP] button.**  
The main menu appears onscreen.  
If the main menu doesn't appear, make sure the appropriate external input is selected on your TV.

**3 Use the Up and Down [▲]/[▼] buttons to select “4. Source Setup”, and then press [ENTER].**  
The “Source Setup” menu appears. The name of the currently selected input selector is displayed.

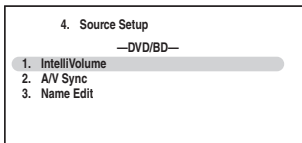

**4 Use the Up and Down [▲]/[▼] buttons to select an item, and then press [ENTER].**

**5 Use the Left and Right [◀]/[▶] buttons to change it.**  
The “Source Setup” menu items are explained below.

**6 When you've finished, press the [SETUP] button.**  
The setup menu closes.

## IntelliVolume

With IntelliVolume, you can set the input level for each input selector individually. This is useful if one of your source components is louder or quieter than the others. Use the Left and Right [◀]/[▶] buttons to set the level. If a component is noticeably louder than the others, use the Left [◀] button to reduce its input level. If it's noticeably quieter, use the Right [▶] button to increase its input level. The input level can be adjusted from -12 dB to +12 dB in 1 dB steps.

**Note:**  
IntelliVolume does not apply for Zone 2.

## A/V Sync

When using your DVD player's progressive scanning function, you may find that the picture and sound are out of sync. With the A/V Sync setting, you can correct this by applying a delay to the audio signal. The delay can be set from 0 to 100 milliseconds (msec) in 10 millisecond steps.

Use the Left and Right [◀]/[▶] buttons to set the delay. To view the TV picture while setting the delay, press [ENTER]. To return to the previous screen, press the [RETURN] button.

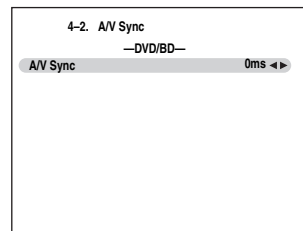

If HDMI Lip Sync is enabled (see page 78), and your TV or display supports HDMI Lip Sync, the displayed delay time will be the A/V Sync delay time. The HDMI Lip Sync delay time is displayed underneath in parentheses.

**Note:**  
A/V Sync is disabled when the Direct listening mode is used with an analog input source.

## Name Edit

You can enter a custom name for each individual input selector and radio preset for easy identification. When entered, the custom name will appear on the display. The custom name is edited using the character input screen.

1. Use the arrow [▲]/[▼]/[◀]/[▶] buttons to select a character, and then press [ENTER].  
Repeat this step to enter up to 10 characters.
2. When you've finished, to store a name, be sure to use the arrow [▲]/[▼]/[◀]/[▶] buttons to select "OK", and then press [ENTER]. Otherwise it will not be saved.

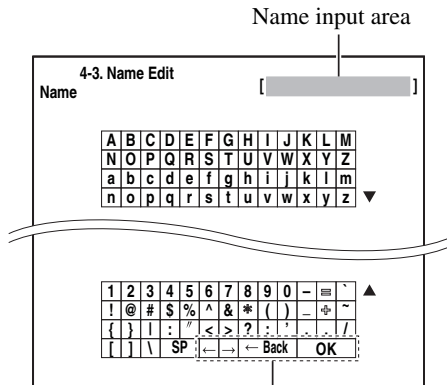

← (Left)/ → (Right):  
Selected when the cursor is moved within the Name input area.

← Back:  
“← Back” moves the cursor backward one character space. In addition, “← Back” deletes the character to the left of the cursor.

OK:  
Selects when the entry is complete.

### To correct a character:

1. Use the arrow [▲]/[▼]/[◀]/[▶] buttons to select “←” (Left) or “→” (Right) and then press [ENTER].
2. Press [ENTER] several times to select the incorrect character (The cursor moves one letter each time [ENTER] is pressed).
3. Use the arrow [▲]/[▼]/[◀]/[▶] buttons to select the correct character, and then press [ENTER].

### Notes:

- To name a radio preset, use the [TUNER] button to select AM or FM, and then select the preset (see step 1 on page 75).
- To restore a custom name to the default, erase the custom name by entering an empty white space for each letter.
- This procedure can also be performed on the AV receiver by using its [SETUP], [ENTER], and arrow buttons.



### Miscellaneous (Volume/OSD) Setup

This section explains the items on the “Miscellaneous” menu.

**1 Press the [RECEIVER] button followed by the [SETUP] button.**

The main menu appears onscreen.

If the main menu doesn't appear, make sure the appropriate external input is selected on your TV.

**2 Use the Up and Down [▲]/[▼] buttons to select “6. Miscellaneous”, and then press [ENTER].**

The “Miscellaneous” menu appears.

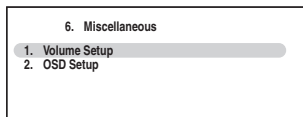

**3 Use the Up and Down [▲]/[▼] buttons to select an item, and then press [ENTER].**

The screen for that item appears.

**4 Use the Up and Down [▲]/[▼] buttons to select an item, and use the Left and Right [◀]/[▶] buttons to change it.**

The items are explained below.

**5 When you've finished, press the [SETUP] button.**

The setup menu closes.

**Note:**

This procedure can also be performed on the AV receiver by using its [SETUP] button, arrow buttons, and [ENTER] button.

### Volume Setup

**Maximum Volume**

With this setting, you can limit the maximum volume.

The Maximum Volume range is “Off”, 79 to 30.

**Power On Volume**

With this preference, you can specify the volume setting to be used each time the AV receiver is turned on.

The range is “Last”, “Min”, 1 to 79 or “Max”.

To use the same volume level that was used when the AV receiver was turned off, select “Last”.

The “Power On Volume” cannot be set higher than the “Maximum Volume” setting.

**Headphone Level**

With this preference, you can specify the headphone volume relative to the main volume. This is useful if there's a volume difference between your speakers and your headphones. The headphones level can be set from -12 dB to +12 dB.

### OSD Setup

**Immediate Display**

This preference determines whether operation details are displayed onscreen when an AV receiver function is adjusted.

**On:** Displayed (default).

**Off:** Not displayed.

Even when “On” is selected, operation details may not be output if the input source is connected to an HDMI IN.

**Display Position**

This preference determines where on the screen operation details are displayed.

**Bottom:** Bottom of the screen (default).

**Top:** Top of the screen.

**Language**

This setting determines the language used for the onscreen setup menus. You can select: English, Deutsch, French, or Spanish.

### Hardware Setup

This section explains items on the “Hardware Setup” menu.

#### 1 Press the [RECEIVER] button followed by the [SETUP] button.

The main menu appears onscreen.  
If the main menu doesn’t appear, make sure the appropriate external input is selected on your TV.

#### 2 Use the Up and Down [▲]/[▼] buttons to select “7. Hardware Setup”, and then press [ENTER].

The “Hardware Setup” menu appears.

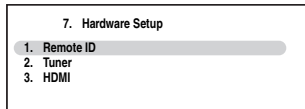

#### 3 Use the Up and Down [▲]/[▼] buttons to select an item, and then press [ENTER].

The screen for that item appears.

#### 4 Use the Up and Down [▲]/[▼] buttons to select an item, and use the Left and Right [◀]/[▶] buttons to change it.

The items are explained below.

#### 5 When you’ve finished, press the [SETUP] button.

The setup menu closes.

#### Note:

This procedure can also be performed on the AV receiver by using its [SETUP] button, arrow buttons, and [ENTER] button.

### Remote ID

#### ■ Remote ID

When several Onkyo components are used in the same room, their remote ID codes may overlap. To differentiate the AV receiver from the other components, you can change its remote ID from 1, the default, to 2 or 3.

#### Note:

If you do change the AV receiver’s remote ID, be sure to change the remote controller to the same ID (see below), otherwise, you won’t be able to control it with the remote controller.

#### Changing the Remote Controller’s ID

#### 1 While holding down the [RECEIVER] button, press and hold down the [SETUP] button until the Remote indicator lights up (about 3 seconds).

#### 2 Use the number buttons to enter ID 1, 2, or 3.

The Remote indicator flashes twice.

### Tuner

#### ■ FM/AM Frequency Step

See “FM/AM Frequency Step Setup” on page 43.

### HDMI

#### ■ Audio TV Out

This preference determines whether audio received at the HDMI IN is output by the HDMI OUT. You may want to turn this preference on if your TV is connected to the HDMI OUT and you want to listen to the audio from a component that’s connected to an HDMI IN, through your TV’s speakers. Normally, this should be set to “Off”.

**Off:** HDMI audio is not output (default).

**On:** HDMI audio is output.

#### Notes:

- If “On” is selected and the signal can be output by the TV, the AV receiver will output no sound through its speakers.
- If “On” is selected, “TV Sp On” appears on the Display by pressing the [DISPLAY] button.
- When “TV Control” is set to “On”, this setting is fixed to “Auto”.
- With some TVs and input signals, no sound may be output even when this setting is set to “On”.
- When the “Audio TV Out” setting is set to “On”, or “TV Control” is set to “On” and you’re listening through your TV’s speakers (see page 23), if you turn up the AV receiver’s volume control, the sound will be output by the AV receiver’s front left and right speakers. To stop the AV receiver’s speakers producing sound, change the settings, change your TV’s settings, or turn down the AV receiver’s volume.

#### ■ Lip Sync

The AV receiver can be set to automatically correct any delay between the video and the audio, based on the data from the connected monitor.

**Disable:** HDMI lip sync disabled (default).

**Enable:** HDMI lip sync enabled.

#### Notes:

- This function works only if your HDMI-compatible TV supports HDMI Lip Sync.
- You can check the amount of delay being applied by the HDMI Lip Sync function on the A/V Sync screen (see page 75).

### ■ x.v.Color

If your HDMI source and HDMI-compatible TV both support the “x.v.Color”, you can enable “x.v.Color” on the AV receiver with this setting.

**Disable:** “x.v.Color” disabled (default).

**Enable:** “x.v.Color” enabled.

#### Notes:

- If the color is unnatural when “x.v.Color” is set to “Enable”, change the setting to “Disable”.
- Refer to the connected component’s instruction manual for details.

### ■ HDMI Control (RIHD)

This function allows **RIHD**-compatible components connected via HDMI to be controlled with the AV receiver.

**Off:** **RIHD** disabled (default).

**On:** **RIHD** enabled.

#### Notes:

- **RIHD**, which stands for Remote Interactive over HDMI, is the name of the system control function found on Onkyo components. The AV receiver can be used with CEC (Consumer Electronics Control), which allows system control over HDMI and is part of the HDMI standard. CEC provides interoperability between various components, however, operation with components other than **RIHD**-compatible components cannot be guaranteed.

When set to “On” and close the menu, the name of connected **RIHD**-compatible components and “RIHD On” are displayed on the AV receiver.

“Search...” → “(name)” → “**RIHD On**”

When the AV receiver cannot receive the name of the component, it is displayed as “Player\*\*\*” or “Recorder\*\*\*”, etc (“\*\*\*” means the number of two or more component).

When set to “Off” and close the menu, “RIHD Off” are displayed on the AV receiver.

“Disconnect” → “**RIHD Off**”

- When an **RIHD**-compatible component is connected to the AV receiver via the HDMI cable, the name of the connected component is displayed on the AV receiver display. For example, while you are watching TV broadcasting, if you operate a DVD/BD player (being powered on) by the remote control of the AV receiver, the name of the DVD/BD player is displayed on the AV receiver.
- Set to “Off” when a connected piece of equipment is not compatible or it is unclear whether the equipment is compatible or not.
- If movement is unnatural when set to “On”, change the setting to “Off”.
- Refer to the connected component’s instruction manual for details.

### Power Control

To link the power functions of **RIHD**-compatible components connected via HDMI, select “On”.

This setting is set to “On” automatically when the above “HDMI Control (RIHD)” is set to “On” first time.

**Off:** Power Control disabled.

**On:** Power Control enabled.

#### Notes:

- The “Power Control” setting can be set only when the above “HDMI Control (RIHD)” setting is set to “On”.
- HDMI power control only works with **RIHD**-compatible components that support it and may not work properly with some components due to their settings or compatibility.
- When set to “On”, power consumption will increase.
- When set to “On”, regardless of whether the AV receiver is On or on Standby, both audio and video received by an HDMI input will be output by the HDMI OUT for playback on the TV or other component that’s connected to the HDMI OUT.
- Refer to the connected component’s instruction manual for details.

### TV Control

Set to “On” when you want to control the AV receiver from an **RIHD**-compatible TV that is connected to HDMI.

**Off:** TV Control disabled.

**On:** TV Control enabled.

#### Notes:

- Do not assign the component connected with the HDMI input to the TV/TAPE selector when you set “TV Control” setting to “On”. Otherwise, appropriate CEC (Consumer Electronics Control) operation is not guaranteed.
- Set to “Off” when the TV is not compatible or when it is unclear whether the TV is compatible or not.
- The “TV Control” setting can be set only when the above “HDMI Control (RIHD)” and “Power Control” settings are both set to “On”.
- Refer to the connected component’s instruction manual for details.

#### Note:

After changing the settings of the “HDMI Control (RIHD)”, “Power Control”, or “TV Control”, turn off the power to all connected pieces of equipment and then turn them on again. Refer to the User’s Manuals for all connected pieces of equipment.

### Lock Setup

With this preference, you can protect your settings by locking the setup menus.

- 1 Press the [RECEIVER] button followed by the [SETUP] button.  
The main menu appears onscreen.  
If the main menu doesn't appear, make sure the appropriate external input is selected on your TV.

- 2 Use the Up and Down [▲]/[▼] buttons to select "9. Lock Setup", and then press [ENTER].  
The "Lock Setup" menu appears.

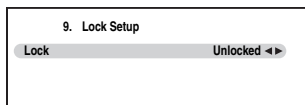

- 3 Use the Left and Right [◀]/[▶] buttons to select:  
When the setup menus are locked, you cannot change any setting.  
**Locked:**  
Setup menus locked.  
**Unlocked:**  
Setup menus not locked.

- 4 Press the [SETUP] button.  
The setup menu closes.

### Using the Video Settings

You can change various settings of the upconverted video signal.

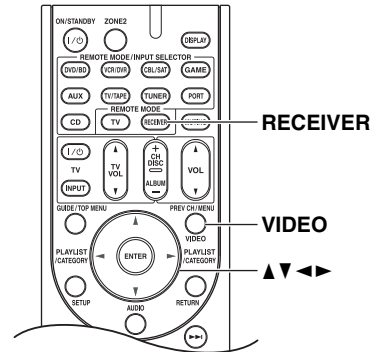

- 1 Press the [RECEIVER] button followed by the [VIDEO] button.
- 2 Use the Up and Down [▲]/[▼] buttons to select an item.
- 3 Use the Left and Right [◀]/[▶] buttons to change the setting.  
Repeat this step for the other settings.

#### ■ Resolution (Reso)

You can specify the output resolution for the HDMI outputs and have the AV receiver upconvert the picture resolution as necessary to match the resolution supported by your TV.

See the "Video Resolution Chart" on page 102 to see how the AV receiver handles video input at different resolutions.

- Through:** Select this to pass video through the AV receiver at the same resolution and with no conversion (default).
- Auto:** Select this to have the AV receiver automatically convert video at resolutions not supported by your TV.
- 480p:** Select this for 480p output and video conversion as necessary.
- 720p:** Select this for 720p output and video conversion as necessary.
- 1080i:** Select this for 1080i output and video conversion as necessary.

#### Note:

If the resolution is not supported by your TV, it is displayed such as "(1080i)" on the AV receiver.

### ■ Zoom Mode (Zoom)

This setting determines the aspect ratio that will be used for 480i and 480p input signals when they are output by the HDMI OUT. This setting only applies when the HDMI Output Resolution setting is set to 1080i or 720p.

**Normal:**

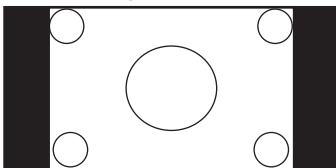
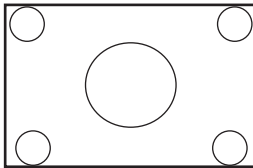

**Full: (default)**

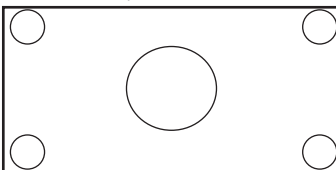
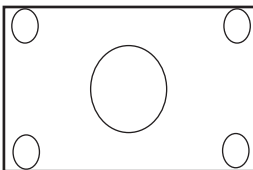

### ■ Brightness

With this setting you can adjust the picture brightness. Can be adjusted from -20 to +20 in steps of 1 (default is 0).

“-20” is the darkest.

“+20” is the brightest.

### ■ Contrast

With this setting you can adjust Contrast.

Can be adjusted from -20 to +20 in steps of 1 (default is 0).

“-20” is the least.

“+20” is the greatest.

### ■ Hue

With this setting you can adjust the red/green balance.

Can be adjusted from -20 to +20 in steps of 1 (default is 0).

“-20” is the strongest green.

“+20” is the strongest red.

### ■ Saturation

With this setting you can adjust saturation.

Can be adjusted from -20 to +20 in steps of 1 (default is 0).

“-20” is the weakest color.

“+20” is the strongest color.

### ■ Sharpness

With this setting you can adjust sharpness.

Can be adjusted from 0 to +5 in steps of 1 (default is 0).

“0” is the default.

“+5” is the sharpest.

## Digital Input Signal Formats

The digital input signal formats are available only for the input sources that you have assigned a digital input jack (see page 41).

Normally, the AV receiver detects the signal format automatically. However, if you experience either of the following issues when playing PCM or DTS material, you can manually set the signal format to PCM or DTS:

- If the beginnings of tracks from a PCM source are cut off, try setting the format to PCM.
- If noise is produced when fast forwarding or reversing a DTS CD, try setting the format to DTS.
- The setting is stored individually for each input selector.

**1** Press the [RECEIVER] button, and then press and hold [AUDIO] button for about 8 seconds.

**2** While “Auto” is displayed (about 3 seconds), press the Left and Right [◀]/[▶] buttons to select: PCM, DTS or Auto.

#### PCM:

Only 2-channel PCM format input signals will be heard. If the input signal is not PCM, the PCM indicator will flash and noise may also be produced.

#### DTS:

Only DTS (but not DTS-HD) format input signals will be heard. If the input signal is not DTS, the DTS indicator will flash and there will be no sound.

#### Auto (default):

The format is detected automatically. If no digital input signal is present, the corresponding analog input is used instead.

# Zone 2

In addition to your main listening room, you can also enjoy playback in the other room, or as we call Zone 2. And, you can select a different source for each room.

## Connecting Zone 2

There are two ways you can connect Zone 2 speakers:

1. Connect them directly to the AV receiver.
2. Connect them to an amp in Zone 2.

### Connecting Your Zone 2 Speakers Directly to the AV receiver

This setup allows 5.1-channel playback in your main room and 2-channel stereo playback in Zone 2, with a different source in each room. This is called Powered Zone 2, as the Zone 2 speakers are powered by the AV receiver. Note that when Powered Zone 2 is turned off, you can enjoy 7.1-channel playback in your main room.

To use this setup, you must set the "Powered Zone 2" setting to "Act" (see page 83).

#### Hookup

- Connect your Zone 2 speakers to the AV receiver's ZONE 2 L/R speaker terminals.

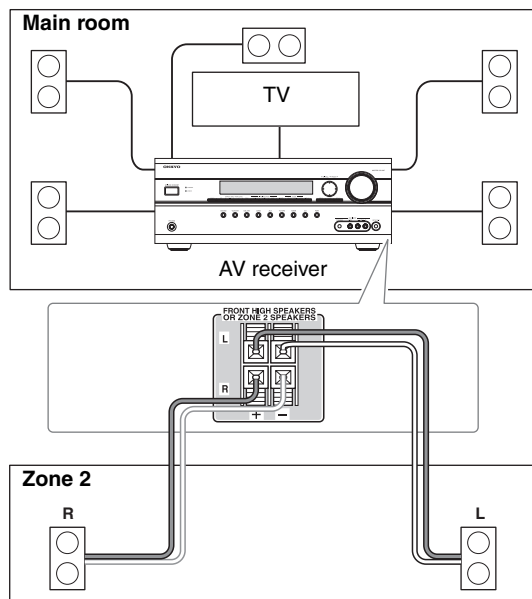

#### Notes:

- With this setup, the Zone 2 volume is controlled by the AV receiver.
- Powered Zone 2 cannot be used if "Speaker Type" is set to "Bi-Amp" (see page 42).

### Connecting Your Zone 2 Speakers to an Amp in Zone 2

This setup allows 7.1-channel playback in your main listening room and 2-channel stereo playback in Zone 2, with a different source in each room.

#### Hookup

- Use an RCA audio cable to connect the AV receiver's ZONE 2 LINE OUT L/R jacks to an analog audio input on your Zone 2 amp.
- Connect your Zone 2 speakers to the speaker terminals on your Zone 2 amp.

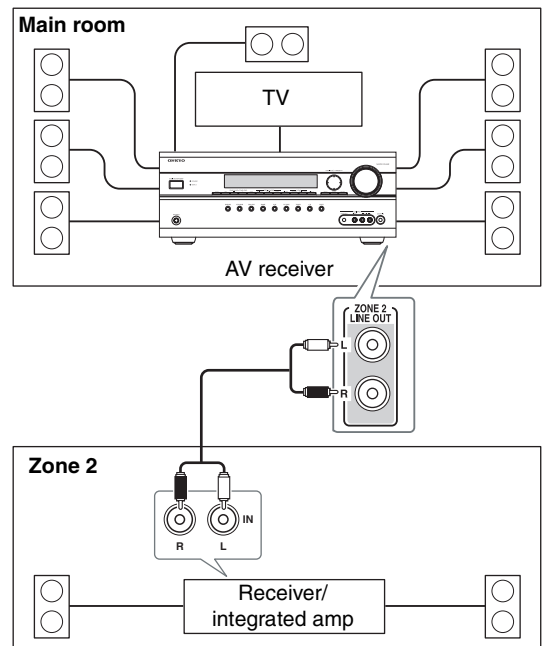

#### Note:

The Zone 2 volume must be set on the Zone 2 amp.

### Setting the Powered Zone 2

If you've connected your Zone 2 speakers to the AV receiver, as explained in "Connecting Your Zone 2 Speakers Directly to the AV receiver" on page 82, you must set the "Powered Zone 2" setting to "Act" (Activated).

**1** Press the [RECEIVER] button followed by the [SETUP] button. The main menu appears onscreen. If the main menu doesn't appear, make sure the appropriate external input is selected on your TV.



**2** Use the Up and Down [▲]/[▼] buttons to select "2. Speaker Setup", and then press [ENTER]. The "Speaker Setup" menu appears.

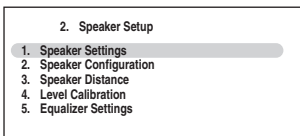

**3** Use the Up and Down [▲]/[▼] buttons to select "1. Speaker Settings", and then press [ENTER]. The "Speaker Settings" menu appears.

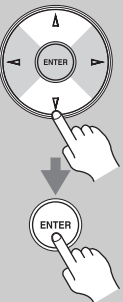

**4** Use the Up and Down [▲]/[▼] buttons to select "Powered Zone 2", and use the Left and Right [◀]/[▶] buttons to select:

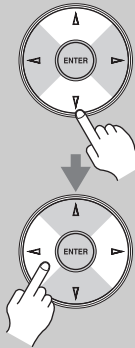

**Not Act:**

ZONE 2 L/R speaker terminals not activated (Powered Zone 2 disabled).

**Act:**

ZONE 2 L/R speaker terminals activated (Powered Zone 2 enabled).

**5** Press the [SETUP] button. The setup menu closes.



**Notes:**

- When "Act" is selected and Zone 2 turned on, the Zone 2 speakers connected to the ZONE 2 L/R speaker terminals output sound, but the surround back or front high speakers connected to the SURR BACK/FRONT HIGH L/R speaker terminals do not. When "Act" is selected and Zone 2 turned off, the surround back or front high speakers output sound as normal.
- When the "Powered Zone 2" setting is set to "Act" and the input selector of Zone 2 is selected, power consumption on standby mode slightly increases.
- Powered Zone 2 cannot be used if "Speaker Type" is set to "Bi-Amp" (see page 42).
- This procedure can also be performed on the AV receiver by using its [SETUP] button, arrow buttons, and [ENTER] button.

## Using Zone 2

This section explains how to turn Zone 2 on and off, how to select an input source for Zone 2, and how to adjust the volume for Zone 2.

### Controlling Zone 2 from the AV receiver

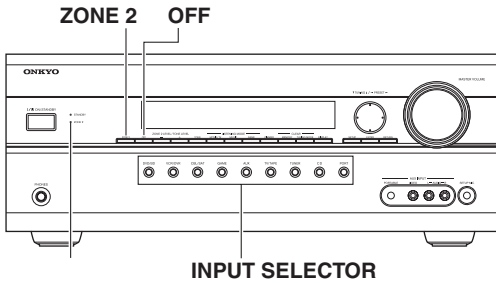

**1** To turn on Zone 2 and select an input source, press the [ZONE 2] button followed by an input selector button within 8 seconds.



Zone 2 turns on, the ZONE 2 indicator lights up.

To select AM or FM press the [TUNER] input selector button repeatedly.

To select the same source as that of the main room, press the [ZONE 2] button repeatedly until “Z2 Selector: Source” appears on the display.

**Note:**  
You cannot select different AM or FM radio stations for your main room and Zone 2. The same AM/FM radio station will be heard in each room.

**2** To turn off Zone 2, press the [OFF] button.



## Controlling Zone 2 with the Remote Controller

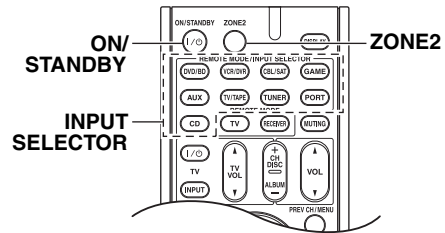

**Note:**  
To control Zone 2, you must press the remote controller’s [ZONE 2] button first.

**1** Press the [ZONE 2] button, then point the remote controller at the AV receiver and press the [ON/STANDBY] button.



Zone 2 turns on, the ZONE 2 indicator lights up.

**2** To select an input source for Zone 2, press the [ZONE 2] button, followed by an INPUT SELECTOR button.



To select AM or FM press the [TUNER] INPUT SELECTOR button repeatedly.

**Note:**  
You cannot select different AM or FM radio stations for your main room and Zone 2. The same AM/FM radio station will be heard in each room.

**3** To turn off Zone 2, press the [ZONE 2] button, followed by the [ON/STANDBY] button.





### Adjusting the Volume for Zone 2

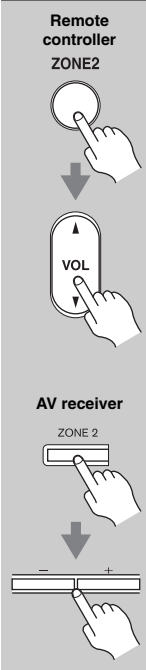

The diagram illustrates two methods for adjusting the volume for Zone 2. The top part shows a remote controller with a hand pointing to the 'ZONE 2' button, followed by a downward arrow and a hand pointing to the 'VOL' button. The bottom part shows an AV receiver with a hand pointing to the 'ZONE 2' button, followed by a downward arrow and a hand pointing to the volume slider.

**Remote controller**  
ZONE 2

**On the remote controller, press the [ZONE 2] button, and then use the VOL [▲]/[▼] button.**

**AV receiver**  
ZONE 2

**On the AV receiver, press the [ZONE 2] button, and then use the [-]/[+] buttons.**

If your Zone 2 speakers are connected to a receiver or integrated amp in Zone 2, use its volume control to adjust the volume.

#### Notes:

- Only analog input sources are output by the ZONE 2 LINE OUT and ZONE 2 L/R speaker terminals. Digital input sources are not output. If no sound is heard when an input source is selected, check if it's connected to an analog input.
- While Powered Zone 2 is being used, listening modes that require surround back or front high speakers (6.1/7.1), such as Dolby Digital EX, DTS-ES and Dolby Pro Logic IIz Height are unavailable.
- While Zone 2 is on, **RI** functions will not work.
- You cannot select different AM or FM radio stations for your main room and Zone 2. The same AM/FM radio station will be heard in each room. For example, if you have an FM station for the main room, that station will also be used in Zone 2.
- Zones can also be unmuted by adjusting the volume.
- When the "Powered Zone 2" setting is set to "Act" and the input selector of Zone 2 is selected, power consumption on standby mode slightly increases.

### Muting Zones

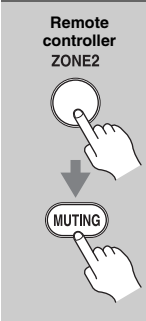

The diagram shows the steps to mute and unmute a zone. It starts with a hand pointing to the 'ZONE 2' button on a remote controller, followed by a downward arrow and a hand pointing to the 'MUTING' button. The text explains that to unmute, the 'ZONE 2' button is pressed again followed by the 'MUTING' button.

**Remote controller**  
ZONE 2

**On the remote controller, press the [ZONE 2] button, and then press the [MUTING] button.**

**To unmute a zone, on the remote controller, press the [ZONE 2] button, and then press the [MUTING] button again.**



**6**

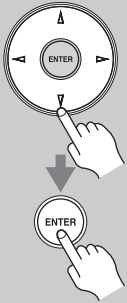

Use the arrow [▲]/[▼]/[◀]/[▶] buttons to select a character, and then press [ENTER].

Repeat this step from the 1st character to the 3rd character of the brand name. When you have entered the 3rd character, select “Search” and press [ENTER].

After searching, a list of the brand name appears.

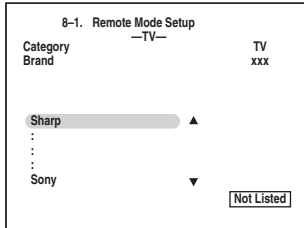

**If the brand name is not found:**

Use the Right [▶] button to select “Not Listed”, and then press [ENTER].

The brand name input panel appears.

**7**

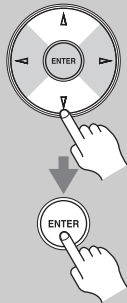

Use the Up and Down [▲]/[▼] buttons to select brand, and then press [ENTER].

After searching, a remote control code and the input procedure appear. Try it.

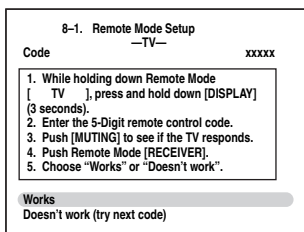

**8**

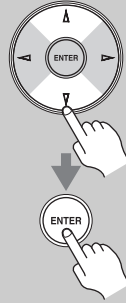

If you can control component, use the Up and Down [▲]/[▼] buttons to select “Works”, and then press [ENTER].

The “Remote Mode Setup” menu appears.

If you cannot control component, use the Up and Down [▲]/[▼] buttons to select “Doesn't work (try next code)” and press [ENTER].

The next code is appear.

**9**



When you've finished, press the [SETUP] button.

The setup menu closes.

**Note:**

This procedure can also be performed on the AV receiver by using its [SETUP] button, arrow buttons, and [ENTER] button.

## Entering Remote Control Codes

You'll need to enter a code for each component that you want to control.

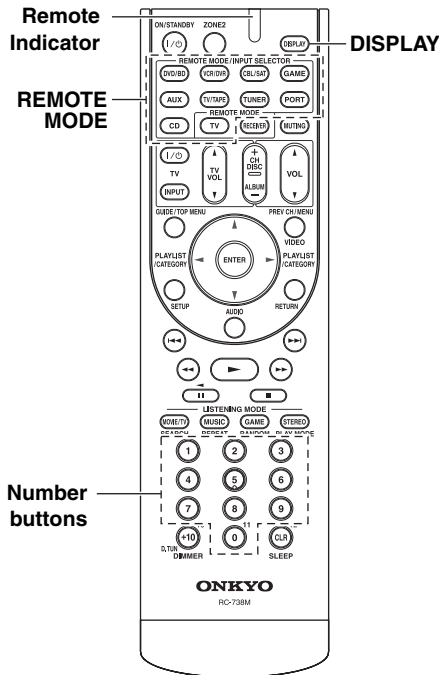

**1** Look up the appropriate remote control code in the separate Remote Control Codes list.

The codes are organized by category (e.g., DVD player, TV, etc.).

**2** While holding down the REMOTE MODE button to which you want to enter a code, press and hold down the [DISPLAY] button (about 3 seconds).



### Notes:

- Remote control codes cannot be entered for the [RECEIVER] and [ZONE 2] buttons.
- Only TV remote control codes can be entered for the [TV] button.
- Apart from the [RECEIVER], [TV], and [ZONE 2] buttons, remote control codes from any category can be entered for the REMOTE MODE buttons. However, these buttons also work as input selector buttons (page 50), so choose a REMOTE MODE button that corresponds with the input to which you connect your component. For example, if you connect your CD player to the CD input, choose the [CD] button when entering its remote control code.

**3** Within 30 seconds, use the number buttons to enter the 5-digit remote control code.



The Remote indicator flashes twice.

If the remote control code is not entered successfully, the Remote indicator will flash once slowly.

### Note:

The remote control codes provided are correct at the time of printing, but are subject to change.

## Remote Control Codes for Onkyo Components Connected via RI

Onkyo components that are connected via **RI** are controlled by pointing the remote controller at the AV receiver, not the component. This allows you to control components that are out of view, in a rack, for example.

- 1** Make sure the Onkyo component is connected with an **RI** cable and an analog audio cable (**RCA**).  
See page 36 for details.
- 2** Enter the appropriate remote control code for the **REMOTE MODE** button.
  - [DVD/BD] button  
**31612**: Onkyo DVD player with **RI**
  - [CD] button  
**71327**: Onkyo CD player with **RI**
  - [TV/TAPE] button  
**42157**: Onkyo cassette recorder with **RI** (default)
  - [PORT] button  
**82351**: Onkyo Dock (default)
  - [TUNER] button  
**51805**: To control the AV receiver's tuner (default)

See the previous page for how to enter remote control codes.
- 3** Press the **REMOTE MODE** button, point the remote controller at the AV receiver, and operate the component.

If you want to control an Onkyo component by pointing the remote controller directly at it, or you want to control an Onkyo component that's not connected via **RI**, use the following remote control codes:

- [DVD/BD] button  
**30627**: Onkyo DVD player without **RI** (default)
- [CD] button  
**71817**: Onkyo CD player without **RI** (default)
- [TV] button  
**11807**: Onkyo TV (default)

If you want to control an Onkyo component by pointing the remote controller directly at it, use the following remote control codes:

- 32900**: Onkyo BD player
- 32901**: Onkyo HD-DVD player
- 70868**: Onkyo MD recorder
- 71323**: Onkyo CD recorder
- 82990**: Onkyo Dock

**Note:**

If you connect an **RI**-capable Onkyo RI Dock to the TV/TAPE, VCR/DVR or GAME jacks, for **RI** to work properly, you must set the Input Display accordingly (see page 44).

## Resetting REMOTE MODE Buttons

You can reset a REMOTE MODE button to its default remote control code.

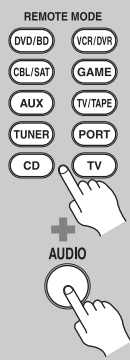
- 1**

**While holding down the REMOTE MODE button that you want to reset, press and hold down the [AUDIO] button until the Remote indicator lights up (about 3 seconds).**

(3 seconds)
- 2**



**Within 30 seconds, press the REMOTE MODE button again.**

The Remote indicator flashes twice, indicating that the button has been reset.

Each of the REMOTE MODE buttons is preprogrammed with a remote control code. When a button is reset, its preprogrammed code is restored.

## Resetting the Remote Controller

You can reset the remote controller to its default settings.

- 1**

**While holding down the [RECEIVER] button, press and hold down the [AUDIO] button until the Remote indicator lights up (about 3 seconds).**

(3 seconds)
- 2**

**Within 30 seconds, press the [RECEIVER] button again.**

The Remote indicator flashes twice, indicating that the remote controller has been reset.

## Controlling a TV

By pressing the [TV] button that's been programmed with the remote control code for TV, you can control your TV with the following buttons.

For details on entering a remote control code for a different component, see page 88.

The [TV] button is preprogrammed with the remote control code for controlling a TV that supports the **RIHD**\*1. The TV must be able to receive remote control commands via **RIHD** and be connected to the AV receiver via HDMI. If controlling your TV via **RIHD** doesn't work very well, program your TV's remote control code into the [TV] button and use the TV remote mode to control your TV.

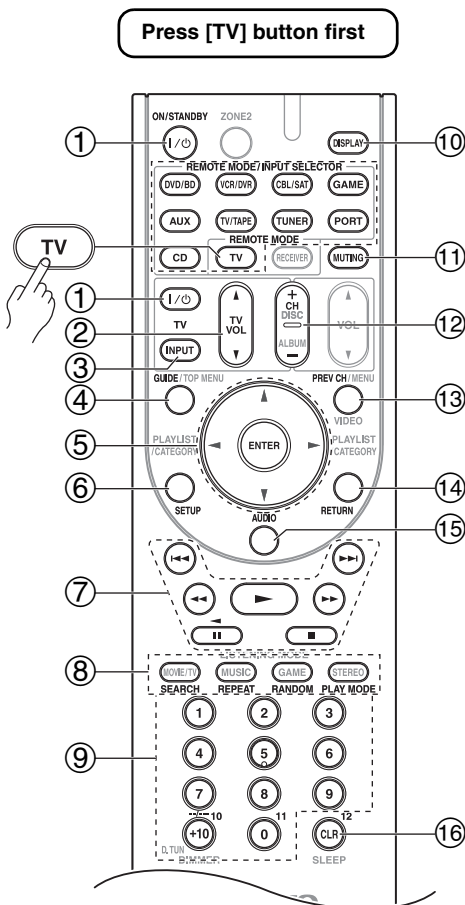

\*1 The **RIHD** supported by the AV receiver is the CEC system control function of the HDMI standard.

- ① **ON/STANDBY, TV [I/O] buttons**  
Set the TV to On or Standby.
- ② **TV VOL [▲]/[▼] button**  
Adjust the TV's volume.
- ③ **TV [INPUT] button**  
Selects the TV's external inputs.
- ④ **GUIDE button**  
Displays the program guide.
- ⑤ **Arrow [▲]/[▼]/[◀]/[▶] and ENTER buttons**  
Used to navigate menus and select items.
- ⑥ **SETUP button**  
Displays a menu.
- ⑦ **[▶], [II], [■], [◀◀], [▶▶], [◀◀◀], [▶▶▶] buttons\***  
Play, Pause, Stop, Rewind, Fast forward, Previous, and Next.  
These buttons work for combination devices.
- ⑧ **SEARCH, REPEAT, RANDOM, and PLAY MODE buttons\***  
Function as colored buttons.
- ⑨ **Number buttons**  
Enter numbers. [0] button enters 11 on some components. [+10] button\* works as "--/---" button or +10.
- ⑩ **DISPLAY button**  
Displays information.
- ⑪ **MUTING button**  
Mutes the TV.
- ⑫ **CH +/- button**  
Select channels on the TV.
- ⑬ **PREV CH button**  
Selects the previous or last channel.
- ⑭ **RETURN button**  
Exits the TV's setup menu.
- ⑮ **AUDIO button\***  
Selects foreign language soundtracks and audio formats (e.g., Dolby Digital or DTS).
- ⑯ **CLR button**  
Cancels functions and clears entered numbers, or enters 12.

### Notes:

- With some components, certain buttons may not work as expected, and some may not work at all.
- Buttons marked with an asterisk (\*) are not supported by the **RIHD** function.

## Controlling a DVD/BD Player, or DVD/BD Recorder

By pressing the REMOTE MODE button that's been programmed with the remote control code for your DVD player (HD DVD, Blu-ray, or TV/DVD combination), you can control your player with the following buttons. The [DVD/BD] button is preprogrammed with the remote control code for controlling an Onkyo DVD player.

For details on entering a remote control code for a different component, see page 88.

The [DVD/BD] button is preprogrammed with the remote control code for controlling a component that supports the **RIHD**\*1. The component must be able to receive remote control commands via **RIHD** and be connected to the AV receiver via HDMI. If controlling your component via **RIHD** doesn't work very well, program your component's remote control code into the [DVD/BD] button and use the DVD/BD remote mode to control your component.

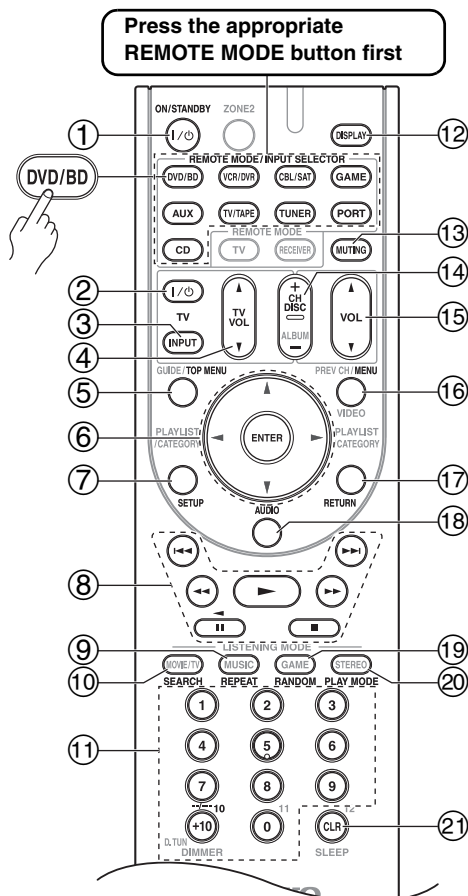

\*1 The **RIHD** supported by the AV receiver is the CEC system control function of the HDMI standard.

- ① **ON/STANDBY button**  
Sets the DVD/BD player to On or Standby.
- ② **TV [I/O] button**  
Set the TV to On or Standby.
- ③ **TV [INPUT] button**  
Selects the TV's external inputs.
- ④ **TV VOL [▲]/[▼] button**  
Adjust the TV's volume.
- ⑤ **TOP MENU button**  
Displays a DVD's top menu or a DVD's title.
- ⑥ **Arrow [▲]/[▼]/[◀]/[▶] and ENTER buttons**  
Used to navigate menus and select items.
- ⑦ **SETUP button**  
Used to access the DVD/BD player's settings.
- ⑧ **[▶], [II], [■], [◀◀], [▶▶], [◀◀], [▶▶] buttons**  
Play, Pause, Stop, Rewind, Fast forward, Previous, and Next.
- ⑨ **REPEAT button**  
Used with the repeat playback functions.
- ⑩ **SEARCH button\***  
Used to search title, chapter, and track numbers, and to search times for locating specific points.
- ⑪ **Number buttons**  
Used to enter title, chapter, and track numbers, and to enter times for locating specific points. The [+10] button\* works as a +10 button or "--/--" button.
- ⑫ **DISPLAY button**  
Displays information about the current disc, title, chapter, or track, including elapsed time, remaining time, total time, and so on.
- ⑬ **MUTING button (52)**  
Mutes or unmutes the AV receiver.
- ⑭ **DISC +/-, CH +/- button**  
Selects discs on a DVD changer. Selects TV channels on a component with a built-in tuner.
- ⑮ **VOL [▲]/[▼] button (50)**  
Adjusts the volume of the AV receiver.
- ⑯ **MENU button**  
Displays a DVD's menu.
- ⑰ **RETURN button**  
Exits the DVD/BD player's setup menu or returns to the previous menu.
- ⑱ **AUDIO button\***  
Selects foreign language soundtracks and audio formats (e.g., Dolby Digital or DTS).
- ⑲ **RANDOM button\***  
Used with the random playback function.



## Controlling Other Components—Continued

- 20 **PLAY MODE button\***  
Selects play modes on components with selectable play modes.
- 21 **CLR button**  
Cancels functions and clears entered numbers.

### Notes:

- With some components, certain buttons may not work as expected, and some may not work at all.

- If you enter the remote control code for a HD-DVD or Blu-ray player that has A, B, C, and D or colored buttons, the [SEARCH], [REPEAT], [RANDOM], and [PLAY MODE] buttons will work as colored or A, B, C, D buttons. In this case, these buttons cannot be used to set repeat playback, random playback, or select play modes.
- Buttons marked with an asterisk (\*) are not supported by the **RIHD** function.

## Controlling a VCR or PVR

By pressing the REMOTE MODE button that's been programmed with the remote control code for your VCR (TV/VCR, PVR, DBS/PVR combination or cable/PVR combination), you can control your video recorder with the following buttons.

For details on entering a remote control code for a different component, see page 88.

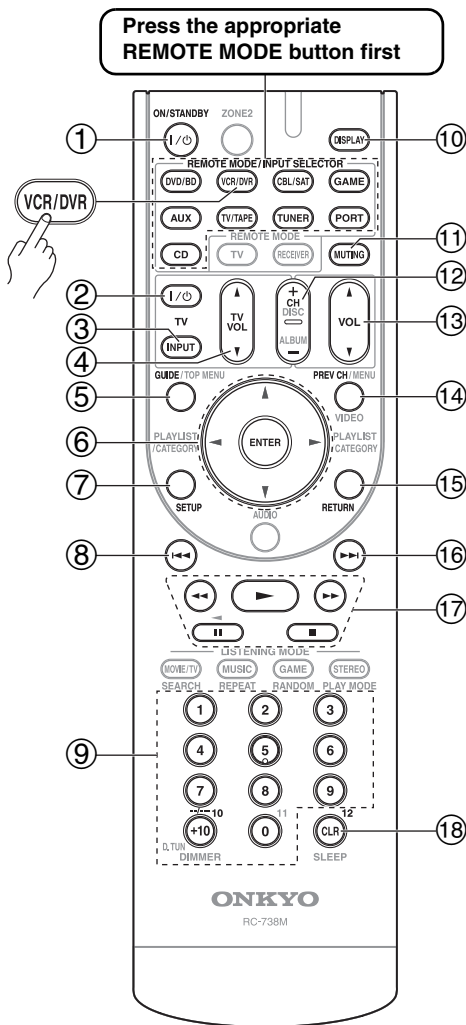

- 1 **ON/STANDBY button**  
Set the video recorder to On or Standby.
- 2 **TV [I/O] button**  
Set the TV to On or Standby.
- 3 **TV [INPUT] button**  
Selects the TV's external inputs.
- 4 **TV VOL [▲]/[▼] button**  
Adjust the TV's volume.
- 5 **GUIDE button**  
Displays the program guide or navigation list.
- 6 **Arrow [▲]/[▼]/[◀]/[▶] and ENTER buttons**  
Used to navigate menus and select items.
- 7 **SETUP button**  
Displays the video recorders setup menu.
- 8 **Previous [◀◀] button**  
Previous or instant replay function.
- 9 **Number buttons**  
Enter numbers. The [0] button enters 11 on some components. The [+10] button works as a +10 button or "--/--" button.
- 10 **DISPLAY button**  
Displays information.
- 11 **MUTING button (52)**  
Mutes or unmutes the AV receiver.
- 12 **CH +/- button**  
Selects TV channels on the video recorder.
- 13 **VOL [▲]/[▼] button (50)**  
Adjusts the volume of the AV receiver.
- 14 **PREV CH button**  
Selects the previous channel.
- 15 **RETURN button**  
Exits the menu or returns to the previous menu.
- 16 **Next [▶▶] button**  
Next or advance function.
- 17 **Playback button**  
From left to right: Rewind, Pause, Play, Stop, and Fast Forward.
- 18 **CLR button**  
Cancels functions or enters the number 12.

### Note:

With some components, certain buttons may not work as expected, and some may not work at all.



## Controlling a Satellite Receiver or Cable Receiver

By pressing the REMOTE MODE button that's been programmed with the remote control code for your satellite receiver, cable receiver, or DVD recorder (DBS/PVR combination or cable/PVR combination), you can control your player with the following buttons. For details on entering a remote control code for a different component, see page 88.

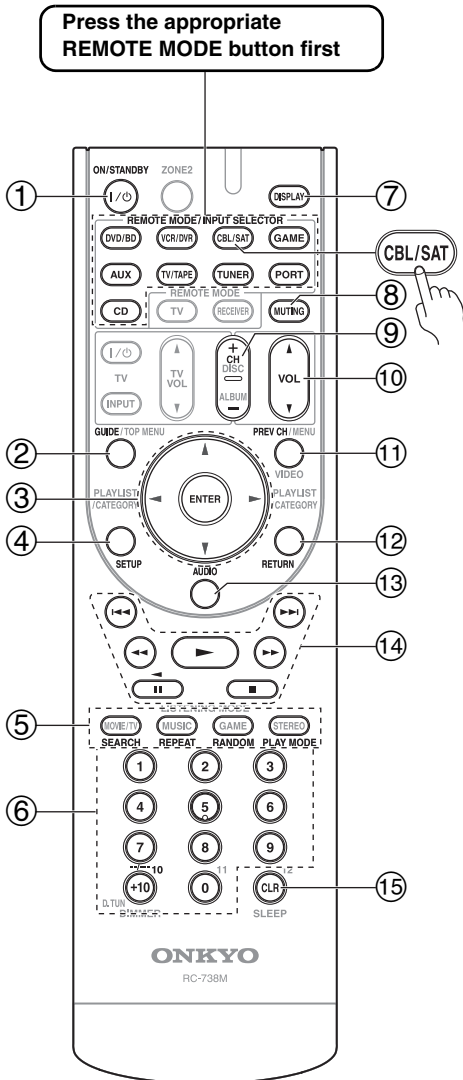

- ① **ON/STANDBY button**  
Set the component to On or Standby.
- ② **GUIDE button**  
Displays the onscreen program guide.
- ③ **Arrow [▲]/[▼]/[◀]/[▶] and ENTER buttons**  
Used to navigate menus and select items.
- ④ **SETUP button**  
Displays the setup menu.
- ⑤ **SEARCH, REPEAT, RANDOM, and PLAY MODE buttons**  
Function as colored buttons.
- ⑥ **Number buttons**  
Enter numbers. The [+10] button works as a +10 button or "--/--" button.
- ⑦ **DISPLAY button**  
Displays information.
- ⑧ **MUTING button (52)**  
Mutes or unmutes the AV receiver.
- ⑨ **CH +/- button**  
Selects satellite/cable channels.
- ⑩ **VOL [▲]/[▼] button (50)**  
Adjusts the volume of the AV receiver.
- ⑪ **PREV CH button**  
Selects the previous channel.
- ⑫ **RETURN button**  
Exits the menu.
- ⑬ **AUDIO button**  
Selects foreign language soundtracks and audio formats (e.g., Dolby Digital or DTS).
- ⑭ **[▶], [■], [■], [◀◀], [▶▶], [◀◀], [▶▶] buttons**  
Play, Pause, Stop, Rewind, Fast forward, Previous, and Next.
- ⑮ **CLR button**  
Cancels functions and clears entered numbers.

**Note:**

With some components, certain buttons may not work as expected, and some may not work at all.

## Controlling a CD Player

By pressing the REMOTE MODE button that's been programmed with the remote control code for your CD player, you can control your player with the following buttons.

The [CD] button is preprogrammed with the remote control code for controlling an Onkyo CD player.

For details on entering a remote control code for a different component, see page 88.

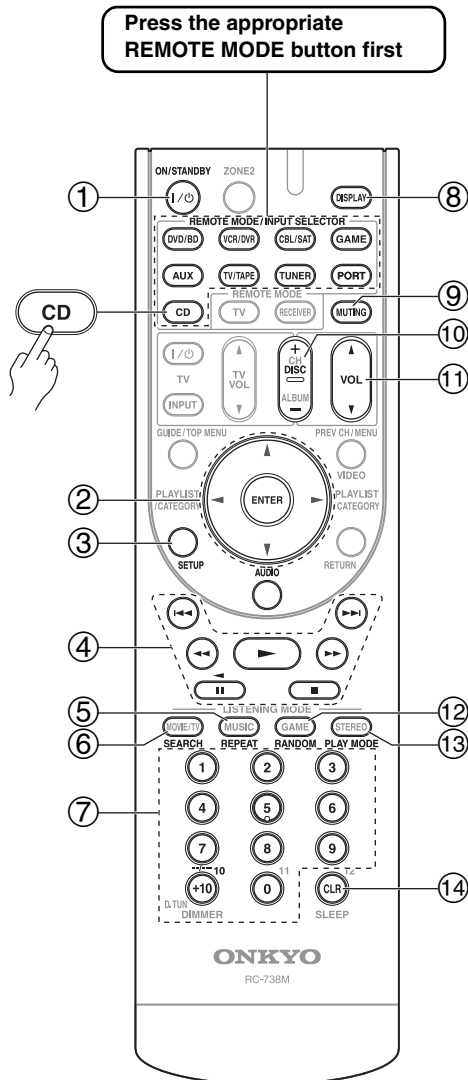

- ① **ON/STANDBY button**  
Set the component to On or Standby.
- ② **Arrow [▲]/[▼]/[◀]/[▶] and ENTER buttons\***  
Used to navigate menus and select items.
- ③ **SETUP button\***  
Used to access the Onkyo CD player's settings.
- ④ **[▶], [⏏], [■], [◀◀], [▶▶], [◀◀◀], [▶▶▶] buttons**  
Play, Pause, Stop, Rewind, Fast forward, Previous, and Next.
- ⑤ **REPEAT button**  
Used with the repeat playback function.
- ⑥ **SEARCH button\***  
Used to locate specific points.
- ⑦ **Number buttons**  
Used to enter track numbers and times for locating specific points. The [+10] button works as a +10 button or "--/--" button.
- ⑧ **DISPLAY button**  
Displays information about the current disc or track, including elapsed time, remaining time, total time, and so on.
- ⑨ **MUTING button (52)**  
Mutes or unmutes the AV receiver.
- ⑩ **DISC +/- button**  
Selects discs on a CD changer.
- ⑪ **VOL [▲]/[▼] button (50)**  
Adjusts the volume of the AV receiver.
- ⑫ **RANDOM button**  
Used with the random playback function.
- ⑬ **PLAY MODE button\***  
Selects play modes on components with selectable play modes.
- ⑭ **CLR button**  
Cancels functions and clears entered numbers.

### Notes:

- Buttons marked with an asterisk (\*) are not supported by the RI control.
- With some components, certain buttons may not work as expected, and some may not work at all.

## Controlling an RI Dock

By pressing the REMOTE MODE button that's been programmed with the remote control code for your Dock, you can control your iPod in the Dock with the following buttons.

For some RI docks, the [ON/STANDBY] button may not work with a remote control code **82990** (without **RI**). In this case, make an **RI** connection and enter a remote control code **82351** (with **RI**).

For details on entering a remote control code, see page 88.

### When Using an RI Dock:

- Connect the RI Dock to the TV/TAPE IN, VCR/DVR IN, or GAME IN L/R jacks.
- Set the RI Dock's RI MODE switch to HDD or HDD/DOCK.
- Set the AV receiver's Input Display to DOCK (see page 44).
- See to the Dock's instruction manual for more information.

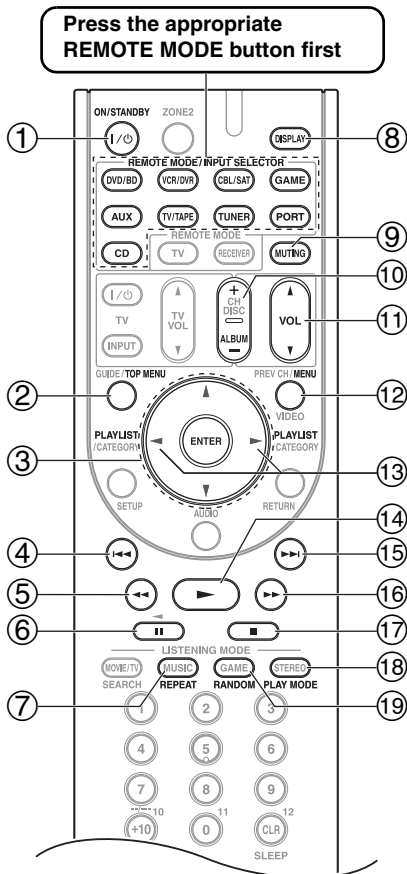

### ① ON/STANDBY button

Turns the iPod on or off.

### Notes:

- This button does not turn the Onkyo DS-A2 or DS-A2X RI Dock on or off.
- Your iPod may not respond the first time you press this button, in which case you should press it again. This is because the remote controller transmits the On and Standby commands alternately, so if your iPod is already on, it will remain on when the remote controller transmits an On command. Similarly, if your iPod is already off, it will remain off when the remote controller transmits an Off command.

### ② TOP MENU button

Works as a Mode button when used with a DS-A2 RI Dock.

### ③ Arrow [▲]/[▼] and ENTER buttons

Used to navigate menus and select items.

### ④ Previous [◀◀] button

Restarts the current song. Press it twice to select the previous song.

### ⑤ Rewind [◀◀] button

Press and hold to rewind.

### ⑥ Pause [⏸] button

Pauses playback.

### ⑦ REPEAT button

Used with the repeat function.

### ⑧ DISPLAY button

Turns on the backlight for 30 seconds.

### ⑨ MUTING button (52)

Mutes or unmutes the AV receiver.

### ⑩ ALBUM +/- button

Selects the next or previous album.

### ⑪ VOL [▲]/[▼] button (50)

Adjusts the volume of the AV receiver.

### ⑫ MENU button

Exits the menu.

### ⑬ PLAYLIST [◀]/[▶] button

Selects the previous or next playlist on the iPod.

### ⑭ Play [▶] button

Starts playback. If the component is off, it will turn on automatically.

### ⑮ Next [▶▶] button

Selects the next song.

### ⑯ Fast Forward [▶▶] button

Press and hold to fast forward.

### ⑰ Stop [■] button

Stops playback and displays a menu.

## Controlling Other Components—Continued

- ⑱ **PLAY MODE button**  
Selects play modes on components with selectable play modes.  
Works as a Resume button when used with a DS-A2 RI Dock.

- ⑲ **RANDOM button**  
Used with the shuffle function.

**Note:**

With some components, certain buttons may not work as expected, and some may not work at all.

### Controlling a Cassette Recorder

By pressing the REMOTE MODE button that's been programmed with the remote control code for your cassette recorder, you can control your cassette recorder with the following buttons.

The [TV/TAPE] button is preprogrammed with the remote control code for controlling an Onkyo cassette recorder when used with an RI connection.

For details on entering a remote control code for a different component, see page 88.

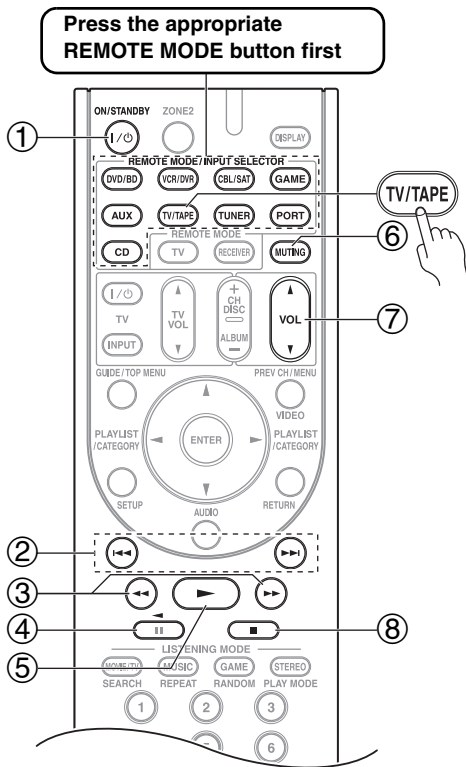

On twin cassette decks, only Deck B can be controlled.

- ① **ON/STANDBY button**  
Turns the cassette recorder on or off.
- ② **Previous and Next [◀◀]/[▶▶] buttons**  
The Previous [◀◀] button selects the previous track. During playback it selects the beginning of the current track. The Next [▶▶] button selects the next track.  
Depending on how they were recorded, the Previous and Next [◀◀]/[▶▶] buttons may not work properly with some cassette tapes.
- ③ **Rewind and Fast Forward [◀◀]/[▶▶] buttons**  
The Rewind [◀◀] button starts rewind. The Fast Forward [▶▶] button starts fast forward.
- ④ **Reverse Play [◀] button**  
Starts reverse playback.
- ⑤ **Play [▶] button**  
Starts playback.
- ⑥ **MUTING button (52)**  
Mutes or unmutes the AV receiver.
- ⑦ **VOL [▲]/[▼] button (50)**  
Adjusts the volume of the AV receiver.
- ⑧ **Stop [■] button**  
Stops playback.

**Note:**

An Onkyo cassette recorder connected via RI can also be controlled in Receiver mode.

\* With some components, certain buttons may not work as expected, and some may not work at all.

# Troubleshooting

If you have any trouble using the AV receiver, look for a solution in this section. If you can't resolve the issue yourself, contact your Onkyo dealer.

If you can't resolve the issue yourself, try resetting the AV receiver before contacting your Onkyo dealer.

**To reset the AV receiver to its factory defaults, turn it on and, while holding down the [VCR/DVR] button, press the [ON/STANDBY] button. "Clear" will appear on the display and the AV receiver will enter Standby mode.**



Note that resetting the AV receiver will delete your radio presets and custom settings.

The onscreen setup menus appear only on a TV that is connected to the HDMI OUT. If your TV is connected to the MONITOR OUT V, or the COMPONENT VIDEO OUT, use the AV receiver's display when changing settings.

## Power

### Can't turn on the AV receiver

- Make sure that the power cord is properly plugged into the wall outlet.
- Unplug the power cord from the wall outlet, wait five seconds or more, then plug it in again.

### The AV receiver turns off as soon as it's turned on

- The amp protection circuit has been activated. Remove the power cord from the wall outlet immediately. Disconnect all speaker cables and input sources, and leave the AV receiver with its power cord disconnected for 1 hour. After that, reconnect the power cord and set the volume to maximum. If the AV receiver stays on, set the volume to minimum, disconnect the power cord, and reconnect your speakers and input sources. If the AV receiver turns off when you set the volume to maximum, disconnect the power cord, and contact your Onkyo dealer.

## Audio

### There's no sound, or it's very quiet

- Make sure that the digital input source is selected properly (page 41).
- Make sure that all audio connecting plugs are pushed in all the way (page 21).
- Make sure that the inputs and outputs of all components are connected properly (pages 23–35).

- Make sure that the polarity of the speaker cables is correct, and that the bare wires are in contact with the metal part of each speaker terminal (page 16).
- Make sure that the input source is properly selected (page 50).
- Make sure that the speaker cables are not shorting.
- Check the volume. The AV receiver is designed for home theater enjoyment. It has a wide volume range, allowing precise adjustment.
- While a pair of headphones is connected to the PHONES jack, no sound is output by the speakers (page 52).
- If there's no sound from a DVD/BD player connected to an HDMI IN, check the DVD/BD player's output settings, and be sure to select a supported audio format.
- Check the digital audio output setting on the connected device. On some game consoles, such as those that support DVD, the default setting is off.
- With some DVD-Video discs, you need to select an audio output format from a menu.
- If your turntable uses an MC cartridge, you must connect an MC head amp, or an MC transformer.
- Make sure that none of the connecting cables are bent, twisted, or damaged.
- Not all listening modes use all speakers (page 64).
- Specify the speaker distances (page 68) and adjust the individual speaker levels (page 69).
- Make sure that the speaker setup microphone is not still connected.
- The input signal format is set to PCM or DTS. Set it to Auto (page 81).

### Only the front speakers produce sound

- When the Stereo or Mono listening mode is selected, only the front speakers and subwoofer produce sound.
- Check the Speaker Configuration (page 67).

### Only the center speaker produces sound

- If you use the Dolby Pro Logic IIx Movie, Dolby Pro Logic IIx Music, or Dolby Pro Logic IIx Game listening mode with a mono source, such as an AM radio station or mono TV program, the sound is concentrated in the center speaker.
- Make sure the speakers are configured correctly (page 67).

### The surround speakers produce no sound

- When the T-D (Theater-Dimensional), Stereo or Mono listening mode is selected, the surround speakers produce no sound.
- Depending on the source and current listening mode, not much sound may be produced by the surround speakers. Try selecting another listening mode.
- Make sure the speakers are configured correctly (page 67).

### The center speaker produces no sound

- When the Stereo or Mono listening mode is selected, the center speaker produces no sound.
- Make sure the speakers are configured correctly (page 67).

### The front high and surround back speakers produce no sound

- Depending on the current listening mode, no sound may be produced by the front high and surround back speakers. Select another listening mode (page 64).
- Not much sound may be produced by the front high and surround back speakers with some sources.
- Make sure the speakers are configured correctly (page 67).
- While Powered Zone 2 is being used, playback in the main room is reduced to 5.1-channels and the front high and surround back speakers produce no sound (page 82).

### The subwoofer produces no sound

- When you play source material that contains no information in the LFE channel, the subwoofer produces no sound.
- Make sure the speakers are configured correctly (page 67).

### There's no sound with a certain signal format

- Check the digital audio output setting on the connected device. On some game consoles, such as those that support DVD, the default setting is off.
- With some DVD-Video discs, you need to select an audio output format from a menu.
- Depending on the input signal, some listening modes cannot be selected (pages 60–63).

### Can't get 6.1/7.1 playback

- If no front high and surround back speakers are connected, or the Zone 2 speakers are being used, 6.1/7.1 playback is not possible.
- You can not always select all of the listening modes, depending on the number of the speakers connected (pages 60–63).

### The volume cannot be set to 79

- Check to see if a maximum volume has been set (page 77).
- If the volume level of each individual speaker has been adjusted to high positive values (page 69), then the maximum master volume possible may be reduced. Note that the individual speaker volume levels are set automatically after the Audyssey 2EQ™ Room Correction and Speaker Setup function has been completed (page 46).

### Noise can be heard

- Using cable ties to bundle audio cables with power cords, speaker cables, and so on may degrade the audio performance, so don't do it.
- An audio cable may be picking up interference. Try repositioning your cables.

### The Late Night function doesn't work

- Make sure the source material is Dolby Digital, Dolby Digital Plus, and Dolby TrueHD (page 72).

### About DTS signals

- When DTS program material ends and the DTS bit-stream stops, the AV receiver remains in DTS listening mode and the DTS indicator remains on. This is to prevent noise when you use the pause, fast forward, or fast reverse function on your player. If you switch your player from DTS to PCM, because the AV receiver does not switch formats immediately, you may not hear any sound, in which case you should stop your player for about three seconds, and then resume playback.
- With some CD and LD players, you won't be able to playback DTS material properly even though your player is connected to a digital input on the AV receiver. This is usually because the DTS bitstream has been processed (e.g., output level, sampling rate, or frequency response changed) and the AV receiver doesn't recognize it as a genuine DTS signal. In such cases, you may hear noise.
- When playing DTS program material, using the pause, fast forward, or fast reverse function on your player may produce a short audible noise. This is not a malfunction.

### The beginning of audio received by an HDMI IN can't be heard

- Since it takes longer to identify the format of an HDMI signal than it does for other digital audio signals, audio output may not start immediately.

## Video

### There's no picture

- Make sure that all video connecting plugs are pushed in all the way (page 21).
- Make sure that each video component is properly connected (pages 23–35).
- If your TV is connected to the HDMI OUT, select “- - - -” in the “HDMI Input Setup” on page 39 to watch composite video, and component video sources.
- If the video source is connected to a component video input, you must assign that input to an input selector (page 40), and your TV must be connected to either the HDMI OUT or COMPONENT VIDEO MONITOR OUT (pages 26 and 23).
- If the video source is connected to a composite video input, your TV must be connected to the HDMI OUT or the corresponding composite video output (pages 26 and 23).
- If the video source is connected to an HDMI input, you must assign that input to an input selector (page 39), and your TV must be connected to the HDMI OUT (page 23).
- On your TV, make sure that the video input to which the AV receiver is connected is selected.

### There's no picture from a source connected to an HDMI IN

- Reliable operation with an HDMI-to-DVI adapter is not guaranteed. In addition, video signals from a PC are not supported (page 23).
- If the message "Resolution Error" appears on the AV receiver's display, this indicates that your TV does not support the current video resolution and you need to select another resolution on your DVD/BD player.

### The onscreen menus don't appear

- On your TV, make sure that the video input to which the AV receiver is connected is selected.

### The immediate display does not appear

- Depending on the input signal, the immediate display may not appear when the input signal from the HDMI IN is output to a device connected to the HDMI OUT.

## Tuner

### Reception is noisy, FM stereo reception is noisy, or the FM STEREO indicator doesn't appear

- Relocate your antenna.
- Move the AV receiver away from your TV or computer.
- Listen to the station in mono (page 53).
- When listening to an AM station, operating the remote controller may cause noise.
- Passing cars and airplanes can cause interference.
- Concrete walls weaken radio signals.
- If nothing improves the reception, install an outdoor antenna.

## Remote Controller

### The remote controller doesn't work

- Make sure that the batteries are installed with the correct polarity (page 12).
- Install new batteries. Don't mix different types of batteries, or old and new batteries (page 12).
- Make sure that the remote controller is not too far away from the AV receiver, and that there's no obstruction between the remote controller and the AV receiver's remote control sensor (page 12).
- Make sure that the AV receiver is not subjected to direct sunshine or inverter-type fluorescent lights. Relocate if necessary.
- If the AV receiver is installed in a rack or cabinet with colored-glass doors, the remote controller may not work reliably when the doors are closed.
- Make sure you've selected the correct remote controller mode (pages 13 and 90-96).
- When using the remote controller to control other manufacturers' AV components, some buttons may not work as expected.
- Make sure you've entered the correct remote control code (page 88).
- Make sure to set the same ID on both the AV receiver and remote controller (page 78).

### Can't control other components

- If it's an Onkyo component, make sure that the **RI** cable and analog audio cable are connected properly. Connecting only an **RI** cable won't work (page 36).
- Make sure you've selected the correct remote controller mode (pages 13 and 90-96).
- If you've connected an **RI**-capable Onkyo RI Dock to the TV/TAPE IN, GAME IN or VCR/DVR IN jacks, for the remote controller to work properly, you must set the display to DOCK (page 44).  
If you cannot operate it, you will need to enter the appropriate remote control code (page 88).
- To control another manufacturer's component, point the remote controller at that component.
- To control an Onkyo component that's connected via **RI**, point the remote controller at the AV receiver. Be sure to enter the appropriate remote control code first (page 89).
- To control an Onkyo component that's not connected via **RI**, or another manufacturer's component, point the remote controller at the component. Be sure to enter the appropriate remote control code first (page 88).
- The entered remote control code may not be correct. If more than one code is listed, try each one.

## Dock for iPod

### There's no sound

- Make sure your iPod is actually playing.
- Make sure your iPod is inserted properly in the Dock.
- Make sure the UP-A1 series Dock is connected to the UNIVERSAL PORT jack on the AV receiver.
- Make sure the AV receiver is turned on, the correct input source is selected, and the volume is turned up.
- Make sure the plugs are pushed in all the way.
- Try resetting your iPod.

### There's no video

- Make sure that your iPod's TV OUT setting is set to On.
- Make sure the correct input is selected on your TV or the AV receiver.
- Some versions of the iPod do not output video.

### The AV receiver's remote controller doesn't control your iPod

- Make sure your iPod is properly inserted in the Dock. If your iPod is in a case, it may not connect properly to the Dock. Always remove your iPod from the case before inserting it into the Dock.
- The iPod cannot be operated while it's displaying the Apple logo.
- Make sure you've selected the right remote mode.
- When you use the AV receiver's remote controller, point it toward your amp.
- If you still can't control your iPod, start playback by pressing your iPod's Play button. Remote operation should then be possible.
- Try resetting your iPod.
- Depending on your iPod, some buttons may not work as expected.

### The AV receiver unexpectedly selects your iPod as the input source

- Always pause iPod playback before selecting a different input source. If playback is not paused, the Direct Change function may select your iPod as the input source by mistake during the transition between tracks.

#### Recording

##### Can't record

- On your recorder, make sure the correct input is selected.

#### Zone 2

##### There's no sound

- Only components connected to analog inputs can be played in Zone 2.

#### Others

##### The sound changes when I connect my headphones

- When a pair of headphones is connected, the listening mode is set to Stereo, unless it's already set to Stereo, Mono, or Direct.

##### How do I change the language of a multiplex source

- Use the "Multiplex" setting on the "Audio Adjust" menu to select "Main" or "Sub" (page 70).

##### The RI functions don't work

- To use **RI**, you must make an **RI** connection and an analog audio connection (RCA) between the component and AV receiver, even if they are connected digitally (page 36).

##### The functions Auto Power On/Standby and Direct Change don't work for components connected via RI

- These functions don't work when Zone 2 is turned on.

##### When performing "Audyssey 2EQ™ Room Correction and Speaker Setup", the measurement fails showing the message "Ambient noise is too high".

- This can be caused by any malfunction in your speaker unit. Check if the unit produces normal sounds.

##### The following settings can be made for the composite video inputs

You must use the buttons on the unit to make these settings.

1. While holding down the input selector button for the input source that you want to set, press the [SETUP] button.
2. Use the Left and Right [◀]/[▶] buttons to change the setting.
3. Press the input selector button for the input source that you want to set when you've finished.

##### • Video Attenuation

This setting can be made for the DVD/BD, VCR/DVR, CBL/SAT, GAME, or AUX input.

If you have a games console connected to the composite video input, and the picture isn't very clear, you can attenuate the gain.

**Video ATT:OFF:** (default).

**Video ATT:ON:** Gain is reduced by 2 dB.

The AV receiver contains a microcomputer for signal processing and control functions. In very rare situations, severe interference, noise from an external source, or static electricity may cause it to lockup. In the unlikely event that this happens, unplug the power cord from the wall outlet, wait at least five seconds, and then plug it back in again.

Onkyo is not responsible for damages (such as CD rental fees) due to unsuccessful recordings caused by the unit's malfunction. Before you record important data, make sure that the material will be recorded correctly.

Before disconnecting the power cord from the wall outlet, set the AV receiver to Standby.

#### Important Note Regarding Video Playback

The AV receiver can upconvert component video and composite video sources for display on a TV connected to the HDMI OUT. However, if the picture quality of the source is poor, upconversion may make the picture worse or disappear altogether.

In this case, try the following:

- 1 **If the video source is connected to a component video input, connect your TV to the COMPONENT VIDEO OUT.**

If the video source is connected to a composite video input, connect your TV to the MONITOR OUT V.

- 2 **On the main menu, select "1. Input Assign", and then select "1. HDMI Input".**  
Select the relevant input selector, and assign it to "- - - -" (page 39).

- 3 **On the main menu, select "1. Input Assign", and then select "2. Component Video Input" (page 40):**

If the video source is connected to COMPONENT VIDEO IN1, select the relevant input selector, and assign it to "IN1".

If the video source is connected to COMPONENT VIDEO IN2, select the relevant input selector, and assign it to "IN2".

If the video source is connected to composite video input, select the relevant input selector, and assign it to "- - - -".



# Specifications

## Amplifier Section

Rated Output Power	
<b>All channels:</b>	<b>80 watts minimum continuous power per channel, 8 ohm loads, from 20 Hz to 20 kHz with a maximum total harmonic distortion of 0.08%. 90 watts minimum continuous power per channel, 8 ohm loads, at 1 kHz with a maximum total harmonic distortion of 0.7%. 130 watts minimum continuous power per channel, 6 ohm loads, at 1 kHz with a maximum total harmonic distortion of 1%.</b>
Dynamic Power	180 W (3 $\Omega$ , Front) 160 W (4 $\Omega$ , Front) 100 W (8 $\Omega$ , Front)
THD (Total Harmonic Distortion)	0.08% (Power Rated)
Damping Factor	60 (Front, 1 kHz, 8 $\Omega$ )
Input Sensitivity and Impedance	200 mV/47 k $\Omega$ (LINE)
Output Level and Impedance	200 mV/2.2 k $\Omega$ (REC OUT)
Frequency Response	5 Hz - 100 kHz/+1 dB, - 3 dB (Direct mode)
Tone Control	$\pm$ 10 dB, 50 Hz (BASS) $\pm$ 10 dB, 20 kHz (TREBLE)
Signal to Noise Ratio	106 dB (LINE, IHF-A)
Speaker Impedance	6 $\Omega$ - 16 $\Omega$

## Video Section

Input Sensitivity/Output Level and Impedance	1 V <sub>p</sub> -p/75 $\Omega$ (Component Y) 0.7 V <sub>p</sub> -p/75 $\Omega$ (Component P <sub>B</sub> /C <sub>B</sub> , P <sub>R</sub> /C <sub>R</sub> ) 1 V <sub>p</sub> -p/75 $\Omega$ (Composite)
Component Video Frequency Response	5 Hz - 50 MHz, - 3 dB

## Tuner Section

FM Tuning Frequency Range	87.5 MHz - 107.9 MHz
AM Tuning Frequency Range	530 kHz - 1710 kHz
Preset Channel	40

## General

Power Supply	AC 120 V, 60 Hz
Power Consumption	5.5 A
Dimensions (W $\times$ H $\times$ D)	435 $\times$ 176 $\times$ 329 mm (17-1/8" $\times$ 6-15/16" $\times$ 12-15/16")
Weight	10.8 kg (23.8 lbs.)

### Video Inputs

HDMI	IN 1, IN 2, IN 3, IN 4, IN 5
Component	IN 1, IN 2
Composite	DVD/BD, VCR/DVR, CBL/SAT, GAME, AUX

### Video Outputs

HDMI	OUT
Component	OUT
Composite	MONITOR OUT, VCR/DVR (REC OUT)

### Audio Inputs

Digital Inputs	Optical: 2 Coaxial: 2
Analog Inputs	DVD/BD, VCR/DVR, CBL/SAT, GAME, AUX (PORTABLE), TV/TAPE, CD

### Audio Outputs

Analog Outputs	TV/TAPE, VCR/DVR, ZONE 2 LINE OUT
Subwoofer Pre Outputs	2
Speaker Outputs	Main (L, R, C, SL, SR, SBL, SBR) + ZONE2 (L, R)/ Front High (L, R)
Phones	1

### Control Terminal

MIC	Yes
-----	-----

Specifications and features are subject to change without notice.

# Video Resolution Chart

The following tables show how video signals at different resolutions are output by the AV receiver.

✓: Output

Input \ Output		HDMI					COMPONENT				COMPOSITE
		1080p (60Hz/24Hz)	1080i	720p	480p	480i	1080i	720p	480p	480i	480i
HDMI	1080p	✓									
	1080i		✓								
	720p			✓							
	480p				✓						
	480i					✓					
COMPONENT	1080i		✓	✓			✓				
	720p		✓	✓				✓			
	480p		✓	✓	✓				✓		
	480i		✓	✓	✓	✓				✓	
COMPOSITE	480i		✓	✓	✓	✓					✓

# Memo

---

## **ONKYO CORPORATION**

Sales & Product Planning Div. : 2-1, Nisshin-cho, Neyagawa-shi, OSAKA 572-8540, JAPAN  
Tel: 072-831-8023 Fax: 072-831-8163

### **ONKYO U.S.A. CORPORATION**

18 Park Way, Upper Saddle River, N.J. 07458, U.S.A.  
Tel: 201-785-2600 Fax: 201-785-2650 <http://www.us.onkyo.com/>

### **ONKYO EUROPE ELECTRONICS GmbH**

Liegnitzerstrasse 6, 82194 Groebenzell, GERMANY  
Tel: +49-8142-4401-0 Fax: +49-8142-4401-555 <http://www.eu.onkyo.com/>

### **ONKYO EUROPE UK Office**

Suite 1, Gregories Court, Gregories Road, Beaconsfield, Buckinghamshire, HP9 1HQ  
UNITED KINGDOM Tel: +44-(0)1494-681515 Fax: +44(0)-1494-680452

### **ONKYO CHINA LIMITED**

Unit 1&12, 9/F, Ever Gain Plaza Tower 1, 88, Container Port Road, Kwai Chung,  
N.T., HONG KONG Tel: 852-2429-3118 Fax: 852-2428-9039  
<http://www.ch.onkyo.com/>



Y0905-1

SN 29400095

(C) Copyright 2009 ONKYO CORPORATION Japan. All rights reserved.



Download from [www.Somanuals.com](http://www.Somanuals.com). All Manuals Search And Download. \* 2 9 4 0 0 0 9 5 \*

## Free Manuals Download Website

<http://myh66.com>

<http://usermanuals.us>

<http://www.somanuals.com>

<http://www.4manuals.cc>

<http://www.manual-lib.com>

<http://www.404manual.com>

<http://www.luxmanual.com>

<http://aubethermostatmanual.com>

Golf course search by state

<http://golfingnear.com>

Email search by domain

<http://emailbydomain.com>

Auto manuals search

<http://auto.somanuals.com>

TV manuals search

<http://tv.somanuals.com>