

AV Receiver

TX-NR801 *TX-NR801E*

Instruction Manual

Thank you for purchasing an Onkyo AV Receiver. Please read this manual thoroughly before making connections and plugging in the unit. Following the instructions in this manual will enable you to obtain optimum performance and listening enjoyment from your new AV Receiver. Please retain this manual for future reference.

Contents

Before using	2
Facilities and connections	8
Setting up your TX-NR801/TX-NR801E	28
Enjoying Music and Movies	39
Useful Settings (Basic)	52
Useful Settings (Advanced)	56
Making full use of your TX-NR801/TX-NR801E	64
Remote Controller	80
Appendix	90

WARNING:

TO REDUCE THE RISK OF FIRE OR ELECTRIC SHOCK, DO NOT EXPOSE THIS APPARATUS TO RAIN OR MOISTURE.

CAUTION:

TO REDUCE THE RISK OF ELECTRIC SHOCK, DO NOT REMOVE COVER (OR BACK). NO USER-SERVICEABLE PARTS INSIDE. REFER SERVICING TO QUALIFIED SERVICE PERSONNEL.



WARNING
RISK OF ELECTRIC SHOCK
DO NOT OPEN

AVIS
RISQUE DE CHOC ELECTRIQUE
NE PAS OUVRIIR



The lightning flash with arrowhead symbol, within an equilateral triangle, is intended to alert the user to the presence of uninsulated "dangerous voltage" within the product's enclosure that may be of sufficient magnitude to constitute a risk of electric shock to persons.



The exclamation point within an equilateral triangle is intended to alert the user to the presence of important operating and maintenance (servicing) instructions in the literature accompanying the appliance.

Important Safety Instructions

1. Read these instructions.
2. Keep these instructions.
3. Heed all warnings.
4. Follow all instructions.
5. Do not use this apparatus near water.
6. Clean only with dry cloth.
7. Do not block any ventilation openings. Install in accordance with the manufacturer's instructions.
8. Do not install near any heat sources such as radiators, heat registers, stoves, or other apparatus (including amplifiers) that produce heat.
9. Do not defeat the safety purpose of the polarized or grounding-type plug. A polarized plug has two blades with one wider than the other. A grounding type plug has two blades and a third grounding prong. The wide blade or the third prong are provided for your safety. If the provided plug does not fit into your outlet, consult an electrician for replacement of the obsolete outlet.
10. Protect the power cord from being walked on or pinched particularly at plugs, convenience receptacles, and the point where they exit from the apparatus.
11. Only use attachments/accessories specified by the manufacturer.
12. Use only with the cart, stand, tripod, bracket, or table specified by the manufacturer, or sold with the apparatus. When a cart is used, use caution when moving the cart/apparatus combination to avoid injury from tip-over.

PORTABLE CART WARNING
S3125A
13. Unplug this apparatus during lightning storms or when unused for long periods of time.
14. Refer all servicing to qualified service personnel. Servicing is required when the apparatus has been damaged in any way, such as power-supply cord or plug is damaged, liquid has been spilled or objects have fallen into the apparatus, the apparatus has been exposed to rain or moisture, does not operate normally, or has been dropped.
15. Damage Requiring Service
- Unplug the apparatus from the wall outlet and refer servicing to qualified service personnel under the following conditions:
 - A. When the power-supply cord or plug is damaged,
 - B. If liquid has been spilled, or objects have fallen into the apparatus,
 - C. If the apparatus has been exposed to rain or water,
 - D. If the apparatus does not operate normally by following the operating instructions. Adjust only those controls that are covered by the operating instructions as an improper adjustment of other controls may result in damage and will often require extensive work by a qualified technician to restore the apparatus to its normal operation,
 - E. If the apparatus has been dropped or damaged in any way, and
 - F. When the apparatus exhibits a distinct change in performance this indicates a need for service.
16. Object and Liquid Entry
Never push objects of any kind into the apparatus through openings as they may touch dangerous voltage points or short-out parts that could result in a fire or electric shock.
The apparatus shall not be exposed to dripping or splashing and no objects filled with liquids, such as vases shall be placed on the apparatus.
Don't put candles or other burning objects on top of this unit.
17. Batteries
Always consider the environmental issues and follow local regulations when disposing of batteries.
18. If you install the apparatus in a built-in installation, such as a bookcase or rack, ensure that there is adequate ventilation.
Leave 20 cm (8") of free space at the top and sides and 10 cm (4") at the rear. The rear edge of the shelf or board above the apparatus shall be set 10 cm (4") away from the rear panel or wall, creating a flue-like gap for warm air to escape.

Precautions

1. Recording Copyright

Unless it's for personal use only, recording copyrighted material is illegal without permission of the copyright holder.

2. AC Fuse

The AC fuse inside the TX-NR801/TX-NR801E is not user-serviceable. If you cannot turn on the TX-NR801/TX-NR801E, contact your Onkyo dealer.

3. Care

Occasionally you should dust the TX-NR801/TX-NR801E all over with a soft cloth. For stubborn stains, use a soft cloth dampened with a weak solution of mild detergent and water. Dry the TX-NR801/TX-NR801E immediately afterwards with a clean cloth. Don't use abrasive cloths, thinners, alcohol, or other chemical solvents, because they may damage the finish or remove the panel lettering.

4. Power

WARNING

BEFORE PLUGGING IN THE UNIT FOR THE FIRST TIME, READ THE FOLLOWING SECTION CAREFULLY.

AC outlet voltages vary from country to country. Make sure that the voltage in your area meets the voltage requirements printed on the TX-NR801/TX-NR801E's rear panel (e.g., AC 230 V, 50 Hz or AC 120 V, 60 Hz).

The Worldwide model has a voltage selector for compatibility with power systems around the world. Before you plug in this model, make sure that the voltage selector is set to the correct voltage for your area.

For USA, Canadian and Australian models

Setting the [STANDBY/ON] switch to STANDBY does not fully shutdown the TX-NR801/TX-NR801E. If you do not intend to use the TX-NR801/TX-NR801E for an extended period, remove the power cord from the AC outlet.

For British Models

Replacement and mounting of an AC plug on the power supply cord of this unit should be performed only by qualified service personnel.

IMPORTANT

The wires in the mains lead are coloured in accordance with the following code:

Blue: Neutral

Brown: Live

As the colours of the wires in the mains lead of this apparatus may not correspond with the coloured markings identifying the terminals in your plug, proceed as follows:

The wire which is coloured blue must be connected to the terminal which is marked with the letter N or coloured black.

The wire which is coloured brown must be connected to the terminal which is marked with the letter L or coloured red.

IMPORTANT

A 5 ampere fuse is fitted in this plug. Should the fuse need to be replaced, please ensure that the replacement fuse has a rating of 5 amperes and that it is approved by ASTA or BSI to BS1362. Check for the ASTA mark or the BSI mark on the body of the fuse.

IF THE FITTED MOULDED PLUG IS UNSUITABLE FOR THE SOCKET OUTLET IN YOUR HOME THEN THE FUSE SHOULD BE REMOVED AND THE PLUG CUT OFF AND DISPOSED OF SAFELY. THERE IS A DANGER OF SEVERE ELECTRICAL SHOCK IF THE CUT OFF PLUG IS INSERTED INTO ANY 13 AMPERE SOCKET.

If in any doubt, consult a qualified electrician.

For U.S. Models

Note to CATV system installer:

This reminder is provided to call the CATV system installer's attention to Section 820-40 of the NEC which provides guidelines for proper grounding and, in particular, specifies that the cable ground shall be connected to the grounding system of the building, as close to the point of cable entry as practical.

FCC Information for User

CAUTION:

The user changes or modifications not expressly approved by the party responsible for compliance could void the user's authority to operate the equipment.

NOTE:

This equipment has been tested and found to comply with the limits for a Class B digital device, pursuant to Part 15 of the FCC Rules. These limits are designed to provide reasonable protection against harmful interference in a residential installation. This equipment generates, uses and can radiate radio frequency energy and, if not installed and used in accordance with the instructions, may cause harmful interference to radio communications. However, there is no guarantee that interference will not occur in a particular installation. If this equipment does cause harmful interference to radio or television reception, which can be determined by turning the equipment off and on, the user is encouraged to try to correct the interference by one or more of the following measures:

- Reorient or relocate the receiving antenna.
- Increase the separation between the equipment and receiver.
- Connect the equipment into an outlet on a circuit different from that to which the receiver is connected.
- Consult the dealer or an experienced radio/TV technician for help.

For Canadian Models

NOTE: THIS CLASS B DIGITAL APPARATUS COMPLIES WITH CANADIAN ICES-003.

For models having a power cord with a polarized plug:

CAUTION: TO PREVENT ELECTRIC SHOCK, MATCH WIDE BLADE OF PLUG TO WIDE SLOT, FULLY INSERT.

Modèle Canadien

REMARQUE: CET APPAREIL NUMÉRIQUE DE LA CLASSE B EST CONFORME À LA NORME NMB-003 DU CANADA.

Sur les modèles dont la fiche est polarisée:

ATTENTION: POUR ÉVITER LES CHOCs ÉLECTRIQUES, INTRODUIRE LA LAME LA PLUS LARGE DE LA FICHE DANS LA BORNE CORRESPONDANTE DE LA PRISE ET POUSSER JUSQU'AU FOND.

For European Models

Declaration of Conformity

We, ONKYO EUROPE
ELECTRONICS GmbH
LIEGNITZERSTRASSE 6,
82194 GROEBENZELL,
GERMANY



declare in own responsibility, that the ONKYO product described in this instruction manual is in compliance with the corresponding technical standards such as EN60065, EN55013, EN55020 and EN61000-3-2, -3-3.

GROEBENZELL, GERMANY

I. MORI

ONKYO EUROPE ELECTRONICS GmbH

Table of Contents

Before using

Important Safety Instructions	2
Precautions	3
Table of Contents	4
Features	6
Supplied Accessories	6
Before Using the TX-NR801/TX-NR801E	7
Setting the Voltage Selector (Worldwide model only)	7
Installing the Batteries	7
Using the Remote Controller	7

Facilities and connections

Index Parts and Facilities	8
Front Panels	8
Front Panel Display	10
Rear Panel.....	11
Remote Controller	12
Connecting Antenna	14
Connecting the Indoor FM Antenna.....	14
Connecting the AM Loop Antenna.....	14
Connecting an Outdoor FM Antenna	15
Connecting an Outdoor AM Antenna.....	15
About Home Theater	16
Enjoying Home Theater.....	16
Speaker Placement	17
Connecting Speakers	18
Using the Speaker Cable Labels	18
AV Cables and Connectors	19
Connecting to Audio/Video Equipment.....	20
Connecting a Television Monitor or Projector (MONITOR OUT)	20
Connecting a DVD Player (DVD).....	21
Connecting a Video Cassette Recorder (VIDEO 1).....	21
Connecting a DVD Recorder or Other Digital Video Recording Device (VIDEO 2).....	22
Connecting a Satellite Tuner, Television, or Settop Box (VIDEO 3 or 4).....	22
Connecting Video Camera, etc. (VIDEO 5 INPUT)	23
Connecting a Compact Disc Player (CD)	23
Connecting a Turntable (PHONO).....	24
Connecting a Cassette Tape Deck, MD Recorder, DAT Deck, or CD Recorder (TAPE).....	24
Connecting the Power Cords from Other Devices	24
Connecting Auxiliary Power Amplifier.....	25
Connecting R I-compatible AV Components	26
Connections for Remote Control (R I)	26
Connecting the Power	27
Turning on the Power	27
Turning on the Power from the Remote Controller.....	27

Setting up your TX-NR801/TX-NR801E

Setup Menu	28
Navigating Through the Setup Menu	29
Selecting the Appropriate Setting for Your Connections	30
Hardware Setup	30
Speaker Impedance Sub-menu.....	30
Surr Back/Zone 2 Sub-menu.....	30
Remote Setup Sub-menu.....	31
TV Format Sub-menu.....	31
AM Frequency Step Sub-menu (Worldwide model Only).....	31
Speaker Setup	32
Speaker Config Sub-menu	33
Speaker Distance Sub-menu	33
Level Calibration Sub-menu.....	34
Configuring Input Settings Suitable for Your Connections	35
To Change the Display of the Input Source from TAPE to MD	35
Input Setup	36
Digital Setup Sub-menu	36
Multichannel Setup Sub-menu	37
Video Setup Sub-menu	38

Also refer to the sections below when you want to make advance settings to suit your preferences.

Useful Settings (Basic)

Input Setup (Basic)	52
Labelling the Input Source (Character Input)	52
Adjusting the Volume Differences Between Components (IntelliVolume)	53
Audio Adjust (Basic)	54
Adjusting the Bass and Treble Sound (Tone Control).....	54
Selecting Surround Speakers to Output the Sound (Surround Speakers).....	54
Setting the Various Sound Effects (Sound Effect)	55

Useful Settings (Advanced)

Input Setup (Advanced)	56
Configuring the Listening Modes You Use Frequently (Listening Mode Preset)	56
Audio Adjust (Advanced).....	57
Adjusting the Audio Delay (Delay Sub-menu) ...	57
Setting the Low Frequency Effect Levels (LFE Level).....	58
Detailed Settings for Each Listening Mode ...	58
Preference (Advanced).....	62
Volume Setup Sub-menu.....	62
Adjusting the Headphone Volume Level (Headphones Level)	63
Setting the Background Color for OSD (OSD Setup)	63
Switching the OSD Position (OSD Position)....	63

Enjoying Music and Movies

Enjoying Music or Videos with the TX-NR801/ TX-NR801E 39

Basic Operation..... 39

Temporarily turning off the sound..... 39

Listening with headphones..... 39

Temporarily Changing the Speaker Output Levels..... 40

Using the Sleep Timer (remote controller only)..... 40

Adjusting the brightness of the front display..... 40

Switching the display..... 41

Changing the audio mode..... 41

Adjusting the bass and treble..... 41

Using the Listening Modes 42

Listening Modes 42

Selecting the Listening Mode 44

Listening to Radio Broadcasts 46

Tuning Into a Radio Station..... 46

Presetting a Radio Station 47

According to your connected devices or environments, you can enjoy more of audio and video with TX-NR801/TX-NR801E's advanced functions.

Making full use of your TX-NR801/TX-NR801E

Enjoying Analog Multichannel Audio Playback 64

Connecting to Devices with Analog Multichannel Output..... 64

Setup for Multichannel Output..... 64

Playing Analog Multichannel Audio..... 65

Enjoying music in the Remote Zone 66

Connecting the Remote Zone (Zone 2)

Speakers and the Monitor or Projector 66

Performing the Settings for the Remote Zone (Zone 2) 67

Enjoying Music in the Remote Zone 68

Operating Components not Reached by the Remote Controller Signals (IR IN/OUT)..... 69

If Remote Controller Signal Does not Reach the TX-NR801/TX-NR801E Remote Sensor..... 69

If Remote Controller Signal Does not Reach Other Components 69

Enjoying Net Audio..... 70

Features 70

System Requirements..... 70

Connecting the TX-NR801/TX-NR801E to Your Ethernet Network 71

Network Setup Menu..... 72

Input Setup Menu..... 74

Enjoying Internet Radio..... 76

Playing a Music File Saved on Your PC 78

Listening to RDS Broadcasts (European models only)48

Listening to RDS Broadcasts.....48

PTY Program Types in Europe.....48

Displaying Radio Text (RT)49

Performing a PTY Scan.....49

Performing a TP Scan49

Recording a Source50

To Record the Input Source Signal You are Currently Watching/Listening50

To Record an Input Source Signal Different from that You are Currently Watching/Listening...50

Recording the Video from One Source and the Audio from Another.....51

Remote Controller

Operating Onkyo Products Using the Remote Controller80

Operating Onkyo Products Using the **RI** Connection.....80

Operating Other Manufacturers' Devices Using the Remote Controller.....82

Learning a Pre-programming Code82

Operating Other Manufacturers' Devices84

Letting the Remote Controller Learn the Codes from Other Remote Controllers.....86

Programming Procedure86

Using the Macro Function88

Programming the Macro88

Executing the Macro89

Appendix

Troubleshooting Guide.....90

POWER90

SPEAKERS90

FM/AM TUNER.....90

VIDEO and AUDIO91

NET AUDIO91

REMOTE CONTROLLER.....92

OTHER92

If One of the Messages Shown Below Appears.....93

Specifications.....94

Features

Amplifier Features

- 100 Watts per channel min. RMS. into 8 Ω 2 channel driven, from 20 Hz to 20 kHz with no more than 0.08% total harmonic distortion (FTC)
- 2 \times 160 Watts into 6 Ω , 1,000 Hz (EIAJ)
- 7 Channel Amplifier
- Wide Range Amplifier Technology (WRAT)
- Linear Optimum Gain Volume Circuitry
- 192 kHz/24 Bit D/A Converters (except for Surround Back L/R)
- Zone 2 Capability

Audio/Video Features

- THX[®] Surround EX[®]
- THX Select Certified
- Dolby[®]* Digital, Dolby Digital EX, Dolby Pro Logic II
- DTS, DTS-ES Discrete, DTS-ES Matrix, DTS Neo:6, and DTS 96/24
- Theater-Dimensional[™] Virtual Surround Mode
- Non-Scaling Configuration
- Onscreen Displays (Basic Menu/Advanced Menu)
- 2 Wideband Component-Video Inputs/1 Output
- Video Converter (other than USA, Canadian and Australian models)
- Composite to S-Video Conversion
- 6 S-Video Inputs/3 Outputs
- 6 Assignable Digital Inputs (3 optical/3 Coaxial), 2 output, and 1 Digital Input (optical on the front panel)
- Pre Out Terminals for Front L/R, Center, Surround L/R, Surround Back L/R or Zone 2 L/R and Subwoofer

FM/AM Tuner Features

- 40 FM/AM Random Presets
- FM Auto Tuning

Other Performance Features

- VLSC (Vector Linear Shaping Circuitry) for L/C/R channels (Other than US & Canadian models and Australian models)
- IntelliVolume
- Character Input
- Net-Tune Function with MP3/WAV/WMA Decoding
- Ethernet Cable Plug-in Capability

- * Manufactured under license from Dolby Laboratories. "Dolby," "Pro Logic," "Surround EX" and the double-D symbol are trademarks of Dolby Laboratories.
- "DTS," "DTS 96/24," "DTS-ES" and "Neo:6" are trademarks of Digital Theater Systems, Inc.
 - THX is a trademark or registered trademark of THX Ltd.
 - Re-Equalization and the "Re-EQ" logo are trademarks of THX Ltd.
 - "Theater-Dimensional" and "Net-Tune" are trademarks of Onkyo Corporation.
 - Windows Media and the Windows logo are trademarks, or registered trademarks of Microsoft Corporation in the United States and/or other countries.





- Intel and Pentium are registered trademarks of Intel Corporation.
- MPEG Layer-3 audio coding technology licensed from Fraunhofer IIS and THOMSON multimedia.
- "XiVA" is a registered trademark of Imerge Limited.
- Xantech is a registered trademark of Xantech Corporation.
- Niles is a registered trademark of Niles Audio Corporation.

THX Select

Before any home theater component can be THX Select certified, it must pass a rigorous series of quality and performance tests. Only then can a product feature the THX Select logo, which is your guarantee that the Home Theater products you purchase will give you superb performance for many years to come. THX Select requirements define hundreds of parameters, including power amplifier performance, and pre-amplifier performance and operation for both digital and analog domains. THX Select receivers also feature proprietary THX technologies (e.g., THX Mode) which accurately translate film soundtracks for home theater playback.

Supplied Accessories

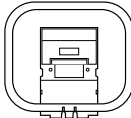
Make sure you have the following accessories:

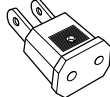
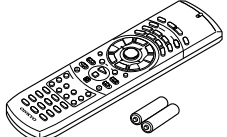
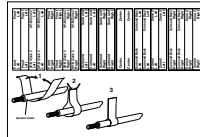
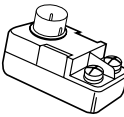
 <p>AM loop antenna</p>	 <p>Indoor FM antenna (connector type varies from country to country)</p>	 <p>Power-plug adapter</p> <p>Only supplied in certain countries. Use this adapter if your AC outlet does not match with the plug on the TX-NR801/TX-NR801E's power cord (Adapter varies from country to country).</p>
 <p>Remote controller & two batteries (AA/R6)</p>	 <p>Speaker cable labels</p>	 <p>75/300 ohm antenna adapter</p> <p>Not supplied with USA, Canadian and European models.</p>

*In catalogs and on packaging, the letter added to the end of the product name indicates the color of the TX-NR801/TX-NR801E. Specifications and operation are the same regardless of color.

Before Using the TX-NR801/TX-NR801E

Setting the Voltage Selector (Worldwide model only)

The worldwide model has a voltage selector for compatibility with power systems around the world. Before you plug in this model, make sure that the voltage selector is set to the correct voltage for your area. If it isn't, use a small screwdriver to set it appropriately. For example, if the voltage in your area is 120 volts (V), set the selector to "120V." And if it's between 220 and 230 volts (V), set it to "220-230V."

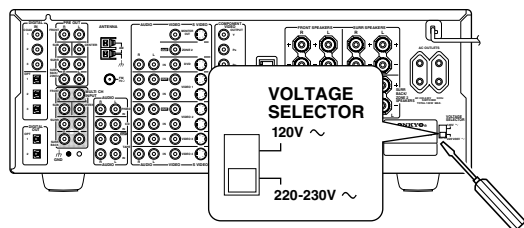

Installing the Batteries

- 1 Remove the battery compartment cover by pressing it and sliding it in the direction shown by the arrow below.

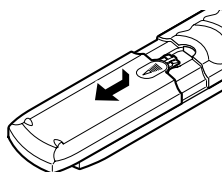

- 2 Insert the two supplied batteries (AA/R6) in accordance with the polarity diagram inside the battery compartment.

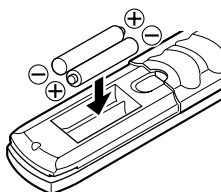

- 3 After the batteries are installed and seated correctly, replace the compartment cover.

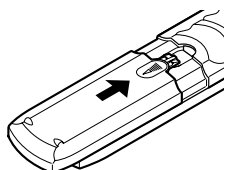

Notes:

- The supplied batteries should last for about six months, although this will vary with usage.
- If the remote controller doesn't work reliably, try replacing both batteries.
- Don't mix new and old batteries, or different types of batteries.
- If you intend not to use the remote controller for a long time, remove the batteries to prevent possible leakage and corrosion.
- Dead batteries should be removed as soon as possible to prevent possible leakage and corrosion.

Using the Remote Controller

To use the remote controller, point it at the TX-NR801/TX-NR801E's remote control sensor, as shown below. The TX-NR801/TX-NR801E's STANDBY indicator flashes while a signal is being received from the remote controller.

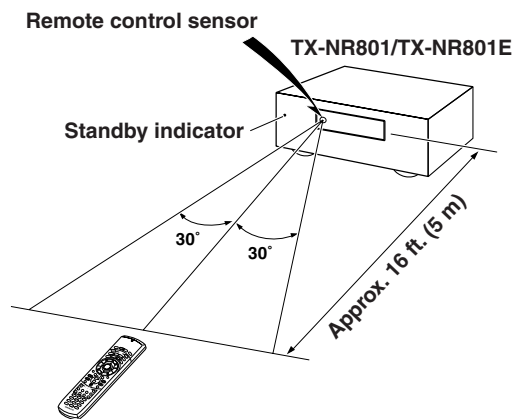

Notes:

- The remote controller may not work reliably if the TX-NR801/TX-NR801E is subjected to bright light, such as direct sunlight or inverter-type fluorescent lights. Keep this in mind when installing the TX-NR801/TX-NR801E.
- If another remote controller of the same type is used in the same room, or the TX-NR801/TX-NR801E is installed close to equipment that uses infrared rays, the remote controller may not work reliably.
- Don't put anything, such as a book, on the remote controller, because the buttons may be pressed inadvertently, thereby draining the batteries.
- The remote controller may not work reliably if the TX-NR801/TX-NR801E is installed in a rack behind colored glass doors. Keep this in mind when installing the TX-NR801/TX-NR801E.
- The remote controller will not work if there's an obstacle between it and the TX-NR801/TX-NR801E's remote control sensor.

Index Parts and Facilities

Here is an explanation of the controls and displays on the front panel of the TX-NR801/TX-NR801E. The specifications for your model may differ due to regional requirements.

Front Panels

USA, Canadian and Australian models

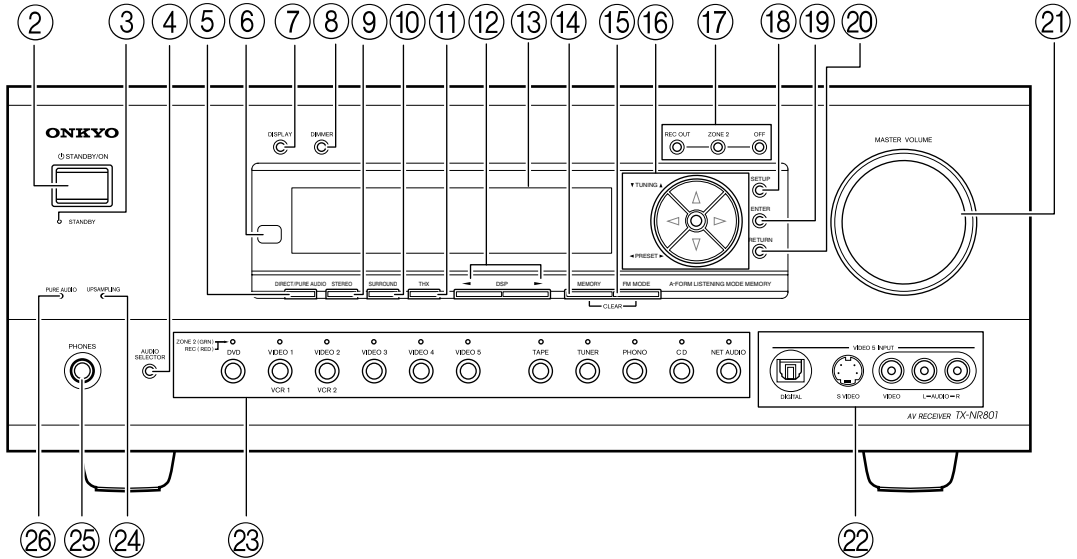

Other models

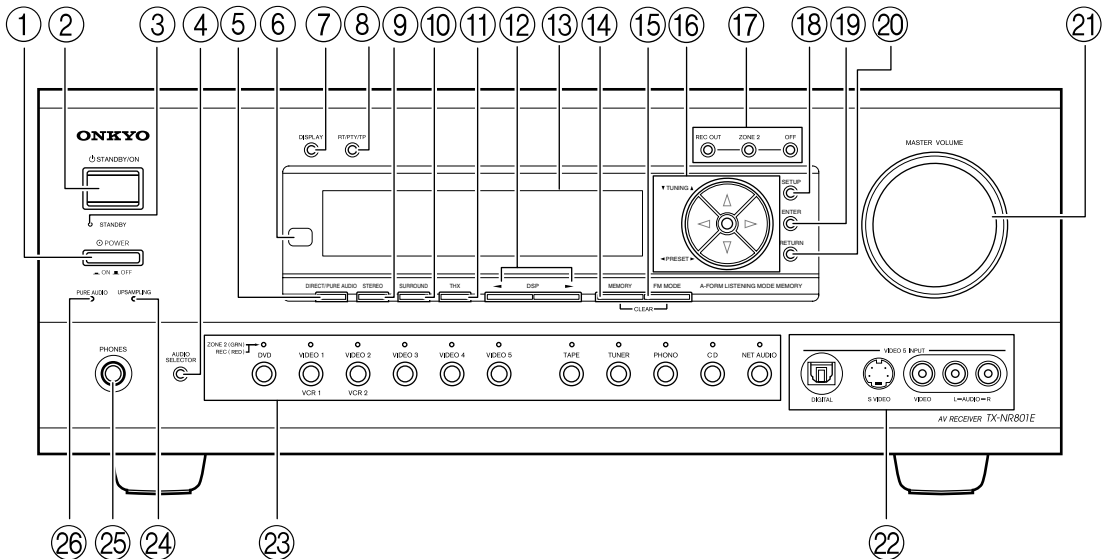

For further operational instructions, see the pages indicated in brackets [].

- ① **POWER switch (for all models other than USA, Canadian and Australian models) [27]**

Press to turn on and off the main power supply for the TX-NR801/TX-NR801E. When the TX-NR801/TX-NR801E is turned on with the POWER switch, the STANDBY indicator lights.

 - Before turning on the power, check to make sure that all cords are properly connected.
 - When the power is turned on, a sudden surge of current will occur that may adversely affect the operation of other devices. To prevent this, do not plug the TX-NR801/TX-NR801E into the same circuit used by sensitive equipment, e.g., computers.
- ② **STANDBY/ON button [27]**

If pressed with the POWER switch turned on (with the receiver plugged in for USA, Canadian and Australian models), the TX-NR801/TX-NR801E turns on and the display lights up. If pressed again, the TX-NR801/TX-NR801E returns to the standby state. In the standby state, the display is turned off and the TX-NR801/TX-NR801E cannot be operated.
- ③ **STANDBY indicator [7, 27]**

Lights when the TX-NR801/TX-NR801E is in the standby state and when a signal is received from the remote controller.
- ④ **AUDIO SELECTOR button [41, 65]**

Press to select the type of audio input signal.
- ⑤ **DIRECT/PURE AUDIO button [41, 39, 65]**

Press to switch between the direct and pure audio listening modes.
- ⑥ **Remote control sensor [7]**
- ⑦ **DISPLAY button [41]**

Press to display information about the current input source signal. Each time you press the DISPLAY button, the screen changes to show you different information concerning the input signal.
- ⑧ **DIMMER button (Other than European models) [40]**

Press to set the brightness of the front display. There are three settings available: normal, dark, and very dark. The brightness of the front display can also be changed using the remote controller.
- ⑧ **RT/PTY/TP button (European models only) [49]**

This button is only available on European models. Press this button to tune into the Radio Data System (RDS) for FM broadcasting. RDS was developed within the European Broadcasting Union (EBU) and is available in most European countries. Each time the button is pressed, the display changes from RT (radio text) to PTY (program type) to TP (traffic program) and then back to RT again.
- ⑨ **STEREO button [44]**

Selects for the stereo listening mode.
- ⑩ **SURROUND button [44]**

Selects for the Dolby Pro Logic II, DTS Neo:6, Dolby Digital, or DTS listening modes.
- ⑪ **THX button [44]**

Selects for the THX listening mode.
- ⑫ **DSP ◀/▶ buttons [44]**

Switches to the DSP (Digital Signal Processing) modes.
- ⑬ **Front display**
- ⑭ **MEMORY button [47]**

Press to assign the radio station to which you are currently tuned to a preset channel or press to delete a previously preset station.
- ⑮ **FM MODE button [46]**

Press to change the stereo mode from AUTO to MONO and vice versa. Each time this button is pressed, the AUTO indication turns on and off indicating the current mode. If you are listening to an FM radio station in stereo and the sound cuts out or there is a great deal of noise, switch from AUTO to MONO.
- ⑯ **TUNING ▼/▲, PRESET ◀/▶ buttons [46, 47, 49]**

To tune into a radio station, press the TUNING ▼/▲ buttons. The tuner frequency is displayed in the front display and it can be changed in 100-kHz (or 50-kHz) increments for FM and 10-kHz (or 9-kHz) increments for AM.

When FM is selected as the input source, you can hold down either the TUNING ▼ or ▲ button and then release it to activate the auto-search feature. It will search for a station in the direction of the button you pressed and stop when it tunes into one. When navigating through the menu settings, these buttons move the cursor up or down (or change the highlighted item). To select a radio station that was stored using the MEMORY button, press the PRESET ◀/▶ buttons. When navigating through the menu settings, these buttons select the value or item that you selected with the TUNING ▼/▲ buttons.

When you press the SETUP button, the TUNING and PRESET buttons become cursor buttons to be used for Setup Menu operations.
- ⑰ **REC OUT/ZONE 2/OFF buttons [50-51, 68]**

These buttons allow you to use the TX-NR801/TX-NR801E to output to a remote zone (Zone 2) or to another component for recording (Rec Out). Press the REC OUT button to output the audio and video signals to a recording component for recording. Press the ZONE 2 button to enjoy the output from the TX-NR801/TX-NR801E in a different room, which is referred to as the remote zone (Zone 2).

When either button is pressed, the currently selected input source for recording or outputting to the remote zone is displayed in the front panel display. If “SOURCE” is displayed, then the same input source as that selected for the main zone will be output.

To select an input source, press the desired button (REC OUT or ZONE 2) and then press one of the input source button within 8 seconds. That source will be output for recording or viewing in the remote zone. To set the output to the source channel, press the desired button (REC OUT or ZONE 2) twice in succession. To turn off the output, press the desired button (REC OUT or ZONE 2) and then press the OFF button within 8 seconds.

Note:

The Rec Out and Zone 2 buttons use the same circuit and therefore cannot be used at the same time. When REC OUT is selected, nothing is output to Zone 2. When ZONE 2 is selected, REC OUT is automatically fixed to SOURCE.

18 SETUP button [29]

Press to enter the Setup Menu. The OSD Menu will appear on the TV monitor as well as the front display on the TX-NR801/TX-NR801E.

19 ENTER button [29, 49]

Press to display the screen for the item that is selected in the Setup Menu.

20 RETURN button [29]

In the Setup Menu, press to go back one level. If pressed while at the Main Menu, you will exit the Setup Menu.

21 MASTER VOLUME dial [39, 65]

Use to control the volume in the main zone. The volume for the remote zone (Zone 2) is independent.

22 VIDEO 5 INPUT terminals [23]

For connecting a video camera or game device.

23 Input source buttons and indicators (DVD, VIDEO 1–5, TAPE, TUNER, PHONO, CD, and NET AUDIO) [35, 36, 39]

Press these buttons to select the input source for the main zone.

To select the input source for the remote zone (Zone 2) or recording out (REC OUT), first press the ZONE 2 or REC OUT button, and then press the desired input source button. The input channel with its indicator lit **red** is output to REC OUT and the one with its indicator lit **green** is output to ZONE 2.

24 UPSAMPLING indicator [55]

Lights during upsampling. This function is available when the input source is Analog/PCM and the listening mode is set to the stereo or surround mode.

25 PHONES jack [39]

This is a standard stereo jack for connecting stereo headphones.

26 PURE AUDIO indicator [44]

Lights during pure audio playback.

Front Panel Display

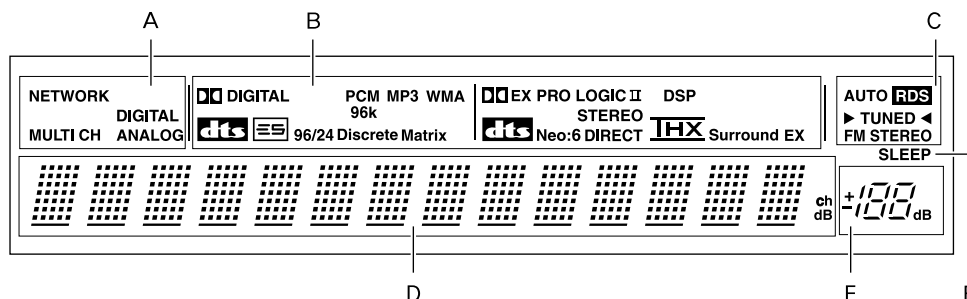

A Input signal path indicators

Shows from which terminal the input signal is coming.

B Listening mode or digital input format indicators

One of these indicators lights to show the format of the current input source. In addition, one of the listening mode indicators lights to indicate the current listening mode.

C Tuning indicators

AUTO indicator

Lights when receiving FM broadcasts in the stereo mode. Turns off when placed into the monaural mode.

RDS indicator (European models only)

Lights when an RDS station is being received.

TUNED indicator

Lights when a radio station is being received.

FM STEREO indicator

Lights when an FM broadcast station is being received in stereo. Turns off when placed into the monaural mode.

D Multi function display

During normal operation, shows the current input source and volume. When the FM or AM input is selected, shows the frequency and preset number. When the DISPLAY button is pressed, shows the listening mode and input source format. However, does not show the source format when the FM or AM source is selected.

E Volume display

Shows the volume level.

F SLEEP indicator

Lights when the sleep timer is turned on.

Rear Panel

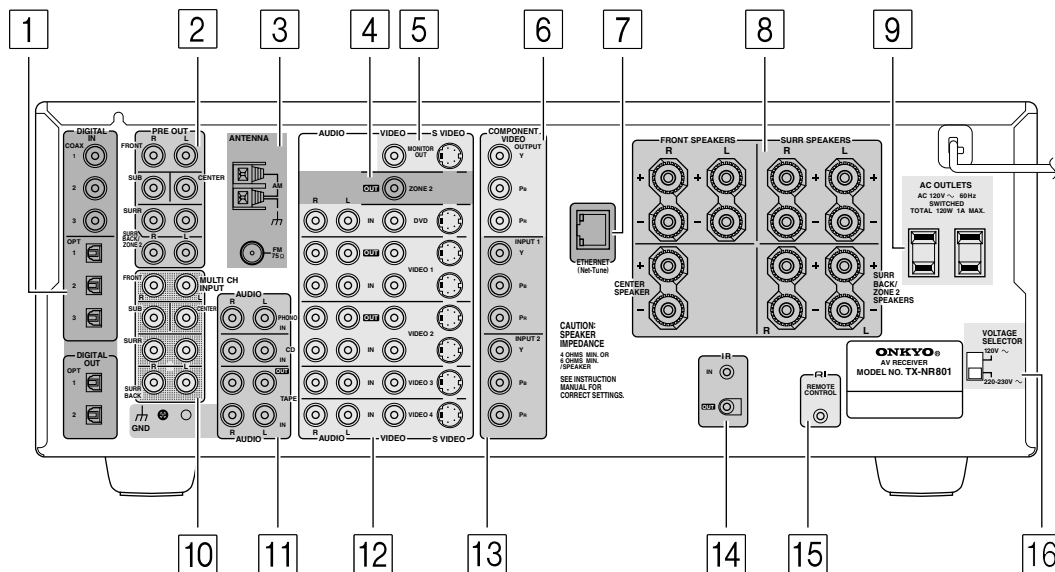

For more information regarding connection procedures, see pages indicated in brackets [].

1 DIGITAL IN/OUT [21-24]

These jacks are for connecting components with digital input and output capabilities. To connect a CD player, see page 23; to connect an MD or CD recorder, see page 24; to connect a DAT deck, see page 24; to connect a DVD player, see page 21; to connect a DVD recorder, see page 22; and to connect a digital satellite tuner, see page 22.

2 PRE OUT [18, 25, 66]

To use the TX-NR801/TX-NR801E as a preamplifier, connect a power amplifier to this jack.

3 ANTENNA [14]

These jacks are for connecting the FM indoor antenna and the AM loop antenna that are supplied with the TX-NR801/TX-NR801E.

4 ZONE 2 VIDEO OUT [21, 66]

This jack is for connecting the component that will be used in the remote zone (Zone 2).

5 MONITOR OUT VIDEO/S VIDEO [20]

These jacks are for connecting to the video input jacks on television monitors or projectors.

6 COMPONENT VIDEO OUTPUT [20]

These jacks are for connecting to the component video input jacks on television monitors or projectors.

7 ETHERNET (Net-Tune) [71]

This connector is for connecting to an Ethernet network.

8 SPEAKERS [18, 66]

These terminals are for connecting the speakers.

9 AC OUTLETS [24]

This AC outlet is provided to plug in the power cord from another component. The shape and number of the AC outlet depend on the shipping destination.

10 MULTI CH INPUT [64]

This connector is for connecting components with a multichannel output.

11 PHONO/CD/TAPE AUDIO IN/OUT [23, 24]

These connectors are for connecting to the audio input and output jacks on audio components. To connect a turntable, see page 24; to connect a CD player, see page 23; and to connect a cassette tape deck, MD recorder, or CD recorder, see page 24.

12 DVD/VIDEO1-4 IN/OUT [21, 22]

These connectors are for connecting to the video input and output jacks on video components. To connect a DVD player, see page 21; to connect a DVD recorder, see page 22; to connect a VCR, see page 21; and to connect a digital satellite tuner, see page 22.

13 COMPONENT VIDEO INPUT1/2 [21, 22]

These connectors are for connecting to the component video outputs of video components that have them. To connect a DVD player, see page 21; to connect a DVD recorder, see page 22; and to connect a digital satellite tuner, see page 22.

14 IR IN/OUT [69]

These connectors are for connecting the remote sensor of a multi-room kit (sold separately).

15 RI [26]

This jack is for connecting other Onkyo components equipped with the same RI terminal. The audio connection cables must also be connected.

16 VOLTAGE SELECTOR [7] (Worldwide models only)

This is only available on the worldwide model. Before connecting the power cord to the wall outlet, be sure to set this to the correct power supply voltage for your region.

Remote Controller

The RC-511M is a multi-functional remote controller. The instructions given here only explain how to use the remote controller in conjunction with the TX-NR801/TX-NR801E. To operate the TX-NR801/TX-NR801E using the remote controller, **first press the RCVR button in the MODE area** to place the remote controller in the receiver mode.

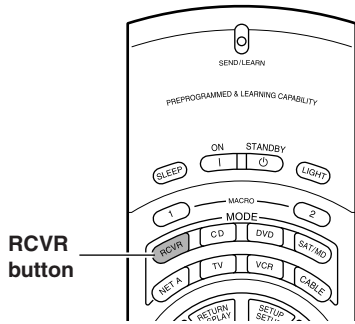

For the procedures below, see pages shown respectively.

- Using the remote controller with your other components (See pages 80-89).
- Enjoying Net Audio (See pages 76-79).

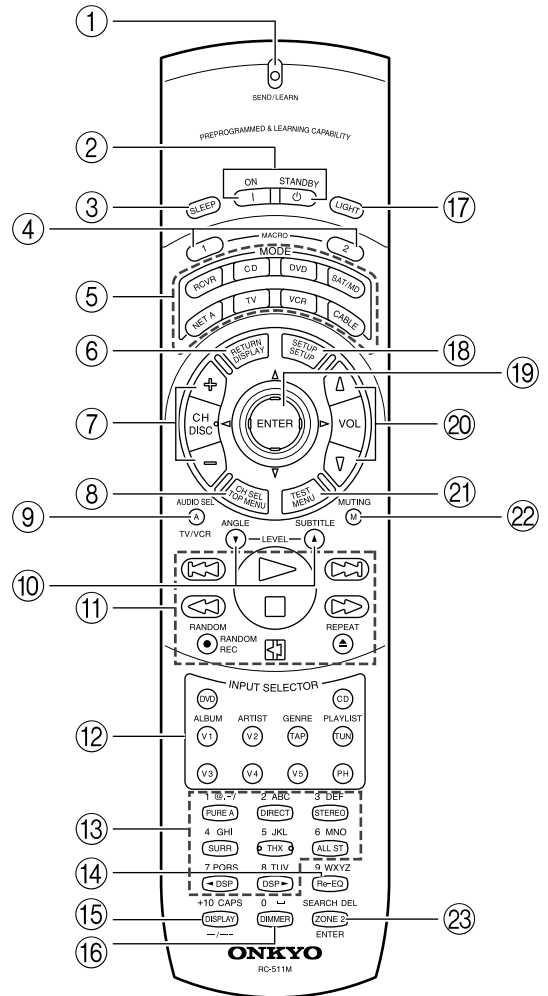

- ① **SEND/LEARN indicator [7]**

Lights red when signals are sent by the remote controller. It also flashes when a button is pressed and the battery power is low.
- ② **ON/STANDBY button [27, 68]**

ON: Press to turn on the TX-NR801/TX-NR801E.
STANDBY: Press to place the TX-NR801/TX-NR801E in the standby state.
Be aware that pressing the STANDBY button only places the TX-NR801/TX-NR801E in standby and does not turn the power off completely.
- ③ **SLEEP button [40]**

Press to set the sleep function.
The SLEEP button enables you to set the TX-NR801/TX-NR801E to turn off automatically after a specified time period.
- ④ **MACRO 1, 2 button [86, 88, 89]**

Press to program or execute the macro function.
- ⑤ **MODE buttons and indicators [80-88]**

Press to select the component to be operated by the remote controller. When a MODE button is pressed, it will light for 8 seconds. The selected MODE button will also light whenever any other operation button is pressed.
- ⑥ **RETURN button [29]**

Press to enter the selected setting and return to the previous menu.
- ⑦ **CH \leftrightarrow button [46]**

Press to select a preset channel for the tuner.
- ⑧ **CH SEL button [35, 40, 65]**

Press to select a speaker channel when adjusting the speaker level.
- ⑨ **AUDIO SEL button [41, 65]**

Press to select the audio input signal.
- ⑩ **LEVEL ∇/\blacktriangle buttons [35, 40, 65]**

Press to adjust the volume of the speaker selected using the CH SEL button.
- ⑪ **Operation buttons [80-81, 85]**

Press to operate other devices connected to the TX-NR801/TX-NR801E.
- ⑫ **INPUT SELECTOR buttons [36, 39, 44, 52, 56, 65, 68]**

Press to select an input source.
Same as the input selector buttons on the front panel of the TX-NR801/TX-NR801E. The input source for each button is given here. DVD:DVD, CD:CD, V1:VIDEO1, V2:VIDEO2, V3:VIDEO3, V4:VIDEO4, V5:VIDEO5, TAP:TAPE, TUN:FM/AM, PH:PHONO.
- ⑬ **Listening mode buttons [44, 65]**

Press to select a listening mode.
- ⑭ **Re-EQ button [55, 61]**

Depending on the listening mode, you can turn the Re-EQ function on or off.
- ⑮ **DISPLAY button [41]**

For changing the front display.
- ⑯ **DIMMER button [40]**

Adjusts the display brightness.
There are three settings available: normal, dark, and very dark.
- ⑰ **LIGHT button**

Press to turn on and off the lights in the buttons of the remote controller.
- ⑱ **SETUP button [29]**

Press to display the Setup Menu on the TV screen and in the display. Press again to exit the menu.
- ⑲ **$\blacktriangleleft/\blacktriangleright/\blacktriangle/\blacktriangledown$, ENTER button [29]**

When in the Setup Menu, press the upper and lower arrow buttons to select an item, press the right and left arrow buttons to select parameter values or modes, and press the ENTER button to advance to the next item.
- ⑳ **VOL Δ/∇ button [39, 65]**

Press to adjust the volume.
- ㉑ **TEST button [35]**

This button is used to set the speaker output levels. Use this button in conjunction with the LEVEL ∇/\blacktriangle and CH SEL buttons to calibrate the speaker levels without entering the Setup Menu.
- ㉒ **MUTING button [39]**

Press to activate the mute function.
- ㉓ **ZONE 2 button [68]**

Press to perform operations in the remote zone.

Connecting Antenna

This chapter explains how to connect the supplied indoor FM antenna and AM loop antenna, and how to connect commercially available outdoor FM and AM antennas.

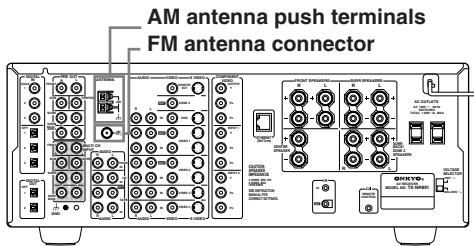

Connecting the Indoor FM Antenna

The supplied indoor FM antenna is for indoor use only.

1 Attach the FM antenna, as shown.

■ USA and Canadian Model

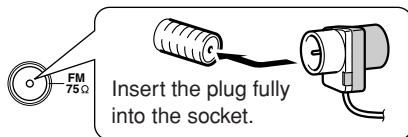

■ Other Models

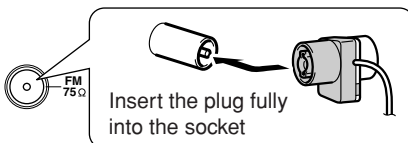

Once your TX-NR801/TX-NR801E is ready for use, you'll need to tune into an FM radio station and adjust the position of the FM antenna to achieve the best possible reception.

2 Use thumbtacks or something similar to fix the FM antenna into position.

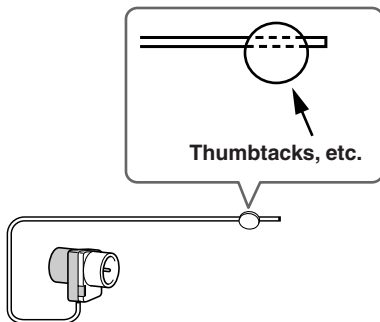

Caution: Be careful that you don't injure yourself when using thumbtacks.

If you cannot achieve good reception with the supplied indoor FM antenna, try using a commercially available outdoor FM antenna instead (See page 15).

Connecting the AM Loop Antenna

The supplied indoor AM loop antenna is for indoor use only.

1 Assemble the AM loop antenna, inserting the tabs into the base, as shown.

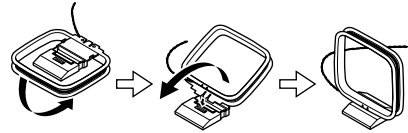

2 Connect both wires of the AM loop antenna to the AM push terminals, as shown.

(The antenna's wires are not polarity sensitive, so they can be connected in either terminal.)

Make sure that the wires are attached securely and that the push terminals are gripping the bare wires, not the insulation.

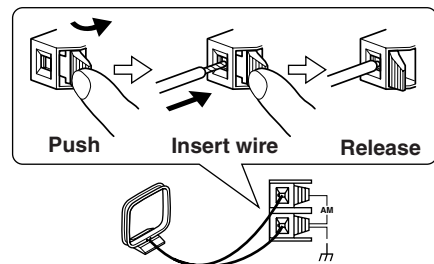

Once your TX-NR801/TX-NR801E is ready for use, you'll need to tune into an AM radio station and adjust the position of the AM antenna to achieve the best possible reception. Keep the antenna as far away as possible from your TX-NR801/TX-NR801E, TV, speaker cables, and power cords.

If you cannot achieve good reception with the supplied indoor AM loop antenna, try using a commercially available outdoor AM antenna (See page 15).

Connecting Antenna—Continued

Connecting an Outdoor FM Antenna

If you cannot achieve good reception with the supplied indoor FM antenna, try using a commercially available outdoor FM antenna instead.

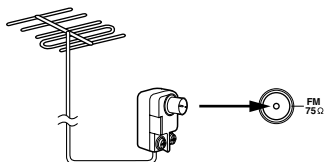

Notes:

- Outdoor FM antennas work best outside, but usable results can sometimes be obtained when installed in an attic or loft.
- For best results, install the outdoor FM antenna well away from tall buildings, preferably with a clear line of sight to your local FM transmitter.
- Outdoor antennas should be located away from possible noise sources, such as neon signs, busy roads, etc.
- For safety reasons, outdoor antennas should be situated well away from power lines and other high-voltage equipment.
- Outdoor antennas must be grounded in accordance with local regulations to prevent electric shock hazards.

Using the 75/300 ohm Antenna Adapter

The 75/300 ohm Antenna Adapter is not supplied with USA, Canadian and European models. The 75/300 ohm antenna adapter can be used to connect an FM antenna using either 75 ohm coaxial cable or 300 ohm twin-core flat cable.

Connecting 300 ohm Flat Cable

- 1 Using a screwdriver, loosen the two screws on the adapter, wrap the bare wires around the screws, and then retighten them, as shown.

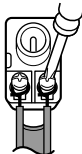

- 2 Plug the adapter into the 75 Ω socket.

Connecting 75 ohm Coaxial Cable

- 1 Strip and prepare the 75 ohm coaxial cable, as shown.

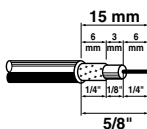

- 2 Using your fingernails or a small screwdriver, lever the adapter's tabs outward and remove the cover, as shown.

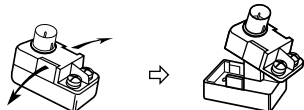

- 3 Move the small wire inside the adapter from position A to position B, as shown.

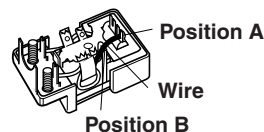

- 4 Insert the central conductor (1), as shown, and use a small pair of pliers to clamp the shielding and outer insulation sections of the cable (2), as shown.

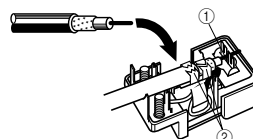

Make sure the shielding is not touching the central conductor.

- 5 Refit the adapter's cover, and then plug the adapter into the 75 Ω socket.

Using a TV/FM Antenna Splitter

It's best not to use the same antenna for both FM and TV reception, as this can cause interference problems. If circumstances demand it, use a TV/FM antenna splitter, as shown.

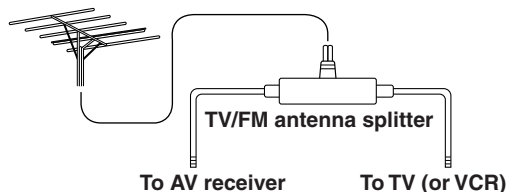

Connecting an Outdoor AM Antenna

If good reception cannot be achieved using the supplied AM loop antenna, an outdoor AM antenna can be used in addition to the loop antenna, as shown.

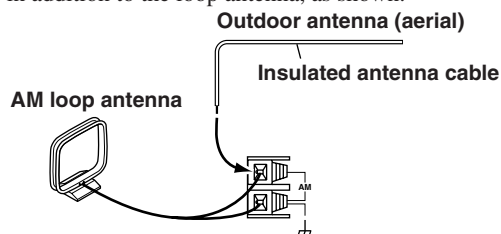

Outdoor AM antennas work best when installed outside horizontally, but good results can sometimes be obtained indoors by mounting horizontally above a window. Note that the AM loop antenna should be left connected. Outdoor antennas must be grounded in accordance with local regulations to prevent electric shock hazards.

About Home Theater

Enjoying Home Theater

The TX-NR801/TX-NR801E has many excellent features to recreate a clear three-dimensional sound image and lively sound movement. This enables you to easily enjoy rich sound effects just like you were in a theater or concert hall at home. For the TX-NR801/TX-NR801E, Onkyo recommends you to use the THX-certified THX speaker system for THX Surround EX playback.

When playing a DVD, you can enjoy sound effects provided by DTS, Dolby Digital or THX, depending on recording formats. In addition, you can enjoy Integra's proprietary DSP surround playback for TV or digital satellite broadcasts.

How to use speakers

When you have **two speakers**, they are used for front left and right speakers (2 channel playback).

When you have **three speakers**, they are used for front left, front right and center speakers (3 channel surround playback).

When you have **four speakers**, they are used for front left, front right, surround left, and surround right speakers (4 channel surround playback).

When you have **five speakers**, they are used for front left, front right, center, surround left and surround right speakers (5 channel surround playback).

When you have **six speakers**, they are used for front left, front right, center, surround left, surround right and surround back speakers (6 channel surround playback).

When you have **seven speakers**, they are used for front left, front right, center, surround left, surround right, surround back left, and surround back right speakers (7 channel surround playback).

No matter how many speakers you use, a subwoofer can be used to produce powerful and heavy bass sound (0.1 channel playback).

Front left and right speakers

Output overall sound. They play the most important role in a home theater system, by creating basic sound images and fields.

Place the front speakers in front of the listener so that they point to the listener's ears in the listening position for music and movies. Ideal speaker placement is so that they are located symmetrically.

Center speaker

Complements the sound effects from front left and right speakers to enrich and clear the sound image and movement. In movies, an actor's speech comes mainly from the center speaker.

Place the center speaker as close as possible to the TV or monitor, pointing it towards the listener's ears. Also, keep the center speaker's height at the same level as the front left and right speakers.

Subwoofer

Outputs only bass sounds to enhance and complement bass sound effects. Place the subwoofer either at the front corner of the room or at a position 1/3 from either front corner of the room.

Surround back speakers

Enhance the sound space representation with surround channel signals. Recreating sound movement effects and sound fields behind the listener gives a more realistic experience.

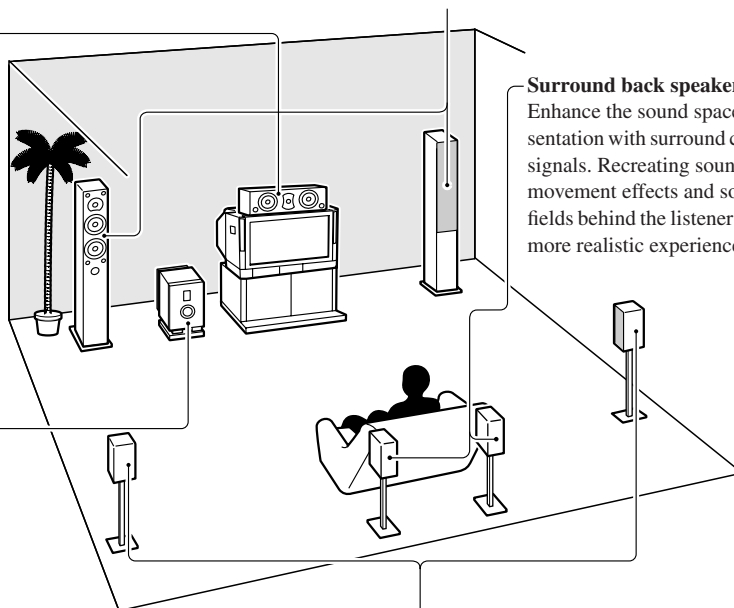

Surround left and right speakers

Enhance the sensation of being at a live performance by giving three-dimensional sound movement to the sound effects. Place the surround speakers at the side of the listener or at a position diagonally from the listener. Ideally, speakers should be placed symmetrically.

- For optimum surround playback, set the distance between the listener and the speakers so that the time it takes the sound to reach the listener is constant. Also, you need to set each speaker volume level individually in order to balance the volume level between speakers (See pages 33 and 35).

Speaker Placement

Before connecting the speakers, it is very important to place them properly to create the optimum sound space for your listening pleasure. During placement and connection, be sure to refer to the manuals and instructions that came with the speakers. Furthermore, be aware that for surround playback, the configuration and placement of your speakers are both very important. Ideal speaker placement varies depending on the size of your room and the wall coverings. Here, only typical examples of speaker placement and recommendations are shown.

In order to create the optimum conditions for the best sound quality, be sure to place all the speakers so that the greatest difference between the distances of each speaker to the listening position is less than 20 feet (6 meters).

Important Points Regarding Speaker Placement

Front left and right speakers and center speaker

- Place these three speakers all at the same height.
- Place each speaker so that it is aimed at the location of the listener's ears when at the listening position.
- Place the right and left speakers at equal distances on either side of the listening point.

Surround left and right speakers

- Place these speakers so that their height is 3 feet (1 meter) higher than that of the listener's ears.

Subwoofer

When bass sound is reproduced, its volume and quality greatly depend on subwoofer placement. Those characteristics also depend on the shape of your listening room as well as your listening point. Generally, good bass sound is obtained when the subwoofer is placed in the corner of the room or at a point $\frac{1}{3}$ the length of the room.

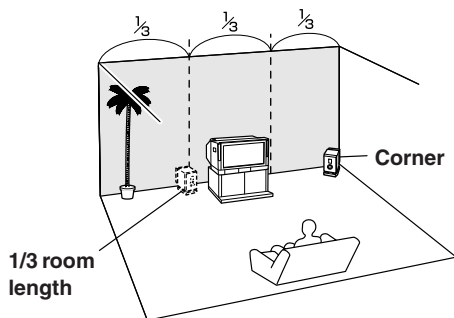

To optimize the subwoofer placement, we recommend:

- Playing a movie or music source containing good quality bass sound,
- Experimenting while changing subwoofer's position in the room, and
- Repositioning the subwoofer until you obtain the most out of the bass sound while fixing the listening point.

Surround back speakers

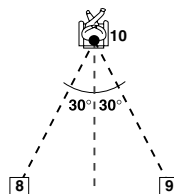

- Place these speakers so that their height is 3 feet (1 meter) higher than that of the listener's ears.
- When using surround back left and right speakers, place them behind the listener so that the angles between the lines from each speaker to the listener and a line straight back from the listener are about 30 degrees.

Layout with dipolar speakers

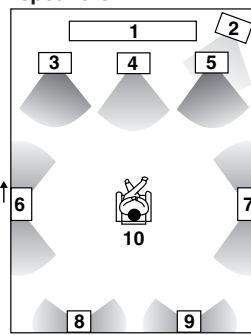

Layout with monopolar speakers

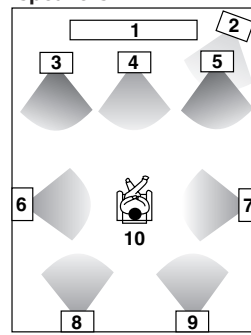

- 1 TV or screen
- 2 Subwoofer
- 3 Front left speaker
- 4 Center speaker
- 5 Front right speaker
- 6 Surround left speaker
- 7 Surround right speaker

- 8 Surround back left speaker
- 9 Surround back right speaker
- 10 Listening position

Most dipoles are marked with an arrow to indicate how they should be oriented in the room. For correct acoustical phasing in the room, dipolar surround speakers should be placed so that their arrows point forward toward the screen; and dipolar surround back speakers should be placed so that their arrows point toward each other.

Connecting Speakers

After determining the layout of your speaker system, it is now necessary to connect the speakers correctly to your TX-NR801/TX-NR801E.

For the USA and Canadian models, you can also use banana plugs/connectors.

Caution:

Connect only speakers with an impedance between 4 and 16 Ω to the TX-NR801/TX-NR801E. If the impedance of even one speaker is between 4 and 6 Ω , be sure to set the speaker impedance setting accordingly (See page 30).

Notes:

- Even if you are using only one speaker or listening to monaural (mono) sound, never connect a single speaker in parallel to both the right and left-channel terminals.

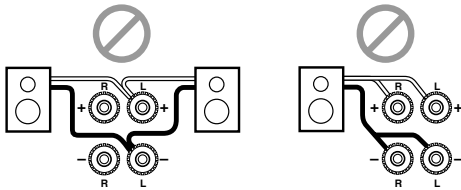

- To prevent damage to circuitry, never short-circuit the positive (+) and negative (-) speaker wire.
- Be sure to connect the positive and negative cables for the speakers properly. If they are mixed up, the left and right signals will be reversed and the audio will sound unnatural.

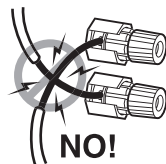

- Do not connect more than one speaker cable to one speaker terminal. Doing so may damage the TX-NR801/TX-NR801E.
- Connect either your surround back speakers or the speakers you will be using in the remote zone (Zone 2) to the SURR BACK/ZONE 2 SPEAKERS terminals (See page 66).

Using the Speaker Cable Labels

The positive speaker terminals on the TX-NR801/TX-NR801E are color coded for easy identification. Attach the supplied speaker labels to the speaker cables, and then match the colors on the speaker cables to the corresponding terminals.

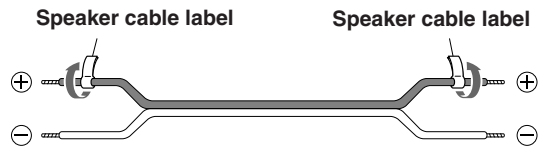

TX-NR801/TX-NR801E

The speaker channels are colored as follows:

- Front left speaker (+): White
- Front right speaker (+): Red
- Center speaker (+): Green
- Surround left speaker (+): Blue
- Surround right speaker (+): Grey
- Surround back/Zone 2 left speaker (+): Brown
- Surround back/Zone 2 right speaker (+): Tan

Use the PRE OUT SUBWOOFER jack to connect a subwoofer with a built-in power amplifier. If your subwoofer does not have a built-in amplifier, connect an amplifier to the PRE OUT SUBWOOFER jack and the subwoofer to the amplifier.

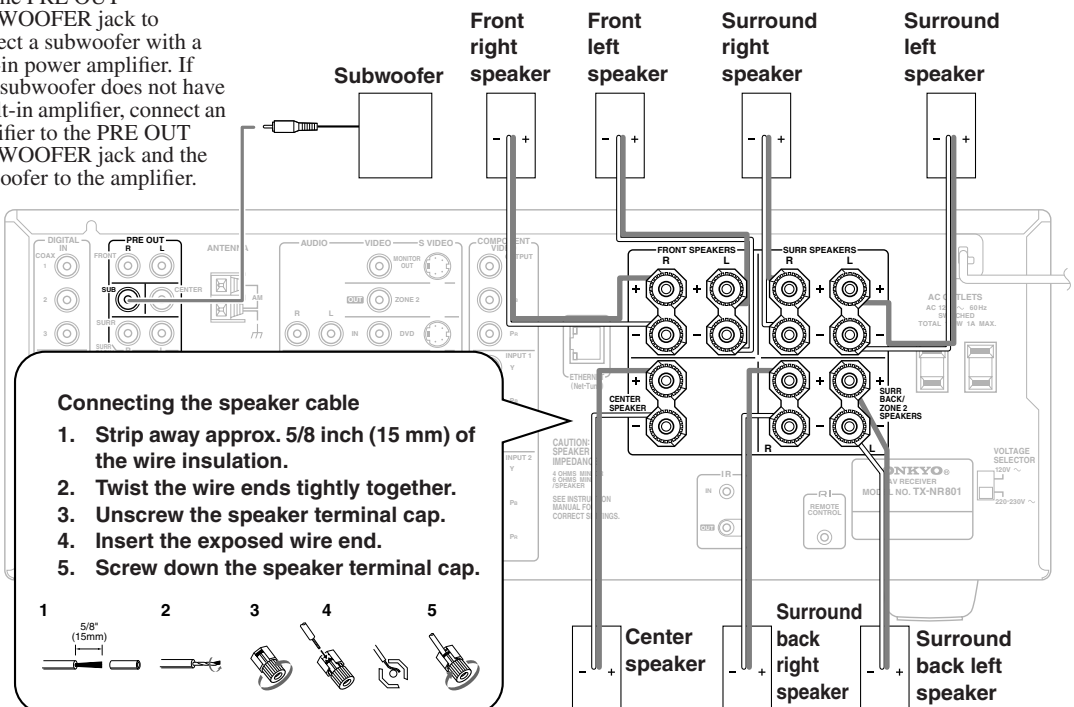

AV Cables and Connectors

- Always refer to the instructions that came with the component that you are connecting.
- Do not plug in the power cord until all connections have been properly made.
- For input jacks, red connectors (marked R) are used for the right channel, white connectors (marked L) are used for the left channel, and yellow connectors (marked V) are used for video connection.
- The optical digital jacks are all of shutter-type construction. Connect an optical cable by first making sure the cable is oriented correctly and then inserting it into the jack by pushing the shutter lid inwards.

- Insert all plugs and connectors securely. Improper connections can result in noise, poor performance, or damage to the equipment.

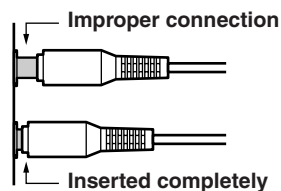

- Do not bind audio/video connection cables with power cords and speaker cables. Doing so may adversely affect the picture and sound quality.

Rear optical jack

Front optical jack



Cables are depicted in the connection diagrams as shown below.

Types of video connection cables and terminals			
Cable names	Cable forms	Terminal shapes	Description
Component video connection cable		 Y P _B P _R	Component video separates the luminance (Y) and color difference signals (P _R , P _B), providing the best picture quality. Some TV manufacturers label their component video inputs differently.
S video connection cable		 S VIDEO	The video quality is higher than the one using the composite video connection. The video component control signals such as aspect ratio signal cannot be sent through this connection.
Video connection cable		 VIDEO	This is the standard video connection method and most of the video components like TV and VCR are equipped with the terminals of this type.

Types of audio connection cables and terminals			
Cable names	Cable forms	Terminal shapes	Description
Optical cable		 OPT	You can enjoy various type of digital sound including Dolby Digital format sound. The sound quality is equal to the one available through the coaxial cable connection.
Coaxial cable		 COAX	You can enjoy various type of digital sound including Dolby Digital format sound. The sound quality is equal to the one available through the optical cable connection.
Audio connection cable		 AUDIO R L	This connection carries analog audio signals.
Multichannel connection cable		 FRONT SUB SURR SURR BACK MULTI CH INPUT R L CENTER	These types of terminals will be found on DVD players that support DVD-Audio format.

Connecting to Audio/Video Equipment

Here is an explanation of typical ways to connect various components to the TX-NR801/TX-NR801E. There are many ways that any one component can be connected, and it is up to you to decide which method best fits your situation. The directions given here are only one option and should only be thought of as such. It is best to fully understand the nature of each connector and terminal as well as those of your components and their features to ascertain which method of connection is best.

COMPONENT VIDEO INPUT/OUTPUT

For DVD players or other devices that have component video connectors, the TX-NR801/TX-NR801E has two banks of component video input connectors (Y, PB, PR) for direct component video input. The TX-NR801/TX-NR801E also has one bank of component video output connectors for direct component video output to the matrix decoder of a television, projector, or other display device. By sending the pure component video signal directly, the signal forgoes the extra processing that normally would degrade the image. The result is vastly increased image quality, with incredibly lifelike colors and crisp details.

VIDEO IN/OUT

These are the video inputs and outputs. On the rear panel, there are five video inputs and two video outputs and each one includes both composite video and S video configurations.

Connect VCRs, VTRs, LD players, DVD players, and other video components to the video inputs. Connect VCRs, VTRs, and other recording components to the video outputs to make video recordings.

- When connecting a VCR or other video component, make sure you connect its audio and video leads to the same bank (e.g., both to VIDEO 3).
- The VIDEO 5 inputs are located on the front panel.

The flow of the video signals is as follows:

Signals that come in from COMPONENT VIDEO INPUT are only output to COMPONENT VIDEO OUTPUT.

When connecting a video player to the COMPONENT VIDEO INPUT jacks, be sure to connect your television to the COMPONENT VIDEO OUTPUT jacks.

For USA, Canadian and Australian models:

Signals that come in from VIDEO and S VIDEO IN are output to VIDEO and S VIDEO. Those signals are not output to COMPONENT VIDEO OUTPUT. A projector or monitor TV should be connected to VIDEO and S VIDEO IN.

For other models whose TV Format is PAL:

Signals that come in from VIDEO and S VIDEO IN are output to VIDEO, S VIDEO and COMPONENT VIDEO. When you connect a projector or monitor TV to COMPONENT VIDEO inputs, you do not have to connect them to VIDEO and S VIDEO inputs.

AUDIO IN/OUT

These are the analog audio inputs and outputs. There are eight audio inputs and three audio outputs on the rear panel. The audio inputs and outputs require RCA-type connectors.

DIGITAL IN/OUT

On the rear panel of the TX-NR801/TX-NR801E, there are three coaxial digital inputs, three optical digital inputs, and two optical digital outputs. To the digital inputs, connect CD players, LD players, DVD players, or other digital source components. To the digital output, connect MD recorders, CD recorders, DAT decks, or other similar components.

- Since an analog connection must be made when using REC OUT or ZONE 2, make sure that the connection to the input source is not digital only, but analog as well.
- When using an optical input or output jack, always use an optical fiber cable.

Connecting a Television Monitor or Projector (MONITOR OUT)

The TX-NR801/TX-NR801E is equipped with a simple Y/C separate circuit and simple Y/C mixed circuit. Since both the signals from the S VIDEO and VIDEO inputs are output to the MONITOR OUT S VIDEO output, if the television or projector is equipped with an S video input, it is unnecessary to connect the video connectors. If it is equipped with only a video input, connect it to the MONITOR OUT VIDEO output.

Using an RCA video connection cable, connect the video input jack (composite) of the device to the MONITOR OUT VIDEO jack of the TX-NR801/TX-NR801E. Or if the device has an S video input jack, connect it to the MONITOR OUT S VIDEO jack of the TX-NR801/TX-NR801E using an S video connection cable. Or if the device has component video inputs, connect them to the bank of COMPONENT VIDEO OUTPUT jacks on the TX-NR801/TX-NR801E. If a model is for other than USA, Canada or Australia and its TV Format is PAL, when you use the connections described above, video signals that come in from S VIDEO and VIDEO IN are output to the TV, projector, etc.

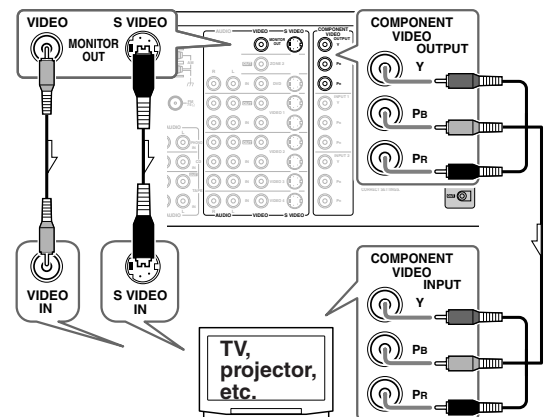

For USA, Canadian and Australian models:

Note that the OSD Menu data will be output to the MONITOR OUT VIDEO and S VIDEO jacks, and will not output to the COMPONENT VIDEO OUTPUT jack.

Connecting to Audio/Video Equipment—Continued

For other models:

Note that the OSD Menu data will be output to the MONITOR OUT VIDEO, S VIDEO and COMPONENT VIDEO jacks. When you connect any OSD-specific monitor TV to the VIDEO connectors, you can disable the OSD output to COMPONENT VIDEO OUTPUT. To disable the OSD output, select Setup Menu → Preference → OSD Setup → Component Video, and then select “OSD Off” (See page 63).

Connecting a DVD Player (DVD)

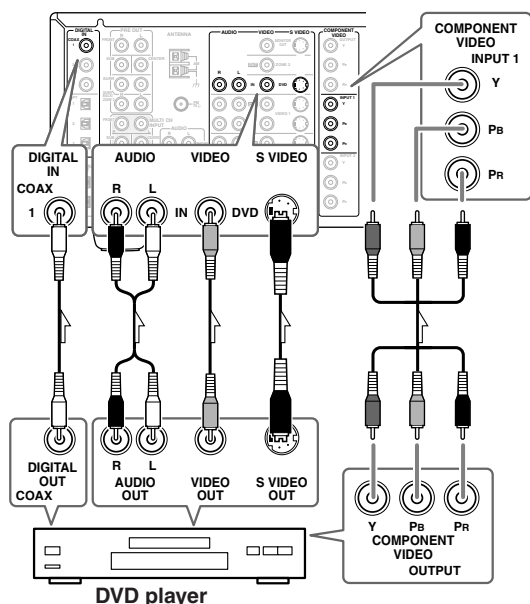

Using an RCA video connection cable, connect the video output jack (composite) of the DVD or LD player to the DVD VIDEO IN jack of the TX-NR801/TX-NR801E. Or if the DVD or LD player has an S video output jack, connect it to the DVD S VIDEO IN jack with an S video connection cable. Or if the device has component video outputs, connect them to one of the banks of COMPONENT VIDEO INPUT jacks on the TX-NR801/TX-NR801E.

On the initial settings of the TX-NR801/TX-NR801E, the DVD input source is set for the COMPONENT VIDEO INPUT 1 jacks.

If you connect the DVD or LD player to the COMPONENT VIDEO INPUT 2 jacks, this must be changed at Setup Menu → Input Setup → Video Setup → Component Video (See page 38).

Using an RCA audio connection cable, connect the audio output jacks of the DVD or LD player to the DVD AUDIO IN jacks of the TX-NR801/TX-NR801E. Make sure that you properly connect the left channel to the L jack and the right channel to the R jack.

If the device has a digital output, connect it to either the DIGITAL IN COAX jack or DIGITAL IN OPT jack of the TX-NR801/TX-NR801E, depending on the type of connector on the DVD player.

On the initial settings of the TX-NR801/TX-NR801E, the DVD input source is set for digital input at the COAX 1 jack.

If the digital connection is made at a different jack, this must be changed at Setup Menu → Input Setup → Digital Setup (See page 36).

Make sure of your DVD player's digital output settings. You need to access the On Screen Menu of your DVD player. See the owner's Manual on your DVD player.

Also, you need to be aware of the Table of contents for the movie, selecting the movie for Dolby Digital or DTS, depends how the movie is encoded.

Connecting a Video Cassette Recorder (VIDEO 1)

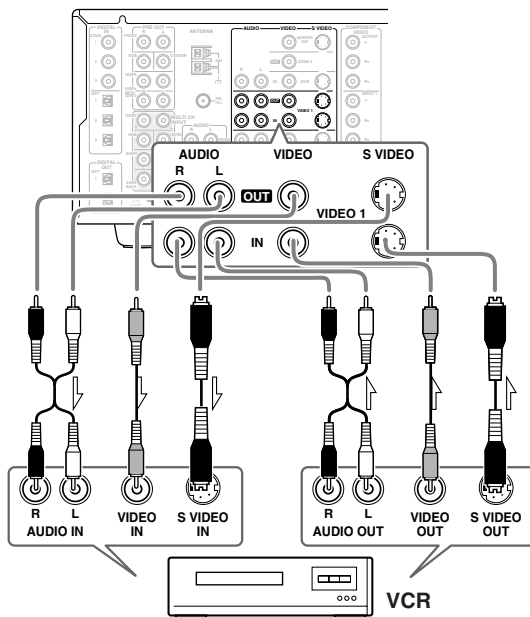

Using RCA video connection cables, connect the video output jack (composite) of the video cassette recorder to the VIDEO 1 VIDEO IN jack of the TX-NR801/TX-NR801E and connect the video input jack of the video cassette recorder to the VIDEO 1 VIDEO OUT jack of the TX-NR801/TX-NR801E. Or if the video cassette recorder has S video input and output jacks, connect them to the VIDEO 1 S VIDEO IN and OUT jacks of the TX-NR801/TX-NR801E using S video connection cables. Or if the video cassette recorder has component video outputs, connect them to one of the banks of COMPONENT VIDEO INPUT jacks on the TX-NR801/TX-NR801E.

On the initial settings of the TX-NR801/TX-NR801E, the VIDEO 1 input source is set for the COMPONENT VIDEO INPUT 2 jacks.

If you connect the video cassette recorder to the COMPONENT VIDEO INPUT 1 jacks, this must be changed at Setup Menu → Input Setup → Video Setup → Component Video (See page 38).

Using RCA audio connection cables, connect the audio output jacks of the video cassette recorder to the VIDEO 1 AUDIO IN jacks of the TX-NR801/TX-NR801E and connect the audio input jacks of the video cassette recorder to the VIDEO 1 AUDIO OUT jacks of the TX-NR801/TX-NR801E. Make sure that you properly connect the left channels to the L jacks and the right channels to the R jacks.

Connecting to Audio/Video Equipment—Continued

If you are connecting a digital output device to the VIDEO 1 jack instead of a VCR, connect it to either the DIGITAL IN COAX jack or DIGITAL IN OPT jack, depending on the type of connector on the device.

On the initial settings of the TX-NR801/TX-NR801E, the VIDEO 1 input source is set for digital input at the COAX 2 jack.

If the digital connection is made at a different jack, this must be changed at Setup Menu → Input Setup → Digital Setup (See page 36).

Connecting a DVD Recorder or Other Digital Video Recording Device (VIDEO 2)

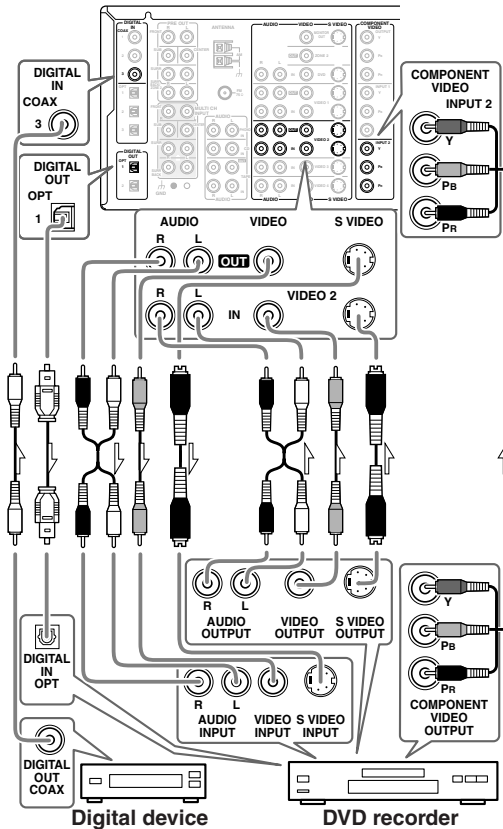

Using RCA video connection cables, connect the video output jack (composite) of the device to the VIDEO 2 VIDEO IN jack of the TX-NR801/TX-NR801E and connect the video input jack of the device to the VIDEO 2 VIDEO OUT jack of the TX-NR801/TX-NR801E. Or if the device has S video input and output jacks, connect them to the VIDEO 2 S VIDEO IN and OUT jacks of the TX-NR801/TX-NR801E using S video connection cables. Or if the device has component video outputs, connect them to one of the banks of COMPONENT VIDEO INPUT jacks on the TX-NR801/TX-NR801E.

On the initial settings of the TX-NR801/TX-NR801E, the VIDEO 2 input source is set for the COMPONENT VIDEO INPUT 2 jacks.

If you connect the device to the COMPONENT VIDEO INPUT 1 jacks, this must be changed at Setup Menu →

Input Setup → Video Setup → Component Video (See page 38).

Using RCA audio connection cables, connect the audio output jacks of the device to the VIDEO 2 AUDIO IN jacks of the TX-NR801/TX-NR801E and connect the audio input jacks of the device to the VIDEO 2 AUDIO OUT jacks of the TX-NR801/TX-NR801E. Make sure that you properly connect the left channels to the L jacks and the right channels to the R jacks.

If the device has a digital output, connect it to either the DIGITAL IN COAX jack or DIGITAL IN OPT jack of the TX-NR801/TX-NR801E, depending on the type of connector on the device.

On the initial settings of the TX-NR801/TX-NR801E, the VIDEO 2 input source is set for digital input at the COAX 3 jack.

If the digital connection is made at a different jack, this must be changed at Setup Menu → Input Setup → Digital Setup (See page 36).

If the device has a digital input, connect it to the DIGITAL OUT OPT jack of the TX-NR801/TX-NR801E for digital recording of the REC OUT signal from the TX-NR801/TX-NR801E.

However, if the same device also has a digital output and it has already been connected to the TX-NR801/TX-NR801E, you cannot connect the digital input of the device to the DIGITAL OUT jack of the TX-NR801/TX-NR801E simultaneously.

Note:

The output from the DIGITAL OUT jack of the TX-NR801/TX-NR801E is only the digital signal input to the DIGITAL IN jack.

Connecting a Satellite Tuner, Television, or Settop Box (VIDEO 3 or 4)

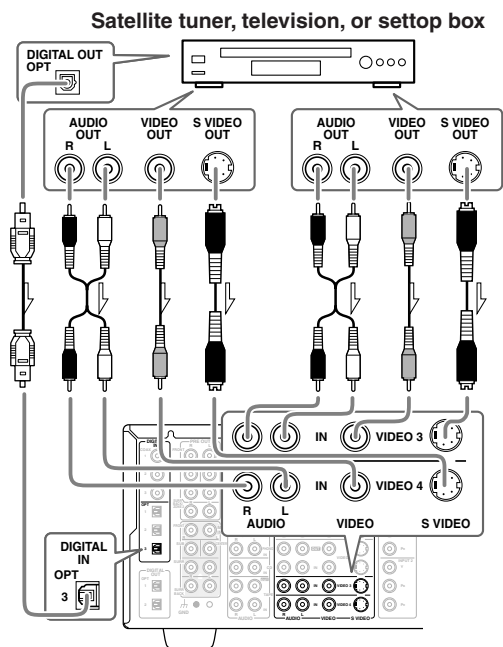

Using an RCA video connection cable, connect the video output jack (composite) of the device to the VIDEO 3 (or 4) VIDEO IN jack of the TX-NR801/TX-NR801E. Or if the device has an S video output jack, connect it to the VIDEO 3 (or 4) S VIDEO IN jack of the TX-NR801/TX-NR801E using an S video connection cable. Or if the device has component video outputs, connect them to one of the banks of COMPONENT VIDEO INPUT jacks on the TX-NR801/TX-NR801E.

On the initial settings of the TX-NR801/TX-NR801E, the VIDEO 3 and 4 input sources are set for the COMPONENT VIDEO INPUT 2 jacks.

If you connect the device to the COMPONENT VIDEO INPUT 1 jacks, this must be changed at Setup Menu → Input Setup → Video Setup → Component Video (See page 38).

Using an RCA audio connection cable, connect the audio output jack of the device to the VIDEO 3 (or 4) AUDIO IN jacks of the TX-NR801/TX-NR801E. Make sure that you properly connect the left channel to the L jack and the right channel to the R jack.

When hooking up a TV with audio outputs, make sure the TV's audio output setting. You might have to go through the TV's menu and set the TV Fixed audio output and then internal speakers off.

If the device has a digital output, connect it to either the DIGITAL IN COAX jack or DIGITAL IN OPT jack of the TX-NR801/TX-NR801E, depending on the type of connector on the device.

On the initial settings of the TX-NR801/TX-NR801E, the VIDEO 3 input source is set for digital input at the OPT 3 jack.

If the digital connection is made at a different jack, this must be changed at Setup Menu → Input Setup → Digital Setup (See page 36).

On the initial settings of the TX-NR801/TX-NR801E, the VIDEO 4 input source is not set for digital input. If you are connecting a digital component, these settings must be changed at Setup Menu → Input Setup → Digital Setup (See page 36).

Connecting Video Camera, etc. (VIDEO 5 INPUT)

Using an RCA video connection cable, connect the video output jack (composite) of the device to the VIDEO 5 VIDEO jack of the TX-NR801/TX-NR801E. Or if the device has an S video output jack, connect it to the VIDEO 5 S VIDEO jack of the TX-NR801/TX-NR801E using an S video connection cable.

Using an RCA audio connection cable, connect the audio output jack of the device to the VIDEO 5 AUDIO jacks of the TX-NR801/TX-NR801E. Make sure that you properly connect the left channel to the L jack and the right channel to the R jack.

If the device has an optical digital output, connect it to the VIDEO 5 DIGITAL jack of the TX-NR801/TX-NR801E.

The VIDEO 5 digital input is fixed to the OPTICAL input on the front panel.

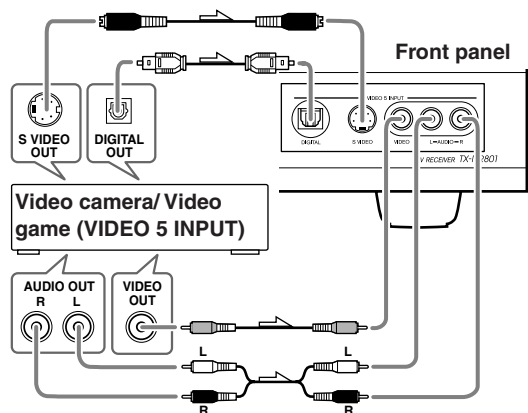

Connecting a Compact Disc Player (CD)

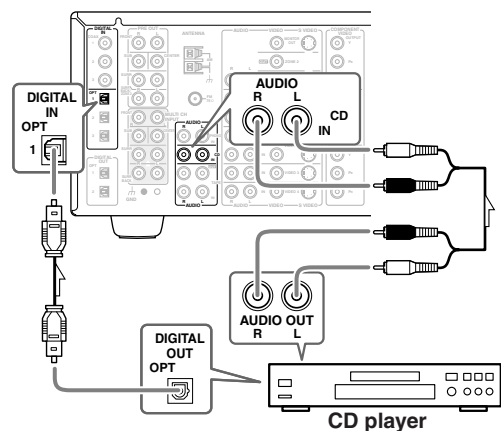

Using an RCA audio connection cable, connect the output jacks of the compact disc player to the CD AUDIO jacks of the TX-NR801/TX-NR801E. Make sure that you properly connect the left channel to the L jack and the right channel to the R jack.

If the compact disc player has a digital output, connect it to either the DIGITAL IN COAX jack or DIGITAL IN OPT jack of the TX-NR801/TX-NR801E, depending on the type of connector on the compact disc player.

On the initial settings of the TX-NR801/TX-NR801E, the CD input source is set for digital input at the OPT 1 jack.

If the digital connection is made to a different jack, this must be changed at Setup Menu → Input Setup → Digital Setup (See page 36).

Connecting a Turntable (PHONO)

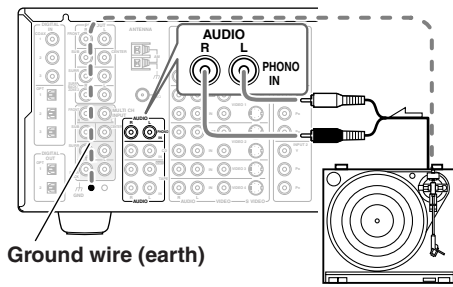

Using an RCA audio connection cable, connect the output jacks of the turntable to the PHONO audio jacks of the TX-NR801/TX-NR801E. Make sure that you properly connect the left channel to the L jack and the right channel to the R jack.

Note:

The TX-NR801/TX-NR801E is designed for use with moving magnet cartridges. For proper operation, connect a ground (or earth) wire to the GND terminal. For some turntables, however, connecting the ground wire may cause increased noise, and in such a case, a ground wire is not necessary and should not be connected.

Connecting a Cassette Tape Deck, MD Recorder, DAT Deck, or CD Recorder (TAPE)

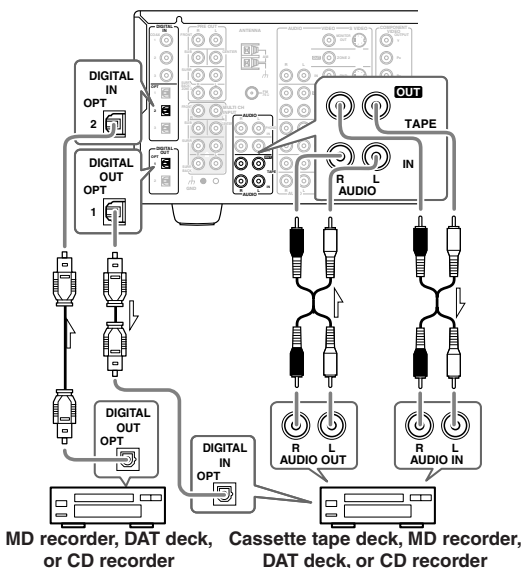

Using RCA audio connection cables, connect the output jacks (PLAY) of the device to the TAPE AUDIO IN jacks of the TX-NR801/TX-NR801E and connect the input jacks (REC) of the device to the TAPE AUDIO OUT jacks of the TX-NR801/TX-NR801E. Make sure that you properly connect the left channels to the L jacks and the right channels to the R jacks. If the device has a digital output, connect it to either the

DIGITAL IN COAX jack or DIGITAL IN OPT jack of the TX-NR801/TX-NR801E, depending on the type of connector on the device.

On the initial settings of the TX-NR801/TX-NR801E, the TAPE input source is set for digital input at the OPT 2 jack.

If the digital connection is made to a different jack, this must be changed at Setup Menu → Input Setup → Digital Setup (See page 36).

If the device has a digital input, connect it to the DIGITAL OUT OPT jack of the TX-NR801/TX-NR801E for digital recording of the REC OUT signal from the TX-NR801/TX-NR801E.

However, if the same device also has a digital output and it has already been connected to the TX-NR801/TX-NR801E, you cannot connect the digital input of the device to the DIGITAL OUT jack of the TX-NR801/TX-NR801E simultaneously.

Note:

The output from the DIGITAL OUT jack of the TX-NR801/TX-NR801E is only the digital signal input to the DIGITAL IN jack.

Connecting the Power Cords from Other Devices

The TX-NR801/TX-NR801E is equipped with AC mains outlets for connecting the power cords from other devices so that their power is supplied through the TX-NR801/TX-NR801E. By doing this, you can leave the connected device turned on and have the STANDBY/ON button on the TX-NR801/TX-NR801E turn on and off the device together with the TX-NR801/TX-NR801E.

The shape, number, and total capacity of the AC outlets may differ depending on the area of purchase.

Caution:

Make sure that the total capacity of the components connected to the TX-NR801/TX-NR801E does not exceed the capacity that is printed on the rear panel (e.g., TOTAL 120W).

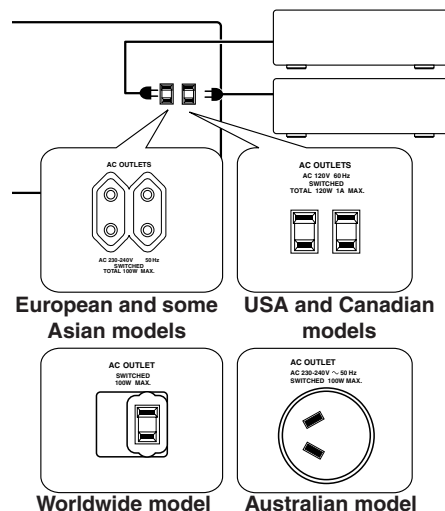

Connecting Auxiliary Power Amplifier

These jacks are for connecting an auxiliary power amplifier.

You can use an auxiliary power amplifier to listen at louder volumes than you can with the TX-NR801/ TX-NR801E alone. When using a power amplifier, connect each speaker to the power amplifier.

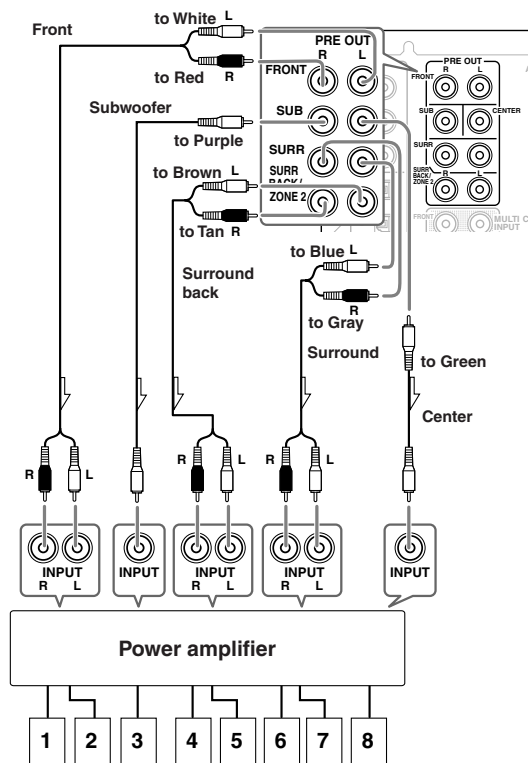

- | | |
|--------------------------------|---------------------------|
| 1. Front left speaker | 6. Surround left speaker |
| 2. Front right speaker | 7. Surround right speaker |
| 3. Subwoofer | 8. Center speaker |
| 4. Surround back left speaker | |
| 5. Surround back right speaker | |

Connecting RI-compatible AV Components

The **RI** terminal on the TX-NR801/TX-NR801E is for connecting other Onkyo components equipped with the same **RI** terminal. When a component is connected to the **RI** terminal, it can be operated by the remote controller supplied with the TX-NR801/TX-NR801E. In addition, when you connect a component to the **RI** terminal, you can also perform the system operations given below.

Power on/ready function

When the TX-NR801/TX-NR801E is in the standby state, if an **RI**-connected component is turned on, the TX-NR801/TX-NR801E also turns on and the input source selected at the TX-NR801/TX-NR801E automatically switches to that component.

Be aware that this function will not work if the power cord for the **RI**-connected component is connected to the AC OUTLET on the TX-NR801/TX-NR801E, or if the TX-NR801/TX-NR801E has already been turned on.

Direct change function

When the play button is pressed on an **RI**-connected component, the input source selected at the TX-NR801/TX-NR801E automatically changes to that component.

Power off function

When the TX-NR801/TX-NR801E is placed in the standby state, all **RI**-connected components are also automatically put into the standby state.

Also, if you press the ON button on the TX-NR801/TX-NR801E remote controller while the TX-NR801/TX-NR801E is turned on, all **RI**-connected components (DVD players, CD players, MD recorders, tuners, etc.) are also turned on.

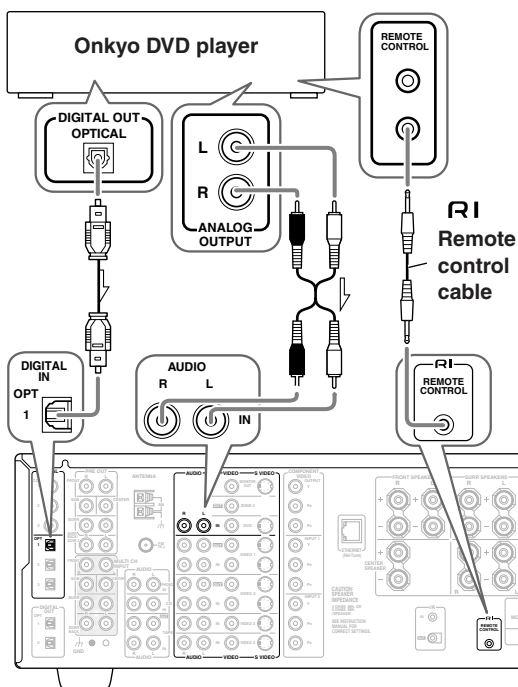

Connections for Remote Control (RI)

To connect components using the **RI** terminal, simply connect a remote control cable from this **RI** terminal to the **RI** terminal of the other component. An **RI** remote control cable with a 1/8 inch (3.5 mm) miniature two-conductor plug comes with every cassette tape deck, compact disc player, MD recorder, and DVD player that has an **RI** terminal.

- When performing operations with **RI**-connected components using the **RI** system, do not use the remote zone (Zone 2).
- For remote control operation, the audio connection cables must also be connected.
- If a component has two **RI** terminals, you can use either one to connect to the TX-NR801/TX-NR801E. The other one can be used to daisy chain with another component.
- With Onkyo DVD players, you can enter the pre-program code so that you can operate the DVD player directly with the remote controller without connecting the **RI** terminals (See page 82).

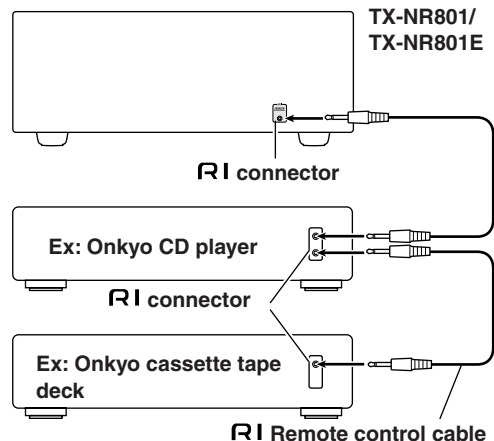

Connecting the Power

(USA, Canadian and Australian models)

(Other models)

STANDBY/ON

STANDBY indicator

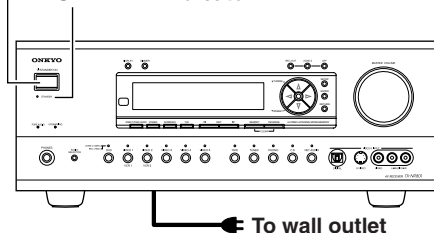

STANDBY/ON

STANDBY indicator

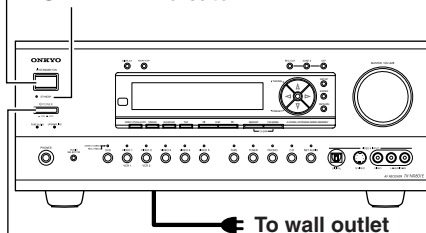

POWER

ON
STANDBY
RCVR



- Before you plug in the TX-NR801/TX-NR801E, confirm that all connections have been made properly.
- Turning on the power may cause a momentary power surge, which might interfere with other electrical equipment on the same circuit, such as computers. If this happens, use a wall outlet on a different circuit.

(All models other than USA, Canadian and Australian models)

- The TX-NR801/TX-NR801E is shipped with the main power (POWER) switch in the on position (ON). When the power cord is plugged in for the first time, the TX-NR801/TX-NR801E will automatically enter the standby state and the STANDBY indicator will light (same condition after step 2 below).

Turning on the Power from the Remote Controller

Before you can use the remote controller, you must perform steps 1 and 2 above and place the TX-NR801/TX-NR801E in the standby state.

1

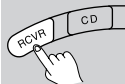

Press the RCVR MODE button.

The RCVR MODE button lights.

2

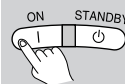

Press the ON button to turn on the TX-NR801/TX-NR801E (take it out of the standby state).

To return the TX-NR801/TX-NR801E to the standby state, press the STANDBY button.

Turning on the Power

1



Plug the power cord into an AC wall outlet.

(USA, Canadian and Australian models)

The STANDBY indicator will light up.



(Other models)

Press the POWER switch to set the TX-NR801/TX-NR801E to standby state.

The STANDBY indicator will light up.



2



STANDBY

Turn off

Press the STANDBY/ON button to turn on the TX-NR801/TX-NR801E.

The display will light up and the STANDBY indicator will turn off.

If you press the STANDBY/ON button again, the TX-NR801/TX-NR801E returns to the standby state.

Memory backup

The TX-NR801/TX-NR801E uses a battery-less memory backup system in order to retain radio presets and other settings when it is unplugged or in the case of a power failure. Although no batteries are required, the TX-NR801/TX-NR801E must be plugged into an AC outlet in order to charge the backup system. (On other than USA, Canadian and Australian models, the TX-NR801/TX-NR801E's POWER switch must be set to ON in order to charge the backup system.) Once it has been charged, the TX-NR801/TX-NR801E will retain the settings for several weeks, although this depends on the environment and time will be shorter in humid climates.

Setup Menu

When making the various settings required to configure your TX-NR801/TX-NR801E for optimum performance, you can either use the OSD Menu that appears on your television monitor or you can use the display on the front of the TX-NR801/TX-NR801E. The OSD Menu is a settings menu that is displayed on your TV monitor. For your reference when performing the setting procedures, this manual shows both the OSD Menu displayed on your television monitor and the display on the front of the TX-NR801/TX-NR801E.

The Setup Menu consists of the Basic Menu that is divided up into 4 menus, the Hardware Setup Menu, the Speaker Setup Menu, the Input Setup Menu, and the Audio Adjust Menu, and the Advanced Menu that contains the menus of the Basic Menu, the Preference Menu, and the Network Setup Menu. These menus are then divided up into various sub-menus, and these contain settings for you to optimize your home theater as you wish.

The display shown below is an example. The actual contents of your display may differ depending on the model of your region and the selected input source.

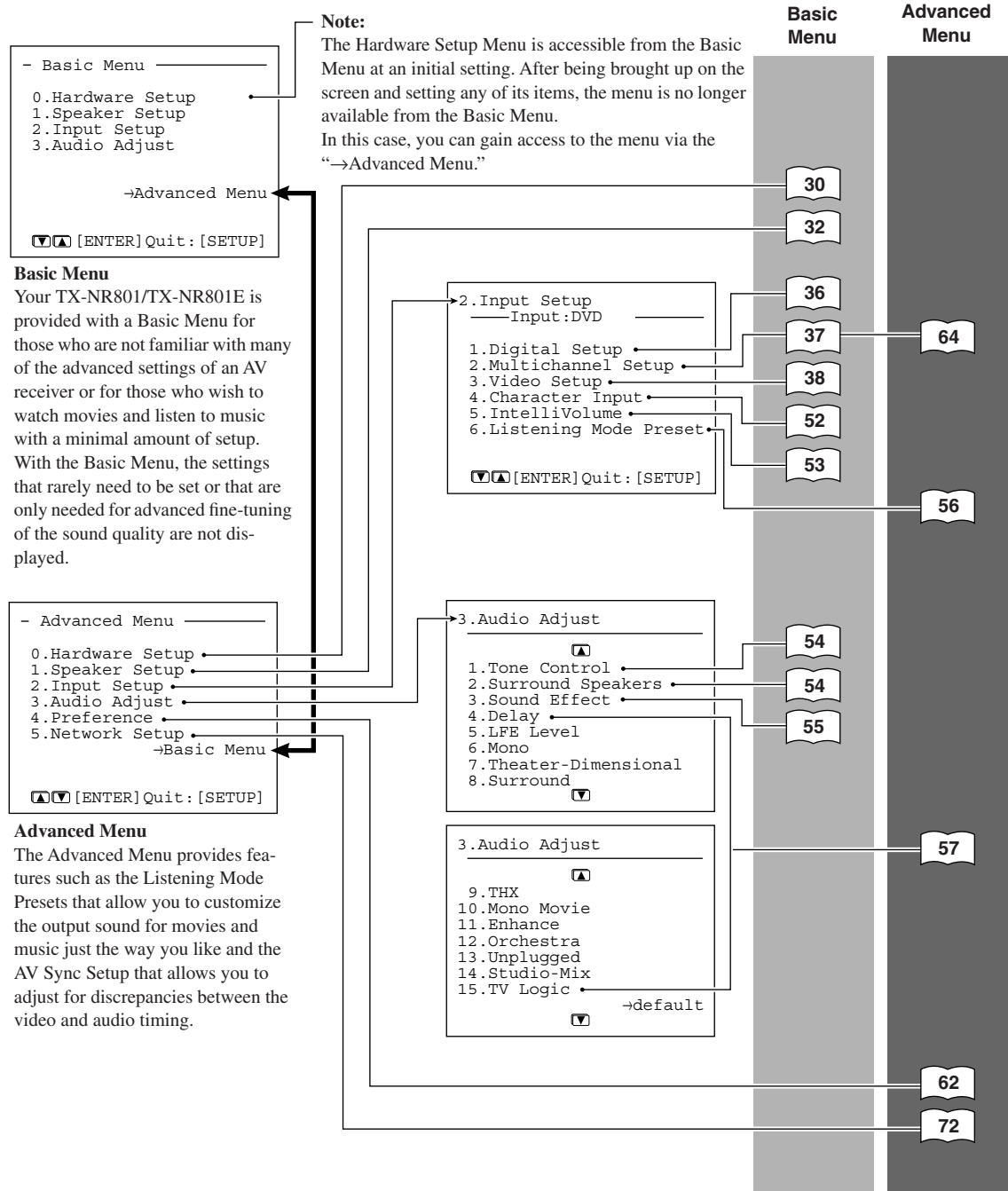

OSD

Front panel display

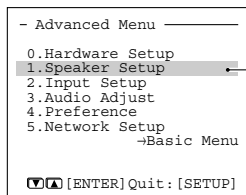

1. Speaker Setup

Main menu

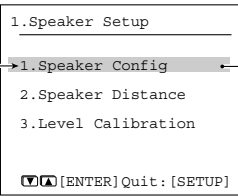

Speaker Config?

Menu

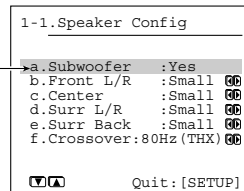

Subwoofer: Yes

Sub-menu

Navigating Through the Setup Menu

You can change settings in the Setup Menu using the buttons on the front panel and on the remote controller. The buttons on the remote controller correspond to those on the TX-NR801/TX-NR801E as shown below.

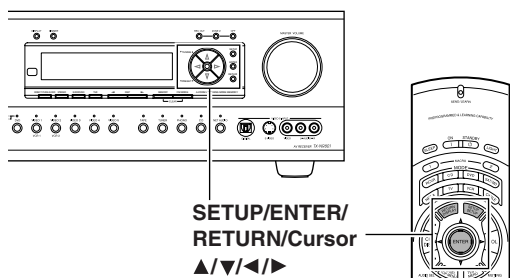

SETUP/ENTER/
RETURN/Cursor
▲/▼/◀/▶

Button on remote controller	Button on TX-NR801/TX-NR801E
SETUP	SETUP
(upper edge of ENTER button)	UP
(lower edge of ENTER button)	DOWN
(left edge of ENTER button)	LEFT
(right edge of ENTER button)	RIGHT
ENTER	ENTER
RETURN	RETURN

- 1** Press the **SETUP** button.

The main menu (Advanced Menu or Basic Menu) appears on your television monitor.
- 2** Using the **▲** and **▼** cursor buttons, select the menu that you want to enter.
- 3** Press the **ENTER** button to enter the selected menu.

The screen for that menu appears.
- 4** Use the **▲** and **▼** cursor buttons to select the sub-menu that you want to enter and press the **ENTER** button.

Each sub-menu has different settings that can be changed as desired, and they are all explained in the pages that follow. To change a setting, first select it using the **▲** and **▼** cursor buttons, and then change the setting using the **◀** and **▶** cursor buttons.
- 5** Press the **SETUP** button to exit the Setup Menu.

Press the **RETURN** button to set the new settings and return to the previous menu.

Selecting the Appropriate Setting for Your Connections

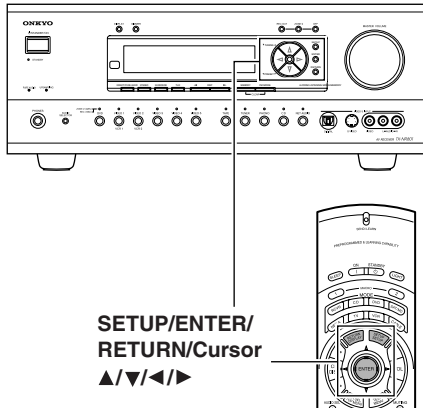

Hardware Setup

In this section, you will perform the initial settings for the following scenarios.

- When the impedances for speakers connected to the TX-NR801/TX-NR801E are between 4 and 6 Ω (See page 18).
- When connecting speakers to the ZONE 2 SPEAKERS terminals (See page 66).
- When operating the remote controller using the IR IN terminal (See page 69).
- When you want to fix the TV Format setting to PAL or NTSC.
- When you want to fix the AM Frequency Step setting to 9 kHz or 10 kHz.

Note:

The settings within the Hardware Setup Menu will need to be made before you use your TX-NR801/TX-NR801E for the first time. Once you have selected one of the Hardware Setup menu items, the setting will not be displayed again when you enter the Basic Menu. To change the setting at a later date, select the Advanced Menu to display the Hardware Setup Menu.

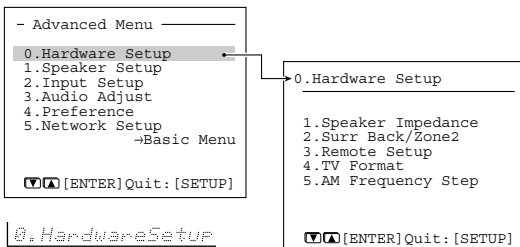

If you want to perform these operations using the remote controller, first press the RCVR button.

1 Display the main menu.

Press the SETUP button on the front panel or SETUP button on the remote controller to display the main menu on the monitor and front display.

2 Use the ▲ and ▼ cursor buttons to select “0. Hardware Setup” and then press the ENTER button.

The “Hardware Setup” menu appears.

3 Use the ▲ and ▼ cursor buttons to select an item and then press the ENTER button.

4 Use the ▲ and ▼ cursor buttons to select an item and then use the ◀ and ▶ cursor buttons to set the desired value.

5 Press the SETUP button to exit the Setup menu.

Press the RETURN button to return to the previous menu.

Speaker Impedance Sub-menu

Use this sub-menu to set the impedance level of the TX-NR801/TX-NR801E to match the specifications of the speakers you are using.

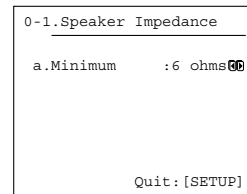

[SP Impedance?]

a. Minimum

6 ohms (default): Select when the impedances of all speakers are between 6 and 16 Ω .

4 ohms: Select when the impedance of even one speaker is between 4 and 6 Ω .

Note:

Before you change this setting, be sure to first lower the volume at the TX-NR801/TX-NR801E to the minimum level.

Surr Back/Zone 2 Sub-menu

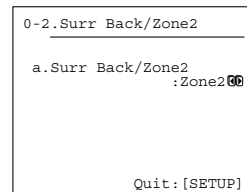

[Surr Back/Zone2?]

Selecting the Appropriate Setting for Your Connections—Continued

a. Surr Back/Zone 2

Zone 2: Select when connecting the speakers for the remote zone (Zone 2) to the SURR BACK/ZONE 2 PRE OUT or SURR BACK/ZONE 2 SPEAKERS terminals (for using the internal amplifier for Zone 2).

Surr Back (default): Select when not connecting the speakers for the remote zone (Zone 2) to the SURR BACK/ZONE 2 PRE OUT or SURR BACK/ZONE 2 SPEAKERS terminals (for using the internal amplifier for the surround back speakers).

Note:

The SURR BACK/ZONE 2 PRE OUT and SURR BACK/ZONE 2 SPEAKER terminals

In order to have 7.1 channel playback in the main room, you must set the Surr Back/Zone 2 setting to “Surr Back.” When set to “Surr Back,” the surround back signals are output from the SURR BACK/ZONE 2 PRE OUT and SURR BACK/ZONE 2 SPEAKER terminals. Connect the surround back speakers to the SURR BACK/ZONE 2 SPEAKER terminals or to the speakers terminals of the power amplifier connected to the SURR BACK/ZONE 2 PRE OUT terminals.

When you are not using the surround back speakers in the main room and are using the internal amplifier to power the speakers for the remote zone (Zone 2), set the Surr Back/Zone 2 setting to are “Zone 2.” When set to “Zone 2,” the Zone 2 signals are output from the SURR BACK/ZONE 2 PRE OUT and SURR BACK/ZONE 2 SPEAKER terminals. Connect the remote zone (Zone 2) speakers to the SURR BACK/ZONE 2 SPEAKER terminals or to the speaker terminals of the power amplifier connected to the SURR BACK/ZONE 2 PRE OUT terminals.

At this time, the main room is switched to 5.1 channel playback mode, and therefore you cannot select the THX Surround EX, Dolby Digital EX or DTS-ES, which requires the surround back speakers.

Remote Setup Sub-menu

Use this sub-menu when you have a remote control sensor connected to the IR IN terminal. The setting in this sub-menu tells the TX-NR801/TX-NR801E whether the remote control sensor is being used for operation of the TX-NR801/TX-NR801E in the main zone or the remote zone (Zone 2).

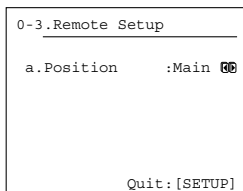

Remote Setup?

a. Position

Main: Select when you are using the remote control sensor for operation with the remote controller in the main zone.

Zone 2: Select when you are using the remote control sensor for operation with the remote controller in the remote zone (Zone 2).

TV Format Sub-menu

a. TV Format (For all models other than USA and Canadian models)

When you want to reconfigure the settings conforming to the television format used for the area where you use the TX-NR801/TX-NR801E, use this sub-menu so that no time is wasted on detection.

Auto: This is the default setting. When you leave this setting unchanged, the television format is detected and automatically set by the TX-NR801/TX-NR801E.

PAL: Use this setting when you know that the television format is PAL.

NTSC: Use this setting when you know that the television format is NTSC.

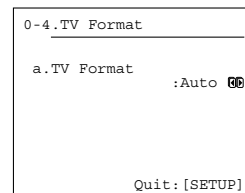

TV Format?

AM Frequency Step Sub-menu (Worldwide model Only)

This sub-menu only appears on the worldwide model. The setting in this sub-menu determines the incremental or decremental amount when adjusting the AM tuner frequency. The initial setting is 9 kHz, and this needs only to be changed if you are using the TX-NR801/TX-NR801E in a 10 kHz region.

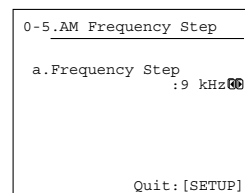

AM Freq Step?

a. Frequency Step

9 kHz: Select when you use the TX-NR801/TX-NR801E in North America.

10 kHz: Select when you use the TX-NR801/TX-NR801E in other than USA and Canada.

Selecting the Appropriate Setting for Your Connections—Continued

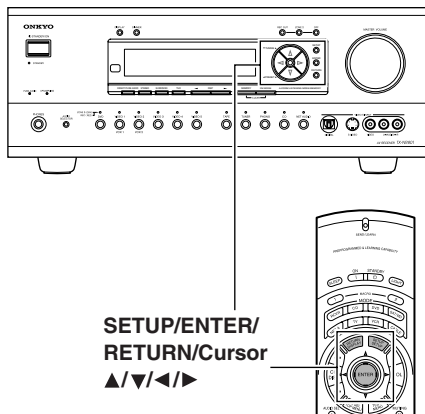

Speaker Setup

After you have installed the TX-NR801/TX-NR801E, connected all the components, and determined the speaker layout, it is now time to perform the settings in the Speaker Setup Menu to optimize the sound acoustics for your environment and speaker layout.

Before you perform the following settings, it is important that you first determine the following items:

- The types and sizes of the speakers that are connected.
- The distance from each speaker to the normal listening position.

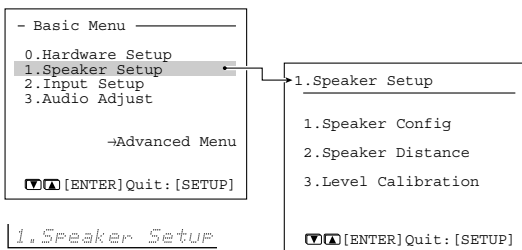

they will be output to the left and right front speakers. (Set all speakers for THX speaker systems to “small.”) If you want to perform these operations using the remote controller, first press the RCVR button.

- 1 Display the main menu.**
Press the SETUP button on the front panel or SETUP button on the remote controller to display the main menu on the monitor and front display.
- 2 Use the ▲ and ▼ cursor buttons to select “1. Speaker Setup” and then press the ENTER button.**
The “Speaker Setup” menu appears.
- 3 Use the ▲ and ▼ cursor buttons to select an item and then press the ENTER button.**
- 4 Use the ▲ and ▼ cursor buttons to select an item and then use the ◀ and ▶ cursor buttons to set the desired value.**
- 5 Press the SETUP button to exit the Setup menu.**
Press the RETURN button to return to the previous menu.

Memo:

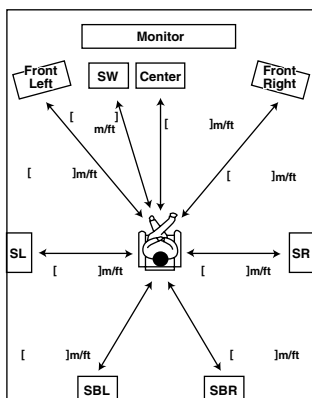

Note:

When “Large” is set, the complete frequency range for that speaker channel will be output. When “Small” is set, the frequencies below 80 Hz for that speaker channel are output to the subwoofer. If there is no subwoofer, then

Selecting the Appropriate Setting for Your Connections—Continued

Speaker Config Sub-menu

Use this sub-menu to enter which speakers are connected and the size of each speaker.

For your reference to speaker size settings, if the diameter of your speaker unit is larger than 6-1/2" (16 cm), use the "Large" setting; otherwise use the "Small" setting.

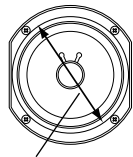

Cone diameter

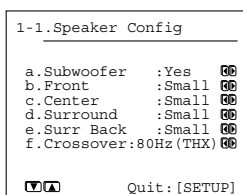

Speaker Config?

a. Subwoofer

Yes: Select when a subwoofer is connected.

No: Select when a subwoofer is not connected.

b. Front

Large: Select if the front speakers are large sized.

Small: Select if the front speakers are small sized.

- If "No" is selected for the Subwoofer setting, this setting is fixed to "Large."

c. Center

None: Select if no center speaker is connected.

Large: Select if the center speaker is large sized.

Small: Select if the center speaker is small sized.

- If "Small" is selected for the Front setting, "Large" cannot be selected for this setting.

d. Surround

None: Select if no surround left and right speakers are connected.

Large: Select if the surround left and right speakers are large sized.

Small: Select if the surround left and right speakers are small sized.

- If "Small" is selected for the Front setting, "Large" cannot be selected for this setting.

e. Surr Back

None: Select if no surround back left and right speakers are connected.

Large: Select if the surround back left and right speakers are large sized.

Small: Select if the surround back left and right speakers are small sized.

- If "None" is selected for the Surround setting, this setting cannot be selected.

- If "Small" is selected for the Surround setting, "Large" cannot be selected for this setting.
- If the Surr Back/Zone 2 setting in the Surr Back/Zone 2 Sub-menu of the Hardware Setup Menu is set to "Zone 2," this setting cannot be selected.

f. Crossover

This setting allows you to set the crossover frequency for your speaker system. The crossover frequency is the minimum frequency delivered to a speaker and can be set to 40 Hz, 60 Hz, 80 Hz (THX), 100 Hz, 120 Hz, or 150 Hz.

Select "80Hz (THX)" if you are using a THX-certified speaker system. This setting is valid when "Subwoofer" is set to "Yes," or for speakers that are set to "Small," at the "Speaker Config" menu. Frequencies below this are cut from speakers set to "Small" and sent to the subwoofer (or to speakers set to "Large").

Note:

When "Large" is set, the complete frequency range for that speaker channel will be output. When "Small" is set, the frequencies below 80 Hz for that speaker channel are output to the subwoofer. If Subwoofer is set to "No" in the 1-1. Speaker Config Sub-menu, then they will be output to the left and right front speakers.

Set all speakers for THX speaker systems to "small."

Speaker Distance Sub-menu

Use this sub-menu to enter the distance from each speaker to the normal listening position.

Notes:

- Speakers that you selected "No" or "None" for in the Speaker Config Sub-menu cannot be selected in this sub-menu.
- The difference between the distances of different speakers cannot be set to more than 20 feet (6 meters).

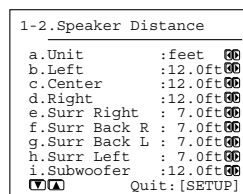

Sp Distance?

a. Unit

feet: Select if you will enter the distances in feet.

meters: Select if you will enter the distances in meters.

b. Left

Set the distance from the front left speaker to your normal listening position. This can be set between 1 and 30 feet in 0.5 feet increments (between 0.3 and 9 meters in 0.15 meter increments).

c. Center

Set the distance from the center speaker to your normal listening position. This can be set between 1 and 30 feet in 0.5 feet increments (between 0.3 and 9 meters in 0.15 meter increments).

Selecting the Appropriate Setting for Your Connections—Continued

d. Right

Set the distance from the front right speaker to your normal listening position. This can be set between 1 and 30 feet in 0.5 feet increments (between 0.3 and 9 meters in 0.15 meter increments).

e. Surr Right

Set the distance from the surround right speaker to your normal listening position. This can be set between 1 and 30 feet in 0.5 feet increments (between 0.3 and 9 meters in 0.15 meter increments).

f. Surr Back R

Set the distance from the surround back right speaker to your normal listening position. This can be set between 1 and 30 feet in 0.5 feet increments (between 0.3 and 9 meters in 0.15 meter increments).

g. Surr Back L

Set the distance from the surround back left speaker to your normal listening position. This can be set between 1 and 30 feet in 0.5 feet increments (between 0.3 and 9 meters in 0.15 meter increments).

Note:

If the Surr Back/Zone 2 setting in the Surr Back/Zone 2 Sub-menu of the Hardware Setup Menu is set to “Zone 2,” then the Surr Back R and Surr Back L settings will not be displayed.

h. Surr Left

Set the distance from the surround left speaker to your normal listening position. This can be set between 1 and 30 feet in 0.5 feet increments (between 0.3 and 9 meters in 0.15 meter increments).

i. Subwoofer

Set the distance from the subwoofer to your normal listening position. This can be set between 1 and 30 feet in 0.5 feet increments (between 0.3 and 9 meters in 0.15 meter increments).

Level Calibration Sub-menu

Use this sub-menu to set the volume for each speaker so that each volume is heard by the listener at the same level. This is especially important for speaker layouts where the left and right speakers are at different distances or in asymmetrical positions due to room designs and configurations. These settings and the distance settings performed in the Speaker Distance Sub-menu are vital for creating proper sound space and dynamics.

1-3.Level Calibration	
a.Left	: 0dB00
b.Center	: 0dB00
c.Right	: 0dB00
d.Surr Right	: 0dB00
e.Surr Back R	: 0dB00
f.Surr Back L	: 0dB00
g.Surr Left	: 0dB00
h.Subwoofer	: 0dB00
	Quit:[SETUP]

Level Cal?

- These settings cannot be made when the sound is muted, when you connect the headphones, and when you use multichannel playback.
- You cannot use the MASTER VOLUME dial while you perform the Level Calibration settings. These settings are intended to bring sound levels between speakers into balance so as to obtain the proper sound space.
- This unit supports the THX format and the test tone is output at a standard 0 dB (the Absolute Volume value is 82). **If you usually enjoy listening at a lower level than the test tone, be careful of the test tone's sudden big sound.** Note that the test tone will be output immediately after pressing the ENTER button in step 1 below.

1 Use the ▲ and ▼ cursor buttons to select “3. Level Calibration” on the sub menu and then press the ENTER button.

The “Level Calibration” menu appears.

You will hear a pink noise from the front left speaker. At this time, the volume of the pink noise will automatically increase to a predetermined reference level (82).

Note:

Speakers for which you selected “No” or “None” in the “Speaker Config” menu will be disabled.

2 Use the ▲ and ▼ cursor buttons to select “Left.”

Remember the volume level of this noise and then press the ▼ cursor button. (Note that this can be adjusted to any level between -12 and +12 decibels in 1 decibel increments. For subwoofer, values between -15 and +12 dB can be set.) The TX-NR801/TX-NR801E will now emit the pink noise from the center speaker.

3 Using the ◀ and ▶ cursor buttons, adjust the volume level of the noise from the center speaker so that it is at the same level as that emitted from the front left speaker.

You can go back and forth between the speakers to help you compare the volume levels.

4 Press the ▼ cursor button again.

The TX-NR801/TX-NR801E will now emit the pink noise from the front right speaker.

5 Repeat steps (3) and (4) above for the front right and other speakers until all speakers are adjusted to the same volume level.

Notes:

- Speakers for which you selected “No” or “None” in the Speaker Config Sub-menu cannot be selected.

Selecting the Appropriate Setting for Your Connections—Continued

- To accurately set the output levels, it is recommended to use a handheld sound pressure level (SPL) meter. Set the meter to C-weighting and slow averaging. A Radio Shack® SPL meter or equivalent is recommended. Using the internal channel noise generators, set each channel so that you read a 75 decibel sound pressure level.

Using the remote controller

1	<p>Press the TEST button.</p> <p>A pink noise will be emitted from the front left speaker.</p> <p>At this time, the volume of the pink noise will automatically increase to a predetermined reference level (0 dB).</p>
2	<p>Remember the volume level of this noise and then press the CH SEL button.</p> <p>The TX-NR801/TX-NR801E will now emit the pink noise from the center speaker.</p>
3	<p>Using the LEVEL ▼/▲ buttons, adjust the volume level of the noise from the center speaker so that it is at the same level as that emitted from the front left speaker.</p>
4	<p>Use the CH SEL and LEVEL ▼/▲ buttons to select other speakers and adjust the volumes until all speakers are adjusted to the same level.</p>
5	<p>Press the TEST button to complete the procedure.</p>

Configuring Input Settings Suitable for Your Connections

These input settings should be made so that the TX-NR801/TX-NR801E is optimized for your connections. If the default settings suit your connections, you do not need to change any settings.

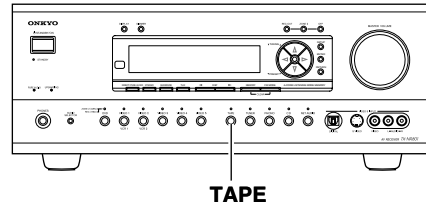

To Change the Display of the Input Source from TAPE to MD

If you connected an MD recorder to the TAPE jack on the TX-NR801/TX-NR801E, you can have "MD" appear when the TAPE source button is pressed.

TX-NR801/ TX-NR801E



Remote controller

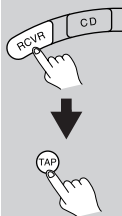

Press and hold down the TAPE source button on the TX-NR801/TX-NR801E until the display changes from TAPE to MD (approx. 3 seconds).

When you use the remote controller to perform the procedure, on the remote controller, press the RCVR button and hold down the TAP button for three seconds.

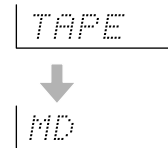

To return the display to its original setting, perform the same procedure.

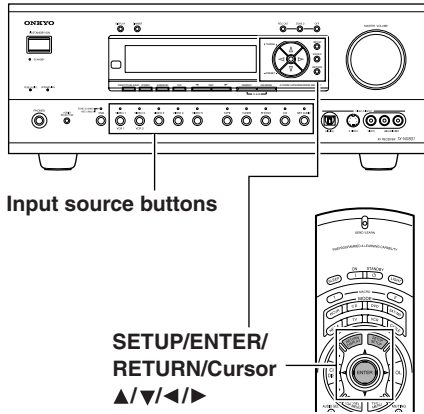

Input Setup

If the default input settings do not suit your connections, perform the following procedures to configure your input settings.

The settings made in this menu are valid for the input source that is currently selected with the input source buttons on the front panel and, therefore, these settings are made separately for each input source.

For details on the Input Setup settings when NET AUDIO is selected as the input source, see page 74.

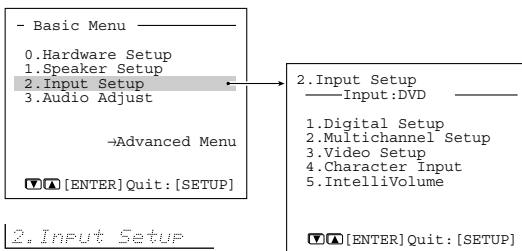

2. Input Setup

If you want to perform these operations using the remote controller, first press the RCVR button.

- 1** Press the input source button (or INPUT SELECTOR button on the remote controller).
- 2** Display the main menu.
Press the SETUP button on the front panel or SETUP button on the remote controller to display the main menu on the monitor and front display.
- 3** Use the ▲ and ▼ cursor buttons to select “2. Input Setup” and then press the ENTER button.
The “Input Setup” menu appears.
- 4** Use the ▲ and ▼ cursor buttons to select an item and then press the ENTER button.

5 Use the ▲ and ▼ cursor buttons to select an item and then use the ◀ and ▶ cursor buttons to set the desired value.

6 Press the SETUP button to exit the Setup menu.

Press the RETURN button to return to the previous menu.

Digital Setup Sub-menu (When NET AUDIO, FM, or AM is not selected as the input source)

This sub-menu concerns the input of digital signals from input sources and if these settings are incorrectly made, the digital audio signals may not be properly output, or not heard at all. This sub-menu cannot be selected if the selected input source button is AM, FM, or NET AUDIO. It is not accessible if “Yes” is selected in 2-2. Multichannel Setup Sub-menu and “Multichannel!” is selected in the AUDIO SELECTOR. Furthermore, VIDEO 5 is fixed to the optical digital terminal on the front panel.

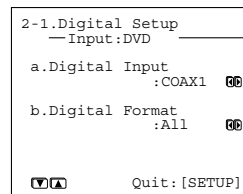

Digital Setup?

Initial settings for each input source

Input source	Digital input
CD	OPT 1
PHONO	----
TUNER	⚡
TAPE	OPT 2
VIDEO 1	COAX 2
VIDEO 2	COAX 3
VIDEO 3	OPT 3
VIDEO 4	----
VIDEO 5	FRONT (fixed)
DVD	COAX 1
NET AUDIO	⚡

----: Available for digital input but not set in initial settings.

⚡: Not available for digital input.

a. Digital Input

This setting tells the TX-NR801/TX-NR801E which input source button on the front panel is connected with which digital input jack on the rear panel.

For example, if the input source selected at the front panel is CD and the compact disc player is connected to DIGITAL IN OPT 1, then select “OPT1” here. If the input source selected is not connected to a digital input, then select “----.”

OPT1-3: Select if the input source is connected to any of the DIGITAL IN OPT jacks 1 through 3.

COAX1-3: Select if the input source is connected to any of the DIGITAL IN COAX jacks 1 through 3.

----: Select if the input source is not from a digital input jack.

b. Digital Format

Sets the digital signal to type given priority during signal detection at the selected digital terminal.

The default setting is “All.” If “----” is selected for this input source at the Digital Input setting, then this setting cannot be selected. Although you can use this default setting as is, you may change it as desired depending on the input signal format or if you know that you will always be listening to a certain input signal format from a particular input source.

All: The digital signal suitable for the input signal will be preceded for playback. When there is no digital signal input, analog signal will be played.

DTS: Select this if you play DTS-formatted CD in “All” mode and hear noise during fast-forward or rewind operation. Non-DTS sound input will not be output.

PCM: Select this if you hear sound gap between PCM tracks such as ones on CD in “All” mode. Non-PCM sound input will not be output.

Notes:

- When you play DTS-formatted CD or LD, be sure to select “All” or “DTS.” If you select “PCM,” noise will be heard.
- If a DTS signal is not input when “DTS” is selected, the TX-NR801/TX-NR801E will not automatically switch to analog output even though “Auto” is selected with the AUDIO SELECTOR button.

Notes on DTS:

- If you play a DTS-formatted CD or LD when the “PCM” setting is selected on the TX-NR801/TX-NR801E, the DTS encoded signal will not be decoded and noise will be output. This noise could damage the amplifier and speakers. Therefore, be sure to select “All” or “DTS” and use the digital input jacks (OPTICAL or COAXIAL) to connect the DTS source.
- If you play a DTS-formatted CD or LD when “All” is selected, you may hear a noise for a short while until the DTS decoder recognizes the DTS-encoded signal and starts operating. This is not a malfunction.
- If you press the pause or skip button on the player while playing a DTS source, a short noise may be

heard. This is not a malfunction. In such cases, try playing the source with the “DTS” selected.

- The DTS indicator on the TX-NR801/TX-NR801E lights while a DTS source is played. When playback finishes and the DTS signal transmission stops, the TX-NR801/TX-NR801E remains in DTS mode and the DTS indicator remains lit. This prevents noise when you operate the pause or skip button on the player. Therefore, if the source is immediately switched from DTS to PCM, the PCM signal may not be played. In this case, stop the playback of the source on the player for about three seconds and then resume playback.
- You may not be able to play some DTS source signals from certain CD players and LD players even when you connect the player to the TX-NR801/TX-NR801E digitally. This is because the digital signal has been processed (such as the output level, sampling frequency, or frequency response) and the TX-NR801/TX-NR801E cannot recognize the signal as DTS data. Therefore you may hear noise when you play a DTS source while processing the signal.
- The outputs for the VIDEO 1 OUT, VIDEO 2 OUT, TAPE OUT, and ZONE 2 OUT output analog audio signals. Do not record from CDs or LDs that support DTS using these outputs. If you do, the DTS-encoded signal will be recorded as noise.

Multichannel Setup Sub-menu (When NET AUDIO is not selected as the input source)

When any input source other than NET AUDIO is selected, this sub-menu appears and allows you to set the multichannel input setting.

The setting in this sub-menu is normally set to “No,” and only needs to be changed to “Yes” if a DVD player, MPEG decoder, or other component that has a multichannel port is connected to the MULTI CH INPUT port for 5.1 channel, 6.1 channel, or 7.1 channel audio. The default setting for “DVD” is set to “Yes” and the one for other input sources is set to “No.” When the analog output from a DVD player is not connected to the MULTI CH INPUT port, change this setting to “No.” For details on the device connection and setting procedures, see “Enjoying analog multichannel audio playback” on page 64.

```
2-2.Multichannel Setup
--Input: DVD
a.Multichannel :Yes 00

Quit:[SETUP]
```

Multich Setup?

Input source selected	Multichannel
CD	No
PHONO	No
TUNER	No
TAPE	No
DVD	Yes
VIDEO 1	No
VIDEO 2	No
VIDEO 3	No
VIDEO 4	No
VIDEO 5	No

Video Setup Sub-menu

When the default input settings does not suit your connection, perform the following procedures to configure your input settings.

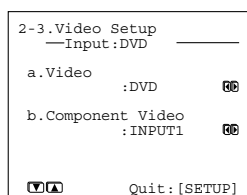

Video Setup?

a. Video

This setting allows you to match the audio from one component with the video from another. Therefore, you can set a video source to be displayed while the audio from another input source is heard. For example, this allows you to play the music from a compact disc, while displaying the picture from a video cassette player or other video source.

The default settings are given below.

Input source selected	Video
CD	Last Valid
PHONO	Last Valid
TUNER	Last Valid
TAPE	Last Valid
DVD	DVD
VIDEO 1	VIDEO 1
VIDEO 2	VIDEO 2
VIDEO 3	VIDEO 3
VIDEO 4	VIDEO 4
VIDEO 5	VIDEO 5
NET AUDIO	Last Valid

The settings in this sub-menu apply to the video and S video signals. Available options for the video source to be displayed are “DVD,” “VIDEO 1” to “VIDEO 5,” “Last Valid” and “----.”

DVD, VIDEO 1-5: Select either the video signal from the VIDEO or S VIDEO terminal for each video input.

Last Valid: Select to have the video of the previous input source continued. For example, if the selected

input source is VIDEO 1, and you then change to CD (set to “Last Valid”), then the audio from the CD input is played while the video from VIDEO 1 continues.

----: Set this option when you do not want any video inputs to be displayed.

b. Component Video

Use this setting if you connect monitors like TV to the COMPONENT VIDEO OUTPUT jacks on the TX-NR801/TX-NR801E.

The default settings are given below.

Input source selected	Component video input
CD	Last Valid
PHONO	Last Valid
TUNER	Last Valid
TAPE	Last Valid
DVD	INPUT 1
VIDEO 1	INPUT 2
VIDEO 2	INPUT 2
VIDEO 3	INPUT 2
VIDEO 4	INPUT 2
VIDEO 5	INPUT 2
NET AUDIO	Last Valid

For example, when you connect the DVD player to the COMPONENT VIDEO INPUT 2 jacks, select “DVD” as input source and set “b. Component Video” to “INPUT 2.”

Available component video inputs are “INPUT 1,” “INPUT 2,” “VIDEO*,” “Last Valid,” and “None*.”

INPUT 1: The video signals from devices connected to the INPUT 1 of the COMPONENT VIDEO input banks are used.

INPUT 2: The video signals from devices connected to the INPUT 2 of the COMPONENT VIDEO input banks are used.

VIDEO*: The video signals assigned in the “a. Video” sub-menu setting are used. This option is useful when no devices are connected to the INPUT 1 and INPUT 2 of the COMPONENT VIDEO input banks.

Last Valid (enables the source last selected): Select to have the video of the previous input source continued.

None*: No video signals are assigned. When you select “None,” the OSD screen disappears. If you want to change this setting later on, use the front panel display on the TX-NR801/TX-NR801E.

*Valid only when the PAL format is used in an area other than USA, Canada and Australia.

Note (When the model is for USA, Canada or Australia and its TV format is PAL):

When the component video signal is output, the information on the NET AUDIO and Immediate Display (see page 63) will not be displayed.

Enjoying Music or Videos with the TX-NR801/ TX-NR801E

Though the TX-NR801/TX-NR801E is often used to listen to the radio, it does not show you its true ability until it is used to play music or watch videos, DVDs, and the like. The TX-NR801/TX-NR801E has the latest state-of-the-art features to play back today's technologies with the utmost in fidelity and power. From a two-speaker system to a seven-speaker system, you are assured a sound space that you can always enjoy.

To ensure the proper sound space, you must first perform the speaker setup settings. These settings allow you to set the type of speakers you are using, the distance they are located from the listening position, and the individual speaker volumes. For more details, see Speaker Setup sub-menu of the Setup Menu on pages 32-35.

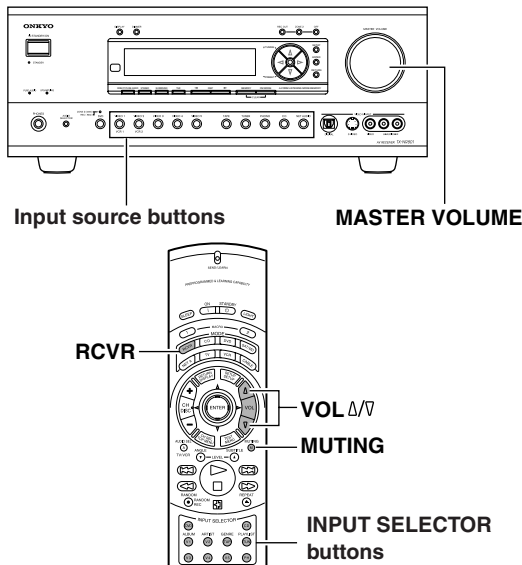

Basic Operation

If you want to perform these operations using the remote controller, first press the RCVR button.

1

**TX-NR801/
TX-NR801E**



**Remote
controller**



Press the input source button (or INPUT SELECTOR button on the remote controller) that corresponds to the source to which you want to listen.

2

Turn on the corresponding component and play the media.

3

**TX-NR801/
TX-NR801E**

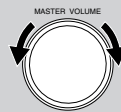

**Remote
controller**



Adjust the volume.

Adjusting the main volume adjusts the volume level of all the speakers connected to the TX-NR801/TX-NR801E together. If headphones are connected, this also adjusts the volume heard from the headphone speakers. To adjust the volume, either press the VOL Δ/V buttons on the remote controller or turn the MASTER VOLUME dial. To increase the volume, turn the dial clockwise; to decrease the volume, turn the dial counterclockwise. The volume can be set from 0 to 100 (or $-\infty$, -81 to $+18$ dB).

Hint:

The TX-NR801/TX-NR801E is designed for home theater environment and has wider volume range enabling fine volume adjustment. This allows you to set the volume at your preferred level easily.

Temporarily turning off the sound

Use the MUTING button to temporarily turn off the sound immediately.

**Remote
controller**



Press the MUTING button on the remote controller.

When pressed, "Muting" is displayed on the TX-NR801/TX-NR801E. Press the MUTING button again to turn the sound back on.

Muting

Listening with headphones

To listen with headphones, plug a pair of headphones with a standard stereo plug into the PHONES jack on the TX-NR801/TX-NR801E front panel.

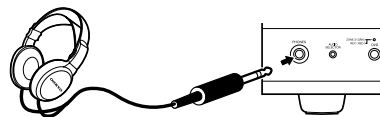

When you connect headphones, no sound will be heard from the speakers.

When the headphones are unplugged, the TX-NR801/TX-NR801E returns to its original listening mode. When using the headphones, you can only use the Direct, Pure Audio, Stereo, and Mono listening modes (Available modes can vary depending on the current input source). If you select MULTI CH INPUT, you will only hear the sound output to the front right and left channels.

The headphone volume level can be adjusted at the Setup Menu (See page 63).

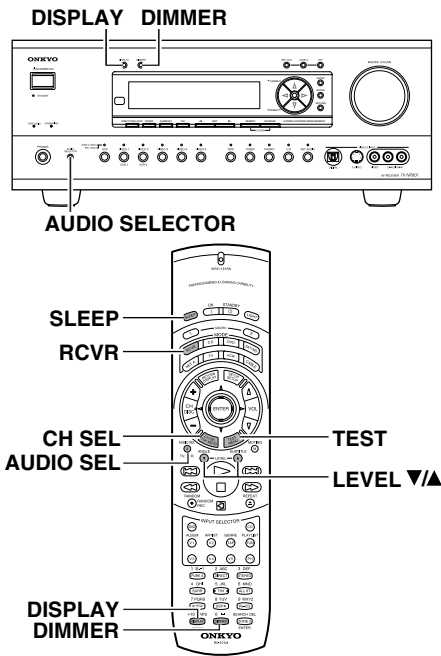

Note:

The signal to the remote zone (Zone 2) will not be affected whether or not headphones are connected.

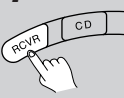

Temporarily Changing the Speaker Output Levels

To change the individual speaker volumes temporarily, follow the procedure given below. Each channel can be set between -12 and +12 decibels (between -15 and +12 decibels for the subwoofer). Note that the speaker volumes will return to the original settings when the TX-NR801/TX-NR801E is put in the standby state.

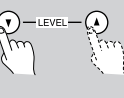
- 1** Press the **RCVR MODE** button.
 
- 2** Press the **CH SEL** button and select the desired speaker.
 
- 3** Press the **LEVEL ▼** or **▲** button to adjust the volume level.
 

Notes:

- You cannot select a speaker if it is set to “No” or “None” in the Speaker Config Sub-menu of the Speaker Setup Menu.
- To have your new speaker levels set here, overwrite the settings at Setup Menu → Speaker Setup Menu → Level Calibration Sub-menu, and press the TEST button after you complete step 3 in the procedure above.

Using the Sleep Timer (remote controller only)

With the sleep timer you can set the TX-NR801/TX-NR801E so that it automatically turns off after a set period.

Remote controller



Press the [SLEEP] button repeatedly to select the required sleep time.

You can set the sleep time from 90 to 10 minutes in 10 minute increments. The SLEEP indicator appears on the display when the sleep timer has been set, as shown. The specified sleep time appears on the display for about five seconds, then the previous display reappears.

Sleep 90min

To cancel the sleep timer, press the [SLEEP] button repeatedly until the SLEEP indicator disappears.

To check the remaining sleep time, press the [SLEEP] button. Note that if you press the [SLEEP] button while the sleep time is being displayed, you'll shorten the sleep time by 10 minutes.

Using the sleep timer only for Zone 2:

If you are using the remote zone (Zone 2), it will turn off at the same time as the main zone. If you want to set the sleep function for Zone 2 only, set the sleep function with main zone turned on and then put the main zone into the standby state.

Adjusting the brightness of the front display

You can adjust the brightness of the front display of the TX-NR801/TX-NR801E using the DIMMER button on the remote controller or on the TX-NR801/TX-NR801E front panel (other than European models).

TX-NR801/ TX-NR801E





Remote controller



Use the DIMMER button to select: dim, dimmer, or normal brightness.

Switching the display

While listening to or watching an input source, you can display information regarding the type of source and signal being input.

<p>TX-NR801/ TX-NR801E</p>  <p>Remote controller</p> <p>+10 CAPS</p> 	<p>Press the DISPLAY button on the TX-NR801/TX-NR801E or the remote controller.</p>
---	--

When an input source other than FM or AM is selected:
Input

DVD

Program format*

Dolby D 3/2.1

Input +
Listening mode
or Multi Ch

DVD Dolby D

* When the input signal is digital audio

The program format is displayed. For example, the display “Dolby D: 3/2.1” shows that the format is Dolby Digital with 5.1 discrete channels consisting of three front channels (front left, front right, and center), two surround channels (surround left and surround right), and the low frequency effect (LFE) channel.

When the front channel number is 2, they are the front left and front right; when it is 1, it is monaural. When the surround channel number is 1, it is monaural; when it is 0, there is no surround channel. When no LFE number is given, there is no LFE channel. Also, if there is no program format for the input signal, nothing will be displayed.

When the input signal is linear PCM

The sampling frequency is displayed. For example, the display “PCM fs: 44.1k” shows that the signal is PCM and that the sampling frequency is 44.1 kHz.

When FM or AM is selected as the input source, see page 47.

Dialog norm



Dialogue Normalization (Dialog Norm) is a feature of Dolby Digital. When playing back software that has been encoded in Dolby Digital, sometimes you may see a brief message in the front panel display that reads Dialog Norm xdB (“x” being a numeric value). Dialogue Normalization serves to let you know if the source material has been recorded at a higher or lower level than usual. For example, if you see the message “Dialog Norm: +4” in the front panel display, to keep the overall output level constant just turn down the volume control by 4 dB. In other words, the source material that you are listening to has been recorded 4 dB louder than

usual. If you do not see a message, then no adjustment of the volume control is necessary.

Dialog Norm: +4

Changing the audio mode

The TX-NR801/TX-NR801E accepts analog, digital and multichannel signals for audio input. You can choose which kind of signal to be played for a specific device.

<p>TX-NR801/ TX-NR801E</p>  <p>Remote controller</p> 	<p>Press the AUDIO SELECTOR button on the front panel (or AUDIO SEL button on the remote controller) to change the audio mode.</p> <p>Each time the button is pressed, the mode changes from “Auto” → “Multich” → “Analog” and back to “Auto.” The “Auto” audio mode is recommended for normal circumstances.</p>
---	--

Auto (automatic detection): With this setting, the TX-NR801/TX-NR801E automatically detects whether the input signal is digital or analog. When a digital signal is not input, then the analog signal is played. This setting only appears if a digital input is selected for the Digital Input setting at Setup Menu → Input Setup Menu → Digital Setup Sub-menu (See pages 36-37).

Multich (Multichannel): Select this setting to play back the input from the component connected to the MULTI CH INPUT port. This setting only appears if “Yes” is selected for the Multichannel setting at Setup Menu → Input Setup Menu → Multichannel Setup Sub-menu (See pages 37-38).

Analog: Select this setting to play back the input from a source component connected to analog audio input jacks. With this setting, even if a digital signal is input from the same component, only the analog signal will be output.

Adjusting the bass and treble

You can adjust the bass and treble levels at the Setup Menu → Audio Adjust Menu → Tone Control Sub-menu (See page 54). The treble level affects the front left and right speakers and the center speaker. The bass level affects the front left and right speakers, the center speaker, and the subwoofer. For multichannel sources, these dials will not work if the tone control is set to “Direct” or “Pure Audio.”

Using the Listening Modes

The TX-NR801/TX-NR801E's surround sound enables you to enjoy movie theater or concert hall quality sound in your home.

The configuration of the speakers is very important for the surround sound effect. Refer to "About Home Theater" on page 16.

Before selecting a listening mode, be sure to complete the Speaker Setup (See page 32). Once the parameters have been set, it is not necessary to set them again. See pages 44-45 for information regarding how to select the listening mode.

Listening Modes

Mono

This mode is for playing old movies where the sound is recorded in monaural or for playing the left and right channels separately for movies that contain different language signals. This mode also allows you to listen to the multiplexed soundtracks on DVDs and other media that have them.

Pure Audio

The same as the direct mode except that the pure audio mode also turns off the display window, turns off the power supply to the video circuitry (resulting in a blacked-out screen), and minimizes the sources of noise. The result is high-fidelity music playback true to the original source.

For USA, Canadian and Australian models:

In the Pure Audio mode, if any component video signal is presented on the COMPONENT VIDEO INPUT 2 jacks, it will be output to the COMPONENT VIDEO OUTPUT jacks.

Direct

This mode delivers pure sound with minimal sound quality adjustment and filtration. The sound recorded for the right and left front channels is output to the right and left front speakers only and not output to the subwoofer.

Stereo

All input sound is output from the left and right front speakers.

The subwoofer is also used for playback.

T-D (Theater-Dimensional)

For the best enjoyment of your home theater, it is recommended that you have front left and right speakers, a center speaker, and surround left and right speakers.

However, if you only have front left and right speakers, you can enjoy multichannel audio by using this mode.

This mode controls the characteristics of the sound that reaches each ear to reproduce a multi-speaker setup. To receive the full effect, there is an optimum listening position (sweet spot). Refer to the explanation of the listening angle. In addition, if the reflective sound components are large, it may be difficult to achieve the desired result, so be sure to set up your system and listening position to minimize reflective sound.

Dolby Pro Logic II

As opposed to Dolby Pro Logic, which had four channels (front left/right, center, and surround) recorded into two channels with matrix processing and then played back in four channels, Dolby Pro Logic II uses a feedback logic circuit to have 5.1 channel surround audio (Dolby Surround, etc.) matrix-encoded into two channels and then played back in its original 5.1 channel form.

Dolby Pro Logic II provides a Movie Mode designed for playing movies and a Music Mode designed for listening to music.

In the Movie Mode, the surround channels, which used to provide monaural output over only a narrow frequency range, now provide complete stereo output over the full frequency range. The result is movie viewing with a realistic feel of movement. This mode can be used with VHS and DVD videos with the  mark and certain television programs.

The Music Mode uses the surround channels to provide a natural soundfield that cannot be provided with normal stereo output. This mode can be used with music compact discs and other stereo sources.

Dolby D (Dolby Digital)

This mode is used for playing Dolby Digital sources. Dolby Digital is compressed digital data with a maximum of 5.1 channel surround sound. This source signal comes from DVDs and LDs that have the  mark and therefore are recorded for 5.1 channel output.

• Dolby Digital EX

Enabled when playing back sources with surround tracks that were encoded using the Surround EX technology.

DTS Neo:6

This mode is for 6.1 channel playback of sources such as PCM or analog sources that have only two channels. The outputs of all six channels have a wide frequency range with a great separation between the different channels.

This mode can be set to the Cinema Mode designed for playing movies and the Music Mode designed for listening to music.

The Cinema Mode is good for movies. The reproduced surround sound provide the same realistic feel of movement as 6.1 channel sources. This mode can be used with VHS and television programs with stereo sound.

The Music Mode uses the surround channels to provide a natural sound space that cannot be provided with normal stereo output. This mode can be used with music CDs and other stereo sources.

DTS

This mode is used for playing DTS sources.

DTS (Digital Theater System) is compressed digital data with a maximum 5.1 channel surround output (6.1 channel with DTS-ES Discrete sources) that allows for an extremely high-quality sound. This source signal requires a DVD player that supports DTS output and comes from DVDs, compact discs, and LDs that have the  mark.

- **DTS-ES Discrete**

With the addition of the surround back channel, this new format has all 6.1 channels recorded independently for a completely discrete digital format. Since all channels are recorded independently, high-fidelity surround playback with an increased feeling of a separated sound space is achieved.

- **DTS-ES Matrix**

This format has the surround back channel matrix encoded and inserted into the left and right surround channels so that at playback the output for the left, right, and back surround channels are decoded using a high-precision matrix decoder.

- **DTS 96/24**

Automatically changes to this mode when playing back sources with surround tracks that were encoded using the DTS 96/24 technology.

THX

THX is an exclusive set of standards and technologies established by the world-renowned film production company, Lucasfilm Ltd. THX grew from George Lucas' personal desire to make your experience of the film soundtrack, in both movie theaters and in your home theater, as faithful as possible to what the director intended. Movie soundtracks are mixed in special movie theaters called dubbing stages and are designed to be played back in movie theaters with similar equipment and conditions. This same soundtrack is then transferred directly onto LD, VHS tape, DVD, etc., and is not changed for playback in a small home theater environment.

THX engineers developed patented technologies to translate accurately the sound from the movie theater environment into the home, correcting the tonal and spatial errors that occur. On this product, when the THX indicator is on, THX features are automatically added in Cinema Modes (e.g. THX Cinema, THX Surround EX).

- **THX Cinema**

This is the conventional 5.1 channel THX format.

This mode should be used only when playing back sources that were mixed for playback in large movie theater environments.

- **THX Surround EX**

“THX Surround EX - Dolby Digital Surround EX” is a joint development of Dolby Laboratories and the THX division of THX Ltd.

In a movie theater, film soundtracks that have been encoded with Dolby Digital Surround EX technology are able to reproduce an extra channel which has been added during the mixing of the program. This channel, called Surround Back, places sounds behind the listener in addition to the currently available front left, front center, front right, surround right, surround left, and subwoofer channels.

This additional channel provides the opportunity for more detailed imaging behind the listener and brings more depth, spacious ambience, and sound localization than ever before.

When released to the home consumer market, movies that were created using the Dolby Digital Surround EX technology, may have a note to that effect on the packaging. A list of movies created using this technology can be found on the Dolby web site at <http://www.dolby.com>.

The TX-NR801/TX-NR801E can play the 5.1 channel sources in THX surround EX mode, even if the source is not encoded in Dolby Digital Surround EX format. In this case, the sound actually output from the surround back channels depends on the source and may not fit your tastes.

Digital Signal Processing (DSP) modes

Mono Movie

This mode is suitable for playing back monaural recording such as old movie soundtracks. The center channel delivers the unprocessed original sound, whereas the other channels deliver the center-channel sound processed with the appropriate reverberation. This allows you to enjoy monaural sound with the atmosphere of a movie theater.

Enhance

This mode reproduces a natural surround environment by using seven speaker channels. The sound effects move smoothly toward the surround back. This mode is good for music and TV sports programs.

Orchestra

This mode is appropriate for classical and opera music. The center channel is cut and the surround channels are emphasized to widen the stereo image. It will simulate the natural reverberation that is created in large halls.

Unplugged

This mode is suitable for acoustical instrumental sounds, vocals, and jazz music. By emphasizing the front stereo image, it will simulate the acoustics that you would experience in front of the stage.

Studio-Mix

This mode is for rock and popular music. The lively sounds are enhanced for a powerful acoustic image that simulates the feeling of being at a club or rock concert.

TV Logic

This mode gives realistic acoustics to TV programs that are aired from TV studios. It enhances the entire surround sound and clarity of the conversation.

All Ch Stereo

This mode is designed for playing background music. The front, surround, and surround back channels create a stereo image that encompasses the entire area.

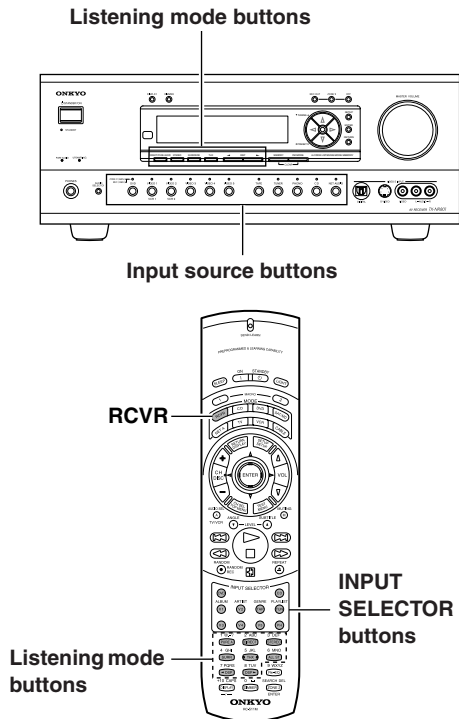

3
**TX-NR801/
 TX-NR801E**
 Use the listening mode buttons on the TX-NR801/TX-NR801E or the remote controller.

Note:
 The available listening modes depend on the input signal you selected (For details, see “Relationship between input source and listening mode” on page 45).

Remote controller

1 @-/	2 ABC	3 DEF
PURE A	DIRECT	STEREO
4 GHI	5 IJKL	6 MNO
SURR	THX	ALL ET
7 PQRS	8 TUV	DSP
DSP	DSP	

DIRECT/PURE AUDIO (DIRECT/PURE A button): Changes the listening mode for the signal type that is currently being input from the selected input source to the Direct listening mode or Pure Audio listening mode. When you use the buttons on the TX-NR801/TX-NR801E for this operation, with each press of this button, you can switch between Direct and Pure Audio. When you select “PURE AUDIO,” the video signal is interrupted (resulting in a blacked-out screen), and the PURE AUDIO indicator lights up.

Note: When you are using the remote zone (Zone 2), the Pure Audio will not work.

STEREO button: Changes the listening mode for the signal type that is currently being input from the selected input source to the Stereo listening mode.

SURROUND (SURR) button: Changes the listening mode for the signal type that is currently being input from the selected input source to the surround mode that matches the signal type (e.g., Dolby Pro Logic II, Dolby Digital, or DTS).

- If the SURROUND (SURR) button is pressed**
- **While playing back DTS sources**
 Switches the DTS-ES setting from: Auto → On → Off. For details, see “d. DTS-ES” on page 60.
 - **While playing back Analog/PCM sources**
 Switches from: Pro Logic II Movie → Pro Logic II Music → DTS Neo6:Cinema → DTS Neo6:Music. For details, see “a. Surr Mode (Analog/PCM)” on page 59.
 - **While playing back D.F. 2-channel sources**
 Switches from: Pro Logic II Movie → Pro Logic II Music. For details, see “b. Surr Mode (D.F.2ch)” on page 59.
 - **While playing back Dolby Digital sources**
 Switches the Dolby Digital EX setting from: Auto → On → Off. For details, see “c. Dolby Digital EX (Dolby D)” on page 60.

Selecting the Listening Mode

The TX-NR801/TX-NR801E provides various listening modes.

1
**TX-NR801/
 TX-NR801E**
Select the input source.
 On the TX-NR801/TX-NR801E, use the input source buttons.
 On the remote controller, after pressing the RCVR button, use the INPUT SELECTOR button.

2
Start playback on the device you selected for input.

Using the Listening Modes—Continued

THX: Changes the listening mode to the THX listening mode.

If the THX button is pressed

- **While playing back Dolby Digital sources**

Switches the THX Surround EX mode (Auto → On → Off) if the source is a THX Surround EX-compatible source. For details, see “c. THX Surround EX (Dolby D)” on page 61.

- **While playing back Analog/PCM sources**

Switches the decoding mode (Pro Logic II Movie → DTS Neo6:Cinema) for THX processing. For details, see “b. Decoder (2ch)” on page 61.

- **While playing back DTS sources**

Switches the DTS-ES mode from Auto → On → Off. Changing the DTS-ES mode allows you to enjoy the DTS THX Cinema, DTS-ES Discrete THX Cinema, and DTS-ES Matrix THX Cinema surround systems. For details, see “d. DTS-ES” on page 61.

Be aware that if surround back speakers are not connected, or if the Surr Back/Zone 2 setting of the Surr

Back/Zone 2 Sub-menu is set to “Zone 2,” the THX Surround EX, DTS-ES Discrete, or DTS-ES Matrix listening modes cannot be selected.

DSP ◀▶: Changes the digital processing mode that is currently being input from the selected input source as shown below.

Mono, Theater-Dimensional, Mono Movie, Enhance, Orchestra, Unplugged, Studio-Mix, TV Logic, All Ch Stereo, Mono.

The digital processing modes available depend on the selected input source.

ALL ST (remote controller only): Changes to All Ch Stereo the listening mode for the input signal of the input source currently selected. If pressed, the corresponding setting in the Listening Mode Preset Sub-menu of the Setup Menu for the selected input source is also changed (See pages 56-57).

On the TX-NR801/TX-NR801E, use the DSP button for enabling the All Ch Stereo listening mode.

Relationship between input source and listening mode

Listening modes marked with the “✓” can be selected. For columns that list a number of listening modes, the display will correspond to the format of the signal from the source media.

Input source signal (display)		Analog/PCM (2ch)	PCM fs= 96k (2ch)	Dolby Digital (3ch-5.1ch)	DTS (5.1ch, 6.1ch)	Digital Format (DD/DTS) (2ch)	Digital Format (Monaural)
Type of software		Tape, Video tape, Vinyl, Tuner, CD, MD, DVD (Stereo), LD, Digital Satellite	DVD (96kHz/24bit)	DVD, Digital Satellite	CD, LD, DVD	DVD, Digital Satellite	DVD
Button/Listening Mode							
PURE A *1	Pure Audio	✓	✓				
DIRECT *1	Direct	✓	✓				
STEREO	Stereo	✓	✓	✓	✓	✓	
SURROUND/SURR	PLII Movie	✓	✓			✓	
	PLII Music	✓	✓			✓	
	DTS Neo:6 Cinema	✓				✓	
	DTS Neo:6 Music	✓				✓	
	Dolby Digital			✓			
	Dolby Digital EX*2			✓			
	DTS				✓		
	DTS 96/24				✓*3		
	DTS-ES Discrete*2				✓*4		
	DTS-ES Matrix*2/ DTS-ES + Neo:6				✓*5		
THX	THX Cinema	✓		✓	✓	✓	
	THX Surround EX*2			✓			
DSP ▶◀	Mono	✓				✓	✓
	Theater-Dimensional	✓		✓	✓	✓	
	Mono Movie	✓				✓	✓
	Enhance	✓		✓	✓	✓	
	Orchestra	✓		✓	✓	✓	
	Unplugged	✓		✓	✓	✓	
	Studio-Mix	✓		✓	✓	✓	
	TV Logic	✓		✓	✓	✓	
	ALL Ch Stereo	✓				✓	

*1 On the TX-NR801/TX-NR801E, use the DIRECT/PURE AUDIO button for selecting these listening modes.

*2 Available only when the surround back speakers are connected to the TX-NR801/TX-NR801E.

*3 Available only when the input source is encoded in the DTS 96/24 format.

*4 Available only when the input source is encoded in the DTS-ES Discrete format.

*5 The DTS-ES Matrix listening mode is enabled when the input source is encoded in the DTS-ES Matrix format. When the input source is in DTS format but other than 6.1ch, and the surround setting for “DTS-ES” is set to “On,” the DTS-ES+Neo:6 listening mode is enabled.

Listening to Radio Broadcasts

One of the features of the TX-NR801/TX-NR801E that is most frequently used is its ability to play FM and AM broadcast radio stations. The TX-NR801/TX-NR801E provides a number of listening modes perfect for listening to the radio and getting the most out of your audio system. Also, by presetting radio stations that you listen to frequently, you can select them easily by pressing the CH +/- button on the remote controller.

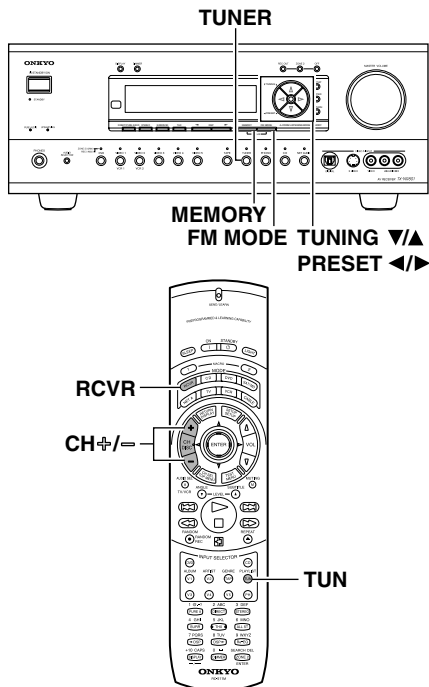

Tuning Into a Radio Station

1



Press the TUNER input source button.

Each time you press the TUNER button, the input source changes between AM and FM.

2

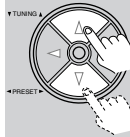

Using the TUNING ▼ and ▲ buttons on the front panel, tune into the station you desire.

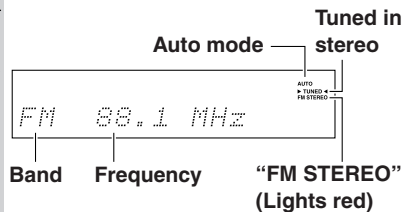

- The tuner frequency changes in 100 kHz (50 kHz) increments for FM and 10 kHz (or 9 kHz) increments for AM.
- You can press the TUNING ▼ or ▲ button continuously for more than 0.5 seconds to scan for an FM station in the direction of the button you pressed (FM auto tuning mode). After you release the button and a station is received in stereo, the scanning stops.
- The European model allows you to receive RDS broadcasts. See pages 48 and 49 for more information regarding tuning into RDS broadcasts.

Listening to a stereo radio station (FM mode)

FM MODE



When you tune into a radio station,

▶ TUNED ◀ indicator appears in the display. If you tune into an FM station in stereo, then “FM STEREO” appears. If the signal is weak, it may be impossible to tune into the station in stereo. In such a case, **press the FM MODE button** on the front panel. The AUTO indication disappears and the radio station is output in the monaural mode. To return to stereo, press the FM MODE button again. “AUTO” appears. Some inter-station noise may be heard, but the sound will not cut in and out as it would if stereo was selected.



Presetting a Radio Station

Up to 40 stations can be stored in memory as preset radio stations.

1	<p>Tune into the radio station you desire (See “Tuning Into a Radio Station”).</p> <p style="text-align: center;">FM 88.1 MHz</p>
2	<p>Press the MEMORY button on the front panel.</p> <p style="text-align: right;">Flashes</p> <p style="text-align: center;">FM 88.1 MHz </p>
3	<p>Using the PRESET ◀▶ buttons, select a preset number (from 1 to 40) to assign the station.</p>
4	<p>Press the MEMORY button to finalize the procedure.</p> <p style="text-align: right;">Lights</p> <p style="text-align: center;">FM 88.1 MHz 7</p> <p>You can enter text names for any of the preset radio stations (See page 52).</p>

Switching the display

While listening to or watching an input source, you can display information regarding the type of source and signal being input.

<p>TX-NR801/ TX-NR801E</p> <p></p> <p>Remote controller</p> <p>+10 CAPS</p> <p></p>	<p>Press the DISPLAY button on the TX-NR801/TX-NR801E or the remote controller.</p>
---	---

When the station have no name:



FM/AM frequency + Preset no.	FM 88.10MHz 1
	↑↓
FM/AM + Listening mode	FM Stereo

When the station have a custom name:



Name + Preset no.	Onkyo 1
	↑↓
FM/AM + Frequency + Preset no.	FM 88.10MHz 1
	↑↓
FM/AM + Listening mode	FM Stereo

Selecting a preset radio station

When using the TX-NR801/TX-NR801E:

1	<p> Press TUNER input source button on the TX-NR801/TX-NR801E. The front display should show the currently selected frequency.</p>
2	<p> Press the PRESET ◀▶ buttons and select the number of the desired preset station.</p>

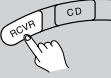
When using the remote controller:

1	<p> Press the RCVR MODE button. The RCVR MODE button lights.</p>
2	<p> Press the TUN button.</p>
3	<p> Press the CH +/- button and select the number of the desired preset station.</p>

Erasing a preset radio station

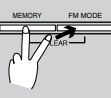
1	<p> Press the TUNER input source (or TUN) button and press the PRESET ◀▶ buttons to select the preset radio station that you want to erase (See above).</p> <p style="text-align: center;">FM 88.1 MHz 7</p>
2	<p> Press and hold the MEMORY button and then press the FM MODE button. The selected preset station is erased.</p>

Listening to RDS Broadcasts (European models only)

Listening to RDS Broadcasts

RDS reception is available only on the European model and only in areas where RDS broadcasts are available.

What is RDS?

RDS stands for Radio Data System and is a type of FM broadcasting. RDS was developed within the European Broadcasting Union (EBU) and is available in most European countries. Many FM broadcasting stations now transmit the RDS signals, which provide the additional information required. RDS provides you with various services so that you can choose a station that broadcasts your favorite categories of music, news, or other information.

There are three main classifications of RDS broadcasts. Though they can be tuned into by using the Tuning buttons as normal stations, RDS broadcasts allow you to scan for stations of the type and classification for which you are looking. This makes it much easier for you to find the station you want (See “Performing a PTY Scan” and “Performing a TP Scan” on page 49). The three main classifications are explained below.

RT: Radio Text

When an RDS station broadcasting RT information is selected, the text information received from the station is displayed.

PTY: Program Type

When an RDS station broadcasting PTY information is selected, the station type (classification) is displayed.

TP: Traffic Program

When an RDS station broadcasting TP information is selected, traffic information will be broadcasted periodically.

Notes:

- In some cases, the characters displayed on the display of the TX-NR801E may not be exactly the same as the ones broadcast by the radio station. Also, unusual characters may appear on the display if the TX-NR801E receives characters that cannot be displayed correctly. This is not a malfunction.
- When an RDS station broadcasting PS information is selected, the name of the station is displayed instead of the frequency.

PTY Program Types in Europe

The text given in parenthesis is what is actually displayed on the TX-NR801E.

None (NONE):

No program type.

News reports (NEWS):

Reports on current events and happenings.

Current affairs (AFFAIRS):

Topical reporting of current affairs, often with a wider range of topics than news reports.

Information (INFO):

General information such as weather forecasts, consumer affairs, medical help, etc.

Sports (SPORT):

Live sports action, sports news, and interviews.

Education (EDUCATE):

Formal educational programs.

Drama (DRAMA):

Radio plays and serials.

Culture (CULTURE):

Cultural programs (including religious affairs).

Science and technology (SCIENCE):

Programs about the natural sciences and technology.

Varied (VARIED):

Speech-based programs not covered by the above categories (e.g., quizzes, panel games, and comedy).

Pop music (POP M):

Popular commercial music, usually from past or present sales charts (e.g., Top 40).

Rock music (ROCK M):

Popular music with an alternative appeal, often not appearing on sales charts.

Middle of the road music (M.O.R. M):

Easy listening music (as opposed to Pop, Rock, or Classical).

Light classics (LIGHT M):

Classical music for general rather than specialist appreciation.

Serious classics (CLASSICS):

Performances of major orchestral works, symphonies, chamber music, etc. (including Grand Opera).

Other music (OTHER M):

Music styles not covered by the above categories (e.g., Jazz, Rhythm & Blues, Folk, Country, and Reggae).

Alarm (ALARM):

When an RDS station is making an emergency broadcast, this ALARM will flash on the display.

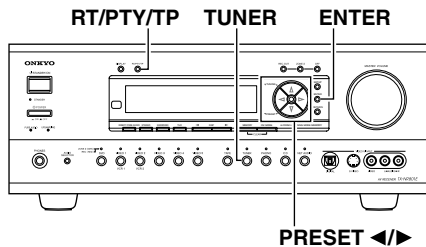

Displaying Radio Text (RT)

If the station you are currently tuned into is broadcasting RT signals, they will be displayed in the front display on the TX-NR801E. If the station does not, this function will be ignored.



To display the radio text, press the RT/PTY/TP button once.

- If the current station you are listening to is not an RDS station, only the frequency of the station will appear.
- If “Waiting” appears on the display, more time is required to receive the RT information. When the information is received, the characters will scroll across the front display.
- If “No Text Data” appears on the display, RT information is not available.
- The display shows the frequency for 3 seconds and returns to program service name.

Performing a PTY Scan

1



Press the TUNER input source button and select the FM input source.

2



Press the RT/PTY/TP button twice. The current program type appears on the display.

ROCK M

3



Using the PRESET ◀▶ buttons, select the PTY program type you desire.

LIGHT M

4



Press the ENTER button.

The TX-NR801E will scan until it reaches a station of the program type you selected. It will then stop briefly at that station before continuing on until it reaches the next station. Pressing the ENTER button stops the PTY scan at that point. If you press the RT/PTY/TP while “NONE” is displayed, “PTY ?” will appear. In this case, return to step 3.

5



Press the ENTER button when it reaches the station that you want to listen to.

“Not Found” will appear when no RDS signal is being received from the station.

Performing a TP Scan

1



Press the TUNER input source button.

2



Press the RT/PTY/TP button three times.

TP

“[TP]” will appear if the current station is broadcasting TP signals. This station will periodically broadcast traffic information. To find a different station, proceed to the next step. Also, if “TP” is displayed, proceed to the next step.

3



Press the ENTER button.

The TX-NR801E will scan until it reaches a station broadcasting traffic information. If “Not Found” appears on the display, a TP station cannot be located.

Recording a Source

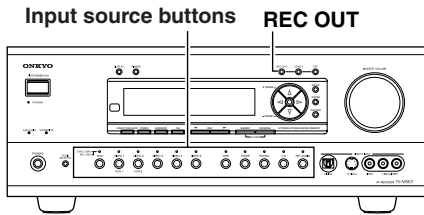

To Record the Input Source Signal You are Currently Watching/Listening

This method outputs to the audio and video outputs the currently selected input source signal. This method allows you to record a signal while you are actually listening to or watching it.

- 1**

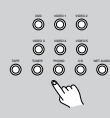

Select the input source to record by pressing the corresponding input source button.

The input source is now selected and you may watch or listen to it as desired.
- 2**



Press the REC OUT button repeatedly until “Rec Sel:SOURCE” appears in the front display.

The signal from the currently selected input source is now output to the TAPE OUT, VIDEO 1 OUT, and VIDEO 2 OUT outputs for recording.

RecSel: SOURCE
- 3**



Start recording at the recording component as desired.

To confirm the settings, press the REC OUT button. The current settings will appear for 8 seconds in the front display.

Notes:

- If you change the input source during recording, you will record the signals from the newly selected input source.
- You cannot record the surround effects.
- Digital signals input to the DIGITAL IN (COAX) and DIGITAL IN (OPT) inputs will be output to the DIGITAL OUT (OPT) output. However, MP3, WMA, WAV, and other music formats played using Net Audio are only output as analog audio.
- Digital input signals are only output to the digital outputs and analog input signals are only output from the analog outputs. There is no conversion from digital to analog or vice versa. When connecting CD players and other digital components, do not connect only the digital terminals, but the analog ones as well.
- There are some restrictions on recording digital signals. When making digital recordings, consult the

instruction manual that came with your digital recording equipment (e.g., MD recorder or DAT deck) to know what restrictions are imposed.

- You cannot record the source connected to the MULTI CH INPUT connector.
- When listening to music in the remote zone, you can record the music or video that is being played in the main zone.
- If you select FM (or AM) with the TUNER input source button when the recording source is set to AM (or FM), the output for the recording source also changes to AM (or FM).

To Record an Input Source Signal Different from that You are Currently Watching/Listening

Follow the procedure given below to record an input source signal different from that which you are listening to or watching at the time of recording.

- 1**

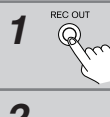

Press the REC OUT button.
- 2**

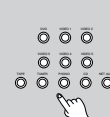

Within 8 seconds, press the input source selector button of the input source signal that you wish to record.

The signal from the selected input source is now output to the TAPE OUT, VIDEO 1 OUT, and VIDEO 2 OUT outputs for recording.

RecSel: VIDEO3
- 3**

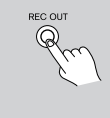

Start recording at the recording component as desired.

To confirm the settings, press the REC OUT button. The current settings will appear for 8 seconds in the front display.

Notes:

- Be aware that the remote (Zone 2) and recording (REC OUT) outputs use the same circuit and therefore cannot be used at the same time.
- You cannot record the surround effects.
- Digital signals input to the DIGITAL IN (COAX) and DIGITAL IN (OPT) inputs will be output to the DIGITAL OUT (OPT) outputs.
- There are some restrictions on recording digital signals. When making digital recordings, consult the instruction manual that came with your digital recording equipment (e.g., MD recorder or DAT deck) to know what restrictions are imposed.
- You cannot record the source connected to the MULTI CH INPUT connector.
- You cannot listen to a broadcast from one station while recording the broadcast from another.

Recording the Video from One Source and the Audio from Another



You can add the sound from one source to the video of another source to make your own video recordings.

Below is an example of recording the sound from a compact disc player connected to CD IN and the video from a video camera connected to VIDEO 5 INPUT to video cassette tape in a video cassette recorder connected to the VIDEO 1 OUT jack.

The illustrations used here represent the TX-NR801/ TX-NR801E.

Notes:

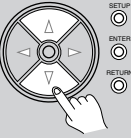
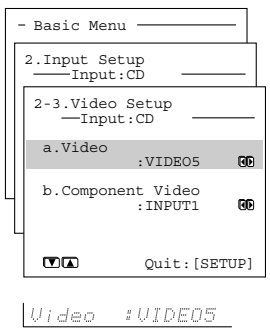
- If you change the input source during recording, you will record the audio signals from the newly selected input source and the video signals assigned to that input source.
- You cannot record the surround effects.

<p>1</p> 	<p>Press the CD input source button.</p>
<p>2</p> 	<p>Set "VIDEO 5" for the Video setting in the Video Setup sub-menu of the Setup menu: Input Setup → Video Setup → Video.</p> 
<p>3</p>	<p>Insert a CD in the CD player and insert a tape in the video camera connected to the VIDEO 5 INPUT.</p>
<p>4</p>	<p>Insert a video tape for recording in the video cassette recorder connected to VIDEO 1 OUT.</p>
<p>5</p> 	<p>Press the REC OUT button repeatedly until "Rec Sel:SOURCE" appears in the front display. Now "CD" has been selected as the audio input source and "VIDEO 5" as the video input source.</p>
<p>6</p>	<p>Start recording on the video cassette recorder and start playing at the CD player and video camera as desired.</p>

Input Setup (Basic)

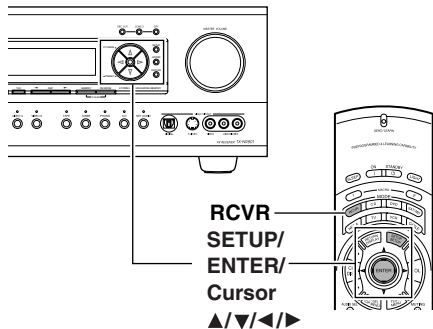

Labelling the Input Source (Character Input)

This sub-menu allows you to give names to the stations you have preset for the AM/FM tuner, and to the input sources you have connected (excluding the tuner itself). Up to 10 characters can be entered for each name. For example, if you have a DVD connected to the VIDEO4 jack, then you can give it the name "DVD2." Or, if you have multiple VCRs connected, you can enter the model names or manufacturer names for each one so that you do not have to remember which is connected to which input source.

The illustrations used here represent the remote controller. When you perform the procedures on the TX-NR801/TX-NR801E, use the corresponding buttons on the front panel.

1 First, press the RCVR button, and then press the INPUT SELECTOR button.

If you want to enter a name for a preset broadcast radio station, select the station that you want to name and enter the name.

2 Press the SETUP button to display the main menu on the monitor and front display.

```

- Basic Menu -
0. Hardware Setup
1. Speaker Setup
2. Input Setup
3. Audio Adjust

-Advanced Menu

[ENTER] Quit: [SETUP]
    
```

3 Use the ▲ and ▼ cursor buttons to select "2. Input Setup" and then press the ENTER button. The "Input Setup" menu appears.

```

2. Input Setup
-Input: DVD

1. Digital Setup
2. Multichannel Setup
3. Video Setup
4. Character Input
5. IntelliVolume

[ENTER] Quit: [SETUP]
    
```

2. Input Setup

4 Use the ▲ and ▼ cursor buttons to select "Character Input" and then press the ENTER button. The "Character Input" menu appears.

```

2-4. Character Input
-Input: DVD

a. Character Display :No
b. Character :

Press 0 to edit.
0 to clear.

[ENTER] Quit: [SETUP]
    
```

Character?

5 Use the ▲ and ▼ cursor buttons to select "a. Character Display" and then use the ◀ and ▶ cursor buttons to set "Yes."

```

2-4. Character Input
-Input: DVD

a. Character Display :Yes
b. Character :

Press 0 to edit.
0 to clear.

[ENTER] Quit: [SETUP]
    
```

Char Disp :Yes

Yes: Select to have your custom name displayed.

No: Select to have the default name displayed.

6 Use the ▲ and ▼ cursor buttons to select "b. Character."

Press the ◀ cursor button to clear the current entry.

Press the ▶ cursor button to bring up the Character Input screen.

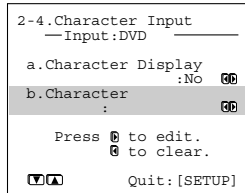

|Character

7

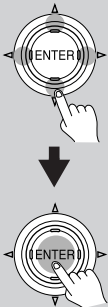

Use the ▲/▼/◀/▶ buttons to move the cursor to the desired character and then press the ENTER button.

The characters entered will appear in order in the 10-character space field above.

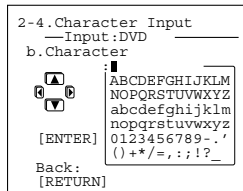

|ABCDEFGHIJKLM

Note:

If you are using the front display and not the OSD Menu, press the ▶ button when “Char: ” appears in the front display. Then “ABCDEF.” appears. This is the Character Input screen. The cursor buttons will allow you to navigate through this screen just as they would if you were using the OSD Menu so you will need to refer to the figure below for the actual layout of the Character Input screen.

At the Character Input screen, press the cursor buttons to move the cursor to the desired character and then press the ENTER button. The characters entered will appear in order in the 10-character space field above. After two seconds, the Character Input screen appears again.

To change an existing character, move the cursor backward with the RETURN button or forward with the ENTER button to the location of the mistaken character and then enter the desired character as explained above.

To erase a character, enter a blank space in its place.

8

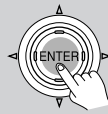

After you have completed the name, press the ENTER button until you return to the Character Input Sub-menu.

Once 10 characters are entered, you will automatically return to the previous screen. If the name is completed before you enter 10 characters, enter spaces until 10 characters are entered.

Adjusting the Volume Differences Between Components (IntelliVolume)

This sub-menu allows you to adjust for the volume differences between your various input source components. When switching input sources, you may find that the output level for different components or input sources connected to the TX-NR801/TX-NR801E is different even though the main volume setting is the same. Under normal circumstances, you would then have to change the volume setting each time you change the input source. This Intelli Volume setting allows you to preset a volume level for each input source separately so that when you do switch from one input source to another, the TX-NR801/TX-NR801E adjusts the volume accordingly and the volume stays the same.

1-3

Use the same procedures as the ones for the “Character Input” sub-menu to display the “Input Setup” sub-menu.

4

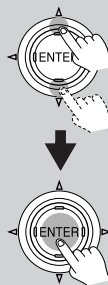

Use the ▲ and ▼ cursor buttons to select “IntelliVolume” and then press the ENTER button.

The “IntelliVolume” menu appears.

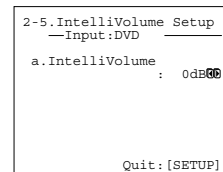

|IntelliVolume?

5



Use the ◀ and ▶ cursor buttons to set the desired value.

If the volume is quieter than other sources, increase its decibel level with the ▶ cursor button, or if it is louder than other sources, decrease its decibel level with the ◀ cursor button. The Intelli Volume can be adjusted between -12 and +12 decibels.

6



Press the SETUP button to return to the main menu.

Audio Adjust (Basic)

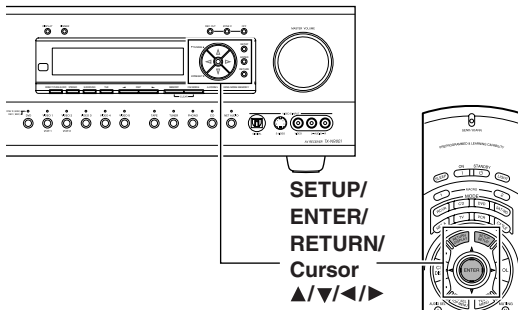

The “Audio Adjust” menu allows you to specify detailed settings for the audio signal. This section explains the basic settings for audio effects.

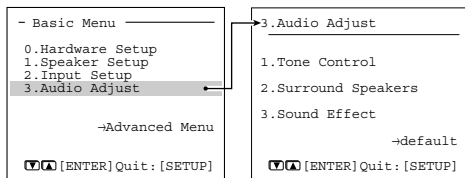

3. Audio Adjust

If you want to perform these operations using the remote controller, first press the RCVR button.

- 1 Display the main menu.**
Press the SETUP button on the front panel or SETUP button on the remote controller to display the main menu on the monitor and front display.
- 2 Use the ▲ and ▼ cursor buttons to select “3. Audio Adjust” and then press the ENTER button.**
The “Audio Adjust” menu appears.
- 3 Use the ▲ and ▼ cursor buttons to select an item and then press the ENTER button.**
- 4 Use the ▲ and ▼ cursor buttons to select an item and then use the ◀ and ▶ cursor buttons to set the desired value.**
- 5 Press the SETUP button to exit.**

Adjusting the Bass and Treble Sound (Tone Control)

This sub-menu allows you to adjust the bass and treble sounds.



Tone Control?

a. Bass

The Bass can be adjusted between -12 and +12 in 2-step increments.

The Bass adjustment is only enabled for the front left, center, front right, and subwoofer speakers.

b. Treble

The Treble can be adjusted between -12 and +12 in 2-step increments.

The Treble adjustment is only enabled for the front left, center and front right speakers.

Selecting Surround Speakers to Output the Sound (Surround Speakers)

This sub-menu allows you to decide which speakers to output to when you are playing back a 5.1 channel source with surround back speakers connected.

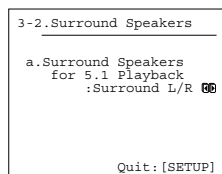

Surround Speakers?

a. Surround Speakers for 5.1 playback

Surround L/R: Select to output the sound to the surround left and right speakers as normal and output nothing to the surround back speaker.

Surround Back: Select to output the sound to the surround back speakers and output nothing to the surround left and right speakers.

Surr L/R+Back: Select to output the sound to both the surround left and right speakers and the surround back speaker.

Setting the Various Sound Effects (Sound Effect)

This sub-menu is used to turn on and off the various sound effects available with the TX-NR801/TX-NR801E.

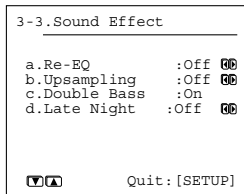

Sound Effect?

a. Re-EQ

Re-EQ (re-equalization) takes the edginess or “brightness” out of your home cinema sound to compensate for the fact that sound mixed for theaters may sound too bright when played back through speakers in the home environment.

This can be set to either “On” or “Off.”

You can use the Re-EQ button on the remote controller for setting “On” or “Off.”

b. Upsampling

Upsampling processes the input digital signal, or the digital signal converted from an analog input source, and converts its digital sampling frequency to twice its current frequency for an even further detailed sound reproduction. This can be set to either “On” or “Off.” When “On” is selected, the **UPSAMPLING indicator** lights.

c. Double Bass

The Double Bass function boosts the bass sound by letting the bass sound of “Front” speakers output also from the subwoofer. To enable this function, in the “Speaker Config” menu, set the “Subwoofer” to “Yes” and “Front” to “Large.”

On: Select to turn on the Double Bass function.

Off: Select to turn off the Double Bass function.

Note:

Double Bass “Off” is the THX preferred setting for accurate bass reproduction.

d. Late Night

The audio for movies made for the cinema have a large dynamic range; thus, the difference between loud noises and soft noises is great. To hear the quieter sounds such as background noises or human conversations, the movie must be played back at higher volumes. When this setting is set to “High” or “Low,” the dynamic range of the sound is narrowed down to allow you to hear easily minute sounds at low volumes. This function is especially useful if you wish to play a movie at a low volume during the nighttime.

This can be set to either “Off” or “Low,” or “High.”

However, when the TX-NR801/TX-NR801E enters the standby state, this setting returns to the default setting (“Off”).

Notes:

- The Late Night function is effective only on Dolby Digital encoded software.
- The depth of the Late Night effect is determined by Dolby Digital software. With some sources, it may produce little or no effect.

Settings possible for each listening mode (3-1. 3-2. 3-3. Sub-menu)

Setting	3-1. Tone Control		3-2. Surround Speakers		3-3. Sound Effect		
	a. Bass	b. Treble	a. Surround Speakers	a. Re-EQ	b. Upsampling*2	c. Double Bass	d. Late Night*3
Listening mode							
Mono	✓			✓*5		✓	✓
Direct/Pure Audio							
Stereo	✓			✓	✓	✓	✓
Theater-Dimensional	✓					✓	✓
DTS	✓		✓	✓		✓	
DTS-ES Matrix	✓			✓		✓	
DTS-ES Discrete	✓			✓		✓	
DTS 96/24	✓		✓	✓		✓	
Dolby Digital	✓		✓	✓		✓	✓
Dolby Digital EX	✓			✓		✓	✓
PLII Movie/PLII Music	✓		✓	✓*1	✓	✓	✓
DTS Neo:6 Cinema/Music	✓			✓*1		✓	✓*4
THX Cinema (PLII)			✓	✓		✓	✓
THX Cinema (Neo:6)				✓		✓	✓*4
THX Cinema (DTS-ES)				✓		✓	
THX Surround EX				✓		✓	✓*4
Mono Movie	✓		✓			✓	✓
Enhance	✓					✓	✓
Orchestra	✓		✓			✓	✓
Unplugged	✓		✓			✓	✓
Studio-Mix	✓		✓			✓	✓
TV Logic	✓		✓			✓	✓
All CH Stereo	✓			✓		✓	✓

*1 Enabled for Dolby Pro Logic II Movie and DTS Neo:6 Cinema input sources.

*2 Takes effect when playing an analog/PCM source in any of the listening modes marked with “✓.”

*3 Takes effect when playing a Dolby Digital source in any of the listening modes marked with “✓.”

*4 Enabled only when the input is a Dolby Digital 2 channel source.

*5 Enabled when the “Academy Filter” function is set to “Off.”

Input Setup (Advanced)

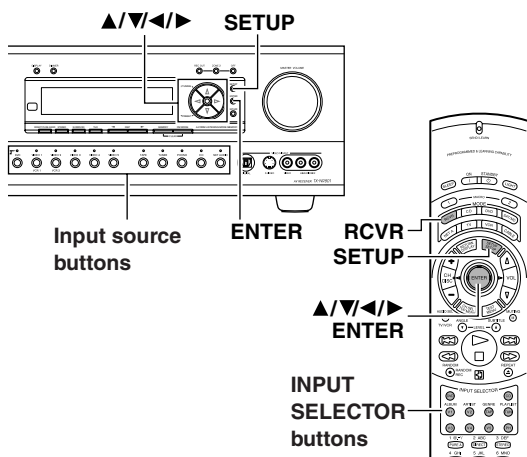

Configuring the Listening Modes You Use Frequently (Listening Mode Preset)

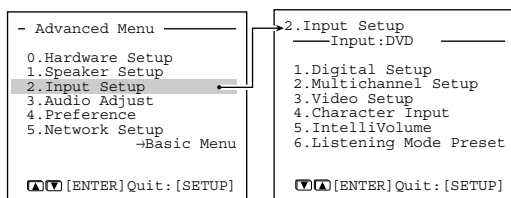

2. Input Setup

With the TX-NR801/TX-NR801E, you can set a different listening mode for each different signal type that comes from each input source. For example, if your DVD player also plays compact discs and the DVD video signal is Dolby Digital and the compact disc signal is PCM, then you can set a different listening mode for each.

This is especially convenient if you frequently play the same types of movies or music.

Once the TX-NR801/TX-NR801E enters the standby state, the listening mode returns to the mode set at “Listening Mode Preset,” even after you changed the listening mode to a different listening mode while playing.

The illustrations used here represent the remote controller. When you perform the procedures on the TX-NR801/TX-NR801E, use the corresponding buttons on the front panel.

- 1 First, press the RCVR button, and then press the INPUT SELECTOR button.**

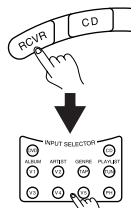

- 2 Press the SETUP button to display the main menu on the monitor and front display.**

When the “Basic Menu” is displayed, select “→Advanced Menu” using the ▲ and ▼ cursor buttons and press the ENTER button to display the “Advanced Menu.”

- 3 Use the ▲ and ▼ cursor buttons to select “2. Input Setup” and then press the ENTER button.**

The “Input Setup” menu appears.

- 4 Use the ▲ and ▼ cursor buttons to select “Listening Mode Preset” and then press the ENTER button.**

The “Listening Mode Preset” menu appears.

- 5 Use the ▲ and ▼ cursor buttons to select an input source signals and then use the ◀ and ▶ cursor buttons to set the desired listening modes.**

- If you set “Last Valid” as the listening mode preset, the last listening mode used for the current input source type will be used automatically when the same input source type is selected to output next time.

- 6 Press the SETUP button to return to the main menu.**

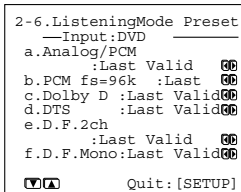

Listening Mode Preset?

a. Analog/PCM

Analog sources consist of LP records, FM and AM broadcasts, cassette tapes, and the like. PCM (Pulse Code Modulation) is one form of digital audio signal and is recorded directly onto compact discs and DVDs without compression.

Available listening modes for “Analog/PCM” are Stereo, T-D, PL II/Neo:6, THX, Mono Movie, Enhance, Orchestra, Unplugged, Studio-Mix, TV Logic, All Ch Stereo, Mono, Pure Audio, and Direct.

b. PCM fs=96k

Digital PCM sources recorded with a sampling rate of 96 kHz. Available listening modes for “PCM fs=96k” are Stereo, PL II, Pure Audio, and Direct.

c. Dolby D (Dolby Digital)

Digital data with AC-3 compression and a maximum of 5.1 channel surround sound. This source signal comes from DVDs and LDs that have the  mark and therefore are recorded for 5.1 channel output.

Available listening modes for “Dolby D” are Dolby D, THX, Enhance, Orchestra, Unplugged, Studio-Mix, TV Logic, Stereo, and T-D.

d. DTS

DTS (Digital Theater System) is compressed digital data with a maximum 5.1 channel surround output (6.1 channel with DTS-ES Discrete sources) that allows for an extremely high-quality sound. This source signal requires a DVD player that supports DTS output and comes from DVDs, compact discs, and LDs that have the  mark.

Available listening modes for “DTS” are DTS, THX, Enhance, Orchestra, Unplugged, Studio-Mix, TV Logic, Stereo, and T-D.

e. D.F. 2 ch (Digital Format 2 channel)

2 channel digital signals (not including PCM) such as Dolby Digital. DVDs or LDs recorded with 2 channel sound may be this type of input signal.

Available listening modes for “D.F. 2 ch” are PL II/Neo:6, THX, Mono Movie, Enhance, Orchestra, Unplugged, Studio-Mix, TV Logic, All Ch Stereo, Mono, Stereo, and T-D.

f. D.F. Mono (Digital Format Monaural)

Monaural digital signals (not including PCM) such as Dolby Digital. DVDs or LDs recorded with monaural sound may be this type of input signal.

Available listening modes for “D.F. Mono” are Mono and Mono Movie.

The “Audio Adjust” menu allows you to specify detailed settings for the audio signal. This section explains the advanced settings for audio effects.

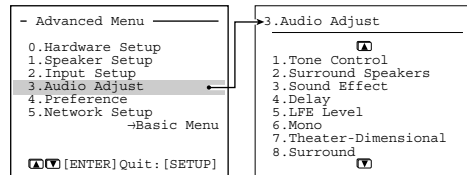

3. Audio Adjust

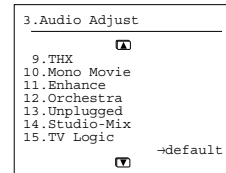

If you want to perform these operations using the remote controller, first press the RCVR button.

1 Display the main menu.

Press the SETUP button on the front panel or SETUP button on the remote controller to display the main menu on the monitor and front display. When the “Basic Menu” is displayed, select “→Advanced Menu” using the ▲ and ▼ cursor buttons and press the ENTER button to display the “Advanced Menu.”

2 Use the ▲ and ▼ cursor buttons to select “3. Audio Adjust” and then press the ENTER button.

The “Audio Adjust” menu appears.

3 Use the ▲ and ▼ cursor buttons to select an item and then press the ENTER button.

4 Use the ▲ and ▼ cursor buttons to select an item and then use the ◀ and ▶ cursor buttons to set the desired value.

5 Press the SETUP button to exit.

Press the RETURN button to return to the previous menu.

Adjusting the Audio Delay (Delay Sub-menu)

This sub-menu gives you various ways to adjust the timing of the audio output from the speakers to give certain soundfield effects or to adjust for unwanted asynchronous video and audio tracks.

This sub-menu does not appear if “Direct” is selected as the listening mode.

This setting is not available when you select “Multichannel.”

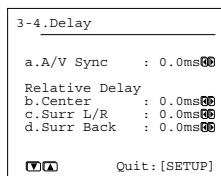

Delay?

a. A/V Sync

If a digital signal processor is connected, there may be times when the audio and video from a DVD or LD player is not output in perfect sync. The result is where the sound and picture do not match and the sound is heard too early. In such a case, use this setting to properly synchronize the audio and video. This setting can be set between 0 and 74.0 ms in 0.5 ms increments. Under normal circumstances, this can be left at 0 ms. If the delay time is set between 24.5 and 74.0 ms, and upsampling is used, the delay will be fixed at 24.0 ms. Note that a change in the setting will not be displayed.

Relative Delay

b. Center, c. Surr L/R, d. Surr Back

Besides level and delay adjustments, this setting provides the ability to change or adjust the relative speaker position to fine tune the soundfield for the listener. This is accomplished using Onkyo's unique Enhanced Spatial Positioning Algorithm. This adjustment provides 10 milliseconds of delay for the speakers, which is equivalent to moving the speaker 10 feet (3 meters) away. This adjustment is set up to provide -4.0 or +6.0 milliseconds (-4 or +6 feet/-1.2 or +1.8 meters) of adjustment to the listener's position.

Once the coarse adjustments (i.e., speaker level and distance adjustments) are made, the system is set up to provide a typical or broad surround environment. By adjusting the relative position of the speakers, we are able to alter the soundfield to be more spread out (deeper) or focused (shallower).

Note:

Surr Back cannot be selected if the Surr Back/Zone 2 setting in the Surr Back/Zone 2 Sub-menu of the Hardware Setup Menu is set to "Zone 2."

Setting the Low Frequency Effect Levels (LFE Level)

This sub-menu is for setting the LFE (Low Frequency Effect) levels included in Dolby Digital and DTS software.

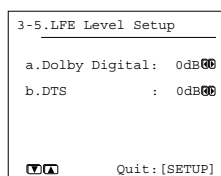

LFE Level?

a. Dolby Digital

The level can be adjusted to either $-\infty$ or between -10 and 0 decibels in 1 decibel increments. For Dolby Digital input source signals, the LFE level set here is used. A setting of 0 decibels is recommended for optimum performance; however, if the source is recorded with the low frequency range too strong, lower this setting as necessary.

b. DTS

The level can be adjusted to either $-\infty$ or between -10 and 0 decibels in 1-decibel increments. For DTS input source signals, the LFE level set here is used. A setting of 0 decibels is recommended for optimum performance; however, if the source is recorded with the low frequency range too strong, lower this setting as necessary.

Detailed Settings for Each Listening Mode

Mono Sub-menu

The settings of this sub-menu shown below are enabled when the listening mode is set to "Mono."

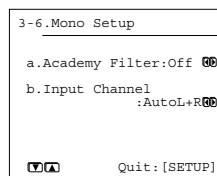

Mono?

a. Academy Filter

Older monaural film mixes relied on high-frequency rolloff in presentation to sound properly balanced, so that excessive hiss from the grain structure of the film would not be heard. The high-frequency loss was typically due to a combination of optical slit loss, electrical filters, loudspeaker response, and screen loss. Some films have been transferred to video without such a high-frequency rolloff, and thus sound overly bright and hissy. The TX-NR801/TX-NR801E includes this "Academy Filter," which is based on contemporary playback practices for such films over wide-range systems.

This can be set to either "On" or "Off."

b. Input Channel

This allows you to set which input channel to use for monaural sound.

Auto L+R: Select this under normal circumstances. When the input source is center channel, this center channel is used as the monaural sound input channel. Otherwise, the left and right channels are mixed and the mixed signal is used as the monaural sound input channel.

Left/Right: You will need to select either left or right when playing a video source that contains bilingual data. In such a case, the left and right channels will contain the audio for different languages. Select the channel with the language you desire.

Theater-Dimensional Sub-menu

Select this to modify the Theater-Dimensional (T-D) listening modes.

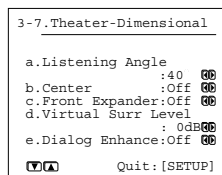

T-D?

a. Listening angle

The listening angle is the angle subtended by the front left and right speakers as seen from the listener. The processing for the virtual surround will be based on this angle. The setting of 20 and 40 degrees are only for nominal purposes, so select the setting that is closest to your actual listening angle.

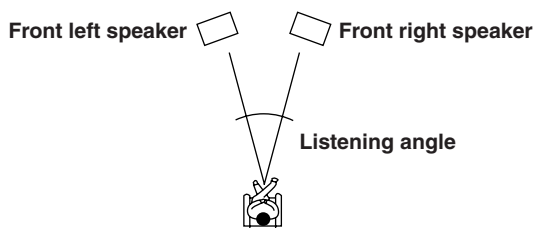

b. Center

In the Theater-Dimensional mode, if the speaker system has a center speaker, the center channel signal can be output from the center speaker. For instance, in systems where the front left and right speakers are small, use of the center speaker may provide a better sound space and reduce the load on the front speaker. (For the proper soundfield, it is important that the speaker levels and speaker distances among the front right, front left, and center speakers are matched. In order to ensure this, make sure that the settings in the Speaker Distance Sub-menu and Level Calibration sub-menu are set correctly.)

On: Select to have the center channel signal output to the center speaker.

Off: Select to have the center channel signal output to the front left and right speakers (Phantom Center).

c. Front Expander

The front expander function spreads out the stereo image in front of the listener. The created stereo image is as if the front speakers have been farther apart for the feeling of a wide sound space. This is especially useful for narrow listening angles of 20 degrees or less.

On: Select to turn on the front expander function to simulate a wider sound space.

Off: Select to turn off the front expander function for a normal sound space.

d. Virtual Surr Level

This setting adjusts the level of the virtual surround signal. This can be set from -3 to +3 decibels. Lowering this setting can improve the sound when the definition is unclear or when the sound feels unnatural.

e. Dialog Enhance

If the dialog from the center channel is difficult to hear in the Theater-Dimensional mode, use this setting to improve the clarity.

On: Select to enhance the vocal ranges of the center channel signal.

Off: Select to output the center channel signal at the regular level and frequency characteristics.

Surround Sub-menu

This sub-menu provides various settings for modifying the plain Dolby Digital, DTS, and Pro Logic II Surround listening modes.

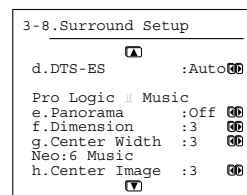
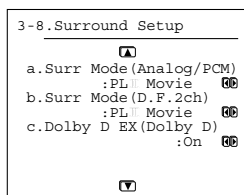

Surround?

a. Surr Mode (Analog/PCM)

Changes the surround mode for when 2 channel analog/PCM signals are input.

PLII Movie: Select when you want to enable the Dolby Pro Logic II Movie listening mode.

PLII Music: Select when you want to enable the Dolby Pro Logic II Music listening mode.

Neo:6 Cinema: Select when you want to enable the DTS Neo:6 Cinema listening mode.

Neo:6 Music: Select when you want to enable the DTS Neo:6 Music listening mode.

You can also easily change the Surr Mode settings using the remote controller. While playing the analog or PCM source, press the SURROUND button on the remote controller. Each press of the button cyclically changes the listening modes in the order of "PLII Movie," "PLII Music," "Neo:6 Cinema," and "Neo:6 Music."

b. Surr Mode (D.F.2ch)

Changes the surround mode for when 2 channel digital signals are input.

PLII Movie: Select when you want to enable the Dolby Pro Logic II Movie listening mode.

PLII Music: Select when you want to enable the Dolby Pro Logic II Music listening mode.

Neo:6 Cinema: Select when you want to enable the DTS Neo:6 Cinema listening mode.

Neo:6 Music: Select when you want to enable the DTS Neo:6 Music listening mode.

You can also easily change the Surr Mode settings using the remote controller. When you play 2ch digital source other than PCM (ex., the source in Dolby Digital format), each press of the SURROUND button on the remote controller cyclically changes the listening modes in the order of "PLII Movie," "PLII Music," "Neo:6 Cinema," and "Neo:6 Music."

c. Dolby Digital EX (Dolby D)

If you have surround back speakers connected, use this setting to select whether or not you will use Dolby EX playback.

Auto: When the source has an EX flag (ID signal for Surround EX), the playback is automatically changed to Dolby Digital EX. If the source has no EX flag, the playback is changed to Dolby Digital.

On: The playback is set to Dolby Digital EX.

Off: The playback is set to normal Dolby Digital.

If your surround channel is monaural or you do not have a surround channel, then the playback will be normal Dolby Digital regardless of the above setting.

You can easily change the Dolby Digital EX mode settings using the remote controller. While playing a Dolby Digital source, after displaying the current listening mode with a press of the SURROUND button, each press of the SURROUND button on the remote controller cyclically changes the Dolby Digital EX mode in the order of “Auto,” “On,” and “Off.”

d. DTS-ES

This setting selects the DTS-ES mode.

Auto: Select to have the listening mode change automatically to DTS-ES Discrete or DTS-ES Matrix when the DTS source has the DTS-ES flag (ID signal for DTS-ES). If the DTS source has no DTS-ES flag, the mode is changed to DTS 5.1.

On: Select to have the listening mode change automatically to DTS-ES Discrete or DTS-ES Matrix when the DTS source has the DTS-ES flag, and to DTS + Neo:6 when the DTS source has no DTS-ES flag.

Off: Select to not use DTS-ES listening modes even when the DTS source has the DTS-ES flag. With this setting, the DTS sources are always played in DTS 5.1 mode.

You can also easily change the DTS-ES mode settings using the remote controller. While playing a DTS source, after displaying the current listening mode with a press of the SURROUND button, each press of the SURROUND button on the remote controller cyclically changes the DTS-ES mode in the order of “Auto,” “On,” and “Off.”

e. Pro Logic II Music Panorama

Use this setting to extend the front stereo image to include the surround speakers for an exciting wrap-around effect with side wall imaging.

On: Select to turn on the PL II Music Panorama mode.

Off: Select to turn off the PL II Music Panorama mode.

f. Pro Logic II Music Dimension

Use this setting to gradually adjust the soundfield forward or backward. It varies between 0 and 6 in steps of 1 and the default value is 3.

The setting of “3” is the normal position. Change the setting to “2” or lower to move the sound space forward and setting to “4” or higher to move the sound space backward. If the stereo recording has excessive broadness or a too strong surroundness, move the sound space forward to get the

appropriate sound balance. In contrast, if the stereo recording feels somewhat like monaural or has narrowness, move the sound space backward to get more surroundness.

g. Pro Logic II Music Center Width

In Pro Logic II decoding, center signals are output from the center speaker. When the center speaker is not used, the decoder will divide the center signal equally to both the front left and right speakers to create a “phantom” center sound image.

The Pro Logic II Music Center Width mode allows you to adjust from where the center sound image is heard. Using this, you can have the soundfield be heard from the center speaker only, from the front left and right speakers only (as a phantom center sound image), or from all three speakers (center, front left and right) in various level combinations. The soundfield varies between 0 and 7 in steps of 1 and the default value is 3. For home use, applying some width to the center signal will improve the level balance for the center and main speakers, and will effect the width of the center sound image, or “weight” of the sound. Many sound recordings processed for stereo playback will be reproduced better by proper control of this setting. The recommended setting for Pro Logic II Music mode is “3.” This allows you to easily distinguish the Pro Logic II Music mode from the Pro Logic II Movie mode whose setting is automatically set to “0.”

h. Center Image

DTS Neo:6 derives a center channel from 2 channel PCM and analog sources.

In the cinema mode, for Lt/Rt film soundtracks, sounds steered to the center are subtracted from the left and right channels.

In the music mode, the intent in the front channels is less one of steering and more one of stabilizing the front image by augmenting it with a center channel, while preserving the original perspective of the stereo mix. Therefore, the derived center is never fully subtracted from the left and right channels.

Center Image is the factor controlling the amount of subtraction. It varies between 0 and 5 in steps of 1 and the default value is 3.

When Center Image=5, the factor is zero and nothing is subtracted from the left and right channels. When Center Image=0, the center channel is subtracted from the left and right channels at half level (–6 dB) for each channel. The signal level sent to the center channel output is not affected by Center Image.

This control should be set based on room layout and personal preferences. A setting of 5 allows the left and right channels to pass through unaltered from the stereo mix. A setting of 0 gives more center channel dominance, which is particularly desirable if listeners are located well off-center. At any setting, the center speaker anchors the image.

Center Image is only enabled when the listening mode is DTS Neo:6 Music.

THX Sub-menu

This sub-menu allows you to set the settings that will be enabled when the THX listening mode is selected.

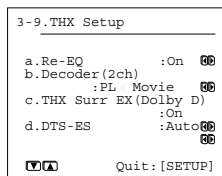

THX?

a. Re-EQ (THX)

Re-EQ (re-equalization) takes the edginess or “brightness” out of your home cinema sound to compensate for the fact that sound mixed for theaters may sound too bright when played back through speakers in the home environment.

This can be set to either “On” or “Off”.

You can use the Re-EQ button on the remote controller for setting “On” or “Off.”

This setting returns to the default setting (“On”) when the TX-NR801/TX-NR801E enters the standby state.

b. Decoder (2ch)

This setting allows you to select the decoding mode for THX processing.

PLII Movie: Select for Dolby Pro Logic II Movie.

Neo:6 Cinema: Select for DTS Neo:6 Cinema.

You can also easily change the Decoder mode settings using the remote controller. While playing the analog or PCM source, each press of the THX button on the remote controller switches the listening modes between “PLII Movie” and “Neo:6 Cinema.”

c. THX Surround EX (Dolby D)

This setting allows you to set whether or not Dolby Digital sources will be played back using THX Surround EX when a surround back speaker is connected.

Auto: Select to automatically output sources with EX-identifying signals using THX Surround EX.

On: Select to output using THX Surround EX regardless of whether or not the source contains EX identifiers.

Off: Select not to output using THX Surround EX regardless of whether or not the source contains EX identifiers (Dolby D is used).

You can also easily change the THX Surround EX mode settings using the remote controller. While playing a Dolby Digital source, after pressing the THX button, each press of the THX button on the remote controller cyclically changes the THX Surround EX mode in the order of “Auto,” “On,” and “Off.”

d. DTS-ES

This setting allows you to select the DTS-ES mode for THX processing.

Auto: Select to have the listening mode change automatically to DTS-ES Discrete or DTS-ES Matrix when the DTS source has the DTS-ES flag (ID sig-

nal for DTS-ES). If the DTS source has no DTS-ES flag, the mode is changed to DTS 5.1.

On: Select to have the listening mode change automatically to DTS-ES Discrete or DTS-ES Matrix when the DTS source has the DTS-ES flag, and to DTS + Neo:6 when the DTS source has no DTS-ES flag.

Off: Select to not use DTS-ES listening modes even when the DTS source has the DTS-ES flag. With this setting, the DTS sources are always played in DTS 5.1 mode.

You can also easily change the DTS-ES mode settings using the remote controller. While playing a DTS source, after pressing the THX button, each press of the THX button on the remote controller cyclically changes the DTS-ES mode in the order of “Auto,” “On,” and “Off.”

Note:

THX Surround EX (Dolby D) and DTS-ES cannot be selected if the Surr Back/Zone 2 setting in the Surr Back/Zone 2 Sub-menu of the Hardware Setup Menu is set to “Zone 2” and the Surr Back setting in the Speaker Config Sub-menu of Speaker Setup menu is set to “None.”

Mono Movie/Enhance/Orchestra/Unplugged/Studio Mix /TV Logic Sub-menu

The settings of these sub-menus become effective when any of the Mono Movie, Enhance, Orchestra, Unplugged, Studio-Mix, or TV Logic listening modes are selected. When one of the listening modes is selected, the settings in the sub-menu of that listening mode become enabled.

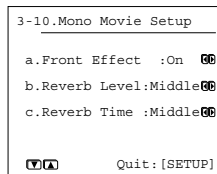

Mono Movie?

a. Front Effect

Some live recordings contain acoustic reverberation. When you play these sources, more reverberation will be applied by the DSP, creating too many reverb effects and the sound loses form or presence. In this case, set this setting to “Off” so that no reverberation from the DSP will be applied to the sound output from the three front channels. With this setting, the sound source is played as it is without any further reverberation.

b. Reverb Level

This setting allows you to adjust the depth of acoustic reverberation to match the playback source material, the acoustics of your room, and other such factors.

Select from the three settings “Low,” “Mid,” and “High.”

c. Reverb Time

Adjust the reverb time to match the source being played back and the acoustics of the room. Select from the three settings “Short,” “Mid,” and “Long.”

Preference (Advanced)

The "Preference" menu allows you to perform miscellaneous settings for the TX-NR801/TX-NR801E.

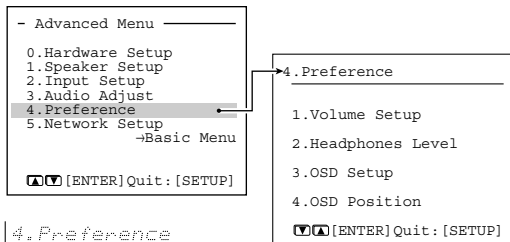
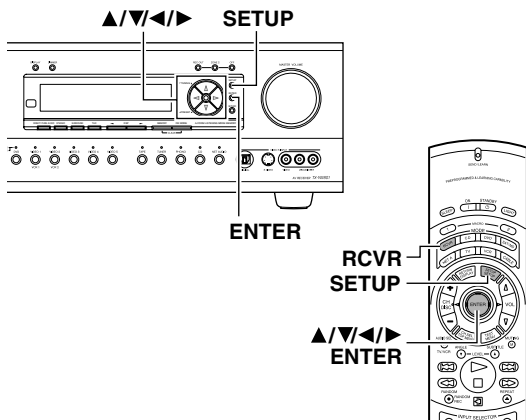

The illustrations used here represent the remote controller. When you perform the procedures on the TX-NR801/TX-NR801E, use the corresponding buttons on the front panel.

- 1 First, press the RCVR button, and then press the SETUP button to display the main menu on the monitor and front display.**
When the "Basic Menu" is displayed, select "→Advanced Menu" using the ▲ and ▼ cursor buttons and press the ENTER button to display the "Advanced Menu."
- 2 Use the ▲ and ▼ cursor buttons to select "4. Preference" and then press the ENTER button.**
The "Preference" menu appears.
- 3 Use the ▲ and ▼ cursor buttons to select an item and then press the ENTER button.**
- 4 Use the ▲ and ▼ cursor buttons to select an item and then use the ◀ and ▶ cursor buttons to set the desired value.**
- 5 Press the SETUP button to return to the main menu.**

Volume Setup Sub-menu

This sub-menu allows you to make various settings concerning the volume control of the TX-NR801/TX-NR801E.

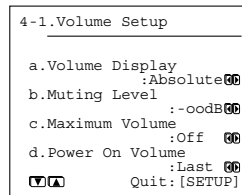

Volume Setup?

a. Volume Display

You can choose from two ways of displaying the volume setting on the screen.

Absolute: This displays the volume with a minimum of 0 for no sound and a maximum of 100. As a reference, the volume setting of Ref (82) is equivalent to 0 decibels for the relative display method.

Relative: This displays the volume as a decibel value on a scale with a designated reference point that is displayed as 0, which equals the volume setting of 82 of the absolute display method. With this display method, the minimum value is $-\infty$, the next highest is -81 , and the maximum value is $+18$.

b. Muting Level

This sets the attenuation level during playback when the MUTING button is pressed on the remote controller. This can be set to $-\infty$, or between -50 and -10 decibels in 10 decibel increments.

c. Maximum Volume

This setting allows you to set the maximum volume that can be output with the MASTER VOLUME dial. Setting a maximum volume allows you to prevent components from being damaged by excessively loud volumes. For the absolute volume display method, this can be set between 50 and 99. For the relative volume display method, this can be set between -32 and $+17$ decibels. To not set a maximum volume, select "Off."

d. Power On Volume

This sets a designated volume to which the TX-NR801/TX-NR801E will be set every time that the power is turned on. This prevents the TX-NR801/TX-NR801E from suddenly outputting very loud sounds if it is turned on while it is set to an extremely high volume. For the absolute volume display method, this can be set between 0 and 100. For the relative volume display method, this can be set to $-\infty$, or between -81 and $+18$ decibels. To have the TX-NR801/TX-NR801E turned on with its current volume setting, set this to "Last."

Adjusting the Headphone Volume Level (Headphones Level)

If you notice a large difference in the volume when listening with the headphones than when listening to the speakers, you can change the headphone volume level so that you do not have to make adjustments with the main volume dial each time you put on the headphones.

The headphone volume can be adjusted between -12 and +12 decibels.

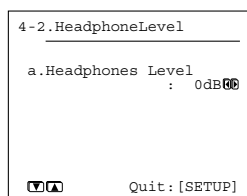

HeadphonesLvl?

Setting the Background Color for OSD (OSD Setup)

This sub-menu allows you to customize the OSD Setup Menu to display in the manner you desire.

USA, Canadian and Australian models

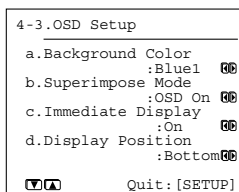

OSD Setup?

Other models whose TV format is PAL

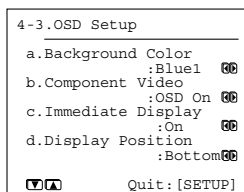

OSD Setup?

a. Background Color

Select either Blue1, Blue2, Green1, Green2, Magenta, Red1, or Red2 as the background color when the OSD Setup Menu is displayed.

b. Superimpose Mode

(USA, Canadian and Australian models)

Off: Select to have the OSD Setup Menu displayed on the selected background color. If this is set to "Off," the background color will not be displayed even when there is no video signal input.

Normal: Select to have the OSD Setup Menu superimposed over the current video if one is displayed or on the selected background color if there is no video signal.

Black: Select to have the OSD Setup Menu displayed on a black background at all times.

b. Component Video (Other models whose TV format is PAL)

You can select whether the OSD signal is output to the TV monitor connected to the COMPONENT VIDEO connectors or not.

OSD On: The OSD signal is output.

OSD Off: The OSD signal is not output.

c. Immediate Display

On: Select to have the screen immediately display certain operations as you perform them (e.g., having the input source displayed whenever an input source selector button is pressed). The display will remain for five seconds after the operation is completed.

Off: Select to turn off the immediate display of operations.

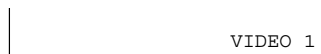

Note (When the model is for USA, Canada or Australia and its TV format is PAL):

While the component video signal is output and even when this setting is set to "On," the information on the Immediate Display will not be displayed.

d. Display Position

Use this setting to select the position of the immediate display that appears when certain operations are performed. You can position the immediate display at any of ten different levels ranging from the top all the way to the bottom.

Switching the OSD Position (OSD Position)

This sub-menu allows you to adjust the position of the OSD Setup Menu as it is displayed on your screen. Depending on the monitor used, there may be cases where the OSD Setup Menu is not displayed in the center and parts of the menus are cut off. To adjust the position of the OSD Setup Menu, simply press the cursor buttons to inch the menu to the position you desire.

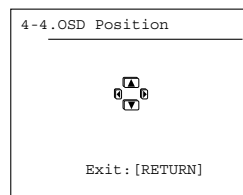

OSD Position?

Playing Analog Multichannel Audio

Before enjoying analog multichannel audio, make sure that the connections and settings shown on the previous page are completed.

The illustrations used here represent the remote controller. When you perform the procedures on the TX-NR801/TX-NR801E, use the corresponding buttons on the front panel.

- 1** Press the input selector button.

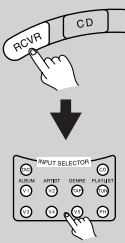
- 2** Select “Multich” using the AUDIO SELECTOR button on the front panel (or AUDIO SEL button on the remote controller).

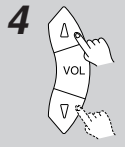

- 3** Turn on the connected component and start playing the desired media.
- 4** Adjust the volume with the MASTER VOLUME dial (or the VOL Δ/∇ buttons on the remote controller).



Adjusting the output level of each speaker as desired

Using the remote controller:

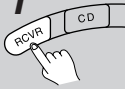
- 1** Press the RCVR mode button.

- 2** Press the CH SEL button and select the desired speaker.

- 3** Press the LEVEL ▼ or ▲ button to adjust the volume level.

Adjust the volume at each speaker so that all the volumes sound at the same level at the listening position. For the front right, front left, center, surround right, surround left, surround back right, and surround back left speakers, the output levels can be adjusted between -12 and +12 decibels. The subwoofer can be adjusted between -30 and +12 decibels.

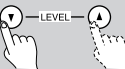

Note:

The speaker level for each multichannel analog input is independent from the speaker level settings made with the test tone. Therefore, you should perform the procedures above before enjoying analog multichannel audio.

Changing the listening mode

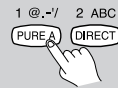
- Each time you press the DIRECT/PURE AUDIO button on the front panel, the display changes between “Direct” ↔ “Pure Audio.” When using the remote controller, press PURE A or DIRECT.
- 

Using the tone control

- 1** Press the SURROUND button on the front panel (or the SURR button on the remote controller) to display “Tone On.”

- 2** Adjust the bass and treble sounds. Select “Setup Menu” → “Audio Adjust Menu” → “Tone Control” to display the “Tone Control” sub-menu and perform the bass and treble settings. For details, see page 54.



To disable the tone control function:

Press the DIRECT/PURE AUDIO button on the front panel (or the DIRECT button on the remote controller).

Enjoying Music in the Remote Zone

The TX-NR801/TX-NR801E allows you to watch and listen to two separate input sources at the same time. This allows you to, for example, place speakers and a television in two different rooms so that two or more people can enjoy two different movies at the same time. The room where the TX-NR801/TX-NR801E is actually located is referred to as the main room while the separate room is referred to as the remote zone (Zone 2). In addition, the IR IN/OUT terminal of the TX-NR801/TX-NR801E allows you to control the TX-NR801/TX-NR801E from the remote zone (Zone 2) with the remote controller even though the remote zone is physically separated.

Note:

ZONE 2 is analog only. Digital signals are not output. If no sound is heard from the selected input source, check if the component is connected to the analog inputs.

Connecting the Remote Zone (Zone 2) Speakers and the Monitor or Projector

When you use the 5.1 channel speaker system for the main room, the unused terminals for the surround back speaker or the surround back pre out can be used for the remote zone (Zone 2). Use the SURR BACK/ZONE 2 SPEAKERS terminals when you want to connect the speakers for the remote zone (Zone 2) directly to the TX-NR801/TX-NR801E. Use the SURR BACK/ZONE 2 PREOUT terminals when you want to connect the power amplifier or pre-main amplifier for dynamic sound.

When using the SURR BACK/ZONE 2 speaker terminals

Be sure to turn off the power before making connections.

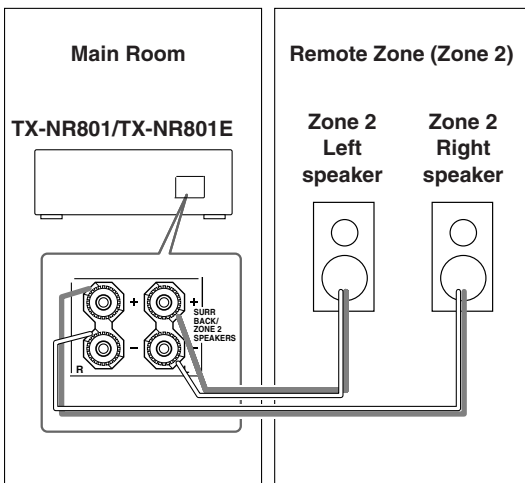

When using the SURR BACK/ZONE 2 PRE OUT terminals

Be sure to turn off the power before making connections.

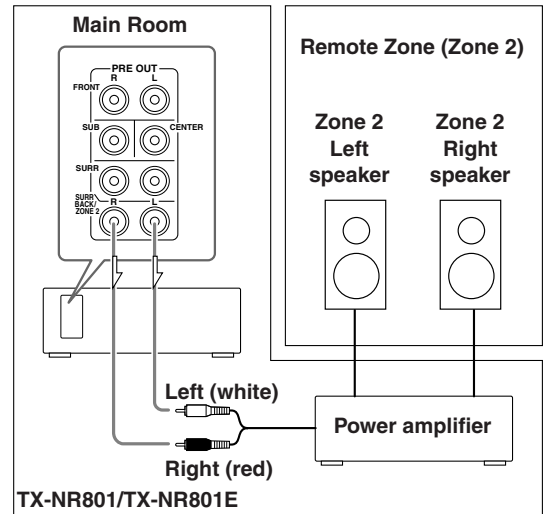

Connecting the TX-NR801/TX-NR801E to the TV or projector for the remote zone

Be sure to turn off the power before making connections.

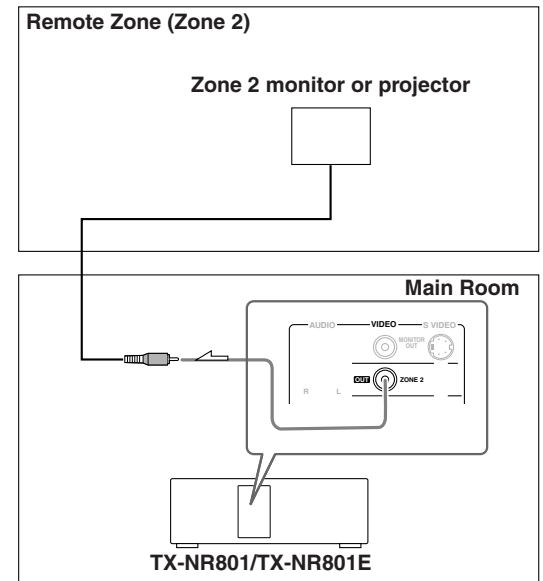

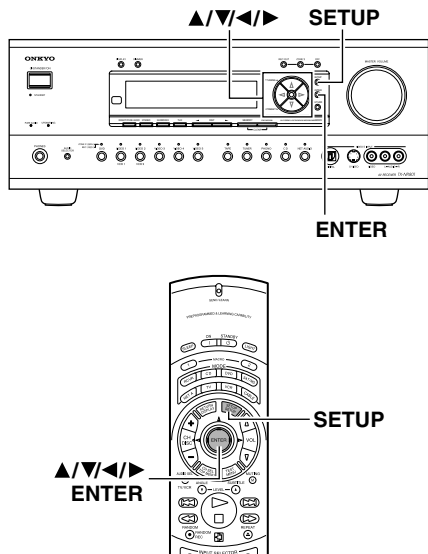

Performing the Settings for the Remote Zone (Zone 2)

To enjoy movies and audio in the remote zone (Zone 2), you need to perform the remote zone settings.

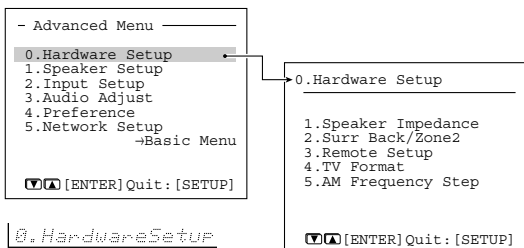

The procedures shown below assume using the remote controller. When performing these procedures using the front panel, use the buttons corresponding to the ones on the remote controller.

1 Press the **SETUP** button to display the main menu on the monitor and front display.

2 Use the **▲** and **▼** cursor buttons to select “0. Hardware Setup” and then press the **ENTER** button. The “Hardware Setup” menu appears. When the “Hardware Setup” menu item does not appear, select “→Advanced Menu” to display the “Advanced Menu.”

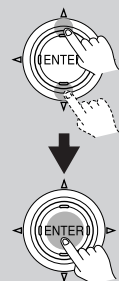

3 When you connect speakers whose impedance values are between 4 and 6 ohms, select “Speaker Impedance” to display the sub-menu and set the value for the “Minimum” to “4 ohms.”

For details, see page 30.

Even if you connect some speakers whose impedance values are between 6 and 16 ohms among speakers whose impedance values are between 4 and 6 ohms, set the “Minimum” value to “4 ohms.”

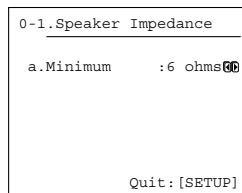

Surr Impedance?

4 Use the **▲** and **▼** cursor buttons to select “Surr Back/Zone 2” and then press the **ENTER** button.

The “Surr Back/Zone 2” menu appears.

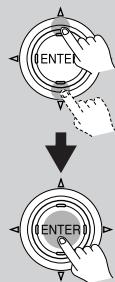

5 Use the **◀** and **▶** cursor buttons to select “Zone 2.”

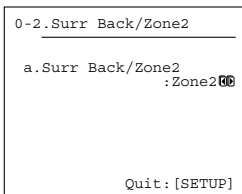

Surr Back/Zone2?



6 Press the **SETUP** button to return to the main menu.

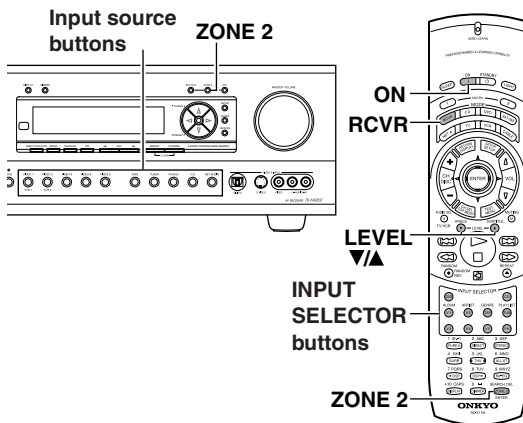



Enjoying Music in the Remote Zone

Using the buttons on the TX-NR801/TX-NR801E

1	 <p>Press the ZONE 2 button on the TX-NR801/TX-NR801E.</p>
2	<p>Select an input source.</p> <p>After pressing the ZONE 2 button, you must press an input source button within 8 seconds. The indicator above the input source button lights green. In this condition, even if you change the input source for the main zone, the input source for the remote zone (Zone 2) will not change.</p> <p>Ex.: When the CD button is pressed.</p> <p style="border: 1px solid black; padding: 2px; display: inline-block;">Z2 Sel:CD</p> <p>To select the same source for the remote zone that is selected for the main zone, press the ZONE 2 button again until “Z2 Sel:SOURCE” appears in the display. In this condition, if you change the input source for the main zone, the input source for the remote zone (Zone 2) will change as well.</p> <p style="border: 1px solid black; padding: 2px; display: inline-block;">Z2 Sel:SOURCE</p> <p>When “Z2 Sel:Off” is displayed, the output to the remote zone is turned off.</p>
3	 <p>Adjusting the volume, press the ◀ or ▶ cursor button.</p>

Notes:

- If a sleep time is set with the SLEEP button, the output to the remote zone will also turn off when the sleep time elapses.
- If the REC OUT button is pressed in the main room while someone is using the system in the remote zone,

the Zone 2 function will be deactivated and the source will turn off in the remote zone.

- If you select FM (or AM) with the TUNER input source buttons when the source for the remote zone (Zone 2) is set to AM (or FM), the output for the remote zone also changes to AM (or FM).
- 7.1 channel playback in the main room is disabled if the Surr Back/Zone 2 setting in the Surr Back/Zone 2 sub-menu of the Hardware Setup Menu is set to “Zone 2.”
- When you are using the remote zone (Zone 2), the **RI** system operation will not work.
- When you are using the remote zone (Zone 2), the Pure Audio setting will not work.
- **When you are not using the remote zone (Zone 2), press the ZONE 2 button and then press the OFF button to turn off the ZONE 2 indicator. (Using the remote controller, press the ZONE 2 button and then the STANDBY button.)**

Using the remote controller

Before performing the procedures, press the RCVR button to enter the receiver mode.

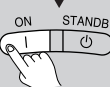

To turn on the TX-NR801/TX-NR801E from the remote zone:

	<p>After pressing the ZONE 2 button, press the ON button within 5 seconds.</p> <p>Be sure to press the ON button while the RCVR button lights.</p>
	

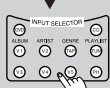
Select an input source:

	<p>After pressing the ZONE 2 button, press an INPUT SELECTOR button within 5 seconds.</p> <p>If tuner is selected with the TUN button, you can use the CH +/- button to select a preset radio station.</p>
	

Adjusting the volume for the remote zone:

	<p>After pressing the ZONE 2 button, press the LEVEL ▼/▲ button.</p>
	

Note:

After you press the ZONE 2 button on the remote controller, the STANDBY indicator on the TX-NR801/TX-NR801E flashes for five seconds. During this time, you will not be able to perform operations in the main zone using the remote controller.

Operating Components not Reached by the Remote Controller Signals (IR IN/OUT)

In order to use the remote controller to control the TX-NR801/TX-NR801E from a remote location, you will need to prepare a multi-room kit (sold separately) such as one of those given below:

- Onkyo's Multi-Room System kits (IR Remote Controller Extension System)
- Multiroom A/V distribution and control system such as those from Niles® and Xantech®

If Remote Controller Signal Does not Reach the TX-NR801/TX-NR801E Remote Sensor

If the TX-NR801/TX-NR801E is located inside a cabinet or other enclosure where the infrared rays from the remote controller cannot enter, then operation with the remote controller will not be possible. In such a case, it will be necessary to install a remote sensor at a location outside of the cabinet that the infrared rays from the controller can reach.

With this connection, select "Main" for the Hardware Setup → Remote Setup → Position in the Setup Menu (See page 31).

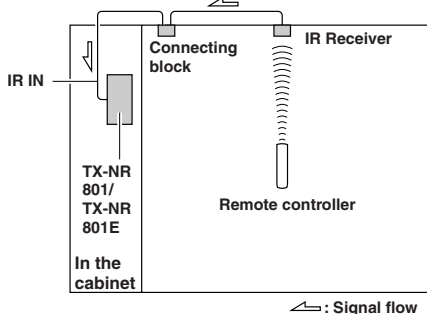

The IR IN input allows you to control the TX-NR801/TX-NR801E from the remote zone (Zone 2) with the remote controller even though the remote zone may be on the other side of the building from the main zone. The diagram below shows how to make the proper connections for the remote zone.

With this connection, select "Zone 2" for the Hardware Setup → Remote Setup → Position in the Setup Menu (See page 31).

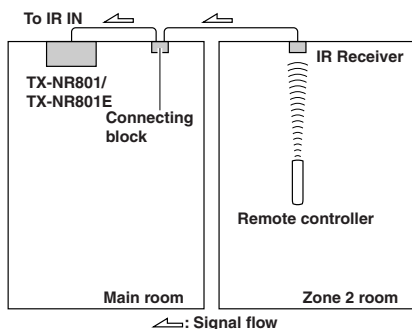

Make the connection as shown below. Do not plug in any equipment to the power outlet until all the connections are complete.

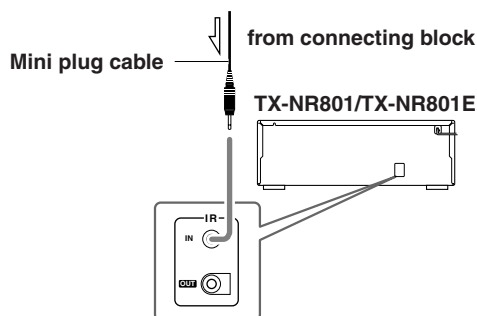

If Remote Controller Signal Does not Reach Other Components

In this situation, you will need to use a commercially available IR emitter. Connect the mini plug of the IR emitter to the IR OUT terminal on the TX-NR801/TX-NR801E and then place the IR emitter on the remote sensor of the component or facing it. When the IR emitter is connected, only the signal input to the IR IN terminal is output to the IR OUT terminal. The signal input from the remote sensor on the front of the TX-NR801/TX-NR801E will not be output to the IR OUT terminal.

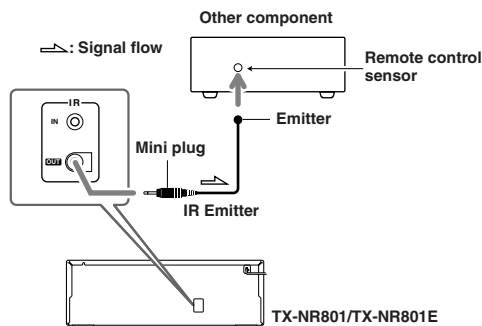
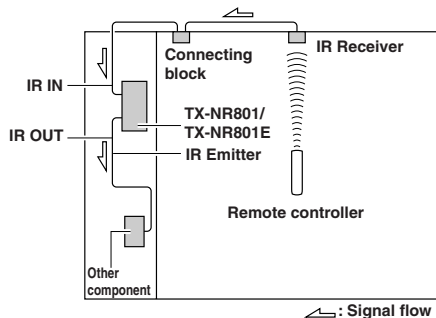

Enjoying Net Audio

Features

The TX-NR801/TX-NR801E is a network audio client that, connected via a LAN to a PC, allows you to enjoy music files saved on the PC, as well as Internet radio, from anywhere in your home.

Internet radio features

The TX-NR801/TX-NR801E provides enhanced support for Internet radio and allows you to:

- Listen to both WMA and MP3 audio streamed from Internet radio stations
- Select stations by genre, location, or language
- Preset up to 30 Internet radio stations

Net-Tune Features

The Net-Tune Central is software that distributes music files stored on PC through a LAN to the TX-NR801/TX-NR801E.

The TX-NR801/TX-NR801E plays distributed music data whenever you need it.

*This software is available from Onkyo's websites.

US→ <http://www.onkyousa.com/net-tune/>

Europe→ <http://www.onkyo.net/net-tune>

Japan→ <http://www.onkyo.co.jp/>

Asia, Oceania, and Central and South America
→ <http://www.onkyo-intl.com/>

In connecting Net-Tune Central and the TX-NR801/TX-NR801E, the standard TCP/IP network protocol and the Onkyo's proprietary NTSP protocol are used for music distribution through a LAN. The NTSP protocol handles not only data for the music itself but also additional music information, including the name of tracks and artists, thus enabling high usability.

In addition to the music distribution server function, Net-Tune Central can automatically retrieve music files stored on a PC to register them easily with the Net-Tune Central database.

Net-Tune Central supports WAVE (PCM), MP3 and WMA formats. The WAVE format has high sound quality (equivalent to CD) with no compression. The MP3 format is widely used in the Internet environment and has near-CD quality with compression. The WMA format, developed by Microsoft®, also has near-CD quality and uses a higher compression rate.

Editable music library

With the Net-Tune Central software, you can edit music titles, artist names, genre names, and so on, while you can also create new genre names, for all music files saved on the PC's hard disks.

Net-Tune Central also provides this information with the TX-NR801/TX-NR801E, allowing you to select tracks more easily on the TX-NR801/TX-NR801E.

Hints:

File Format:MP3/WMA (Approximately 1 MB for 1 minute)

WAVE (Approximately 10 MB for 1 minute)

- * How much free space is actually required also depends somewhat on such factors as the format and residual space on your hard disk, and the bit rate at which you make recordings.
- * Depending on the MP3 encoder you use, your recorded file may not be playable, or the music will be degraded by noise, or will generate unpleasant sounds.

Also note that no WMA format file with copyright protection enabled is playable on the TX-NR801/TX-NR801E

System Requirements

Requirements for listening to both Internet radio stations and music files saved on the music server

■ **Modem** (a device that provides Internet connections via leased lines; e.g., a cable modem, xDSL modem, terminal adapter)

* To have access to Internet, you typically need to contract with an Internet service provider (ISP). Modem requirements differ from ISP to ISP; for detailed information, consult with your ISP or PC retailer.

■ **Router (gateway)** (a device that enables multiple PCs or devices to connect to the Internet simultaneously)

An IP address can be obtained automatically by using the router's DHCP function.

* Some routers have built-in modem functionality. Router requirements differ from ISP to ISP; for detailed information, consult with your ISP or PC retailer.

■ Ethernet CAT-5 cable

■ Minimum Internet Connection Requirements:

- Broadband Internet Connection
- DHCP (Dynamic Host Configuration Protocol) based network (requires a DHCP-enabled router)
- 100Base-TX switch built-in broadband router (recommended)

■ Minimum PC System Requirements:

600 MHz Intel Pentium III CPU or better, Windows 98SE, Me, XP, or 2000 OS (operating system), more than 20 MB of free hard disk space, RAM (Windows 98SE, Me, 2000; requires 128 MB, XP; requires 256 MB) and Ethernet port.

Not compatible with Macintosh systems.

Notes:

- If your ISP contract assumes manual configuration of network settings, you need to manually configure your network settings as described in "Network Setup Menu" (See page 72).
- The TX-NR801/TX-NR801E does not support network settings for PPPoE connections; therefore, if your ISP contract requires PPPoE, you must have a gateway/router with PPPoE support.

- You may have to set up a proxy server to listen to Internet radio, depending on the ISP you choose. If your PC is configured to use a proxy server for Internet access, the TX-NR801/TX-NR801E must also be configured the same way. For more information, see “Proxy Setup Sub-menu” (See page 73).
- The TX-NR801/TX-NR801E is designed to take advantage of the DHCP and AutoIP functionality, thereby automatically configuring the network settings. If you opt not to use the DHCP and AutoIP functionality, you should manually configure the network settings. For more information, see “a. DHCP/AUTO IP” (See page 73).
- To enjoy music on Internet Radio, it is assumed that you have a broadband Internet connection on which you can successfully run a web browser. If you have any problem in connecting to the Internet, consult with your ISP.

Connecting the TX-NR801/TX-NR801E to Your Ethernet Network

Plug one end of an Ethernet CAT-5 cable into the port on the backside of the TX-NR801/TX-NR801E and the other end into the gateway.

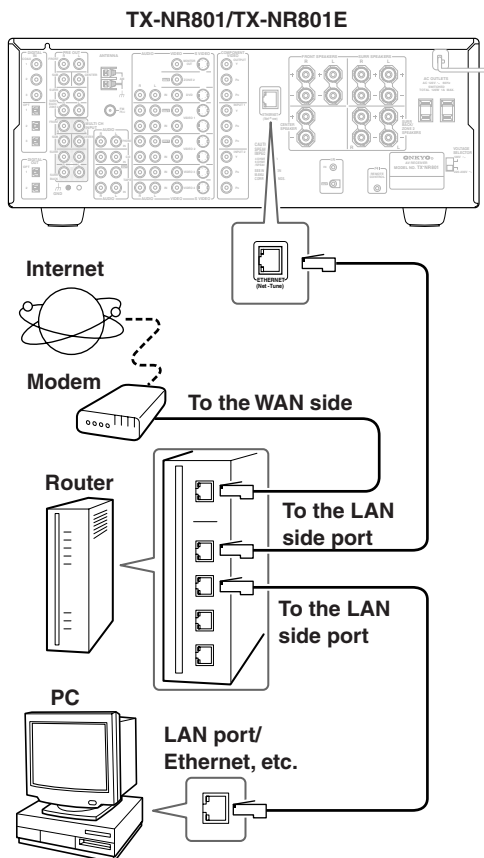

Hint:

Connecting more than one TX-NR801/TX-NR801E unit to a router enables several users to listen to Internet radio at different stations or different music pieces contained in the same library on the PC.

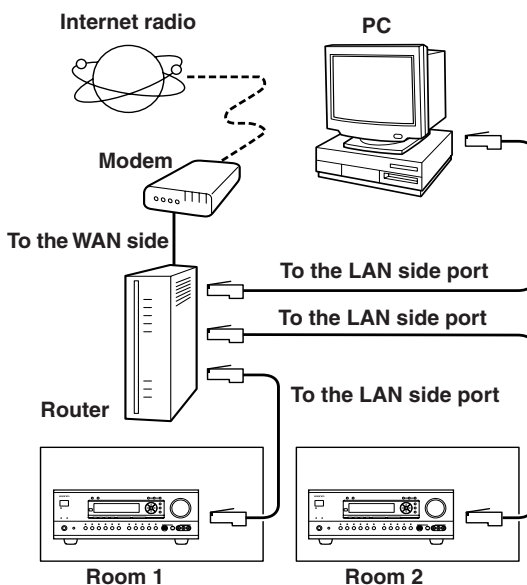

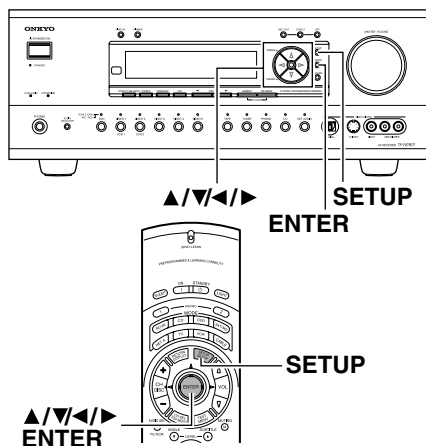

Network Setup Menu

Before you can use the TX-NR801/TX-NR801E to play music contained in the music library on the Net-Tune server and listen to Internet radio, you must correctly configure the TX-NR801/TX-NR801E's network settings so that it can connect to your LAN and the Internet. It is strongly recommended to use a broadband connection (via an xDSL or CATV leased line) and a router. If you are connected to the Internet via a narrowband dial-up connection, you may not be able to enjoy Internet radio as you expect or at all.

Before setting up the TX-NR801/TX-NR801E, make sure that you are already using a router that provides Internet access and that the TX-NR801/TX-NR801E is correctly connected with your router or hub via a LAN cable.

For more information on Internet connectivity, consult with your ISP (Internet Service Provider) or refer to the router documentation.

DHCP (Dynamic Host Configuration Protocol) and **AutoIP** are mechanisms for network configuration, which assign IP addresses automatically to network devices such as the TX-NR801/TX-NR801E, PC, and broadband router.

DNS (Domain Name System) is a mechanism which translates domain names into IP addresses or vice versa. Domain names such as www.onkyo.co.jp are used for Web browsing, and IP addresses such as 210.199.170.69 are used for actual network data transfer.

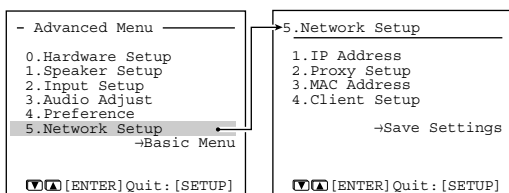

5. Network Setup

If you want to perform these operations using the remote controller, first press the RCVR button.

- 1 Display the main menu.**
Press the SETUP button on the front panel or SETUP button on the remote controller to display the main menu on the monitor and front display. When the "Basic Menu" is displayed, select "→Advanced Menu" using the ▲ and ▼ cursor buttons and press the ENTER button to display the "Advanced Menu."
- 2 Use the ▲ and ▼ cursor buttons to select "5. Network Setup" and then press the ENTER button.**
The "Network Setup" menu appears.
- 3 Use the ▲ and ▼ cursor buttons to select an item and then press the ENTER button.**
- 4 Use the ▲ and ▼ cursor buttons to select an item and then use the ◀ and ▶ cursor buttons to set the desired value.**
- 5 Press the SETUP button to exit the Setup menu.**
Press the RETURN button to return to the previous menu.

IP Address Sub-menu

You can use this submenu to turn on/off the DHCP and Auto IP functionality.

Also, you can use this menu to manually configure network settings. Referring to the documentation from your ISP, enter the IP address and subnet mask assigned to your TX-NR801/TX-NR801E as well as the IP addresses of the default gateway and DNS server.

After the necessary settings are complete, press the RETURN button to go back to "5. Network Setup Menu," select "→ Save Settings," and press the ENTER button to save the setting you made.

When you set a. DHCP/AUTO IP to Off, select a menu item under b. and press the ENTER or ▶ button; the TX-NR801/TX-NR801E will enter the number-entry mode.

Select a number using the ◀/▶ buttons, and press the ENTER button to enter the number.

After all the necessary numbers are entered, the TX-NR801/TX-NR801E exits the number-entry mode.

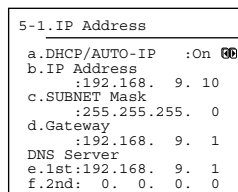

IP Address?

a. DHCP/AUTO IP

Sets whether the network setting is configured automatically or not.

On: The network setting will be configured automatically. When you set this option to On, the values for b. through f. will be assigned using DHCP.

Off: The network setting is configured manually.

b. IP Address

You will enter this value when you set the a. DHCP/AUTO IP setting above to Off.

Enter the IP address assigned to your TX-NR801/TX-NR801E. If your TX-NR801/TX-NR801E is directly connected with an xDSL modem or terminal adapter, be sure to enter the static IP address exactly as specified by your ISP.

Specify the IP address within the range below. Net-Tune Central cannot be used with IP addresses out of the ranges below.

CLASS A: 10.0.0.0–10.255.255.255

CLASS B: 172.16.0.0–172.31.255.255

CLASS C: 192.168.0.0–192.168.255.255

Because the most of the commercially available routers are set to a CLASS C IP address, specify a CLASS C IP address for the TX-NR801/TX-NR801E.

c. SUBNET Mask

You will enter this value when you set the a. DHCP/AUTO IP setting above to Off.

Enter the subnet mask. If your TX-NR801/TX-NR801E is directly connected with an xDSL modem or terminal adapter, be sure to enter the subnet mask exactly as specified by your ISP. Usually, enter 255.255.255.0 here.

d. Gateway

You will enter this value when you set the a. DHCP/AUTO IP setting above to Off.

Enter the IP address of the default gateway. If your TX-NR801/TX-NR801E is directly connected with an xDSL modem or terminal adapter, be sure to enter the gateway address exactly as specified by your ISP. If your TX-NR801/TX-NR801E is connected to a gateway/router, enter the IP address of the gateway/router.

DNS Server

e. 1st

f. 2nd

You will enter this value when you set the a. DHCP/AUTO IP setting above to Off.

Enter the IP address of the DNS server. If your TX-NR801/TX-NR801E is directly connected with an xDSL modem or terminal adapter, be sure to enter the DNS address exactly as specified by your ISP.

When your Internet service provider provides only one DNS address, enter this address into “e. 1st.” When two or more DNS addresses are provided, enter both of them into “e. 1st” and “f. 2nd,” respectively.

Note:

After setting, allow approx. 2 seconds until the TX-NR801/TX-NR801E stores all of the data in the

memory. Be sure not to turn off the power during that time otherwise the data will be lost.

Proxy Setup Sub-menu

Configure this item if your TX-NR801/TX-NR801E uses a proxy server to connect to the Internet.

Enter the proxy server settings exactly as specified by your ISP.

After the necessary settings are complete, press the RETURN button to go back to “5. Network Setup Menu,” select “→ Save Settings,” and press the ENTER button to save the setting you made.

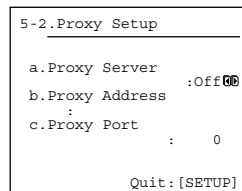

Proxy Setup?

a. Proxy Server

Sets whether the TX-NR801/TX-NR801E connects to Internet radio station through proxy server or not.

On: Connects to Internet radio station through Proxy Server.

Off: Connects to Internet radio station without Proxy Server.

b. Proxy Address

Enter the domain name of the proxy server.

When you set a. Proxy Server to On, select this menu item and press the ENTER or ► button, the TX-NR801/TX-NR801E enters the character-entry mode.

Select a character using the ▲/▼/◀/▶ buttons, and press the ENTER button to enter the character.

After all the necessary characters are entered, the TX-NR801/TX-NR801E exits the character-entry mode.

c. Proxy Port

Enter the port number of the proxy server.

When you set a. Proxy Server to On, select this menu item and press the ENTER or ► button, the TX-NR801/TX-NR801E enters the number-entry mode.

Select a number using the ▲/▼/◀/▶ buttons, and press the ENTER button to enter the number.

After all the necessary numbers are entered, the TX-NR801/TX-NR801E exits the number-entry mode.

Note:

After setting, allow approx. 2 seconds until the TX-NR801/TX-NR801E stores all of the data in the memory. Be sure not to turn off the power during that time otherwise the data will be lost.

MAC Address Sub-menu

You can view the assigned MAC address. Every network port is identified by a unique MAC address (This is read-only information).

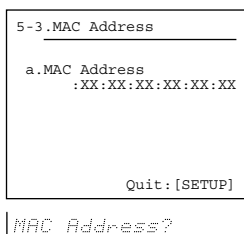

a. MAC Address

Displays the MAC address assigned to your TX-NR801/TX-NR801E.

Client Sub-menu

A client is a device that receives information from a sever. One server can serve multiple clients. Throughout this guide, the term “client” refers to your TX-NR801/TX-NR801E.

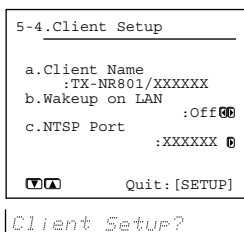

a. Client Name

Shows the name used on Net-Tune Central.

The client name has already been set by the TX-NR801/TX-NR801E.

b. Wakeup on LAN (Network connection status)

Sets whether to leave the network connection open or not while the TX-NR801/TX-NR801E is in the standby state.

On: Leaves the network connection open.

Off: Closes the network connection while the TX-NR801/TX-NR801E is in the standby state. You can save power consumption during standby state.

c. NTSP Port

You can change the TCP/IP port number used for communicating with Net-Tune Central. Be sure to match the port number set here with the port number set on Net-Tune Central. When you change the port number settings, press the **▶** button to display the NTSP Port Input menu.

Select a number using the **◀/▶** buttons, and press the ENTER button to enter the number.

After all the necessary numbers are entered, the TX-NR801/TX-NR801E exits the number-entry mode.

After the necessary settings are complete, press the RETURN button to go back to “5. Network Setup Menu,” select “→ Save Settings,” and press the ENTER button to save the setting you made.

Never turn off the TX-NR801/TX-NR801E while saving the settings.

Input Setup Menu

The illustrations used here represent the remote controller. When you perform the procedures on the TX-NR801/TX-NR801E, use the corresponding buttons on the front panel.

- 1** Press the **NET A** button.
- 2** Press the **RCVR** button, and then press the **SETUP** button to display the main menu on the monitor and front display.

When the “Basic Menu” is displayed, select “→Advanced Menu” using the **▲** and **▼** cursor buttons and press the ENTER button to display the “Advanced Menu.”
- 3** Use the **▲** and **▼** cursor buttons to select “2. Input Setup” and then press the **ENTER** button.

The “Input Setup” menu appears.
- 4** Use the **▲** and **▼** cursor buttons to select the sub-menu that you want to enter and then press the **ENTER** button.
- 5** Use the **▲** and **▼** cursor buttons to select an item and then use the **◀** and **▶** cursor buttons to set the desired value.
- 6** Press the **SETUP** button to return to the main menu.

Music Server Sub-menu

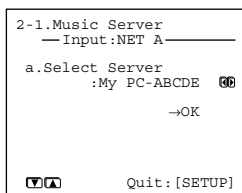

Music Server?

a. Select Server

Select a network server that exists on the network.

* mark appears to the servers detected on the network.

If there is a server which does not have * mark, make sure that the server is operating.

After selection, use the ▼ button to select “→ OK,” and press the ENTER button to confirm your selection.

Playback OSD Display Sub-menu

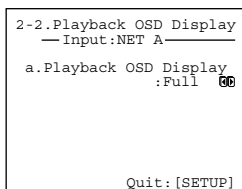

Playback OSD?

The Playback OSD Display sub-menu allows you to select the way the information on the currently played track appears on the OSD.

a. Playback OSD Display

Full: Select this when you want to have the OSD display the information on the currently played track.

Simple: Displays the current track information summary in two lines.

Off: Select this when you do not want to have the information displayed on the OSD.

Hint:

Procedures for the other setup menus are same as other input sources. For details, see the following pages.

Video Setup Sub-menu → page 38

IntelliVolume Sub-menu → page 53

Listening Mode Preset Sub-menu → page 56

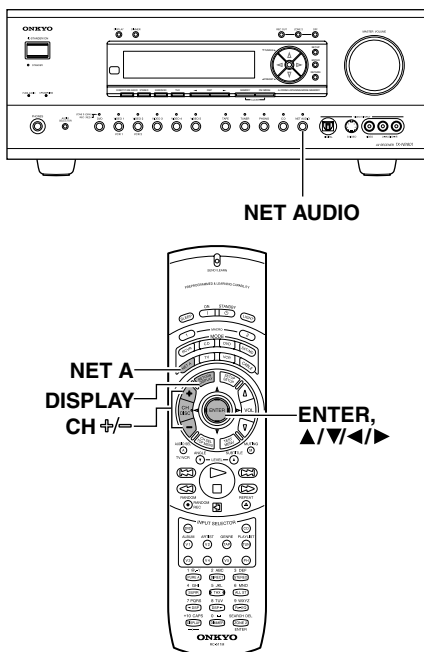

Enjoying Internet Radio

To listen to Internet radio, the connection/configuration requirements listed on pages 70 and 75 must be satisfied. When you perform step 2 and following steps, use the blue-labeled buttons on the remote controller.

- | | |
|--|---|
| <p>1</p> <p>TX-NR801/
TX-NR801E
NET AUDIO</p> <p>Remote controller</p> | <p>Press the NET AUDIO button (on the main unit) or the NET A button (on the remote controller).</p> <p>This recalls the last setting used. To listen to Internet radio immediately after using the Music Server on your PC, you can switch to Internet radio by pressing the same button again. It will take some time until the connection is established.</p> |
| <p>2</p> | <p>Press the DISPLAY button on the remote controller.</p> <p>If the main menu has been already displayed, go to the next step.</p> |
| <p>3</p> | <p>Use the ▲/▼ buttons to select one of the main menu; Genres, Location, or Language.</p> <p>To cancel, press the ◀ button.</p> |

4



Press the ENTER button.

Wait while your requested data is downloaded from the XiVA Internet Radio Service.

*** What is the XiVA Internet Radio Service?**

The XiVA Internet Radio Service provides tuning information, allowing you to select from a large number of stations. You can find Internet Radio Stations based on your interests, musical taste, language and location.

When Genres is selected:

Allow a few moment until the Genre menu appears. When the main list of genres appears, use the ▲/▼ buttons to select the genre desired. Pressing the ENTER button brings up the sub-list of the genre you selected, which prompts you to further select one of the items using the ▲/▼ buttons.

When Location is selected:

The list containing names of countries appears. Use the ▲/▼ buttons to select the desired item.

When Language is selected:

The list of languages appears. Use the ▲/▼ buttons to select your desired item.

If no list is found, "No List" appears. You can return from this screen to the previous selection screen by pressing the ◀ button.

5

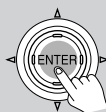

Press the ENTER button.

You are presented with a list of radio station names.

6

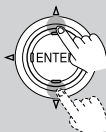

Use the ▲/▼ buttons to select one of the radio stations.

You can return to the previous step by pressing the ◀ button.

7

Press the ENTER button.

Buffering starts with the following message displayed.



Buffering 90%

When the buffering is complete, the TX-NR801/TX-NR801E starts playback of the broadcast.

Note:

If you are connected to the Internet via a slow link (such as a dial-up connection) rather than a broadband link (via an xDSL or cable modem), you may not be able to enjoy Internet radio as you expect or at all.

You can switch the displayed content using the ▲/▼ buttons.

After the switch operation, the display mode appears for 3 seconds, and then the appropriate information scrolls.

If there is no information on title or artist, “No Info” appears.

When using the OSD screen, all the information is displayed on one screen without scrolling.

OSD	iNet Radio Station ONK 7ch
Title:	Station ONK Live
Program:	Station ONK Live
Artist:	RealOnkyoNet.com
Data:	WMA 20kbps
	Tuned

Display Station ONK

Presetting Internet radio stations

You can preset up to 30 Internet radio stations.

1

Receive your desired station.

2

Press the ► button.

The TX-NR801/TX-NR801E enters into preset mode; the currently selected preset number flickers for 5 seconds.

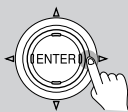

Preset number

Station ONK 10

3

Press the ENTER button.

The preset is now complete.



Choosing a preset Internet radio station

1

**TX-NR801/
TX-NR801E**

NET AUDIO



Remote controller

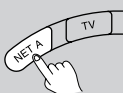

Press the NET AUDIO button (on the main unit) or the NET A button (on the remote controller).

This recalls the last setting used. To listen to Internet radio immediately after using the Net Server on your PC, you can switch to Internet radio by pressing the same button again.

2

Press the CH +/- button.

When you choose a preset station, the station name is displayed for 5 seconds, and then the progress of buffering is displayed instead.



Station ONK



Buffering 90%

When the progress of buffering reaches 100%, you will be presented with the playing screen.

Erasing a preset Internet radio station

1

Select the station to erase, following the instructions described above.

2

Press the ► button.

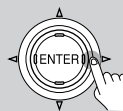

Station ONK 10

The TX-NR801/TX-NR801E enters into preset erase mode.

3

Press the ENTER button.

Your selected station is erased.

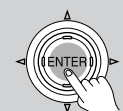

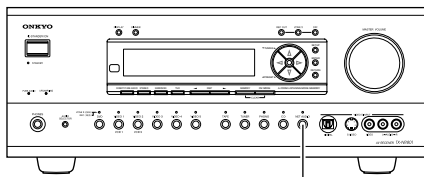

NET AUDIO

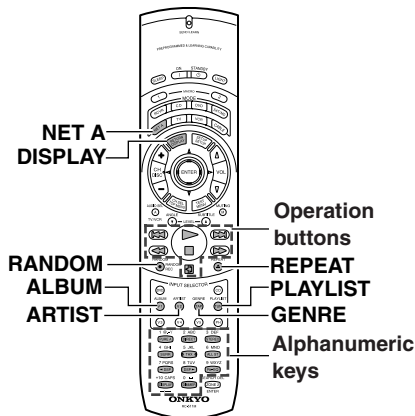

Playing a Music File Saved on Your PC

To play music files saved on your PC, the requirements listed on page 70 must be satisfied.

- 1 Start Net-Tune Central on your PC.**
Wait for a while until Net-Tune Central starts up. It may take a second.
- 2 Turn on the TX-NR801/TX-NR801E.**
When you connect the TX-NR801/TX-NR801E to the network the first time, it will be connected to the first server found.
- 3 Press the NET AUDIO button (on the main unit) or the NET A button (on the remote controller).**
If you want to play a music file immediately after listening to Internet radio, you can switch to Net Server on your PC by pressing the same button again. The track you played the last time is called up so that you can play it again. Until the TX-NR801/TX-NR801E connects to the network, finds the server and completes the connection, "Network Starting..." and "Connecting..." appears. After completing the connection to the Net-Tune Central server, the display changes to the normal indication. If the following messages appear, check the message meaning and perform the appropriate procedures.

“No Track”
The Net-Tune Central could not retrieve any track information. Register tracks with Net-Tune Central. If you have already registered tracks, use the DISPLAY, ARTIST, ALBUM, GENRE, and PLAYLIST buttons to display information.

“Disconnected”
The Net-Tune Central server may not start or the server connected last time may not be found. Confirm the connections between router, PC and the TX-NR801/TX-NR801E. Start the Net-Tune Central server or select another server referring to “Select Server” on “Music Server Sub-menu” (See page 75).

4 Press the \triangleright button to play the music file.
The TX-NR801/TX-NR801E provides five normal display modes; you can use the $\blacktriangle/\blacktriangledown$ button to switch among them.

Remote controller



Display 1r 1m20s

- **To stop playback:**
Press the \square button on the remote controller.
- **To pause playback:**
Press the \boxtimes button on the remote controller.
- **To select a track:**
Press the \leftarrow/\rightarrow button on the remote controller. Press the \rightarrow button to move to the next track. Press the \leftarrow button to move to the beginning of the current track; hold down the \leftarrow button to move to the previous track. You can also use the alphanumeric keys to select a track.
ex.
To select number 3, press 3.
To select number 10, press --/--, 1 and 0.
To select number 37, press --/--, 3 and 7.
To select number 123, press --/-- twice, and then press 1, 2 and 3.
To select number 2568, press --/-- third, and then press 2, 5, 6, and 8.
- **To fast-forward/reverse the music:**
Press and hold the \triangleright button on the remote controller to fast-forward the music; press and hold the \triangleleft button to fast-reverse the music. When the music is rewound to the beginning, normal playing starts.

• To switch to the track list:

While playing the music, you can press the  button to display a list of currently open tracks.

Playing a music file at random



Press the RANDOM button on the remote controller while playing stops.

Pressing the RANDOM button on the remote controller displays the current random settings.

This button switches between two alternative settings: On and Off.

On: Randomly plays the tracks in the currently selected mode.

Off: Random mode is disabled.

After the necessary settings are complete, press the  button.

Playing a music file repeatedly



Press the REPEAT button on the remote controller.

Pressing the REPEAT button on the remote controller displays the current repeat settings.

This button cyclically switches among three alternative settings: Repeat 1 → All → Off.

Repeat 1: Repeats the current track only.

Repeat All: Repeats the tracks in the currently selected mode.

Repeat Off: Repeat mode is disabled.

You can operate the TX-NR801/TX-NR801E when playing and when stopped.

Selecting a track list

You can use the music file data saved on your PC to select which tracks to play.

For example, you can:

- Select a track list based on the album name
- Select a track list based on the artist name
- Select a track list based on the genre name
- Select a play list

1



Press either the ALBUM, ARTIST, GENRE, or PLAYLIST button on the remote controller.

Search the tracks stored on the PC with your selected mode to display it in the display.

In the artist and album modes, the tracks are displayed in alphabetical order.

You can also use the procedure below.

1. Press the DISPLAY button.
2. You can press the  buttons to cyclically switch among the four modes: Albums ↔ Artists ↔ Genres ↔ Playlists.
3. Press the ENTER button.

2



Use the buttons to select one from the menu.

At this time, pressing  button brings you one step behind where you can change the selection you made.

Also, pressing  button in the genre or artist selection mode will display a list of albums with the genre or artist you selected.

In the album, artist or playlist selection mode, using the alphanumeric buttons will accelerate your selecting operation (See below).

3

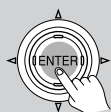

Press the ENTER button.

The title of your selected track appears. You can choose another track by pressing the  buttons.

Press the  button to return to the previous step. You can also select the list number using the numeric buttons.

4



Press the ENTER button.

The playback begins.

Using the alphanumeric keys

The alphanumeric keys allow you to input one of the letters or numbers printed on their key tops. Pressing the CAPS button cyclically switches the types of input: Upper case (A) → Lower case (a) → Numeric value (1) →...

When your desired input type is selected, then press the alphanumeric key.

Let us take the 2ABC button as an example to see how it can be operated.

When the upper case is selected:

Pressing the button once will perform the search by the letter "A." Pressing twice will do the search by "B," pressing three times by "C."

When the lower case is selected:



Pressing the button once will perform the search by the letter "a." Pressing twice will do the search by "b," pressing three times by "c."

When the numeric value is selected:

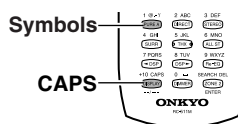
Pressing the button once will perform the search by the numeric value "2."



To cancel the operation:

Press the  button to return to the previous step. You can cancel the whole operation by pressing the  button in step 1.

Note:

Pressing DISPLAY button on the main unit will display the current listening mode.

Operating Onkyo Products Using the Remote Controller

The RC-511M remote controller is a useful tool that can not only operate the TX-NR801/TX-NR801E, but also all the other components of your home theater as well. To operate any component, first press the Mode button on the remote controller that corresponds to the component that you wish to control. Then simply press the desired operation button and the component will operate accordingly. To operate a digital satellite tuner, cable, VCR, or television with the remote controller, first program the signal to the button.

There are two methods. One method is selecting the name of a different brand from the table, entering the setting number listed, and calling up the pre-programming code (See page 83). The other method is sending the commands from the other brand's remote control directly into this remote controller (See pages 86-87).

Operating Onkyo Products Using the RI Connection

Connecting your RI-compatible Onkyo CD player, MD recorder, DVD player, or cassette recorder to the TX-NR801/TX-NR801E via RI allows you to control your system with the TX-NR801/TX-NR801E's remote controller by pointing it at the TX-NR801/TX-NR801E. This allows you to control components that are out of sight, for example, in a cabinet. Since you don't have to enter any special codes, or do any programming, RI

allows you to control these components quickly and easily. See page 26 for connection information.

Note:

To use the RI function, you must make an RI connection and an analog RCA/phono connection between the AV component and your TX-NR801/TX-NR801E, even if they are connected digitally.

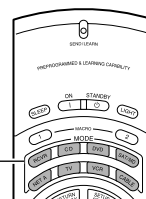

MODE buttons

- 1 Press the MODE button.**
 - When operating the Onkyo cassette tape deck, press the RCVR MODE button.
 - When operating the Onkyo DVD player, press the DVD MODE button.
 - When operating the Onkyo CD player, press the CD MODE button.
 - When operating the Onkyo MD player, press the SAT/MD MODE button.
- 2 Point the remote controller at the TX-NR801/TX-NR801E and press the desired operation button.**

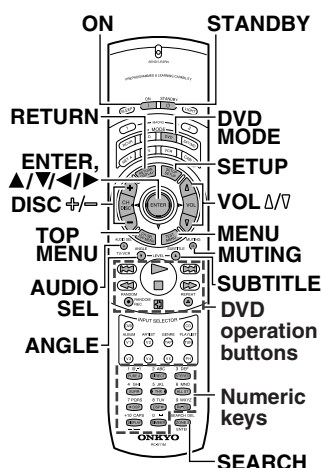

Note:

When operating an Onkyo DVD player directly with the remote controller without connecting the RI terminals, pre-programming is necessary (See page 82).

DVD mode	
ON	Turns DVD player on and off
STANDBY	Turns DVD player off (Some sets may not respond to this button. In this case, use the ON button to put the DVD player in the standby state.)
SETUP	Displays the OSD of the DVD player
▲/▼/◀/▶	Moves cursor in the OSD Menu of the DVD player
ENTER	Enter button for the OSD Menu of the DVD player
RETURN	Return button for the OSD Menu of the DVD player
TOP MENU or MENU	Displays menu screens recorded on DVD media
DISC +/-	Selects disc in DVD changer
AUDIO SEL	Selects audio or language track (if recorded on the DVD)
ANGLE	Selects a camera angle (if recorded on the DVD)
SUBTITLE	Selects subtitle language (if recorded on the DVD)
SEARCH	Searches for location on disc to start playback
RANDOM	Random playback
⏮	Chapter/Track down
⏭	Chapter/Track up
▶	Play
⏹	Stop
⏪	Fast reverse
⏩	Fast forward
⏸	Pause
⏴	Opens/closes the disc tray
0, 1 to 9, +10	Numeric keys
VOL Δ/V	Adjusts volume at TX-NR801/TX-NR801E
MUTING	Activates muting function at TX-NR801/TX-NR801E

Operating Onkyo Products Using the Remote Controller—Continued

	TAPE MODE	CD MODE	MD MODE
ON		Turns on and off the compact disc player (same as STANDBY button on the remote controller)	Turns on and off MD player (same as STANDBY button on the remote controller)
DISC +		Selects a disc in the CD changer	
	Play	Play	Play
	Stop	Stop	Stop
	Rewind	Skip backward	Skip backward
	Fast forward	Skip forward	Skip forward
	Skips to beginning of current track during playback	Track down	Track down
	Skips to beginning of next track during playback	Track up	Track up
REC ●	Record/Pause		Record
	Reverse playback	Pause	Pause
		Opens/closes disc tray	Eject
0, 1 to 9, +10		Numeric keys	Numeric keys
ENTER			Enters the settings
RANDOM		Random playback	
Operates the TX-NR801/TX-NR801E			
VOL Δ/∇	Adjusts volume at TX-NR801/TX-NR801E		
MUTING	Activates muting function at TX-NR801/TX-NR801E		
	<p>Note: Even for devices with the and buttons, signal discrepancies may cause them not to work properly.</p>		<p>Note: The SAT/MD button is used for operating digital satellite tuners and Onkyo MD recorders. Be aware that if you enter the preset code for a digital satellite tuner as shown on page 83, then this button cannot be used to operate Onkyo MD recorders. If this is the case, to operate an Onkyo MD recorder, you must first erase the digital satellite tuner code by following the directions given in “Erasing all the commands programmed under a MODE button” on page 87.</p>

Operating Other Manufacturers' Devices Using the Remote Controller

The remote controller has three learning functions. One is entering the pre-programmed code for a remote controller of another manufacturer. Another is the normal learning function that enables the remote controller to learn the codes directly from other remote controllers (See page 86). And the last is a macro learning function that enables you to program a series of operations into the remote controller so that the operations can all be performed at once by pressing one button (See page 88).

Learning a Pre-programming Code

By entering a pre-programming code, you can have the RC-511M remote controller operate a component made by another manufacturer. The buttons that are used for operation are given on pages 84-85.

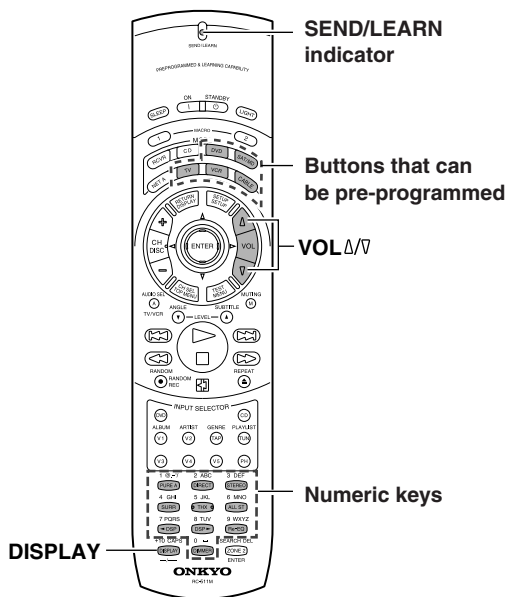

Caution

With some brand's components, some buttons may not work correctly. In this case, program the command directly from the other remote controller normally (See page 86).

- 1** In the table on the next page find the 3-digit number for the manufacturer of the component that you want to operate.
- 2** Turn on the component that you want to operate (i.e., DVD, satellite tuner, or television).
- 3** While holding down the **MODE** button on the RC-511M that you want to program, press the **DISPLAY** button, and then release both buttons.
The SEND/LEARN indicator lights when the MODE button is pressed and turns off when the DISPLAY button is pressed. When the indicator turns off, release both buttons. The SEND/LEARN indicator lights again.
- 4** Within 30 seconds, enter the 3-digit code.
The SEND/LEARN indicator slowly flashes twice. If the SEND/LEARN indicator quickly flashes three times, then either a mistaken 3-digit code was entered or an incorrect operation was performed. If this occurs, return to step 3.
- 5** Press the button that you programmed and check if the system operates correctly.
 - If the component does not operate properly, return to step 3 and repeat the steps above.
 - If it still does not operate properly, program the command directly from the other remote controller normally (See page 86).

When entering the code of Onkyo DVD players:

There are three SETTING numbers. Choose the SETTING number according to how you will be using the DVD player.

No. 601/613: These codes are for operating the Onkyo DVD player by pointing the remote controller directly at it, either because it does not have an **RI** terminal, or it does but you are not connecting it with an **RI** cable. First enter 601 and if it does not operate properly, enter 613.

No. 600: This code is for Onkyo DVD players that have an **RI** terminal that you are connecting to the TX-NR801/TX-NR801E with an **RI** cable. You will then operate the DVD player by pointing the remote controller at the remote control sensor on the TX-NR801/TX-NR801E. You do not need to enter this code because it is factory preset. However, if the code has been changed to 601 or 613, then you will need to change it back to 600.

Operating Other Manufacturers' Devices Using the Remote Controller— Continued

Pre-programming codes

Note:

If more than one code is given in the table, try each code one by one until you reach the code that works (i.e., if the first code does not work, then try the next).

DVD

BRAND	SETTING No.
DENON	602, 609
HITACHI	603
JVC	604
KENWOOD	605
MAGNAVOX	606, 613
MARANTZ	607
mitsubishi	608, 613
ONKYO	600,601,613
PANASONIC	609
PIONEER	610
PROSCAN	611
RCA	611
SONY	612
TOSHIBA	613
YAMAHA	609, 614
ZENITH	613, 615

SAT

BRAND	SETTING No.
ECHOSTAR	700
GENERAL INSTRUMENTS	701
HITACHI	702
HUGHES NETWORK SYSTEMS	703
PANASONIC	704
PRIMESTAR	705
PROSCAN	706,707
RCA	706,707
SONY	708
TOSHIBA	709

CABLE

BRAND	SETTING No.
GENERAL INSTRUMENTS	500
GEMINI	501
HAMLIN	502, 503, 504, 505
JERROLD	500, 506, 507, 508, 509, 510, 511, 512, 513, 514
MACOM	515, 516, 517
MAGNAVOX	518
OAK	519, 520, 521
PANASONIC	522, 523
PHILIPS	524, 525, 526, 527, 528, 529
PIONEER	530, 531
SCIENTIFIC ATLANTA	532, 533, 534
SAMSUNG	535
TOCOM	536
ZENITH	537, 538

VCR

BRAND	SETTING No.
AIWA	300, 301, 302
AKAI	303, 304, 305, 306, 307
BAIRD	308
BELL & HOWELL	309
BLAUPUNKT	310
CGM	311, 312, 313
COLTINA	314
DAEWOO	315, 316
DIGITAL	317
EMERSON	318, 319, 320, 321, 322
FENNER	323
FISHER	324, 325, 326, 327
FUJITSU GENERAL	328
FUNAI	329
GE	330, 331
GO VIDEO	332, 336, 337
GOLDSTAR	333, 334
GOODMANS	335
GRUNDIG	338
HITACHI	339, 340, 341
JVC	342, 343, 344, 345, 346, 347, 348, 349, 350
LOEWE	351, 352
MAGNAVOX	353, 354, 355
MITSUBISHI	356, 357, 358, 359, 360, 361, 362, 363, 364
NEC	365, 366, 367
NOKIA	313
NORDMENDE	368, 369, 370
OKANO	371, 372
ORION	319, 373
PANASONIC	374, 375, 376, 377, 378
PHILIPS	353, 379, 380
PHONOLA	311
PIONEER	381
RCA	382
SABA	383
SAMSUNG	384, 385, 386, 387, 388, 389, 390
SANYO	391, 392, 393
SCOTT	394
SELECO	395
SHARP	396, 397, 398, 399
SHINTOM	400
SIEMENS	401
SONY	402, 403, 404, 405, 406, 407, 408, 409, 410, 411, 412, 413
SYMPHONIC	414
TEKNIKA	414, 415
TELEFUNKEN	416, 417
TOSHIBA	418, 419, 420
WHITE WESTINGHOUSE	333
WATSON	421
ZENITH	422

TV

BRAND	SETTING No.
AIWA	100, 101
AKAI	102, 103, 104
AUDIOSONIC	105
BELL & HOWELL	106
BLAUPUNKT	107
BRIONVEGA	108, 109
CENTURION	110
COLTINA	111, 112, 113
CORONAD	114
CROWN	115, 116
DAEWOO	117, 118, 119, 120, 121
DUAL	122
EMERSON	123, 124, 125, 126, 127
FENNER	128, 129
FERGUSON	130, 131
FISHER	132
FUNAI	133, 134, 135
FUJITSU GENERAL	136, 137, 138
GE	139, 140, 141
GOLDSTAR	142, 143
GOODMANS	144
GRUNDIG	145, 146
HITACHI	147, 148, 149, 150
HYPER	151
INNO HIT	152
IRRADIO	103
JVC	153, 154, 155, 156, 157
KENDO	158
KTV	159, 160
LUXOR	161
MAGNAVOX	162, 163
MARANTZ	164
MARK	165
MATSUI	166, 167, 168, 169
MITSUBISHI	170, 171, 172, 173
MIVAR	174, 175
NEC	176, 177
NOKIA	178, 179, 180, 181
OCEANIC	181
NORDMENDE	182, 183
OKANO	152
ORION	184, 185, 186
PANASONIC	187, 188, 189, 190
PHILIPS	152, 162, 191
PIONEER	192, 193
PROSCAN	194
QUASAR	195
RADIO SHACK	196
RCA	110, 141, 197, 198, 199, 200
SABA	182, 183, 201
SAMSUNG	202, 203, 204, 205, 206, 207, 208
SANYO	209, 210, 211, 212
SCHNEIDER	103
SEARS	213
SELECO	214, 215
SHARP	216, 217
SONY	218, 219, 220, 221, 222, 223
SYMPHONIC	224, 225
TELEFUNKEN	201, 226, 227
THOMSON	228
TOSHIBA	213, 229
UNIVERSUM	230
ZENITH	231, 232

Operating Other Manufacturers' Devices Using the Remote Controller— Continued

Operating Other Manufacturers' Devices

After entering a pre-programming by following the procedure given above, the following modes become enabled for use.

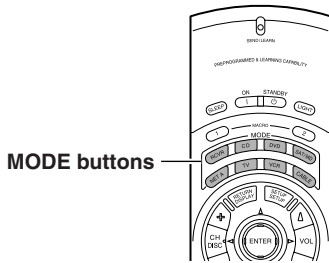

1 Press the MODE button.

- When operating the satellite tuner unit, press the SAT/MD MODE button.
- When operating the cable TV unit, press the CABLE MODE button.
- When operating the VCR, press the VCR MODE button.
- When operating the television, press the TV MODE button.
- When operating the DVD player, press the DVD MODE button. The buttons you can use for operation are same as the ones described on page 80.

2 Point the remote controller at the component and press the desired operation button.

SAT MODE

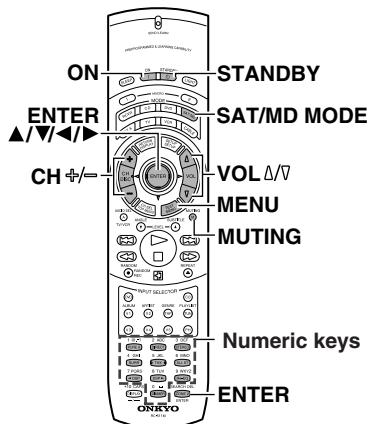

CABLE MODE

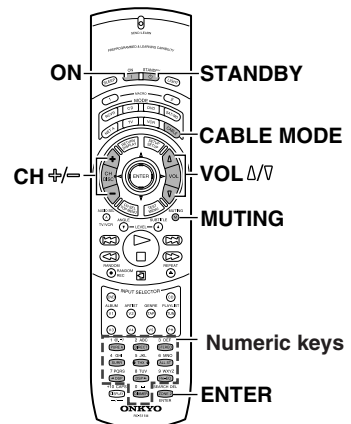

ON	Turns on and off satellite tuner unit (same as STANDBY button on the remote controller)	Turns on and off cable TV unit (same as STANDBY button on the remote controller)
CH +/-	Changes selected preset channel	Changes selected preset channel
▲/▼/◀/▶	Moves cursor	
ENTER	Confirms selection	
MENU	Displays menu	
0, 1 to 9	Numeric keys	Numeric keys
ENTER	Confirm	Confirm
VOL Δ/∇	Adjusts the volume at the TX-NR801/TX-NR801E	
MUTING	Activates the muting function at the TX-NR801/TX-NR801E	

Operating Other Manufacturers' Devices Using the Remote Controller— Continued

VCR MODE	TV MODE

ON	Turns on and off the VCR (same as STANDBY button on the remote controller)	Turns on and off the television (same as STANDBY button on the remote controller)
CH +/-	Changes selected preset channel	Changes television channel
TV/VCR	Switches VCR input setting	Switches television input setting
0, 1 to 9, +10		Numeric keys
	Play	
	Stop	
	Rewind	
	Fast Forward	
	Pause	
0, 1 to 9, +10	Numeric keys	
ENTER		Confirm
VOL Δ/∇	Adjusts the volume at the TX-NR801/TX-NR801E	Adjusts volume at television
MUTING	Activates the muting function at the TX-NR801/TX-NR801E	Activates muting function at television

Letting the Remote Controller Learn the Codes from Other Remote Controllers

Programming Procedure

When programming the commands of another remote controller to the RC-511M remote controller, you must first decide under to which MODE button you want the commands to be linked. In general, you will select the MODE button that corresponds to the component you are programming. For example, if you are programming the functions from a remote controller for a compact disc player, you would choose the CD MODE button. Then, by pressing the CD MODE button, the buttons on the RC-511M remote controller will change to the commands you program here to operate the compact disc player. After programming which MODE button to use, you will then transfer the separate commands from the other remote controller over to the RC-511M remote controller one at a time. Each command is then programmed to a different button on the RC-511M remote controller. Any button is programmable for this step except for the eight MODE buttons (RCVR, CD, DVD, SAT/MD, NET A, TV, VCR, and CABLE), the two MACRO buttons (1 and 2), and the LIGHT button. Even after the commands have been memorized, keep your old remote controller in a safe place. If for some reason the commands are lost (e.g., when the batteries run down), it will be necessary to memorize them once again.

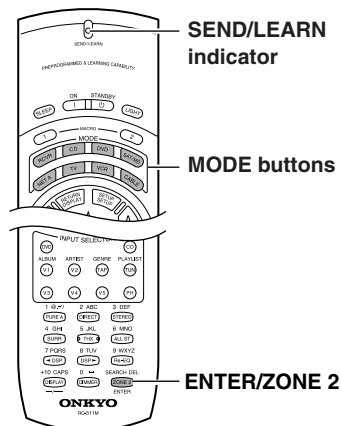

- 1** Place the remote controller and the remote controller for the other device facing each other at a distance of 2 to 6 inches (5 to 15 cm) apart.

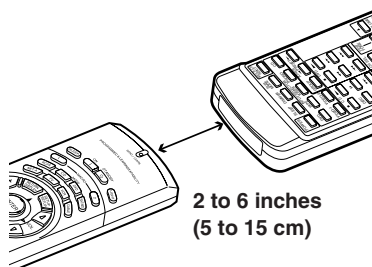

- 2** While pressing and holding down the desired MODE button on the remote controller, press the ENTER/ZONE 2 button and then release both buttons.

The SEND/LEARN indicator lights when the MODE button is pressed and turns off when the ENTER button is pressed. When the indicator turns off, release both buttons. The SEND/LEARN indicator lights again.

- 3** Press and release the button on the remote controller to which you want to transfer the next command.

You may select any button excluding the eleven ones indicated in the figure below. When you press the button, the SEND/LEARN indicator turns off. When you release the button, the indicator lights again.

If you press the wrong button by mistake, press that same button again. The SEND/LEARN indicator flashes twice, and the remote controller exits the programming mode.

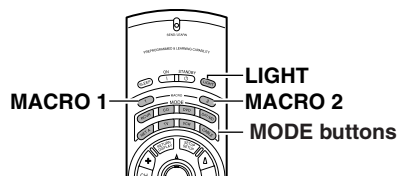

- 4** Press and hold down the button (that corresponds to the command you are programming) on the remote controller of the other device until the SEND/LEARN lamp on the remote controller flashes twice.

After flashing twice, the SEND/LEARN indicator will light again.

- 5** Repeat Steps 3 and 4 to transfer all the commands you desire from the other remote controller and program them to buttons on the remote controller under the same MODE.

Repeat Steps 2 through 4 to program commands to a different MODE (e.g., when programming from a different remote controller).

- 6** Press the MODE button that you pressed in step 2 to complete the programming.

- 7** Operate the newly programmed buttons to make sure the learning function was performed properly.

Letting the Remote Controller Learn the Codes from Other Remote Controllers—Continued

Notes:

- The remote controller codes for Onkyo compact disc players, cassette tape decks, DVD players, and mini disc recorder have already been programmed into buttons on the remote controller. You may, however, use these buttons to program the codes for other remote controllers. If you wish to restore the Onkyo preset codes after you program new codes, you must first erase the new codes (See this page).
- The remote controller has 408 memory slots (8 modes × 51 buttons). Some remote controllers may have more commands than can be remembered by the remote controller. In such cases, it will be necessary for you to determine which commands are more important to you.
- If the SEND/LEARN indicator quickly flashes three times and turns off, then the remote controller has exited the programming mode because either you have made a mistake during programming or a time-out has occurred because no button was pressed. Resume from Step 2.
- If you try to program beyond the learning capacity of the remote controller, the SEND/LEARN indicator flashes six times quickly, and the remote controller exits the programming mode. Try programming under a different MODE button.
- When you want to program a command to a button to which you have already programmed a command, simply follow the same procedure given and the previous programming for that button will be overwritten.
- The remote controller uses infrared rays to send its commands, as do most other remote controllers. Though most remote controller codes can be memorized by the remote controller, be aware that some remote controllers use systems that are quite different from the remote controller and therefore may not be able to be programmed.
- Some remote controllers have a single button that performs multiple functions (for example, the function may change each time the button is pressed). If this is the case, each function must be programmed to a separate button on the remote controller.
- Once you have transferred the commands from the other remote controller, refer to the instruction manual that came with that product for instructions on how to operate that product.
- Make sure both the remote controller and the other remote controller have new batteries. If either of them has batteries that are low, you may not be able to program the commands of the other remote controller properly into the remote controller.

Erasing the programmed command from one button

You can only erase memorized commands and not preset ones.

- 1 Press and hold down the MODE button for the command, press the ENTER/ZONE 2 button, and then release both buttons.**
When you press the MODE button, the SEND/LEARN indicator lights. When you press the ENTER/ZONE 2 button, the lamp turns off. When you release the buttons, the lamp lights again.
- 2 Press and release the button for the command you wish to erase.**
When you press the button, the SEND/LEARN indicator turns off. When you release the button, the lamp lights again.
- 3 Press and release the same button again.**
The SEND/LEARN lamp slowly flashes twice. The memorized command is erased.

Note:

If no button is pressed for more than 30 seconds during the erasing procedure, the SEND/LEARN indicator flashes three times quickly, and the remote controller exits the erasing mode. Resume from Step 1.

Erasing all the commands programmed under a MODE button

- 1 Press and hold down the desired MODE button, press the ENTER/ZONE 2 button twice, and then release both buttons.**
When you press the MODE button, the SEND/LEARN indicator lights. When you press the ENTER/ZONE 2 button, the lamp turns off. When you release the buttons, the lamp slowly flashes twice and then lights again.
- 2 Press and release the same MODE button again.**
When you release the button, the SEND/LEARN indicator slowly flashes twice. This erases all the commands memorized to the MODE button.

Notes:

- If no button is pressed for more than 30 seconds during the erasing procedure, the SEND/LEARN indicator flashes three times quickly and the remote controller exits the erasing mode. Resume from Step 1.
- If you perform an invalid operation during erasing, the SEND/LEARN indicator flashes three times quickly, and the remote controller exits the erasing mode. Resume from Step 1.
- If many commands have been programmed to the MODE button, then the SEND/LEARN indicator may remain lit for up to 20 seconds during Step 2. This is not a malfunction.

Executing the Macro

Perform the procedure below to execute the macro that you have programmed into the remote controller. After programming the macro, you should always run it at least once to make sure that it has been programmed properly.

- 1 Point the remote controller at the TX-NR801/TX-NR801E.**
- 2 Press the MACRO 1 (or 2) button.**
It may take a while for the macro to finish transmitting, so be sure to continue pointing the remote controller at the device until the SEND/LEARN indicator turns off.

Erasing a macro from the MACRO 1 (or 2) button

- 1 Press and hold down any one of the 8 MODE buttons, press the MACRO 1 (or 2) button, and then release both buttons.**
When you press the MODE button, it lights and the SEND/LEARN indicator lights. When you press the MACRO 1 (or 2) button, the indicator turns off. When you release the buttons, the indicator flashes once.
- 2 Press the MACRO 1 (or 2) button again.**
The SEND/LEARN indicator slowly flashes twice. The macro programmed to the MACRO button is erased.

Notes:

- If the SEND/LEARN indicator quickly flashes three times and turns off, then the remote controller has exited the erasing mode because either you have made a mistake during erasing or a time-out has occurred because no button was pressed. Resume from Step 1.
- If you press a button other than MACRO 1 (or 2) button in Step 2, then you will in effect be overwriting the previous macro with a new macro.

Erasing all commands and macros that have been programmed

This procedure will erase all the commands and macros that you have programmed into the remote controller and return it to its default settings. This operation will not affect the preset settings of the remote controller.

- 1 Open the battery cover and remove the batteries from the remote controller.**
- 2 While pressing and holding down the ON and STANDBY buttons, re-insert the batteries in their correct orientation, and then release both buttons.**
The SEND/LEARN indicator flashes slowly.
- 3 Press the ENTER/ZONE 2 button.**
The SEND/LEARN indicator lights up for about ten seconds and then turns off.

All programmed commands and macros are erased and the remote controller returns to its factory presets.

Notes:

- Proceed to Step 3 immediately after Step 2; otherwise, the batteries will be consumed quickly.
- If you press any button other than the ENTER/ZONE 2 button in Step 3, nothing will be erased. In this case, resume from Step 1.

Macro mode programming memo

	MACRO 1	MACRO 2
1		
2		
3		
4		
5		
6		
7		
8		
9		
10		
11		
12		
13		
14		
15		
16		

Troubleshooting Guide

If a problem occurs while you are using the remote controller, first try to operate the controls on the front panel of the TX-NR801/TX-NR801E to make sure that it is not due to a malfunction (or dead batteries) in the remote controller.

	Symptoms	Causes	Remedies
POWER	No power.	Power cord is disconnected.	Connect power cord (See page 27).
		External noise is affecting the internal microcomputer.	Turn off the power, wait five seconds, and then turn the power back on (See page 27).
	Power turns on but no sound.	“Muting” is displayed.	Press the MUTING button on the remote controller to turn off muting (See page 39).
		Bad connections or wiring.	Check connections, speaker cables, and other wiring (See pages 18 to 26).
	Sound of playback source is not heard.	Input selector is not set properly.	Set to correct input source (See page 39).
Headphones are connected.		Lower volume and then disconnect headphones (See page 39).	
	Power shuts off immediately after power on.	Amplifier protection circuitry is activated.	Remove the power cord from outlet immediately. Contact your Onkyo service center.
SPEAKERS	No sound from the center speaker, or at very low volume.	Speaker cable is not connected.	Check the connection between TX-NR801/TX-NR801E and speaker (See page 18).
		Listening mode is set to Stereo, Pure Audio or Direct.	Set the Listening mode to any mode other than Stereo, Pure Audio or Direct. The output to the center speaker may differ depending on the listening mode (See page 42).
		Center speaker volume is set to minimum.	Set the center speaker level to the appropriate volume (See pages 34, 35).
		The Center setting is set to “None.”	Set the Center setting to “Large” or “Small” at Setup Menu → Speaker Setup Menu → Speaker Config Sub-menu (See page 33).
	No sound or very low volume from subwoofer.	Subwoofer setting is set to “No.”	Set the Subwoofer setting to “Yes” at Setup Menu → Speaker Setup Menu → Speaker Config Sub-menu (See page 33).
		Subwoofer volume is set to minimum.	Set the subwoofer level to the appropriate volume (See pages 34, 35).
	Low frequency humming is heard.	Not properly grounded.	Check outer conductor of input plugs.
		Turntable motor is not properly grounded.	Check for proper ground connection.
		Audio connection cables on the rear panel are connected incorrectly.	Adjust the placement of the cables to reduce hum.
	Howling is heard when the volume is turned up.	Turntable and speakers are located too close together.	Move them farther apart.
	Rough or scratchy sound is heard. High range is not clear.	Turntable needle is dirty or worn, or a problem exists with a connected component.	Refer to the instructions of the connected components and check for problems.
		Treble control is too high.	Turn treble setting down at Setup Menu → Audio Adjust Menu → Tone Control Sub-menu (See page 54).
FM/AM TUNER	AM stations cannot be received.	AM loop antenna is not connected.	Connect the included AM loop antenna to the AM antenna terminals (See page 14).
	Buzzing noise on AM stations (particularly noticeable at night or with weak stations).	Noise from electrical apparatus such as fluorescent lamp.	Move the AM loop antenna to different position. Set up an outdoor AM antenna (See page 15).
		Noise is heard at high-pitched sounds on AM stations.	Noise caused by TV set.

	Symptoms	Causes	Remedies
FM/AM TUNER	Crackling noise on both AM and FM stations.	Noise caused by fluorescent lamp being turned on and off.	Move antenna as far as possible from the fluorescent lamp.
		Noise from automobile ignition.	Install an FM outdoor antenna as far as possible from the road (See page 15). Change the position or direction of the outdoor antenna.
	Stereo indicator lights, but sound is distorted and stereo separation is bad.	Station is too strong.	Change to FM indoor antenna (See page 14).
		Multiple reflection of the radio waves because of tall buildings or mountains.	Use antenna that has better directivity and orient it so distortion decreases.
	Indicators for stereo reception flicker and hiss is heard on FM stations.	Station is too weak.	Install an outdoor FM antenna (See page 15).
		Stereo FM broadcasts cover only about half the distance of an ordinary broadcast.	Change the position or direction of the outdoor antenna (See page 15).
No preset station is recalled.	Memory is lost because power has been turned off for a long time.	Store all stations again (See page 47).	
VIDEO and AUDIO	Desired picture does not appear.	Improper connection.	Check connections. Insert the plugs and connectors completely (See pages 20 to 23).
		Video Setup Sub-menu settings are incorrect.	Check settings at Setup Menu → Input Setup Menu → Video Setup Sub-menu (See page 38).
	No OSD Menu display.	Improper connection.	Check connections (See pages 20 to 23).
	Audio and video do not match.	Improper connection.	Check connections (See pages 20 to 23).
		Video Setup Sub-menu settings are incorrect.	Check settings at Setup Menu → Input Setup Menu → Video Setup Sub-menu (See page 38).
	Audio is not heard or audio from different source is heard.	Digital Setup Sub-menu settings are incorrect.	Check settings at Setup Menu → Input Setup Menu → Digital Setup Sub-menu (See page 36).
No picture appears on the TV screen (or monitor).	TV (or monitor) is not set to receive the output signals from the receiver.	Set the TV (or monitor) to the receiver input.	
	Video connection cable is not connected securely.	Check connections (See pages 20 to 23).	
	Input source is connected to the COMPONENT VIDEO IN connectors.	Make sure TV (or monitor) is connected to COMPONENT VIDEO OUT connectors (See page 20).	
NET AUDIO	Pressing the NET AUDIO button on the main unit (or the NET A button on the remote controller) fails to activate the Internet radio or music server feature.	Imperfect network connection.	Check the connection between this unit and the LAN side port of your router (gateway) (See page 71).
			Make sure that the modem and router (gateway) are correctly connected. Also, make sure that the power is on (See page 71).
			Make sure that the Network Setup is configured properly (See pages 72 to 74).
The playback sound discontinues while using the Music Server.	Excessive load on the network or server. Or processor-intensive applications including word processor and spreadsheet are running.	Make sure that your system satisfies all the system requirements listed on page 70.	
		When you download or copy a large file on the PC, the playback sound may discontinue. In such a case, upgrade your PC to a higher performance model or close unnecessary applications. And it is recommended that you deploy a new server PC dedicated to Net-Tune Central. When you play WAVE files on multiple TX-NR801/TX-NR801E, the playback sound may discontinue because of network overload. In this case, deploying another independent LAN dedicated to the Net Audio to separate it from the general LAN connection, or adding a switching hub or router to improve network traffic may resolve the problem.	
The unit fails to obtain a station list from an Internet radio site (via the XiVA internet Radio Service).	The radio site is now out of service or otherwise inaccessible due to some other reason such as maintenance.	Try to access the site again at a later time.	

Troubleshooting Guide—Continued

	Symptoms	Causes	Remedies
NET AUDIO	Selecting the “Music Server” fails to play music or fails to connect to the server.	Your PC is not turned on, or Net-Tune Central is not running.	Turn on your PC, and start Net-Tune Central.
		No audio files found on the server.	Create MP3, MWA, and/or WAV audio files on your PC, and use Net-Tune Central to create the list of audio files saved on your PC.
		The network is down because of some failures.	Turn off the power of the TX-NR801/TX-NR801E and turn it on again (When the TX-NR801/TX-NR801E is without a power switch, unplug the power cord and plug it in again). If this does not resolve the problem, reboot the PC running the Net-Tune Central server.
		The NTSP Port setting on the TX-NR801/TX-NR801E differs from that of Net-Tune Central.	Go to “5-4. Client Setup Sub-menu,” select “c. NTSP Port;” then set the same value as used for Net-Tune Central (See page 74).
	Search by album returns no match.	The audio file list of Net-Tune Central contains no files that have album names.	Assign album names to the files contained in the audio file list of Net-Tune Central.
	Search by artist returns no match.	The audio file list of Net-Tune Central contains no files that have artist names.	Assign artist names to the files contained in the audio file list of Net-Tune Central.
	Search by genre returns no match.	The audio file list of Net-Tune Central contains no files that have genre names.	Assign genre names to the files contained in the audio file list of Net-Tune Central.
No playlist can be selected.	You have not yet created any playlists in Net-Tune Central.	Create playlists in Net-Tune Central.	
The Net Audio information is not displayed.	Depending on the model’s shipping destination, the information on NET AUDIO and Immediate Display may not be displayed when the component video signal is output.	Set the Component Video setting to “VIDEO” at Input Setup Menu → Video Setup Sub-Menu.	
REMOTE CONTROLLER	Front panel controls function but remote controller controls do not.	No batteries in remote controller.	Insert batteries (See page 7).
		Batteries are dead.	Replace batteries (See page 7).
		Remote controller is not pointed at the remote sensor of the TX-NR801/TX-NR801E.	Point the remote controller at the remote sensor of the TX-NR801/TX-NR801E (See page 7).
		Remote controller is too far from the TX-NR801/TX-NR801E.	Operate the remote controller within 16 feet (5 meters) (See page 7).
		Remote controller is functioning in a different mode.	Press the RCVR MODE button.
OTHER	LATE NIGHT function cannot be used.	Playback source is not Dolby Digital encoded.	Check that the DOLBY DIGITAL indicator lights up on the display (See page 55).
	Re-EQ function cannot be used.	Re-EQ may not be able to be set due to current listening mode.	Select different listening mode (See page 55).
	Desired parameter cannot be set.	Parameter may not be able to be set due to current listening mode.	Check settings in Audio Adjust Menu (See pages 57 to 61).
	Multichannel audio is not output.	The Multichannel setting is set to “No.”	Set the Multichannel setting to “Yes” at Setup Menu → Input Setup Menu → Multichannel Setup Sub-menu (See page 64).
		Input source is not connected to MULTI CH INPUT port.	Check connections (See page 64).
	Components in remote zone (Zone 2) do not operate properly.	Components are incorrectly connected.	Check connections (See page 66).
		Objects are interfering with remote controller signals.	Move inferring objects away from path of remote controller signals.
	Sound is sometimes heard and sometimes not heard with digital sources.	One digital input format has been specified so other digital formats are not played.	Select “All” at Setup Menu → Input Setup Menu → Digital Setup Sub-menu → Digital Format (See page 37).
	Noise during playback or skipping of the beginning sounds occurs with DTS sources, PCM sources and other digital sources.	When “All” is set for the digital format setting, time is required to change formats when different sources are played.	Try specifying the format you are playing at Setup Menu → Input Setup Menu → Digital Setup Sub-menu → Digital Format (See page 37).
The unit cannot be switched to Dolby EX or DTS-ES mode.	“Surr Back/Zone 2” is set to “Zone 2.”	Change the Hardware Setup → Surr Back/Zone 2 Sub-menu setting to Surr Back (See page 30).	

If One of the Messages Shown Below Appears

“Not available with headphones use”

Operation not allowed because headphones are plugged into the TX-NR801/TX-NR801E.

“Not available with Multichannel use”

Operation not allowed while the multichannel output is being used.

“Not available in this Sp Config”

Will not work with the current speaker configuration settings.

“Not available in Zone 2 mode”

Setting not allowed because the Zone 2 mode is turned on.

“Only available with Dolby D”

No setting other than Dolby Digital can be set.

“Not available in this Listening mode”

Will not work with the current listening mode.

“Not available with this signal”

The listening mode cannot be selected with the current input source.

“Not available in Pure Audio mode”

Will not work with the Pure Audio mode.

“Surr Back/Zone 2 setting is Surr Back”

Operation not allowed because the setting is Surr Back.

“Surr Back/Zone 2 setting is Zone 2”

Operation not allowed because the setting is Zone 2.

“Not available with Muting”

Operation not allowed because the muting is activated.

“Zone 2 is not On”

Will not work because Zone 2 has not been turned on.

Also refer to the respective instruction manuals of the CD player, DVD player, video cassette recorder, TV monitor, etc., that comprise your entertainment system.

The TX-NR801/TX-NR801E contains an internal microcomputer that performs high-level operations.

However, on extremely rare occasions, noise or interference from an external source or static electricity may cause faulty operation. If this occurs, unplug the power cord from the wall outlet, wait five or more seconds, and then plug it back in. This should correct the situation.

* To reset the surround mode and other settings to the factory default settings, hold down the VIDEO 1 button with the TX-NR801/TX-NR801E turned on and then press the STANDBY/ON button. “CLEAR” appears in the front display and the TX-NR801/TX-NR801E enters the standby state.

Specifications

AMPLIFIER SECTION

Continuous average power output (FTC) (USA and Canadian models):

All channels: 100 W per channel min. RMS into 8 Ω , 2 channels driven from 20 Hz to 20 kHz with no more than 0.08% total harmonic distortion.
130 W min. RMS into 6 Ω , 2 channels driven, 1 kHz with no more than 0.1% total harmonic distortion.

Continuous power output (DIN)

(European model): 135 W at 6 Ω

Maximum power output (EIAJ)

(Asian model): 160 W at 6 Ω

Dynamic power output (stereo) 2×250 W at 3 Ω

2×210 W at 4 Ω

2×130 W at 8 Ω

Total Harmonic Distortion: 0.08% at rated power

0.08% at 1 W output

IM Distortion: 0.08% at rated power

0.08% at 1 W output

Damping factor:

60 at 8 Ω

Input sensitivity and impedance

PHONO: 2.5 mV, 50 k Ω

LINE (CD, TAPE, DVD,

VIDEO 1-5): 200 mV, 50 k Ω

MULTICHANNEL INPUT

(FRONT L/C/R, SUR-

ROUND L/R, SURROUND

BACK L/R): 200 mV, 50 k Ω

(SUBWOOFER): 36 mV, 50 k Ω

COAXIAL 1, 2, 3 (DIGI-

TAL): 0.5 V_{p-p}, 75 Ω

DVD, VIDEO 1, 2, 3, 4, 5: 1 V_{p-p}, 75 Ω (Composite Video)

1 V_{p-p}, 75 Ω (S-Video, Y signal)

0.28 V_{p-p}, 75 Ω (S-Video, C signal)

COMPONENT VIDEO 1, 2: 1 V_{p-p}, 75 Ω (Y)

0.7 V_{p-p}, 75 Ω (P_B/C_B, P_R/C_R)

Output level and impedance

Rec out (TAPE, VIDEO 1,2): 200 mV, 470 Ω

Pre out: 1 V, 470 Ω

ZONE 2 OUT: 100 mV, 470 Ω

VIDEO (VIDEO 1, 2, MONI-

TOR OUT, ZONE 2 OUT): 1 V_{p-p}, 75 Ω (Composite Video)

S-VIDEO (VIDEO 1, 2,

MONITOR OUT): 1 V_{p-p}, 75 Ω (S-Video, Y signal)

0.28 V_{p-p}, 75 Ω (S-Video, C signal)

COMPONENT VIDEO OUT: 1 V_{p-p}, 75 Ω (Y)

0.7 V_{p-p}, 75 Ω (P_B/C_B, P_R/C_R)

120 mV RMS at 1 kHz, 0.5%

T.H.D.

Frequency response: 10 Hz to 100 kHz: +1/-3 dB (CD

in Direct mode)

RIAA deviation: 20 Hz to 20 kHz: ± 0.8 dB

Tone Control

Bass: ± 10 dB at 50 Hz

Treble: ± 10 dB at 20,000 Hz

Signal-to-noise ratio (direct)

PHONO: 80 dB (IHF A, 5 mV input)

Line: 110 dB (IHF A, 0.5 V input)

Ethernet port: 100BASE-TX

Supported audio file format: MP3, WMA, WAV (non-compres-

sion, sampling rates of 32 kHz,

44.1 kHz, and 48 kHz supported)

TUNER SECTION

FM

Tuning range

USA & Canadian models: 87.50–108.00 MHz (100 kHz steps)

Other models: 87.50–108.00 MHz (50 kHz steps)

Usable sensitivity

Mono: 11.2 dBf, 1.0 μ V (75 Ω , IHF) 0.9 μ V (75 Ω , DIN)

Stereo: 17.2 dBf, 2.0 μ V (75 Ω , IHF) 23 μ V (75 Ω DIN)

50 dB quieting sensitivity

Mono: 17.2 dBf, 2.0 μ V (75 Ω)

Stereo: 37.2 dBf, 20.0 μ V (75 Ω)

Capture ratio: 2.0 dB

Image rejection ratio

USA & Canadian models: 40 dB

Other models: 85 dB

IF rejection ratio: 90 dB

Signal-to-noise ratio

Mono: 76 dB

Stereo: 70 dB

Alternate channel attenuation: Mono 55 dB

Selectivity: 50 dB (DIN)

AM suppression ratio: 50 dB

Total harmonic distortion

Mono: 0.2%

Stereo: 0.3%

Frequency response: 30 Hz–15 kHz, ± 1.0 dB

Stereo separation: 45 dB at 1 kHz

30 dB at 100 Hz–10 kHz

AM

Tuning range

USA & Canadian models: 530–1,710 kHz (10 kHz steps)

Other than worldwide models: 522–1,611 kHz (9 kHz steps)

Worldwide models: 522–1,611 kHz (9 kHz steps), or

530–1,710 kHz (10 kHz steps)

Usable sensitivity: 30 μ V

Image rejection ratio: 40 dB

IF rejection ratio: 40 dB

Signal-to-noise ratio: 40 dB

Total harmonic distortion: 0.7%

GENERAL

Power supply

USA & Canadian models: AC 120 V, 60 Hz

European & Australian mod-

els: AC 230–240 V, 50 Hz

Some Asian models: AC 220–230 V, 50/60 Hz

Worldwide models: AC 220–230 V and 120 V switch-

able, 50/60 Hz

Power consumption

USA & Canadian models: 8.1 A

Other models: 655 W

Dimensions (W \times H \times D): 435 \times 175 \times 459 mm

17-1/8" \times 6-7/8" \times 18-1/16"

Weight

USA & Canadian models: 16.8 kg (37.1 lbs)

Other models: 17.8 kg (39.3 lbs)

Specifications and features are subject to change without notice.

Memo

ONKYO CORPORATION

Sales & Product Planning Div. : 2-1, Nisshin-cho, Neyagawa-shi, OSAKA 572-8540, JAPAN
Tel: 072-831-8023 Fax: 072-831-8124

ONKYO U.S.A. CORPORATION

18 Park Way, Upper Saddle River, N.J. 07458, U.S.A.
Tel: 201-785-2600 Fax: 201-785-2650 <http://www.onkyousa.com>

ONKYO EUROPE ELECTRONICS GmbH

Liegnitzerstrasse 6, 82194 Groebenzell, GERMANY
Tel: +49-8142-4401-0 Fax: +49-8142-4401-555 <http://www.onkyo.net>

ONKYO CHINA LIMITED

Units 2102-2107, Metroplaza Tower I, 223 Hing Fong Road, Kwai Chung,
N.T., HONG KONG Tel: 852-2429-3118 Fax: 852-2428-9039



Free Manuals Download Website

<http://myh66.com>

<http://usermanuals.us>

<http://www.somanuals.com>

<http://www.4manuals.cc>

<http://www.manual-lib.com>

<http://www.404manual.com>

<http://www.luxmanual.com>

<http://aubethermostatmanual.com>

Golf course search by state

<http://golfingnear.com>

Email search by domain

<http://emailbydomain.com>

Auto manuals search

<http://auto.somanuals.com>

TV manuals search

<http://tv.somanuals.com>