

Audio Video Control Tuner Amplifier

TX-SV535

Instruction Manual

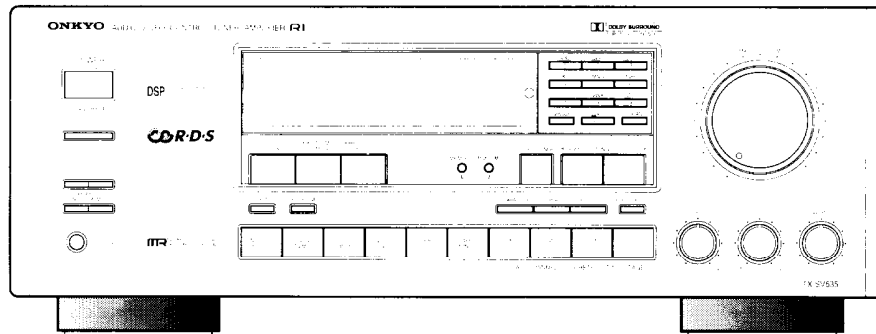

CONTENTS

Features	2	Control positions and names	16
Important Safeguards	3	Listening to your favourite source	18
Precautions	4	Using the tuner	20
Supplied accessories	4	Receiving RDS (European model only)	22
Before using this unit	5	Entering station names (European model only)	24
Explanation	6	Use of surround mode	25
Speaker placement	7	Recording a source	27
Audio equipment connections	8	Listening to devices connected to this unit in another room	30
Video equipment connections	9	Trouble shooting guide	31
Speaker connections	10	Specifications	32
Optional power amplifier connections	11		
Antenna connections	12		
Connection for Multiple-Room Remote Control	14		

Thank you for your purchase of the Onkyo A/V Tuner Amplifier.

Please read this manual thoroughly before making connections and turning on the power.

Following the instructions in this manual will enable you to obtain optimum performance and listening enjoyment from your new A/V Tuner Amplifier.

Please retain this manual for future reference.

Features

■ Powerful A/V Receiver with Discrete Outputs

Plenty of pristine power drives your home theater system to perfection. In surround mode you get 65 watts per channel (8 ohms) to your front L/R and center speakers, plus 25 watts per channel to your L/R surround speakers.

Stereo mode: 80 watts per channel (8 ohms). Discrete output stage circuitry for all channels contributes and heavy-duty power supplies help the TX-SV535 excel at driving accurately the most demanding low-impedance speakers.

■ Dolby Pro Logic & 4 Digital Soundfields

In addition to fully digital Dolby Pro Logic (for the most accurate surround sound), your TX-SV535 gives you a choice of four ambience-producing DSP surround modes (Theater, Hall, Live and Arena) so you can select the listening environment that best suits your source and your mood.

■ IPM System

Onkyo's Intelligent Power Management (IPM) system switches on the TX-SV535 and automatically selects Video-1 when you turn on your TV, giving you instant surround sound.

■ Multiroom and Multisource Capability

You can listen to a CD in the bedroom while someone else enjoys the radio or any other source in the main room. (Requires additional speakers and optional accessories. The necessary accessories may differ, depending on area where sold. Your authorized Onkyo service center has details.)

■ RI Compatible Remote Control

■ Useful Extras You'll Enjoy

- 3 Video and 6 audio Inputs
- Heavy-duty, multiway binding posts for front L/R speakers
- 30 Random FM/AM presets and 3-group classification
- Recording selector
- Selective tone control
- All channels Preout terminals
- Automatic FM scanning
- Motor-driven volume control
- Battery-free memory backup
- Sleep timer
- RDS (European model only)

Declaration of Conformity

We, ONKYO EUROPE
ELECTRONICS GMBH
INDUSTRIESTRASSE 18/20
82110 GERMERING,
GERMANY



declare in own responsibility, that the ONKYO product described in this instruction manual is in compliance with the corresponding technical standards such as EN55013, EN55020, EN60555-2, EN60065

GERMERING, GERMANY

K. KOBAYASHI

ONKYO EUROPE ELECTRONICS GMBH

FOR USA MODEL

Note to CATV system installer:

- This reminder is provided to call the CATV system installer's attention to Section 820-40 of the NEC which provides guidelines for proper grounding and, in particular, specifies that the cable ground shall be connected to the grounding system of the building, as close to the point of cable entry as practical.

FCC INFORMATION FOR USER

CAUTION:

Changes or modifications not expressly approved by the manufacturer for compliance could void the user's authority to operate the equipment.

NOTE:

This equipment has been tested and found to comply with the limits for a Class B digital device, pursuant to Part 15 of the FCC Rules. These limits are designed to provide reasonable protection against harmful interference in a residential installation. This equipment generates, uses, and can radiate radio frequency energy and, if not installed and used in accordance with the instructions, may cause harmful interference to radio communications. However, there is no guarantee that interference will not occur in a particular installation. If this equipment does cause harmful interference to radio or television reception, which can be determined by turning the equipment off and on, the user is encouraged to try to correct the interference by one or more of the following measures:

- Reorient or relocate the receiving antenna.
- Increase the separation between other equipment and receiver.
- Connect the equipment into an outlet on a circuit different from that to which other receiver is connected.
- Consult the dealer or an experienced radio/TV technician for help.

FOR CANADIAN MODEL: (POUR LE MODELE CANADIEN)

- For models having a power cord with a polarized plug.

CAUTION: TO PREVENT ELECTRIC SHOCK, MATCH WIDE BLADE OF PLUG TO WIDE SLOT, FULLY INSERT.

- THIS DIGITAL APPARATUS DOES NOT EXCEED THE CLASS B LIMITS FOR RADIO NOISE EMISSION FROM DIGITAL APPARATUS SET OUT IN THE RADIO INTERFERENCE REGULATIONS OF THE CANADIAN DEPARTMENT OF COMMUNICATIONS.

- Sur les modèles dont la fiche est polarisée.

ATTENTION: POUR ÉVITER LES CHOCs ÉLECTRIQUES, INTRODUIRE LA LAME LA PLUS LARGE DE LA FICHE DANS LA BORNE CORRESPONDANTE DE LA PRISE ET POUSSER JUSQU'AU FOND.

- L'INTERFERENCE, RADIO ELECTRIQUE GENEREE PAR CET APPAREIL NUMERIQUE DE TYPE B NE DEPASSE PAS LES LIMITES ENONCEES DANS LE REGLEMENT SUL LES PERTURBATIONS RADIO ELECTRIQUES, SECTION APPAREIL NUMERIQUE, DU MINISTERE DES COMMUNICATIONS.

FOR EUROPEAN MODEL

- This apparatus complies with requirements of EC directive 87/308/EEC.

“WARNING”

“TO REDUCE THE RISK OF FIRE OR ELECTRIC SHOCK, DO NOT EXPOSE THIS APPLIANCE TO RAIN OR MOISTURE.”

CAUTION:

“TO REDUCE THE RISK OF ELECTRIC SHOCK, DO NOT REMOVE COVER (OR BACK). NO USER-SERVICEABLE PARTS INSIDE. REFER SERVICING TO QUALIFIED SERVICE PERSONNEL.”



CAUTION
RISK OF ELECTRIC SHOCK
DO NOT OPEN



- The lightning flash with arrowhead symbol, within an equilateral triangle, is intended to alert the user to the presence of uninsulated “dangerous voltage” within the product’s enclosure that may be of sufficient magnitude to constitute a risk of electric shock to persons.



- The exclamation point within an equilateral triangle is intended to alert the user to the presence of important operating and maintenance (servicing) instructions in the literature accompanying the product.

Important safeguards

1. **Read Instructions** – All the safety and operating instructions should be read before the appliance is operated.
2. **Retain Instructions** – The safety and operating instructions should be retained for future reference.
3. **Heed Warnings** – All warnings on the appliance and in the operating instructions should be adhered to.
4. **Follow Instructions** – All operating and use instructions should be followed.
5. **Water and Moisture** – The appliance should not be used near water – for example, near a bathtub, washbowl, kitchen sink, laundry tub, in a wet basement, or near a swimming pool, and the like.
6. **Carts and Stands** – The appliance should be used only with a cart or stand that is recommended by the manufacturer.

6A. An appliance and cart combination should be moved with care. Quick stops, excessive force, and uneven surfaces may cause the appliance and cart combination to overturn.

PORTABLE CART WARNING



S3125A

7. **Wall or Ceiling Mounting** – The appliance should be mounted to a wall or ceiling only as recommended by the manufacturer.
8. **Ventilation** – The appliance should be situated so that its location or position does not interfere with its proper ventilation. For example, the appliance should not be situated on a bed, sofa, rug, or similar surface that may block the ventilation openings; or, placed in a built-in installation, such as a bookcase or cabinet that may impede the flow of air through the ventilation openings.
9. **Heat** – The appliance should be situated away from heat sources such as radiators, heat registers, stoves, or other appliances (including amplifiers) that produce heat.
10. **Power Sources** – The appliance should be connected to a power supply only of the type described in the operating instructions or as marked on the appliance.
11. **Polarization** – If the appliance is provided with a polarized plug having one blade wider than the other, please read the following information: The polarization of the plug is a safety feature. The polarized plug will only fit the outlet one way. If the plug does not fit fully into the outlet, try reversing it. If there is still trouble, the user should seek the services of a qualified electrician. Under no circumstances should the user attempt to defeat the polarization of the plug.
12. **Power-Cord Protection** – Power-supply cords should be routed so that they are not likely to be walked on or pinched by items placed upon or against them, especially near plugs, convenience receptacles, and the point where they exit from the appliance.
13. **Cleaning** – The appliance should be cleaned only as recommended by the manufacturer.

14. **Power Lines** – An outdoor antenna should be located away from power lines.
15. **Nonuse Periods** – The power cord of the appliance should be unplugged from the outlet when left unused for a long period of time.
16. **Object and Liquid Entry** – Care should be taken so that objects do not fall and liquids are not spilled into the enclosure through openings.
17. **Damage Requiring Service** – The appliance should be serviced by qualified service personnel when:
 - A. The power-supply cord or the plug has been damaged; or
 - B. Objects have fallen, or liquid has been spilled into the appliance; or
 - C. The appliance has been exposed to rain; or
 - D. The appliance does not appear to operate normally or exhibits a marked change in performance; or
 - E. The appliance has been dropped, or the enclosure damaged.
18. **Servicing** – The user should not attempt to service the appliance beyond that described in the operating instructions. All other servicing should be referred to qualified service personnel.
19. **Outdoor Antenna Grounding** – If an outside antenna is connected to the receiver, be sure the antenna system is grounded so as to provide some protection against voltage surges and built up static charges. Article 810 of the National Electrical Code, ANSI/NFPA 70, provides information with regard to proper grounding of the mast and supporting structure, grounding of the lead-in wire to an antenna discharge unit, size of grounding conductors, location of the antenna discharge unit, connection to grounding electrodes, and requirements for the grounding electrode. See Figure 73.1.

FIGURE 73.1:
EXAMPLE OF ANTENNA GROUNDING AS PER NATIONAL ELECTRICAL CODE

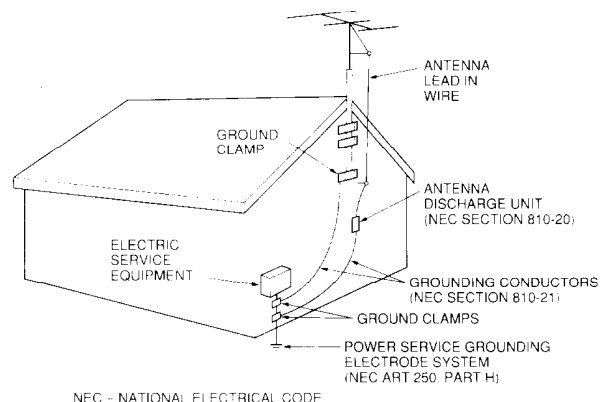

S2898A

Precautions

1. Warranty Card

The serial number is written on the rear panel of this unit. Copy the serial number and model number onto your warranty card and keep it in a safe place.

2. Recording Copyright

Recording of copyrighted material for other than personal use is illegal without permission of the copyright holder.

3. AC Fuse

The fuse is located inside the chassis and is not user-serviceable. If power does not come on, contact your Onkyo authorized service station.

4. Care

From time to time you should wipe the front and rear panels and the cabinet with a soft cloth. For heavier dirt, dampen a soft cloth in a weak solution of mild detergent and water, wring it out dry, and wipe off the dirt. Following this, dry immediately with a clean cloth. Do not use rough material, thinners, alcohol or other chemical solvents or cloths since these could damage the finish or remove the panel lettering.

5. Power

WARNING

BEFORE PLUGGING IN THE UNIT FOR THE FIRST TIME, READ THE FOLLOWING SECTION CAREFULLY.

- Some models are designed for use only with the power supply voltage of the region where they are sold.
 - European and Australian models: AC 230V, 50Hz
 - U.S.A. and Canadian models: AC 120V, 60Hz
 - Worldwide model: AC 220-230V/120V switchable, 50/60Hz
- Voltage Selector (Rear Panel)**

Worldwide models are equipped with a voltage selector to conform to local power supplies. Be sure to set this switch to match the voltage of the power supply in your area before plugging in the unit. Models without a voltage selector can only be used in areas where the power supply is the same as that of the unit.

Supplied accessories

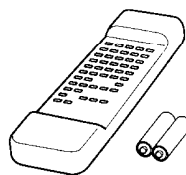

- 1 Remote control
- 2 Batteries (size AA, R6, or UM-3)

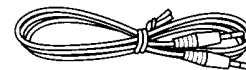

- 1 Remote control cable

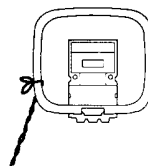

- 1 AM loop antenna

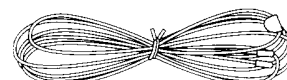

- 1 T-shaped FM antenna

(Worldwide models only)

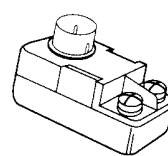

- 1 75/300 ohm antenna adaptor

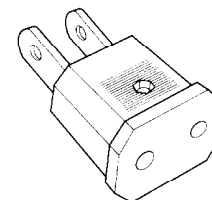

- 1 CV plug (Shape may vary according to the area where purchased.)

Memory Preservation

This unit does not require memory preservation batteries. A built-in memory power back-up system preserves the contents of the memory during power failures and even when the unit is unplugged. The unit must be plugged in order to charge the back-up system.

The memory preservation period after the unit has been unplugged varies depending on climate and placement of the unit. On the average, memory contents are protected over a period of a few weeks after the last time the unit has been unplugged. This period is shorter when the unit is exposed to a highly humid climate.

For USA and Canada

- Manufactured under license from Dolby Laboratories Licensing Corporation. Additionally licensed under Canadian number 1,037,877. "Dolby", "Pro Logic", and the double-D symbol are trademarks of Dolby Laboratories Licensing Corporation.

ATTENTION FOR BRITISH MODEL

- Replacement and mounting of an AC plug on the power supply cord of this unit should be performed only by qualified service personnel.
- IMPORTANT:** The wires in the mains lead are coloured in accordance with the following code:

Blue: Neutral

Brown: Live

As the colours of the wires in the mains lead of this apparatus may not correspond with the coloured markings identifying the terminals in your plug, proceed as follows:

The wire which is coloured blue must be connected to the terminal which is marked with the letter N or coloured black.

The wire which is coloured brown must be connected to the terminal which is marked with the letter L or coloured red.

Before using this unit

(Worldwide models only)

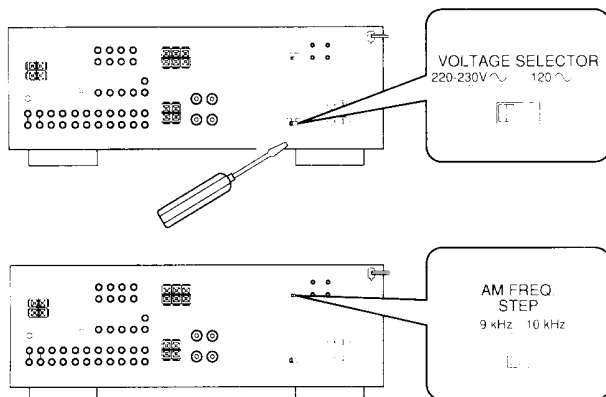

Setting the Voltage selector

1. Determine the proper voltage for your area: 220-230V or 120V.
2. If the preset voltage is not correct for your area, insert a screwdriver into the groove in the switch. Slide the switch all the way to the right (120V) or to the left (220-230V), whichever is appropriate.

Setting the tuning step frequency

Worldwide models are equipped with a switch that controls the AM (9kHz/10kHz) band tuning steps.

Please set this switch to match the tuning step frequency in your area.

U.S.A.: AM 10kHz

Other areas: AM 9kHz

Insert the batteries into the remote control according to the illustration.

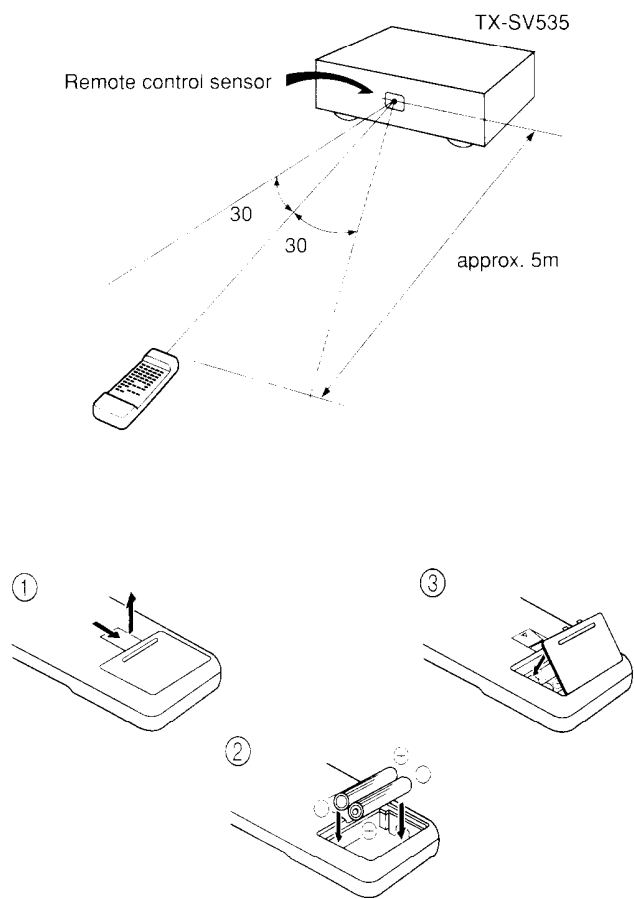

Using the remote control

The following information will help you get optimal use from the remote control.

- Place this unit away from direct bright light, which can prevent proper operation of the remote control.
- Make sure audio rack doors do not have tinted glass. If this unit is placed behind such a door, this may prevent proper remote control operation.
- Using other remote controls in the same room as this unit's remote control may cause interference.

Loading the batteries

Remove the battery compartment cover by opening it as shown in the illustration. Load three R6 (UM-3) AA size batteries into the remote control with the plus (+) and minus (-) terminals positioned as indicated by the diagram inside the battery compartment and close the cover.

- Remove dead batteries immediately to avoid corrosion damage.
- To avoid potential corrosion damage, never mix old batteries with new ones.
- The manganese batteries supplied with this unit have a service life of approximately six months, depending on frequency of usage.
- This unit comes equipped with R6 (UM-3) AA manganese batteries, but we recommend that long-life alkaline batteries LR6 (AM-3) AA be used when replacing the batteries.

Explanation

Surround System

DOLBY PRO LOGIC Surround

Many motion pictures produced have been released in the 4-channel "Dolby Stereo" sound, with music, dialogue, and panned effects coming from the 3-channel front soundstage, and surround effects and ambience emanating from the sides and rear of the theater.

The motion picture masters are used for production of stereo VHS, VHS-Hi-Fi, Beta Hi-Fi, and stereo laser discs that you can buy or rent at your video store. The TX-SV535 incorporates the Digital Dolby Pro Logic Surround Circuit, which is designed to decode the four channel the audience experience found in DOLBY STEREO movies. Dolby Pro Logic Surround is capable of creating a multi-dimensional soundstage, but with the increased channel separation it gives a far greater sense of "movement" and sound localization. Just like in the theater, the addition of the active center channel ensures that all audience members hear dialogue coming from its on-screen sources regardless of seating position.

THEATER Surround

There are many surround speakers in an actual theater. The THEATER Surround mode uses Dolby Pro Logic Surround decoding, followed by additional audio processing designed by ONKYO. Use this mode for creating a theater atmosphere. This mode is suitable for playback of media recorded in the Dolby Surround format.

HALL Surround

This mode is especially suitable for media already having a substantial amount of reverb sound such as classical music. The atmosphere of a concert hall can be simulated.

Live Surround

Reproduces the feeling of a live performance.

ARENA Surround

This mode recreates the feel of listening to a pop concert in a domed stadium.

Since the TX-SV535 is equipped with Front amplifiers, Center amplifier and Surround amplifiers, Dolby Pro Logic, Theater, Hall, Live and Arena Surround effects can be produced. You can enjoy the feeling of a movie theater, concert hall or ball game ground in your own room.

DSP (Digital Signal Processor)

The DSP converts the musical signal into digital form and produces reflected sound from the digital signal. This is applied to the musical signal to yield an effect approaching that of a live performance.

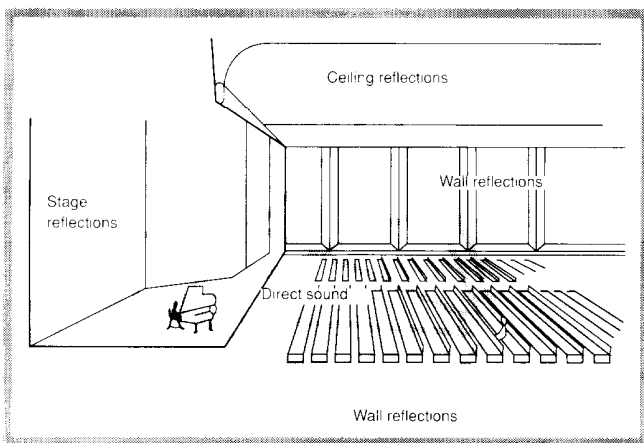

NOTES:

- The concert hall effect is produced from the reflections and reverberations contained in the original recording. These are converted into reflected sound that is reproduced from four directions. Thus, in some cases an unnatural impression can be conveyed if there are too few reflections in the recording or if the effects in the original recording were produced artificially.
- The concert hall effect is not merely an artificial reverberation unit, but a sophisticated effect that spreads existing reverberation around.

Multiple Room Remote System (MR)

Xantech's Multi-Room System is available in the U.S. and Canada, while Onkyo's Multi-Room System is available in all other countries. (Refer to page 14-15 for details.)

1. U.S.A., and Canadian models

- The following equipment (manufactured by Xantech and sold separately) is essential for using the Multi-Room System:
 - * Dinky Link: Model No. 480B-009 or J-Box Receiver: Model No. 780-10
 - * Connecting Block: Model No. 789-40
 - * 120VAC Power Supply: Model No. 781C-00The following accessories are necessary for operation of components not manufactured by Onkyo:
 - * Hi-Current Power Supply: Model No. 782-00
 - * Mini-Emitter: Model No. 282-00
- Use the secondary remote control model indicated below for operation of the system from the sub-room.
 - * Secondary Remote Control For Multi-Room Remote System: Model No. RC-MR1H

- Consult your nearest Onkyo Service Center with any questions concerning Xantech's Multi-Room System.

2. Models other than U.S.A., and Canadian models

- The following equipment (manufactured by Onkyo and sold separately) is essential for using the Multi-Room System:
 - * Sensor Unit: Model No. HR-10The following accessories are necessary for operation of components not manufactured by Onkyo:
 - * Remote Emitter: Model No. HE-50(AC)
 - * Remote Emitter Head: Model No. HE-10
- Use the secondary remote control model indicated below for operation of the system from the sub room.
 - * Secondary Remote Control For Multi-Room Remote System: Model No. RC-MR1H
- Consult your nearest Onkyo Service Center when replacing your Onkyo Multi-Room System with a Xantech Multi-Room System.

Speaker placement

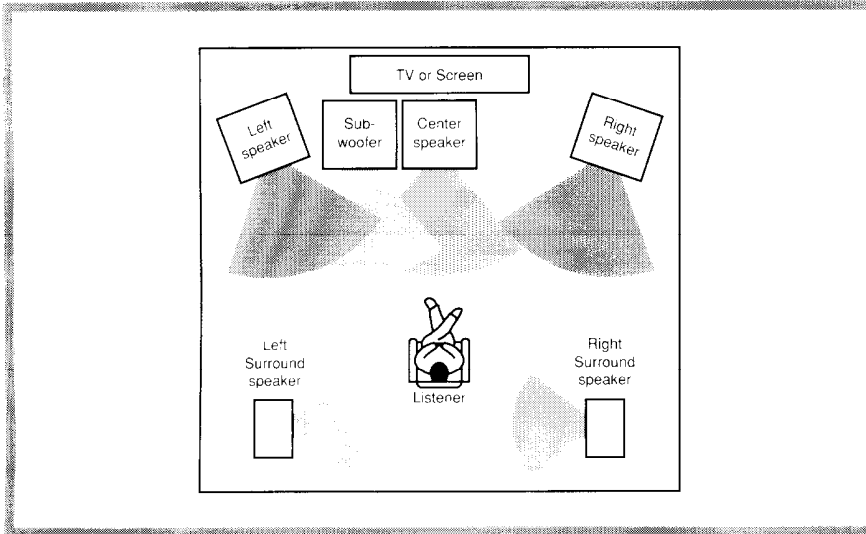

Placing the speakers for Surround effects

Speaker placement plays an important role in the reproduction of sound using Surround. The manner in which the speakers are placed varies depending on the size of the room and the wall coverings used in the room. The following shows an example of a layout for standard speaker placement. Refer to the example for placing the speakers appropriately in order to experience the best Surround sound.

In principle, for Surround sound reproduction, two Front speakers and two Surround (Rear) speakers are required. Refer to the illustration on the left.

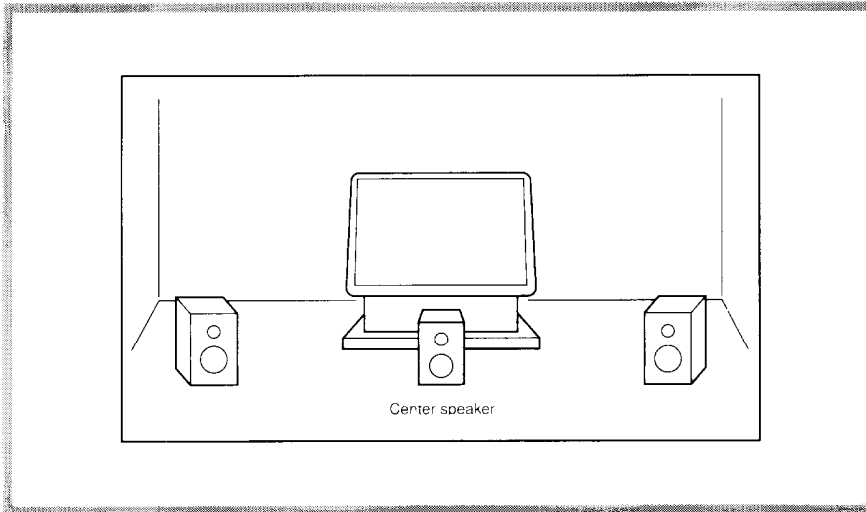

Placing the front speakers

If the Front L and R speakers are placed too far away from each other, sound spreads out too much and is dispersed resulting in diminished sound quality.

Placing the center speaker

To enjoy Surround sound, a Center speaker is required in addition to the four basic speakers.

If a screen with a projector is used, place the Center speaker under the screen. If a Monitor TV is used, it is recommended that the Center speaker be placed on top of or under the Monitor.

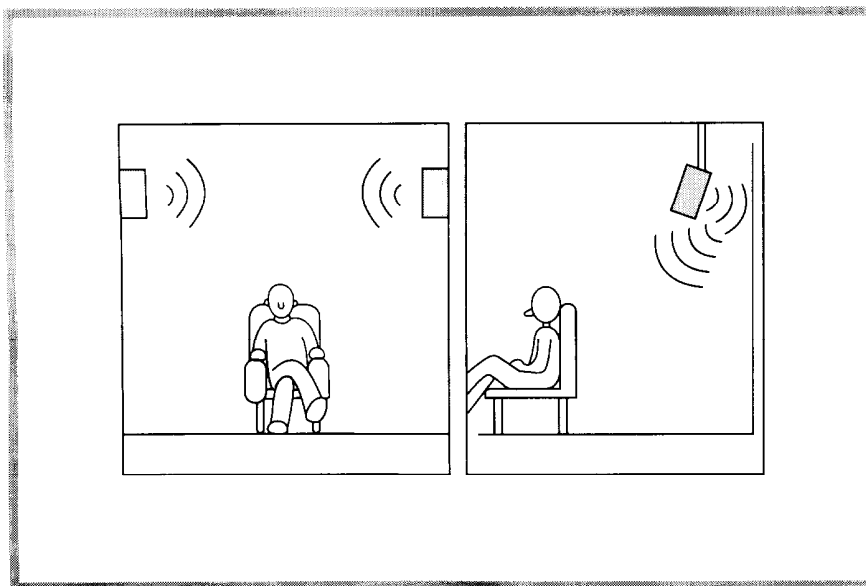

Placing the rear speakers

To bring out the feeling of shifting sound, the rear speakers should not be placed on the floor, but would be most effective placed above ear position. They can also be placed facing the ceiling or walls to reflect the sound.

Placing a subwoofer speaker

To enjoy powerful bass sounds, install a subwoofer with a built-in power amplifier. The placement of the Subwoofer does not affect the final quality of the sound image too much, therefore as its exact placement is not critical, you can install it more with the room layout in mind. To especially enjoy A/V Surround, a Subwoofer can bring out the best features of Dolby Pro Logic Surround.

Audio equipment connections

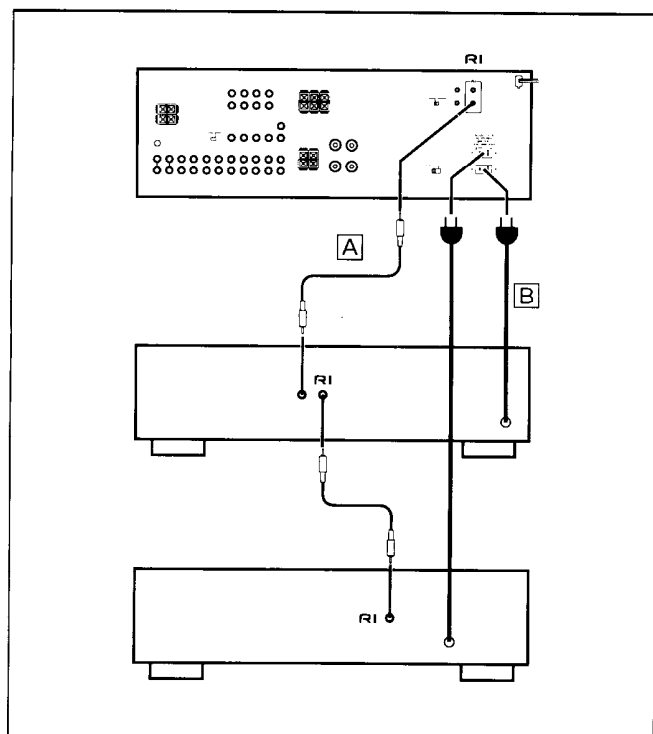
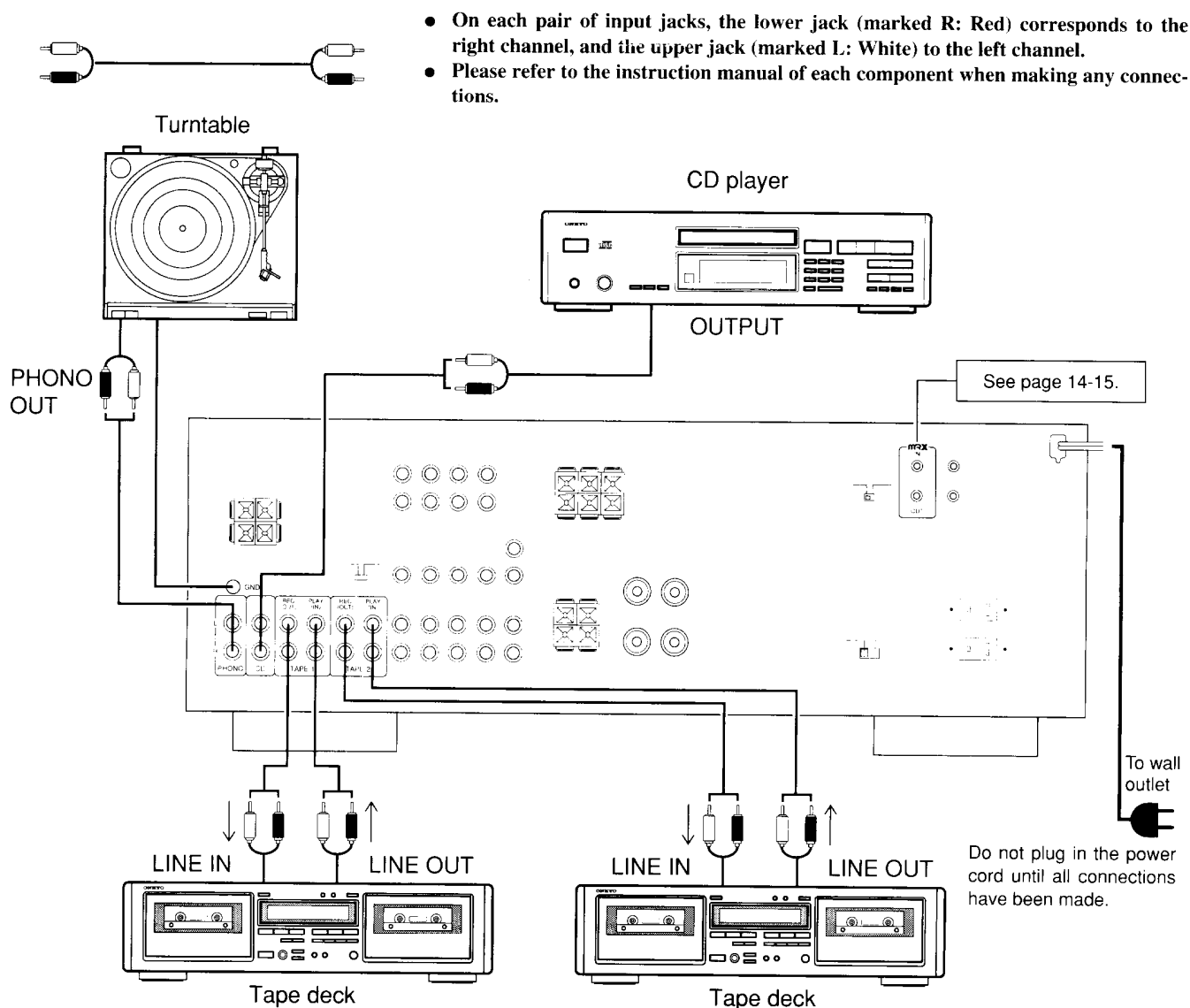

Remote control connections

A cassette tape deck and compact disc player that have the ONKYO **RI** mark can be operated using the accessory remote control with this unit. Connect a remote control cable to the black jack with the **RI** mark. Never connect it to the green or gray jack with the **MRX** mark. Connect the remote control cable as shown right side to enable remote control operation of other components. (**A**)

NOTES:

- To enable proper remote control operation, both the **RI** cable and the audio cables must be connected between units.
- This unit's remote control cannot be used to control ONKYO turntables.
- An **RI** remote control cable equipped with a 1/8" (3.5 mm) miniature 2 conductor phone plug is included with this unit and with any other component with the **RI** mark.

AC outlet connections

The SWITCHED outlet is switched on and off by the power buttons on the front panel and remote control. For AC outlet connection details, refer to **B** in the illustration at the left.

The shape, number and total capacity of the AC outlets may differ according to the model and the area where the unit is purchased. Be careful that other components connected to this unit do not exceed the capacity that is printed on the rear panel above the AC outlets.

Video equipment connections

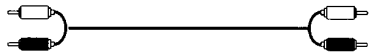

- On each pair of input jacks, the lower jack (marked R: Red) corresponds to the right channel, and the upper jack (marked L: White) to the left channel.
- Please refer to the instruction manual of each component when making any connections.

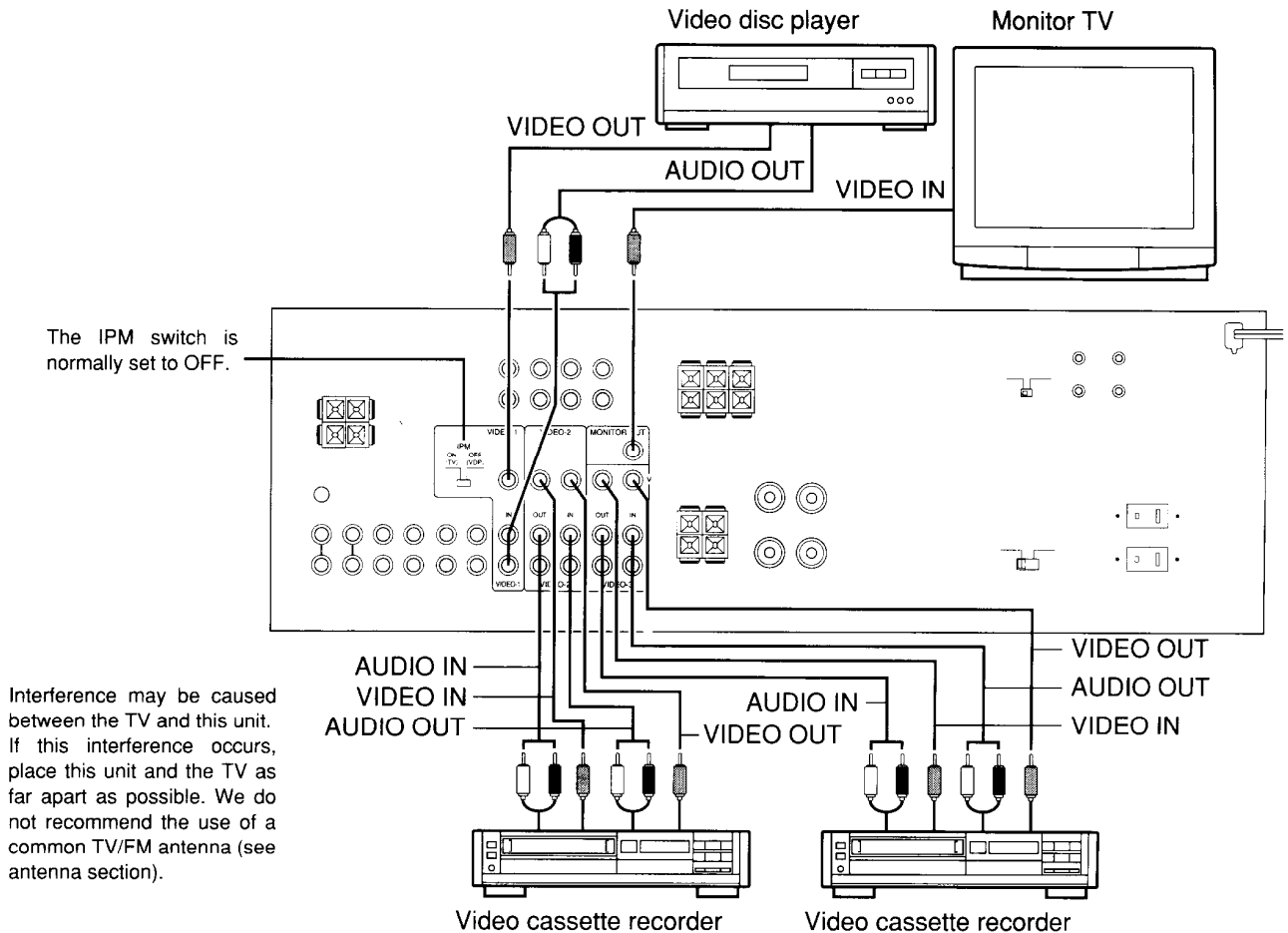

IPM system: The receiver's power is automatically turned on when the TV is turned on. To use this function, connect the units as shown in the diagram.

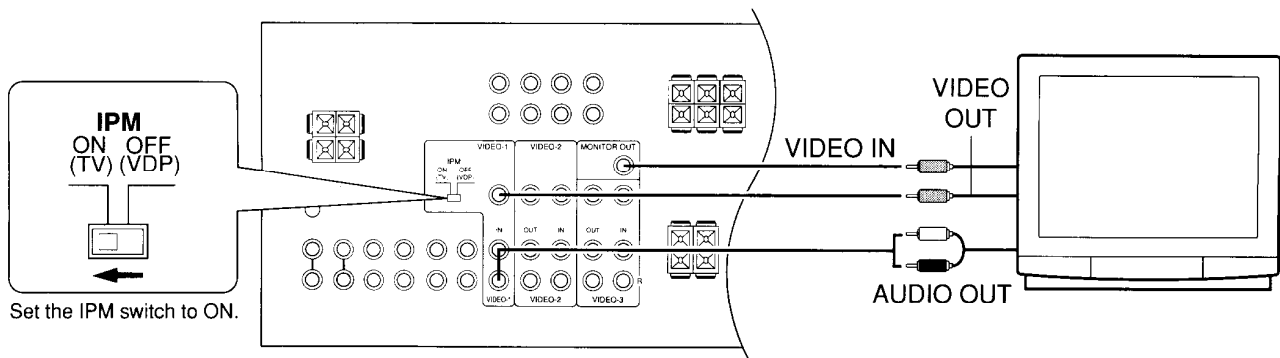

NOTES:

- This unit will automatically switch on approximately three to five seconds after the TV comes on.
- The IPM function is not operating if the TV screen remains blank, even if the TV is switched on.
- In order to use the IPM function, the TX-SV535 should be connected to the video input terminal on the TV.

Speaker connections

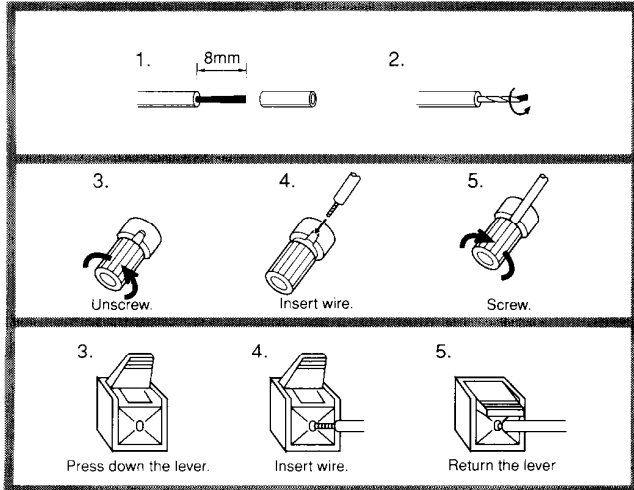

Connecting the speaker cables

When using banana plugs, make sure the speaker terminal screws are screwed in firmly before inserting the banana plugs.

NOTE:

Speaker terminals on European models are not banana plug compatible.

NO

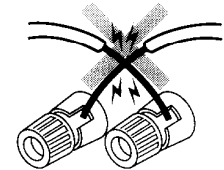

NOTE:

To prevent damage to circuitry, never short-circuit the positive (+) and negative (-) speaker wires.

Connecting the front and rear (surround) speakers

If you want to use Surround effects, the rear and Center speakers must be connected. (Surround effects can be heard even if a center speaker is not connected.)

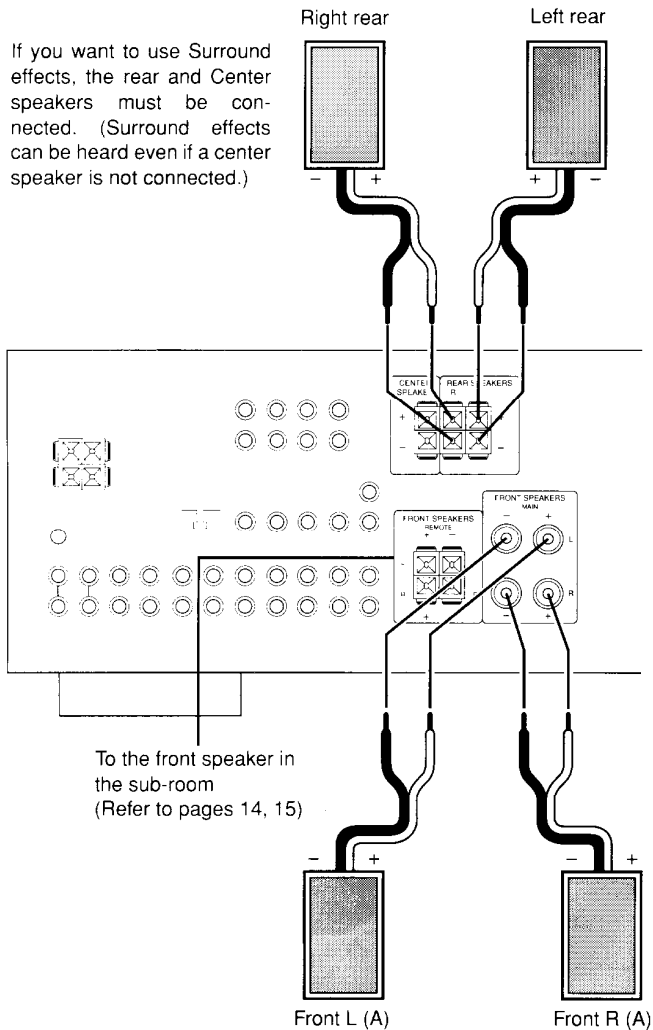

Connecting of center speaker and subwoofer

Active subwoofer

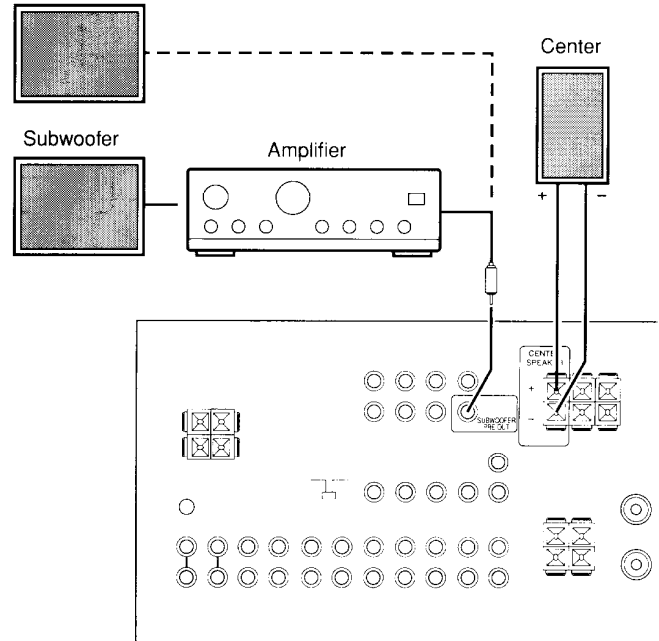

■ Speaker impedance

FRONT MAIN: 6 ohms min./speaker
 CENTER, REAR, FRONT REMOTE: 8 ohms min./speaker

Optional power amplifier connections

The TX-SV535 is equipped with a set of PRE OUT terminals which allow you to connect each external power amplifier. With a powerful power amp, you can play music at even higher volume levels than with the TX-SV535 alone. Connect the power amp to the PRE OUT terminals of the TX-SV535, and connect the speakers to the power amp.

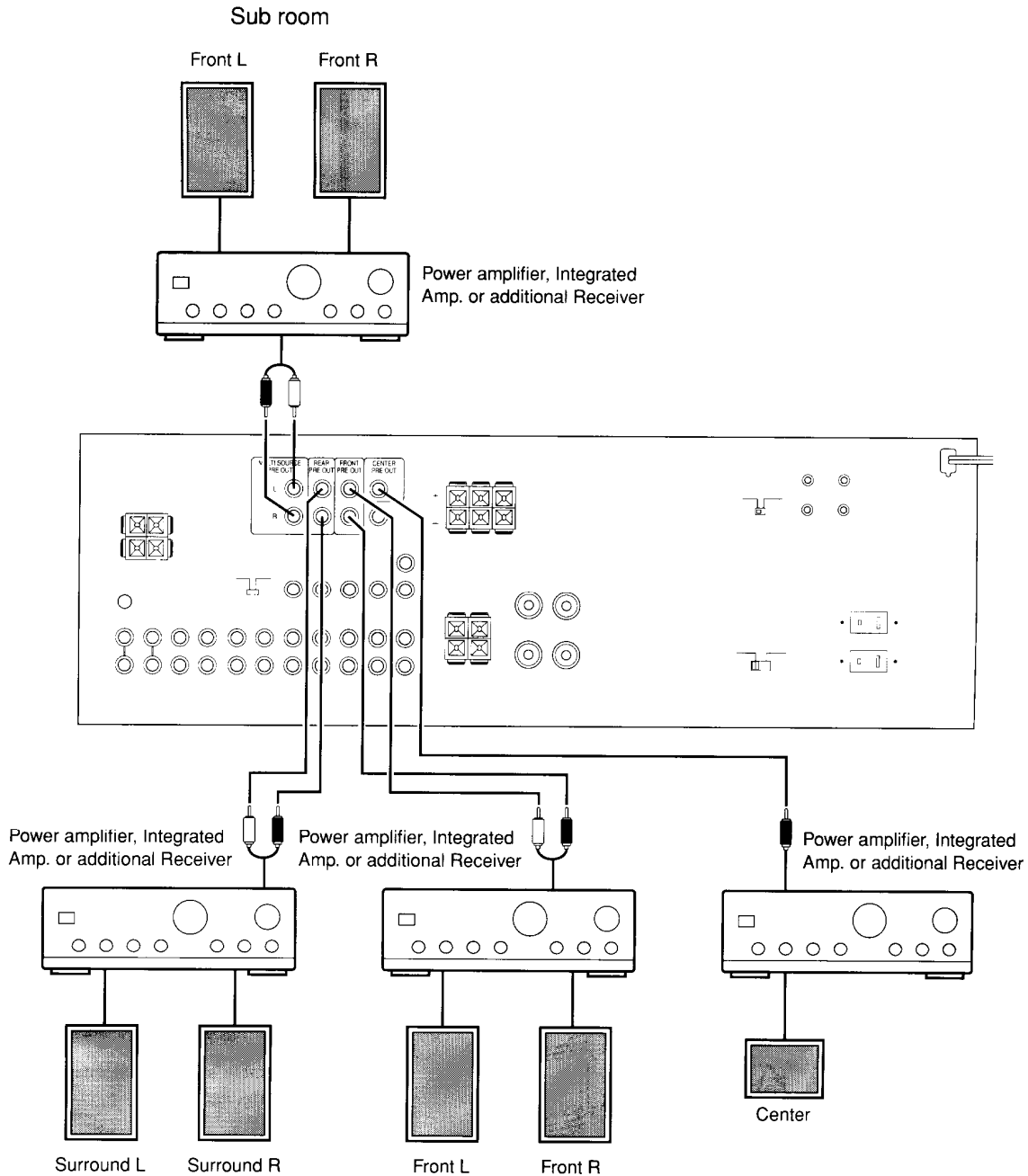

NOTE:

- If integrated Amp. or Receiver used in the application, you will have the benefit of tone control as well as added input flexibility.
- No signals will be output from FRONT, REAR, CENTER and SUB WOOFER PRE OUT when the SPEAKERS MAIN button is turned off.
- No signals will be output from MULTI SOURCE PRE OUT when the SPEAKERS REMOTE button is turned off.

Antenna connections

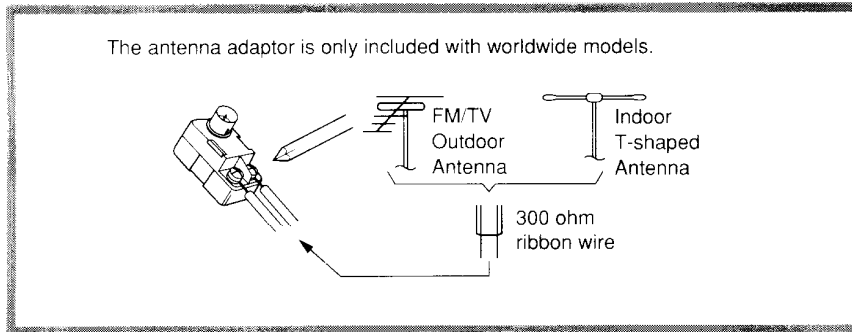

Connecting the T-shaped antenna or 300 ohm ribbon wire to the 75/300 ohm adaptor (Worldwide models)

Loosen the screws and wrap the wire around these screws. Then tighten the screws with a screwdriver

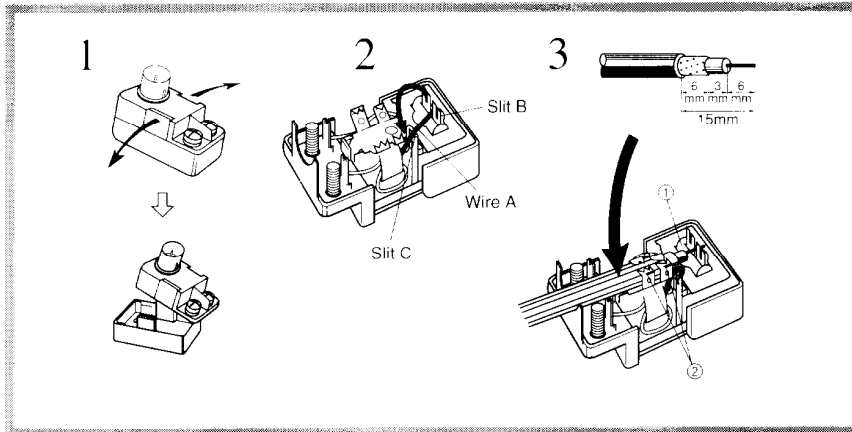

Connecting the coaxial cable to the 75/300 ohm adaptor (Worldwide models)

1. With your fingernail or a small screwdriver, press the stoppers outwards and remove the cover.
2. Remove the transformer wire A from slit B and insert it into slit C.
3. Prepare the coaxial cable as shown in the diagram. Connect the 75/300 ohm antenna adaptor to the coaxial cable

1. Insert the end of the cable.
2. Clamp it in place with pliers.

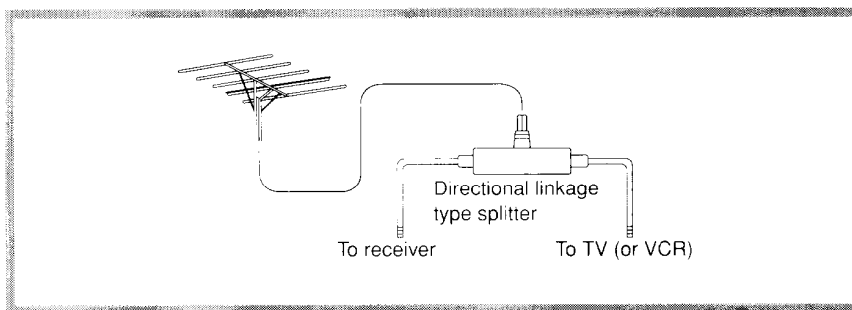

Directional linkage

Do not use the same antenna for both FM and TV (or VCR) reception since the FM and TV (or VCR) signals can interfere with each other. If you must use a common FM/TV (or VCR) antenna, use a directional linkage type splitter.

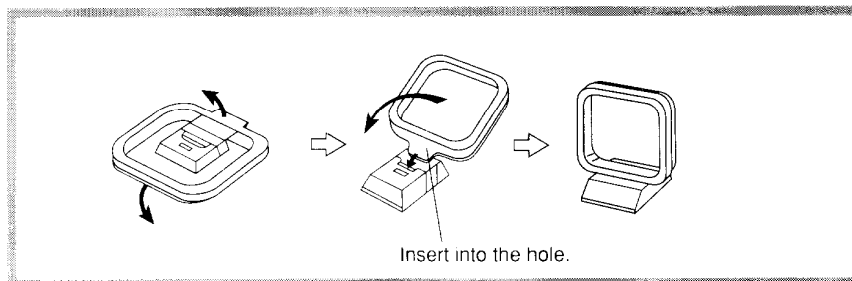

Assembling the AM loop antenna

Assemble the loop antenna as shown in the illustration.

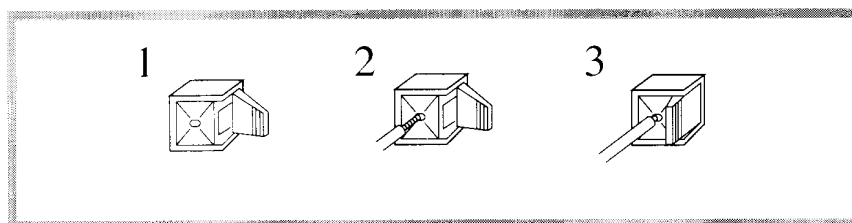

Connecting the antenna cable

1. Press down the lever.
2. Insert wire.
3. Return the lever.

Antenna connections

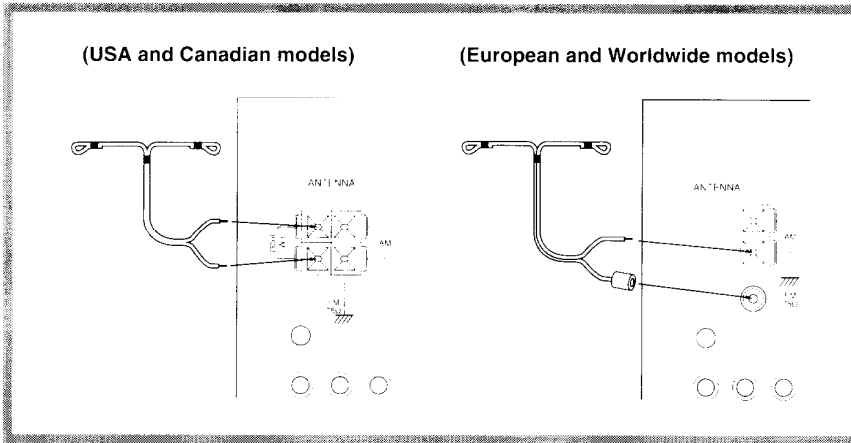

Connecting the enclosed T-shaped FM antenna

The T-shaped FM antenna is for indoor use only. Extend the antenna and move it in various directions until the clearest signal is received. Fix it with push pins or similar in the position giving the least amount of distortion.

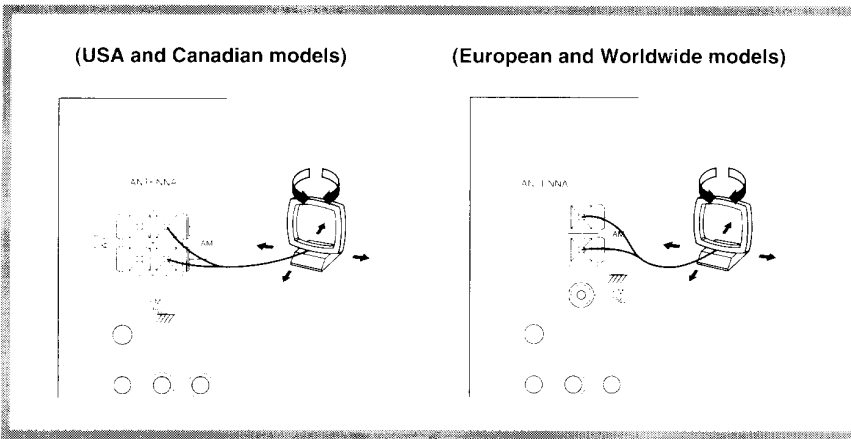

Connecting the enclosed AM loop antenna

The AM loop antenna is for indoor use only. Set it in the direction and position where you receive the clearest sound. Put it as far as possible away from the main unit, TV set, speaker cables and power cord.

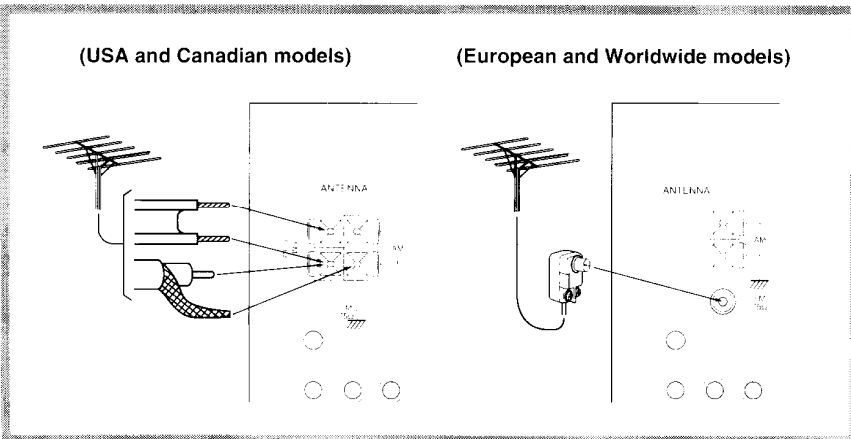

Connecting an FM outdoor antenna

If the reception is not very clear with the attached T-shaped FM antenna, the use of an external antenna is recommended.

Please make sure that you comply with the following considerations regarding the location.

Keep the antenna away from noise sources (neon signs, busy roads etc.)

It is dangerous to put it close to power lines, so keep it well away from power lines, etc.

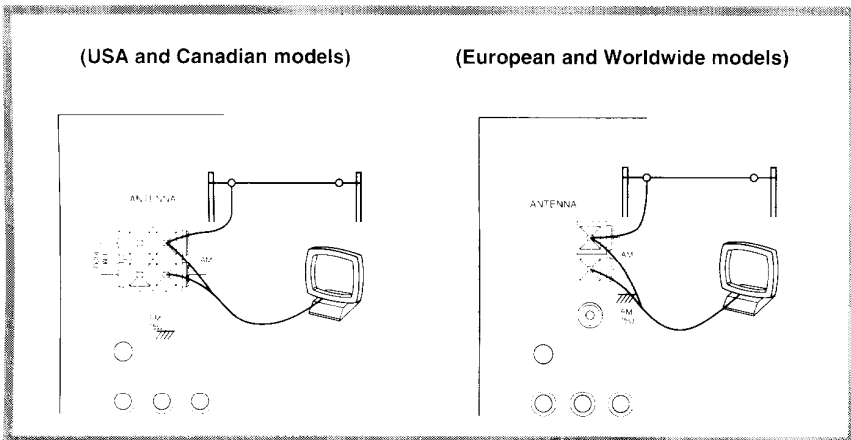

Connecting an AM outdoor antenna

When reception is not satisfactory using the attached AM loop antenna alone, connection of an external antenna is recommended. (Do not remove the AM loop antenna)

The external antenna will be more effective if you stretch it horizontally in a high place above a window or outside.

Connection for Multiple-Room Remote Control

U.S.A. and Canadian models (Xantech Multiple-Room systems)

Do not plug in the power cord until all connections have been made.

When making connections ① through ⑤, be sure to connect the units as shown in the connection diagram below. Do not make a mistake when connecting the units.

A. Operating components displaying Onkyo's RI mark from the sub-room

Components mounted in a rack should be connected as shown below to enable remote control operation.

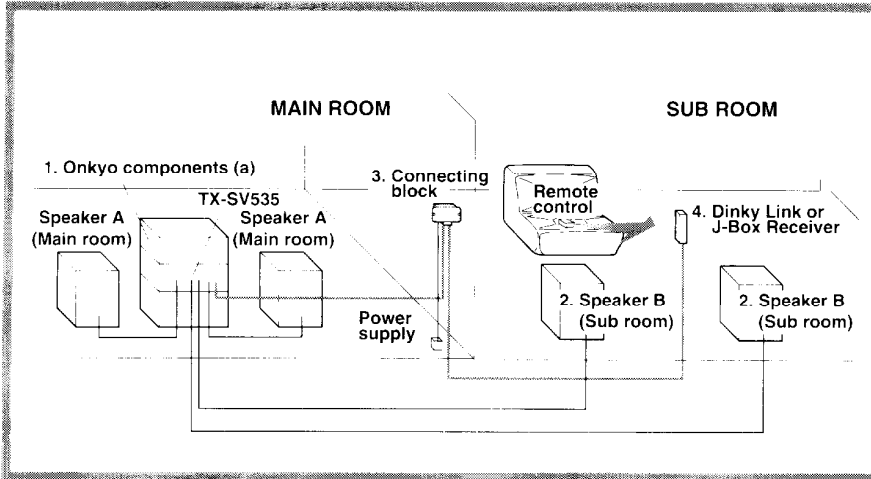

1. Set up the components (a) displaying Onkyo's RI mark.
2. Connect the speaker B cables to the speaker terminal on the TX-SV535. (1)
3. Install Connecting Block 789-40 in the main room, then connect it to the TX-SV535. (2)
(Connect Power Supply 781C-00 or 782-00 to the Connecting Block.)
4. Install Xantech's J-Box Receiver 780-10 or Dinky Link 480B-00 in the sub-room, then connect it to the Connecting Block in the main room. (3)

B. Using a remote control to operate components not displaying Onkyo's RI mark from the sub-room

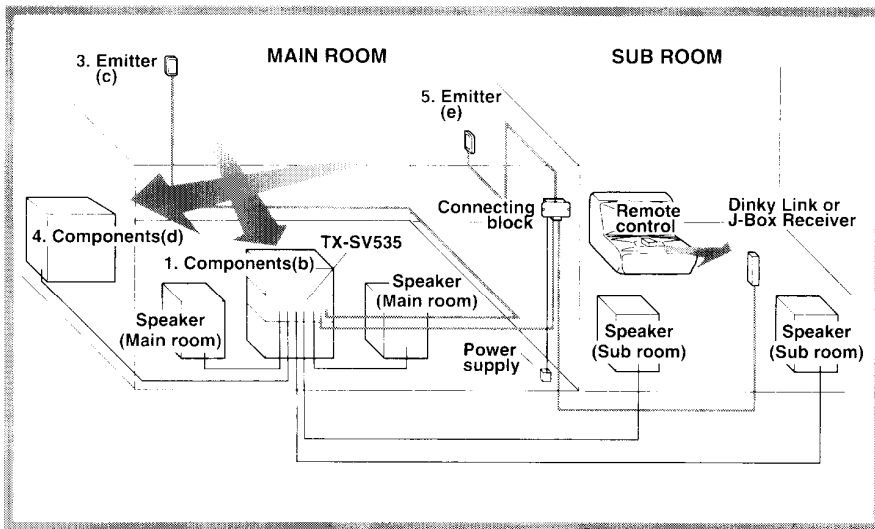

1. Connect the components (b) to the TX-SV535.
2. Make the connections described above in steps 2 through 4 of section A.
3. Install Emitter 282-00 (c) so that its sensor is directed toward these components, then connect it to the TX-SV535. (4)

■ Operating components which are positioned out of the range of the emitter installed as described above

4. Connect the components (d) to the TX-SV535.
5. Install another Emitter 282-00 (e) so that its sensor is directed toward these components, then connect it to the Connecting Block 789-40. (5)

Connection diagram

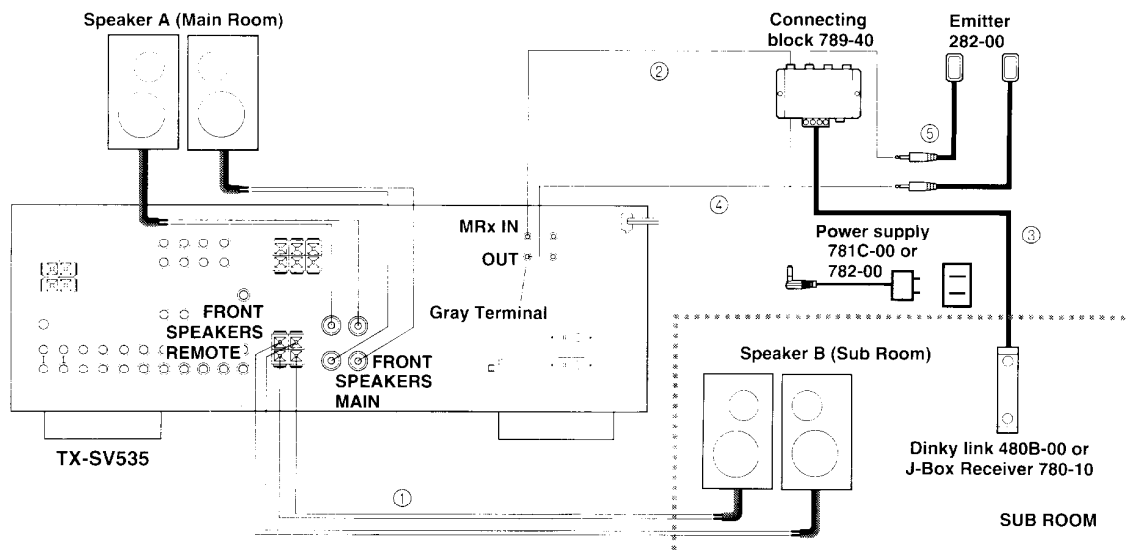

Connection for Multiple-Room Remote Control

Models other than U.S.A. and Canadian models (Onkyo Multi-Room Systems)

Do not plug in the power cord until all connections have been made.

When making connections 1 through 4, be sure to connect the units as shown in the connection diagram below. Do not make a mistake when connecting the units.

A. Operating components displaying Onkyo's RI mark from the sub-room

Components mounted in a rack should be connected as shown below to enable remote control operation.

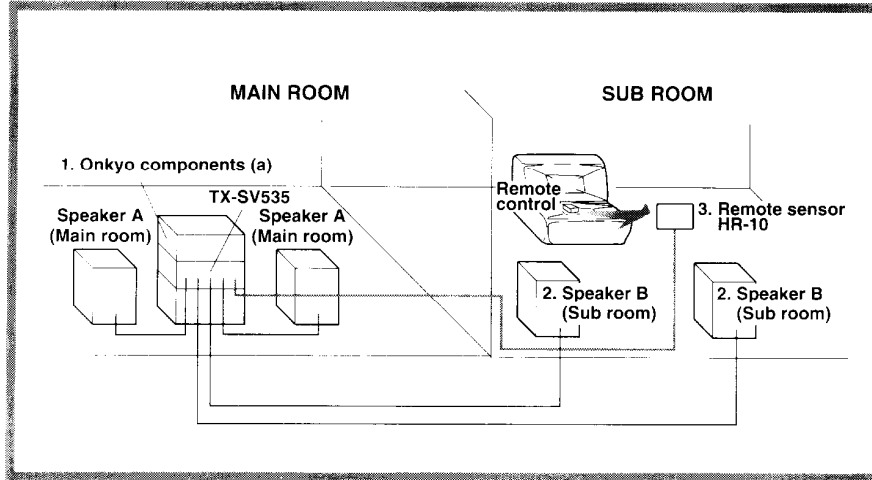

1. Set up the components (a) displaying Onkyo's RI mark.
2. Connect the speaker (sub room) cables to the speaker terminal on the TX-SV535. (1)
3. Install Remote Sensor HR-10 in the sub-room, then connect it to the TX-SV535. (2)

B. Using a remote control to operate components not displaying Onkyo's RI mark from the sub-room

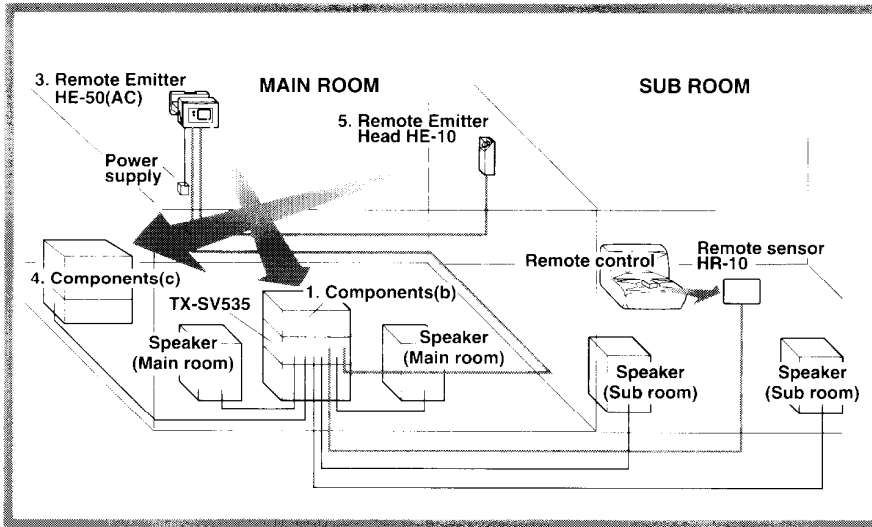

1. Connect the components (b) to the TX-SV535.
2. Make the connections described above in steps 2 through 3 of section A.
3. Install Remote Emitter HE-50 (AC) so that its sensor is directed toward these components, then connect it to the TX-SV535. (3)
(Connect the AC adapter to the Remote Emitter.)

■ Operating components which are positioned out of the range of the emitter installed as described above.

4. Connect the components (c) to the TX-SV535.
5. Install Remote Emitter Head HE-10 so that its sensor is directed toward these components, then connect it to the HE-50 (AC). (4)

Connection diagram

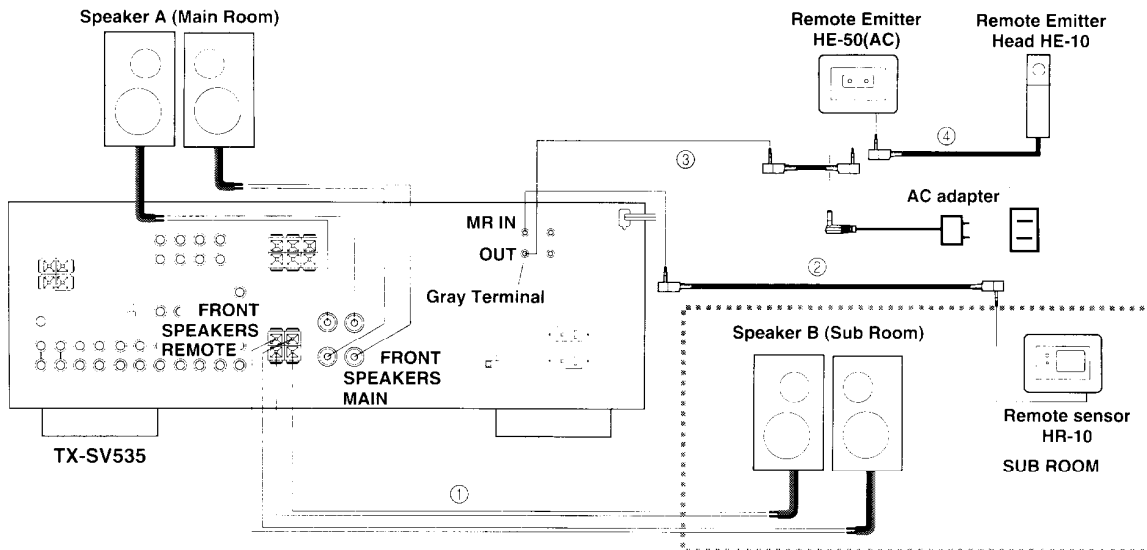

Control positions and names

For more information about buttons or controls, turn to the page number listed in the brackets after each item.

Front panel

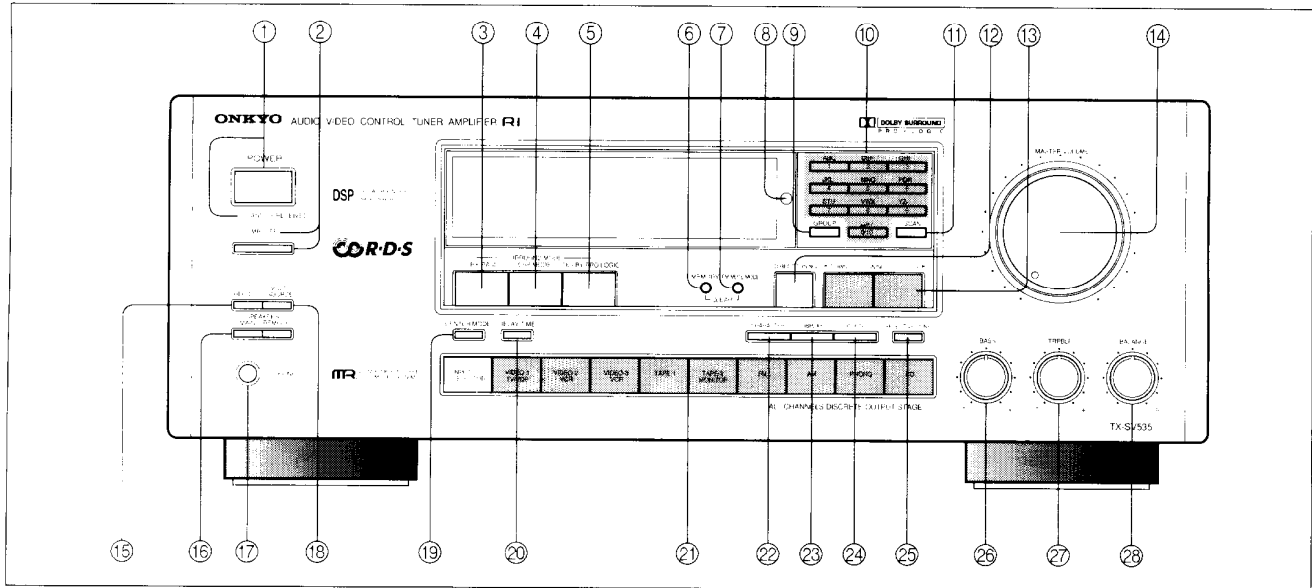

- | | | |
|--|---|--|
| <p>1 Power button and stand-by received indicator (POWER) [18, 19]</p> <p>2 MR off button (MR OFF) and indicator [30]</p> <p>3 By-Pass button (BY-PASS) [25]</p> <p>4 DSP mode button (DSP MODE) [25, 26]</p> <p>5 Dolby Pro Logic button (DOLBY PRO LOGIC)</p> <p>6 Memory button (MEMORY) [21]</p> <p>7 FM muting/mode button (FM MUTE/MODE) [20, 21]</p> <p>8 Remote control sensor [5]</p> <p>9 Group button (GROUP) [21]</p> <p>10 Number buttons (1 to 9, 0/10) [20, 21, 24]</p> <p>11 Preset Scan button (PRESET SCAN) [21] (Except for the European model)
Scan button (SCAN) [21, 23] (European model only)</p> | <p>12 Direct access tuning button (DIRECT TUNING) [20]</p> <p>13 Tuning selector buttons (DOWN, UP) [20, 23]</p> <p>14 Volume control knob and indicator (MASTER VOLUME) [18, 19]</p> <p>15 Recording out button (REC OUT) [27, 28, 29]</p> <p>16 Speaker selector buttons (SPEAKERS MAIN/REMOTE) [18, 19, 30]</p> <p>17 Headphone jack (PHONES) [19]</p> <p>18 Multi-source button (MULTI SOURCE) [30]</p> <p>19 Center mode button (CENTER MODE) [25, 26]</p> <p>20 Delay time button (DELAY TIME) [25, 26]</p> | <p>21 Input selector buttons [18, 27, 28, 29, 30]
Audio selectors (CD, PHONO, FM, AM, TAPE-1, TAPE-2 MONITOR)
Video selectors (VIDEO-1 TV/VDP, VIDEO-2 VCR, VIDEO-3 VCR)</p> <p>22 Character button (CHARACTER) [24] (European model only)</p> <p>23 Display button (DISPLAY) [23] (European model only)</p> <p>24 PTY/TP button (PTY/TP) [23] (European model only)</p> <p>25 Selective tone control button (SELECTIVE TONE) [18, 19]</p> <p>26 Bass control knob (BASS) [18, 19]</p> <p>27 Treble control knob (TREBLE) [18, 19]</p> <p>28 Balance control knob (BALANCE) [18, 19]</p> |
|--|---|--|

Display

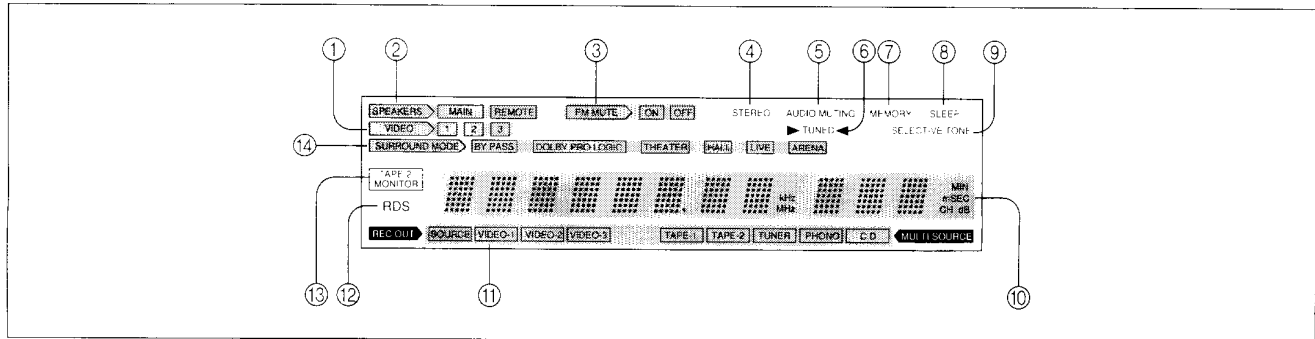

- | | | |
|--|--|---|
| <p>1 Video input selector indicators</p> <p>2 Speaker selector indicators</p> <p>3 FM muting on/off indicators</p> <p>4 FM stereo indicator</p> <p>5 Audio muting indicator</p> <p>6 Tuned indicator</p> <p>7 Memory indicator</p> | <p>8 Sleep indicator</p> <p>9 Selective tone control indicator</p> <p>10 Multi function display
frequency / input selector / character / preset station / sleep timer / multi-source volume level / delay time / center, rear volume level</p> | <p>11 Recording out / multi-source indicators</p> <p>12 RDS indicator (European model only)</p> <p>13 Tape-2 monitor indicator</p> <p>14 Surround mode indicators</p> |
|--|--|---|

Control positions and names

Remote control

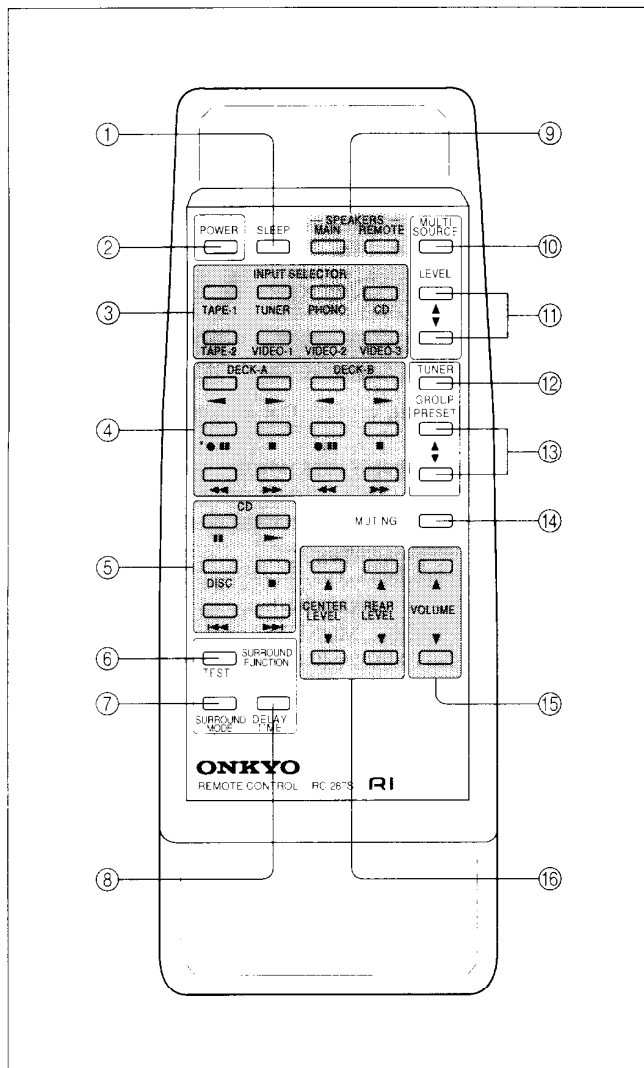

- ① **Sleep button (SLEEP) (Remote control transmitter only)**
Press to set the power off timer. The sleep timer is a function which turns off the power to the system from the time it is set. When this button is pressed, "90 MIN" is displayed for 5 seconds, and the power goes off 90 minutes later. Each time the button is pressed during 5 seconds, the timer setting changes, by 10 minute intervals, such as 80, 70, 60 While the sleep timer is operating, the **[SLEEP]** indicator is lit. If the sleep button is pressed during this time, the amount of time remaining on the sleep timer is displayed, and if the button is pressed during that display, 10 minutes will be subtracted from that time. If the button is pressed when the panel display shows 10 minutes or less, the sleep timer is cancelled, and the power is not turned off.
- ② **Power button (POWER) [18, 19]**
- ③ **Input selector buttons [18, 30]**
(TAPE-1, TUNER, PHONO, CD, TAPE-2, VIDEO-1, VIDEO-2, VIDEO-3)
When the TUNER button is pressed, the station which was received previously is recalled. Selection of AM or FM should be done on the main unit.

- ④ **Tape operation buttons (DECK-A, DECK-B)**
These buttons control ONKYO double cassette tape decks that can be remote controlled. Use the DECK-B buttons to control single cassette tape decks with the **RI** mark.
 - **II** : When this is pressed, the recording stand-by mode is entered.
 - ▶ : The tape plays, moving from right to left, or, in the recording stand-by mode, recording begins.
 - : Interrupts all operations.
 - ◀ : The tape plays, moving from left to right, or, in the recording stand-by mode, recording begins.
 - ◀◀ : Fast forward from right to left.
 - ▶▶ : Fast forward from left to right.
- ⑤ **CD operation buttons (CD)**
These buttons are used to operate an ONKYO CD player with the **RI** sleepmark.
 - ▶ : Press this button to play the CD player.
 - : Press this button to pause the CD play back. To resume disc play, press the ▶ button.
 - DISC : Press to use for sequential selection of discs in the order they were loaded on the CD changer.
 - : Press this button to stop the CD player.
 - ◀◀ : Press this button to go back to the beginning of the current track and again to skip back to the previous track.
 - ▶▶ : Press this button to skip to the next track.
- ⑥ **Test tone button (TEST) [26]**
- ⑦ **Surround mode button (SURROUND MODE) [25, 26]**
- ⑧ **Delay time button (DELAY TIME) [25, 26]**
- ⑨ **Speaker selector buttons (SPEAKERS MAIN/REMOTE) [18, 19, 30]**
- ⑩ **Multi source button (MULTI SOURCE) [30]**
- ⑪ **Multi source level up/down buttons [30] (LEVEL ▲/▼)**
- ⑫ **Group selector button (GROUP) [21]**
- ⑬ **Preset memory UP/DOWN buttons (PRESET ▲/▼) [21]**
- ⑭ **Audio muting button (MUTING)**
This button temporarily switches off the sound from the speakers or headphone by operating this unit audio muting circuits. The audio muting indicator "AUDIO MUTING" will flash. Pressing the button again or using the POWER button to turn the power on will turn off the audio muting.
 - Pressing this button does not mute the sound of the multi source.
Press the SPEAKERS REMOTE button to mute the sound of the multi source.
- ⑮ **Volume buttons (VOLUME ▲/▼) [18, 19]**
- ⑯ **Center level up/down buttons (CENTER LEVEL ▲/▼) Rear level up/down buttons (REAR LEVEL ▲/▼) [26]**

Listening to your favourite source

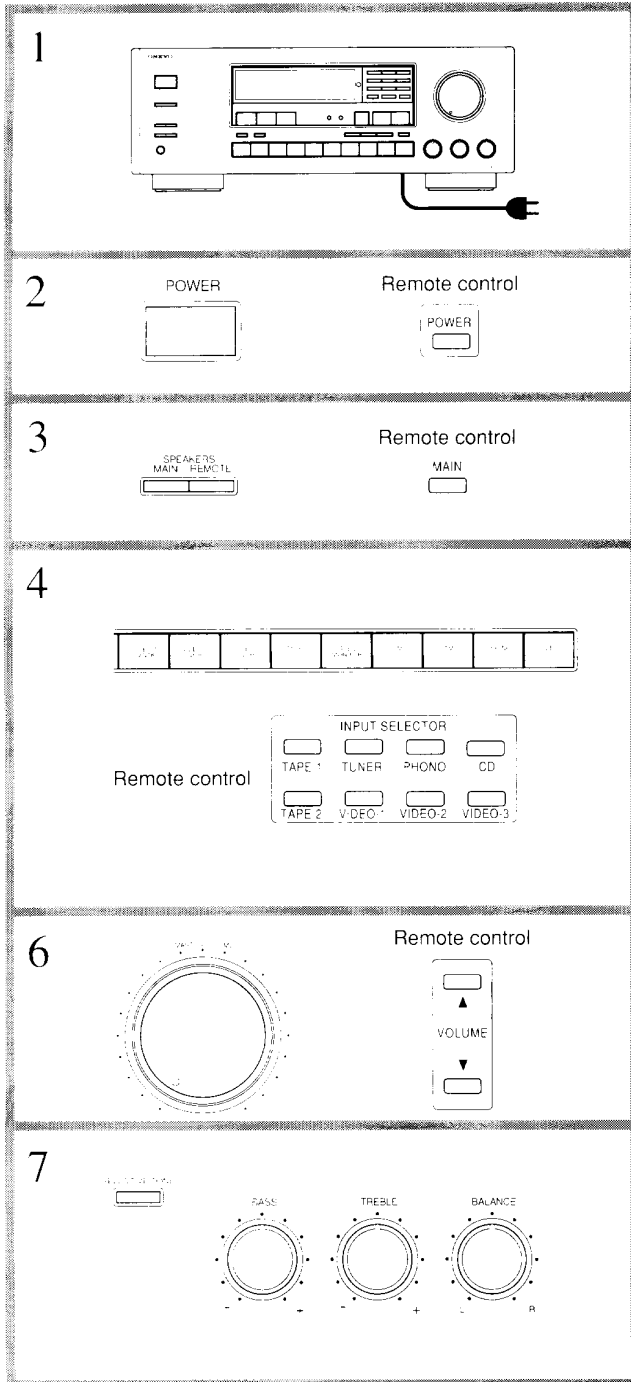
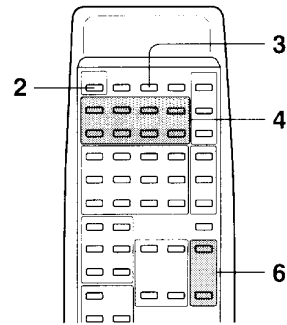
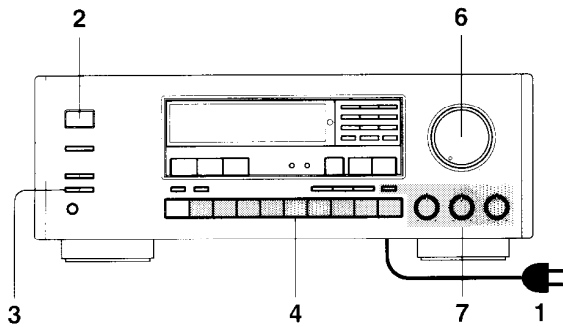

Basic operation

Before plugging in the unit, confirm that all connections have been made properly.

1. **Insert the AC power supply cord into the wall outlet.**
The STAND-BY/RECEIVED indicator comes on.
2. **Press the POWER button to turn on the power.**
3. **Press the MAIN speakers button.**
MAIN indicator lights up.
4. **Press the desired input selector button.**
Confirm that the TAPE-2 MONITOR indicator is off when a source other than the TAPE-2 MONITOR has been selected. Also check the audio muting is off.
5. **Start the selected input source playing.**
Follow the operating instructions of that unit.
6. **Adjust the volume to appropriate level using the MASTER VOLUME knob or VOLUME ▲/▼ buttons on the remote control.**
7. **Adjust the tone controls**

Listening to your favourite source

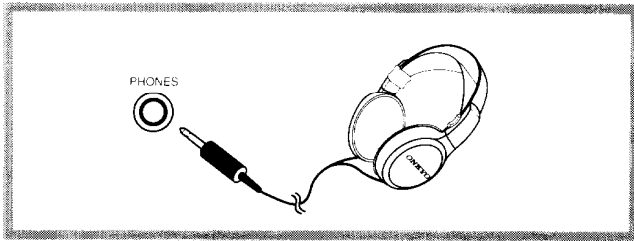

Using headphones

Stereo headphones with a standard stereo jack plug can be connected to the PHONES jack. The sound heard through the headphones is the same sound that can be heard from the Front speakers, although it may be slightly different from what is heard from the speakers when the Surround mode is used. (The sound from the headphones may sound a little distant.)

Explanation of the buttons

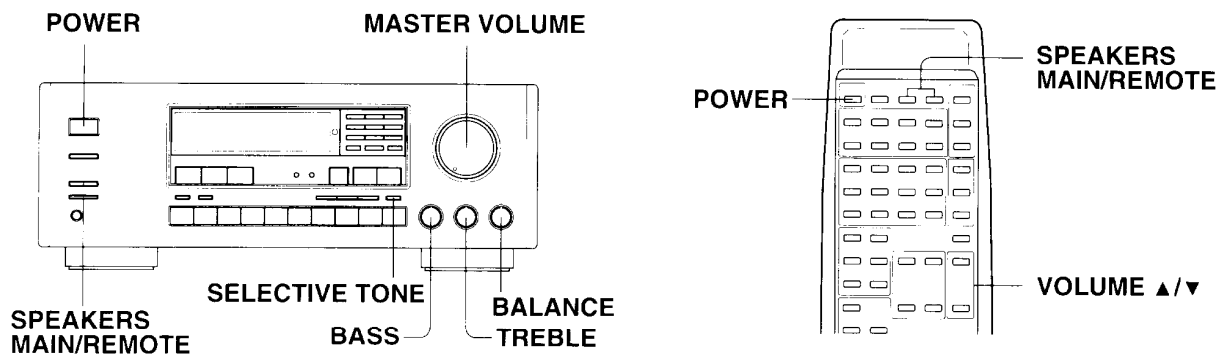

■ Power button (POWER) and STAND-BY/RECEIVED indicator

The STAND-BY/RECEIVED indicator comes on when the AC power cord for this unit has been inserted in an outlet.

This indicates that this unit is standing by for operation. Press the power button will turn the main unit on, then this indicator goes off. The indicator also lights when a signal is received from the remote control.

■ Speaker selector buttons (SPEAKERS MAIN/REMOTE) and indicators

MAIN button This button turns on or off the speakers connected to the MAIN, CENTER and REAR terminals.

When the speakers are turned on, the MAIN indicator lights up.

REMOTE button This button turns on or off the speakers connected to the REMOTE terminals.

When the speakers are turned on, the REMOTE indicator lights up.

Turn on these speakers when using multi source. (See page 30.)

■ Master volume control knob (MASTER VOLUME)

Use this knob to adjust the volume of the Front, Main, Center, Rear (Surround) speakers.

■ Tone and balance controls

Treble, bass and selective tone are effectively only for the Front L and R speakers.

The best results are obtained from DOLBY PRO LOGIC Surround when the center and front L and R speakers contain the same amounts of mid and high frequencies. As the treble and bass control do not affect the Center speaker, adjust the tone controls for the Front L and R speakers to match the sound given by the Center speaker. Because of this, we recommend the use of a good quality center speaker.

● Bass control knob (BASS)

Adjust to strengthen or weaken bass response.

● Treble control knob (TREBLE)

Adjust to strengthen or weaken treble response.

● Selective tone control button (SELECTIVE TONE) and indicator

The selective tone control is used to clearly reproduce ultra low and high frequencies, and only affects the Front speakers.

● Balance control knob (BALANCE)

Use the balance control knob to adjust the relative volume levels of the right and left front Main speaker systems. This adjusts the relative volume level of the Front Main speakers only.

Using the tuner

Please make sure that the TAPE-2 MONITOR indicator is off and audio muting is off.

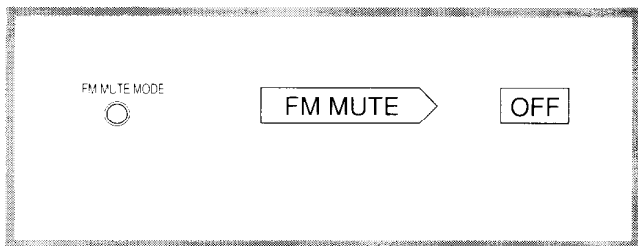
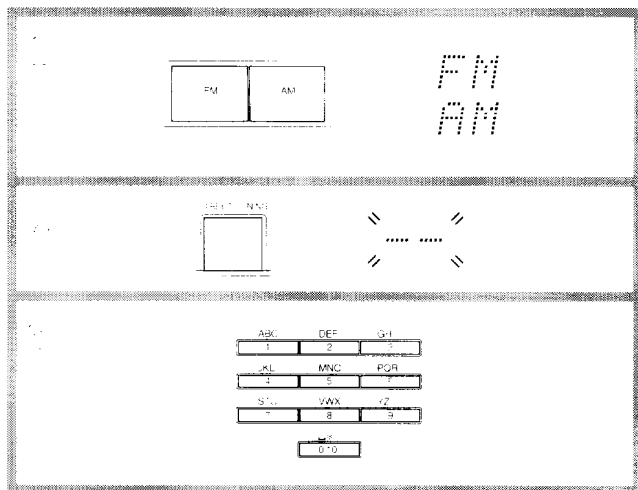
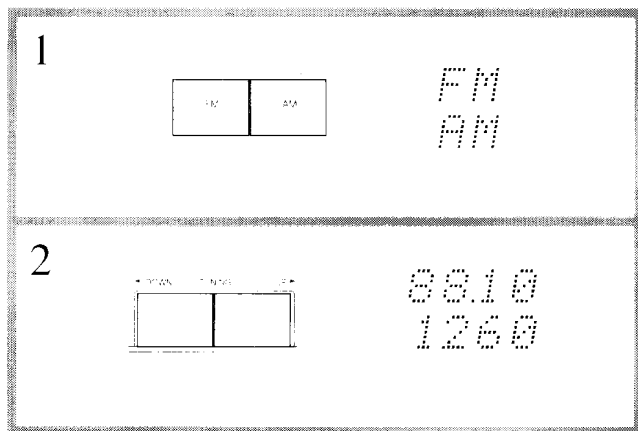
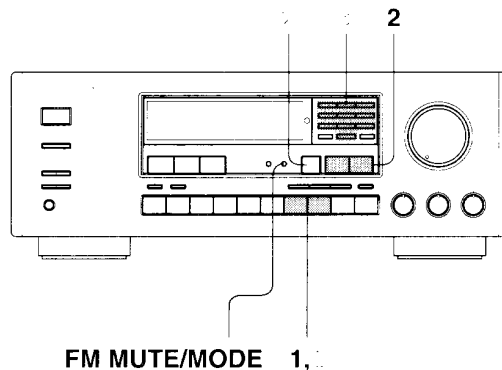

Tuning the radio (Manual tuning and Direct tuning)

When the frequency is not known—Manual tuning

1. Press the FM or AM button.
 2. Use the ◀ DOWN TUNING UP ▶ buttons to change the frequency.
 - UP.....the frequency increases.
 - DOWNthe frequency decreases.
- The frequency is changed in 50 kHz steps in FM and 10 kHz (or 9kHz) in AM when the tuning selector button is pressed in single steps.
 - If this button is held continuously for more than 0.5 seconds, the frequencies are scanned automatically. (FM auto tuning mode) When a broadcast is received, scanning stops.

When the frequency is known—Direct tuning

1. Press the FM or AM button.
 2. Press the DIRECT TUNING button.
 - The "—" will flash 16 seconds in the frequency display.
 3. Enter the frequency with the number buttons while the cursor are flashing.
- Example: 88.10 MHz 8 → 8 → 1 → 0/10
- When receiving AM broadcasts with a 9 kHz step (this depending on your region), you can enter the frequency directly.
 - With 10 kHz steps, entering a number for the 10 kHz digit will set the 1 kHz digit automatically to 0.
 - If you enter a frequency that does not have a station, this unit will automatically tune to the next station immediately below that station.
 - If you enter a frequency that is out of range, this unit will return to the previous frequency. If this happens, repeat the procedure.

Listening to a stereo radio stations (FM only)

If you tune in a stereo FM station, the STEREO indicator will be illuminated if the signal is sufficiently strong. If the signal is weak, it may be impossible to tune in to your desired station. In this case, tune in as follows. Press the FM MUTE/MODE button and FM MUTE OFF lights. At this time, the station will be in mono and interstation noise will be heard. Select the station you want listen to.

Using the tuner

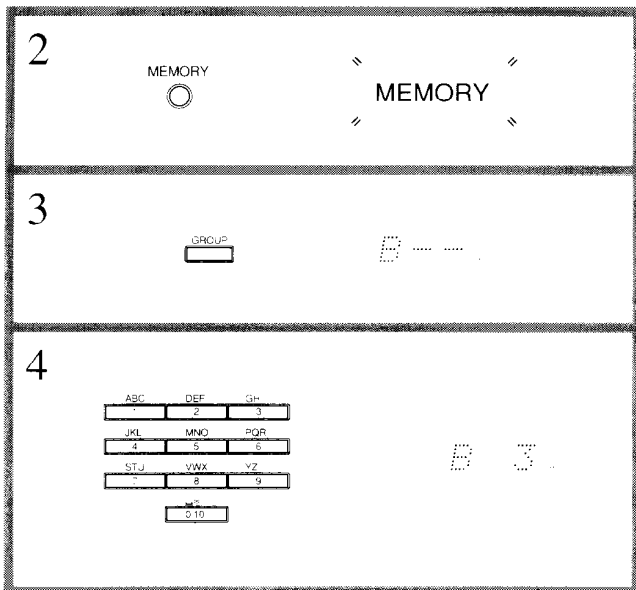
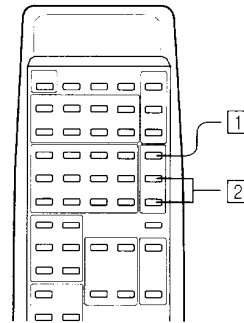
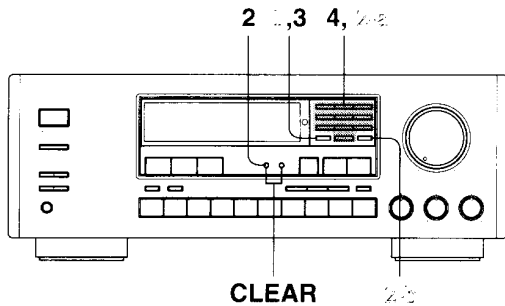

Using preset stations

Since ten AM or FM stations can be stored in each group (A, B or C), a total of 30 stations can be stored in the memory.

Programming radio station

1. **Select the frequency that you want to store in the memory.**
(See page 20 Tuning the radio)
2. **Press the MEMORY button.**
The MEMORY indicator will light for 8 seconds.
3. **While the MEMORY indicator lights, press the GROUP button to choose the desired group.**
The group shown on the display changes in the following order each time the button is pressed: A → B → C → A.
4. **Select the desired memory number using the number buttons.**
Press button 0/10 when choosing memory number 10.

NOTE (European model only):

If the FM station received is an RDS station with a PS (Program Service Name), the frequency display will change to the PS display. If there is no PS, the frequency display will not change.
(Refer to page 22 – 24 for the RDS function)

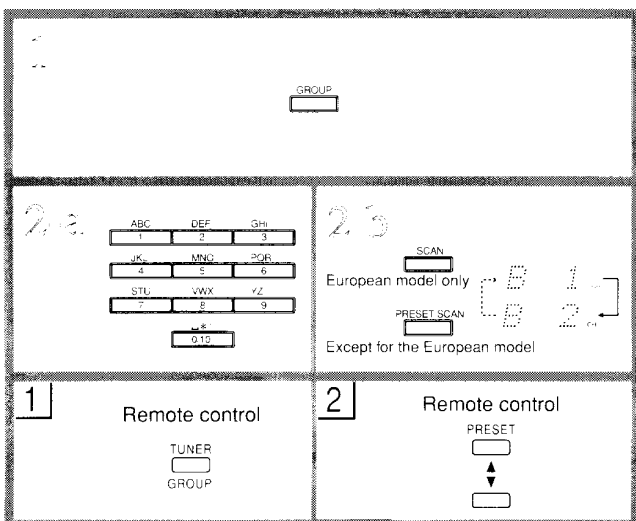

Selecting preset stations

Main unit

1. **Press the GROUP button to select the desired group.**
2. **Input the memory number you wish to receive by using the number buttons.**
3. **Press the SCAN (or PRESET SCAN) button.**
Each station stored in the group chosen in step 1 will be received for 5 seconds (for each station).
When the station that you want is found, press the SCAN (or PRESET SCAN) button again and scanning will stop.

Remote control

- 1 **Press the GROUP button and choose the group.**
- 2 **Press the PRESET (▲ or ▼) button.**
After the last number of GROUP C is reached, scanning will restart at GROUP A.

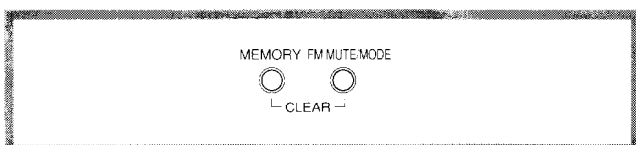

Cancelling preset stations

1. **Select the station that you want to cancel as explained in the previous section.**
2. **Press the FM MUTE/MODE button while holding down the MEMORY button.**
"-" will be shown on the display.

Receiving RDS (European model only)

RDS reception is only available on the European model, and only in areas where RDS broadcasts are available.

What is RDS?

Many FM stations now transmit RDS signals which give additional information. RDS provides you with various services so that (for example) you can choose a station broadcasting your favorite categories of music, or other information. The information on the right side is available on this unit.

NOTE:

In some cases, the characters displayed on the display of the TX-SV535 may not be exactly the same as the ones broadcast by the radio station. If strange characters appear in the display, it is because characters are being received that cannot be correctly displayed by the TX-SV535. They do not indicate a malfunction of the unit.

PS: Program Service Name

When an RDS station broadcasting PS information is received, the name of the station will be displayed instead of the frequency.

PTY: Program Type

When an RDS station broadcasting PTY information is received, the type (category) of the broadcast will be displayed.

TP: Traffic Program

When an RDS station broadcasting TP information is received, the traffic information will be displayed.

RT: Radio Text

When an RDS station broadcasting RT information is received, the information received from the station will be shown on the display.

PTY Classifications in Europe

0	NONE	None	No program type or undefined.
1	NEWS	News reports	Reports on current events and happenings.
2	AFFAIRS	Current affairs	Topical reporting of current affairs, often with a wider range of topics than news reports.
3	INFO	Information	General information such as weather forecasts, consumer affairs, medical help etc.
4	SPORT	Sport	Live sports action, sports news and interviews.
5	EDUCATE	Education	Formal educational programs.
6	DRAMA	Drama	Radio plays and serials
7	CULTURE	Culture	Cultural programs (including religious affairs)
8	SCIENCE	Science and technology	Programs about the natural sciences and technology.
9	VARIED	Varied	Speech based programs not covered by the above categories eg. quizzes, panel games, comedy, etc.
10	POP M	Pop music	Popular commercial music, usually included in past or present sales charts.
11	ROCK M	Rock music	Popular music with a more specialist appeal, often not included in sales charts.
12	M. O. R. M	Middle of the road music	Easy listening music as opposed to Pop, Rock or Classical.
13	LIGHT M	Light classics	Classical music for general rather than specialist appreciation.
14	CLASSICS	Serious classics	Performances of major orchestral works, symphonies, chamber music etc. and including Grand Opera.
15	OTHER M	Other music	Music styles not covered by the above categories, eg. Jazz, Rhythm & Blues, Folk, Country, Reggae.

Receiving RDS (European model only)

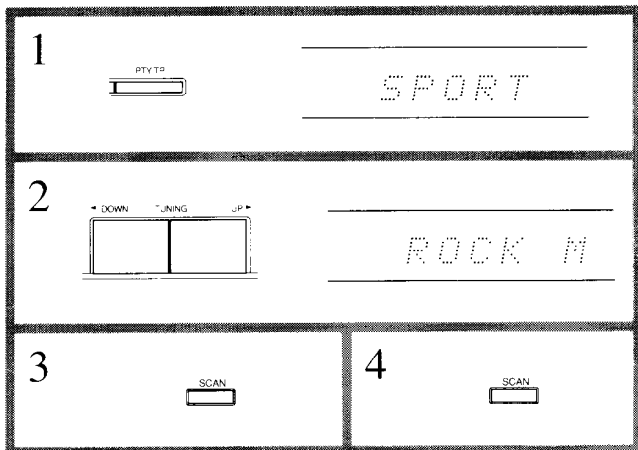
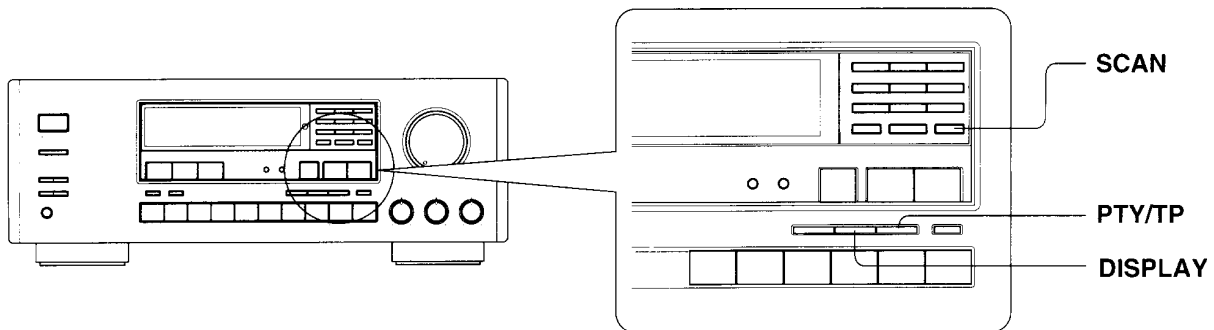

How to search for a station which broadcasts your favorite category (PTY scan)

1. Press the PTY/TP button, to select "PTY".
If the station you are receiving is not broadcasting RDS, "Not RDS" (this is not an RDS station) will be shown on the display.
2. Use the ◀ DOWN TUNING ▶ buttons to select the program type (PTY) (for example, "ROCK M").
See the PTY description on the previous page.
3. Press the SCAN button to start searching for the chosen PTY station. When a station is received with the desired PTY, the scanning stops for approximately 5 seconds, before the unit starts scanning again.
4. When the desired station is reached, press SCAN button again to stop scanning.

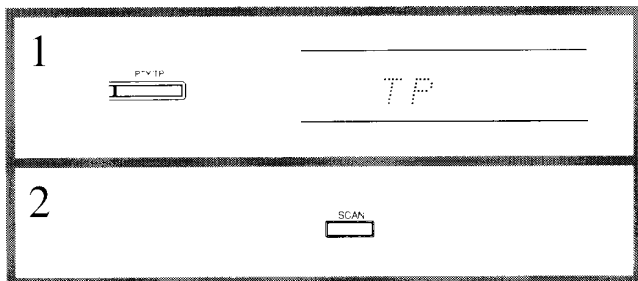

Receiving RDS traffic Information

1. Press the PTY/TP button to select "TP".
If $\uparrow TP \downarrow$ is shown on the display, it indicates that the current station is broadcasting traffic information.
2. Press the SCAN button to start searching for a TP station.
When the unit receives a TP station, it stops scanning. If the unit cannot receive any TP station, "Not find" (cannot find the station) is shown on the display.



Displaying Radio Text (RT)

If the station you are listening to is not an RDS station, this function cannot be used.

1. Each time you press the DISPLAY button, the display changes as follows.

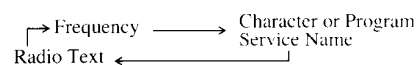

If the current station you are listening to is not an RDS station, only the frequency of the station and the characters (see pages 24) appears. (If there have been no characters entered, only the frequency is shown.)

When RT is received, it can sometimes take up to 15 seconds (more or less) to show RT on the display.

Sometimes the following messages will be shown on the display.

Wait: When the information is received, the characters will scroll across the display.

No text: this appears for 3 seconds and indicates that even though an RDS station is being received, there is no RT information included.

Entering station names (European model only)

Characters can be entered during reception of an FM or AM broadcast station.

This function enables you to memorize a maximum of 8 characters consisting of alphabetic, some symbols and numbers, for instance, representing broadcasting names, for each preset station.

If you attempt to enter characters while receiving an FM broadcast RDS station, "RDS...PS" is displayed and characters cannot be entered.

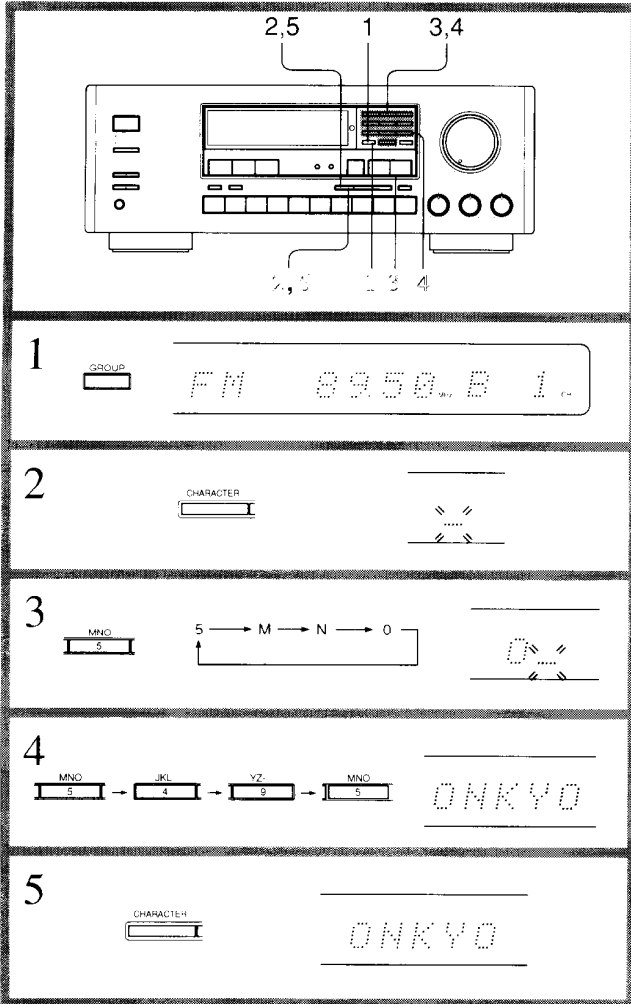

Characters which can be input

A B C D E F G H I J K L M N O P Q R S T U V W X Y
Z 1 2 3 4 5 6 7 8 9 0 - _ * /

Note: _ indicates a space.

Entering new characters

To name ICH of GROUP B as "ONKYO", for example, operate as follows. (Example: FM broadcast at 89.50 MHz has been memorized into ICH of GROUP B).

1. Press the GROUP and number button.

The memorized broadcast station is received.

2. Press the CHARACTER button.

The frequency in the display goes off and "_" flashes.

3. To enter O from "ONKYO", press the 5MNO button.

Pressing the button each time changes the character from 5 to M, N, and O, one at a time. Select O.

- "_" will move to the next character. (If you do not press the number button for one second, "_" will automatically move to the next position.)

- When you want to delete a character, press the DIRECT TUNING button. The character is deleted, and the characters on the right move to the left by one space.

4. Repeat step 3.

To enter N from "ONKYO", press the 5MNO button and select N.

To enter K from "ONKYO" press the 4JKL button and select K.

5. Press the CHARACTER button.

If you have not pressed a button for 16 seconds, the operation will complete automatically.

Clearing all of the characters stored in memory

1. Press the CHARACTER button.

2. While pressing the MEMORY button, press the FM MUTE/MODE button.

All the characters entered for this station will be cleared.

Changing existing characters

1. Press GROUP buttons to recall the desired preset number.

2. Press the CHARACTER button.

The first character and "_" flashes alternately.

3. Press the ◀ DOWN TUNING UP ▶ button and move "_" to the character you want to change.

"_" moves to the right when pressing the UP ▶ button and moves to the left when pressing the ◀ DOWN button.

4. Enter the desired character.

The previous character is replaced with a new character.

5. Press the CHARACTER button.

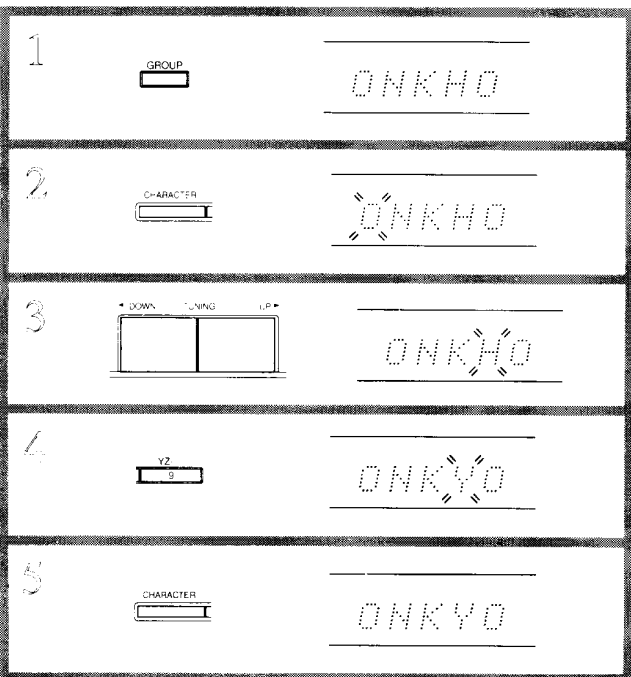

Use of surround mode

This unit is provided with 5 kinds of Surround modes. Select a mode by pressing the DOLBY PRO LOGIC button, DSP MODE button or BY-PASS button. (When using the remote control, press the SURROUND MODE button.) Make your choice of modes depending on the type of music you are listening to, the media used, and your personal preference. See page 26 for instructions about setting the speaker-volume levels for each mode.

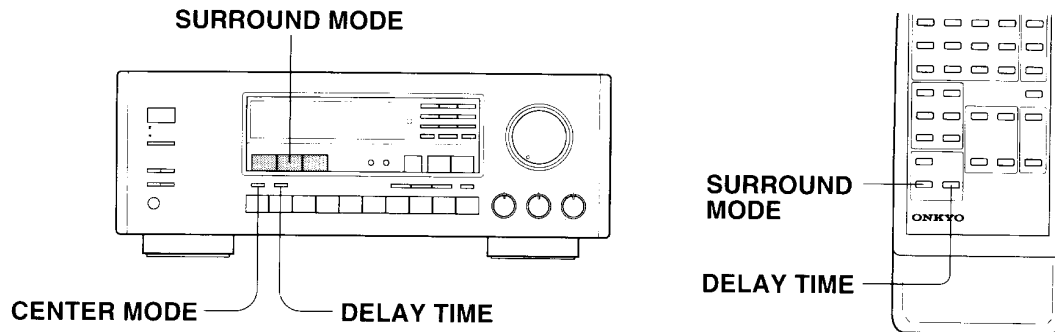

Explanation 1: Surround mode

Dolby Pro Logic

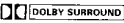
By using video tape and laser discs with the  trade mark. You can decode four channel surround sound.

Theater

There are many surround speakers in an actual theater. Use this mode for creating a theater atmosphere. This mode is suitable for playback of media recorded with Dolby Surround.

Hall

Simulates the atmosphere of a concert hall. Intended for classical music.

Live

Reproduces the feeling of a live performance.

Arena

This mode recreates the feel of listening to a pop concert in a domed stadium.

By-Pass

This mode is used when you do not wish to use the Surround mode. All input sound is output from the front speakers directly.

NOTE:

In the surround mode, each selected source along with the input selector source is automatically stored, and concequently recalled when that input selector source is selected.

Explanation 2: Center mode

Because the center speaker plays such an important part in Dolby Pro Logic surround, three different modes are available for it, depending on its size. Select a mode by pressing the CENTER MODE button.

NORMAL: Use this setting when a small enclosure center speaker is utilized.

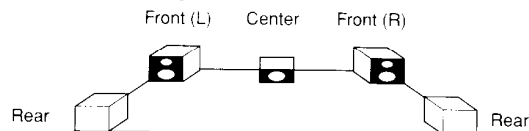

WIDEBAND: Use this setting when a speaker similar to the left and right stereo speakers is utilized.

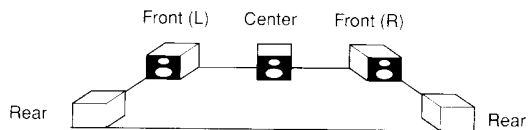

PHANTOM: When a center speaker is not present.

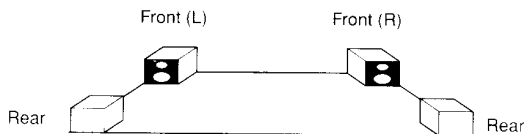

When you press the CENTER MODE button, the name of each mode will be shown on the display for 3 seconds in turn.

Explanation 3: Delay time

You can change the delay time for the sound from the rear (surround) speakers.

Pressing the DELAY TIME button changes the delay time every 1 msec during a period of 15 to 30 msec in Dolby Pro Logic and Theater, and every 5 msec during a period of 10 to 40 msec in Hall, Live and Arena. Dolby Surround delay time is specified at 20 msec. It is recommended that initial Dolby Surround delay time be set at 20 msec, and adjustment to either 15 or 30 msec possible via the control. By adjusting the delay time, and carefully adjusting Master Volume Level, Center Volume Level and Rear Volume Level, the apparent acoustic size of your listening room can be enlarged or deduced. Adjustable delay time allows you to tailor the acoustic size of your listening environment to match the sonic characteristic spaces, such as concert halls, cathedrals, etc. Use a shorter delay to simulate the size of a small club or cabaret. Respective delay time can be memorized for each surround mode. This operation can also be performed using the delay time button of the remote control.

- When you press the DELAY TIME button, DELAY and the delay time will be shown for 3 seconds on the display.
- For surround modes other than Dolby Pro Logic and Theater, a reverb effect is applied in conjunction with the delay time.

Use of surround mode

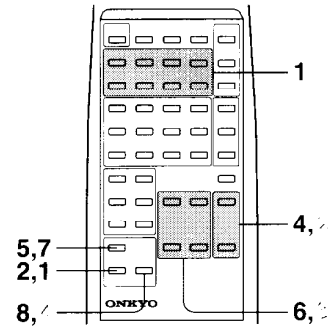
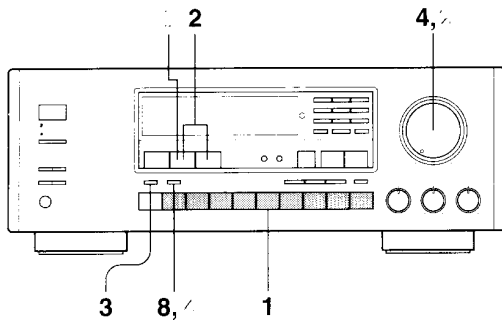

1

Remote control

2, 1

Remote control

3

4, 1

Remote control

5

Remote control

6, 1

Remote control

7

Remote control

8, 1

Remote control

Setting the Dolby Pro Logic surround or Theater mode

When using video cassette tapes or video discs with the Dolby Surround trademark, you can achieve the same kind of sound in your room that can be experienced in a movie theater.

1. Select a source encoded with Dolby surround.
2. Press the DOLBY PRO LOGIC button to select Dolby Pro Logic surround mode, or press the DSP MODE button to select Theater mode.

If you are working from the remote control, press SURROUND MODE button to select either PRO LOGIC or THEATER.

3. Use the CENTER MODE button to select Center mode. (Explanation 2)
4. Use the MASTER VOLUME to set the volume to the desired listening position.

5. Press the TEST button to start test-tone cycling. The test tone (pink noise) cycles from speaker to speaker. The cycling sequence depends on the Center Mode settings, as follows.

If Center Mode is NORMAL or WIDEBAND:

→ left front → center → right front → rear →

When the center mode is set to PHANTOM:

→ left front → right front → rear →

6. Using the test tone as your reference, adjust the center and rear speaker levels with the CENTER/REAR LEVEL ▲ and ▼ buttons on the remote control.

When one of these buttons is pressed, the level is shown on the display for three seconds. The level can be adjusted in each Surround mode and stored for that specific mode.

7. Press the TEST button again to turn off the test tone.
8. Adjust the delay time (Explanation 3).

Adjusting the Hall, Live and Arena Surround parameters

1. Use the DSP MODE button to select either Hall, Live or Arena (Explanation 1).
2. Use the MASTER VOLUME to set the volume to the desired listening position.
3. Adjust the center level, and rear level using the CENTER LEVEL ▲/▼ and REAR LEVEL ▲/▼ buttons on the remote control.
4. Adjust the delay time (Explanation 3).

Recording a source

Recording an audio source

Tape recording

With the TX-SV535 you can perform recording while listening to the sound of another source through speakers or headphones. Make all connections between the tape deck and the unit as shown in the system connections diagram. When recording a tape while the multiple room remote control is connected, turn the MR off (the MR OFF indicator will light) to disable remote control operation from another rooms.

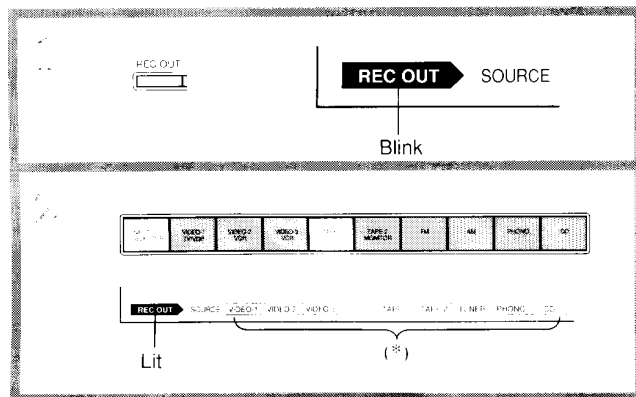
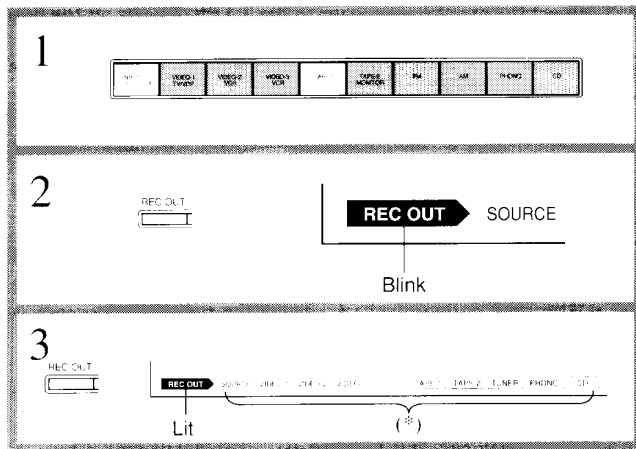
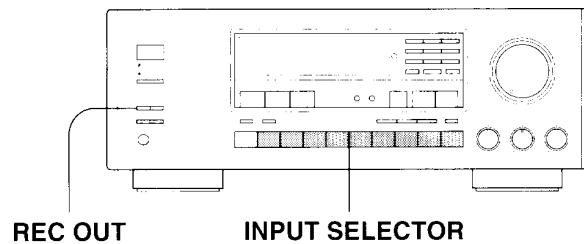

Recording and dubbing to a tape deck connected to TAPE-1

- When recording the same source you are listening to
 - Press the input selector button to select the source to be recorded. (other than TAPE-1)
 - Press the REC OUT button.
 - Press the REC OUT button again while the REC OUT indicator is flashing.

The SOURCE indicator and the source you have chosen will be displayed in red boxes. (*)
 - Start the device selected in step 1 while setting the tape deck connected to TAPE-1 to recording mode.

NOTE:

- Never change the positions of any controls on this unit during recording and dubbing operations.
- Pressing the input selector button during recording will change the source being recorded.
- When the TAPE-2 MONITOR indicator is on, only TAPE-2 can be recorded and if the input selector is changed, the TAPE-2 MONITOR indicator will not change.

- When recording a source different from the one you are listening to
 - Press the REC OUT button.
 - Press the input selector button for the source to be recorded. (other than TAPE-1) while the REC OUT indicator is flashing.

The chosen source will be displayed in a red box. (*)
 - Start the device selected in step 2, and start recording on the tape deck connected to TAPE-1, or on any recording device connected to the VIDEO-2 or VIDEO-3 audio output jacks.

NOTE:

- The source you selected to record will be output from the TAPE-1, VIDEO-2 and VIDEO-3 REC OUT jacks. The source you are listening to does not change.
- If you choose to record from FM or AM while listening to another source, the tuner's frequency and group displays will be shown for 3 seconds.

Recording a source

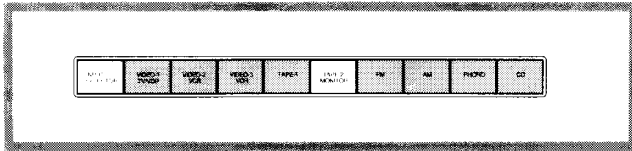

Recording and dubbing to a tape deck connected to TAPE-2

1. Press the input selector button of the source to be recorded.
(other than TAPE-2)
2. Start playing back the device selected in step 1, and start recording on the tape deck connected to TAPE-2.

NOTES:

- When the TAPE-2 MONITOR is off, any source signals can be monitored through the speakers or the headphones (this is normal operation).
- If tape deck 2 is 3-head type however, you can monitor the recording directly of the tape by turning TAPE-2 MONITOR on. Refer to the tape deck instruction manuals for more details.
Set the recording level using the controls on the tape deck used for recording.

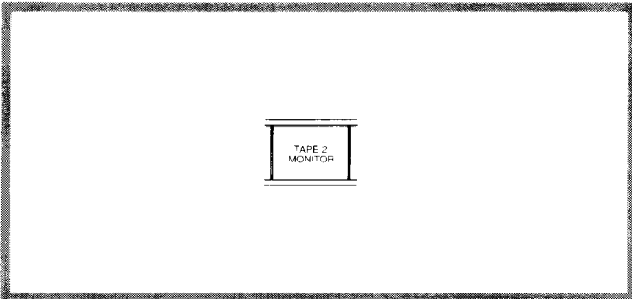

Using the graphic equalizer

1. Connect the graphic equalizer to the TAPE-2 jacks on the rear panel.
2. If a second tape deck is used, connect it to the tape jacks on the graphic equalizer.
3. Press the TAPE-2 MONITOR button to turn on the TAPE-2 MONITOR indicator.

Follow the graphic equalizer operation instructions.

To record an equalized signal, use the tape deck (connect to the equalizer) for recording.

NOTE:

Since the surround function may be less efficient if a graphic equalizer is also used during playback, flatten the frequency response on the graphic equalizer.

VCR recording

Data can be recorded from video-disc players, video cassette recorders connected to VIDEO-2 and 3.

Connect the VCR to VIDEO-2 and/or VIDEO-3.

Refer to each instruction manual for information concerning video-disc players, video camcorders, video cassette recorders and monitor TV.

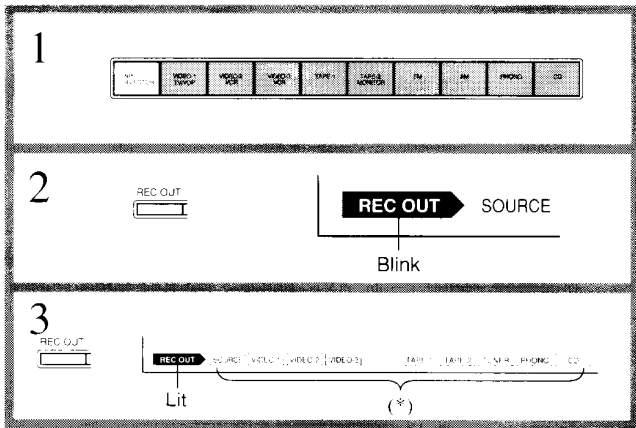

Recording to VIDEO-2 and VIDEO-3

- a. Recording the source being played back.
 1. Select the source to be recorded with the input selector buttons.
 2. Press the REC OUT button.
 3. Press the REC OUT button again while the REC OUT indicator is flashing.
The SOURCE and the source you have chosen will be displayed in red boxes. (*)
 4. Start the source selected in step 1, and start recording on the VCR connected to VIDEO-2 and/or VIDEO-3.

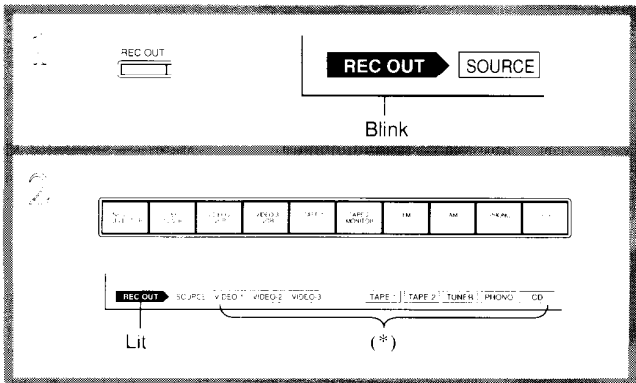

- a. Recording a source different from the one being played back
 1. Press the REC OUT button.
 2. Press the input selector button of the source to be recorded while the REC OUT indicator is flashing.
The chosen source will be displayed in a red box. (*)
 3. Start the source selected in step 2, and start recording on the VCR connected to VIDEO-2 and/or VIDEO-3.

Recording a source

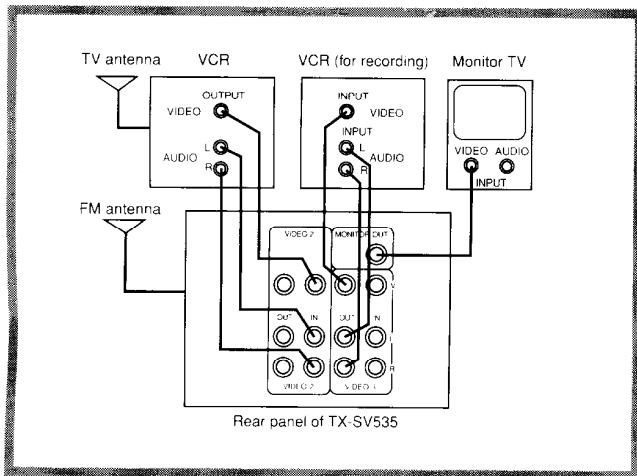

Playback and recording of TV picture and FM/ CABLE TV sound

Recording of a TV broadcast and FM broadcast (simulcast) is possible when two VCR are used.

1. Receive the TV broadcast using the VCR tuner.
2. Press the VIDEO-2 or -3 input selector to set the picture to VIDEO-2 or -3.
3. Press the FM Input Selector and tune in the FM simulcast using a preset button or the tuning selectors.
The picture will be sent to the monitor TV and the FM stereo sound to the speakers connected to this unit.
4. To record the TV picture with FM sound, receive the TV broadcast using one VCR (connected to VIDEO-2 (or 3)) and begin recording on the other VCR (connected to VIDEO-3 (or 2)).
The program can be monitored during recording.

Mixing video and audio for VCR recording

1. Press the Input Selector button to select the VCR (VIDEO-1, 2 or 3) that will be used to play the video.
2. Press the REC/PAUSE button on the VCR (VIDEO-2 or 3) that will be doing the recording.
3. Press the REC OUT button.
4. Press the Input Selector button (CD, PHONO, FM, AM, TAPE-1 or TAPE-2) that will provide the audio source.
5. Start operation of the equipment.

The picture will be left as is. Only the audio will be changed. The picture will be recorded from the video source, and the sound from the audio source.

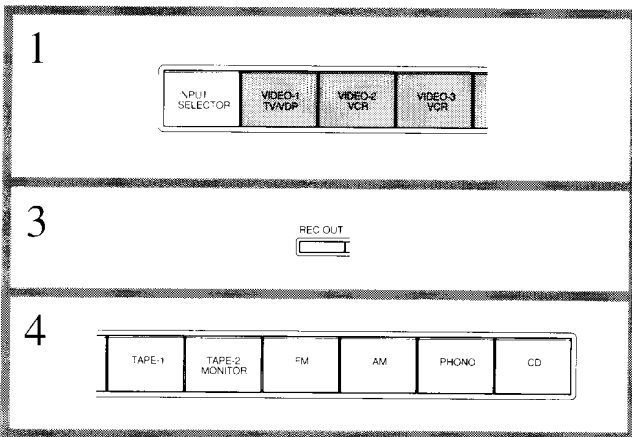

Listening to devices connected to this unit in another room

Make sure that recording is not being carried out before performing the following operations.

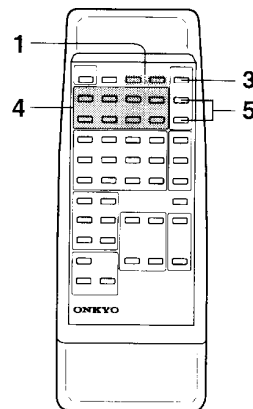
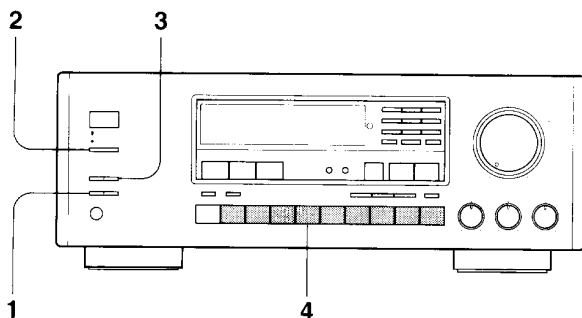

The following steps (except step 2) can be performed using the remote control. It is recommended that the adjustments described below be done in the main room in advance, since it is not possible to operate the remote control in another room while watching the display of the TX-SV535.

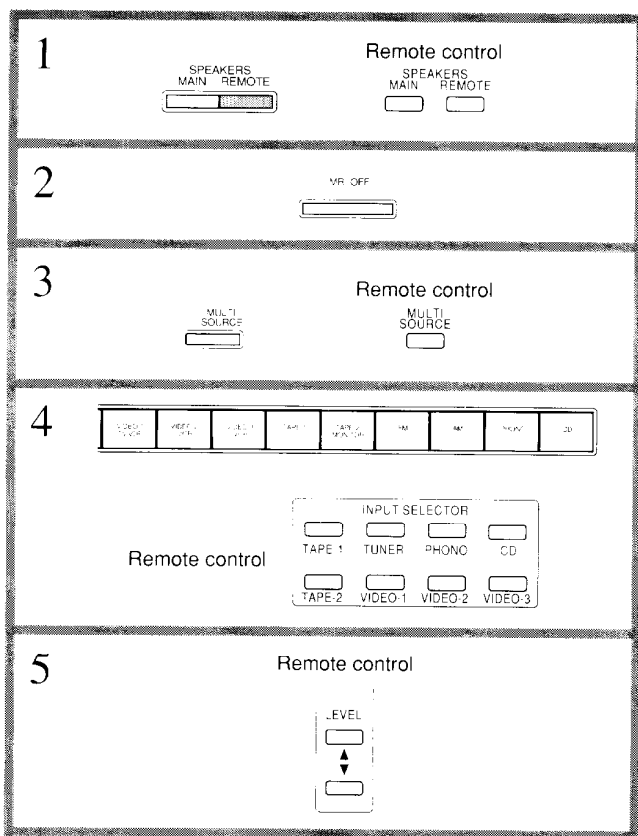

In the main room:

1. Press the **SPEAKERS REMOTE** button to illuminate the **REMOTE** indicator.

Press the **MAIN** button to turn off the **MAIN** indicator if you are not listening to the sound in the main room.

2. Turn the **MR OFF** button off.

MR OFF indicator is turned off.

In the sub-room, direct the remote control toward the Dinky Link or J-Box Receiver (Xantech system) or toward the Remote Sensor (Onkyo system) and:

3. Press the **MULTI SOURCE** button.

REC OUT indicator will be turned off and the

MULTI SOURCE indicator will flash for 8 seconds.

4. While this is flashing, use the **Input Selector** button to select the desired source.

If the tuner is selected with **MULTI SOURCE** and the **Input Selector** is set to something other than **TUNER**, the tuner's frequency and group displays will be shown for 3 seconds.

When changing the source, be sure to press the **MULTI SOURCE** button before pressing the **Input Selector** button. Pressing the **Input Selector** button without first pressing the **MULTI SOURCE** button will change the source in the main room.

5. Adjust the level using the **MULTI SOURCE LEVEL** ▲ / ▼ buttons on the remote control.

MULTI and the level will be indicated on the display for three seconds, the indication for the sub room output level ranges from the minimum of ($-\infty$ dB), -78, -77, ... -1, to the maximum of (0 dB).

You can switch the sub-room source in the main room.

1. Press the **MULTI SOURCE** button on the main unit.
2. While the **MULTI SOURCE** indicator flashes, use the input selector buttons to select your desired source. (If an input selector button is pressed while the indicator is off, the main room source will change.)

If the remote controller is used from the sub-room, but the components cannot be controlled, check the following.

- Use the buttons and switches on the component in the main room to check whether it is working properly. Then, use the remote control to check whether the component is working properly. If it is not, refer to page 5.
- When operating a component that does not display Onkyo's **RI** mark, check that the emitter is directed toward that component.
- Check that the components are correctly connected.
- Check that the **MR OFF** button on the TX-SV535 is not turned on (the indicator should not be lit).

Trouble shooting guide

NOTE:

If a problem occurs while you are using the remote control, first operate the unit using the front panel controls to confirm that it is not due to a malfunction (or worn out batteries) of the remote control.

Trouble	Cause	Remedy
No power.	<ul style="list-style-type: none"> ● Power cord is disconnected. ● There is external noise in the computer circuits of the TX-SV535. ● AC fuse blown. 	<ul style="list-style-type: none"> ● Connect power cord. ● Turn the power button off and then on again or remove the AC plug from the outlet and then plug it again. ● Contact your ONKYO service center.
Power but no sound.	<ul style="list-style-type: none"> ● Tape-2 monitor switch on. ● Audio muting switch on. ● Bad connections. ● Amplifier protection circuitry has been activated. ('PROTECT' will be displayed.) 	<ul style="list-style-type: none"> ● Switch to off. ● Switch to off by remote control transmitter ● Check connections, speaker leads, etc. ● Contact your ONKYO service center.
Hum, low-frequency noise.	<ul style="list-style-type: none"> ● Poor or no input ground. ● Poor or no phono motor ground. ● The placement of the audio connection cable on the rear panel is not correct. 	<ul style="list-style-type: none"> ● Check outer conductor of input plugs. ● Check for proper ground connection. ● Adjust the placement of the cables to reduce hum.
Howling when the volume is turned up.	<ul style="list-style-type: none"> ● Turntable and speakers are too close together. 	<ul style="list-style-type: none"> ● Move them farther apart.
Rough or scratchy sound. High range is not clear.	<ul style="list-style-type: none"> ● Stylus of pick-up is worn. ● Stylus tip is dirty. ● Treble control too high. 	<ul style="list-style-type: none"> ● Replace. ● Clean. ● Turn treble control down.
AM stations cannot be received.	<ul style="list-style-type: none"> ● AM loop antenna is not attached. 	<ul style="list-style-type: none"> ● Connect the included AM loop antenna to the AM antenna terminals.
Buzzing noise on AM (particularly conspicuous at night or with weak stations).	<ul style="list-style-type: none"> ● Noise from electrical apparatus such as fluorescent lamp. 	<ul style="list-style-type: none"> ● Move AM loop antenna to different position. ● Set up outdoor AM antenna.
High-pitched noise or buzzing noise on AM.	<ul style="list-style-type: none"> ● Noise from TV set. 	<ul style="list-style-type: none"> ● Place the AM loop antenna as far as possible from the TV. ● Move unit away from TV set.
Crackling noise on AM, FM.	<ul style="list-style-type: none"> ● Noise caused by turning fluorescent lamp on and off. ● Noise from automobile ignition. 	<ul style="list-style-type: none"> ● Move antenna as far as possible from the fluorescent lamp. ● Install an FM outdoor antenna as far as possible from the road. ● Change the position or direction of the outdoor antenna.
FM tuned and stereo indicators light but sound is distorted and stereo separation is bad.	<ul style="list-style-type: none"> ● Station is too strong. ● Multiple reflection of the radio waves because of tall buildings or mountains. 	<ul style="list-style-type: none"> ● Change to T-shaped antenna. ● Use antenna which has better directivity and select a point where the distortion is least.
FM tuned indicator and stereo indicator flicker and hiss is heard on FM.	<ul style="list-style-type: none"> ● Station is too weak. ● Stereo FM broadcasts cover only about half the distance of an ordinary broadcast. 	<ul style="list-style-type: none"> ● Install an outdoor FM antenna. ● Change the position or direction of the outdoor antenna.
No station is recalled when a preset key is pressed.	<ul style="list-style-type: none"> ● The power cord has been unplugged for a long time. 	<ul style="list-style-type: none"> ● The memory contents are lost. Store all stations again.
The multiple room remote system does not operate.	<ul style="list-style-type: none"> ● Connection is wrong. ● The MR OFF button on the TX-SV535 is engaged. (The MR OFF indicator will light.) 	<ul style="list-style-type: none"> ● Check the connection again. ● Press the MR OFF button. (The MR OFF indicator will be turned OFF.)
Front panel controls function but remote control transmitter does not.	<ul style="list-style-type: none"> ● No batteries in remote control transmitter. ● Batteries have worn out. 	<ul style="list-style-type: none"> ● Insert batteries. ● Replace batteries.
Also refer to the respective instruction manuals of the video disc player, video cassette recorder, TV monitor, etc., being used.		

Specifications

AMPLIFIER SECTION

Power Output:

Stereo mode

Front L/R channels

80 watts per channel min. RMS. at 8 ohms, both channels driven, from 20 Hz to 20,000 Hz, with no more than 0.08% total harmonic distortion.

Continuous power output:

2 × 100 watts at 8 ohms (DIN)

Surround mode and Multi source mode

Front L/R and center channels

65 W + 65 W + 65 W (1 kHz 0.08 % 8 ohms)

Rear channels (Rear only driven)

25 W + 25 W (1 kHz 0.8 % 8 ohms)

Remote channels

65 W + 65 W (1 kHz 0.08 % 8 ohms)

IM Distortion:

0.08% at rated power (FRONT)

Damping Factor:

60 at 8 ohms (FRONT)

Input sensitivities and impedance:

Phono: 2.5 mV/50 kohms

CD/Tape play/Video in: 150 mV/50 kohms

Output level and impedance:

Tape rec/Video out: 150 mV/2.2 kohms

Pre out (SUBWOOFER): 1 V/2.2 kohms

120 mV RMS. at 1,000 Hz, 0.5% THD.

20 to 30,000 Hz, +/-1 dB

20 to 20,000 Hz, +/-0.8 dB

Phono Overload:

Frequency Response:

RIAA Deviation:

Tone Control:

BASS: +/-10 dB at 100 Hz

TREBLE: +/-10 dB at 10,000 Hz

Signal to Noise Ratio:

PHONO: 80 dB (IHF A, 5 mV input)

CD/TAPE: 100 dB (IHF A)

Muting:

- ∞ dB

VIDEO SECTION

Signal sensitivity and impedance:

VDP/VCR input, output: 1 Vp-p, 75 ohms

TUNER SECTION

FM:

Tuning Range:

87.5 --- 108.0 MHz (50 kHz steps)

Usable Sensitivity:

Mono: 11.2 dBf, 1.0 μV (75 ohms)
0.9 μV (26 dB S/N, 40 kHz Div.)
75 ohm DIN

Stereo: 17.2 dBf, 2.0 μV (75 ohms)
23 μV (46 dB S/N, 40 kHz Div.)
75 ohm DIN

50dB Quietening Sensitivity:

Mono: 17.2 dBf, 2.0 μV (75 ohms)
Stereo: 37.2 dBf, 20 μV (75 ohms)

Capture Ratio:

1.5 dB

Image Rejection Ratio:

USA & Canadian models: 40 dB

Other area models: 85 dB

IF Rejection Ratio:

90 dB

Signal-to-Noise Ratio:

Mono: 73 dB

Stereo: 67 dB

Alternate Channel Attenuation: 55 dB, 50 dB (DIN)

AM Suppression Ratio: 50 dB

Total Harmonic Distortion: Mono: 0.15%

Stereo: 0.25%

Frequency Response:

30 -- 15,000 Hz +/-1.5 dB

Stereo Separation:

45 dB at 1 kHz/30 dB

at 100 -- 10,000 Hz

Muting Level:

17.2 dBf, 2.0 μV (75 ohms)

AM:

Tuning Range:

European models

522 -- 1611 kHz (9 kHz steps)

USA & Canadian models

530 -- 1710 kHz (10 kHz steps)

Worldwide models

531 -- 1602 kHz (9 kHz steps)

530 -- 1710 kHz (10 kHz steps)

Usable Sensitivity:

30 μV

Image Rejection Ratio:

40 dB

IF Rejection Ratio:

40 dB

Signal-to-Noise Ratio:

40 dB

Total Harmonic Distortion:

0.7%

GENERAL

Power Supply:

USA & Canadian models

AC120 V, 60 Hz

European models

AC230 V, 50 Hz

Worldwide models

120 and 220-230 V switchable, 50/60 Hz

Dimensions (W × H × D):

455 × 170 × 389 mm

17-15/16" × 6-11/16" × 15-5/16"

Mass:

11.8 kg (26.0 lbs)

Specifications and features are subject to change without notice.

This device employs a microcomputer to perform various functions and operations. If interference generated by an external power supply, radio waves, or other electrical source results in an accident which causes the specified operations and functions to operate abnormally. To perform a reset, please follow the procedure below.

1. Press and hold down the VIDEO-1 button, then press the POWER button.
2. After "clear" is displayed, the preset memory and each mode stored in the memory, such as surround, are initialized and will return to the factory settings.

ONKYO CORPORATION

ONKYO CORPORATION

Sales & Product Planning Div.: 2-1, Nisshin-cho, Neyagawa-shi, OSAKA 572, JAPAN

Tel: 0720-31-8111 Fax: 0720-33-5222

ONKYO U.S.A. CORPORATION

200 Williams Drive, Ramsey, N.J. 07446, U.S.A.

Tel: 201-825-7950 Fax: 201-825-8150

ONKYO EUROPE ELECTRONICS GmbH

Industriestrasse 18-20, 82110 Germering, GERMANY

Tel: 089 84 93 20 Fax: 089 84 93 226

ONKYO FRANCE

Immeuble Le Diamant, Domaine Technologique de Saclay, 4 Rue René Razel,

91892 SACLAY, FRANCE Tel: (1) 69 33 14 00 Fax: (1) 69 41 35 84

Free Manuals Download Website

<http://myh66.com>

<http://usermanuals.us>

<http://www.somanuals.com>

<http://www.4manuals.cc>

<http://www.manual-lib.com>

<http://www.404manual.com>

<http://www.luxmanual.com>

<http://aubethermostatmanual.com>

Golf course search by state

<http://golfingnear.com>

Email search by domain

<http://emailbydomain.com>

Auto manuals search

<http://auto.somanuals.com>

TV manuals search

<http://tv.somanuals.com>