

ONKYO®

Contents

DVD Changer

DV-C501

Instruction Manual

Before Using Your DVD Changer 2

Getting Started 6

Connections 10

Basic Playback 14

Advanced Playback 21

Function Setup 32

Others 40

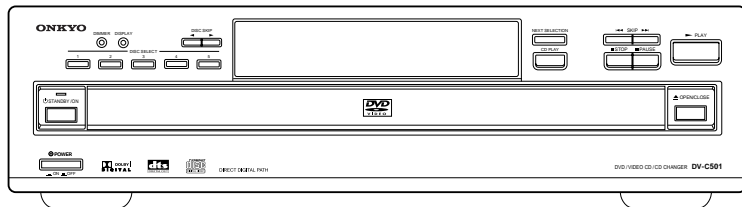

Thank you for purchasing the Onkyo DVD Changer. Please read this manual thoroughly before making connections and turning on the power. Following the instructions in this manual will enable you to obtain optimum performance and listening enjoyment from your new DVD Changer. Please retain this manual for future reference.



WARNING:

TO REDUCE THE RISK OF FIRE OR ELECTRIC SHOCK, DO NOT EXPOSE THIS APPLIANCE TO RAIN OR MOISTURE.

CAUTION:

TO REDUCE THE RISK OF ELECTRIC SHOCK, DO NOT REMOVE COVER (OR BACK). NO USER-SERVICEABLE PARTS INSIDE. REFER SERVICING TO QUALIFIED SERVICE PERSONNEL.



WARNING
RISK OF ELECTRIC SHOCK
DO NOT OPEN

AVIS
RISQUE DE CHOC ELECTRIQUE
NE PAS OUVRIR



The lightning flash with arrowhead symbol, within an equilateral triangle, is intended to alert the user to the presence of uninsulated "dangerous voltage" within the product's enclosure that may be of sufficient magnitude to constitute a risk of electric shock to persons.



The exclamation point within an equilateral triangle is intended to alert the user to the presence of important operating and maintenance (servicing) instructions in the literature accompanying the appliance.

Important Safeguards

1. **Read Instructions** – All the safety and operating instructions should be read before the appliance is operated.
2. **Retain Instructions** – The safety and operating instructions should be retained for future reference.
3. **Heed Warnings** – All warnings on the appliance and in the operating instructions should be adhered to.
4. **Follow Instructions** – All operating and use instructions should be followed.
5. **Cleaning** – Unplug the appliance from the wall outlet before cleaning. The appliance should be cleaned only as recommended by the manufacturer.
6. **Attachments** – Do not use attachments not recommended by the appliance manufacturer as they may cause hazards.
7. **Water and Moisture** – Do not use the appliance near water –for example, near a bath tub, wash bowl, kitchen sink, or laundry tub; in a wet basement; or near a swimming pool; and the like.
8. **Accessories** – Do not place the appliance on an unstable cart, stand, tripod, bracket, or table. The appliance may fall, causing serious injury to a child or adult, and serious damage to the appliance. Use only with a cart, stand, tripod, bracket, or table recommended by the manufacturer, or sold with the appliance. Any mounting of the appliance should follow the manufacturer's instructions, and should use a mounting accessory recommended by the manufacturer.
9. An appliance and cart combination should be moved with care. Quick stops, excessive force, and uneven surfaces may cause the appliance and cart combination to overturn.
10. **Ventilation** – Slots and openings in the cabinet are provided for ventilation and to ensure reliable operation of the appliance and to protect it from overheating, and these openings must not be blocked or covered. The openings should never be blocked by placing the appliance on a bed, sofa, rug, or other similar surface. The appliance should not be placed in a built-in installation such as a bookcase or rack unless proper ventilation is provided. There should be free space of at least 5 cm (2 in.) and an opening behind the appliance.
11. **Power Sources** – The appliance should be operated only from the type of power source indicated on the marking label. If you are not sure of the type of power supply to your home, consult your appliance dealer or local power company.
12. **Grounding or Polarization** – The appliance may be equipped with a polarized alternating current line plug (a plug having one blade wider than the other). This plug will fit into the power outlet only one way. This is a safety feature. If you are unable to insert the plug fully into the outlet, try reversing the plug. If the plug should still fail to fit, contact your electrician to replace your obsolete outlet. Do not defeat the safety purpose of the polarized plug.
13. **Power-Cord Protection** – Power-supply cords should be routed so that they are not likely to be walked on or pinched by items placed upon or against them, paying particular attention to cords at plugs, convenience receptacles, and the point where they exit from the appliance.
14. **Lightning** – For added protection for the appliance during a lightning storm, or when it is left unattended and unused for long periods of time, unplug it from the wall outlet and disconnect the antenna or cable system. This will prevent damage to the appliance due to lightning and power-line surges.
15. **Overloading** – Do not overload wall outlets, extension cords, or integral convenience receptacles as this can result in a risk of fire or electric shock.
16. **Object and Liquid Entry** – Never push objects of any kind into the appliance through openings as they may touch dangerous voltage points or short-out parts that could result in a fire or electric shock. Never spill liquid of any kind on the appliance.
17. **Servicing** – Do not attempt to service the appliance yourself as opening or removing covers may expose you to dangerous voltage or other hazards. Refer all servicing to qualified service personnel.
18. **Damage Requiring Service** – Unplug the appliance from the wall outlet and refer servicing to qualified service personnel under the following conditions:
 - A. When the power-supply cord or plug is damaged,
 - B. If liquid has been spilled, or objects have fallen into the appliance,
 - C. If the appliance has been exposed to rain or water,
 - D. If the appliance does not operate normally by following the operating instructions. Adjust only those controls that are covered by the operating instructions as an improper adjustment of other controls may result in damage and will often require extensive work by a qualified technician to restore the appliance to its normal operation,
 - E. If the appliance has been dropped or damaged in any way, and
 - F. When the appliance exhibits a distinct change in performance – this indicates a need for service.
19. **Replacement Parts** – When replacement parts are required, be sure the service technician has used replacement parts specified by the manufacturer or have the same characteristics as the original part. Unauthorized substitutions may result in fire, electric shock, or other hazards.
20. **Safety Check** – Upon completion of any service or repairs to the appliance, ask the service technician to perform safety checks to determine that the appliance is in proper operation condition.
21. **Wall or Ceiling Mounting** – The appliance should be mounted to a wall or ceiling only as recommended by the manufacturer.
22. **Heat** – The appliance should be situated away from heat sources such as radiators, heat registers, stoves, or other appliances (including amplifiers) that produce heat.

PORTABLE CART WARNING



S3125A

Precautions

CAUTION:

VISIBLE LASER RADIATION WHEN OPEN AND INTERLOCK FAILED OR DEFEATED. DO NOT STARE INTO BEAM.

CAUTION:

THIS PRODUCT UTILIZES A LASER. USE OF CONTROLS OR ADJUSTMENTS OR PERFORMANCE OF PROCEDURES OTHER THAN THOSE SPECIFIED HEREIN MAY RESULT IN HAZARDOUS RADIATION EXPOSURE.

For European model

This unit contains a semiconductor laser system and is classified as a "CLASS 1 LASER PRODUCT." So, to use this model properly, read this Instruction Manual carefully. In case of any trouble, please contact the store where you purchased the unit. To prevent being exposed to the laser beam, do not try to open the enclosure.



This label on the rear panel states that:

1. This unit is a CLASS 1 LASER PRODUCT and employs a laser inside the cabinet.
2. To prevent the laser from being exposed, do not remove the cover. Refer servicing to qualified personnel.

For U.S. model

The laser is covered by a housing which prevents exposure during operation or maintenance. However, this product is classified as a Laser Product by CDRH (Center for Devices and Radiological Health) which is a department of the Food and Drug Administration. According to their regulations 21 CFR section 1002.30, all manufactures who sell Laser Products must maintain records of written communications between the manufacturer, dealers and customers concerning radiation safety. If you have any complaints about instructions or explanations affecting the use of this product, please feel free to write to the address on the back page of this manual. When you write us, please include the model number and serial number of your unit.

In compliance with Federal Regulations, the certification, identification and the period of manufacture are indicated on the rear panel.

FCC INFORMATION FOR USER

CAUTION:

The user changes or modifications not expressly approved by the party responsible for compliance could void the user's authority to operate the equipment.

NOTE:

This equipment has been tested and found to comply with the limits for a Class B digital device, pursuant to Part 15 of the FCC Rules. These limits are designed to provide reasonable protection against harmful interference in a residential installation. This equipment generates, uses and can radiate radio frequency energy and, if not installed and used in accordance with the instructions, may cause harmful interference to radio communications. However, there is no guarantee that interference will not occur in a particular installation. If this equipment does cause harmful interference to radio or television reception, which can be determined by turning the equipment off and on, the user is encouraged to try to correct the interference by one or more of the following measures:

- Reorient or relocate the receiving antenna.
- Increase the separation between the equipment and receiver.
- Connect the equipment into an outlet on a circuit different from that to which the receiver is connected.
- Consult the dealer or an experienced radio/TV technician for help.

For Canadian model

For models having a power cord with a polarized plug:

CAUTION: TO PREVENT ELECTRIC SHOCK, MATCH WIDE BLADE OF PLUG TO WIDE SLOT, FULLY INSERT.

This Class B digital apparatus complies with Canadian ICES-003.

Modele pour les Canadien

Sur les modeles dont la fiche est polarisee:

ATTENTION: POUR EVITER LES CHOCS ELECTRIQUES, INTRODUIRE LA LAME LA PLUS LARGE DE LA FICHE DANS LA BORNE CORRESPONDANTE DE LA PRISE ET POUSSER JUSQU'AU FOND.

Cet appareil numérique de la classe B est conforme à la norme NMB-003 du Canada.

For British model

Replacement and mounting of an AC plug on the power supply cord of this unit should be performed only by qualified service personnel.

IMPORTANT

The wires in the mains lead are coloured in accordance with the following code:

Blue : Neutral

Brown : Live

As the colours of the wires in the mains lead of this apparatus may not correspond with the coloured markings identifying the terminals in your plug, proceed as follows:

The wire which is coloured blue must be connected to the terminal which is marked with the letter N or coloured black.

The wire which is coloured brown must be connected to the terminal which is marked with the letter L or coloured red.

IMPORTANT

A 5 amp fuse is fitted in this plug. Should the fuse need to be replaced, please ensure that the replacement fuse has a rating of 5 amps and that it is approved by ASTA or BSI to BS1362. Check for the ASTA mark or the BSI mark on the body of the fuse.

IF THE FITTED MOULDED PLUG IS UNSUITABLE FOR THE SOCKET OUTLET IN YOUR HOME THEN THE FUSE SHOULD BE REMOVED AND THE PLUG CUT OFF AND DISPOSED OF SAFELY. THERE IS A DANGER OF SEVERE ELECTRICAL SHOCK IF THE CUT OFF PLUG IS INSERTED INTO ANY 13 AMP SOCKET.

If in any doubt, please consult a qualified electrician.

Precautions

1. Regional restriction codes (region number)

Regional restriction codes are built-in to DVD changers and DVD discs for each sales region. If the regional code of the DVD changer does not match one of the regional codes of the DVD disc, playback is not possible.

The region number can be found on the rear panel of the DVD player. (ex:  Region 1)

2. About This Manual

This manual explains the basic procedures for operating your DVD Changer. Some DVD video discs do not support the full potential of the DVD technology. Your DVD Changer may therefore not respond to all operating commands. Refer to instruction notes on discs.

A "⊘" mark may appear on the TV screen during operation. It means that the operation is not permitted by the DVD Changer or the disc.

3. Warranty Claim

You can find the serial number on the rear panel of this unit. In case of warranty claim, please report this number.

4. Recording Copyright

Recording of copyrighted material for other than personal use is illegal without permission of the copyright holder.

5. Power

WARNING

BEFORE PLUGGING IN THE UNIT FOR THE FIRST TIME, READ THE FOLLOWING SECTION CAREFULLY.

The voltage of the available power supply differs according to country or region. Be sure that the power supply voltage of the area where this unit will be used meets the required voltage (e.g., AC 230 V, 50 Hz or AC 120 V, 60 Hz) written on the rear panel.

6. Do not touch this unit with wet hands

Do not handle this unit or power cord when your hands are wet or damp. If water or any other liquid enters the case, take this unit to an authorized service center for inspection.

7. Location of this unit

- Place this unit in a well-ventilated location.
Take special care to provide plenty of ventilation on all sides of this unit especially when it is placed in an audio rack. If ventilation is blocked, this unit may overheat and malfunction.
- Do not expose this unit to direct sunlight or heating units as this unit's internal temperature may rise and shorten the life of the pickup.
- Avoid damp and dusty places and places directly affected by vibrations from the speakers. In particular, avoid placing the unit on or above one of the speakers.
- Be sure this unit is placed in a horizontal position. Never place it on its side or on a slanted surface as it may malfunction.
- When you place this DVD Changer near a TV, radio, or VCR, the playback picture may become poor and the sound may be distorted. In this case, place the DVD Changer away from the TV, radio, or VCR.

8. Care

From time to time you should wipe the front and rear panels and the cabinet with a soft cloth. For heavier dirt, dampen a soft cloth in a weak solution of mild detergent and water, wring it out dry, and wipe off the dirt. Following this, dry immediately with a clean cloth. Do not use rough material, thinners, alcohol or other chemical solvents or cloths since these could damage the finish or remove the panel lettering.

9. Notes on Handling

- When shipping the DVD Changer, use the original shipping carton and packing materials. For maximum protection, repack the unit as it was originally packed at the factory.
- Do not use volatile liquids, such as insect spray, near the DVD Changer. Do not leave rubber or plastic products in contact with the DVD Changer for a long time. They will leave marks on the finish.
- The top and rear panels of the DVD Changer **may become warm after a long period of use. This is not a malfunction.**
- When the DVD Changer is not in use, be sure to remove the disc and turn off the power.
- If you do not use the DVD Changer for a long period, the unit may not function properly in the future. Turn on and use the DVD Changer occasionally.

10. To Obtain a Clear Picture

The DVD Changer is a high technology, precision device. If the optical pick-up lens and disc drive parts are dirty or worn down, the picture quality becomes poor. To obtain a clear picture, we recommend regular inspection and maintenance (cleaning or parts replacement) every 1,000 hours of use depending on the operating environment. For details, contact your nearest dealer.

11. Notes on Moisture Condensation

Moisture condensation damages the DVD Changer. Please read the following carefully.

Moisture condensation occurs, for example, when you pour a cold drink into a glass on a warm day. Drops of water form on the outside of the glass. In the same way, moisture may condense on the optical pick-up lens inside this unit, one of the most crucial internal parts of the DVD Changer.

- Moisture condensation occurs in the following cases.
 - When you bring the DVD Changer directly from a cold place to a warm place.
 - When you use the DVD Changer in a room where you just turned on the heater, or a place where the cold wind from the air conditioner directly hits the unit.
 - In summer, when you use the DVD Changer in a hot and humid place just after you move the unit from an air conditioned room.
 - When you use the DVD Changer in a humid place.
- Do not use the DVD Changer when moisture condensation may occur.
If you use the DVD Changer in such a situation, it may damage discs and internal parts. Remove the disc, connect the power cord of the DVD Changer to the wall outlet, turn on the DVD Changer, and leave it for two or three hours. After a few hours, the DVD Changer will have warmed up and evaporated any moisture. Keep the DVD Changer connected to the wall outlet and moisture condensation will seldom occur.

Table of Contents

Important Safeguards/Precautions/Table of Contents	2-5
--	-----

Getting Started

Features	6	Handling Discs	9
Supplied Accessories	7	Cleaning Discs	9
Preparing the Remote Controller	8	Storing Discs	9
Installing the remote controller batteries	8	About VIDEO CDs	9
Using the remote controller	8	Notes on Copyright	9
Notes on the Discs You Can Use with this Unit	9		
Discs You can Use	9		

Connections

Connecting the DV-C501 to a TV	10	Connecting to an Amplifier Equipped with Dolby Pro Logic Surround	12
Connecting the DV-C501 to a TV	10	Connecting to an Amplifier Equipped with a DTS Decoder	13
Connecting to an Audio System and TV with COMPONENT VIDEO Inputs	11	Connecting to an Amplifier Equipped with a Digital Audio Input	13
Other Audio Playback Options	12		
Connecting to an Amplifier Equipped with a Dolby Digital Decoder	12		

Basic Playback

Playing back Discs	14	Locating Titles, Chapters, or Tracks	18
Basic Playback	14	Locating a Title Using the Title Menu	18
Direct Playback, Stop and Pause	16	Title Selection with the Numeric Buttons	18
Fast Reverse and Fast Forward Playback	16	Selecting Chapters or Tracks	19
Slow-Motion Playback	17	Selecting a Precise Scene or Audio Passage	20
Resuming Playback From the Desired Location	17	Entering the Time Location	20

Advanced Playback

Repeat Functions	21	Zooming in	27
Repeating a Title or Chapter/Track	21	Changing the Camera Angle	27
Repeating a Given Scene or Passage	21	Audio Playback Settings	28
Setting the Desired Playback Order	22	Using the Subtitle Feature	30
Programming Memory Sequences	22	Using The On-Screen Display Functions	31
Additional Playback Functions	24	Requesting Basic Information	31
Next Selection: Preparing the next Audio Track	24	More Specific Information: Remaining Time and Setting Status	31
Using the DVD Changer as CD player	25		
Random Playback	26		
DVD Video Disc Functions	27		

Function Setup

Advanced Settings	32	DISPLAY Settings	37
Setting Procedure	32	OPERATION Settings	37
LANGUAGE Functions	34	Table of Languages	39
PICTURE Settings	35	Table of Languages and Their Abbreviations	39
AUDIO Settings	36		

Others

Troubleshooting	40	DVD Display	42
Symptoms and Corrections	40	Remote Controller	43
Identification of Controls	41	Specifications	44
Front Panel	41	DVD Changer/Outputs	44
Rear Panel	41		

Features

■ Highlights that Set the DV-C501

- Dolby* Digital Audio Output
- 5-Disc playback
- DTS** Compatibility
- Video CD playback
- Full 96-kHz/24-bit resolution with 96-kHz/24-bit discs
- Direct digital path for signal purity (U.S. & Canadian models only)
- Enhanced black-level setting
- Next Selection

■ Video Features

- DTS Compatibility means the DV-C501 can pass a DTS-encoded digital signal from discs with DTS soundtracks to an external processor or receiver with a DTS decoder
- Advanced 10-Bit 27 MHz Video D/A Conversion for four times the accuracy of conventional 8-bit, 13.5 MHz systems
- 3-Mode Picture Magnification enables you to “zoom” in and enlarge in three steps 25 selected areas of the picture
- Enhanced Black-Level Control lets you set the reference black threshold cutoff-especially useful for picture calibration on TVs
- Passes PLUGE Signals to make it easier for you to set the brightness of your monitor when using DVD test discs
- Video CD Playback for enjoying the wide selection of inexpensive Video-CD software, which has the same high audio quality as MiniDiscs, and picture quality comparable to VHS video cassettes
- High Resolution Onscreen Display
- S-Video Output
- Full-Time Active Video Outputs to make using the DVD changer with both the main home-theater television and the display in the bedroom much easier
- 4-Mode Search (title, DVD chapter, CD track, and time)
- Still Frame to view single frames
- Frame Advance
- Slow Motion for DVD playback without sound at 1/2, 1/4, or 1/8th the normal speed
- Fast Forward/Reverse (x2, x8, x30)
- Last Memory Play function for both DVDs and CDs-resumes play from where last stopped, even if the power was turned off
- 6-Mode Repeat allows you to repeat titles, chapters, tracks, all tracks, memory, and a user-selected A-B section on DVDs and CDs
- Programmed Memory Playback
- Random Playback
- Multi-Aspect Ratio
- 8-Language Soundtrack Capability
- 32 Subtitle Languages
- Multi-Camera Angle
- Parental Viewing Control
- Screen Saver

■ Audio Features

- Audiophile-Class Audio Performance
- Direct Digital Path (U.S. & Canadian models only)
- Full 96-kHz/24-Bit Audio Resolution
- Digital Audio Output (coaxial)
- Optical Digital Audio Output
- 1 Pair of Analog Outputs (RCA)

■ Other Features You'll Enjoy

- 4-Disc Exchange
- CD Mode (DVD Skip) Control
- Next Selection
- Direct Disc Access
- Separate indicators for Each Disc (1 to 5)
- Dual-Focus Optical Pickup
- Dynamic Range Control
- Large, Bright, Universal Fluorescent Display
- 2-Mode Display Dimmer (normal, dim)
- Anti-Resonant, Heavy-Gauge, Reinforced-Steel Chassis
- Large Anti-Resonant Feet
- Inlet type AC Cord
- Brushed Aluminum Front Panel
- 53-Key Full-Function Remote Control

* Manufactured under license from Dolby Laboratories. “Dolby” and the double-D symbol **DD** are trademarks of Dolby Laboratories. Confidential Unpublished Works. ©1992-1997 Dolby Laboratories, Inc. All rights reserved.

** “DTS” and “DTS Digital Surround” are trademarks of Digital Theater Systems, Inc.

Supplied Accessories

After unpacking, check whether the box contains all items listed below.
If anything is missing, contact the ONKYO dealer where you bought the DVD Changer.
The number of accessories is indicated in brackets.

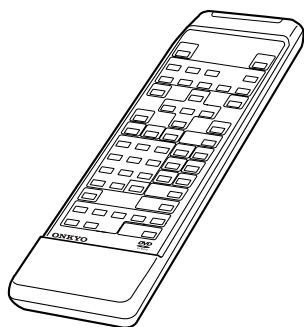

Remote controller (RC-417DV) [1]

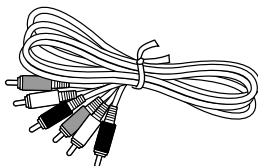

Audio/video connection cable [1]

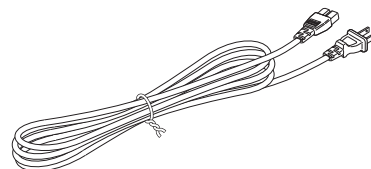

Power cable [1]
(U.S. & Canadian model's cable shown)

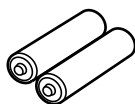

Batteries for the remote controller
(size AA/UM-3) [2]

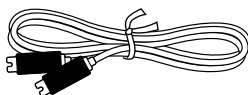

S video cable [1]

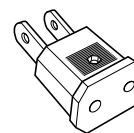

Conversion plug [1]

Use this plug if the power cable plug of the DV-C501 does not fit your AC outlet. (Shape may vary according to the area where purchased.)
Not available on the U.S. and Canadian models.

Declaration of Conformity

We, ONKYO EUROPE
ELECTRONICS GmbH
INDUSTRIESTRASSE 20
82110 GERMERING,
GERMANY



declare in own responsibility, that the ONKYO product described in this instruction manual is in compliance with the corresponding technical standards such as EN60065, EN55013, EN55020 and EN61000-3-2, -3-3 (or EN60555-2, -3)

GERMERING, GERMANY

K.OTSU

ONKYO EUROPE ELECTRONICS GmbH

Preparing the Remote Controller

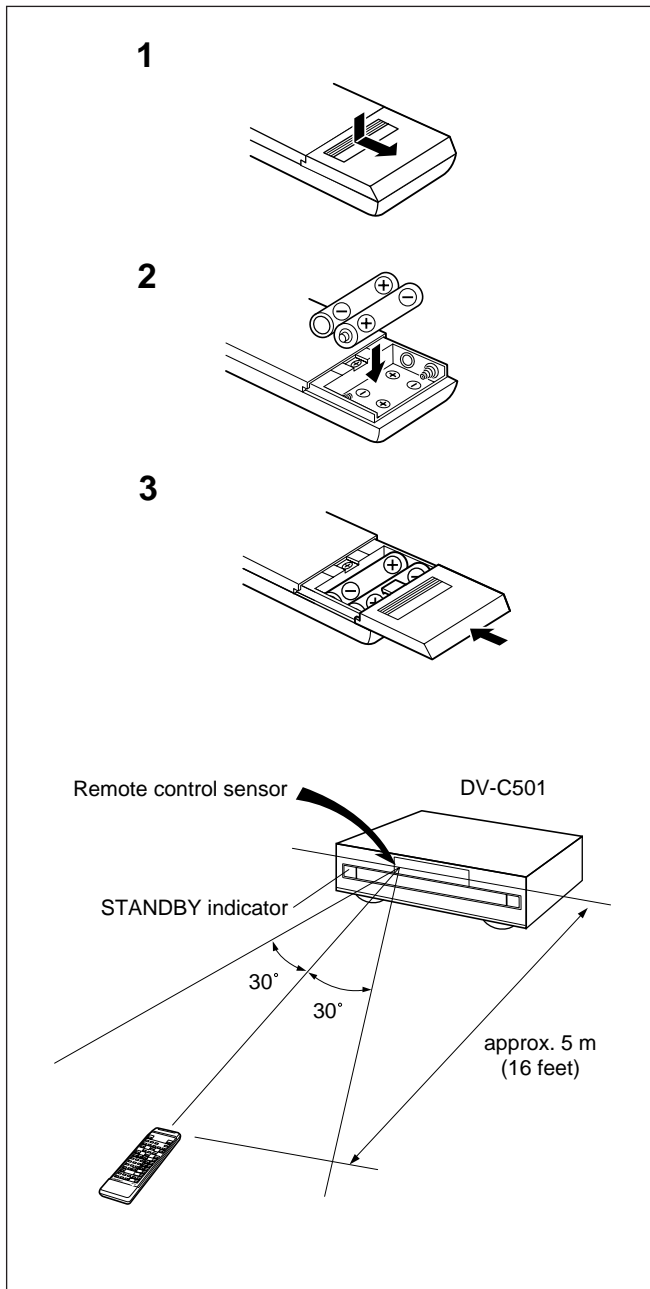

Installing the remote controller batteries

1. Remove the battery compartment cover by pressing and sliding it away from the remote controller unit.
2. Insert two AA (R6- or UM-3)-size batteries into the battery compartment. Carefully follow the polarity diagram (positive (+) and negative (-) symbols) inside the battery compartment.
3. After batteries are installed and seated correctly, replace the compartment cover.

Notes:

- Do not mix new batteries with old batteries or different kinds of batteries.
- To avoid corrosion, remove the batteries if the remote controller is not to be used for a long time.
- Remove dead batteries immediately to avoid damage from corrosion. If the remote controller doesn't operate smoothly, replace both the batteries at the same time.
- The life of the batteries supplied is about six months but this will vary depending on usage.

Using the remote controller

Point the remote controller toward the remote control sensor.

Notes:

- Place the unit away from strong light such as direct sunlight or inverted fluorescent light which can prevent proper operation of the remote controller.
- Using another remote controller of the same type in the same room or using the unit near equipment which uses infrared rays may cause operational interference.
- Do not put any object such as a book on the remote controller. The buttons of the remote controller may be pressed by mistake and drain the batteries.
- Make sure the audio rack doors do not have colored glass. Placing the unit behind such doors may prevent proper remote controller operation.
- If there is any obstacle between the remote controller and the remote control sensor, the remote controller will not operate.

Notes on the Discs You Can Use with this Unit

In this section, you will learn which discs can be used with your DV-C501, and how to handle, clean, and store them.

Discs You can Use

Your DVD Changer can play back the following discs:

	Disc mark	Contents	Disc size	Maximum playback time
DVD videos		Audio + Video (moving pictures)	12 cm	Approx. 4 hours (single sided disc)
				Approx. 8 hours (double-sided disc)
			8 cm	Approx. 80 minutes (single-sided disc)
				Approx. 160 minutes (double-sided disc)
VIDEO CDs		Audio + Video (moving pictures)	12 cm	Approx. 74 minutes
			8 cm	Approx. 20 minutes
Audio CDs		Audio	12 cm	Approx. 74 minutes
			8 cm (CD single)	Approx. 20 minutes

- You cannot play back discs other than those listed above.
- You cannot play back discs such as CD-R, CD-RW, CD-ROM, DVD-RAM, DVD-RW, etc., even though they may be labelled with one of the above logos.

U.S. & Canadian models:

This DVD Changer uses the NTSC color system, and cannot play back DVD videos recorded in any other color system (PAL, SECAM, etc.).

Other area models:

This DVD Changer uses the PAL/NTSC color system, and cannot play back DVD videos recorded in any other color system (SECAM, etc.).

- Avoid using heart-shaped or octagonal discs. Playing irregularly shaped discs may damage the DVD Changer's internal mechanism.

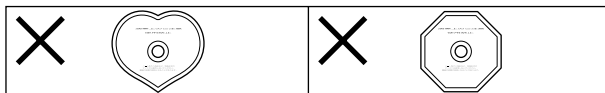

- Do not use discs that contain adhesive tape or a disc label (on rental discs). Otherwise, you may not be able to eject the discs, or the DVD Changer may become inoperative.

Handling Discs

- Never touch the playback side (the "blank" side) of the disc.

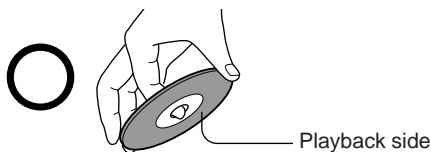

- Never attach paper or tape to discs.



Cleaning Discs

- Fingerprints and dust on the disc cause a deterioration of the picture and sound quality. Wipe the disc from the center outwards with a soft cloth. Always keep the discs clean.

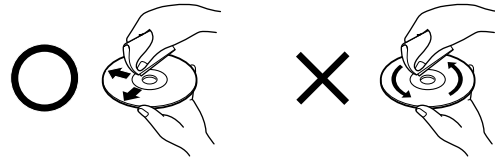

- Stubborn dust or dirt can be removed by wiping the disc lightly with a slightly moistened soft cloth and finishing with a dry cloth.
- Never use solvents such as thinner, benzine, commercially available cleaners, or antistatic spray for vinyl LPs. They may damage the disc.

Storing Discs

- Do not store discs in places subject to direct sunlight or near heat sources.
- Do not store discs in places subject to moisture and dust, such as in a bathroom or near a humidifier.
- Store discs vertically in their case. Stacking or placing objects on unprotected discs may cause warping and scratches.

About VIDEO CDs

Your DVD Changer can play back version 1.1 and 2.0 Video CDs. Version 2.0 discs support PBC functionality. (PBC is the abbreviation of Playback Control.)

- VIDEO CDs not equipped with PBC functionality (Version 1.1)**
Sound and pictures are played back in the same way as an audio CD.
- VIDEO CDs equipped with PBC functionality (Version 2.0)**
In addition to the functions available for version 1.1 Video CDs, you can use interactive software and search functions. These are accessible via a menu displayed on the TV screen (Menu Playback). However, not all functions described in this Instruction Manual are supported by all Video CDs.

Notes on Copyright

It is forbidden by law to copy, broadcast, show, broadcast on cable, play in public, and rent copyrighted material without permission. DVD video discs are copy protected, and any copy made from these discs will be distorted.

This product incorporates copyright protection technology that is protected by method claims of certain U.S. patents and other intellectual property rights owned by Macrovision Corporation and other rights owners. Use of this copyright protection technology must be authorized by Macrovision Corporation, and is intended for home and other limited viewing uses, unless otherwise authorized by Macrovision Corporation. Reverse engineering or disassembly is prohibited.

Connecting the DV-C501 to a TV

Here is how to connect your DVD Changer to your TV set. In this case, both the video and audio signals will be played back by your TV set.

Connecting the DV-C501 to a TV

1. Switch off the DVD Changer and the TV set.
2. Connect the DV-C501 to your TV set as shown in the illustration.

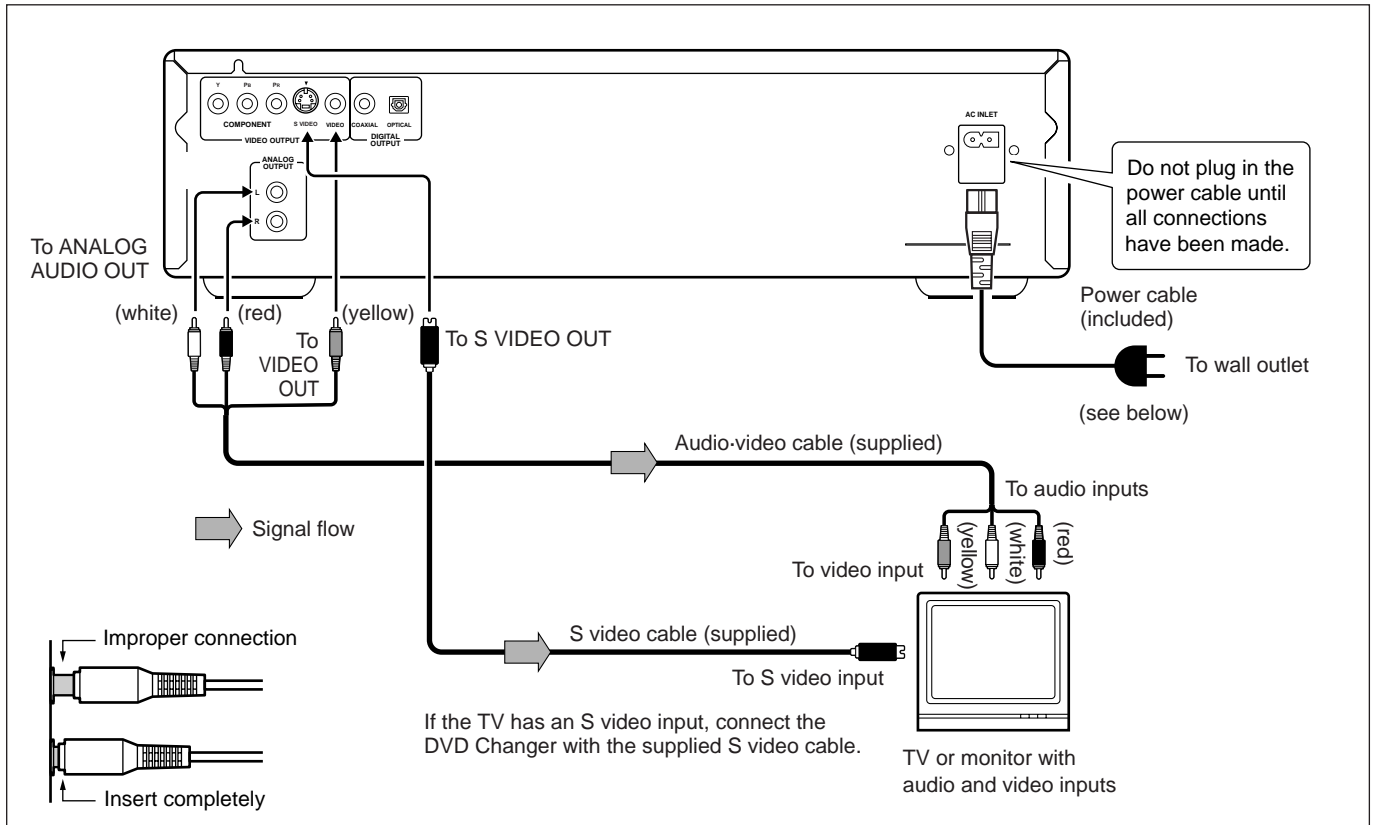

■ Selecting the audio outputs

Your DV-C501 provides several options for audio playback: you can use the analog or one of the digital audio outputs. If the audio is to be played back by your TV set, connect the ANALOG OUTPUTS to the audio inputs of your TV set and activate them ("Analog 2ch"). See "Audio Settings" on page 36 for details.

Notes:

- See also the instruction manual of the connected TV on how to select the signals transmitted by the DVD Changer.
- Before connecting the DVD Changer to your TV, be sure to turn off the power to and unplug both units from the wall outlet.
- If your TV set has one audio input (monaural), connect a Y cable adapter to the DV-C501's ANALOG OUTPUTS, and the other end of the adapter to the TV's audio input.
- Be sure to establish a direct video connection between the DV-C501 and your TV set. Do not route the video signal through your VCR or other video component. Otherwise the picture may be distorted due to the DVD disc's copy protection.

Connecting a power cable

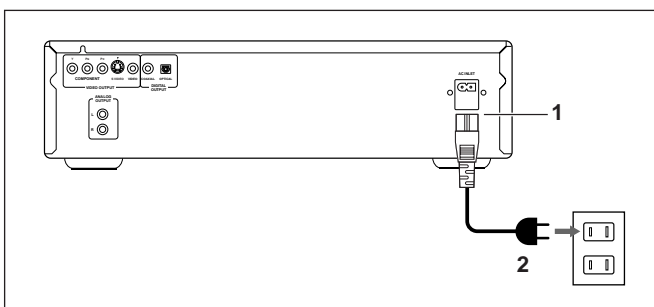

1. Connect the outlet plug on the included power cable to the AC INLET on the DV-C501.
2. Plug-in the other end of the cable to a wall AC outlet.

Notes:

- Do not use any power cable other than the included cable. The included cable is designed for use only with the DV-C501. Do not use it for any other device.
- Do not connect or disconnect the outlet plug from the DV-C501 while the other end is plugged into the wall AC outlet.

Connecting to an Audio System and TV with COMPONENT VIDEO Inputs

■ It is also possible to “split” the audio and video signals by sending the video signal to your TV set and the audio signal to an amplifier. Doing so has the advantage that you can:

- Listen to the sound of audio CDs and DVD video discs in stereo (via the amplifier) or in Dolby Digital, Dolby Pro Logic Surround or DTS (see pages 12, 13);
- Enjoy a better picture quality of DVD video discs on a TV equipped with Component Video inputs than would be possible via an S-video connection.

Notes

- See also the manuals of your audio amplifier and TV set for establishing the correct connections and making the required settings.
- Before connecting the DVD Changer to other equipment, be sure to turn off the power and unplug all components from the wall outlet.
- This DVD Changer outputs a very dynamic audio signal. Be sure to set the amplifier's volume to a moderate listening level to avoid damaging your speakers due to sudden volume surges.
- Switch off the amplifier or select another input source before connecting or disconnecting the DVD Changer's power cable. If you leave the amplifier power on, the speakers may be damaged.

Your DV-C501 provides several options for audio playback: you can use the analog or one of the digital audio outputs. If your amplifier only provides analog inputs, use the DV-C501's ANALOG OUTPUTs and select them via the on-screen menu (“Analog 2ch”). See “Audio Settings” on page 36 for details.

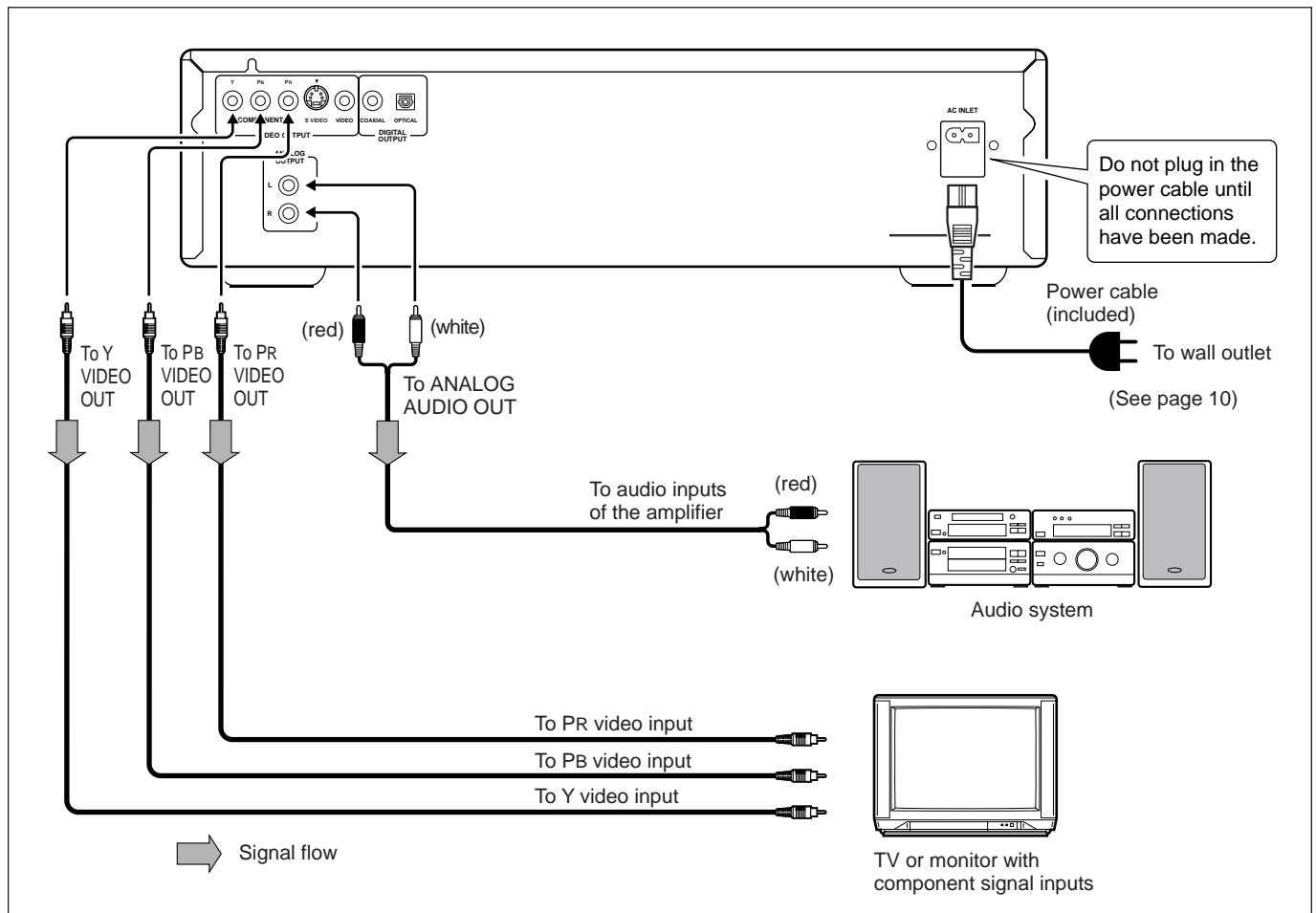

■ COMPONENT VIDEO OUT (COLOR DIFFERENCE):

Some TVs or monitors are equipped with Color Difference inputs. Connecting the DV-C501 to these inputs allows you to enjoy a better picture quality. Be sure to match the DV-C501's VIDEO OUTPUTs with the Component Video inputs of your TV or monitor (see the illustration).

Actual labels for the Color Difference inputs may vary depending on the TV manufacturer (e.g. Y, B-Y, R-Y, etc.).

On some TVs or monitors, the color levels of the picture may be reduced slightly, or the tint may change. In such cases, adjust the TV or monitor for optimum performance.

Note:

- If you place the DVD Changer near a tuner or radio, the radio reception might be distorted due to interference. In this case, locate the DV-C501 away from the tuner or radio.

Other Audio Playback Options

■ You can enjoy high-quality surround audio playback by connecting the DV-C501 to an amplifier equipped with a Dolby Digital, Dolby Pro Logic Surround, or DTS decoder. Furthermore you can transfer the signal of audio CDs to your amplifier in the digital domain if it is fitted with a digital input. See pages 10 and 11 for the video hookup of the DV-C501 to your TV set.

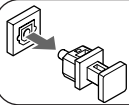

When using an optical digital cable, remove the cap from the DIGITAL OUTPUT OPTICAL connector and firmly fit the cable's jack into the connector. When not using this connector, keep it capped to protect it from dust intrusion.

Notes:

- Before connecting the DVD Changer to other equipment, be sure to turn off the power and unplug all components from the wall outlet.
- This DVD Changer outputs a very dynamic audio signal. Be sure to set the amplifier's volume to a moderate listening level to avoid damaging your speakers due to sudden volume surges.
- Switch off the amplifier or select another input source before connecting or disconnecting the DVD Changer's power cable. If you leave the amplifier power on, the speakers may be damaged.

Connecting to an Amplifier Equipped with a Dolby Digital Decoder

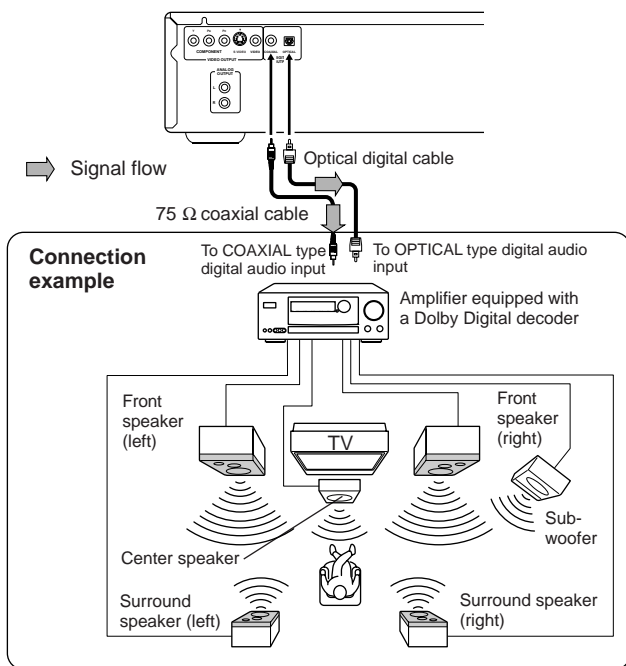

Playback of Dolby Digital-encoded discs requires that you establish a digital connection with the amplifier. The selection of the DV-C501's DIGITAL OUTPUT depends on the type of digital input provided on your amplifier. Use either the DIGITAL OUTPUT COAXIAL or OPTICAL connector. See the amplifier's manual for details.

Dolby Digital

Dolby Digital is a surround sound technology used in movie theaters that is now also available on equipment for a home environment. You can play back motion picture and live-concert DVD video discs of this sound format by connecting the DVD Changer to a 6-channel amplifier equipped with a Dolby Digital decoder or Dolby Digital processor. If your amplifier (or separate decoder) supports Dolby Pro Logic Surround, you can even play back Dolby Pro Logic-encoded DVD movies with full 5.1-channel Dolby Digital soundtracks, as well as titles with the Dolby Surround mark.

- This functionality is only available when using DVD video discs with Dolby Digital encoding.
- Make the following settings:

Setting	Select:	Page
Audio Out Select	Bitstream	36
Recording system	<input checked="" type="checkbox"/>	29

- Select the Dolby Digital or Dolby Pro Logic Surround mode on your amplifier.

Connecting to an Amplifier Equipped with Dolby Pro Logic Surround

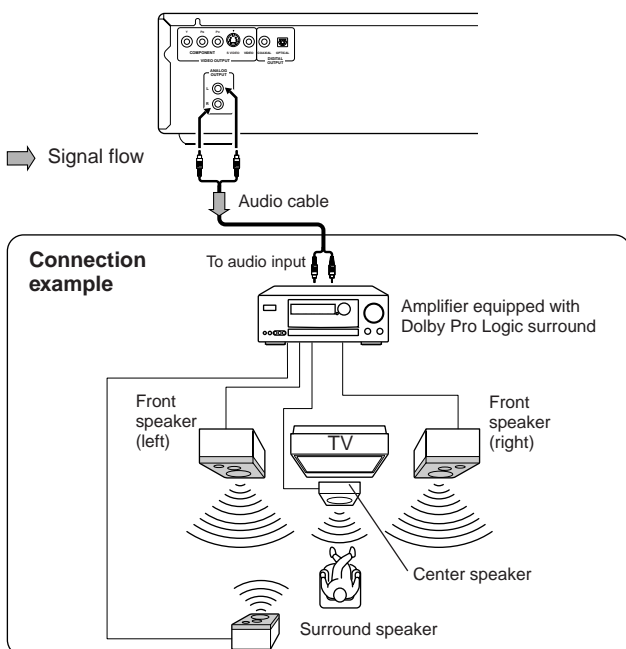

Your DV-C501 also supports Dolby Pro Logic Surround. This effect can be obtained in one of two ways: via a digital or an analog connection with an amplifier that supports Dolby Pro Logic Surround (see below).

Dolby Pro Logic Surround

Playback of Dolby Pro Logic Surround-encoded DVD video discs requires that you connect the DV-C501 to an amplifier with right and left front speakers, a center speaker, and one or two surround speakers. Feel free to use one or two surround speakers. Be aware, though, that the output sound of the rear channel will be monaural even if you connect two surround speakers.

• **If your amplifier is fitted with a digital input:**

See the connection for Dolby Digital playback above and make the suggested settings. See also the amplifier's manual for how to select its Dolby Pro Logic Surround mode.

• **If your amplifier has no digital input:**

Connect the DV-C501's ANALOG OUTPUTS as shown in the illustration to the left, and make the following setting:

Setting	Select:	Page
Audio Out Select	Analog 2ch	36

- Select the Dolby Pro Logic Surround mode on your amplifier.

Note:

- Do not forget to select the DVD Changer's AUDIO OUTPUTs ("Analog 2ch"). See "Audio Settings" on page 36 for details.

Warnings

- If you connect to the digital input of an amplifier that does not have a Dolby Digital decoder or DTS decoder, set the DV-C501's "Audio Out Select" function to "PCM." Any other setting may damage your ears or speakers when using high volume levels.
- During playback of DTS-encoded audio CDs, excessive noise may be output from the ANALOG OUTPUTS. To avoid possible damage to your audio system, we recommend you either break the connection between the DVD Changer's ANALOG OUTPUTS and the amplifier, or to only start playback of your DV-C501 after selecting the appropriate digital input source on your amplifier.
- DTS Digital Surround™ playback is only available if you connect an external 5.1-channel DTS Digital Surround™ decoder to a DIGITAL OUTPUT jack of the DVD Changer.

Connecting to an Amplifier Equipped with a DTS Decoder

Playback of DTS-encoded discs requires that you establish a digital connection with the amplifier. The selection of the DV-C501's DIGITAL OUTPUT depends on the type of digital input provided on your amplifier. Use either the DIGITAL OUTPUT COAXIAL or OPTICAL connector. See the amplifier's manual for details.

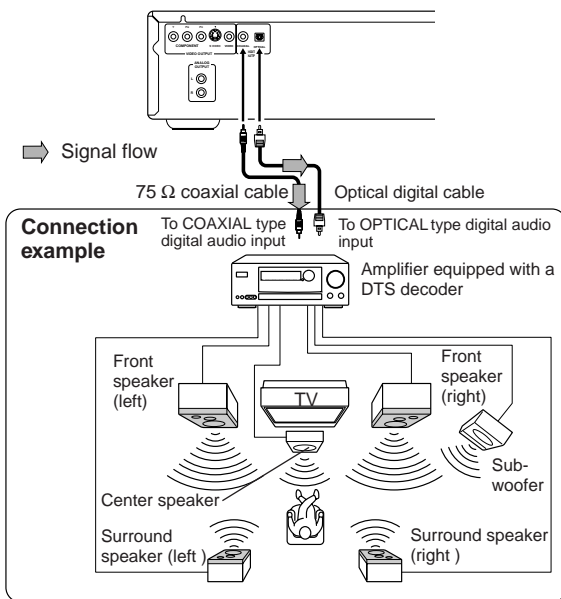

Digital Theater System (DTS)

DTS is a high-quality surround technology used in movie theaters that is also available for home use on DVD video discs or audio CDs. If you have a DTS decoder or processor, you can obtain the full benefit of 5.1-channel DTS encoded sound tracks.

- DTS functionality is only available when using DVD video discs or audio CDs with DTS encoding.
- Make the following settings:

Setting	Select:	Page
Audio Out Select	Bitstream	36
Recording system	DTS	29

- Select the DTS mode on your amplifier.

Digital Stereo Audio Playback

The DV-C501 also allows you to output a stereo audio signal in the digital domain. The selection of the DV-C501's DIGITAL OUTPUT depends on the type of digital input provided on your amplifier. Use either the DIGITAL OUTPUT COAXIAL or OPTICAL connector. See the amplifier's manual for details.

Connecting to an Amplifier Equipped with a Digital Audio Input

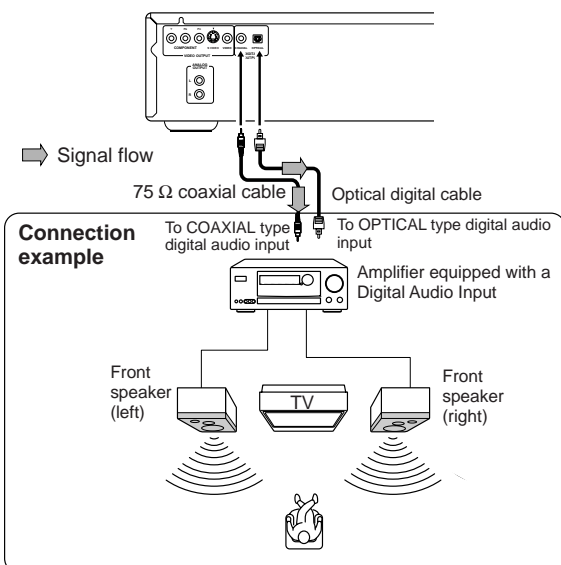

PCM

If your amplifier provides a digital audio input, you can establish a digital connection between the DV-C501 and the amplifier. Choose this type of connection if your amplifier is equipped with a better D/A converter than your DV-C501, or if you also own a dedicated D/A converter.

- Make the following setting:

Setting	Select:	Page
Audio Out Select	PCM	36

Notes:

- NEVER connect a DIGITAL OUTPUT jack of the DVD Changer to the AC-3 RF input of a Dolby Digital Receiver. AC-3 RF inputs use a different encoding format that is not supported by the DV-C501's DIGITAL OUTPUTS.
- The amplifier's coaxial digital input may be labelled "DIGITAL" rather than "COAXIAL". See its manual for details.

Playing back Discs

CAUTION

Keep your fingers clear of the disc drawer as it is closing to avoid personal injury.

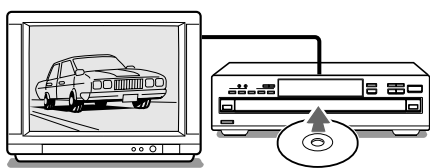

This section shows you the basics on how to playback a disc. Most steps in this manual need to be performed using the supplied remote controller. The relative buttons are usually indicated at the beginning of a section.

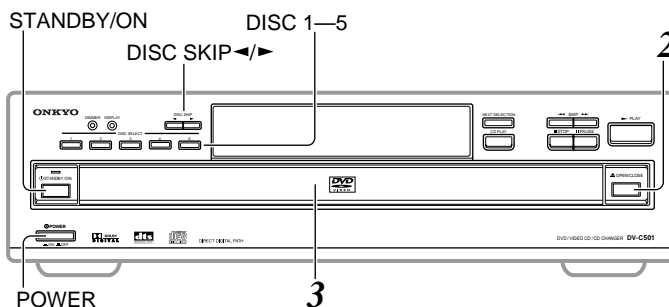

Basic Playback

■ Preparations

- To view a video disc, switch on your TV set and select the video input the DV-C501 is connected to. See also pages 10, 11 for how to connect the DVD Changer to your TV set.
- If you are also using an amplifier for separate audio playback (see pages 11, 12, 13), switch on the amplifier and select the input the DV-C501 is connected to.

<p>1</p> <p>② POWER</p> <p>③ STANDBY/ON</p> <p>OR</p> <p>POWER</p>	<p>Connecting to a Wall Outlet and Powering On.</p> <ol style="list-style-type: none"> Plug the power cable into a suitable wall outlet. Press the POWER button on the main unit to switch it to Standby mode. The STANDBY/ON indicator on the main unit lights. Press the STANDBY/ON button on the main unit, or the POWER button on the supplied remote controller to switch on the DVD Changer. The display lights up, and the STANDBY indicator goes dark. 	<p>Note:</p> <p>When you use the DV-C501 for the first time: When the DV-C501 is shipped from the factory, the POWER switch is set to ON (ON OFF). Therefore, when you plug in the power cable to the AC outlet, the STANDBY/ON indicator lights up and the unit enters Standby mode as described in Step 1- ②.</p>
<p>2</p> <p>OPEN/CLOSE</p> <p>OR</p> <p>OPEN/CLOSE</p>	<p>Press the OPEN/CLOSE button.</p> <p>The disc drawer opens, and the disc indicator lights up. (See “DISC INDICATORS ATTENTION” on page 42.)</p>	<p>Note:</p> <p>The disc drawer can also be opened when the DVD Changer is switched off.</p>
<p>3</p>	<p>Place a disc in the front disc tray (DISC 1).</p> <p>Be sure to insert the disc with the playback side down.</p> <p>■ Placing discs in the remaining disc trays.</p> <p>Repeatedly press the DISC SKIP button on the main unit to rotate the disc drawer in the direction of the arrow of the button, and place a disc in each desired tray (1–5).</p>	<p>Notes:</p> <ul style="list-style-type: none"> The DV-C501 supports two disc sizes. To avoid damaging your discs or causing malfunction, be sure to insert the discs in the correct guide. Only use DVD video discs or audio CDs. Other data carriers may damage your DVD Changer and/or amplifier/TV set.
<p>4</p> <p>OPEN/CLOSE</p>	<p>Press the OPEN/CLOSE button again.</p> <p>The disc drawer closes. Press one of the DISC 1–5 buttons to select the desired disc on the tray for playback.</p>	<p>Note:</p> <p>Alternatively, press one of the DISC 1–5 buttons to close the disc drawer and play the selected disc automatically.</p>

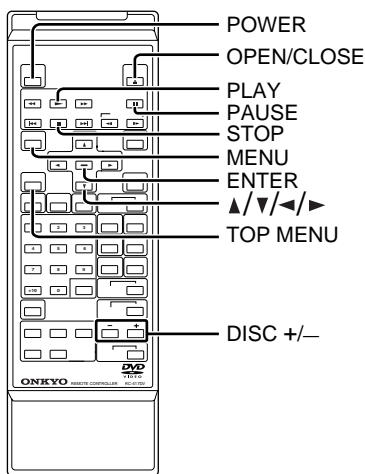

■ To obtain a higher picture quality

Occasionally, some picture distortion not usually visible during a normal telecast may appear on the TV screen during playback of a DVD video disc. This is due to the fact that DVD videos provide a higher resolution and therefore also more data to process. While the amount of noise depends on the TV you connect the DVD Changer to, reducing the sharpness setting on your TV when viewing DVD video discs may alleviate the problem.

■ About the DVD VCD CD symbols

The DVD VCD CD icons on the heading bars below show the discs that support the function described in the section in question.

DVD : This function is available for playback of DVD video discs.

VCD : This function is available for playback of VIDEO CDs.

CD : This function is available for playback of audio CDs.



5

PLAY



OR



Press the ► PLAY button.

The DVD Changer starts playback.

If you have inserted a DVD video disc with a title menu or a Video CD with PBC (Playback Control) functionality, a menu screen may appear. See "Direct Playback via the On-Screen Menu" on page 16.

To start playback of a PBC-equipped VIDEO CD from the menu screen, set "PBC" to "ON" via the on-screen menu function. See page 38.

Notes:

- For PBC (Playback Control) of VIDEO CDs, see "About VIDEO CDs" on page 9.
- Depending on the DVD video disc you are using, you may need to press the TOP MENU or MENU button to display the menu screen.

■ Inserting other discs

1. Press the ▲ OPEN/CLOSE button to open the disc drawer.
2. Press the DISC SKIP ◀ / ▶ button on the main unit repeatedly until the disc you wish to replace can be accessed.
3. Remove the disc you wish to replace, and insert another disc.
4. Press the ▲ OPEN/CLOSE button again to close the disc drawer.

Note:

You can also press the ► PLAY button to automatically close the drawer and start playback of the disc that is currently up front. To start playback of another disc than the one in the front tray, you first need to close the disc drawer.

■ Selecting the desired disc for playback

Press one of the DISC 1–5 buttons on the main unit or on the remote controller. The DV-C501 starts playing the first title of the selected disc. There is no need to press the ► PLAY button.

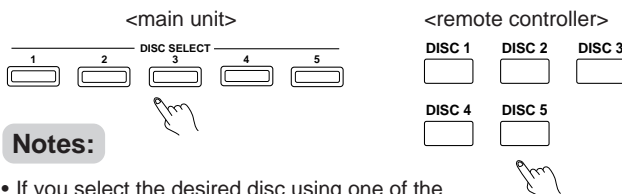

Notes:

- If you select the desired disc using one of the DISC 1–5 buttons while the DVD Changer is playing back a title of another disc, playback starts with the first title of the newly selected disc.
- You can also press the DISC SKIP ◀ / ▶ button on the unit or DISC +/- button to jump to the disc in the next tray (or from tray #5 to tray #1 if the disc in tray #5 is currently being played back). In that case playback will start with the first title of the disc in the newly selected tray.
- If you select the desired disc by pressing the DISC SKIP button while the DVD Changer is stopped, press the ► PLAY button to start playback of the first title of the selected disc.

■ The FIRST SETUP screen

The FIRST SETUP screen is only displayed the very first time you switch on your DV-C501. This page allows you to set the

two single most important parameters. Note that you can change these settings any time by selecting the appropriate on-screen menu function. See also page 34, 35.

1. Check the video connection of the DVD Changer to your TV set (see page 10 and following) and switch on your TV.

2. Switch on the DVD Changer.

The following menu screen page is displayed:

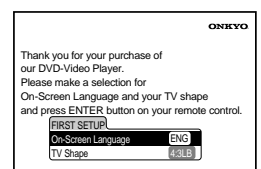

3. Press the remote controller's ▲ or ▼ button to select "On-Screen Language" and press the ENTER button.

You can select one of the following languages: ENG (English), FRE (French), or SPA (Spanish). That language will be used on all on-screen menu pages and for subtitles. See page 35.

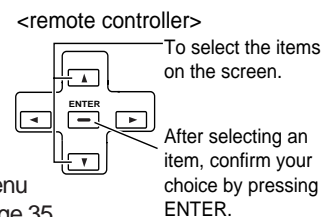

4. Select the desired language using the ▲ or ▼ button and confirm by pressing ENTER.

Note:

If you agree with the currently selected language, just press ENTER without changing the setting.

5. Press the ▼ button to select the "TV Shape" function and confirm by pressing ENTER.

This function allows you to specify the picture size of your TV. See 35 for details.

6. Use the ▲ and ▼ buttons to specify the screen size and confirm by pressing ENTER.

7. Press the SETUP button to store your settings.

The settings are stored and you are returned to the FIRST SETUP screen page. As stated above, you can also change these settings at a later stage. See page 32.

Playing back Discs (continued)

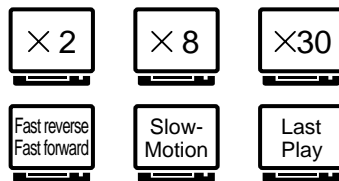

You can play back discs at various speeds, and resume playback in various ways. Use the remote controller for the following functions.

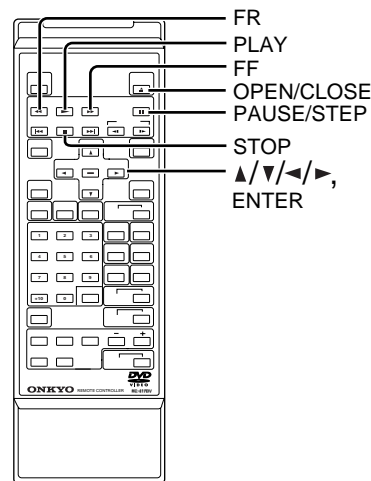

Direct Playback, Stop and Pause

Direct Playback via the On-Screen Menu

- Switch on your TV set.
- Select the desired title using the **▲ / ▼ / ◀ / ▶** or the number buttons.
- Press the **ENTER** button.
 - The DVD Changer starts playing back the selected title.
 - If you do not need the menu functionality of PBC-encoded Video CDs, set the "PBC" function to "Off". See page 38.

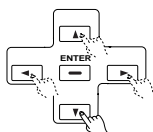

Pausing Playback: Still mode

- To pause playback, press the **⏸ PAUSE/STEP** button.
 - The sound is muted during still mode.
- Press the **▶ PLAY** button to resume playback.

Note:

The DV-C501 also provides a function for optimum display of still pictures (only available for DVD video discs). See "Pause/Still" on page 37.

Stopping Playback

Press the **■ STOP** button.

If you do not wish to resume playback from this position, see "Resuming Playback from the Beginning of the Current Title" on page 17.

Removing a Disc

- Stop playback.
- Press the **▲ OPEN/CLOSE** button.
- Wait until the disc drawer has opened completely, then remove the disc.

Notes:

- Do not move the DV-C501 during playback or subject it to strong vibrations to avoid damaging the discs.
- Use the **▲ OPEN/CLOSE** button on the remote controller or DVD player to open and close the disc drawer. Do not obstruct the disc drawer while it is moving. Doing so may cause the DVD Changer to malfunction.
- Do not push up the disc drawer or put objects other than discs on it. Doing so may cause the DVD Changer to malfunction.
- In many instances, a menu screen will appear after playback of a movie is completed. Prolonged display of such a menu may damage your television set, permanently etching that image onto the screen. To avoid this, press the **■ STOP** button on your remote controller once playback of the movie is finished.
- If you pause a picture and leave it still for a long time, the screen saver of the DV-C501 is automatically activated (provided the "Screen Saver" function is set to "On", see page 37). To deactivate the screen saver and resume playback, press the **▶ PLAY** button.

Fast Reverse and Fast Forward Playback

FR

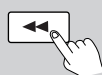

FF

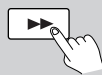

Press the **FR (fast reverse)** or **FF (fast forward)** button during playback.

DVD video discs

The playback speed changes to twice the normal speed in the selected direction. Press the button again to further increase the fast forward or reverse speed.

FR: press this button to quickly return to an earlier position.

FF: press this button to advance to a position behind the current position.

TV screen

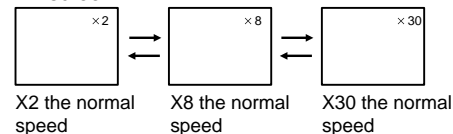

The direction of the arrow varies depending on the button you press.

VIDEO CDs/Audio CDs

For Video and Audio CDs, there are two fast forward and reverse speeds.

TV screen

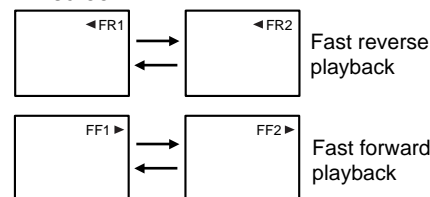

Resuming Normal Playback after Fast Forwarding/Reversing

PLAY



After locating the desired position, press the **▶ PLAY** button to resume normal playback.

- The DVD Changer does not play back sound or subtitles during fast reverse or forward scans of DVD video discs. The sound of audio CDs, however, is played back at the selected scrolling speed.
- The x2, x8 and x30 speeds are only approximate values. They may vary slightly from disc to disc.

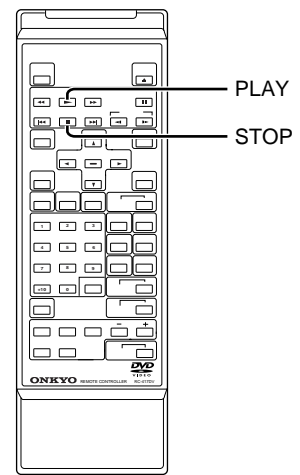
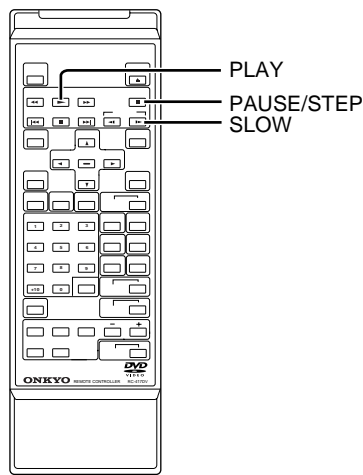

Slow-Motion Playback

DVD VCD

DVD video discs can be played back in slow motion. This is done by reducing the playback speed.

Press the ◀ or ▶ SLOW button during playback.

By pressing either button repeatedly, you can cycle through the three available playback speeds.

TV screen

1/2 the normal speed 1/4 the normal speed 1/8 the normal speed

TV screen

1/8 the normal speed 1/4 the normal speed 1/2 the normal speed

Only for the DVD video disc

Resuming Normal Playback

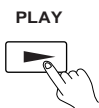

Press the ▶ **PLAY** button to resume normal playback.

Using Frame Step

DVD VCD

PAUSE/STEP

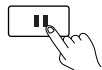

While playback is paused, you can step forward one frame at a time by pressing the || **PAUSE/STEP** button.

Resuming Playback From the Desired Location

DVD VCD CD

After stopping playback, you can either resume from the location where it was stopped, or from the beginning of the current title.

- Press the ■ STOP button at the location where you want to halt playback.**

The DVD Changer memorizes this location.
- Press the ▶ PLAY button.**

The DVD Changer resumes playback from the location where playback was stopped.

Resuming Playback from the Beginning of the Current Title

If you do not wish to resume playback from the position where it was stopped, proceed as follows. In this case, playback will be started from the beginning of the last title you played back, or from the beginning of the disc.

1. Stop playback by pressing the ■ STOP button twice.



The second press of the ■ STOP button will clear the DVD Changer's location memory.

2. Press the ▶ PLAY button.

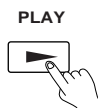

The location where playback is started depends on the type of disc you are using:

DVD video disc: Playback starts from the beginning of the current title.

Video CDs/audio CDs: Playback starts from the beginning of the disc.

- To resume playback a DVD video disc from the beginning of the disc, press the ■ STOP button, open and close the disc tray by pressing the ▲ OPEN/CLOSE button, then press the ▶ PLAY button.

Notes:

- The DVD Changer's location memory is also cleared when you:
 - unplug the DVD Changer from the wall outlet after stopping playback.
 - open the disc drawer.
 - adjust/change the Parental Lock function (see page 37) or select another disc menu language (see page 34).
- Depending on the disc, playback may not be resumed at the exact location where it was stopped.
- Other settings you change via the on-screen menu while a location is memorized may be available only after the memory is cleared.

Locating Titles, Chapters, or Tracks

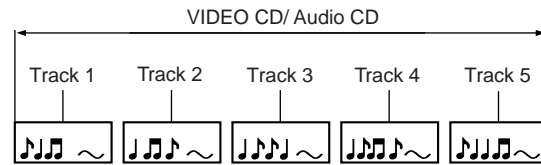
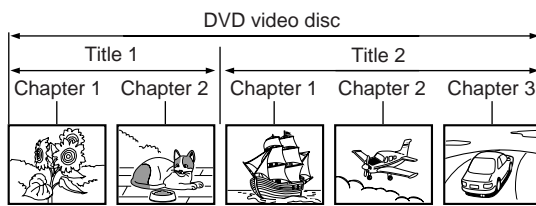

Normally, DVD video discs are divided into “titles”, while the titles are themselves sub-divided into “chapters”. VIDEO CDs and audio CDs are divided into “tracks”. You can quickly locate any specific title, chapter, or track.

Locating a Title Using the Title Menu DVD

If the DVD video disc you are playing back contains a title menu, you can locate any specific title you wish to play back.

- 1** Press the **TOP MENU** button.

A Title menu like the following appears:
- 2** Use the **▲ / ▼ / ◀ / ▶** buttons to select the title you want to watch.

If the titles in the Title menu are assigned a number, you can directly select the desired title using the numeric buttons on the remote controller.
- 3** Press the **ENTER** button.

The DVD Changer starts playback from Chapter 1 of the selected title.

Notes:

- The above instructions correspond to the basic procedure. Please note that the exact steps may depend on the contents of the selected DVD video disc. If different instructions appear on the TV screen, follow those instructions.
- If you display the Title menu during playback and press the TOP MENU button again without selecting a title, the DVD Changer resumes playback from the point where you first pressed the TOP MENU button.

Title Selection with the Numeric Buttons DVD

If the selected DVD video disc contains Title numbers, you can select the desired title by entering its number.

- 1** Press the **SEARCH** button.

Check whether the Title number is highlighted. If it is not, press **▲** to select it.

Example:
- 2** Press the numeric button of the Title you wish to select.

To select a two-digit title, press the digits in order of magnitude (e.g., for 32, press “3” then “2”).

To select Title 2, press [2].

To select Title 12, press [1] or [+10] once, then [2].
- 3** Press the **▶ PLAY** button.

The DVD Changer starts playback from Chapter 1 of the selected title. You can also select another Chapter before starting playback.

Notes:

- Press the CLEAR button if you do not wish to start playback from the Title number you have just entered (before pressing the **▶ PLAY** button). Pressing CLEAR several times will reset both the Title and Chapter numbers. (SEARCH also allows you to directly select the desired Chapter, see next page.)
- See pages 32, 34 for how to select the languages for the on-screen menu displays.

Selecting a Precise Scene or Audio Passage

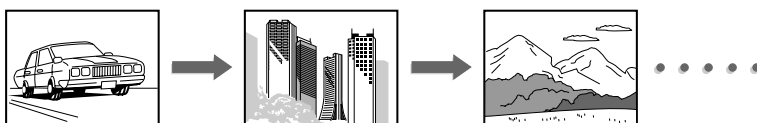

It is also possible to directly select a given location and to start playback from there. This may come in handy when you want to view a given scene (DVD video discs/Video CDs) or listen to a specific passage (audio CD) within the currently selected Title or Track.

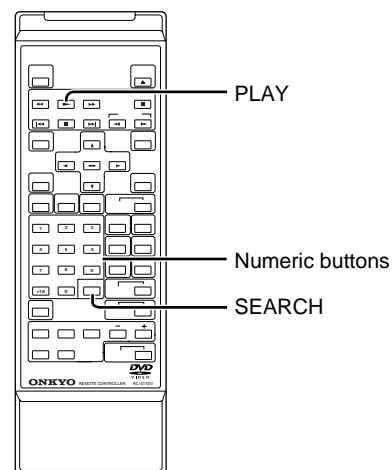

Entering the Time Location

DVD VCD CD

Here is how to enter the time location of the scene or passage you wish to play back:

1 SEARCH 	Press the SEARCH button several times until the following message is displayed: Time ---
2 	Enter the desired time value with the numeric buttons. Here is an example: 1 → 2 → 5 → 3 → 0 Time 1:25:30
3 PLAY 	Press the ► PLAY button. The DVD Changer starts playback from that location.

Notes:

- Some discs may not respond to this procedure.
- In some cases, there may be a slight shift between the time value you enter and the location where playback starts.
- This method of selecting the desired location is only available within the current Title (DVD video discs) or track (Video/audio CDs).

Repeat Functions

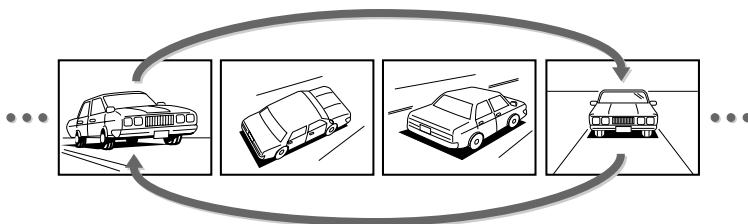

Your DVD Changer allows you to repeat a given Title, Chapter/track or disc indefinitely. It is also possible to repeat a given scene or audio passage (A-B Repeat).

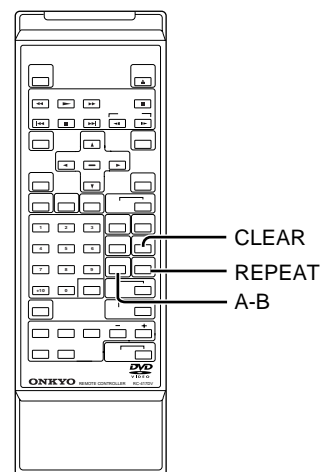

Repeating a Title or Chapter/Track

Here is what you need to do in order to program a playback loop of the selected Title, Chapter/track, or disc:

- 1** Select the disc that contains the material to be repeated (or that you want to playback repeatedly in its entirety).
See "Selecting the desired disc for playback" on page 15.
- 2** Select the Title or Chapter/track you want to repeat.
See "Locating Titles, Chapters, or Tracks" on page 18 and following.
- 3** Press the REPEAT button to select the desired Repeat function.
Pressing this button repeatedly cycles you through the available options. These options depend on the currently selected disc:
DVD video discs:
 - Chapter Repeat Repeats the same chapter.
 - Title Repeat Repeats the same title.
 - Disc Repeat Repeats the same disc.
 - All Repeat Repeats all discs.
 - Repeat Off Resumes normal playback.**Video CDs/audio CDs**
 - Track Repeat Repeats the same track.
 - Disc Repeat Repeats the same disc.
 - All Repeat Repeats all discs.
 - Repeat Off Resumes normal playback.
- 4** CLEAR
To cancel the Repeat function at any time, press the CLEAR button.

Note:

Some discs do not support these Repeat functions.

Repeating a Given Scene or Passage

- 1** Start playback of the desired Chapter or Track (see page 19 and following for how to select it).
- 2** Press the A-B button at the beginning of the scene or passage you wish to repeat (this position is called "A").
- 3** Press A-B again at the end of the excerpt to be repeated (to store point "B").

The DVD Changer automatically returns to point "A" and starts repeating the selected excerpt.
- 4** CLEAR
To cancel the Repeat function at any time, press the CLEAR button.

Notes:

- Some discs do not support the A-B Repeat function.
- The "A" and "B" points must be located within the currently selected Title or Track.
- For DVD video discs: The A-B Repeat function is not available for scenes that provide several camera angles.
- In some cases, the "A" and "B" points may be shifted slightly with respect to the positions you selected.

Setting the Desired Playback Order



Your DV-C501 comes with a special 28-step memory that allows you to program the order in which the Titles and Chapters/tracks are to be played back. Such “sequences” can include material from several discs.

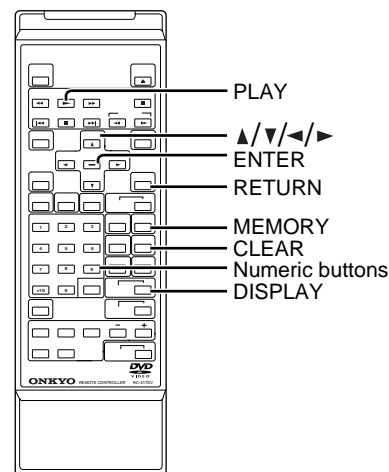

DVD VCD CD

Programming Memory Sequences

The DV-C501's Memory function allows you to program the order in which the material on one or several discs should be played back.

Note:

If you only want to select the next track for playback, using the Next Selection function is a lot faster. See page 24.

■ Programming the D, T and C entries

Here are a few hints that explain the programming system and help you save time:

Note:

For Video and audio CDs, you can only program the disc (“D”) and Track numbers. Track numbers are assigned to the “T” entry. The “C” entry only applies to DVD video discs.

Only specify what you does need to change:

Disc number: if a subsequent entry refers to the previously selected disc number, you do not need to enter it again for the new step. (Do not change the “—” setting for “D”.)

Title number (DVD video discs only): if a subsequent step refers to another Chapter of the previously selected Title, only entering the Chapter number is enough. (Do not change the “—” setting for the “D” and “T” entries.)

Chapter number (DVD video discs only): if you want the DV-C501 to play back all Chapters of the selected Title, leave the “C” entry blank.

- 1

Insert the disc(s) you need for programming the desired sequence.
- 2

Switch on your TV set.
- 3

MEMORY

Stop playback if it is still running, and press the MEMORY button.

MEMORY			
D	T	C	
1	---	8	---
2	---	9	---
3	---	10	---
4	---	11	---

The letters on this menu page have the following meaning:
D: Disc number, T: Title (or Track) number, C: Chapter number.
- 4

Use the numeric buttons on the remote controller to enter the numbers you wish to include in your Memory sequence.

Use the ◀ / ▶ buttons to move the cursor to the “D”, “T”, or “C” column, depending on whether you want to enter a disc, Title (or Track), or Chapter number.
- 5

ENTER

Confirm your selection by pressing the ENTER.

The DV-C501 now jumps to the next Memory step.
- 6

Program the remaining steps.
- 7

PLAY

Press the ▶ PLAY button to start playback of your memory sequence.

Here are a few programming examples:

Chapters 25 and 12 of Title # 2 on disc #3 (two steps):

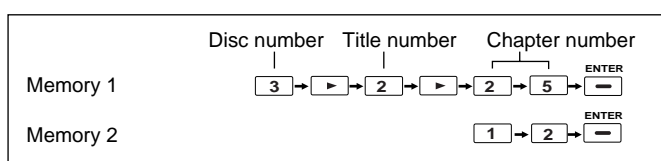

All chapters of Title #1 on disc #1:

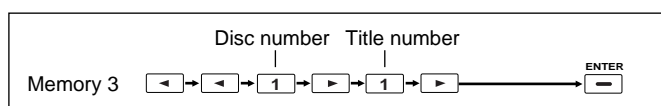

Chapter 2 of Title #4 on disc #1:

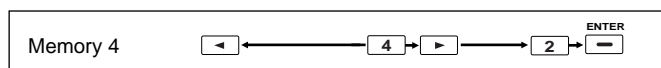

MEMORY											
D	T	C	D	T	C	D	T	C	D	T	C
1	3	02 25	8	---	---	15	---	---	22	---	---
2	3	02 12	9	---	---	16	---	---	23	---	---
3	1	01	10	---	---	17	---	---	24	---	---
4	1	04 02	11	---	---	18	---	---	25	---	---
5	---	---	12	---	---	19	---	---	26	---	---
6	---	---	13	---	---	20	---	---	27	---	---
7	---	---	14	---	---	21	---	---	28	---	---

“Copy” the settings of the previous memory:

Doing so allows you to use the settings of the previous memory as a starting point and only change one entry. Example: if memory 1 refers to disc 3/Title 2/Chapter 25, while memory 2 needs to refer to disc 3/Title 2/Chapter 12, you can “copy” memory 1 to memory 2 and modify the “C” (chapter) entry:

- Program the memory to be copied (example: memory 1), and press the ENTER button. The DVD Changer advances to memory 2.
- Use the numeric buttons to enter the chapter number 12 on the black cursor on the “C” entry, then press the ENTER button, “D” and “T” on the memory 1 are copied to memory 2.

Other Memory Functions

Leaving the MEMORY display page

To leave the MEMORY display page, press the MEMORY button.

Correcting an entry of a previously programmed step:

- Use the ▲ / ▼ buttons to move the cursor to the corresponding memory number.
- Select the entry (D, T or C) you wish to change with the ◀ / ▶ buttons.
- Enter the correct value using the numeric buttons.

Erasing a step

- Stop playback.
- If the Memory sequence is not currently displayed, press the MEMORY button to select it.
- Select the step you wish to erase with the ▲ / ▼ buttons.
- Press the CLEAR button to erase the selected step.

Erasing the entire Memory sequence

To erase all steps, either switch the DVD Changer off and back on again, or open and close the disc tray.

Programming the next step during playback

If you press the MEMORY button during playback, a menu page is displayed where you can program a new step.

Programming several new steps during playback

- Press the MEMORY button followed by the DISPLAY button. The Memory menu appears on the TV screen.
- Continue with step 3 on page 22.

Notes:

- Some discs do not allow Memory playback.
- The Repeat function (see page 21) is also available during playback of your Memory sequence. Press the REPEAT button to activate it for the current step of your Memory sequence.
- You can only program Title (or Track) and Chapter numbers that exist on the selected disc.
- For Video and audio CDs, the “T” entry allows you to select the track, while the “C” entry is not used.
- The Memory function is also available during playback.

Additional Playback Functions

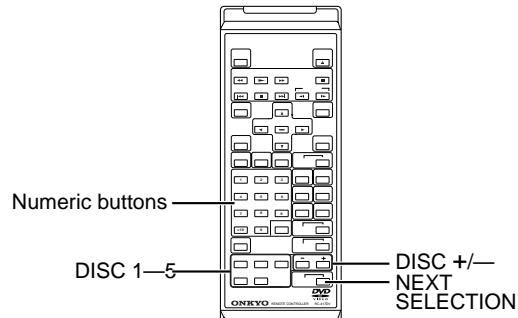

Next Selection: Preparing the next Audio Track



During playback of an audio CD, you can already prepare the next track that will be played as soon as the current one is finished. The difference with direct selection of a track or disc is that playback of the prepared track starts only after the current track is finished (i.e. not right away).

1 During playback of an audio CD, press the **NEXT SELECTION** button on the DV-C501 or the remote controller to activate this function.

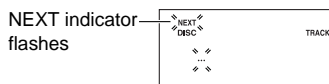

The NEXT indicator flashes and the disc number and track number disappear on the display.

2 Use the **DISC 1 – 5** buttons (or **DISC +** and **DISC –**) to select the disc that contains the next track you want to listen to.

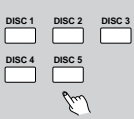

The number of the selected disc and the "AL" indicator flash on the display.

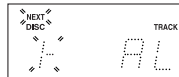

If you wish to play all tracks of the selected disc, press the **NEXT SELECTION** button again to confirm the operation. (If you do not press the **NEXT SELECTION** button, the operation will be confirmed when the number and the "AL" indicator stop flashing.)

AL: means that all tracks will be played back. Skip to Step 3 to select the track number.

3 Select the track using the numeric buttons. The number of the selected track lights up on the display.



In that case, the display looks as follows:

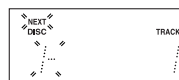

Tip:

- You can also use the **DISC SKIP** ◀ / ▶ button on the DV-C501 to select the next disc.

■ Checking the next selection

1 Press the **NEXT SELECTION** button to confirm your selection. The disc number flashes and the track number lights up continuously. After a few moments, the disc and track numbers of the currently playing track reappear.

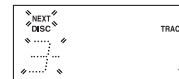

You can check the next selection by pressing the **NEXT SELECTION** button.

As soon as the current track is finished, the DVD Changer will play back the prepared track (or disc if you selected "AL").

Notes:

- The ◀◀ / ▶▶ buttons are disabled while the Next Selection function is activated. Pressing the **DISC SKIP** ◀ / ▶ buttons or **DISC +/-** buttons will cancel the Next Select function.
- You can only prepare one track with Next Selection. See "Programming Memory Sequences" on page 22 for how to prepare a series of tracks. Preparing yet another track before the previously entered Next Selection command has been executed overrides your first setting, so that only the second Next Selection is carried out.
- If you stop playback by pressing the ■ **STOP** button, the Next Selection function is cancelled.

■ Cancelling the Next Selection function

If you decide not to take advantage of the Next Selection function after all, proceed as follows:

- Press the **NEXT SELECTION** button. The disc numbers flash on the display.
- Press the **CLEAR** button.
- Press the **NEXT SELECTION** button again. The **NEXT** indicator goes dark and the function is cancelled.

Notes:

- This function is only available for audio CDs (when the CD indicator lights).
- You need to press one of these buttons within 8 seconds after pressing **NEXT SELECTION**. Otherwise, the Next Selection function will be cancelled. In that case, start again with step 1.

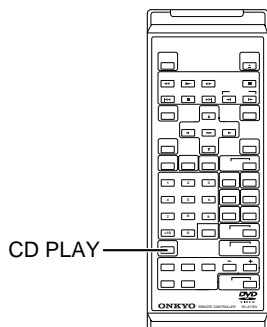

Using the DVD Changer as CD player CD

Since your DV-C501 allows you to insert up to five discs in any combination (DVD video discs, Video CDs, audio CDs), there may be times when you only want to listen to music and avoid having to press the DISC SKIP ◀ / ▶ or DISC +/- buttons several times to skip to the next audio CD. In that case, proceed as follows:

1

CD PLAY



Press the CD PLAY button while the DV-C501 is stopped or playing back a CD.

The RPT message appears on the display and the REPEAT indicator lights to signal that all audio CDs will be repeated in sequence.

REPEAT CD CD ▶

REPEAT

●●●●●

↓ The indication changes in 2-3 seconds.

DISC TRACK REPEAT CD CD ▶

3 1 RPT

●●●●●

CD PLAY



Press the CD PLAY button again to cancel CD Mode.

The RPT message disappears and the REPEAT indicator goes dark again to signal that the DVD Changer has returned to normal playback mode.

Notes:

- The CD PLAY button does not work while the DV-C501 is playing back a disc other than an audio CD. You first need to press the STOP button. Next, press the CD PLAY button to enter CD PLAY Mode. The DVD Changer starts playing back the audio CD in the disc drawer with the lowest number.
- Another way of selecting only audio tracks is to take advantage of the DV-C501's Memory function. See "Programming Memory Sequences" on page 22 for details.

Additional Playback Functions (continued)

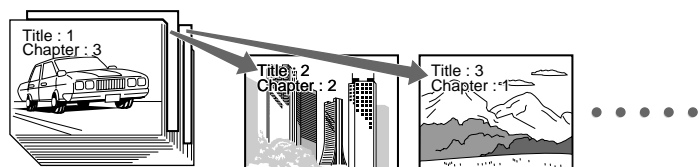

The DV-C501's Random playback functions allow you to select a mode where the DV-C501 decides which Title or Chapter/track to play next. A similar function is available on most CD players. There are two Random functions: one for DVDs only, and another that is available for both DVDs and Video/audio CDs:

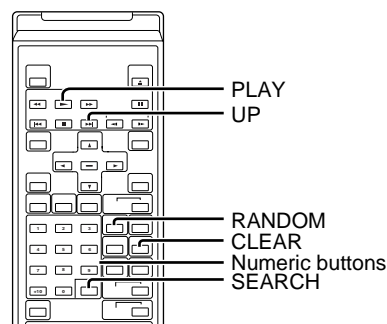

Random Playback

Title Random

For DVD video discs, you can decide to have the DV-C501 select the Titles in a random (unpredictable) order:

1	<p>Stop playback and select the DVD video disc whose titles you wish to watch in random order.</p> <p>See "Selecting the desired disc for playback" on page 15 for details.</p>
2	<p>Press the RANDOM button to select "Title Random".</p> <p>Pressing this button repeatedly will cycle through the following options:</p> <div style="border: 1px solid black; padding: 5px; margin: 10px 0;"> <p>DVD Chapter Random</p> <p>↓</p> <p>Title Random</p> <p>↓</p> <p>Random Off</p> </div> <p>Note: If you press the RANDOM button during playback, the DV-C501 automatically starts random playback after finishing the current title.</p>
3	<p>Press the ► PLAY button within 5 seconds after pressing the RANDOM button.</p> <p>The DVD Changer starts random playback.</p>
4	<p>Press CLEAR to resume normal playback.</p>

Notes:

- Some discs may not permit random playback.
- You cannot use this Random function in conjunction with Memory playback (see page 22).
- Select "Random Off" if you do not need the Random function after all.

Playing Chapters or Tracks in Random Order

This Random function allows you to activate random playback of the Chapters within the currently selected title (DVD video discs) or of the tracks on a Video or audio CD.

1	<p>Stop playback and select the disc whose titles you wish to watch/listen to in random order.</p> <p>See "Selecting the desired disc for playback" on page 15 for details.</p>
2	<p>Press the SEARCH button and use the numeric buttons on the remote controller to select the Title.</p> <p>(DVD video disc)</p> <div style="border: 1px solid black; padding: 5px; margin: 10px 0;"> <p>SEARCH → 2</p> <p>Title: 1 Chapter: 1</p> </div> <p>Note: This is only possible for DVD video discs. Skip to step 2 for Video/audio CDs.</p>
3	<p>Press the RANDOM button to select "Chapter Random" (DVD) or "Track Random" (Video/audio CD).</p> <p>If you press the RANDOM button during playback, the DV-C501 automatically starts random playback after finishing the current Chapter or track.</p> <div style="border: 1px solid black; padding: 5px; margin: 10px 0;"> <p>(DVD video disc)</p> <p>Chapter Random</p> <p>Title: 1 Chapter: 1</p> </div>
4	<p>Press the ► PLAY button within 5 seconds after pressing the RANDOM button.</p> <p>The DVD Changer starts random playback.</p>
5	<p>Press CLEAR to resume normal playback.</p>

Notes:





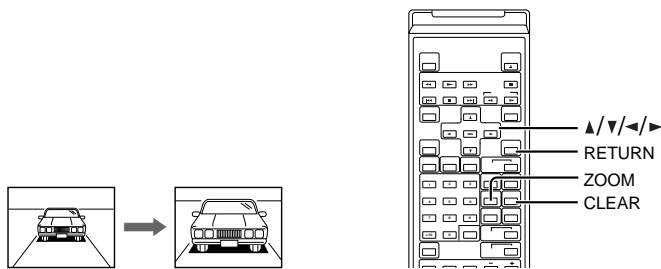

- Some discs may not permit random playback.
- You cannot use this Random function in conjunction with Memory playback (see page 22).
- You can press the UP ►► button during Random playback to jump to the next Chapter or track and continue Random playback from there.
- Select "Random Off" if you do not need the Random function after all.

DVD Video Disc Functions

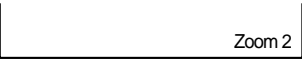
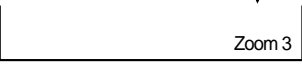

Zooming in

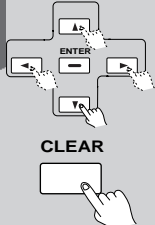
The Zoom function allows you to magnify a portion of a picture. Feel free to select the area to be magnified.

1	 ZOOM	<p>Press the ZOOM button during normal or slow (see page 17) playback or while playback is paused (“still”, see page 16).</p> <p>There are three Zoom levels. Press this button repeatedly to select the desired level.</p> <div style="text-align: center;">  Zoom 1 ↓  Zoom 2 ↓  Zoom 3 </div>
2	 RETURN	<p>Press the RETURN button to progressively zoom out again (return to the preceding Zoom level).</p>
3	 CLEAR	<p>Use the ▲ / ▼ / ◀ / ▶ buttons to shift the zoom point.</p> <p>When the zoom point reaches an edge of the picture, the color of the “Zoom” message changes.</p> <p>Pressing the CLEAR button restores the zoom point to the center of the picture.</p>
4	 ZOOM	<p>To defeat the Zoom function, press the ZOOM button repeatedly until the “Zoom” message disappears.</p>

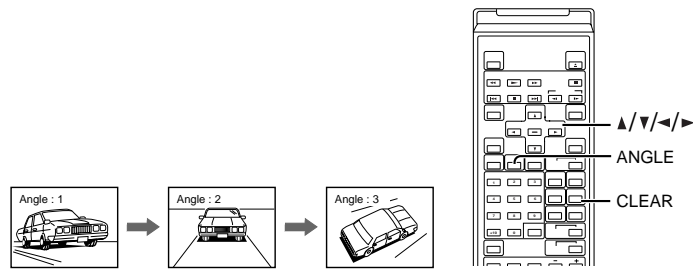

Notes:

- Some DVD Video discs do not support the Zoom function.
- For certain scenes, the Zoom function is not available.
- The Zoom function does not apply to subtitles or menu screens included on DVD video discs.
- During zoom playback, the ▲ / ▼ / ◀ / ▶ buttons are not available for selecting option of a DVD’s menu function (they are used to shift the zoom point). If you want to use the menu screens, cancel zoom playback (see above).
- The magnification level varies depending on the picture size you select (see page 32, 35).

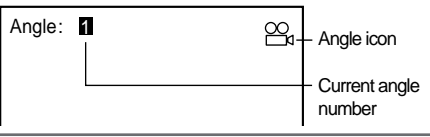

Changing the Camera Angle

One of the new features of the DVD carrier is that some discs contain scenes shot from different angles. The following function allows you to select the desired angle.

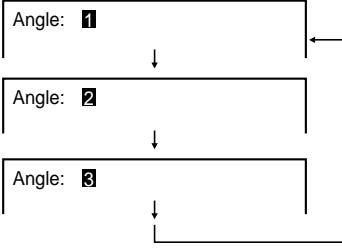
1	 ANGLE	<p>Set the “On-Screen Displays” function to “On” if you want the angle icon (📐) as well as series of other icons to be displayed on screen. See pages 32, 37 for details.</p> <p>If you do not need these on-screen messages, set the above function to “Off”.</p>
2		<p>Start playback and look out for the multiangle icon (📐).</p> <p>If this icon appears on the display (and on screen)...</p>
3		<p>...press the ANGLE button.</p> <div style="text-align: center;">  </div>
4	 ANGLE	<p>Select the desired Angle by repeatedly pressing ANGLE.</p> <p>You can also use the ▲ and ▼ buttons to advance to the next or return to the previous angle. ANGLE only allows you to cycle in one direction.</p> <div style="text-align: center;">  </div> <p>Use the numeric buttons to directly select the desired angle.</p>
5		<p>Press the CLEAR button to switch off the angle number.</p>

Notes:

- You can also change the camera angle in pause (“still”) mode (see page 16). In that case, the camera angle changes to the new setting when you resume playback.
- If you pause a picture immediately after changing the camera angle, the resumed playback picture may no longer use the new camera angle.

DVD Video Disc Functions (continued)

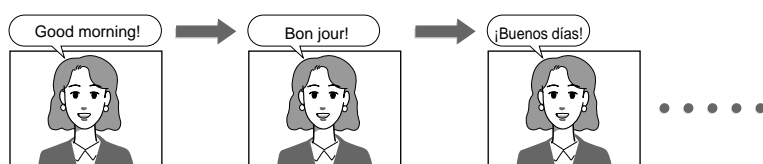

Your DV-C501 allows you to select the following audio-related settings. The number of options depends on the DVD video disc you are playing back. It is not possible to select an option for which there is no data on the DVD.

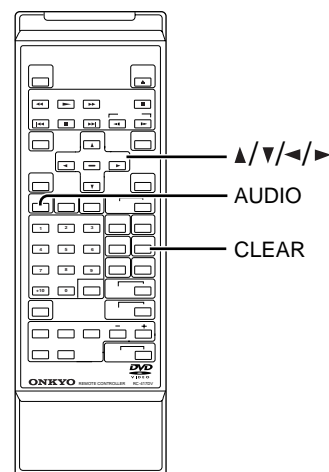

Audio Playback Settings

Language: A DVD video disc may contain several language versions of a movie. Select the preferred language.

Recording system: Select the recording system that best matches the input capabilities of your amplifier or receiver. For example, there is little point in selecting "Dolby Digital 6CH" if your amplifier does not support Dolby Digital 5.1. Depending on the selected recording system, the DV-C501 automatically converts the audio data to an acceptable format for your amplifier.

The DV-C501 accepts the Dolby Digital, DTS, and PCM recording systems. Other systems cannot be played back. See also the conversion table below for details about the available options. Dolby Digital 5.1 Channel is displayed as "Dolby Digital 6CH."

1 **AUDIO**

Press the AUDIO button during playback of a DVD video disc.

The current Audio settings are displayed for about 3 seconds.

Output sound format

See page 39 for a list of abbreviations of the available languages and their meaning.

2 **AUDIO**

Press the AUDIO or ▲ button while the above Audio page is still displayed (i.e. within 3 seconds).

Pressing one of these buttons cycles through the available options.

Use the ▼ button to cycle in the opposite direction.

3 **CLEAR**

After making the desired settings, either wait more than 3 seconds, or press the CLEAR button to leave the Audio page.

Selecting Sound Channels of Video CDs

A Video CD may have left and right sound channels with different information (sound track on one channel, dialogues on the other; or one language on one channel, and another on the second channel, etc.). You can select the desired channel:

During playback, press AUDIO repeatedly to select the sound channel.

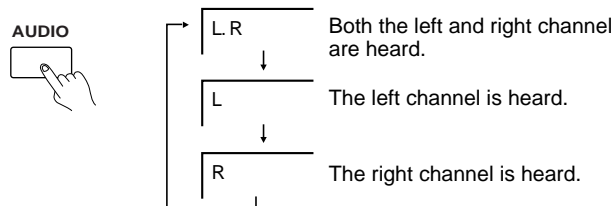

Notes:

- Some discs allow you to change Audio settings only via the disc menu. In that case, press the MENU button and choose the desired language.
- The Audio settings are not saved internally. When you switch off the DVD Changer or open the disc tray, the DV-C501 returns to the default setting. See page 34.
- When you select an option that is not available on the selected DVD video disc, the DV-C501 ignores your setting and goes on using the previously selected language, etc.

Recording Systems and Automatic Conversions

Here are all the Recording systems formats the DV-C501 supports as well as the conversions that will be carried according to the Recording system you select (see page 28).

Output sound conversion table (sampling frequency/quantization bit)

Discs	Sound recording system	Audio settings on the setting screen (page 32, 36)					
		Bitstream		Analog 2ch Stereo Output		PCM	
		DIGITAL OUTPUT jack	ANALOG OUTPUT jacks	DIGITAL OUTPUT jack	ANALOG OUTPUT jacks	DIGITAL OUTPUT jack	ANALOG OUTPUT jacks
DVD video discs	Dolby Digital	Bitstream	48 kHz/16 bit	Bitstream	48 kHz/16 bit	48 kHz/16 bit	48 kHz/16 bit
	Linear PCM	48 kHz/16 bit	48 kHz/16 bit	48 kHz/16 bit	48 kHz/16 bit	48 kHz/16 bit	48 kHz/16 bit
		48 kHz/20 bit	48 kHz/16 bit	48 kHz/16 bit	48 kHz/16 bit	48 kHz/20 bit	48 kHz/16 bit
		48 kHz/24 bit	48 kHz/16 bit	48 kHz/16 bit	–	48 kHz/24 bit	48 kHz/16 bit
		96 kHz/16 bit	48 kHz/16 bit	48 kHz/16 bit	–	96 kHz/16 bit	48 kHz/16 bit
		96 kHz/20bit	48 kHz/16 bit	48 kHz/16 bit	–	96 kHz/20 bit	48 kHz/16 bit
		96 kHz/24 bit	48 kHz/16 bit	48 kHz/16 bit	–	96 kHz/24 bit	48 kHz/16 bit
	DTS	Bitstream	–	Bitstream	–	–	–
MPEG 2	Bitstream(7.1ch)	–	Bitstream(2ch)	48kHz/16bit	48kHz/16bit	48kHz/16bit	
VIDEO CDs	MPEG1	44.1 kHz/16 bit	44.1 kHz/16 bit	44.1 kHz/16 bit	44.1 kHz/16 bit	44.1 kHz/16 bit	44.1 kHz/16 bit
Audio CDs	Linear PCM 44.1 kHz/16 bit	44.1 kHz/16 bit	44.1 kHz/16 bit	44.1 kHz/16 bit	44.1 kHz/16 bit	44.1 kHz/16 bit	44.1 kHz/16 bit
	DTS	Bitstream	(Noise)	Bitstream	(Noise)	Bitstream	(Noise)

DVD Video Disc Functions (continued)



Some DVD video discs also contain subtitles – sometimes even in several languages. Here is how to display them and select the language (if several languages are available).

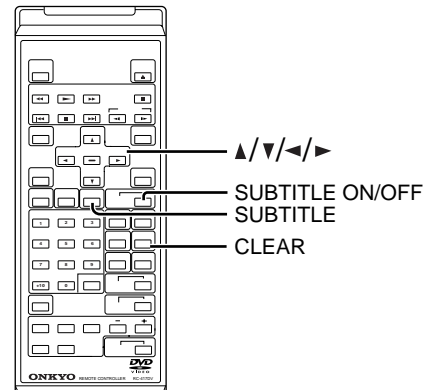

Using the Subtitle Feature

Selecting the Subtitle Language

- 1** **SUBTITLE**

Press the **SUBTITLE** button during playback.

The current subtitle setting is displayed for about three seconds.

Subtitle: 1 ENG On

|

Language

Position number

Refer to the list of languages and their abbreviations. See page 39.
- 2** **SUBTITLE**

Press the **SUBTITLE** or **▲** button during the above page is displayed.

Repeatedly press the **SUBTITLE** or **▲** button to cycle through the options. You can only select a subtitle language for which there are data on the selected DVD video disc.

Subtitle: 1 ENG On

↓

Subtitle: 2 FRE On

↓

Subtitle: 3 SPA On

⋮

You can also use **▼** button to cycle through the options in the opposite direction.
- 3** **CLEAR**

Press the **CLEAR** button to hide the above indication.

Turning Subtitles On or Off

- 1** **SUBTITLE ON/OFF**

Press the **SUBTITLE ON/OFF** button during playback.

The current subtitle setting is displayed for about three seconds.

Subtitle: 1 ENG On

Appears for about 3 seconds

Good morning!

Subtitles

The subtitles are displayed at the bottom of the screen.
- 2** **SUBTITLE ON/OFF**

Press the **SUBTITLE ON/OFF** button again to turn the subtitles off.

Subtitle: 1 ENG Off

Appears for about 3 seconds

The subtitles disappear.

Notes:

- Some DVD video discs are set to display subtitles automatically. In that case, you cannot switch off the subtitle function.
- For certain scenes, the subtitle function takes a little longer to become effective (due to heavy data processing). Switching on subtitles may thus not always have an immediate effect.
- Some DVD video discs also allow you to select the language and status of the subtitles via the disc menu.
- See page 39 for a list of abbreviations of the available languages and their meaning.
- The Subtitle settings are not saved internally. When you switch off the DVD Changer or open the disc tray, the DV-C501 returns to the default settings. See page 34.
- When you select an option that is not available on the selected DVD video disc, the DV-C501 ignores your setting and goes on using the previously selected language, etc.

Using The On-Screen Display Functions

Information about a disc and its operational status can be monitored on your TV screen. If you want to take advantage of this feature for audio CDs, please remember to connect the DV-C501 to your TV set (see pages 10 and 11) and to switch it on. Please note that the information provided on screen is only for reference purposes and cannot be changed.

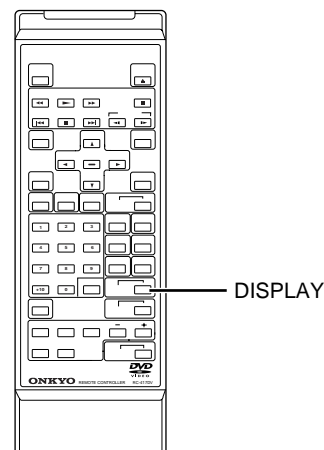

Requesting Basic Information

This operation allows you to view the current title number, track number, and total playing time of the disc on the TV screen.

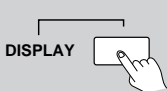

Stop playback and press the **DISPLAY** button.

Each time you press the DISPLAY button, the on-screen display changes as follows:

DVD video disc

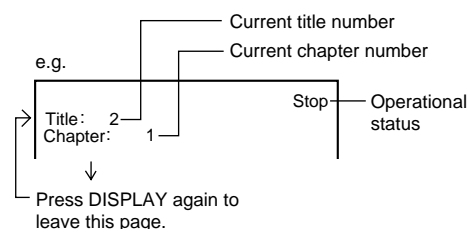

VIDEO CD/Audio CD

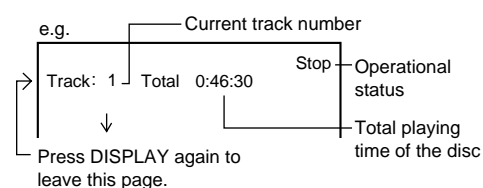

Tip:

When you play a disc that contains text data, the unit displays text information, such as the disc title and song titles. If the disc does not contain any text, the unit displays "No Text".

More Specific Information: Remaining Time and Setting Status

You can also view the elapsed time, remaining time, and setting status of the disc on the TV screen. Though the operation is almost exactly the same as for requesting general information, please note that you need to start playback before being able to access this information.

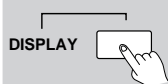

Press the **DISPLAY** button during playback.

Each time you press the DISPLAY button, the on-screen display changes as follows.

DVD video disc

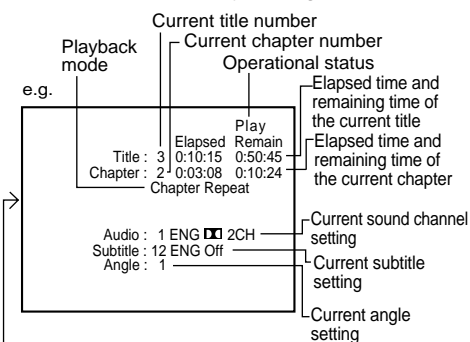

See page 39 for a list of abbreviations of the languages.



Bit Rate (Mbit/sec): Amount of picture, sound and subtitle data on the DVD video disc transferred per second. The larger the value, the more data need to be processed. Please note that the amount of data provides no information about the picture quality.

Press DISPLAY again to leave this page.

VIDEO CD/ Audio CD

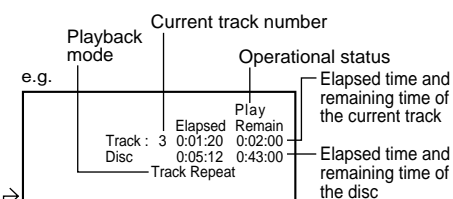

Advanced Settings

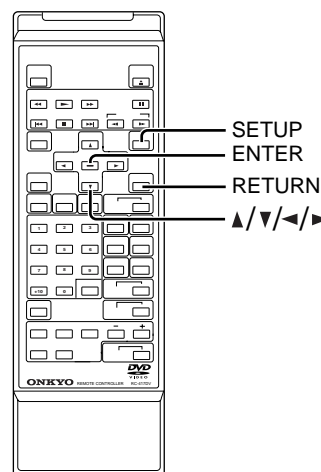

The DV-C501 contains a lot more functions than have been covered so far. Most of these functions can only be accessed via the on-screen menu. Please note that not all available functions apply to all disc types supported by the DV-C501. Setting the language, for instance, has no effect for audio CDs.

Setting Procedure

<p>1</p>	<p>Switch on your TV set.</p>	<p>3</p>	<p>Use the ▲ / ▼ buttons to choose a function below the selected icon, and confirm by pressing the ENTER button.</p>
<p>2</p>	<p>Stop playback and press the SETUP button.</p> <p>The following on-screen menu appears:</p>		
<p>3</p> 	<p>Use the ◀ / ▶ buttons to select the menu heading (icon) that provides access to the desired function.</p> <p>See the next page for an overview of the available functions. Here is what the icons stand for:</p> <p>Language-related settings.</p> <p>Picture-related settings.</p> <p>Audio output settings.</p> <p>Settings related to the on-screen menu function.</p> <p>General utility settings.</p>	<p>4</p>	<p>Enter the desired value with the ▲ / ▼ buttons and confirm by pressing the ENTER button.</p> <p>For the OPERATION function, you will also need the ◀ / ▶ buttons. The exact procedure will be explained in that section.</p>
<p>5</p>			<p>Repeat steps 4 and 5 to change other settings.</p>
<p>6</p>			<p>Press the SETUP button to switch off the on-screen menu.</p> <p>Press the RETURN button to return to the previous display.</p>

Notes:

- Though the SETUP button may also work during normal playback, certain functions may not be accessible. In that case, a warning message is displayed. Stop playback and press SETUP again to be able to select the desired function.



Setting		Details	Page
On-Screen Language	DVD VCD CD	Allows you to select the language of the on-screen displays.	34
Disc Menu Language	DVD	Allows you to select the language to be used by the disc menus (menus included on the discs you are playing back).	34
Audio Language	DVD	Allows you to select the sound track language.	34
Subtitle Language	DVD	Allows you to select the subtitle language.	35



TV Shape	DVD	Allows you to adapt the picture size to the aspect ratio of your TV.	35
Black Level	DVD VCD	Allows you to set the "blackness" of the screen.	35
PAL/Auto*	DVD	Allows you to select the video system of a disc.	35



Audio Out Select	DVD VCD CD	Allows you to select the audio outputs (digital or analog) and/or the output format of the digital audio data.	36
Dynamic Range Control	DVD	Allows you to reduce the dynamic range of the audio data (i.e. to reduce the difference between loud and soft sounds).	36
Karaoke Vocal	DVD	Allows you to switch on or mute the vocal track of a DVD Karaoke disc.	36
Extended Audio Features	DVD	Allows you to activate or mute the Extended Audio track for visually impaired persons.	36



On-Screen Displays	DVD VCD CD	Allows you to decide against having the operation status icons displayed on the TV screen.	37
OSD Background Color	DVD VCD CD	Allows you to select the background color for on-screen displays.	37
Extended Subtitle Features	DVD	Allows you to activate or switch off special subtitles for hearing-impaired persons.	37
Screen Saver	DVD VCD	Allows you to switch on or off the screen saver function.	37



Pause/Still	DVD	Allows you to select the resolution of still pictures. (Field/Frame)	37
Parental Lock	DVD	Allows you to set on or switch off the Parental Lock function.	37
Title Stop	DVD	Allows you to switch on or off a feature that automatically stops playback after a Title is finished.	38
PBC	VCD	To select to playback a PBC- controllable video CD.	38

*U.S. and Canadian models do not support the advanced setting function.

Advanced Settings (continued)

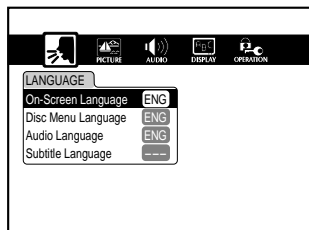

LANGUAGE Functions

On-Screen Language

This function allows you to select the language for the on-screen displays.

- | | |
|--|---|
| U.S. & Canadian models | Other area models |
| <ul style="list-style-type: none"> • English • French • Spanish | <ul style="list-style-type: none"> • English • French • German • Spanish • Italian |

Disc Menu Language

This function allows you to select the language used by the disc menus. Note that you can only select a language supported by the DVD video disc in question.

- | | |
|---|--|
| U.S. & Canadian models | Other area models |
| <ul style="list-style-type: none"> • English • French • Spanish • Others* | <ul style="list-style-type: none"> • English • French • German • Spanish • Italian • Others* |

- *Others : To select another language than the above, proceed as follows:
- a) Press the ENTER button.
 - b) See the list on page 39 for the abbreviation of the desired language.
 - c) Enter the first character of the abbreviation with the ▲ / ▼ buttons (see the Code field).
 - d) Move the cursor to the second position and use ▲ / ▼ for entering the second character of the abbreviation.

U.S. & Canadian models

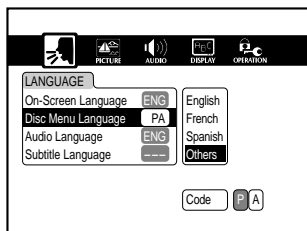

Other area models

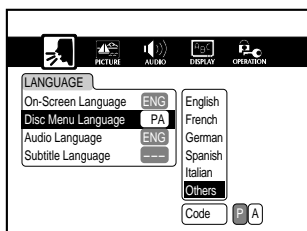

- e) Press the ENTER button.

Note:

Some DVD video discs may not include the desired language. In that case, the DVD Changer automatically switches to the disc's default disc menu language.

Audio Language

If the DVD video disc you are playing back contains multilingual soundtracks, Audio Language allows you to select the desired language.

- | | |
|---|--|
| U.S. & Canadian models | Other area models |
| <ul style="list-style-type: none"> • English • French • Spanish • Others* | <ul style="list-style-type: none"> • English • French • German • Spanish • Italian • Others* |

*Others : To select another language than the above, see steps (a) – (e) under “Disc Menu Language”.

U.S. & Canadian models

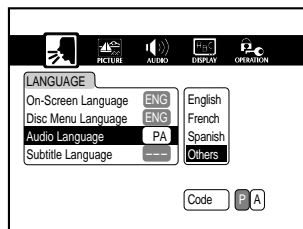

Other area models

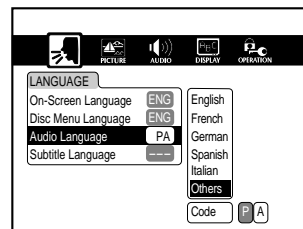

Note:

Some DVD video discs could be played back in a different language than the one you selected. This is usually due to the fact that the disc contains a preset language selection.

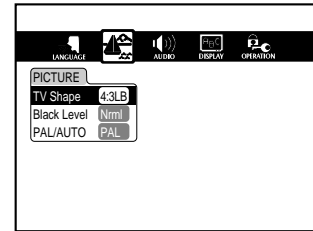

PICTURE Settings

Subtitle Language

Use this function to select the subtitle language, or to switch the subtitles off altogether.

U.S. & Canadian models

- English
- French
- Spanish
- No Subtitle (subtitles are switched off)
- Others: To select another language than the above, see steps (a) – (e) under “Disc Menu Language”.

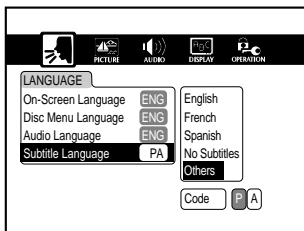

Other area models

- English
- French
- German
- No Subtitle (subtitles are switched off)
- Others: To select another language than the above, see steps (a) – (e) under “Disc Menu Language”.

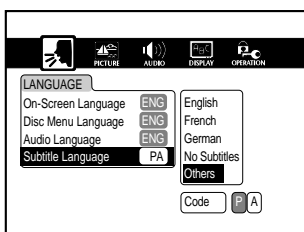

Notes:

- If DVD video disc contains a preset subtitle language setting, your selection is ignored.
- Some DVD video discs allow you to change the subtitle language only via the disc menu. If so, press the MENU button and choose the desired subtitle language from the disc menu.

TV Shape

This is where you can specify the shape of your TV screen. This is important for determining whether you would like to see the whole picture, or a slightly bigger version.

4:3 Letterbox:

Select this setting if you own a standard 4:3 TV set and want to see the whole picture. In that case, masking bars are inserted above and below the picture.



4:3 Normal:

Select this setting for a standard 4:3 TV set if you want the picture to fill the entire screen. In that case, the left and right borders may fall outside the screen's scope.



16:9 Widescreen:

Select this setting for a 16:9 wide-screen TV.

Notes:

- The picture size is preset on the DVD video disc. Therefore, the playback picture may not conform to the picture size you select.
- When you play DVD video discs that only contain 4:3 picture size information, any other TV Shape setting you may select is ignored.
- If you select “16:9 Widescreen” while your TV set is equipped with a 4:3 screen, the picture will be horizontally distorted (compressed) during playback. Always set the TV Shape function according to the TV set you are using.

Black Level

This function allows you to optimize the black picture content (true black instead of dark gray), and hence the video quality.

U.S. & Canadian models

- Enhanced:** Enhanced black level. (0 IRE)
- Normal:** Standard black level. (7.5 IRE)

Other area models

- Normal:** Standard black level (0 IRE)
- Light:** Brighter than in “Normal” (7.5 IRE)

PAL/Auto*

PAL: Choose this option when you wish to watch DVD video discs in the PAL video format. This requires that you connect the DVD Changer to a PAL television set.

Auto: The DVD Changer automatically selects either the PAL or the NTSC video system depending on the format used by the DVD video disc you are playing back. Choose this option if your television set is of the multisystem type (PAL/NTSC compatible).
If the DVD video disc contains some footage in the PAL format and other scenes in the NTSC system, the image may briefly distort while the DVD Changer switches to the appropriate format.

* U.S. and Canadian models do not support the advanced setting function.

Advanced Settings (continued)

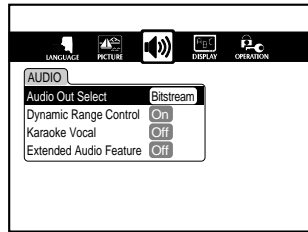

AUDIO Settings

Audio Out Select

This function allows you to select the outputs and format for audio playback. Always select the setting that best matches your amplifier's capabilities and input connectors. The "Bitstream" and "PCM" options refer to the DV-C501's digital outputs. See also "Other Audio Playback Options" on page 12.

Bitstream: Select this option if your amplifier is equipped with a digital input (optical or coaxial) and a Dolby Digital, DTS, MPEG1, or MPEG2 decoder. The DV-C501 outputs digital audio information in the Bitstream format when you play back a DVD video disc with Dolby Digital, DTS, MPEG1, or MPEG2 encoding.

Analog2Ch: Select this option if the DV-C501 is connected to the audio inputs of your TV set, or an analog input pair of your external amplifier. Note that even this analog connection may allow you to take advantage of the amplifier's Dolby Pro Logic processor.

PCM: Select this option if the DV-C501 is connected to a digital input of your amplifier and if you would like the sound to be played back in stereo (e.g. for audio CDs). If you select "PCM", the audio data of DVD video discs with Dolby Digital, MPEG1, or MPEG2 encoding is automatically converted to 2-channel PCM, so that you lose the surround information. See also the table on page 29.

Dynamic Range Control

Dynamic Range Control allows you to "compress" the dynamic range of a DVD's sound track, so that you can lower the volume without losing extremely soft signals. This is especially useful when you are watching a movie late at night.

Off: The full dynamic range is maintained.

On: Low-level signals are slightly boosted so as to remain audible at a low volume setting.

Notes:

- This function is only available during playback of Dolby Digital-encoded DVD video discs.
- The degree of dynamic range reduction may differ depending on the DVD video disc.

Karaoke Vocal

DVD Karaoke discs sometimes also contain a vocal track you probably don't need for Karaoke applications. That is why the DV-C501 allows you to switch the lead vocal off.

Off: The lead vocal track is muted.

On: If available on the selected DVD Karaoke disc, the lead vocal track is output.

Notes:

- The Karaoke Vocal feature is only available during playback of Dolby Digital-encoded (multi-channel) DVD Karaoke discs.
- For optimum Karaoke enjoyment, be sure to use appropriate audio equipment, such as an external amplifier.

Extended Audio Feature

Some DVD video discs contain a special track that describes the on-screen actions for visually impaired persons. Your DV-C501 is set to automatically output this track if available. If this is not necessary, switch this function off.

Off: The Extended Audio Feature track is muted.

On: The Extended Audio Feature is active.

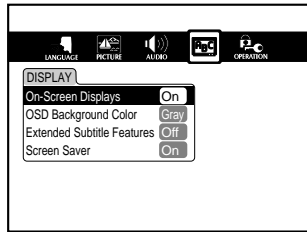
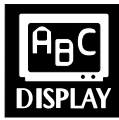

DISPLAY Settings

On-Screen Displays

This function allows you to activate or suppress the display of on-screen icons that inform you about the operational status.

Off: Operational icons or messages (e.g. "Play", "⏸") are not displayed.

On: Operational icons or messages (e.g. "Play", "⏸") are displayed on-screen.

OSD Background Color

This function allows you to select the background color for the on-screen menu.

Blue: Blue background.

Gray: Gray background.

Extended Subtitle Features

Some DVD video discs contain special subtitles, an enhancement of closed captioning for hearing-impaired persons. The DVD Changer automatically displays these special subtitles.

Off: The special subtitles are not displayed.

On: The special subtitles are displayed.

Screen Saver

The screen saver function protects your TV screen from burn-in of images that are displayed for too long. If you also work with a computer, you probably know how it works. The screen saver is especially useful if you often use the Pause ("still") function and tend to forget to switch it off. See page 16.

Off: The screen saver will not blank out the screen after the delay time has elapsed.

On: The screen saver will come on whenever necessary.

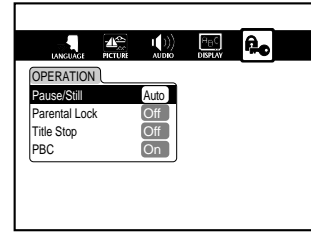

OPERATION Settings

Pause/Still

This function allows you to obtain an even better quality for still pictures. Such pictures are displayed when you pause playback of a DVD video disc. See also page 16.

Auto: For normal use. The image quality should be sufficient for most applications.

Frame: Still pictures are clearer thanks to a higher resolution.

Parental Lock

DVD video discs equipped with the Parental Lock function allow you to decide what exactly can be viewed on your DV-C501, which is especially useful if you have children. For example: you could select a level where violent scenes unsuitable for children are skipped and replaced with more suitable scenes, or prevent playback of a disc altogether. Whether the Parental Lock function actually works depends on the DVD video disc in question, because it needs to contain the software capable of responding to this function. Parental Lock is secured by means of a 4-digit code to avoid that your children bypass this function.

Ask your dealer or rental service for details about the Parental Lock support of a given DVD video disc. Also note that the meaning of the Parental Lock levels depends on the country whose rating standards are used by the DVD video disc.

Off: The Parental Lock feature is not active. To select the "Off" setting, perform steps 1 and 2 below.

On: Switching on Parental Lock involves specifying the highest level that can be viewed. You cannot just switch this function on without selecting a level. Careful: if you only carry out steps 1 and 2, Parental Lock will be switched off. Be sure to perform steps 1 – 4 below.

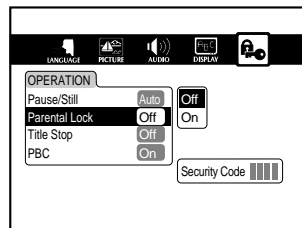

1. Press the ENTER button.

2. Enter the 4-digit code via the numeric buttons on the remote controller, and press the ENTER button. If you entered the wrong code, press the CLEAR button before pressing ENTER, and enter your 4-digit code again.

Advanced Settings (continued)

OPERATION Settings (continued)

3. Press the ◀ / ▶ buttons to select the country whose standards were used to rate the DVD video disc.

See the information supplied with the DVD for details.

U.S. & Canadian models

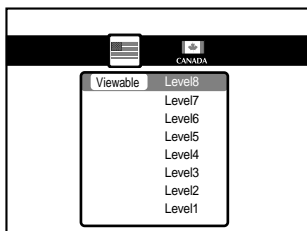

Other area models

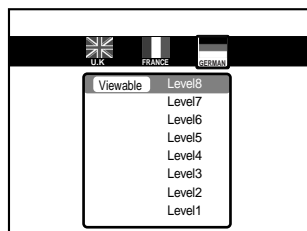

4. Press the ▲ / ▼ buttons to select the Parental Lock level, then press the ENTER button.

U.S. & Canadian models

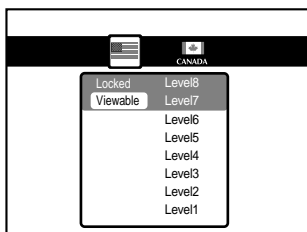

Other area models

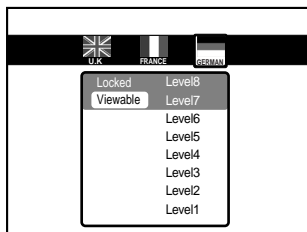

It is now impossible to play back DVD video discs rated higher than the selected level. For example, when you select level 7 (“Viewable”), discs rated higher than level 7 (“Locked”) and cannot be played back.

The Parental Lock level is equivalent to the following USA movie ratings:

Level 7: NC-17

Level 6: R

Level 4: PG 13

Level 3: PG

Level 1: G

The parental lock levels for “Canada” are included for future use. Since they are different from the US ratings, carefully check what they correspond to before buying new DVD video discs with the Canadian Parental Lock system as they become available.

■ Changing the Parental Lock level

Perform steps 2 – 4 above.

■ Changing the 4-digit Code

- a) After selecting a level or “Off,” press the STOP button four times, followed by the ENTER button.



The current 4-digit code is cleared.

- b) Press the numeric buttons to enter a new 4-digit security code.
c) Press the ENTER button.
Be sure to either memorize this code or to write down and store it in a safe place.

Title Stop

This function allows you to specify what happens when the DV-C501 reaches the end of a DVD Title.

- Off:** The DV-C501 continues after playback of a Title is completed. Selecting this option also changes the behavior of the DOWN ◀◀ and UP ▶▶ buttons. See “Selecting the Next/Previous Chapter or Track” on page 19.

- On:** The DV-C501 stops after playback of a title is completed.

PBC (Playback Control)

- Off:** The menu screen of the selected Video CD (if available) is not displayed.

- On:** The menu screen of a Video CD with PBC functionality is displayed on screen.

Table of Languages

Table of Languages and Their Abbreviations

Abbreviation of the Language	Language	Abbreviation of the Language	Language	Abbreviation of the Language	Language	Abbreviation of the Language	Language
—	No alternate language	EO	Esperanto	LN	Lingala	SL	Slovenian
CHI (ZH)	Chinese	ET	Estonian	LO	Laotian	SM	Samoan
DUT (NL)	Dutch	EU	Basque	LT	Lithuanian	SN	Shona
ENG (EN)	English	FA	Persian	LV	Latvian, Lettish	SO	Somali
FRE (FR)	French	FI	Finnish	MG	Malagasy	SQ	Albanian
GER (DE)	German	FJ	Fiji	MI	Maori	SR	Serbian
ITA (IT)	Italian	FO	Faroese	MK	Macedonian	SS	Siswati
JPN (JA)	Japanese	FY	Frisian	ML	Malayalam	ST	Sesotho
KOR (KO)	Korean	GA	Irish	MN	Mongolian	SU	Sudanese
MAY (MS)	Malay	GD	Scottish Gaelic	MO	Moldavian	SV	Swedish
SPA (ES)	Spanish	GL	Galician	MR	Marathi	SW	Swahili
AA	Afar	GN	Guarani	MT	Maltese	TA	Tamil
AB	Abkhazian	GU	Gujarati	MY	Burmese	TE	Telugu
AF	Afrikaans	HA	Hausa	NA	Nauru	TG	Tajik
AM	Amharic	HI	Hindi	NE	Nepali	TH	Thai
AR	Arabic	HR	Croatian	NO	Norwegian	TI	Tigrinya
AS	Assamese	HU	Hungarian	OC	Occitan	TK	Turkmen
AY	Aymara	HY	Armenian	OM	(Afan) Oromo	TL	Tagalog
AZ	Azerbaijani	IA	Interlingua	OR	Oriya	TN	Setswana
BA	Bashkir	IE	Interlingue	PA	Panjabi	TO	Tongan
BE	Belorussian	IK	Inupiak	PL	Polish	TR	Turkish
BE	Belorussian	IN	Indonesian	PS	Pashto, Pushto	TS	Tsonga
BG	Bulgarian	IS	Icelandic	PT	Portuguese	TT	Tatar
BH	Bihari	IW	Hebrew	QU	Quechua	TW	Twi
BI	Bislama	JI	Yiddish	RM	Rhaeto-Romance	UK	Ukrainian
BN	Bengali, Bangla	JW	Javanese	RN	Kirundi	UR	Urdu
BO	Tibetan	KA	Georgian	RO	Romanian	UZ	Uzbek
BR	Breton	KK	Kazakh	RU	Russian	VI	Vietnamese
CA	Catalan	KL	Greenlandic	RW	Kinyarwanda	VO	Volapük
CO	Corsican	KM	Cambodian	SA	Sanskrit	WO	Wolof
CS	Czech	KN	Kannada	SD	Sindhi	XH	Xhosa
CY	Welsh	KS	Kashmiri	SG	Sango	YO	Yoruba
DA	Danish	KU	Kurdish	SH	Serbo-Croatian	ZU	Zulu
DZ	Bhutani	KY	Kirghiz	SI	Singhalese		
EL	Greek	LA	Latin	SK	Slovak		

Troubleshooting

If your DV-C501 does not seem to work as expected, check the following table for the possible cause before contacting your ONKYO dealer or service.

Symptoms and Corrections

Symptom	Cause	Correction	Page
No power.	<ul style="list-style-type: none"> The power plug is disconnected. 	<ul style="list-style-type: none"> Insert the power plug firmly. 	10, 11
No picture.	<ul style="list-style-type: none"> The TV is not set to receive DVD signal output. 	<ul style="list-style-type: none"> Select the appropriate video input mode on the TV so that the DV-C501's picture appears on the TV screen. 	14
	<ul style="list-style-type: none"> The video cable is not securely connected. 	<ul style="list-style-type: none"> Connect the video cable into the jacks securely. 	10-13
No sound.	<ul style="list-style-type: none"> The DV-C501 has not been selected as input source on the amplifier or receiver. 	<ul style="list-style-type: none"> Select the input source on the amplifier or receiver that corresponds to the input(s) the DV-C501 is connected to. 	14
	<ul style="list-style-type: none"> The audio cables are not securely connected. 	<ul style="list-style-type: none"> Connect the audio cable securely. 	10-13
	<ul style="list-style-type: none"> The device you connected the DV-C501's audio outputs to is switched off. 	<ul style="list-style-type: none"> Switch on the amplifier or receiver. 	–
	<ul style="list-style-type: none"> The output sound type setting is not correct. 	<ul style="list-style-type: none"> Select the appropriate audio settings. 	29,32 36
The picture occasionally distorts.	<ul style="list-style-type: none"> The disc is dirty. 	<ul style="list-style-type: none"> Eject the disc and clean it. 	9
	<ul style="list-style-type: none"> The Fast Forward or Fast Reverse function is active. 	<ul style="list-style-type: none"> Sometimes a small amount of picture distortion may be noticeable. This is not a malfunction. 	–
Unstable brightness or picture noise.	<ul style="list-style-type: none"> This is caused by the copy protection signal. 	<ul style="list-style-type: none"> Connect the DV-C501 directly to the TV. Never route its picture signal via a VCR or other video device ("daisy chain"). 	10
The DV-C501 won't start playback.	<ul style="list-style-type: none"> No disc is inserted. 	<ul style="list-style-type: none"> Insert a disc. (Check whether the "DVD", "VCD" or "CD" indicator lights.) 	42
	<ul style="list-style-type: none"> The inserted disc cannot be read. 	<ul style="list-style-type: none"> Insert a playable disc. (Check the disc type and color system.) 	9
	<ul style="list-style-type: none"> The disc is placed upside down. 	<ul style="list-style-type: none"> Insert the disc with the playback side down. 	14
	<ul style="list-style-type: none"> The disc is not placed within the guide. 	<ul style="list-style-type: none"> Place the disc correctly inside the guide. 	14
	<ul style="list-style-type: none"> The disc is dirty. 	<ul style="list-style-type: none"> Clean the disc. 	9
	<ul style="list-style-type: none"> The Parental Lock function is on. 	<ul style="list-style-type: none"> Cancel the Parental Lock function or select another Parental Lock level. 	32,33 37
You hear a voice that describes the action.	<ul style="list-style-type: none"> The DVD video disc contains an Extended Audio Feature track that is being played back. 	<ul style="list-style-type: none"> Switch off the Extended Audio Feature. 	36
The buttons do not work.	<ul style="list-style-type: none"> Power supply fluctuations or other abnormalities such as static electricity may interrupt correct operation. 	<ul style="list-style-type: none"> Turn the power on or off with the POWER button. Or disconnect the power plug and insert it into the wall outlet again. 	–
The remote controller does not work properly.	<ul style="list-style-type: none"> The remote controller is not pointed at the remote sensor of the DVD Changer. 	<ul style="list-style-type: none"> Point the remote controller at the remote sensor of the DVD Changer. 	8
	<ul style="list-style-type: none"> The remote controller is too far from the DVD Changer. 	<ul style="list-style-type: none"> Operate the remote controller within about 5 m. 	8
	<ul style="list-style-type: none"> The batteries in the remote controller are exhausted. 	<ul style="list-style-type: none"> Replace the batteries with new ones. 	8

This unit contains a sensitive microcomputer that, under certain circumstances, might fail to operate due to excessive noise interference. In such case, disconnect the power cord from the wall outlet, wait five seconds and connect the power cord again.

Identification of Controls (continued)

DVD Display

- Pressing of the DIMMER button changes the brightness of the Display.

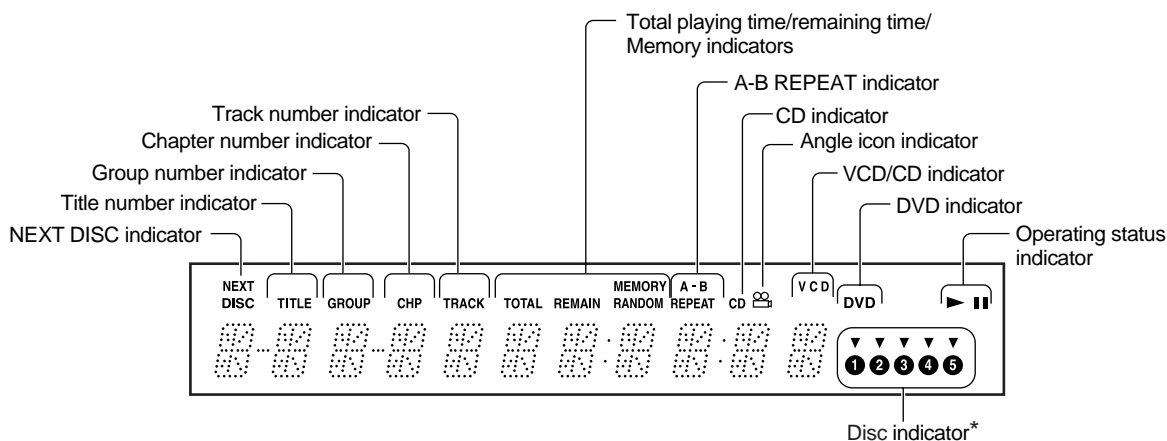
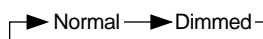

* DISC INDICATORS ATTENTION:

When the tray is closed, the unit will search to play the first disc loaded; all Disc Indicator will be illuminated. As the unit accesses the disc locations the indicators will either go out or stay lit to indicate the presence of a disc. An indicator may stay lit even if there is no disc loaded until the player has accessed that location. This is not malfunction.

■ The indicators vary depending on the kinds of discs you play.

■ DVD Video disc

- When closing the disc tray:
Example

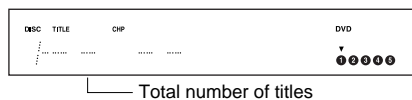

- During playback:
Example

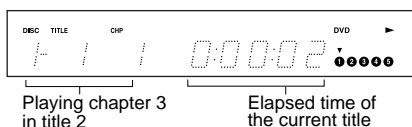

Some DVD video discs may not display the chapter numbers or elapsed time.

■ VIDEO CD

- When closing the disc tray:
Example

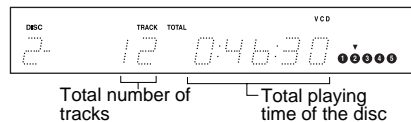

- During playback:
Example

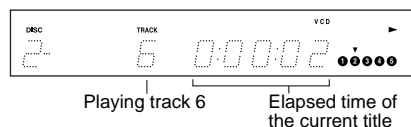

Some VIDEO CDs may not display the track numbers or elapsed time.

■ Audio CD

- When closing the disc tray:
Example

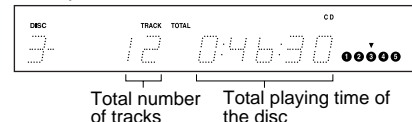

- During playback:
Example

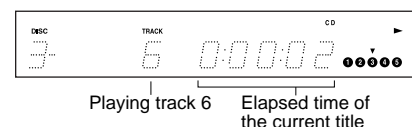

Most steps in this manual need to be performed using the supplied remote controller. That is why the functions of the remote controller's buttons are explained in the relative chapters and sections. See the pages in [] for details.

Remote Controller

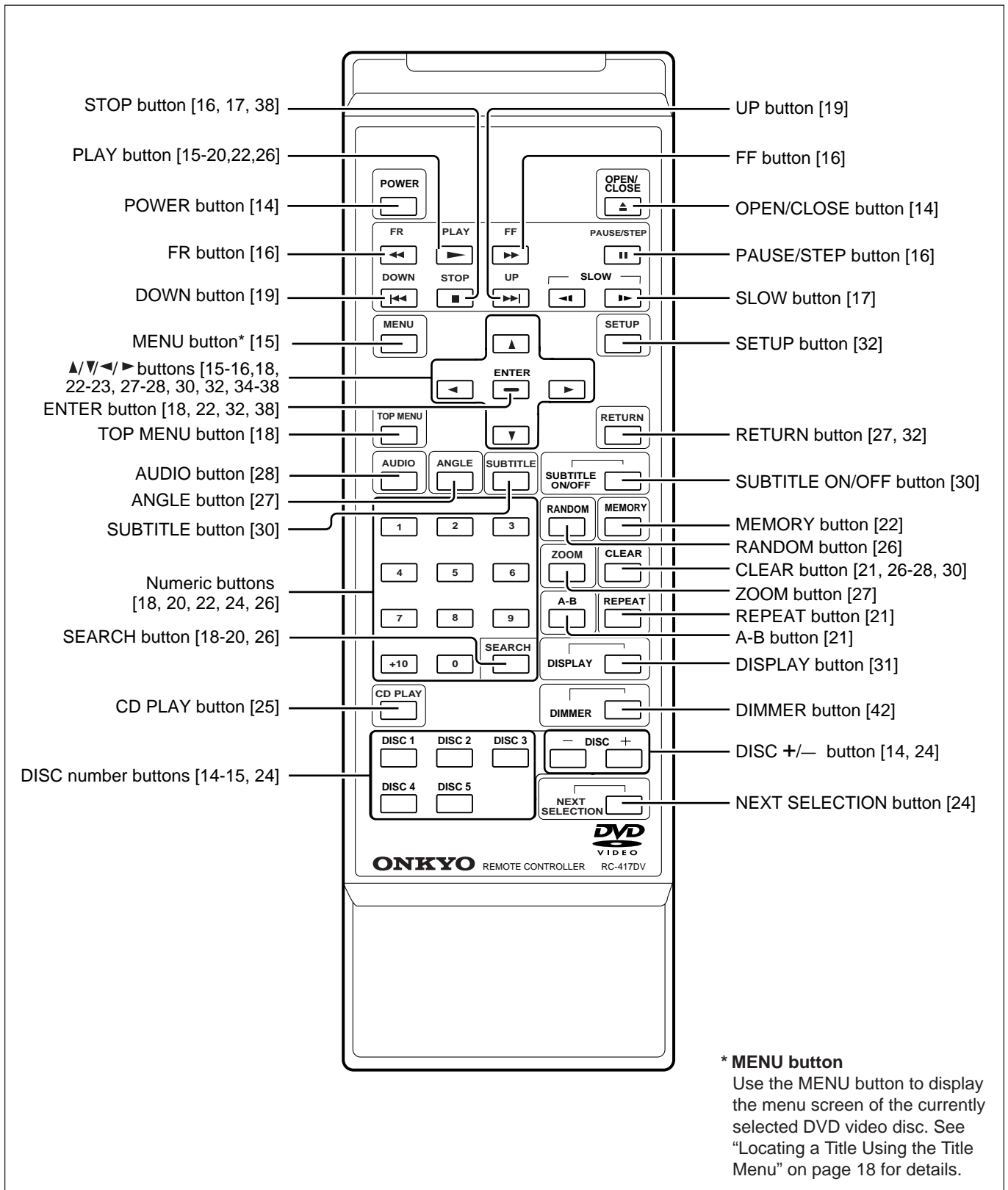

Specifications

DVD Changer/Outputs

DVD Changer

Power supply	AC 120 V, 60 Hz (U.S. & Canadian models) AC 100 – 240 V, 50/60 Hz (Other area models)
Power consumption	19 W
Weight	6.6 kg, 14.6 lbs
External dimensions (W/H/D)	435 X 121 X 400 mm, 17-1/8" X 4-3/4" X 15-3/4"
Signal system	Standard NTSC (U.S. & Canadian models) PAL/3.58 NTSC (Other area models)
Laser	Semiconductor laser, wavelength 650 nm
Frequency range (digital audio)	DVD linear sound : 48 kHz sampling 4 Hz to 22 kHz 96 kHz sampling 4 Hz to 44 kHz Audio CD : 4 Hz to 20 kHz
Signal-to-noise ratio (digital audio)	More than 96 dB (EIAJ)
Audio dynamic range (digital audio)	More than 90 dB (EIAJ)
Harmonic distortion (digital audio)	Less than 0.01 %
Wow and flutter	Below measurable level (less than ± 0.001 % (W.PEAK)) (EIAJ)
Operating conditions	Temperature: 5°C to 35°C (41 to 95 degrees), Operation status: Horizontal

Outputs

Video output	1.0 V (p-p), 75 Ω , negative sync., pin jack X 1
S video output	(Y) 1.0 V (p-p), 75 Ω , negative sync., Mini DIN 4-pin X 1 (C) 0.286 V (p-p), 75 Ω
Component Video output	(Y) 1.0 V (p-p), 75 Ω , negative sync., pin jack X 1 (P _B)/(P _R) 0.7 V (p-p), 75 Ω
Digital Audio output (optical)	Optical connector X 1
Digital Audio output (coaxial)	0.5 V (p-p), 75 Ω , pin jack X 1
Audio output (analog audio)	2.0 V (rms), 470 Ω , pin jack (L, R) X 1

- Design and specifications are subject to change without notice.

ONKYO CORPORATION

Sales & Product Planning Div. : 2-1, Nisshin-cho, Neyagawa-shi, OSAKA 572-8540, JAPAN
Tel: 072-831-8111 Fax: 072-833-5222

ONKYO U.S.A. CORPORATION

200 Williams Drive, Ramesy, N.J. 07446, U.S.A.
Tel: 201-825-7950 Fax: 201-825-8150 E-mail: onkyo@onkyousa.com

ONKYO EUROPE ELECTRONICS GmbH

Industriestrasse 20, 82110 Germering, GERMANY
Tel: 089-849-320 Fax: 089-849-3265 E-mail: info@onkyo.de

ONKYO CHINA LIMITED

Units 2102-2107, Metroplaza Tower I, 223 Hing Fong Road, Kwai Chung,
N.T., HONG KONG Tel: 852-2429-3118 Fax: 852-2428-9039



Free Manuals Download Website

<http://myh66.com>

<http://usermanuals.us>

<http://www.somanuals.com>

<http://www.4manuals.cc>

<http://www.manual-lib.com>

<http://www.404manual.com>

<http://www.luxmanual.com>

<http://aubethermostatmanual.com>

Golf course search by state

<http://golfingnear.com>

Email search by domain

<http://emailbydomain.com>

Auto manuals search

<http://auto.somanuals.com>

TV manuals search

<http://tv.somanuals.com>