

DX-C380

Compact Disc Changer

Instruction Manual

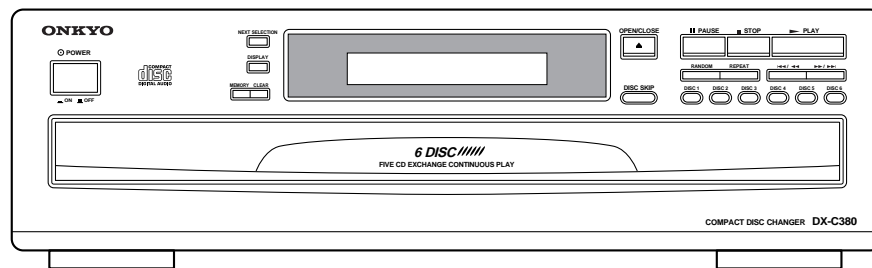

Thank you for purchasing the Onkyo Compact Disc Changer.

Please read this manual thoroughly before making connections and plugging in the unit.

Following the instructions in this manual will enable you to obtain optimum performance and listening enjoyment from your new Compact Disc Changer.

Please retain this manual for future reference.

CONTENTS

Important Safeguards	2	System Connections	7
Precautions	3	Playing CDs	8
Features	4	Using memory functions	14
Control positions and names	5	Troubleshooting Guide	16
Supplied accessories	5	Specifications	16
Remote controller	6		

WARNING:

TO REDUCE THE RISK OF FIRE OR ELECTRIC SHOCK, DO NOT EXPOSE THIS APPLIANCE TO RAIN OR MOISTURE.

CAUTION:

TO REDUCE THE RISK OF ELECTRIC SHOCK, DO NOT REMOVE COVER (OR BACK). NO USER-SERVICEABLE PARTS INSIDE. REFER SERVICING TO QUALIFIED SERVICE PERSONNEL.



WARNING
RISK OF ELECTRIC SHOCK
DO NOT OPEN

AVIS
RISQUE DE CHOC ELECTRIQUE
NE PAS OUVRIR



The lightning flash with arrowhead symbol, within an equilateral triangle, is intended to alert the user to the presence of uninsulated "dangerous voltage" within the product's enclosure that may be of sufficient magnitude to constitute a risk of electric shock to persons.



The exclamation point within an equilateral triangle is intended to alert the user to the presence of important operating and maintenance (servicing) instructions in the literature accompanying the appliance.

Important Safeguards

- Read Instructions** – All the safety and operating instructions should be read before the appliance is operated.
- Retain Instructions** – The safety and operating instructions should be retained for future reference.
- Heed Warnings** – All warnings on the appliance and in the operating instructions should be adhered to.
- Follow Instructions** – All operating and use instructions should be followed.
- Water and Moisture** – The appliance should not be used near water – for example, near a bathtub, washbowl, kitchen sink, laundry tub, in a wet basement, or near a swimming pool, and the like.
- Carts and Stands** – The appliance should be used only with a cart or stand that is recommended by the manufacturer.

PORTABLE CART WARNING



S3125A
- 6A. An appliance and cart combination should be moved with care.** Quick stops, excessive force, and uneven surfaces may cause the appliance and cart combination to overturn.
- Wall or Ceiling Mounting** – The appliance should be mounted to a wall or ceiling only as recommended by the manufacturer.
- Ventilation** – The appliance should be situated so that its location or position does not interfere with its proper ventilation. For example, the appliance should not be situated on a bed, sofa, rug, or similar surface that may block the ventilation openings; or if placed in a built-in installation, such as a bookcase or cabinet that may impede the flow of air through the ventilation openings, there should be free space of at least 5 cm (2 in.) and an opening behind the appliance.
- Heat** – The appliance should be situated away from heat sources such as radiators, heat registers, stoves, or other appliances (including amplifiers) that produce heat.
- Power Sources** – The appliance should be connected to a power supply only of the type described in the operating instructions or as marked on the appliance.
- Polarization** – If the appliance is provided with a polarized plug having one blade wider than the other, please read the following information:
The polarization of the plug is a safety feature. The polarized plug will only fit the outlet one way. If the plug does not fit fully into the outlet, try reversing it. If there is still trouble, the user should seek the services of a qualified electrician. Under no circumstances should the user attempt to defeat the polarization of the plug.
- Power-Cord Protection** – Power-supply cords should be routed so that they are not likely to be walked on or pinched by items placed upon or against them, especially near plugs, convenience receptacles, and the point where they exit from the appliance.
- Cleaning** – The appliance should be cleaned only as recommended by the manufacturer.
- Nonuse Periods** – The power cord of the appliance should be unplugged from the outlet when left unused for a long period of time.
- Object and Liquid Entry** – Care should be taken so that objects do not fall and liquids are not spilled into the enclosure through openings.
- Damage Requiring Service** – The appliance should be serviced by qualified service personnel when:
 - The power-supply cord or the plug has been damaged; or
 - Objects have fallen, or liquid has been spilled into the appliance; or
 - The appliance has been exposed to rain; or
 - The appliance does not appear to operate normally or exhibits a marked change in performance; or
 - The appliance has been dropped, or the enclosure damaged.
- Servicing** – The user should not attempt to service the appliance beyond that described in the operating instructions. All other servicing should be referred to qualified service personnel.

This unit contains a semiconductor laser system and is classified as a "CLASS 1 LASER PRODUCT". So, to use this model properly, read this Instruction Manual carefully. In case of any trouble, please contact the store where you purchased the unit. To prevent being exposed to the laser beam, do not try to open the enclosure.

DANGER:

INVISIBLE LASER RADIATION WHEN OPEN AND INTER-LOCK FAILED OR DEFEATED. AVOID DIRECT EXPOSURE TO BEAM.

CAUTION:

THIS PRODUCT UTILIZES A LASER. USE OF CONTROLS OR ADJUSTMENTS OR PERFORMANCE OF PROCEDURES OTHER THAN THOSE SPECIFIED HEREIN MAY RESULT IN HAZARDOUS RADIATION EXPOSURE.

For European model

This label on the rear panel states that:

- This unit is a CLASS 1 LASER PRODUCT and employs a laser inside the cabinet.
- To prevent the laser from being exposed, do not remove the cover. Refer servicing to qualified personnel.

Precautions

For U.S. model

The laser is covered by a housing which prevents exposure during operation or maintenance. However, this product is classified as a Laser Product by CDRH (Center for Devices and Radiological Health) which is a department of the Food and Drug Administration. According to their regulations 21 CFR section 1002.30, all manufacturers who sell Laser Products must maintain records of written communications between the manufacturer, dealers and customers concerning radiation safety. If you have any complaints about instructions or explanations affecting the use of this product, please feel free to write to the address on the back page of this manual. When you write us, please include the model number and serial number of your unit.

In compliance with Federal Regulations, the certification, identification and the period of manufacture are indicated on the rear panel.

FCC INFORMATION FOR USER

CAUTION:

The user changes or modifications not expressly approved by the party responsible for compliance could void the user's authority to operate the equipment.

NOTE:

This equipment has been tested and found to comply with the limits for a Class B digital device, pursuant to Part 15 of the FCC Rules. These limits are designed to provide reasonable protection against harmful interference in a residential installation. This equipment generates, uses and can radiate radio frequency energy and, if not installed and used in accordance with the instructions, may cause harmful interference to radio communications. However, there is no guarantee that interference will not occur in a particular installation. If this equipment does cause harmful interference to radio or television reception, which can be determined by turning the equipment off and on, the user is encouraged to try to correct the interference by one or more of the following measures:

- Reorient or relocate the receiving antenna.
- Increase the separation between the equipment and receiver.
- Connect the equipment into an outlet on a circuit different from that to which the receiver is connected.
- Consult the dealer or an experienced radio/TV technician for help.

For Canadian model

For models having a power cord with a polarized plug:

CAUTION: TO PREVENT ELECTRIC SHOCK, MATCH WIDE BLADE OF PLUG TO WIDE SLOT, FULLY INSERT.

This Class B digital apparatus complies with Canadian ICES-003.

Modele pour les Canadien

Sur les modèles dont la fiche est polarisée:

ATTENTION: POUR ÉVITER LES CHOCS ÉLECTRIQUES, INTRODUIRE LA LAME LA PLUS LARGE DE LA FICHE DANS LA BORNE CORRESPONDANTE DE LA PRISE ET POUSSER JUSQU'AU FOND.

Cet appareil numérique de la classe B est conforme à la norme NMB-003 du Canada.

For British model

Replacement and mounting of an AC plug on the power supply cord of this unit should be performed only by qualified service personnel.

IMPORTANT

The wires in the mains lead are coloured in accordance with the following code:

Blue : Neutral

Brown : Live

As the colours of the wires in the mains lead of this apparatus may not correspond with the coloured markings identifying the terminals in your plug, proceed as follows:

The wire which is coloured blue must be connected to the terminal which is marked with the letter N or coloured black.

The wire which is coloured brown must be connected to the terminal which is marked with the letter L or coloured red.

IMPORTANT

A 5 amp fuse is fitted in this plug. Should the fuse need to be replaced, please ensure that the replacement fuse has a rating of 5 amps and that it is approved by ASTA or BSI to BS1362. Check for the ASTA mark or the BSI mark on the body of the fuse.

IF THE FITTED MOULDED PLUG IS UNSUITABLE FOR THE SOCKET OUTLET IN YOUR HOME, THEN THE FUSE SHOULD BE REMOVED AND THE PLUG CUT OFF AND DISPOSED OF SAFELY. THERE IS A DANGER OF SEVERE ELECTRICAL SHOCK IF THE CUT OFF PLUG IS INSERTED INTO ANY 13 AMP SOCKET.

If in any doubt, please consult a qualified electrician.

Declaration of Conformity

We, ONKYO EUROPE
ELECTRONICS GmbH
INDUSTRIESTRASSE 20
82110 GERMERING,
GERMANY



declare in own responsibility, that the ONKYO product described in this instruction manual is in compliance with the corresponding technical standards such as EN60065, EN55013, EN55020 and EN61000-3-2, -3-3 (or EN60555-2, -3)

GERMERING, GERMANY

K. OTSU

ONKYO EUROPE ELECTRONICS GmbH

Precautions

1. Warranty Claim

You can find the serial number on the rear panel of this unit. In case of warranty claim, please report this number.

2. Power

WARNING

BEFORE PLUGGING IN THE UNIT FOR THE FIRST TIME, READ THE FOLLOWING SECTION CAREFULLY.

The voltage of the available power supply differs according to country or region. Be sure that the power supply voltage of the area where this unit will be used meets the required voltage (e.g., AC 230 V, 50 Hz or AC 120 V, 60 Hz) written on the rear panel.

3. Do not touch this unit with wet hands

Do not handle this unit or power cord when your hands are wet or damp. If water or any other liquid enters the case, take this unit to an authorized service center for inspection.

4. Location of this unit

Place this unit in a well-ventilated location.

Take special care to provide plenty of ventilation on all sides of this unit especially when it is placed in an audio rack. If ventilation is blocked, this unit may overheat and malfunction.

Do not expose this unit to direct sunlight or heating units as this unit's internal temperature may rise and shorten the life of the pickup.

Avoid damp and dusty places and places directly affected by vibrations from the speakers. In particular, avoid placing the unit on or above one of the speakers.

Be sure this unit is placed in a horizontal position. Never place it on its side or on a slanted surface as it may malfunction.

Do not place near tuners or TV sets.

If placed next to a TV or tuner, it may cause reception interference resulting in some noise in the TV or tuner output.

5. Care

From time to time you should wipe the front and rear panels and the cabinet with a soft cloth. For heavier dirt, dampen a soft cloth in a weak solution of mild detergent and water, wring it out dry, and wipe off the dirt. Following this, dry immediately with a clean cloth.

Do not use rough material, thinners, alcohol or other chemical solvents or cloths since these could damage the finish or remove the panel lettering.

6. Points to remember

If this unit is brought from a cold environment to a warm one or is in a cold room that is quickly heated, condensation may form on the pickup, preventing proper operation. In this case, remove the disc and leave the power ON for about one hour to remove the condensation.

When transporting this unit, be careful not to bump it.

Always close the disc tray when not loading or unloading discs to protect delicate internal parts from dust.

Features

- 6-disc carousel changer
- Up to five discs to be changed without interrupting disc in play
- Next Selection function allows next track or disc to be selected without interrupting current track playing
- Single-bit PWM (Pulse Width Modulation) D/A converter minimizes low-level linearity errors, eliminating loss of detail during quiet passages
- Proprietary AccuPulse Quartz system with Polysorb virtually eliminates the possibility of clock-oscillator timing errors
- 8-times oversampling
- Fixed analog output
- Display visible even when disc tray is out
- Oversized power transformer
- 6-mode repeat: Entire disc, All discs, Random tracks, Programmed tracks, Random memory, Single track
- 3-mode time display: Elapse, Remain, and Total Remain
-  compatible remote control
- Disc Intro Scan function plays the first eight seconds of each disc
- Direct track or disc access via the remote controller
- Optical digital output for direct connection to a DAT, MD, or DSP receiver

Memory Preservation

This unit does not require memory preservation batteries. A built-in memory power back-up system preserves the contents of memory during power failures and even when the POWER switch is set to OFF.

The POWER switch must be set to ON in order to charge the back-up system. The memory preservation period after the unit has been turned off varies depending on climate and placement of the unit. On average, memory contents are protected over a period of a few weeks after the time the unit has been turned off. This period is shorter when the unit is exposed to a very humid climate.

Playable Discs

This CD changer can play back the following discs.

	Disc mark	Contents	Disc size	Maximum playback time
Audio CDs		Audio	12 cm	74 minutes
			8 cm (CD single)	20 minutes

You cannot play back discs other than those listed above.

Avoid using heart-shaped or octagonal discs. Playing irregularly shaped discs may damage the internal mechanism of the CD changer.



Do not use discs on which adhesive from adhesive tape or a disc label (if it is a rental disc) remains. Otherwise, you may not be able to eject the discs or the CD changer may become inoperative.

Control positions and names

Note:

- If there is a protective film on the surface of the display that makes it difficult to read the display, remove it.
- For more information about the buttons and knobs, refer to the pages listed in the brackets ([]) below.

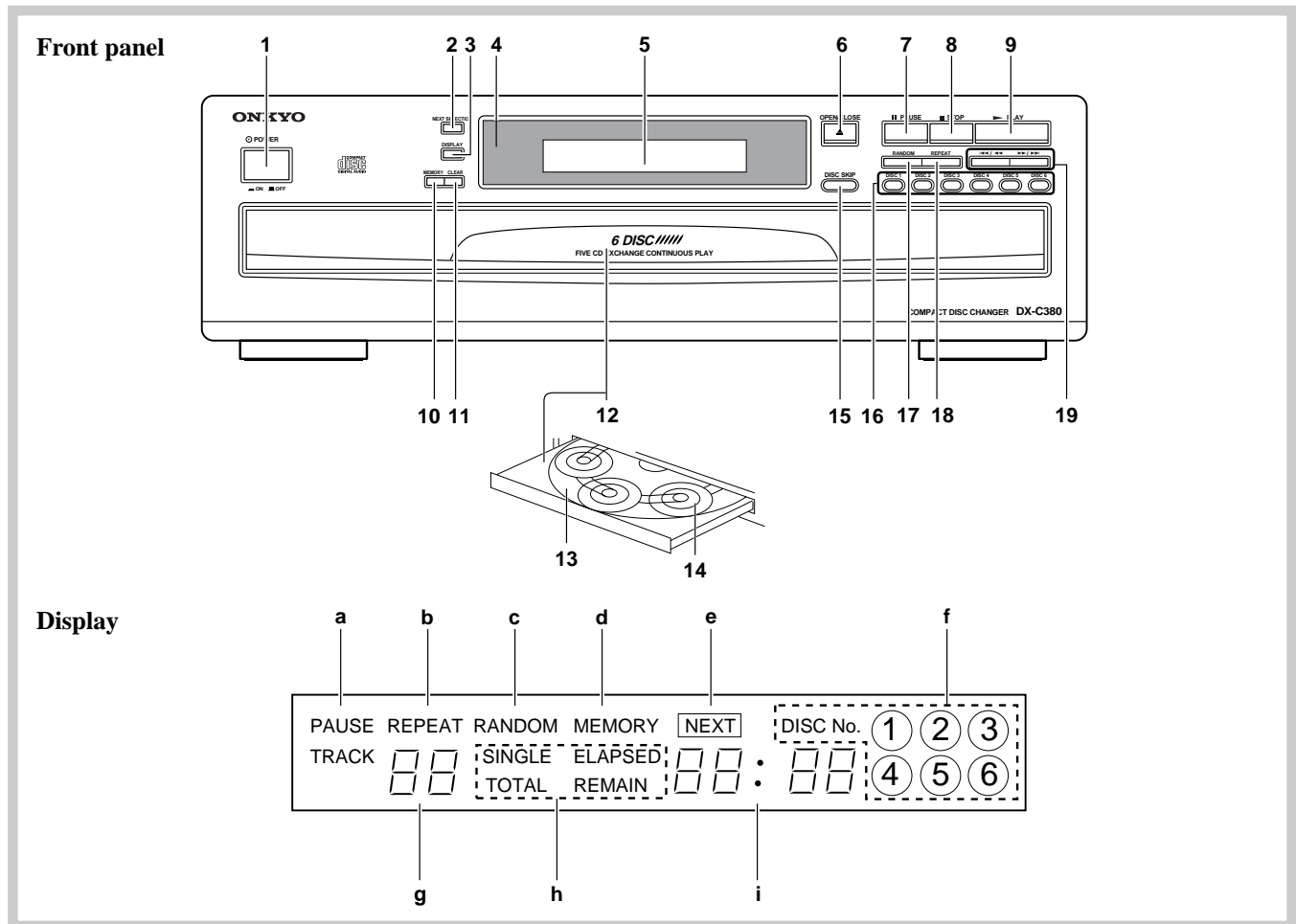

Front panel

- | | |
|-------------------------------|--|
| 1. POWER button [7] | 12. Loading drawer |
| 2. NEXT SELECTION button [12] | 13. Carousel |
| 3. DISPLAY button [9] | 14. Disc trays |
| 4. Remote control sensor [6] | 15. DISC SKIP buttons [8] |
| 5. Display | 16. Direct play buttons
(DISC 1-DISC 6) [10, 12, 14] |
| 6. OPEN/CLOSE button [8] | 17. RANDOM button [13] |
| 7. PAUSE button [9] | 18. REPEAT button [13] |
| 8. STOP button [9, 11] | 19. Search/Skip buttons
(◀◀/▶▶, ▶▶/▶▶) [9~12, 14, 15] |
| 9. PLAY button [8~10, 13, 14] | |
| 10. MEMORY button [14, 15] | |
| 11. CLEAR button [15] | |

Display

- | |
|------------------------------|
| a. PAUSE indicator |
| b. REPEAT indicator |
| c. RANDOM indicator |
| d. MEMORY indicator |
| e. NEXT indicator |
| f. Disc number indicator |
| g. Track number indicator |
| h. ELAPSED/REMAIN indicators |
| i. Time display |

Supplied accessories

Check that the following accessories are supplied with this unit.

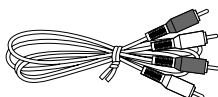

Audio connection cable × 1



RI cable × 1

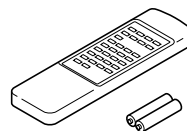

Remote controller (RC-331C) × 1
Batteries (size AA, R6 or UM-3) × 2

Remote controller

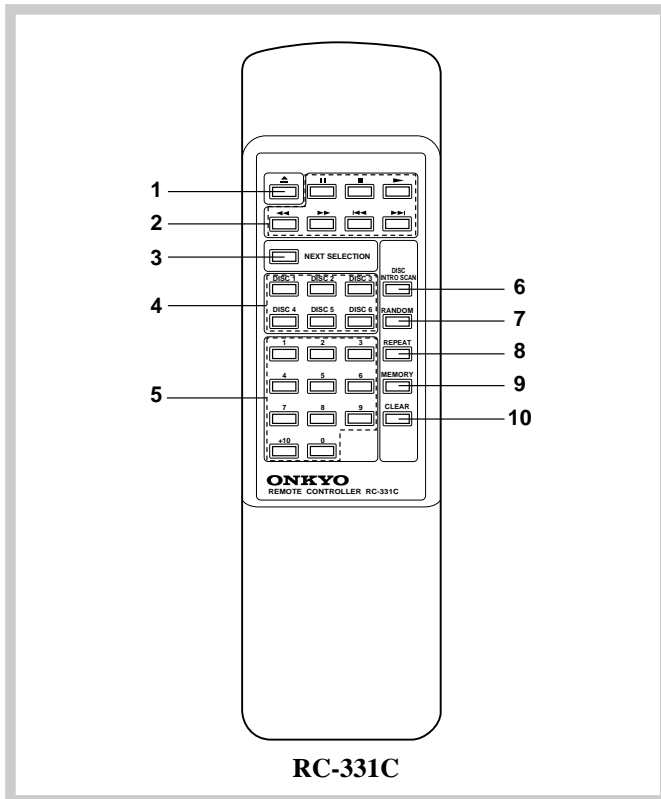

Remote controller

1. **Open/close button** [8]
2. **Operation buttons**
 - : Stop button [9, 11]
 - || : Pause button [9]
 - ▶ : Play button [8~10, 13, 14]
 - ◀▶ : Fast reverse button [9, 15]
 - ▶▶ : Fast forward button [9, 15]
 - ◀◀ : Reverse skip button [11, 14]
 - ▶▶ : Forward skip button [11, 14]
3. **NEXT SELECTION button** [12]
4. **Direct play buttons (DISC 1-DISC 6)** [10, 12, 14]
5. **Number buttons and +10 button** [10, 12, 14]
6. **DISC INTRO SCAN button** [11]
7. **RANDOM button** [13]
8. **REPEAT button** [13]
9. **MEMORY button** [14, 15]
10. **CLEAR button** [15]

Insert the batteries into the remote controller following the illustration below.

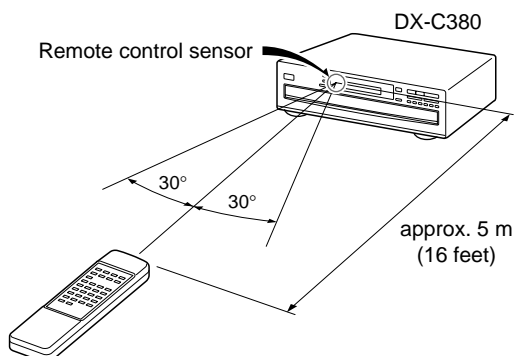
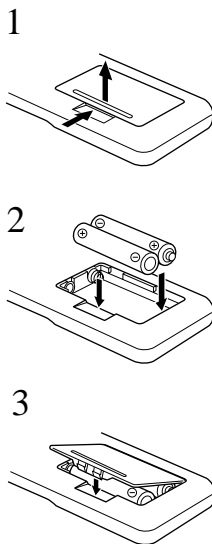

Inserting the remote controller batteries

1. Remove the battery compartment cover by opening it as shown in the illustration.
2. Insert two AA (R6- or UM-3)-size batteries into the battery compartment. Carefully follow the polarity diagram (positive (+) and negative (-) symbols) inside the battery compartment.
3. After batteries are installed and seated correctly, replace the compartment cover.

Notes

- Do not mix new batteries with old batteries or different kinds of batteries.
- To avoid corrosion, remove the batteries if the remote controller is not to be used for a long time.
- Remove dead batteries immediately to avoid damage from corrosion. If the remote controller doesn't operate smoothly, replace both the batteries at the same time.
- The life of the batteries supplied is about six months but this will vary depending on usage.

Using the remote controller

Point the remote controller toward the remote control sensor.

Notes

- Place the unit away from strong light such as direct sunlight or inverted fluorescent light which can prevent proper operation of the remote controller.
- Using another remote controller of the same type in the same room or using the unit near equipment which uses infrared rays may cause operational interference.
- Do not put any object such as a book on the remote controller. The buttons of the remote controller may be pressed by mistake and drain the batteries.
- Make sure the audio rack doors do not have colored glass. Placing the unit behind such doors may prevent proper remote controller operation.
- If there is any obstacle between the remote controller and the remote control sensor, the remote controller will not operate.

System Connections

- Do not plug in the power cord until all connections have been made.
- On each pair of input or output jacks, the jack marked R corresponds to the right channel and the jack marked L corresponds to the left channel.

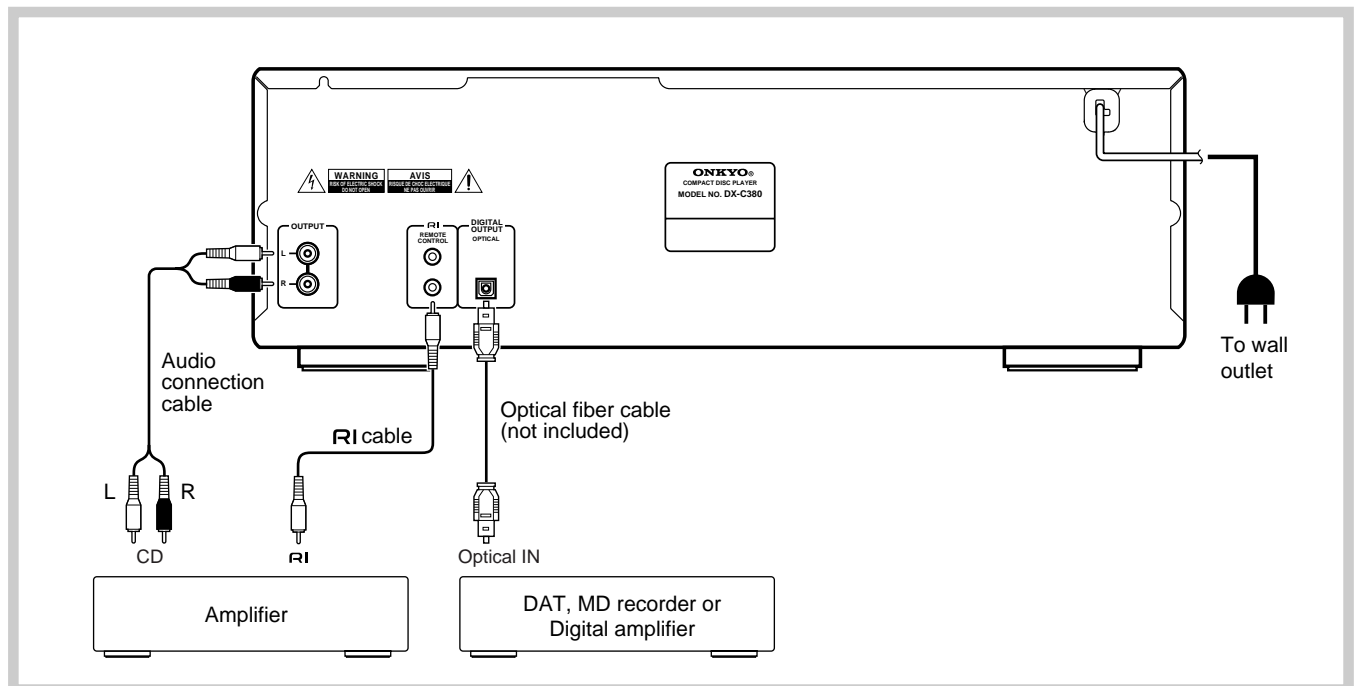

Connecting to an audio system

Two types of output jacks are located on the rear panel. Use the DIGITAL OUTPUT jack if you are connecting the unit to audio equipment that supports a digital connection.

OUTPUT (analog) jacks:

These are the most commonly used jacks. Connect these jacks to the amplifier's CD input jacks using the supplied audio connection cable.

DIGITAL OUTPUT (optical) jack:

For digital recording, connect this jack to the digital input jack of a Mini Disc recorder, a DAT deck, or other digital equipment. If your amplifier has a digital input jack, connecting the DIGITAL OUTPUT jack to it will produce a much clearer and more dynamic sound.

- Terminal protection cap is attached to the digital jack. Remove the cap when connecting the unit to other digital equipment. When you are not using the digital output jack, replace the cap.
- Refer to the amplifier's instruction manual for connections.

Connections for remote controller (RI)

When connecting Onkyo products, it is necessary to attach the RI cable to be able to use the remote controller of the main component to control the entire system.

1. To use this CD changer with an amplifier (or receiver), cassette tape deck, and tuner that include the appropriate RI jack, connect the components using the RI cable, plugged into the REMOTE CONTROL jacks.
2. As the exact connection sequence of the RI cable is unimportant, you can connect from the amplifier (or receiver) to either the tuner, cassette tape deck, or compact disc changer.
3. To operate correctly, the remote controller must point toward the remote control sensor of the amplifier (or receiver).

NOTES:

- The upper and lower RI REMOTE CONTROL jacks have the same function.
- Remote controller operation is not possible when only the RI cable is connected – the audio connection cables must also be connected.
- An RI cable equipped with a 3.5mm (1/8 in.) diameter miniature two-conductor phone plug is included with this unit and with every tuner and cassette tape deck that utilizes the RI jack.

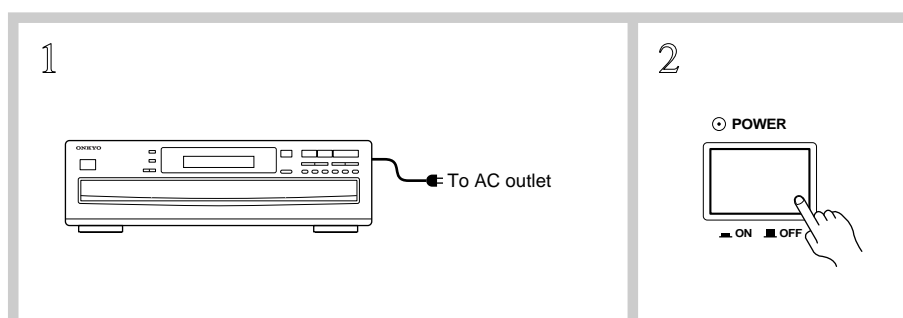

Connecting the power

Before plugging in the unit, confirm that all connections have been made properly.

1. **Insert the AC power supply cord into the outlet.**
 2. **Press the POWER button.**
- When the power first turns on, the carousel rotates to find a disc and stops automatically if there is a disc on the disc tray.

Playing CDs

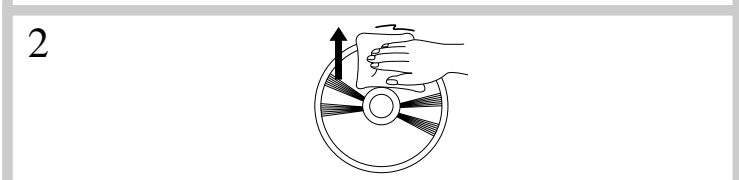
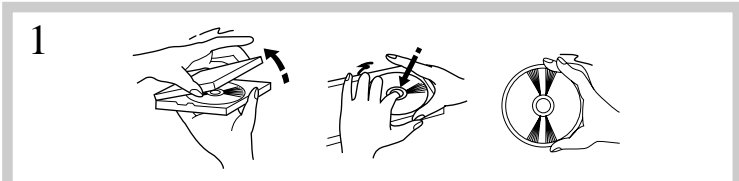
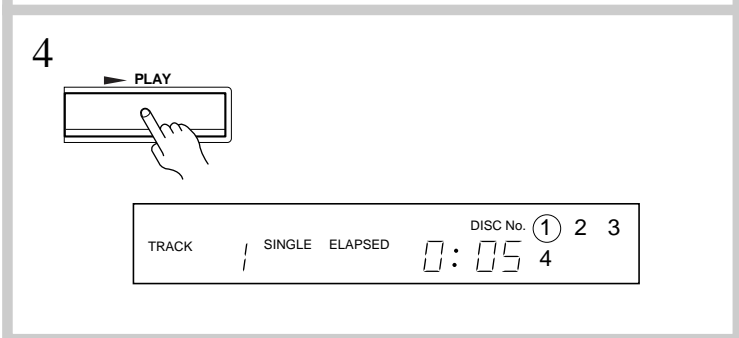
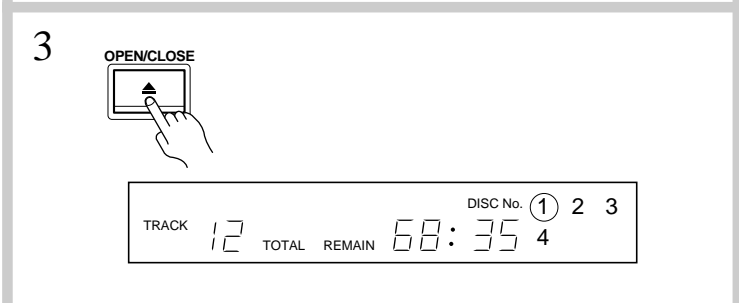
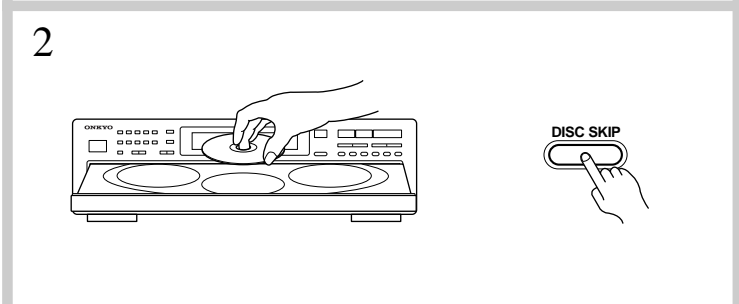
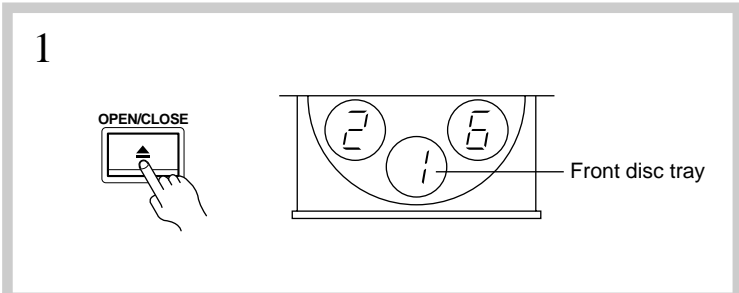
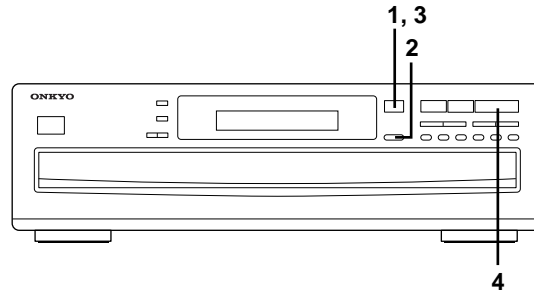

Normal playback

- Press the **▲ OPEN/CLOSE** button to open the loading drawer.
- Place the disc(s) in the disc trays with the label(s) facing up.
 - Pressing the DISC SKIP button rotates the carousel so that you can load disc(s) in other disc trays.
 - The disc tray with the Disc Number marked by a circle on the indicator will come to the front.
 - The carousel usually rotates counter-clockwise. However, it may sometimes rotate clockwise when you press the DISC SKIP button four times repeatedly.
 - If you place the discs in the disc trays and press the **▶ PLAY** button instead of the **▲ OPEN/CLOSE** button, the drawer will close, the carousel will rotate, and the unit will start playing back the disc in the front disc tray.
- Press the **▲ OPEN/CLOSE** button again to close the loading drawer.

When you close the loading drawer, the unit will read the disc in the front disc tray and display the number of tracks and the recording time in the disc. If there is no disc in this tray, the carousel rotates until it finds a disc tray with a disc. Disc Numbers with empty trays disappear from the display.
- Press the **▶ PLAY** button.

The unit will start playing back the disc from the first track. After the CD changer completes playing back all discs on the carousel, the display returns to the view shown in step 3.

Changing a disc during playback

- Press the **OPEN/CLOSE** button during playback.
 - Press the **DISC SKIP** button.

The carousel will turn so that you can change a disc other than the one that is playing.
 - Press the **OPEN/CLOSE** button to close the loading drawer.
- Note:**
You cannot select a new disc to play if the loading drawer is open. When you finish changing discs, close the loading drawer immediately.

Important notes on handling CDs

- Carefully lift the disc from the disc case, making sure to hold the disc by its edges or the hole in the center.
- You may use a dry, soft cloth to wipe dust and fingerprints from the surface of CDs. Do not use volatile agents on discs, such as thinner or benzene. Also, do not use conventional record cleaner or antistatic agents.
 - Do not place a CD in direct sunlight or locations subject to high humidity or low temperature.
 - Do not store a CD in the CD changer tray for a long period of time.

Playing CDs

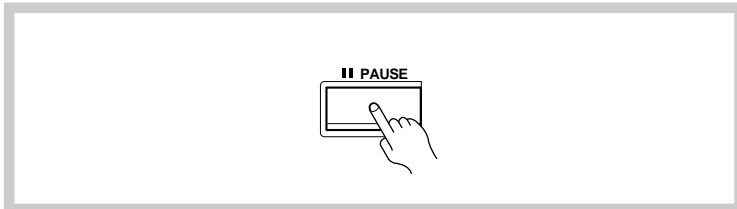
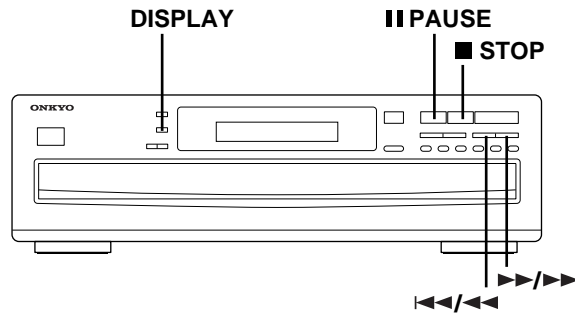

Stopping playback temporarily

Press the **|| PAUSE** button.

The PAUSE indicator will light up. To resume playback, press the **▶ PLAY** button, or press the **|| PAUSE** button again. The CD changer starts playing again from exactly the point at which it stopped.

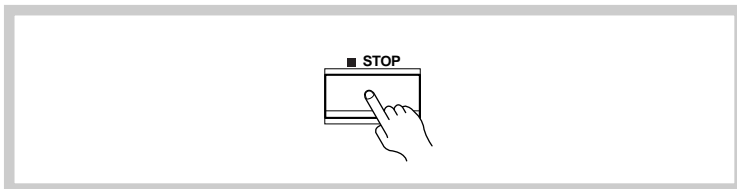

Stopping playback

Press the **■ STOP** button.

- When you open the loading drawer, the disc that was playing will be in the front disc tray.

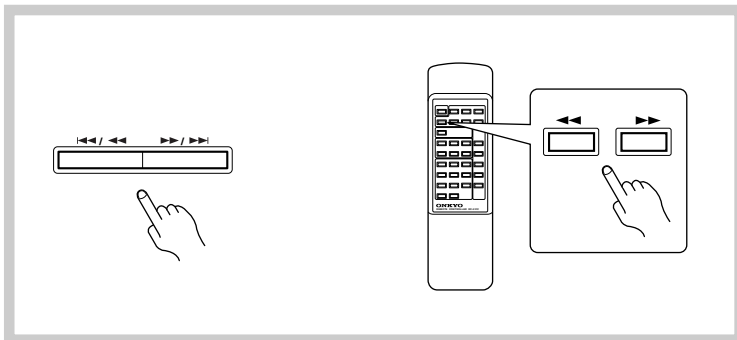

Search play

Hold down the **▶▶/▶▶** button to fast forward the current track during playback.

Hold down the **◀◀/◀◀** button to fast reverse the current track during playback.

Release the **▶▶/▶▶** or **◀◀/◀◀** button when you reach the point on the track you want to play back.

You can also use the remote controller to search by using the **◀◀** and **▶▶** buttons instead of the **◀◀/◀◀** and **▶▶/▶▶** buttons.

- The unit starts fast forwarding at 10-times speed, and after four seconds at 60-times speed.
- During the fast forward operation, you will hear a cueing sound at low volume.
- When the end of the disc is reached, the unit will play back the next disc.
- If you locate the top of the disc, the unit will cancel the fast forward operation and start playing back from the top of the disc (Track 1).

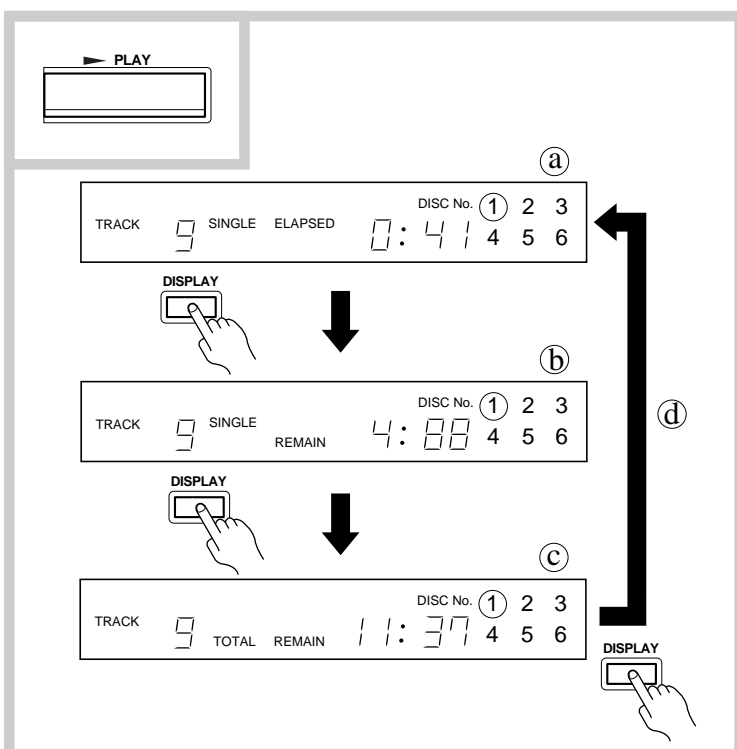

Checking the elapsed or remaining time

Press the **DISPLAY** button during playback.

The display changes each time you press the **DISPLAY** button.

- Ⓐ SINGLE ELAPSED: Indicates how long the current track has been playing.
- Ⓑ SINGLE REMAIN: Indicates how much time is left for the current track. For beyond the 20th track, the unit displays "--: --".
- Ⓒ TOTAL REMAIN: Indicates how much time is left for the entire disc to play. During memory play, this display indicates the playing time remaining for the entire sequence of tracks programmed into memory.
- Ⓓ The display returns to SINGLE ELAPSED time display.

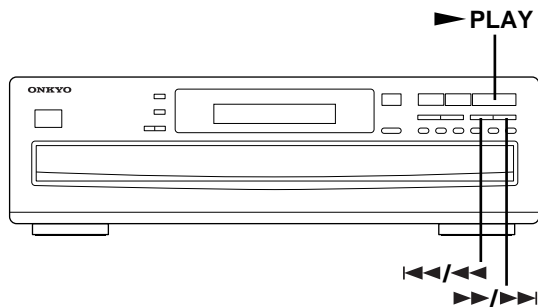

Starting playback from a given disc

Press the Direct Play button of a disc you wish to play back (DISC 1-DISC 6) on the front panel or the remote controler.

- The unit will play back the selected disc.
- If you press the Direct Play button (DISC 1-DISC 6) during playback, the playback will be cancelled and the unit will start playing back Track 1 of the selected disc.
- If you press the DISC SKIP button during playback, the playback will be cancelled and the unit will start playing back Track 1 of the next disc. (If the playback of Disc 6 is cancelled, the unit will start playing back Disc 1.)
- You can select a disc by pressing the DISC SKIP button while the playback is stopped. After you select a disc, press the PLAY button to start playback from Track 1.

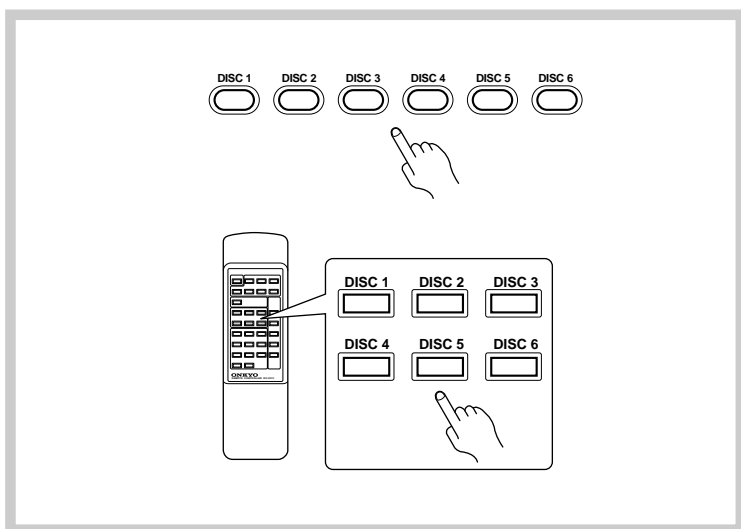

Starting playback from a given track

Using Skip buttons to select a playback track

1. While the unit is stopped, press the $\blacktriangleright/\blacktriangleright\blacktriangleright$ or $\blacktriangleleft/\blacktriangleleft$ button to select a track.

- Do not hold down the button. Press it repeatedly.
 - The Track indicator section will display the selected track number.
2. Press the \blacktriangleright PLAY button.
- The unit will start playing back from the selected track.

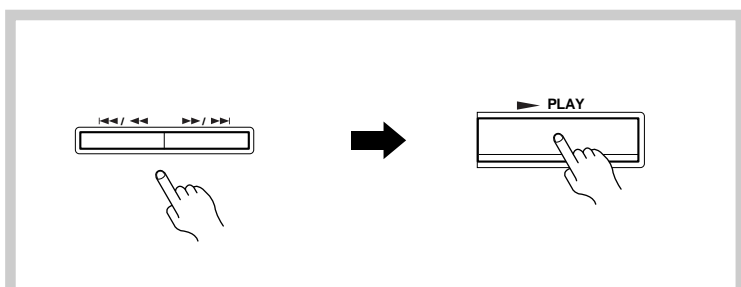

Using the number buttons to select a playback track

1. Select the track number you wish to play back using the number buttons.

The CD changer will start playing automatically. You do not need to press the \blacktriangleright PLAY button.

- The +10 number button is used to select a track with a number of 10 or higher. For example, to select Track Number 30, press this button three times, and then press 0.
- If you do not select a track, playback will start from the first track on the selected disc.

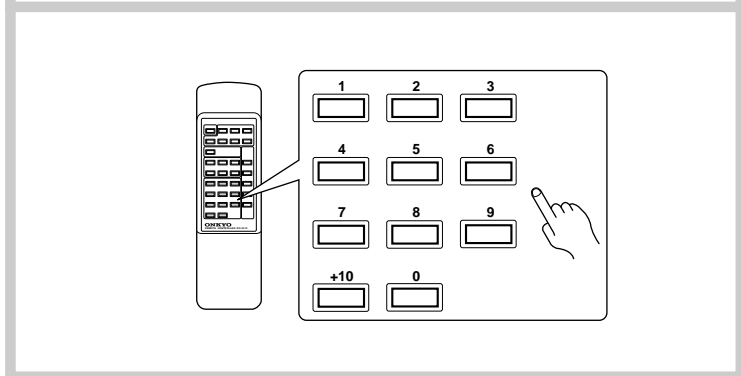

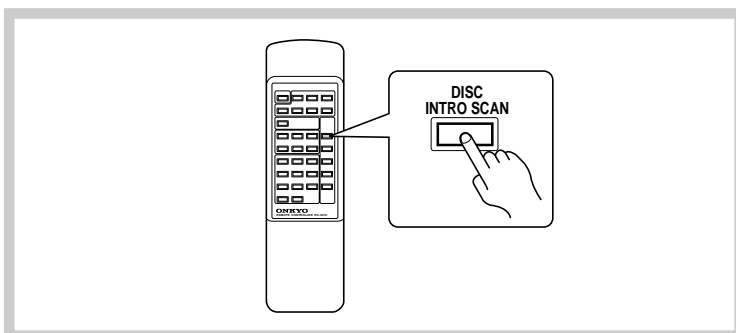
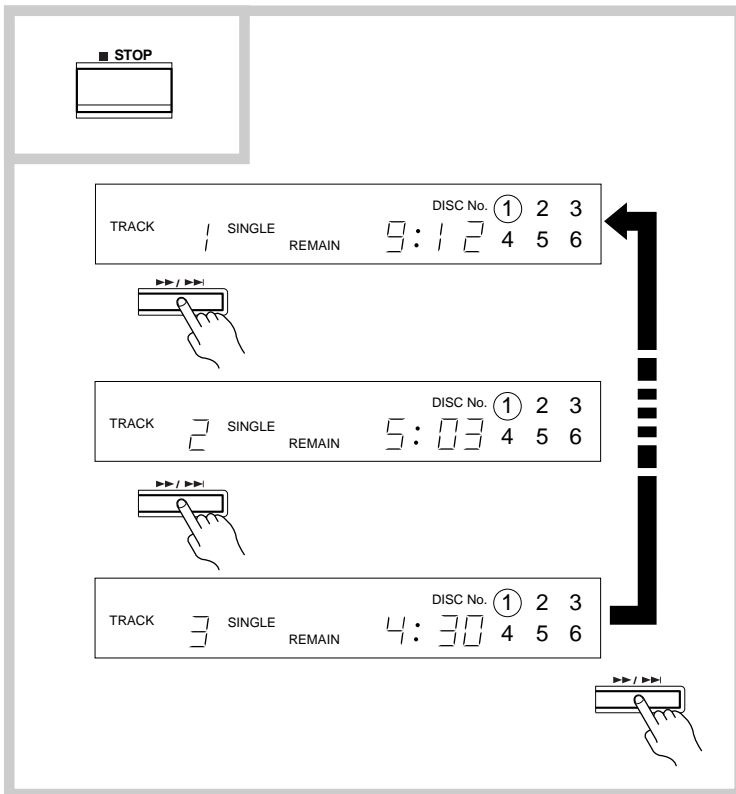
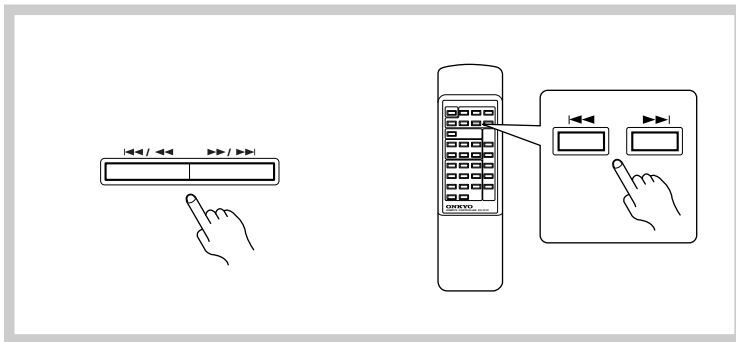
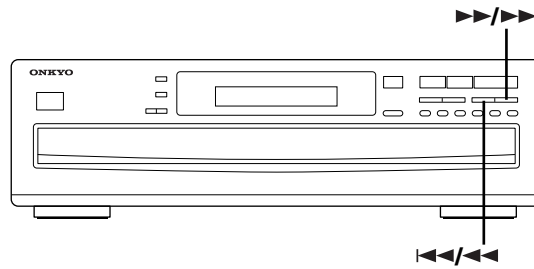

Skip playback

Use the $\blacktriangleleft/\triangleleft$ and $\blacktriangleright/\triangleright$ buttons.

You can also use the remote controller to operate the unit by using the \blacktriangleleft and \blacktriangleright buttons instead of the $\blacktriangleleft/\triangleleft$ and $\blacktriangleright/\triangleright$ buttons.

During playback, press the $\blacktriangleright/\triangleright$ button.

The CD changer will stop playing the current Track and will begin playing the next track from the beginning.

During memory playback (see "Using memory functions" on page 14), pressing this button will skip to the top of the next memorized track or the next disc.

Pressing this button during random playback (see "Playing back tracks at random" on page 13) will stop the playback, and the unit will select the next song at random and start playing it back.

During playback, press the $\blacktriangleleft/\triangleleft$ button.

The CD changer will return to the beginning of the current track and will begin playing back the same track again. To jump back to the previous track, quickly press the $\blacktriangleleft/\triangleleft$ button again before playback begins.

During memory playback, pressing this button will skip to the top of the previous track or disc.

Pressing this button during random playback will locate the top of the current track, not the previous track.

- The $\blacktriangleright/\triangleright$ button is disabled when the unit is playing back the last track of the disc or the last stored track.
- When the first track of the disc (Track 1) or the first stored track is being played back, the $\blacktriangleleft/\triangleleft$ button serves only to locate the top of the track.

Checking the playing time of a track

When you press the $\blacktriangleright/\triangleright$ button, the display indicates the playing time of the next track, in the order of the tracks on the CD.

- When you press the $\blacktriangleleft/\triangleleft$ button, the display shows the playing time of the previous track.

Continuously listening to the beginning of discs (Disc intro scan)

The "disc intro scan" function is particularly useful for quickly checking the contents of discs.

To activate this function, press the DISC INTRO SCAN button on the remote controller.

The CD changer will play back only the beginning of each disc for about eight seconds.

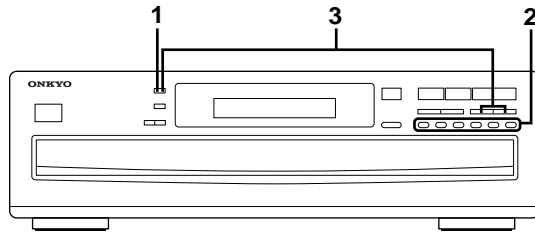

1

2

3

Selecting the next track to play back

This function enables you to select the next track or disc to play back.

1. Press the NEXT SELECTION button during playback.

2. Select the disc you wish to play using the Direct Play buttons (DISC 1-6).

- You can also use the DISC SKIP button to select a disc.
- To indicate that you wish to play the entire disc, press the NEXT SELECTION button at this point. (AL means all tracks)
- If you do not select a disc within approximately eight seconds, your disc selection will be cancelled. In this case, try Steps 1 and 2 again.

3. Select the track number you wish to play using the <<</>>>/<<< and >>>/>>> buttons and then press the NEXT SELECTION button.

When the playback of the current track is complete, the selected track will play.

You can use the number buttons on the remote controller to select a track number. In this case, you do not need to press the NEXT SELECTION button.

- If you select an entire disc to play back, the unit will first complete playback of the current disc, then play back the selected disc. If you select a track to play back, the unit will first complete playback of the current track, then play back the selected track.
- You can use the Next Selection function during memory playback, random playback, and memory random playback (see "Using memory functions" on page 14, and "Playing back tracks at random" on page 13). In these cases, the unit will first complete playback of the current track, then start playing back the selected disc or track, and the memory playback, random playback, or memory random playback will be cancelled.

NOTE:

- If after making your selection, you use the DISC SKIP button, <<</>>> and >>>/>>> buttons, or the number buttons to change the track for playback, the settings will be cancelled.
- The Next Selection function is effective only once at a time. The function will be cancelled when the selected disc or track starts playing back after playback of the current disc or track is completed.
- If you press the STOP button, the setting will be cancelled.

To select another disc or track ...

Press the NEXT SELECTION button. The currently-selected disc or track number will flash on the panel. You can change this number in the usual way.

To cancel the selection ...

Press the NEXT SELECTION button. The selected disc or track number will flash on the panel. Press the CLEAR button, and the selected disc or track will be cancelled. Press the NEXT SELECTION button.

- The NEXT SELECTION indicator will turn off.

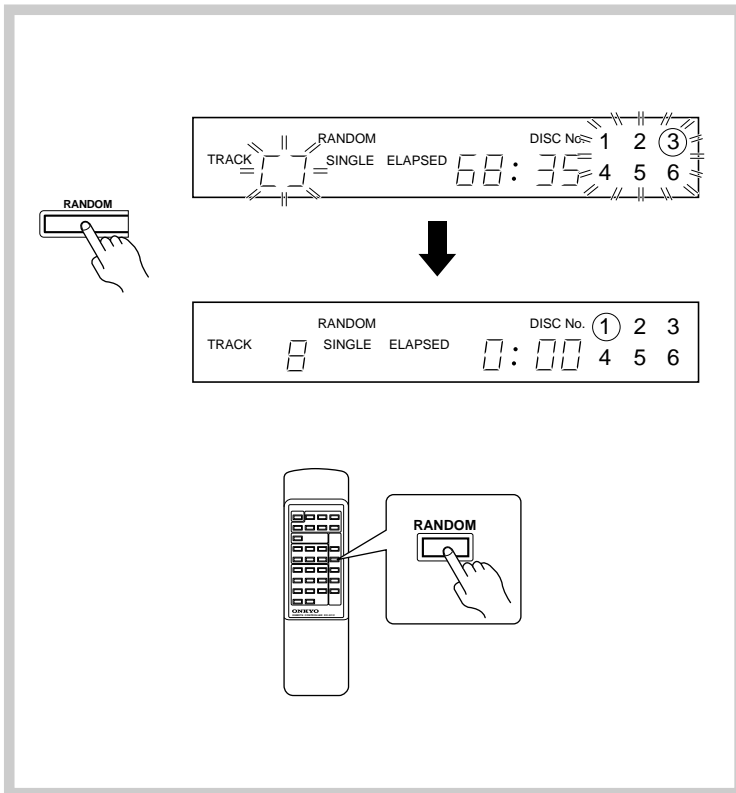
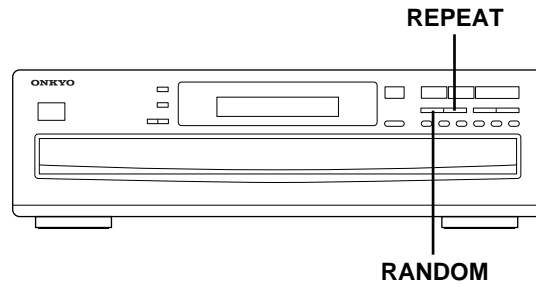

Playing back tracks at random

Press the RANDOM button on the unit or the remote controller to enter random mode.

The CD changer will play all tracks on all six discs at random.

- To cancel random play, press the ■ STOP or RANDOM button.
- The unit stops when it completes playback of all tracks on all discs.

If you have pressed the REPEAT button, the unit will repeat playback of all tracks at random after it finishes playing all tracks once.

- During random playback, the DISC 1 - DISC 6 buttons, the DISC SKIP button, and the number buttons will be disabled.
- Discs can be exchanged during random playback. However, if you add a disc with a different number of tracks, all tracks will be played back. A disc that contains the same number of tracks will not play back track numbers that have already been played. If a disc for which all tracks have been played is exchanged, the new disc is not played.
- Random mode can be operated together with memory mode and repeat mode. However, if the whole disc is stored into memory and the disc is selected, no other songs are played until the random playback of tracks from this disc is completed. (Refer to "Using memory functions" on page 14 for more information on memory playback.)

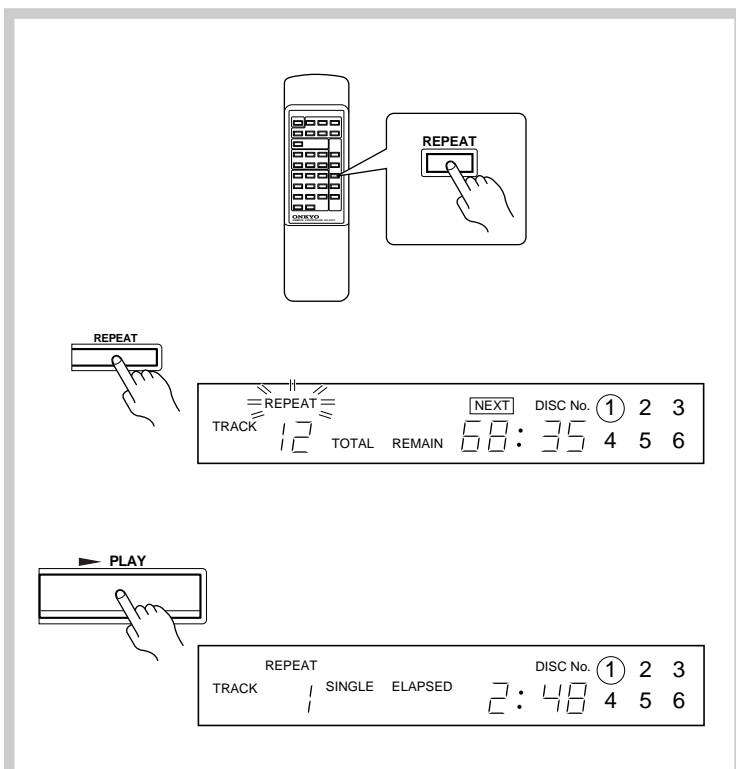

Repeating all tracks of all discs

1. Press the REPEAT button on the unit or the remote controller to enter the repeat mode.

The REPEAT indicator will light up.

2. Press the ► PLAY button.

All tracks from all discs inserted in the disc trays will be played back repeatedly.

Repeat playback can be used with normal, random, and memory playback modes (see "Using memory functions" on page 14). You can press this button either before or during playback.

3. To cancel the repeat mode, press the REPEAT button to turn off the repeat indicator.

Using memory functions

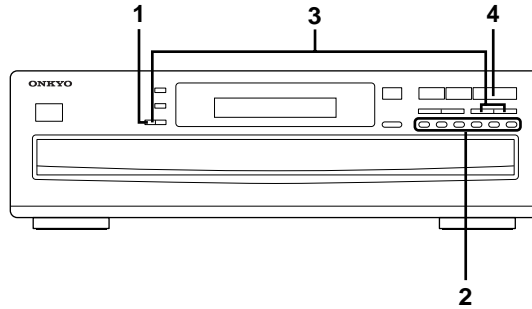

1

2

3

4

Storing a program into memory and playing it

Up to 40 tracks can be stored in memory.

1. Press the MEMORY button.

The MEMORY indicator will light up.

2. Select the desired disc using the Direct Play buttons (DISC 1-6).

- You may also use the DISC SKIP button to select a disc.
- If you wish to program the entire disc, select the desired disc and press the MEMORY button. ("AL (all)" appears.)
- To use the number buttons on the remote controller to select the entire disc, press the "0" button.

3. Use the <<</>>> and >>>/>>> buttons to select the desired track, and then press the MEMORY button.

The selected tracks are stored in memory.

You can use the number buttons on the remote controller to select a track number. In this case, you do not need to press the MEMORY button.

- To store tracks on other discs into the memory, repeat steps 2 and 3.
- Repeat Step 3 to select a track from the same disc.
- If you attempt to select more than 40 tracks, "FULL" will flash on the time display to indicate that the memory is full.

4. Press the ► PLAY button.

The CD changer will play the programmed tracks in the order you selected.

- If you press the MEMORY button during playback, the track being played will be stored in memory. You can use the number buttons to program more tracks.
- You will need to select a disc each time you wish to program a track from a non-current disc.

NOTES:

- If the total remaining time is more than 99 minutes 59 seconds or when the contents of the memory extends to 2 or more discs, "--:--" will be displayed.
- If a selected disc or track does not exist, the corresponding indicator (disc or track) will light up and the selection will be included in the program count, but the selection(s) will be ignored and the subsequent disc or track in the program will play.

Stopping a memory playback

Press the ■ STOP button.

Using memory functions

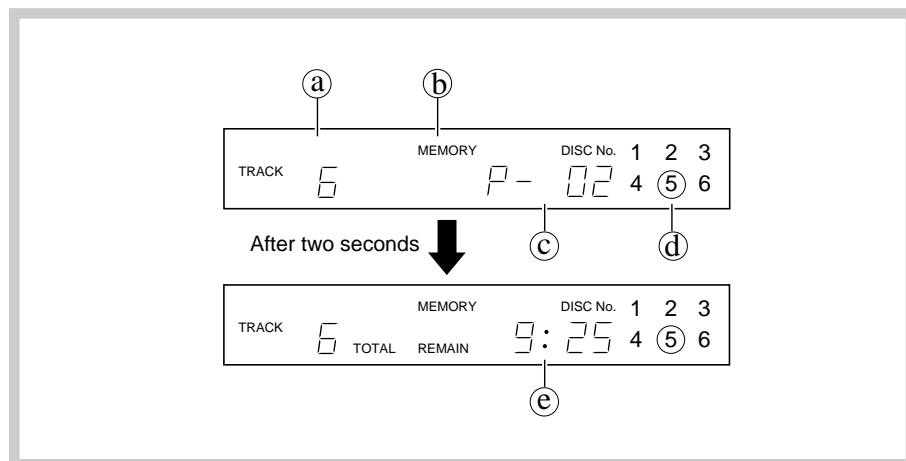

Contents of the display

Example: When the sixth track of DISC #5 is stored in memory as the second track to play back (P-02).

- Ⓐ Track number
- Ⓑ MEMORY indicator
- Ⓒ Program number
- Ⓓ Disc Number
- Ⓔ Total number of stored programs

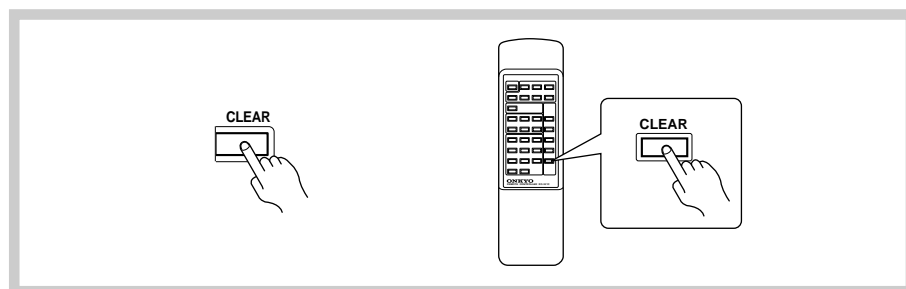

Clearing the last track stored

Press the **CLEAR** button.

The last track stored in memory is cleared.

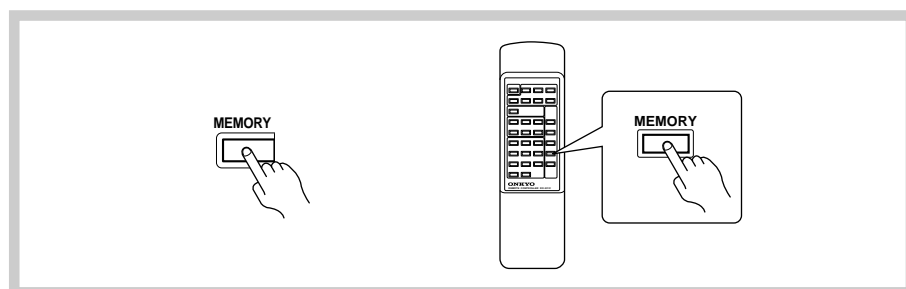

Clearing the entire program

Press the **MEMORY** button to turn off the **MEMORY** indicator.

The contents of memory are completely cleared.

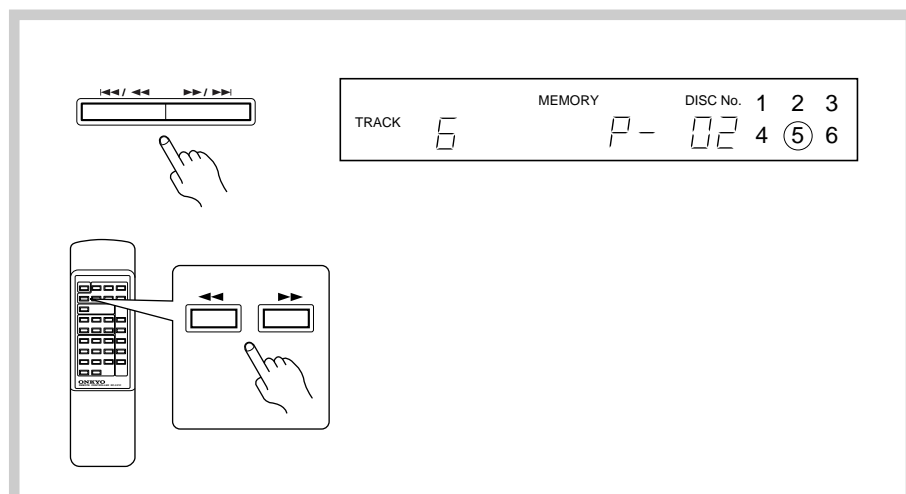

Checking what is stored in memory

1. First, if the CD changer is playing in memory playback mode, press the STOP button. The CD changer will display the last program number stored in memory.
2. If you press and hold down the ►►/►► button, the track numbers in memory will appear in the display in the order in which they were stored. If you press and hold down the ◀◀/◀◀ button, the track numbers will appear in the opposite order.

Notes about the time display

In the following cases, the time display may indicate "-- : --" due to the memory limitations.

- If you switch to the remaining time display while the CD changer is playing the 21st or later song on the disc
- If you switch to the total remaining time display after storing the 21st or later song on the disc
- If you switch to the total remaining time display after the CD changer plays songs from memory for more than 99 minutes 59 seconds, or
- If you switch to the total remaining time display during random playback of a CD that contains 21 or more songs.

Troubleshooting Guide Specifications

- **No power.**
Cause: Power cable is not properly plugged into the AC outlet.
Remedy: Insert the power plug firmly.
- **A disc is loaded in the disc tray, but playback will not start.**
Cause: A disc in the disc tray may be upside down.
Remedy: Load the disc with the label facing upward.
Cause: The disc is dirty.
Remedy: Clean the disc.
Cause: Moisture has accumulated inside the CD changer.
Remedy: Remove the disc from the disc tray, place the CD changer in a warm place, and leave the power on for about one hour.
- **No sound is heard.**
Cause: Connections may be incomplete or incorrect.
Remedy: Check all cable connections. Insert all the plugs firmly into the jacks.
Cause: The input selector switch on the amplifier may be set incorrectly.
Remedy: Set the switch to the proper position. See your amplifier's operating instructions for more information.
- **Disc playback skips.**
Cause: The disc is dirty.
Remedy: Clean the disc.
Cause: A disc is scratched.
Remedy: Replace the disc.
Cause: The CD changer is subject to being accidentally bumped.
Remedy: Place the CD changer in a more stable location.
- **Search time (when locating a specific track) is extremely long.**
Cause: The disc is dirty.
Remedy: Clean the disc.
Cause: The disc is scratched.
Remedy: Replace the disc.
- **Track numbers cannot be stored in memory.**
Cause: No disc in the tray.
Remedy: Load a disc in the tray.
Cause: You have entered a track number that does not exist on the disc.
Remedy: Use only the track numbers that exist on the disc.
- **Front panel controls function correctly, but remote controller does not.**
Cause: No batteries in remote controller.
Remedy: Insert batteries.
Cause: Batteries have worn out.
Remedy: Replace batteries.

Because the unit contains a microcomputer to provide advanced functions, it may malfunction due to external noise or static electricity. If this happens, press the POWER switch on the unit and then press it in again after about five seconds.

Signal readout system:	Optical non-contact
Reading rotation:	About 500 - 200 r.p.m. (constant linear velocity)
Linear velocity:	1.2 - 1.4 m/s
Error correction system:	Cross Interleave Reed-Solomon code
D/A converter:	1 bit PWM/ACCUPULSE
Sampling frequency:	352.8 kHz (8 times oversampling)
Number of channels:	2 (stereo)
Frequency response:	5 Hz - 20 kHz
Total harmonic distortion:	0.005% (at 1 kHz)
Dynamic range:	96 dB
Signal to noise ratio:	92 dB
Channel separation:	92 dB (at 1 kHz)
Wow and Flutter:	Below threshold of measurability
Output level:	2 volts r.m.s.
Power consumption:	10 watts
Power supply:	120 V, 60 Hz 230V, 50 Hz
Dimensions (W × H × D):	435× 131× 433mm (17-1/8" × 5-3/16" × 17-1/16")
Weight:	6.9 kg (15.2 lbs.)

Specifications and features are subject to change without notice.

ONKYO CORPORATION

Sales & Product Planning Div. : 2-1, Nisshin-cho, Neyagawa-shi, OSAKA 572-8540, JAPAN
Tel: 072-831-8111 Fax: 072-833-5222

ONKYO U.S.A. CORPORATION

200 Williams Drive, Ramesy, N.J. 07446, U.S.A.
Tel: 201-825-7950 Fax: 201-825-8150 E-mail: onkyo@onkyousa.com

ONKYO EUROPE ELECTRONICS GmbH

Industriestrasse 20, 82110 Germering, GERMANY
Tel: 089-849-320 Fax: 089-849-3265 E-mail: info@onkyo.de

ONKYO CHINA LIMITED

Units 2102-2107, Metroplaza Tower I, 223 Hing Fong Road, Kwai Chung,
N.T., HONG KONG Tel: 852-2429-3118 Fax: 852-2428-9039



Free Manuals Download Website

<http://myh66.com>

<http://usermanuals.us>

<http://www.somanuals.com>

<http://www.4manuals.cc>

<http://www.manual-lib.com>

<http://www.404manual.com>

<http://www.luxmanual.com>

<http://aubethermostatmanual.com>

Golf course search by state

<http://golfingnear.com>

Email search by domain

<http://emailbydomain.com>

Auto manuals search

<http://auto.somanuals.com>

TV manuals search

<http://tv.somanuals.com>