

Stereo Tuner T-405X

Before using

Connections

Operation

Other Information

Instruction Manual

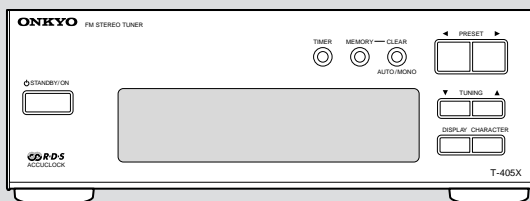
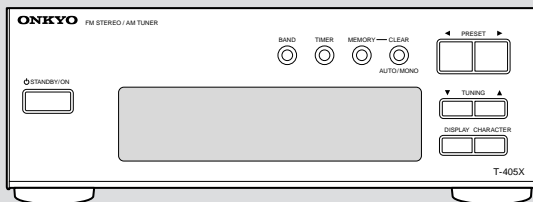

Thank you for purchasing the ONKYO T-405X Tuner.

Please read this manual thoroughly before making any connection or turning on the power.

Follow these instructions to obtain optimum performance and maximum listening enjoyment from your new Tuner. Please retain this manual for future reference.

Main Features

- High-Quality Separate Component
- Preset Memory for Up to 30 Broadcast Stations
- Auto Preset Memory Function
- Weekly Program Timer

WARNING:

TO REDUCE THE RISK OF FIRE OR ELECTRIC SHOCK, DO NOT EXPOSE THIS APPLIANCE TO RAIN OR MOISTURE.

CAUTION:

TO REDUCE THE RISK OF ELECTRIC SHOCK, DO NOT REMOVE COVER (OR BACK). NO USER-SERVICEABLE PARTS INSIDE. REFER SERVICING TO QUALIFIED SERVICE PERSONNEL.



WARNING
RISK OF ELECTRIC SHOCK
DO NOT OPEN

AVIS
RISQUE DE CHOC ELECTRIQUE
NE PAS OUVRIR



The lightning flash with arrowhead symbol, within an equilateral triangle, is intended to alert the user to the presence of uninsulated "dangerous voltage" within the product's enclosure that may be of sufficient magnitude to constitute a risk of electric shock to persons.



The exclamation point within an equilateral triangle is intended to alert the user to the presence of important operating and maintenance (servicing) instructions in the literature accompanying the appliance.

Important Safeguards

1. **Read Instructions** – All the safety and operating instructions should be read before the appliance is operated.
2. **Retain Instructions** – The safety and operating instructions should be retained for future reference.
3. **Heed Warnings** – All warnings on the appliance and in the operating instructions should be adhered to.
4. **Follow Instructions** – All operating and use instructions should be followed.
5. **Water and Moisture** – The appliance should not be used near water – for example, near a bathtub, washbowl, kitchen sink, laundry tub, in a wet basement, or near a swimming pool, and the like.
6. **Carts and Stands** – The appliance should be used only with a cart or stand that is recommended by the manufacturer.
- 6A. An appliance and cart combination should be moved with care. Quick stops, excessive force, and uneven surfaces may cause the appliance and cart

PORTABLE CART WARNING



Important Safeguards

7. **Wall or Ceiling Mounting** – The appliance should be mounted to a wall or ceiling only as recommended by the manufacturer.
8. **Ventilation** – The appliance should be situated so that its location or position does not interfere with its proper ventilation. For example, the appliance should not be situated on a bed, sofa, rug, or similar surface that may block the ventilation openings; or if placed in a built-in installation, such as a bookcase or cabinet that may impede the flow of air through the ventilation openings, there should be free space of at least 5 cm (2 in.) and an opening behind the appliance.
9. **Heat** – The appliance should be situated away from heat sources such as radiators, heat registers, stoves, or other appliances (including amplifiers) that produce heat.
10. **Power Sources** – The appliance should be connected to a power supply only of the type described in the operating instructions or as marked on the appliance.
11. **Polarization** – If the appliance is provided with a polarized plug having one blade wider than the other, please read the following information: The polarization of the plug is a safety feature. The polarized plug will only fit the outlet one way. If the plug does not fit fully into the outlet, try reversing it. If there is still trouble, the user should seek the services of a qualified electrician. Under no circumstances should the user attempt to defeat the polarization of the plug.
12. **Power-Cord Protection** – Power-supply cords should be routed so that they are not likely to be walked on or pinched by items placed upon or against them, especially near plugs, convenience receptacles, and the point where they exit from the appliance.
13. **Cleaning** – The appliance should be cleaned only as recommended by the manufacturer.
14. **Power Lines** – An outdoor antenna should be located away from power lines.
15. **Nonuse Periods** – The power cord of the appliance should be unplugged from the outlet when left unused for a long period of time.
16. **Object and Liquid Entry** – Care should be taken so that objects do not fall and liquids are not spilled into the enclosure through openings.
17. **Damage Requiring Service** – The appliance should be serviced by qualified service personnel when:
 - A. The power-supply cord or the plug has been damaged; or
 - B. Objects have fallen, or liquid has been spilled into the appliance; or
 - C. The appliance has been exposed to rain; or
 - D. The appliance does not appear to operate normally or exhibits a marked change in performance; or
 - E. The appliance has been dropped, or the enclosure damaged.
18. **Servicing** – The user should not attempt to service the appliance beyond that described in the operating instructions. All other servicing should be referred to qualified service personnel.
19. **Outdoor Antenna Grounding** – If an outside antenna is connected to the receiver, be sure the antenna system is grounded so as to provide some protection against voltage surges and built up static charges. Article 810 of the National Electrical Code, ANSI/NFPA 70, provides information with regard to proper grounding of the mast and supporting structure, grounding of the lead-in wire to an antenna-discharge unit, size of grounding conductors, location of antenna-discharge units, connection to grounding electrodes, and requirements for the grounding electrode. See Figure 1.

FIGURE 1:
EXAMPLE OF ANTENNA GROUNDING AS PER
NATIONAL ELECTRICAL CODE

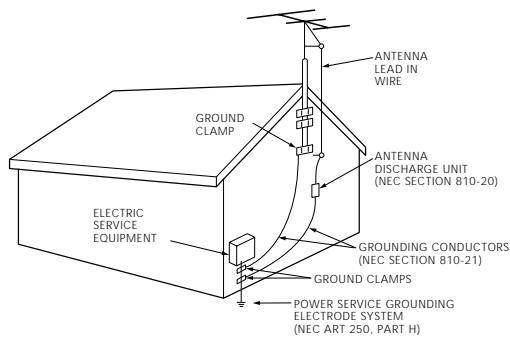

NEC – NATIONAL ELECTRICAL CODE

Precautions

1. Warranty Claim

You can find the serial number on the rear panel of this unit. In case of warranty claim, please report this number.

2. Care

From time to time you should wipe the front and rear panels and the cabinet with a soft cloth. For heavier dirt, dampen a soft cloth in a weak solution of mild detergent and water, wring it out dry, and wipe off the dirt. Following this, dry immediately with a clean cloth. Do not use rough material, thinners, alcohol or other chemical solvents or cloths since these could damage the finish or remove the panel lettering.

3. Power

WARNING

BEFORE PLUGGING IN THE UNIT FOR THE FIRST TIME, READ THE FOLLOWING SECTION CAREFULLY.

The voltage of the available power supply differs according to country or region. Be sure that the power supply voltage of the area where this unit will be used meets the required voltage (e.g., AC 230 V, 50 Hz or AC 120 V, 60 Hz) written on the rear panel. Setting the STANDBY button to standby does not shut off the power completely. So the power cord should be removed from the AC outlet when the unit is not used for a prolonged time.

For British model

Replacement and mounting of an AC plug on the power supply cord of this unit should be performed only by qualified service personnel.

IMPORTANT

The wires in the mains lead are coloured in accordance with the following code:

Blue : Neutral
Brown : Live

As the colours of the wires in the mains lead of this apparatus may not correspond with the coloured markings identifying the terminals in your plug, proceed as follows:

The wire which is coloured blue must be connected to the terminal which is marked with the letter N or coloured black.

The wire which is coloured brown must be connected to the terminal which is marked with the letter L or coloured red.

IMPORTANT

A 5 amp fuse is fitted in this plug. Should the fuse need to be replaced, please ensure that the replacement fuse has a rating of 5 amps and that it is approved by ASTA or BSI to BS1362. Check for the ASTA mark or the BSI mark on the body of the fuse. IF THE FITTED MOULDED PLUG IS UNSUITABLE FOR THE SOCKET OUTLET IN YOUR HOME THEN THE FUSE SHOULD BE REMOVED AND THE PLUG CUT OFF AND DISPOSED OF SAFELY. THERE IS A DANGER OF SEVERE ELECTRICAL SHOCK IF THE CUT OFF PLUG IS INSERTED INTO ANY 13 AMP SOCKET.

If in any doubt, please consult a qualified electrician.

For U.S. model

Note to CATV system installer:

This reminder is provided to call the CATV system installer's attention to Article 820-40 of the NEC, ANSI/NFPA 70, which provides guidelines for proper grounding and, in particular, specifies that the cable ground shall be connected to the grounding system of the building, as close to the point of cable entry as practical.

FCC Information for User

CAUTION:

The user changes or modifications not expressly approved by the party responsible for compliance could void the user's authority to operate the equipment.

NOTE:

This equipment has been tested and found to comply with the limits for a Class B digital device, pursuant to Part 15 of the FCC Rules. These limits are designed to provide reasonable protection against harmful interference in a residential installation. This equipment generates, uses and can radiate radio frequency energy and, if not installed and used in accordance with the instructions, may cause harmful interference to radio communications. However, there is no guarantee that interference will not occur in a particular installation. If this equipment does cause harmful interference to radio or television reception, which can be determined by turning the equipment off and on, the user is encouraged to try to correct the interference by one or more of the following measures:

- Reorient or relocate the receiving antenna.
- Increase the separation between the equipment and receiver.
- Connect the equipment into an outlet on a circuit different from that to which the receiver is connected.
- Consult the dealer or an experienced radio/TV technician for help.

For Canadian model

For models having a power cord with a polarized plug:

CAUTION: TO PREVENT ELECTRIC SHOCK, MATCH WIDE BLADE OF PLUG TO WIDE SLOT, FULLY INSERT.

Modele pour les Canadien

Sur les modèles dont la fiche est polarisée:

ATTENTION: POUR ÉVITER LES CHOCS ÉLECTRIQUES, INTRODUIRE LA LAME LA PLUS LARGE DE LA FICHE DANS LA BORNE CORRESPONDANTE DE LA PRISE ET POUSSER JUSQU'AU FOND.

Table of contents

Connections

Connecting to the ONKYO Separate Collection Series Components	6
Connecting to other components	8
Antenna connections	10

Operation

Setting the Clock	12
Receiving stations	16
Naming a preset station	19
Receiving RDS (European models only)	22
Using the timer	23

Other Information

Troubleshooting	30
Index to parts and controls	31
Specifications	32

Supplied accessories

Check that the following accessories are supplied with this unit.

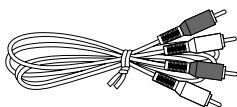

Audio connection cable × 1

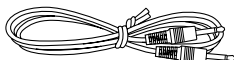

RI remote control cable × 1

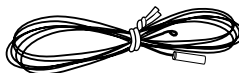

FM indoor antenna × 1
(not available on the U.S. and Canadian models)

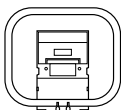

AM loop antenna × 1
(only available on the U.S. and Canadian models)



T-shaped FM indoor antenna × 1
(only available on the U.S. and Canadian models)

Declaration of Conformity

We, ONKYO EUROPE
ELECTRONICS GmbH
INDUSTRIESTRASSE 20
82110 GERMERING,
GERMANY



declare in own responsibility, that the ONKYO product described in this instruction manual is in compliance with the corresponding technical standards such as EN60065, EN55013, EN55020 and EN61000-3-2, -3-3 (or EN60555-2, -3)

GERMERING, GERMANY



K. OTSU

ONKYO EUROPE ELECTRONICS GmbH

Memory Preservation

This unit does not require memory preservation batteries. A built-in memory power back-up system preserves the contents of the memory during power failures and even when the unit is unplugged. The unit must be plugged in order to charge the back-up system.

The memory preservation period after the unit has been unplugged varies depending on climate and placement of the unit. On the average, memory contents are protected over a period of a few weeks after the last time the unit has been unplugged. This period is shorter when the unit is exposed to a highly humid climate.

This section introduces you to the other Separate Collection Series system components and their convenient system functions, followed by instruction on how to connect the system.

The following Separate Collection Series components are available:

- A-905X Integrated Stereo Amplifier
- C-705X Compact Disc (CD) Player (Not available in U.S. and Canada)
- C-707CH Compact Disc (CD) Changer (Only available in U.S. and Canada)
- K-505X Stereo Cassette Tape Deck
- MD-105X ... Minidisc (MD) Recorder (Not available in U.S. and Canada)

Note that the available components may vary according to the area.

Combining the T-405X Stereo tuner with the above system components enables you to operate the following convenient functions:

- **Auto Power On**

- You can turn on the power to the amplifier by pressing the STANDBY/ON button on one of the system components. (The amplifier's POWER switch must be set to ON.)
- When the amplifier's POWER switch is set to ON, you can turn on the power to all the system components simultaneously by pressing the STANDBY/ON button on the amplifier. Afterwards, you can turn off the power to the individual components that are not in use.

- **Direct Change**

Press the following button on the component you want to operate. The amplifier will automatically select the input from the corresponding component:

- The play button on the CD player (or changer), MD recorder, or stereo cassette tape deck; or
- The PRESET ◀/▶ buttons on the tuner.

- **Remote Control Operation**

You can operate all the system components using the remote controller supplied with the amplifier A-905X.

- **Program Timer**

You can operate the timer playback and recording functions using the T-405X (see page 23).

- **Sleep Timer**

You can fall asleep to a music/radio program using the timer (see page 29).

- **CD Dubbing**

Simple CD dubbing using a stereo cassette tape deck or MD recorder is possible with the pressing of a single button (CD dubbing function using an MD recorder is not available on the C-707CH). (Refer to the K-505X or MD-105X Instruction Manual for more information).

- **CD/MD Synchro Recording**

When using a stereo cassette tape deck or MD recorder to record from the CD player or when using a stereo cassette tape deck to record from an MD recorder, you can record with simply starting on a CD player or MD recorder. (Refer to the K-505X or MD-105X instruction manual for more information.)

- **Dubbing a specific track from CD**

You can specify a track on a CD and easily dub it to a connected MD recorder. (Refer to the MD-105X instruction manual for more information.)

System connection for use of Timer function

If you wish to use the Timer function of this unit in your system, connect the power cord as shown below and connect the **RI** cable and audio connection cables.

- Be sure to connect the power cord of this unit to an AC outlet that supplies continuous power.
- Turn on the POWER switch on the amplifier A-905X. If you turn off the POWER switch, the Timer function setting will be cancelled.
- Be sure to make the audio cable connection. Refer to the instruction manual for the A-905X for information on audio cable connection.

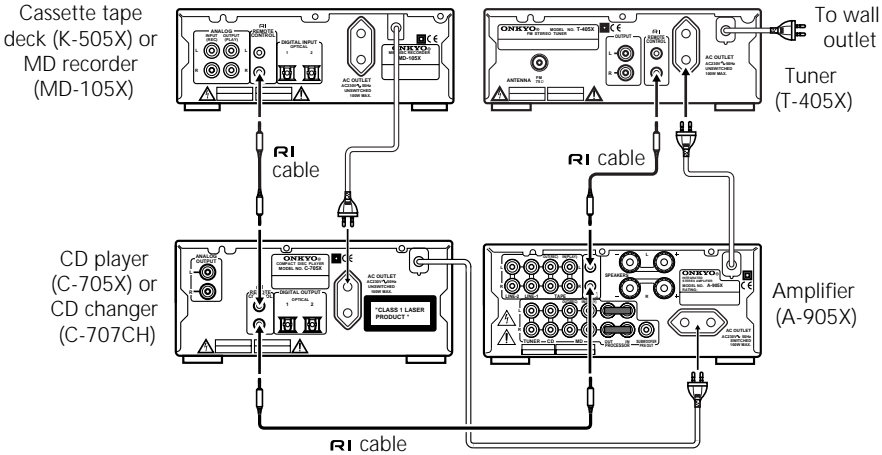

Notes

You can turn off the power to the entire system by simply turning off the POWER switch on the A-905X Amplifier, refer to the A-905X instruction manual for more information.

The 230 V models are shown in the illustrations.

Using the remote controller

The unit is not shipped with a remote controller. However, you may use a remote controller (RC-398S) that is supplied with A-905X amplifier to operate the unit.

Be sure to make the **RI** connection securely. If the connection is incomplete, you cannot use the remote controller to operate the unit.

Point the remote controller toward the remote control sensor of A-905X.

Notes

- Place the unit away from strong light such as direct sunlight or inverted fluorescent light which can prevent proper operation of the remote controller.
- Using another remote controller of the same type in the same room or using the unit near equipment which uses infrared rays may cause operational interference.
- Do not put any object such as a book on the remote controller. The buttons of the remote controller may be pressed by mistake and drain the batteries.
- Make sure the audio rack doors do not have colored glass. Placing the unit behind such doors may prevent proper remote controller operation.
- If there is any obstacle between the remote controller and the remote control sensor, the remote controller will not operate.

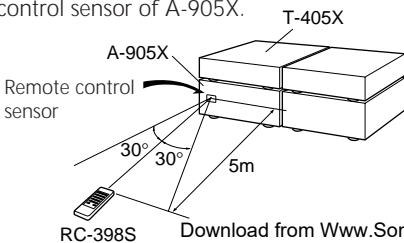

Connecting to other components

Before connecting

- Do not connect the unit's AC power cord to a wall outlet until you have completed all the other connections.
- On each pair of connectors, a red connector (marked R) corresponds to the right channel, and a white connector (marked L) to the left channel. Connect white plugs of audio connection cables to L connectors and connect red plugs of audio connection cables to R connectors .

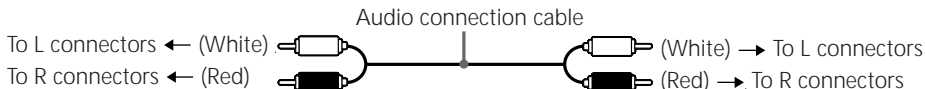

- Insert the plug securely. If the connection is incomplete, noise or malfunction may result.

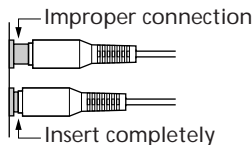

- Bundling an audio connection cable with the power cord or speaker cord may degrade the sound quality.

Note:

The 230 V model is shown in the following illustrations.

Connections

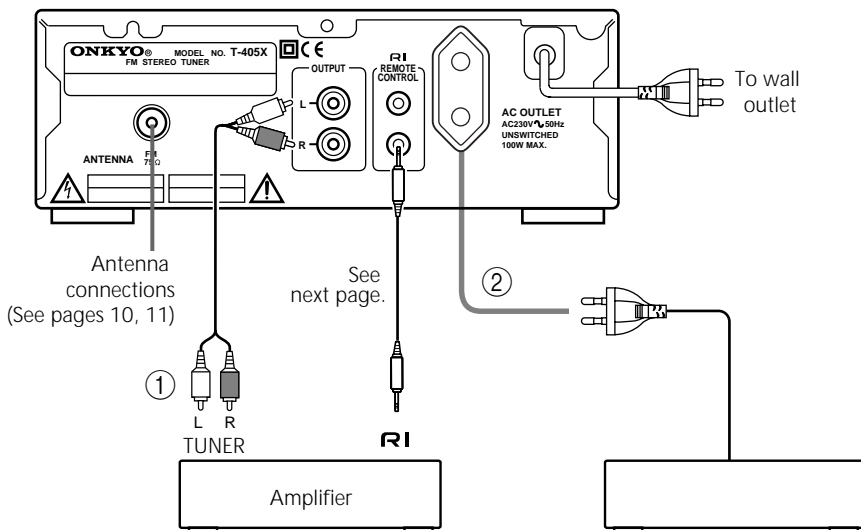

① Connecting the amplifier

Connect the tuner's OUTPUT jacks and the amplifier's TUNER input jacks using the audio connection cable. Refer to the amplifier's instruction manual for connection information.

② AC outlet (UNSWITCHED)

The AC power cord of another component can be connected to this AC OUTLET connector.

This means that if the T-405X is plugged into an AC outlet, AC power is available to this AC OUTLET even if the T-405X is off.

The shape and capacity of the AC outlet may differ depending on the area of purchase. Make sure that the capacity of other components connected to this unit does not exceed the capacity that is printed on the rear panel.

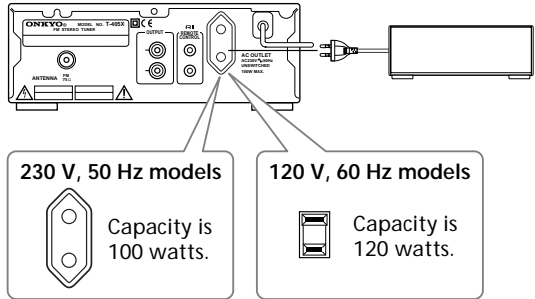

Connecting the RI connector

If you are using other ONKYO components equipped with **RI** connectors, you can control these components using the amplifier's remote controller.

Before connecting

- The amplifier must be connected to the **RI** system hookups for **RI** control operations.
- Each component has two **RI** connectors. There is no difference between these connectors.
- The components may be connected in any order.
- Remote control operation is not possible if only the **RI** remote control cable is connected to the **RI** connectors. Connect the audio connection cables correctly.

The illustration is an example of an **RI** hookup. With these hookups, you can use the Program Timer function. (See "Using the timer" on page 23).

For the Program Timer function, at least the unit and amplifier must be connected via the **RI** connectors.

Note

An **RI** remote control cable equipped with a 1/8 in. (3.5mm) diameter miniature two-conductor phone plug is included with this unit and with every compact disc player and cassette deck that bears the **RI** mark.

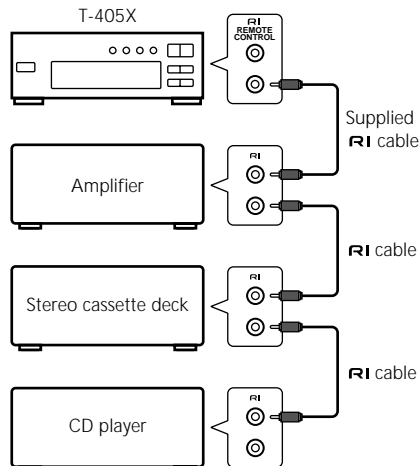

Antenna connections

Connecting the FM antenna

Connecting the antenna cable

1. Open the lever.
2. Insert the wire.
3. Close the lever.

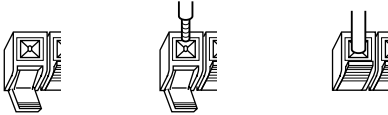

FM indoor antenna

The supplied FM antenna is for indoor use only. Move the antenna in various directions until the clearest signal is received. Fix it with push pins or similar implements in the position that will cause the least amount of distortion.

U.S. and Canadian models

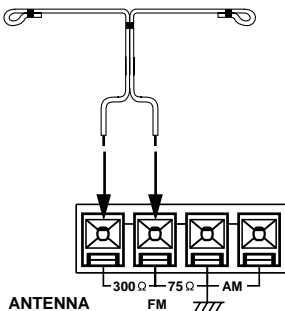

Other models

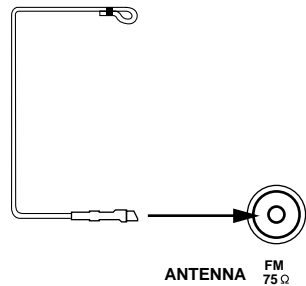

FM outdoor antenna

If the reception is not very clear with the supplied FM antenna, the use of an outdoor antenna is recommended.

Please make sure that you follow the considerations below regarding the location.

- Keep the antenna away from noise sources (neon signs, busy roads etc.).
- It is dangerous to put the antenna close to power lines. Keep it well away from power lines, etc.
- To avoid the risk of lightning and electrical shock, grounding is necessary. Follow item 19 of the "Important Safeguards" on page 3 when you install the outdoor antenna.

U.S. and Canadian models

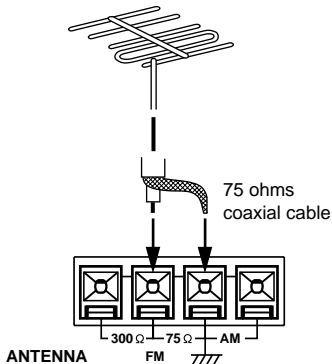

Other models

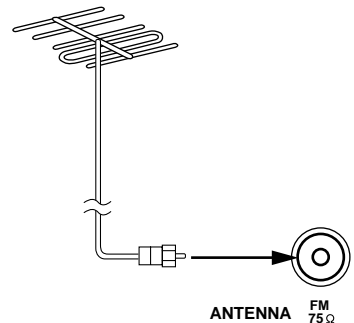

Connecting the AM antenna (U.S. and Canadian models only)

- AM reception is available only on the U.S. and Canadian models.

Assembling the AM loop antenna

Assemble the loop antenna as shown in the illustration.

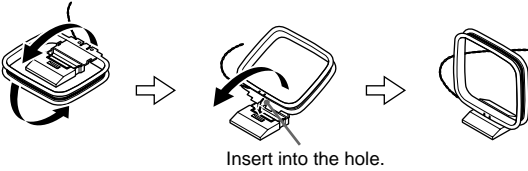

Connecting the antenna cable

1. Open the lever.
2. Insert the wire.
3. Close the lever.

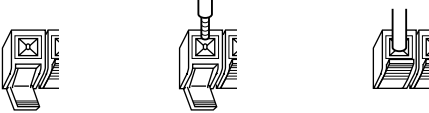

Connecting the AM loop antenna

The AM loop antenna is for indoor use only. Set it in the direction and position where you receive the clearest sound. Put it as far as possible away from this unit, TV, speaker cables, and power cords.

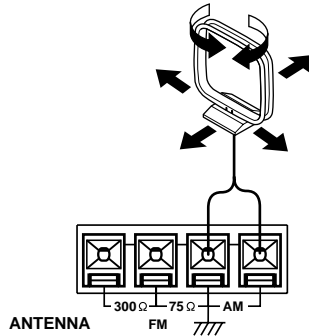

Connecting an AM outdoor antenna

When reception is not satisfactory with the supplied AM loop antenna alone, connection of an outdoor antenna is recommended.

The outdoor antenna will be more effective if it is stretched horizontally above a window or outside.

- Do not remove the AM loop antenna.
- To avoid the risk of lightning and electrical shock, grounding is necessary. Follow item 19 of the "Important Safeguards" on page 3 when you install the outdoor antenna.

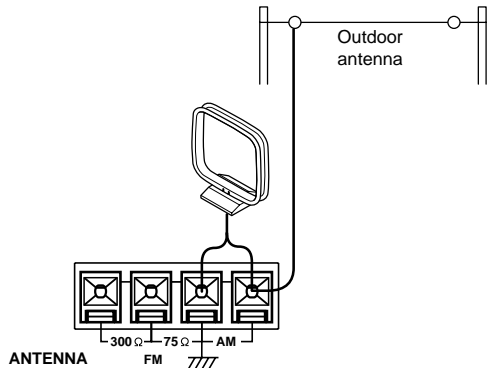

Setting the Clock

The "ACCUCLOCK" features an automatic clock adjusting function automatically sets the clock time on the tuner by means of RDS broadcast signals.

- The "ACCUCLOCK" feature is available only on the European model, and only in areas where RDS broadcasts are available.
- Adjust the clock as explained in "Setting the clock manually" on page 14 if you are using a model U.S. and Canadian models or if you are using the unit in the area where RDS broadcasts are unavailable.

Setting the clock automatically (European models only)

ACCUCLOCK starts operating as soon as the power cord is plugged in. It then searches for an RDS broadcasting station which regularly sends time signals and waits to receive such time information. The tuner should be in STANDBY mode until the clock setting is complete.

The following steps describe how to set the clock automatically:

1. Plug in the power cord.

"AUTO" flashes slowly on the time display.

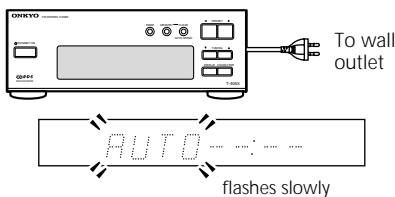

2. Once an RDS station that sends time signals is detected, the indicator flashes more rapidly.

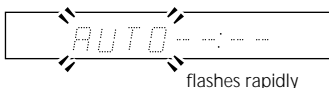

3. Once the time signal is received from the RDS station, "CLOCK ADJUSTED" will scroll on the time display.

4. The received time information (the day of the week and the time) appears.

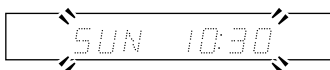

5. The clock starts running.



- It may take about 5 minutes for the time information to be received and displayed.

6. After the clock is initially set, it will be adjusted periodically when the tuner unit is in STANDBY mode.

Notes on using the "ACCUCLOCK" function:

- Make sure that your FM antenna has been properly connected as explained on page 10. It is strongly recommended that you install an outdoor FM antenna since the FM indoor antenna may not receive RDS broadcasts well enough to allow ACCUCLOCK to function properly.
- The clock will display the time in a 24 hour cycle. For example, 5:30 pm will be displayed as "17:30".
- If RDS signals cannot be received, no RDS station will be found.

Or if an RDS signal is present but the signal is not strong enough to allow the ACCUCLOCK to automatically set the time, "- :-" will lit on the display as shown below. If this occurs, set the clock manually. (See page 14.)

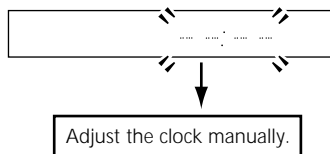

- You may wish to adjust the clock manually because the time information may differ depending on the RDS station detected. If so, follow the manual clock adjustment procedure described on page 14.
- There may be cases in which you can listen to radio broadcasts but cannot use the ACCUCLOCK function.
- Once activated, ACCUCLOCK will remember the RDS station it uses for several weeks even if the power cord of the tuner is unplugged. If you move outside the service area of the memorized RDS station and find out that ACCUCLOCK is not functioning, see "Confirming/changing the RDS Station used by ACCUCLOCK" on page 13 to change the memorized RDS station.

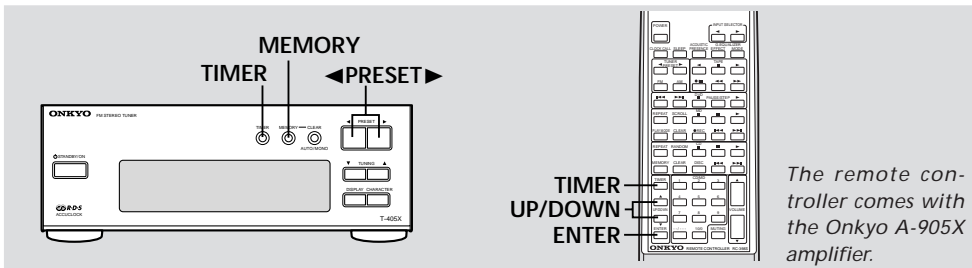

The following procedures are based on the front panel of the T-405X. However, you can also perform the procedure using the remote controller that comes with Onkyo A-905X amplifier.

On the remote controller, press the "ENTER" button and "UP/DOWN" button instead of the "MEMORY" button and PRESET ◀/▶ button respectively.

2 If "AUTO" appears on the display, press the MEMORY button. If "MANUAL" appears on the display, press the PRESET ◀ or ▶ button to select "AUTO," then press the MEMORY button.

Confirming/changing the RDS station used by ACCUCLOCK

If you wish to know which RDS station has been used to set the clock by ACCUCLOCK, or to use a different RDS station signal to set the clock, follow the steps below:

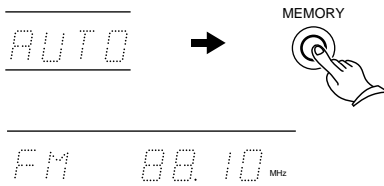

1 Press the TIMER button repeatedly until "ADJUST" is selected on the display, then press the MEMORY button.

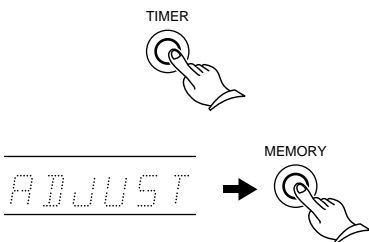

"AUTO" or "MANUAL" appears on the display.

The example shown above indicates that the ACCUCLOCK function uses the RDS station whose information appears on the display (FM 88.10 MHz). If RDS station signals cannot be received successfully, "--.--" will appear instead of the radio frequency of the station. If you wish to change the selected RDS station or if no RDS station is selected, choose the desired RDS station by using the PRESET ◀ or ▶ button, then press the MEMORY button.

Setting the Clock

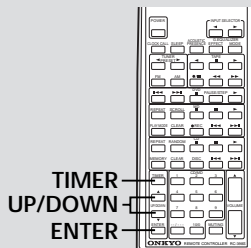
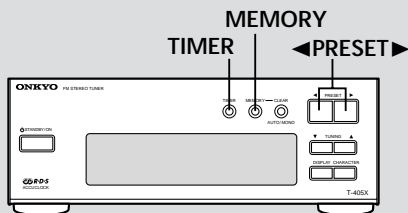

The remote controller comes with the Onkyo A-905X amplifier.

Setting the clock manually

The following procedures are based on the front panel of the T-405X. However, you can also perform the procedure using the remote controller that comes with Onkyo A-905X amplifier. On the remote controller, press the "ENTER" button and "UP/DOWN" button instead of the "MEMORY" button and PRESET ◀/▶ button respectively.

- 1 Press the TIMER button until "ADJUST" is selected on the display, then press the MEMORY button.**

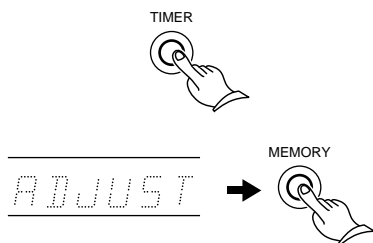

The day of the week will flash on the display.

Non-U.S. and non-Canadian models:

"AUTO" or "MANUAL" appears on the display.

If "MANUAL" appears on the display, press the MEMORY button. If "AUTO" appears on the display, press the PRESET ◀ or ▶ button to select "MANUAL," then press the MEMORY button.

The day of the week will flash on the display.

- 2 Press the PRESET ◀ or ▶ button until the desired day of the week is selected, then press the MEMORY UP/DOWN button.**

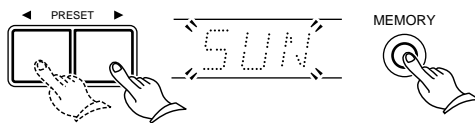

The time will flash on the display.

- 3 Use the PRESET ◀ or ▶ button to set the desired time.**

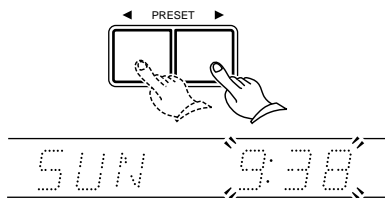

- 4 Press the MEMORY button.**



The clock will start operating.

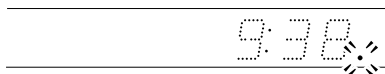

Note

The ACCUCLOCK function is disabled if you set the clock manually. If you wish to enable the ACCUCLOCK function, refer to the following section.

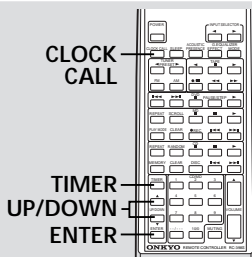
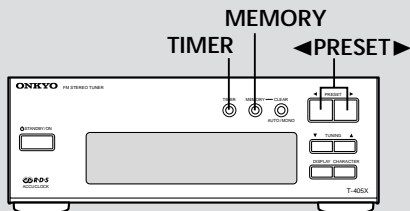

The remote controller comes with the Onkyo A-905X amplifier.

Clock Call function

You can execute the Clock Call function only by using the remote controller that is supplied with A-905X amplifier.

- 1 Press the **CLOCK CALL** button to display the time, press again to cancel the time display.



Note

If the time has not been set, "ADJUST" will flash on the display.

Enabling the ACCUCLOCK function

If you have set the clock manually (see page 14), the ACCUCLOCK function is automatically disabled. To enable this function, follow the steps below:

- 1 Press the **TIMER** button repeatedly until "ADJUST" is selected on the display, then press the **MEMORY** button.

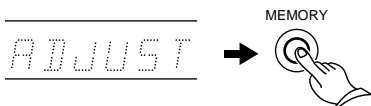

- 2 Press the **PRESET** ◀ or ▶ button until "AUTO" appears, then press the **MEMORY** button.

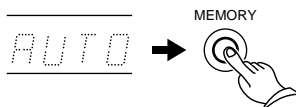
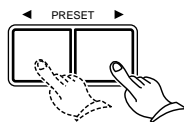

"- - -" instead of the radio frequency will appear on the display.

- 3 Press the **MEMORY** button.

ACCUCLOCK will become active whenever the T-405X enters STANDBY mode.

Receiving stations

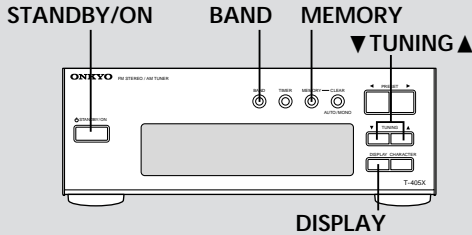

Tuning the radio

Make sure that the input selector on the amplifier has been set to TUNER.

1 Press the STANDBY/ON button.

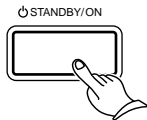

The display changes from clock to frequency (or character) indication.

2 Select FM or AM using the BAND button. (only for U.S. and Canadian models)



Use the TUNING ▼ or ▲ button to change the frequency.

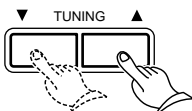

The indoor antenna should be installed on a wall or other surface in the position which gives the best reception. For more information on how to install the antenna, refer to page 10, 11.

Note

AM reception is available on the U.S. and Canadian models.

Display Options:

When you are listening to radio broadcasts, the display usually shows the radio frequency of the selected station. You can, however, change to the current time or character information for the selected station. To do so, press the DISPLAY button repeatedly until the desired indication appears. For more information on how to enter character information, see "Naming a preset station" on page 19.

Using Auto Memory

This function enables you to store the frequencies into memory automatically, without having to go through and store each frequency manually.

1 Hold down the MEMORY button for a few seconds. "AUTO" will start flashing on the display. Keep holding down the button for a few more seconds to start the Auto Memory function.



Hold down



The frequencies are scanned from low to high. Up to 20 FM and 10 AM stations (U.S. and Canadian models) and 20 FM stations (non-U.S. and Canadian models) with the best signal quality are selected, sorted in order from low to high frequency, and stored into the preset memory.

Note

All stations previously stored in memory will be replaced with new Auto Memory stations.

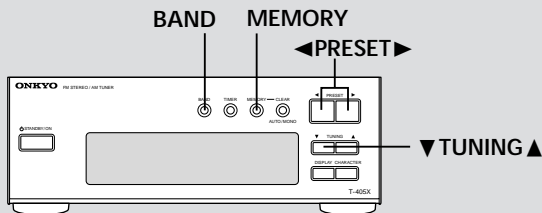

Presetting your favorite stations

You can store your favorite stations in the preset memory. Follow the procedure below:

- 1 Select FM or AM using the BAND button. (only for U.S. and Canadian models)**



Use the TUNING ▼ or ▲ button to select the frequency of your favorite station.

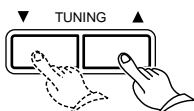

To automatically scan the stations, hold down the TUNING ▼ or ▲ button for more than 0.5 seconds, then release the button. Scanning will stop when a station is tuned in.

- 2 Press the MEMORY button.**

The MEMORY indicator lights up and "....." will flash.

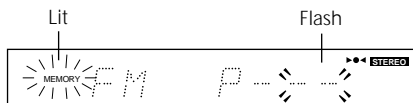

- 3 While "....." is flashing, use the PRESET ◀ or ▶ button to select the preset number into which to store the station frequency.**

The preset number will flash on the display.

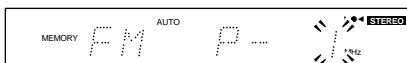
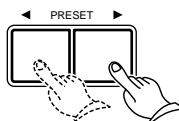

Note

If you select a preset number into which a station has already been programmed, the number will flash rapidly. If you proceed with this number, the original station will be replaced by a new station.

- 4 While the number is flashing, press the MEMORY button.**

The frequency will be stored into the selected preset.

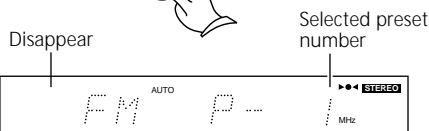

Notes

- Up to 30 stations can be stored in the preset memory.
- If the FM station received is an RDS station that has a PS (Program Service Name), the frequency display will change to the PS display. (Refer to page 22 for more information on the RDS function.) RDS reception is available only on the European models.

Receiving stations

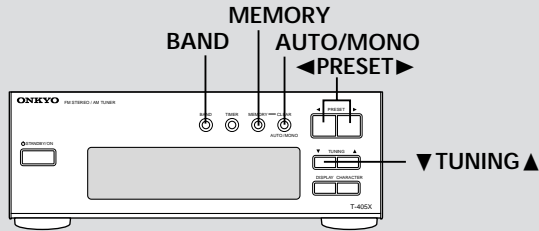

Listening to a stereo radio station

When you tune in a stereo FM station, the STEREO indicator lights up if the signal is sufficiently strong. If the signal is weak, you can still listen to the station in mono mode. In this case, tune in as follows.

1 Press the **AUTO/MONO** button.

The MONO indicator lights up.

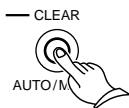

Displayed

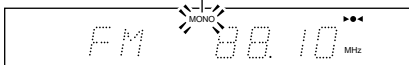

2 Select the station you would like to listen to using the **TUNING** ▼ or ▲ button.

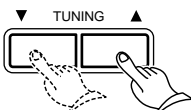

Selecting preset stations

Follow the procedure below to select a preset station stored in memory.

1 Select **FM** or **AM** using the **BAND** button. (only for U.S. and Canadian models)



Use the **PRESET** ◀ or ▶ button to select the desired preset station.

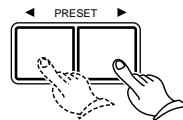

Clearing preset stations

You can clear preset stations from the preset memory.

1 Select the station as explained in the previous section.

2 Press and hold the **MEMORY** button and press the **AUTO/MONO** button within a second.

"....." appears on the display.

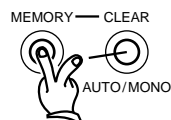

Note

If you fail to press the AUTO/MONO button while holding down the MEMORY button immediately, the AUTO MEMORY function will start operating.

Naming a preset station

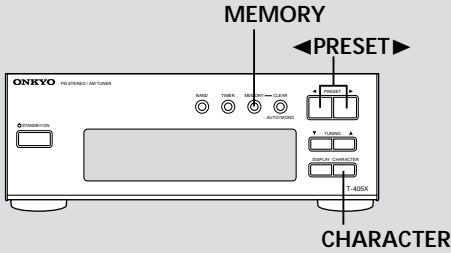

The following 54 characters can be used:
— ABCDEFGHIJKLMNOPQRS
TUVWXYZ " & ' () * + , - / = ? [\]
| 0 1 2 3 4 5 6 7 8 9

Naming a preset station

You can name the preset stations so that the name, instead of the frequency, appears on the display when you press the DISPLAY button. (For more information, see "Display options" on page 16.)

Note

You cannot enter characters for an RDS station that has a program service (PS) name, since the PS name has priority over other character information. (For more information on RDS stations, see page 22.)

- RDS reception is available only on the European models.

1 Select the station you wish to name. (See "Selecting preset stations" on page 18.)

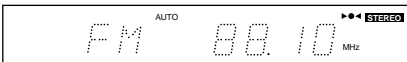

2 Press the CHARACTER button.

The T-405X enters character input mode, and "....." flashes on the display.

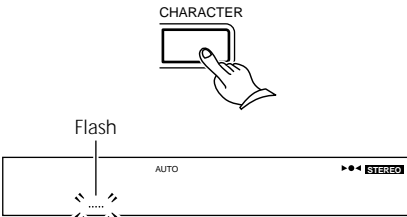

3 Use the PRESET ◀ or ▶ button to select a character.

The character flashes on the display.

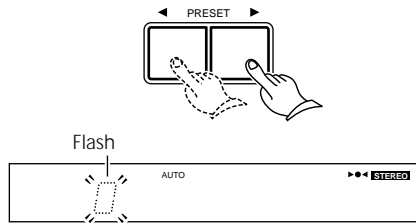

4 Press the MEMORY button to store the character.

Flashing "....." mark appears next to the stored character.

Repeat the steps 3 and 4 to store more characters. You can store up to 8 characters. To enter a space between characters, press the MEMORY button. The bar cursor moves on to the next position.

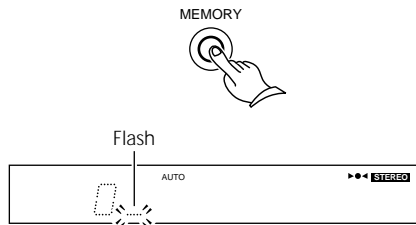

(continued on the next page)

Naming preset stations

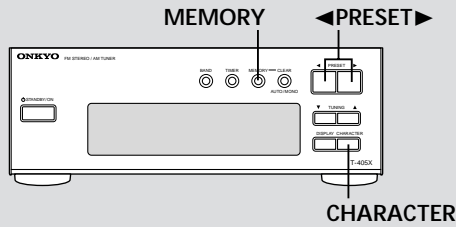

5 When you finish entering all necessary characters, press the **CHARACTER** button to complete the operation.

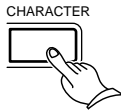

Note

If you have not pressed any button for 16 seconds during the procedure, the operation will complete automatically.

Changing the existing characters

Follow the procedure below to change the existing characters or rename the preset station.

1 Select the station you wish to modify. (See "Selecting preset stations" on page 18.)



2 Press the **CHARACTER** button.

The T-405X enters character input mode, and the first character flashes.

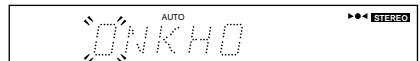

3 Press the **MEMORY** button repeatedly until the character that you want to change flashes.

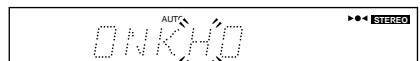

Note

You can use the TUNING ▼ or ▲ button instead of the MEMORY button.

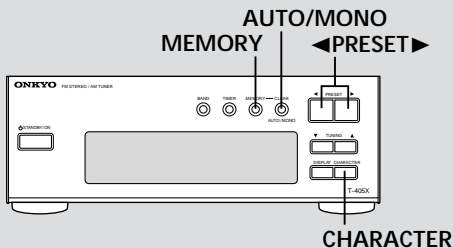

4 Use the PRESET ◀ or ▶ button to change the character.

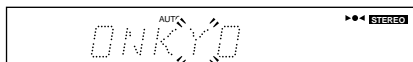
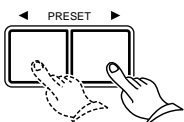

5 Press the MEMORY button to store the character.

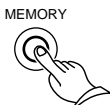

6 Press the CHARACTER button to complete the operation.

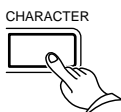

Clearing all names stored in memory

Follow the procedure below to delete the name of the selected preset station.

1 Press the CHARACTER button.

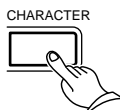

2 While holding down the MEMORY button, press the AUTO/MONO button.

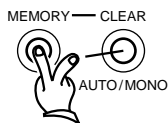

The name will be deleted.

Receiving RDS (European models only)

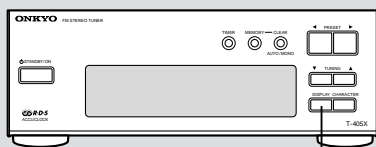

DISPLAY

RDS reception is available only on the European model, and only in areas where RDS broadcasts are available.

What is RDS?

Many FM stations now transmit RDS signals which contain additional information. RDS provides you with various services so that you can choose a station broadcasting your favorite categories of music or other information. The information below is available through the T-405X.

PS: Program Service Name

RT: Radio Text

Note

If radio signals are weak, RDS may not be received.

Displaying Radio Text (RT)

Radio Text can be displayed as follows.

Note

If the station you are listening to is not an RDS station, no Radio Text will be displayed.

If the current station you are listening to is not an RDS station, only the frequency of the station and the characters (see page 19) appear. (If no characters have been entered, only the frequency information will appear.)

When RT is received, it can sometimes take between a few seconds and 15 seconds (more or less) to display.

Sometimes the following messages will be shown on the display.

WAIT: This message indicates that it requires more time to receive the RT information. When the information is received, the characters will scroll across the display.

NO TEXT: This message appears for three seconds and indicates that even though an RDS station is being received, the signal does not contain RT information.

1 Each time you press the DISPLAY button, the display changes as follows.

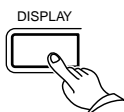
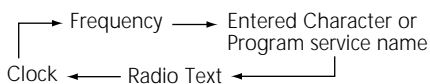

Using the timer

The T-405X features a Timer function that enables you to start playing or recording a specified component at a specified time. To use this function, you need to configure a system that includes an ONKYO amplifier A-905X connected to the T-405X and other components via **RI** REMOTE CONTROL jacks. Refer to "System connection for use of Timer function" and "Connecting to other components" on pages 7 through 9 for more information on making the connections.

Buttons and modes for the Timer function

The following buttons and setting modes are used to operate the Timer function. You can use the remote controller (that comes with the ONKYO amplifier A-905X), as well as the front panel of the T-405X.

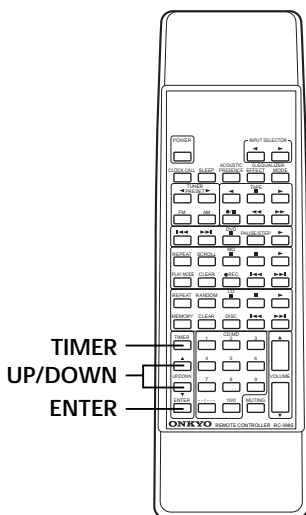
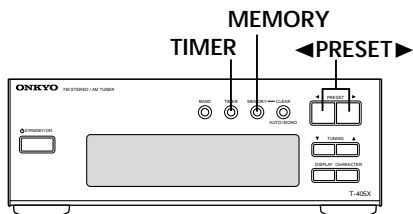

The remote controller comes with the Onkyo A-905X amplifier.

TIMER button

Use this button to select a timer mode. The timer mode will change each time you press this button.

PRESET ◀/▶ buttons (T-405X), or UP/DOWN (▲/▼) buttons (Remote controller)

Use these buttons to select the details of the mode or to change values.

MEMORY button (T-405X), or ENTER button (Remote controller)

Use this button to enter the selected mode or numbers.

Timer setting modes:

- **WEEKDAY:** This mode enables you to listen to a specified component at a designated time on weekdays.
- **WEEKEND:** This mode enables you to listen to a specified component at a designated time on weekends.
- **REC:** This mode enables you to record your favorite broadcasting program(s) starting at a designated time.
- **DAY SET:** This mode enables you to change the day setting (definition) of WEEKDAY or WEEKEND.
- **ADJUST:** This mode enables you to set and adjust the clock.

The following sections (page 24–28) describe operations using the front panel of the T-405X. As mentioned above, however, you can also perform the following operations from the remote controller that comes with the Onkyo A-905X amplifier.

On the remote controller, press the ENTER button and UP/DOWN (▲/▼) buttons instead of the MEMORY button and PRESET ◀/▶ buttons

Using the timer

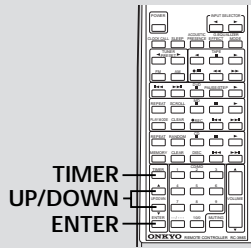
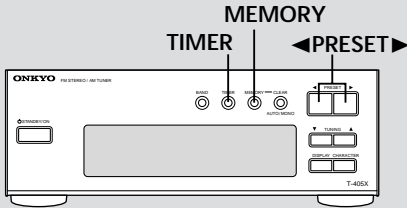

The remote controller comes with the Onkyo A-905X amplifier.

Changing the WEEKDAY and WEEKEND settings

You can define or change which day is WEEKDAY or WEEKEND. You can also define the day as both WEEKDAY and WEEKEND in order to program two timer settings on the same day.

The initial factory settings are:

WEEKDAY : Monday – Friday

WEEKEND : Saturday and Sunday

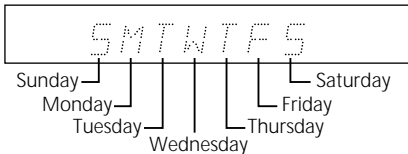

1 Press the **TIMER** button repeatedly until “DAY SET” appears on the display, then press the **MEMORY** button.

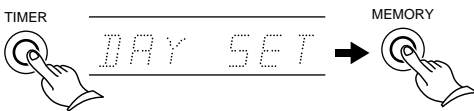

2 Press the **PRESET** ◀ or ▶ button to select “WEEKEND” or “WEEKDAY”.
“END” or “DAY” flashes.



3 Press the **MEMORY** button.



The current WEEKDAY or WEEKEND setting will be displayed.

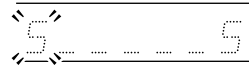

4 Press the **MEMORY** button repeatedly until the desired day of the week flashes.

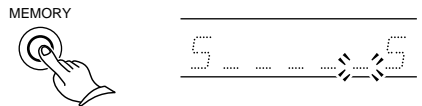

5 Press the **PRESET** ◀ or ▶ button to display the desired day of the week.



Pressing the **PRESET** ◀ or ▶ button repeatedly toggles between the day indication and the bar cursor (....).

6 Press the **MEMORY** button to confirm the selection.

When you press the **MEMORY** button while the character or bar cursor at the right end is flashing, the unit completes the setting.

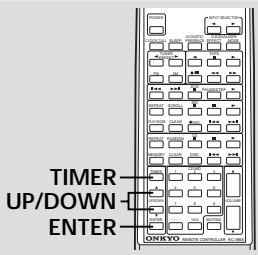
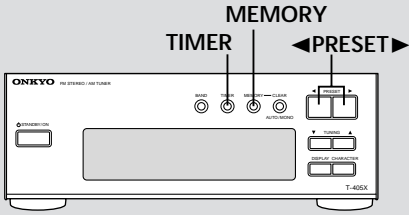

The remote controller comes with the Onkyo A-905X amplifier.

Programming to play at a specified time

Before using the timer for listening to or recording broadcast programs, you need to store the preset stations. (Refer to "Receiving stations" on page 16, 17 for information how to preset stations.)

- When you store the ON time, the display automatically indicates that the OFF time is one hour after the ON time you specified.

3 Press the PRESET ◀ or ▶ button to select the OFF time, and press the MEMORY button.

1 Press the TIMER button repeatedly until "WEEKDAY" or "WEEKEND" is displayed, and press the MEMORY button.

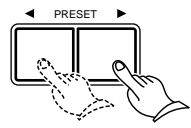
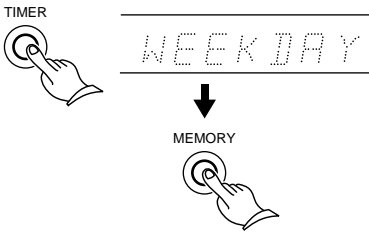

4 Press the PRESET ◀ or ▶ button to select the source (FM/AM/CD/MD/TAPE/LINE-1/LINE-2), and press the MEMORY button.

2 Press the PRESET ◀ or ▶ button to set the ON time, and press the MEMORY button.

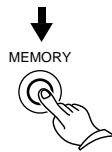
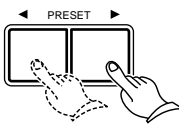
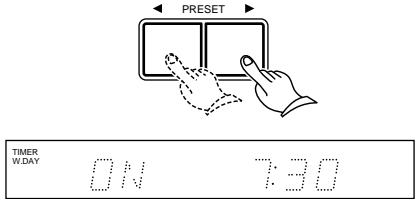

If you select "FM" or "AM", press the PRESET ◀ or ▶ button again to select the preset number and press the MEMORY button.

- AM reception is available only on the U.S. and Canadian models.

Using the timer

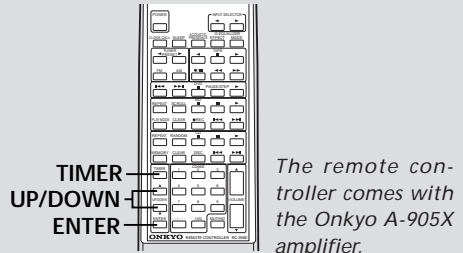
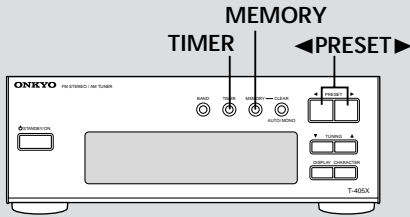

5 Press the **STANDBY/ON** button on the Amplifier A-905X to set the **STANDBY** mode.

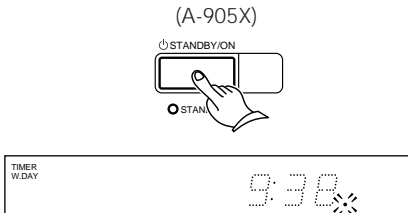

Notes

- The clock of the tuner must be set correctly before programming the timer.
- Make sure that the specified source component is connected to the amplifier, and that the CD, MD, or cassette tape has been inserted into the appropriate component.
- After setting the timer, be sure to set the amplifier in **STANDBY** mode. If the amplifier is not in **STANDBY** mode, the timer will not work.
- Make sure that the **POWER** switch on the A-905X Amplifier is set to **ON**.

Programming to record at a specified time

REC mode of the Timer function enables you to record a specified source at a specified time.

Notes

- To perform timer recording to a tape, you need to use a cassette tape deck that features the **RI** mark, such as the K-505X.
- To perform timer recording to a mini disc, you need to use an MD recorder that features the **RI** mark, such as the MD-105X.

1 Press the **TIMER** button repeatedly until "**REC**" appears on the display, then press the **MEMORY** button.

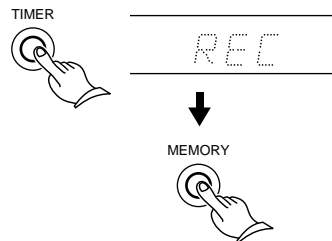

2 Press the **PRESET** ◀ or ▶ button to select the day of the week when you wish to start recording, then press the **MEMORY** button.

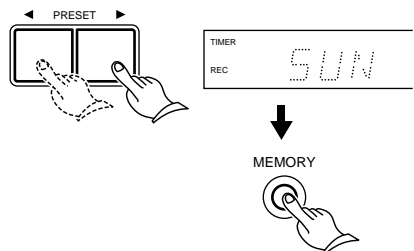

You can select "**NEXT**" instead of the day of the week. If you do so, recording will start at the next occurrence of the indicated time.

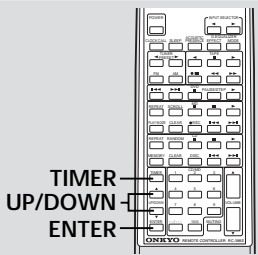
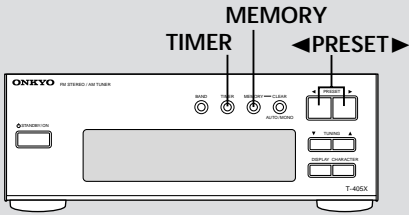

The remote controller comes with the Onkyo A-905X amplifier.

3 Press the PRESET ◀ or ▶ button to set the ON time, and press the MEMORY button.

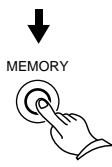
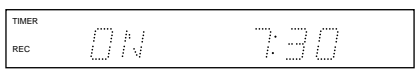
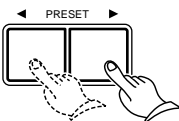

- When you store the ON time, the display automatically indicates that the OFF time is one hour after the ON time you specified.

4 Press the PRESET ◀ or ▶ button to set the OFF time, then press the MEMORY button.

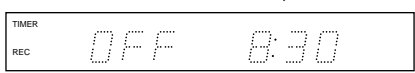
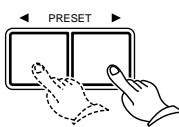

5 Press the PRESET ◀ or ▶ button to select the source (FM/AM/LINE-1/ LINE-2), and press the MEMORY button.

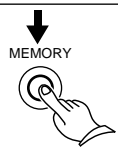
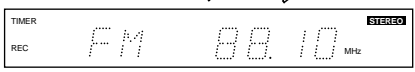
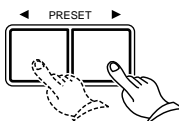

If you select "FM" or "AM", press the PRESET ◀ or ▶ buttons again to select the preset number, then press the MEMORY button.

- AM reception is available only on the U.S. and Canadian models.

6 Press the PRESET ◀ or ▶ button to select the recording component (MD REC, TAPE REC, or MD/TAPE REC), and press the MEMORY button.

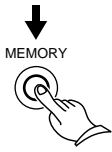
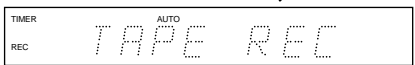
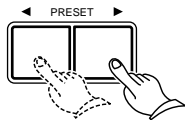

Using the timer

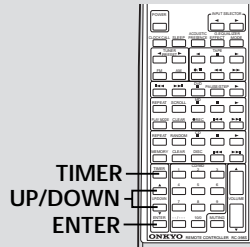
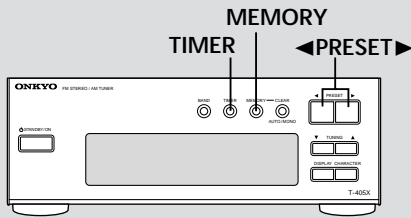

The remote controller comes with the Onkyo A-905X amplifier.

- 1 Press the **STANDBY/ON** button on the Amplifier A-905X to set the **STANDBY** mode.

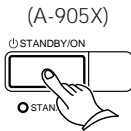

Notes

- Since muting is automatically turned on when the timer is used to record, the sound cannot be heard during recording. To monitor recording, press the **MUTING** button on the remote controller to cancel muting.
- Timer recording is activated once. After recording, the **REC** mode setting will be cancelled.
- After setting the timer, be sure to set the amplifier in **STANDBY** mode. If the amplifier is not in **STANDBY** mode, the timer will not work.
- Make sure that the **POWER** switch on the A-905X Amplifier is set to **ON**.

Switching the timer ON/OFF

You can switch the timer **ON/OFF** to cancel the timer setting, to enable the timer again, or to perform timer recording again.

When the Timer function is enabled, the selected timer mode such as "WEEKDAY", "WEEKEND", and "REC" appears in the upper left corner of the display.

Note

To switch the timer **ON**, first you need to program the time value.

- 1 Press the **TIMER** button repeatedly until the timer mode (**WEEKDAY**, **WEEKEND** or **REC**) that you wish to enable or disable appears on the upper left corner of the display.

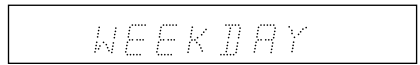

- 2 Press the **PRESET** ◀ or ▶ button to switch the selected mode **ON** or **OFF**.

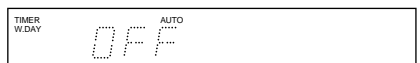
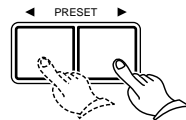

- 3 Press the **MEMORY** button to confirm the selection.



SLEEP

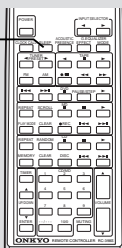

The remote controller comes with the Onkyo A-905X amplifier.

Sleep function

The Sleep function can be performed only by using remote controller that comes with the amplifier A-905X.

The SLEEP timer automatically sets the entire system to standby mode after a specified period of time.

1 Start playing something you would like to listen to.

(CD, tape, MD or radio broadcast).

2 Press the SLEEP button repeatedly to set the desired sleep time.

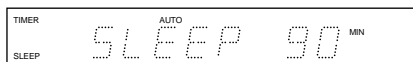

The time value will decrease from 90 minutes to 10 minutes in steps of 10 minutes.

After a specified period of time, the power will be switched off automatically.

- To check the remaining time while the SLEEP function is active, press the SLEEP button.

Cancelling the SLEEP setting

Press the SLEEP button repeatedly until the SLEEP indicator on the display disappears.

Notes for timer setting

- Make sure that the clock has been set correctly before setting the timer.
- After setting the timer, be sure to set the amplifier in standby mode. If the amplifier is not in standby mode, the timer will not work.
- When the power is turned on by one of the timer mode settings, the other timer modes may not be activated at their ON time. The power will be switched off by the first timer mode at its OFF time. (See the figure below.)
- If you press the SLEEP button during timer play or timer recording, the power will be switched off at the SLEEP timer's OFF time.
- If more than two timer mode settings are made at the same time, the "WEEKDAY" setting has the priority over the "WEEKEND" setting. The "REC" mode setting has no priority.
- The timer recording setting will be cancelled if the recording does not start at the ON time (for example, if the power is already on).

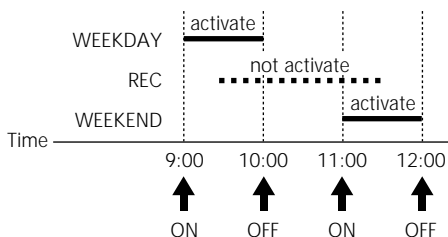

Other Information

Troubleshooting

Symptom	Cause	Remedy
No power.	<ul style="list-style-type: none"> Power cord is disconnected. 	<ul style="list-style-type: none"> Connect power cord.
AM stations cannot be received.	<ul style="list-style-type: none"> AM loop antenna is not attached. 	<ul style="list-style-type: none"> Connect the supplied AM loop antenna to the AM antenna terminals.
Buzzing noise on AM (particularly conspicuous at night or with weak stations).	<ul style="list-style-type: none"> Noise from electrical apparatus such as fluorescent lamp. 	<ul style="list-style-type: none"> Move the AM loop antenna to different position. Set up an outdoor AM antenna.
High-pitched noise or buzzing noise on AM.	<ul style="list-style-type: none"> Noise from TV set. 	<ul style="list-style-type: none"> Place the AM loop antenna as far as possible from the TV. Move unit away from TV set.
Crackling noise on AM, FM.	<ul style="list-style-type: none"> Noise caused by turning a fluorescent lamp on and off. Noise from automobile ignition. 	<ul style="list-style-type: none"> Move the antenna as far away as possible from the fluorescent lamp. Install an outdoor FM antenna as far away as possible from the road.
Tuning indicators and stereo indicator light but sound is distorted and separation is bad.	<ul style="list-style-type: none"> Station is too strong. Multiple reflection of the radio waves because of tall buildings or mountains. 	<ul style="list-style-type: none"> Change to FM indoor antenna. Use antenna that has better directivity and select a point with the least distortion.
Tuning indicators and stereo indicator flicker and hiss is heard on FM.	<ul style="list-style-type: none"> Station is too weak. Stereo FM broadcasts cover only about half the distance of an ordinary broadcast. 	<ul style="list-style-type: none"> Install an outdoor FM antenna. Change the position or direction of the outdoor antenna. Switch to mono reception. (Even stereo broadcasts will be heard in mono.)
No station or undesired station is recalled when a Preset button is pressed.	<ul style="list-style-type: none"> The power cord has been unplugged for a long time. 	<ul style="list-style-type: none"> The memory contents are lost if the power is not turned on and off a few times each month. Store all stations in the memory again and remember to turn the power on and off a few times each month.
The RDS function does not work.	<ul style="list-style-type: none"> The station is not an RDS station. The reception station signal is too weak. Too much interference. 	<ul style="list-style-type: none"> Receive an RDS station. Install an outdoor FM antenna. Change the position or direction of the outdoor antenna. Move the antenna as far away as possible from fluorescent lamps. Install an outdoor FM antenna.
ACCUCLOCK function does not work.	<ul style="list-style-type: none"> The station is not an RDS station, or received signal is too weak. RDS broadcasts cannot be received. 	<ul style="list-style-type: none"> See the remedies for the RDS function problem above. Set and adjust according to instructions above.

- Excessive electrical interference may temporarily render this system's sensitive microcomputer inoperable. If this happens, unplug the system for at least five seconds.

Index to parts and controls

Front panel

For more information about buttons, turn to the page number in the brackets [].

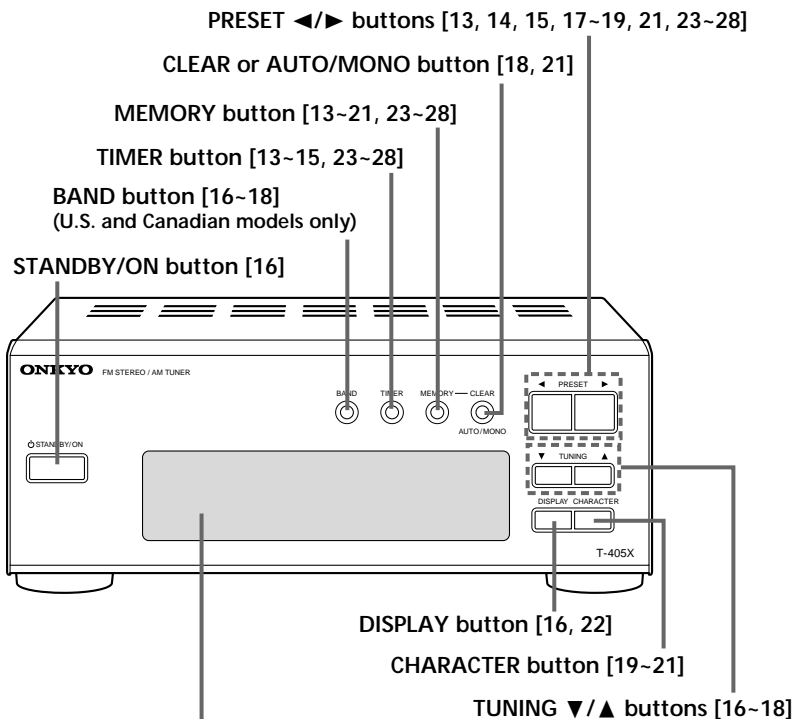

Display

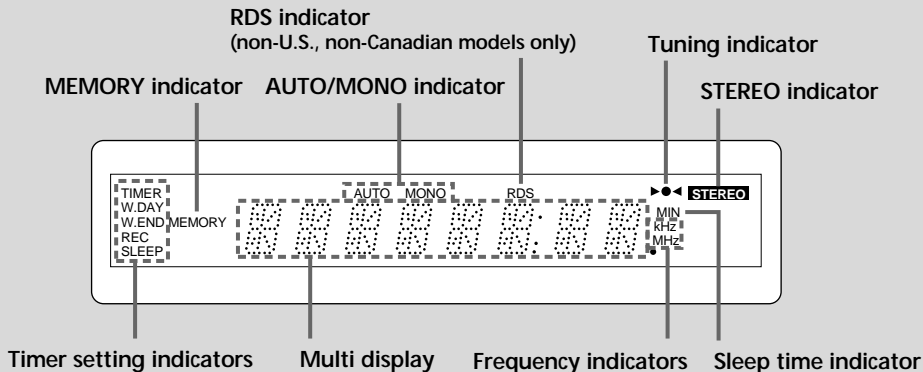

Specifications

FM

Tuning Range:

87.90 – 107.90 MHz, 200 kHz steps
(U.S. & Canadian models)

87.50 – 108.00 MHz, 50 kHz steps
(Other area models)

Usable Sensitivity:

Mono : 12.8 dBf 1.2 μ V, 75 Ohms IHF

Stereo: 19.2 dBf 2.5 μ V, 75 Ohms IHF

50dB Quieting Sensitivity:

Mono : 18.0 dBf 2.2 μ V, 75 Ohms

Stereo: 38.0 dBf 22 μ V, 75 Ohms

Capture Ratio : 1.5 dB

Image Rejection Ratio : 85 dB

IF Rejection Ratio : 90 dB

Signal-to-Noise Ratio : Mono: 73 dB IHF

Stereo: 66 dB IHF

Selectivity : 50 dB DIN (\pm 300 kHz, 40 kHz dev.)

AM Suppression Ratio : 50 dB

Total Harmonic Distortion : Mono: 0.5%

Stereo: 0.8%

Frequency Response : 30 – 15,000 Hz (\pm 1.5 dB)

Stereo Separation : 40 dB at 1 kHz

30 dB at 70 – 10,000 Hz

Output Level : 0.5 V (U.S. & Canadian models)

0.75 V (Other area models)

Muting Level : 17.2 dBf 2.0 μ V, 75 Ohms

AM

Tuning Range :

530 – 1,710 kHz, 10 kHz steps

Usable Sensitivity : 30 μ V

Image Rejection Ratio : 30 dB

IF Rejection Ratio : 40 dB

Signal-to-Noise Ratio : 40 dB

Total Harmonic Distortion : 0.8%

Output Level: 0.15 V

General

Power Supply :

AC 120 V, 60 Hz

AC 230 V, 50 Hz

Power Consumption : 9 W

Dimensions (W \times H \times D) :

205 \times 76 \times 279 mm

8-1/16" \times 3" \times 11"

Weight : 1.7 kg, 3.7 lbs.

AM reception is available only on the U.S. and Canadian models.

Specifications and external appearance are subject to change without notice as a result of product improvement.

ONKYO CORPORATION

Sales & Product Planning Div. : 2-1, Nisshin-cho, Neyagawa-shi, OSAKA 572-8540, JAPAN

Tel: 0720-31-8111 Fax: 0720-33-5222 <http://www.onkyo-intl.com>

ONKYO U.S.A. CORPORATION

18 Park Way, Upper Saddle River, N.J. 07458, U.S.A.

Tel: 201-785-2600 Fax: 201-785-2650 <http://www.onkyousa.com>

ONKYO EUROPE ELECTRONICS GmbH

Liegnitzerstrasse 6, 82194 Groebenzell, GERMANY

Tel: +49-8142-4401-0 Fax: +49-8142-4401-555 <http://www.onkyo.net>

ONKYO CHINA LIMITED

Units 2102-2107, Metroplaza Tower I, 223 Hing Fong Road, Kwai Chung, N.T., HONG KONG Tel: 852 2429 3118 Fax: 852 2428 9039



SN 29342744

Printed in Japan
I9905-1



Free Manuals Download Website

<http://myh66.com>

<http://usermanuals.us>

<http://www.somanuals.com>

<http://www.4manuals.cc>

<http://www.manual-lib.com>

<http://www.404manual.com>

<http://www.luxmanual.com>

<http://aubethermostatmanual.com>

Golf course search by state

<http://golfingnear.com>

Email search by domain

<http://emailbydomain.com>

Auto manuals search

<http://auto.somanuals.com>

TV manuals search

<http://tv.somanuals.com>