

TA-RW544/344

Stereo Cassette Tape Deck Instruction Manual

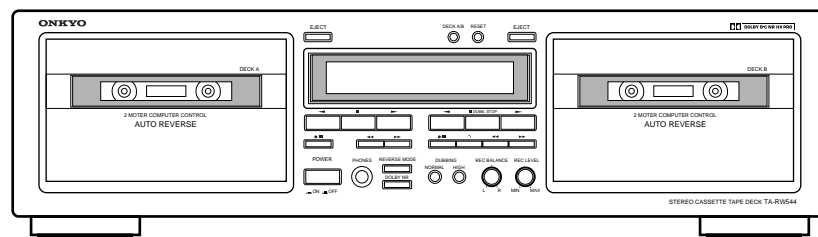

CONTENTS

Features	2	Tape Dubbing	12
Important Safeguards	3	Useful Recording Functions	13
Precautions	3	Making Good Sound Recordings	13
Control Positions and Names	4	Connecting ONKYO Components for RI Components	14
Setting the Voltage Selector	5	CD Synchro Recording System	14
System Connections	5	Reverse Mode Function	15
Power Connections	5	Handling Cassette Tapes	16
To Play a Tape	6	Cassette Deck Maintenance	17
Useful Functions Available during Playback (TA-RW544 Only)	7	Specifications	17
Recording	8	Troubleshooting Guide	18

Thank you

for your purchase of the

ONKYO TA-RW544/344 Cassette Tape Deck.

Please read this manual thoroughly before making connections and plugging in the AC power cord.

Following the instructions in this manual will enable you to obtain optimum performance and maximum listening enjoyment from your new TA-RW544/344.

Please retain this manual for future reference.

Features

■ Convenient dubbing & nonstop music

Excellent performance is not this deck's singular feature.

The TA-RW544 is two outstanding recording decks in one. So you can make a copy for yourself and one for a friend at the same time. Or keep recording or playing tape after tape with its dual auto reverse (to capture and enjoy those longer shows).

■ Rugged 2 x 2 motor transport system

Separate capstan and reel motors for each transport not only prevent overloading, they provide the precise tape movement needed for accurate reproduction. They also contribute to the long-life, trouble-free performance that ONKYO cassette decks are famous for.

■ Dolby HX Pro headroom extension

Dolby HX Pro extends the dynamic headroom to capture the wider musical dynamics of CDs and other digital sources. It provides noticeably cleaner reproduction of those crucial higher frequencies by improving the tape's ability to capture high-level signals without saturation. Another plus is the tapes you record with Dolby HX Pro can be played back on decks without Dolby HX Pro, for improved sound performance.

■ Music search (TA-RW544 only)

When you're playing a tape back, our Music Search system does just what you might expect—lets you automatically skip forward or backward to easily find the exact beginning of each selection. It works by sensing pauses between music selections.

■ One-touch CD synchronized recording

This handy feature lets you effortlessly and accurately record your favorite CDs when your deck is connected to virtually any **RI** compatible ONKYO CD player.

■ z (Remote Interactive) system compatible

As might be expected, the TA-RW544/344 is fully compatible with ONKYO's **RI** (Remote Interactive) system. This means you can control virtually all of the cassette deck's major functions with other ONKYO remote controls.

■ Other features

- **Auto tape selector:** Automatically sets bias and equalization for the type of tape you insert.
- **Auto spacing:** Handy for inserting blank spaces when re-recording or editing tapes, or recording from CDs, records and the radio.
- **Headphone jack:** For private listening.
- **Full repeat:** Repeats both A and B sides of both transports up to eight times, then shuts off automatically.
- **8-segment fluorescent peak metering:** Allows you to accurately adjust recording levels for optimum performance.

Declaration of Conformity

We, ONKYO EUROPE
ELECTRONICS GMBH
INDUSTRIESTRASSE 18/20
82110 GERMERING,
GERMANY



declare in own responsibility, that the ONKYO product described in this instruction manual is in compliance with the corresponding technical standards such as EN55013, EN55020, EN60555-2, -3 and EN60065

GERMERING, GERMANY

H. YAMAZOE

ONKYO EUROPE ELECTRONICS GMBH

FOR CANADIAN MODEL: (POUR LE MODELE CANADIEN)

• For models having a power cord with a polarized plug
CAUTION: TO PREVENT ELECTRIC SHOCK, MATCH WIDE BLADE OF PLUG TO WIDE SLOT, FULLY INSERT.

• Sur les modèles dont la fiche est polarisée.
ATTENTION: POUR ÉVITER LES CHOCS ÉLECTRIQUES, INTRODUIRE LA LAME LA PLUS LARGE DE LA FICHE DANS LA BORNE CORRESPONDANTE DE LA PRISE ET POUSSER JUSQU'AU FOND.

ATTENTION FOR BRITISH MODEL

- Replacement and mounting of an AC plug on the power supply cord of this unit should be performed only by qualified service personnel.
- **IMPORTANT:** The wires in the mains lead are coloured in accordance with the following code:
Blue: Neutral
Brown: Live

As the colours of the wires in the mains lead of this apparatus may not correspond with the coloured markings identifying the terminals in your plug, proceed as follows:

The wire which is coloured blue must be connected to the terminal which is marked with the letter N or coloured black. The wire which is coloured brown must be connected to the terminal which is marked with the letter L or coloured red.

IMPORTANT

A 5 amp fuse is fitted in this plug. Should the fuse need to be replaced, please ensure that the replacement fuse has a rating of 5 amps and that it is approved by ASTA or BSI to BS1362. Check for the ASTA mark or the BSI mark on the body of the fuse. **IF THE FITTED MOULDED PLUG IS UNSUITABLE FOR THE SOCKET OUTLET IN YOUR HOME THEN THE FUSE SHOULD BE REMOVED AND THE PLUG CUT OFF AND DISPOSED OF SAFELY. THERE IS A DANGER OF SEVERE ELECTRICAL SHOCK IF THE CUT OFF PLUG IS INSERTED INTO ANY 13 AMP SOCKET.**

Supplied accessory

Audio connection cable

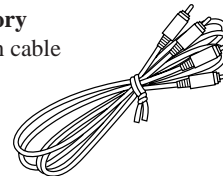

WARNING

"TO REDUCE THE RISK OF FIRE OR ELECTRIC SHOCK, DO NOT EXPOSE THIS APPLIANCE TO RAIN OR MOISTURE."

CAUTION

"TO REDUCE THE RISK OF ELECTRIC SHOCK, DO NOT REMOVE COVER (OR BACK). NO USER-SERVICEABLE PARTS INSIDE. REFER SERVICING TO QUALIFIED SERVICE PERSONNEL."



CAUTION

RISK OF ELECTRIC SHOCK
DO NOT OPEN



- The lightning flash with arrowhead symbol, within an equilateral triangle, is intended to alert the user to the presence of uninsulated "dangerous voltage" within the product's enclosure that may be of sufficient magnitude to constitute a risk of electric shock to persons.
- The exclamation point within an equilateral triangle is intended to alert the user to the presence of important operating and maintenance (servicing) instructions in the literature accompanying the appliance.

Important Safeguards

- 1. Read Instructions** — All the safety and operating instructions should be read before the appliance is operated.
 - 2. Retain Instructions** — The safety and operating instructions should be retained for future reference.
 - 3. Heed Warnings** — All warnings on the appliance and in the operating instructions should be adhered to.
 - 4. Follow Instructions** — All operating and use instructions should be followed.
 - 5. Water and Moisture** — The appliance should not be used near water — for example, near a bathtub, washbowl, kitchen sink, laundry tub, in a wet basement, or near a swimming pool, and the like.
 - 6. Carts and Stands** — The appliance should be used only with a cart or stand that is recommended by the manufacturer.
- 6A.** An appliance and cart combination should be moved with care. Quick stops, excessive force, and uneven surface may cause the appliance and cart combination to overturn.

PORTABLE CART WARNING



- 7. Wall or Ceiling Mounting** — The appliance should be mounted to a wall or ceiling only as recommended by the manufacturer.
- 8. Ventilation** — The appliance should be situated so that its location or position does not interfere with its proper ventilation. For example, the appliance should not be situated on a bed, sofa, rug, or similar surface that may block the ventilation openings; or if placed in a built-in installation, such as a book case or cabinet that may impede the flow of air through the ventilation openings, there should be free space of at least 20 cm (8 in.) and open up behind the appliance.
- 9. Heat** — The appliance should be situated away from heat sources such as radiators, heat registers, stoves, or other appliances (including amplifiers) that produce heat.
- 10. Power Sources** — The appliance should be connected to a power supply only of the type described in the operating instructions or as marked on the appliance.
- 11. Polarization** — The polarization of the plug is a safety feature. The polarized plug will only fit the outlet one way. If the plug does not fit fully into the outlet, try reversing it. If there is still trouble inserting it, the user should seek the services of a qualified electrician. Under no circumstances should the user attempt to defeat the polarization of the plug.
- 12. Power-Cord Protection** — Power-supply cords should be routed so that they are not likely to be walked on or pinched by items placed upon or against them, especially near plug, convenience receptacles, and the point where they exit from the appliance.
- 13. Cleaning** — The appliance should be cleaned only as recommended by the manufacturer.
- 14. Nonuse Periods** — The power cord of the appliance should be unplugged from the outlet when left unused for a long period of time.
- 15. Object and Liquid Entry** — Care should be taken so that objects do not fall and liquids are not spilled into the enclosure through openings.
- 16. Damage Requiring Service** — The appliance should be serviced by qualified service personnel when:
 - A. The power-supply cord or the plug has been damaged; or
 - B. Objects have fallen, or liquid has been spilled into the appliance; or
 - C. The appliance has been exposed to rain; or
 - D. The appliance does not appear to operate normally or exhibits a marked change in performance; or
 - E. The appliance has been dropped, or the enclosure damaged.
- 17. Servicing** — The user should not attempt to service the appliance beyond that described in the operating instructions. All other servicing should be referred to qualified service personnel.

Precautions

1. Warranty Claim

You can find the serial number on the rear panel of the unit. In case of warranty claim, please report this number.

2. Recording Copyright

Recording of copyrighted material for other than personal use is illegal without permission of the copyright holder.

3. Deck Location

- Do not use or leave in direct sunlight or in other places subject to high temperature and humidity. The unit should also not be left in potentially hot places such as near heating appliances. Excessive heat and moisture can lead to internal damage and serious malfunctions. (This also applies to cassette tapes.) The recommended ambient temperature range is 5°C to 35°C.
 - Avoid damp and dusty places and locations prone to vibrations.
 - Be extremely careful with the recording/playback heads. Clean and demagnetize them regularly, but under no circumstances should magnets or other metals be used anywhere near the heads.
 - This unit is extremely sensitive to magnetic fields, so do not use near large speakers or other devices which generate magnetic fields.
 - Hum may even be included by magnetic flux leakage from the power transformer in certain amplifiers. Therefore, this unit should also be kept clear of the amplifier.
 - Do not remove the cabinet case. If any of the internal parts are handled, there is a considerable danger of electric shock.
- ## 4. Cassettes to Avoid:
- Cassettes with poorly formed cases that rattle during rewind and fast forward.
 - Low cost cassettes with no guide roller or pressure pad spring should never be used for stereo.
 - C-120 cassettes — because the tape and the coating are extremely thin, distortion levels are high. Also, even a slight stretching of the tape will make it susceptible to being caught up in the pinch roller and capstan.
 - Endless tapes, if used for a long period of time, can overheat.

5. Power

WARNING

BEFORE PLUGGING IN THE UNIT FOR THE FIRST TIME, READ THE FOLLOWING SECTION CAREFULLY.

- Some models are designed for use only with the power supply voltage of the region where they are sold.

European and Australian models:	AC 230 V, 50 Hz
U.S.A. and Canadian models:	AC 120 V, 60 Hz
Worldwide model:	AC 120/220-230 V switchable, 50/60 Hz
- Voltage Selector (Rear Panel)

The worldwide model is equipped with a voltage selector to conform with local power supplies. Be sure to set this switch to match the voltage of the power supply in your area before plugging in the unit. (See “Setting the Voltage Selector [Worldwide Model Only]” on page 5.) Models without a voltage selector can only be used in areas where the power supply voltage is the same as that of the unit.

Dolby noise reduction and HX Pro headroom extension manufactured under license from Dolby Laboratories Licensing Corporation. HX Pro originated by Bang & Olufsen. “Dolby,” the double-D symbol and “HX PRO” are trademarks of Dolby Laboratories Licensing Corporation.

Control Positions and Names

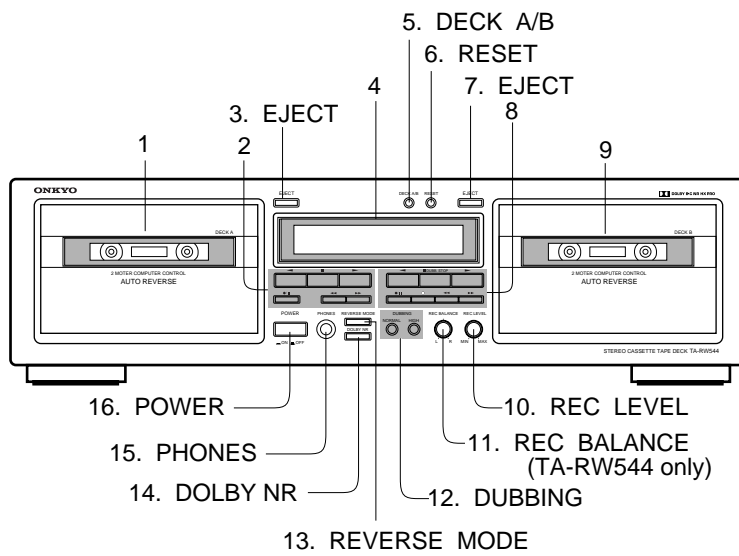

(TA-RW544)

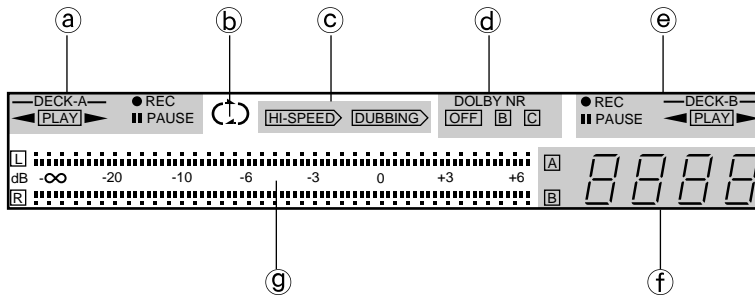

(TA-RW344)

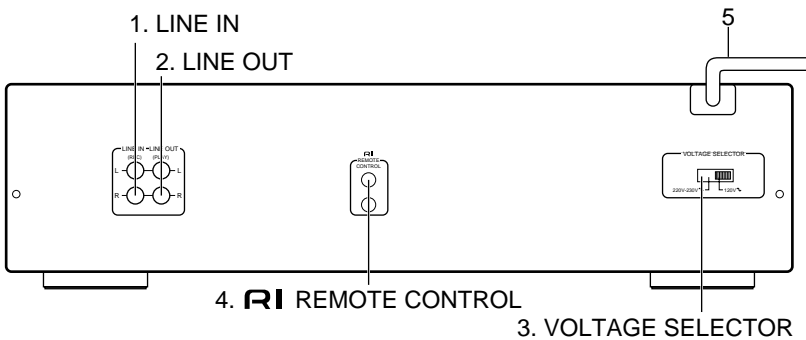
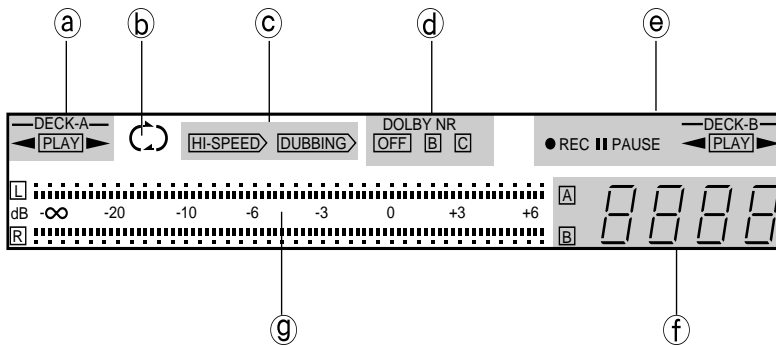

If there is a protective film on the surface of the display, which makes it difficult to read the display, remove it.

For more information about a button or control, turn to the page number listed in square brackets ([]).

Front panel

1. Deck A cassette holder
2. Deck A operation buttons
 - ◀ : Reverse play button [6]
 - : Stop button [6,9]
 - ▶ : Forward play button [6,9,10,11]
 - /|| : Rec/pause button [9,10,11] (TA-RW544 only)
 - ◀◀ : Rewind button [7]
 - ▶▶ : Fast forward button [7]
3. Deck A EJECT button [6,8]
4. Display
5. DECK A/B counter button [9,10,11]
6. Counter RESET button [9,10,11]
7. Deck B EJECT button [6,8]
8. Deck B operation buttons
 - ◀ : Reverse play button [6]
 - DUBB.STOP : Stop button (Dubbing stop) [7,9,12]
 - ▶ : Forward play button [6,9,10]
 - /|| : Rec/pause button [9,10,12]
 - : Auto space button [13]
 - ◀◀ : Rewind button [7]
 - ▶▶ : Fast forward button [7]
9. Deck B cassette holder
10. REC LEVEL control knob [9,10,11]
11. REC BALANCE control knob [9,10,11] (TA-RW544 only)
12. DUBBING buttons (NORMAL/HIGH) [12]
13. REVERSE MODE button [6,8,12,15]
14. DOLBY NR button [6,8]
15. PHONES (Headphones) jack [7]
16. POWER button [5]

Display

- (a) Deck A operation and direction indicators
- (b) Reverse mode indicator
- (c) Dubbing indicators
- (d) Dolby NR indicators
- (e) Deck B operation and direction indicators
- (f) Electric counter
- (g) Peak level indicator

Rear panel

1. Line in jacks [5]
2. Line out jacks [5]
3. Voltage selector [5] (Worldwide model only)
4. Remote control jacks [14]
5. AC power cord [5]

Setting the Voltage Selector (Worldwide Model Only)

Models without a voltage selector can only be used in areas where the power supply is the same as that of the cassette deck.

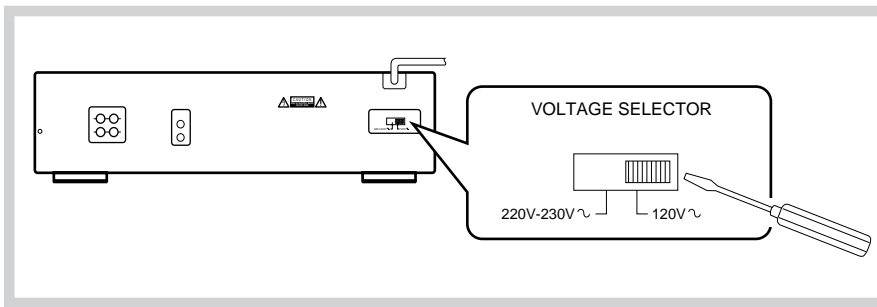

1. Determine the proper voltage for your area: 220-230 V or 120 V.
2. If the preset voltage does not conform to your area, insert a screwdriver into the groove in the switch. Slide the switch all the way to the right (120 V) or to the left (220-230 V), whichever is appropriate.

System Connections

- Do not plug in the AC power cord until all other connections have been made.
- On each pair of input or output jacks, the lower jack (marked R) corresponds to the right channel, and the upper jack (marked L) to the left channel. Refer to the amplifier's instruction manual for further information on connections.

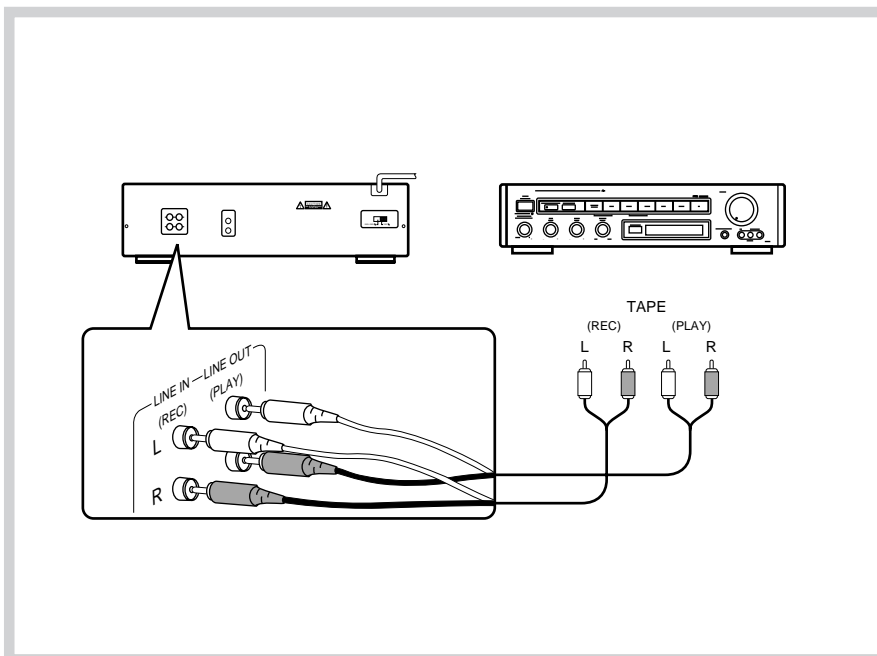

Connecting to an amplifier

Connect the tape deck LINE IN jacks to the TAPE REC jacks on the rear panel of the amplifier and the tape deck LINE OUT jacks to the amplifier TAPE PLAY jacks. Refer to the amplifier's instruction manual for further information on connections.

Power Connections

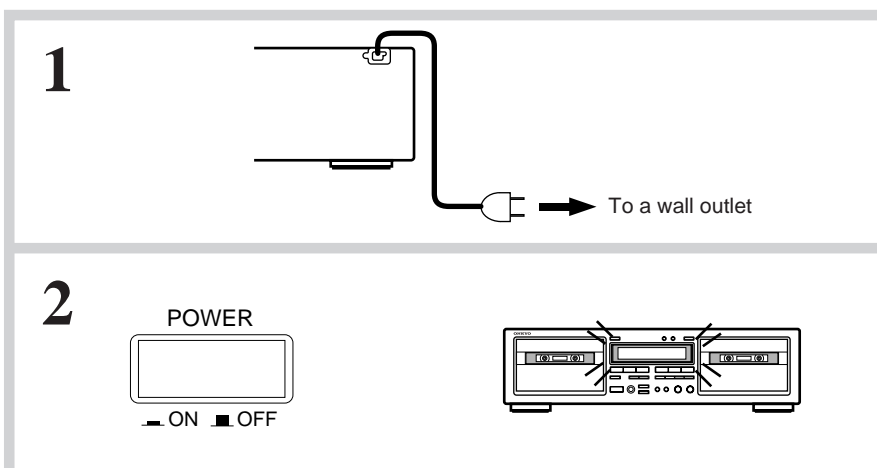

Switching power on

1. Plug the AC power cord into a wall outlet.
2. Press the **POWER** button.
The display will light.

To Play a Tape

- Check once again that all connections have been completed exactly as indicated in the connections diagram and then plug in the AC power cord.
- After turning the power on, the display illuminates and the ■ PAUSE indicator flashes (about 5 seconds). While the indicator is flashing, no operation can be performed.
- This deck holds two cassettes at once. Both Deck A and Deck B are capable of auto-reverse playback.
- Tapes can be played back using either Deck A or Deck B. Follow the procedure on Deck A or B. (Deck A is pictured.)

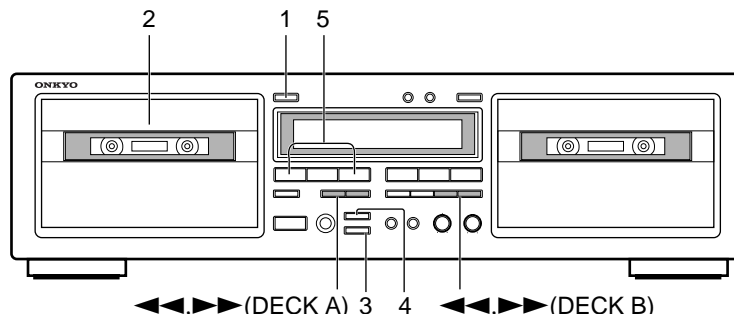

1

EJECT

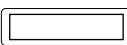

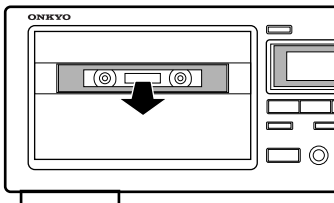

2

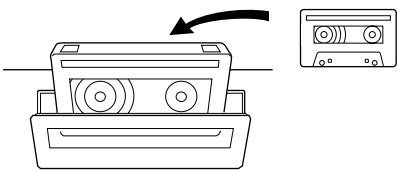

3

DOLBY NR





DOLBY NR

OFF B C

4

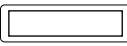
REVERSE MODE





5







Listening to a tape

- 1. Press the EJECT button to open the cassette holder.**
- 2. Insert a cassette.**
 - The side of the cassette with the exposed tape should be facing downward.
- 3. Set the Dolby NR by pressing the DOLBY NR button repeatedly until the proper Dolby NR indicator (OFF, B or C) turns on.**
 - Select the same noise reduction system that was used when the cassette was recorded. For instance, tapes recorded using Dolby B NR should be played back with Dolby B NR.
- 4. Set the Reverse Mode by pressing the REVERSE MODE button repeatedly until the desired mode is displayed.**
 - (▶) one side: Only one side of the tape is played back.
 - (↻) repeat: Both sides of the tape are played back repeatedly eight times or until the ■ button is pressed.
- 5. Start playback.**
 - Press the ◀ or ▶ button depending on which side of the cassette you wish to listen to.
 - ▶ : Playback starts from the front side.
 - ◀ : Playback starts from the reverse side.
 - The auto-stop mechanism will automatically stop the tape (depending on the tape transport mode) if a tape is played through to the end.

Stopping playback

Press the ■ button.

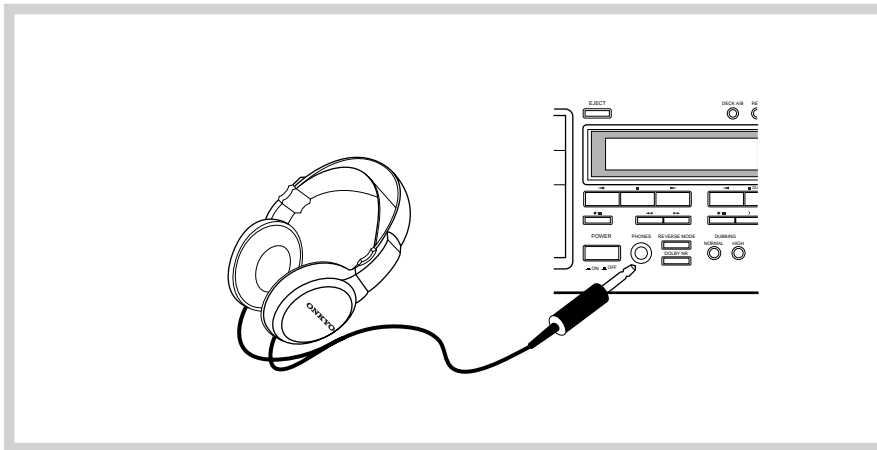
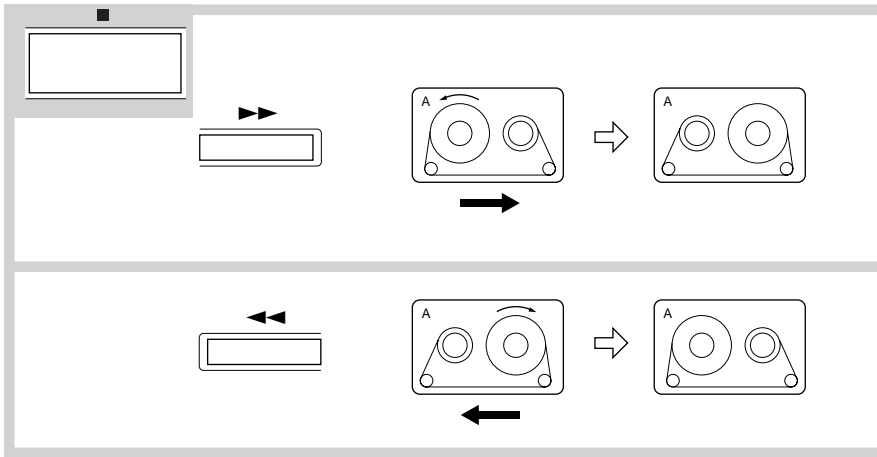

Recheck the tape direction settings (shown by the Deck A and Deck B direction indicators) before pressing the ◀◀ or ▶▶ button.

The following explanation assumes that the tape direction is forward (▶).

Fast forward and rewind

Make sure the tape is stopped before using the fast forward or rewind function.

To fast forward the tape, press the ▶▶ button.

To rewind the tape, press the ◀◀ button.

- To stop either fast forward or rewind, press the ■ button.

Listening with the headphones

Plug the headphones to the PHONES jack.

Automatic tape selection system

This deck detects the type of cassette in the cassette holder and automatically sets the bias and equalization to the correct settings. Tape selection is performed by detecting the presence or absence of identification pits on the back of the cassette shell. Cassettes manufactured before this identification system was adopted and bargain cassettes that do not incorporate these pits cannot be used with this deck.

Useful Functions Available during Playback (TA-RW544 Only)

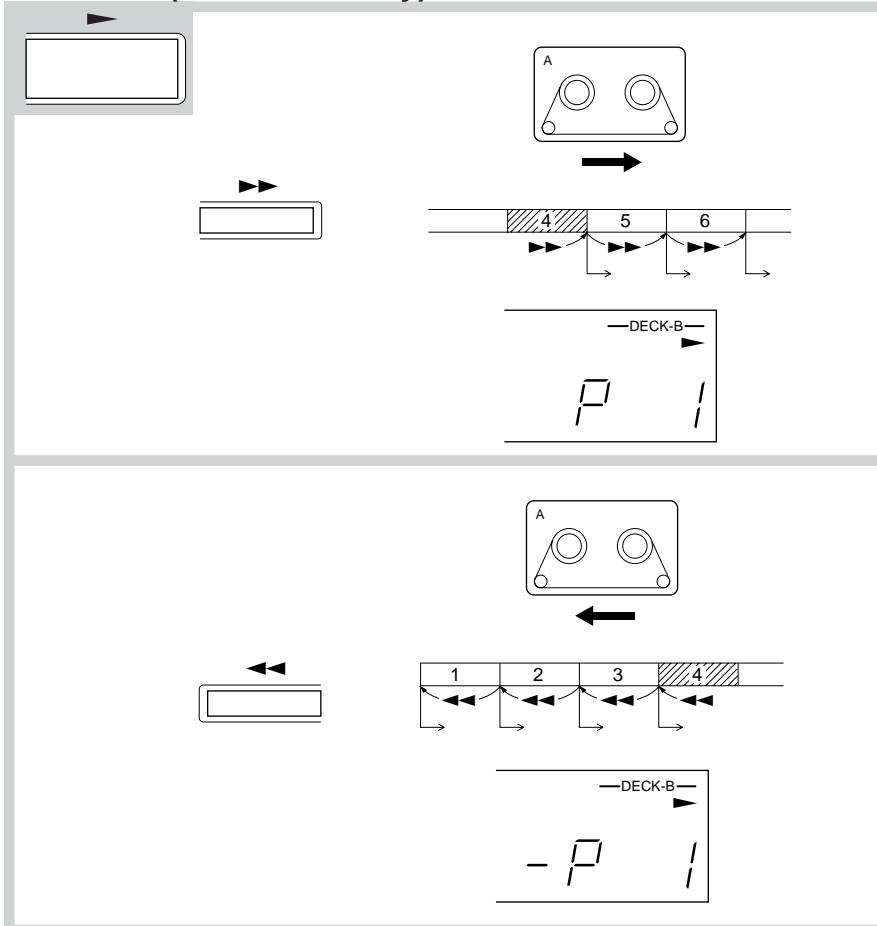

Skipping to a song

Make sure the tape is playing before using this function.

To skip ahead to the next song, press the ▶▶ button.

It is possible to skip up to 15 songs at one time. The number of songs skipped is indicated by the display (P1, P2 P15).

Skipping to the beginning of the current song or a preceding song

Make sure the tape is playing before using this function.

To skip back to the beginning of the song being played or preceding song, press the ◀◀ button.

The number of songs skipped is indicated by the display (-P1, -P2 -P15).

Note:

The Skip function operates by detecting the blank space between songs. Therefore, it may not operate properly under circumstances such as the following:

- 1) The blank space is too short.
- 2) The song is interrupted by narration, etc.
- 3) The music level changes, such as a quiet section immediately followed by a loud section.
- 4) There is excessive noise between songs.

Recording

With TA-RW544, both Deck A and Deck B can be used for recording. Three recording methods are possible.

- (A) Recording on a single cassette using Deck A or Deck B
- (B) Recording the same program simultaneously on cassettes in both Deck A and Deck B
- (C) Recording on two cassettes consecutively using first Deck A then Deck B

- With TA-RW344, only Deck B is available for recording.
- Check to see if one or both of the cassette's erasure prevention tabs have been removed.
- Confirm that the cassette deck is properly connected to the amplifier.
- Illustrations enclosed in solid boxes indicate source component operations.

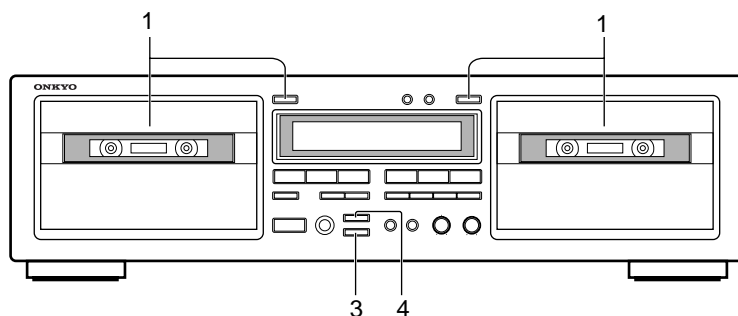

1

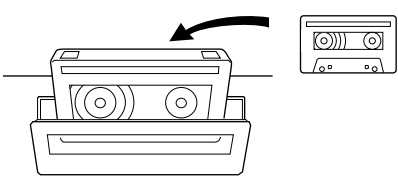

2

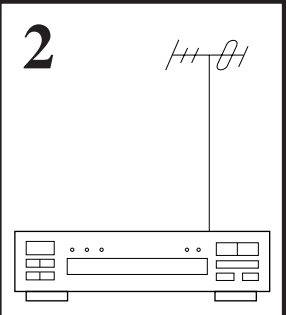

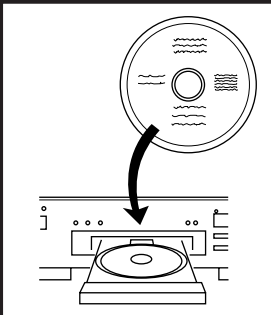

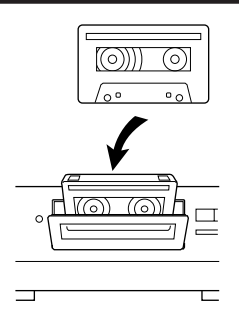

3

DOLBY NR

DOLBY NR

 OFF B C

4

REVERSE MODE



Preparing for recording

Confirm that the amplifier is set up correctly for recording. (Refer to the amplifier's instruction manual for details.)

- 1. Insert the cassettes.**
Make sure the side to be recorded is facing outward.
 - Recording is not possible on the tape leaders (the transparent sections you see at both ends of the tape).
- 2. Prepare the source component to be used for the recording.**
 - Tune in the desired station on the tuner.
 - Load a CD (or LP) into the CD player (or turntable).
 - Load a cassette into the tape player (analog or DAT).
- 3. Set the Dolby NR by pressing the DOLBY NR button repeatedly until the desired Dolby NR indicator (OFF, B or C) turns on.**
- 4. Set the Reverse Mode by pressing the REVERSE MODE button repeatedly until the desired mode is displayed.**
 - (↔) one side: Only one side of the tape is recorded.
 - (↻) repeat: Both sides of the tape are recorded.
 - When recording from a source component to Deck A and Deck B consecutively, select the "↻" mode.

Note:

This deck will not begin recording if you press the ●/|| and ► or ◀ button at the same time. To begin recording, first press the ●/|| button to put the deck into the rec/pause mode, then press either the ► or ◀ button as appropriate.

(A) Recording on a single cassette using Deck A or Deck B

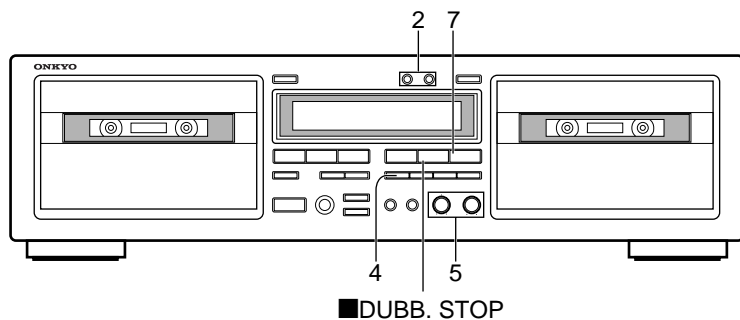

The following explanation assumes that Deck B is being used.

Procedure for recording

1. **Prepare for recording.**
(See page 8.)
Note:
With TA-RW544, when recording to Deck A only, do not insert a cassette in Deck B. In the “↻” mode, recording in Deck B may start consecutively.
2. **Press the DECK A/B button to select the appropriate Deck A or B, and press the RESET button to return the tape counter to [0000].**
3. **Begin playing the source component.**
4. **Press the ●/|| button.**
5. **While observing the peak level indicators, adjust the recording level and balance.**
 - Use the REC LEVEL knob to adjust the recording level.
 - With TA-RW544, adjust the REC BALANCE knob so that the left and right channels have approximately the same levels. This knob is normally at the center position.
 - When using metal cassettes, the REC LEVEL knob should be adjusted so that +3 dB indicators light periodically. When using other kinds of tapes, the 0 dB indicator should light periodically. (See “Making Good Sound Recordings” on page 13.)
6. **Put the source component into recording standby status.**
 - Temporarily stop CD (or LP) play.
 - Rewind the tape to the portion you wish to start playback.
7. **Press the ► button on this unit and begin playing the source component.**

You can also use the CD Synchro Recording function if this unit is properly connected to an ONKYO

Stopping recording

(See page 14.)
Press the ■ DUBB.STOP button.

Interrupting recording briefly

Press the ●/|| button.

2

3

4

5

(TA-RW544 only)

6

7

■ DUBB. STOP

●/||

(B) Recording the same program simultaneously on cassettes in both Deck A and Deck B (TA-RW544 only)

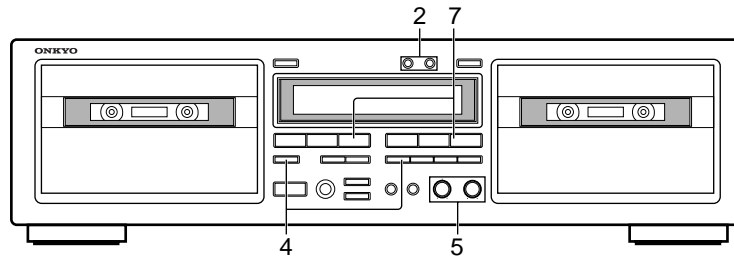

2

DECK A/B	RESET	
DECK A/B	RESET	

3

4

--	--	--	--

5

REC BALANCE	REC LEVEL	

6

7

--	--

	or	
--	----	--

Procedure for recording

1. **Prepare for recording.**
(See page 8.)
2. **Press the RESET button to return the tape counter for both Deck A and Deck B to [0000].**
 - To change the active deck, press the DECK A/B button.
3. **Begin playing the source component.**
4. **Press the Deck A and Deck B ●/|| buttons.**
5. **While observing the peak level indicators, adjust the recording level and balance.**
 - Use the REC LEVEL knob to adjust the recording level.
 - Adjust the REC BALANCE knob so that the left and right channels have approximately the same levels. This knob is normally at the center position.
6. **Put the source component into recording standby status.**
7. **Press the Deck A or Deck B ► button and begin playing the source component.**

You can also use the CD Synchro Recording function if this unit is properly connected to an ONKYO CD player bearing the symbol. (See page 14.)

Notes:

- The following buttons and knob affect both Deck A and Deck B.
 - The REVERSE MODE button
 - The DOLBY NR button
 - The REC LEVEL knob and REC BALANCE knob
- The auto space function operates both Deck A and Deck B at the same time. And, pressing the ◀, ▶ or ●/|| button on either Deck A or Deck B affects both Deck A and Deck B.

Stopping recording

To stop recording on Deck A or Deck B only, press the appropriate deck button.

(C) Recording on two cassettes consecutively using first Deck A then Deck B (TA-RW544 only)

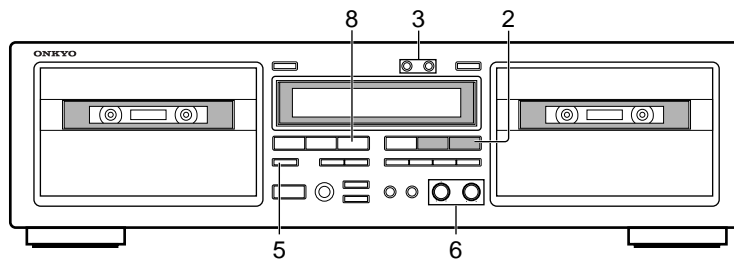

Procedure for recording

1. **Prepare for recording.**
(See page 8.)
Note:
Be sure to set the reverse mode to “↺” mode.
2. **Check that the Deck B direction indicator is forward (▶).**
 - To change the setting of the direction indicator, press the ▶ button followed by the ■ DUBB.STOP button.
3. **Press the RESET button to return the tape counter for both Deck A and Deck B to [0000].**
 - To change the active deck, press the DECK A/B button.
4. **Begin playing the source component.**
5. **Press the Deck A ●/|| button.**
6. **While observing the peak level indicators, adjust the recording level and balance.**
 - Use the REC LEVEL knob to adjust the recording level.
 - Adjust the REC BALANCE knob so that the left and right channels have approximately the same levels. This knob is normally at the center position.
7. **Put the source component into recording standby status.**
8. **Press the Deck A ▶ button and begin playing the source component.**

You can also use the CD Synchro Recording function if this unit is properly connected to an ONKYO CD player bearing the symbol. (See page 14.)

Note:
If one of the erasure prevention tabs of the cassettes inserted into Deck A and Deck B has been removed, recording will stop on that side. For example, the broken tab on the reverse side of the cassette inserted into Deck A will cease reverse side recording on Deck A and both sides recording on Deck B.

2

3

4

5

6

7

8

Tape Dubbing

- The recording level will be fairly close to that of the tape in Deck A.
- The Dolby NR System of Deck A is automatically used to record the tape in Deck B. If you wish to monitor the signal from a Dolby NR encoded tape during normal-speed dubbing, be sure to set the Dolby NR to match the type of Dolby NR with which the cassette was recorded.
- During high-speed dubbing, decrease the sound level from the amplifier (or receiver) using the volume control and unplug the headphones from the headphone jack.

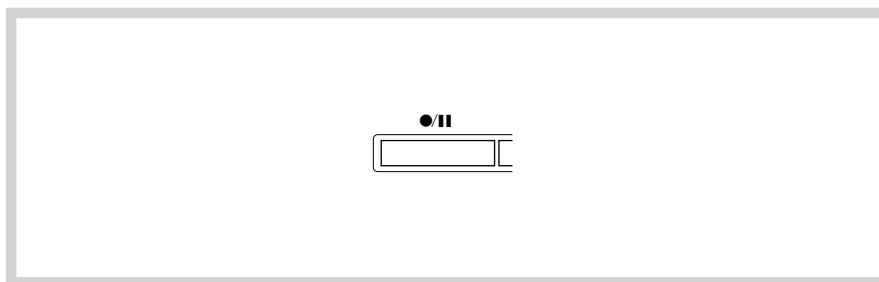
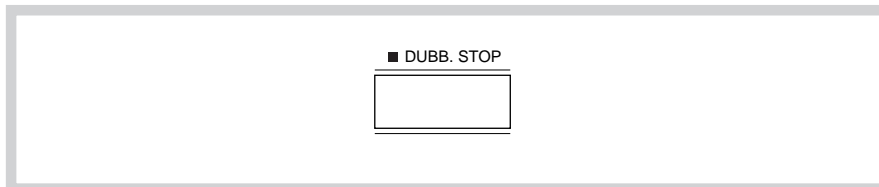
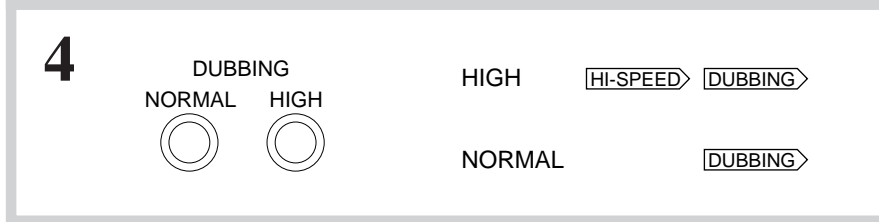
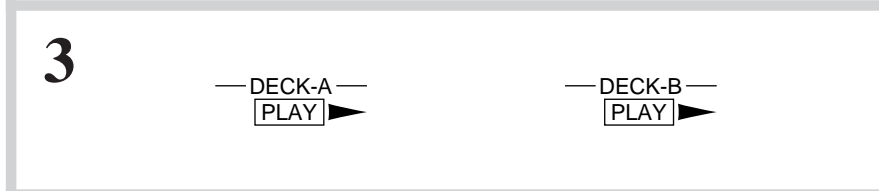
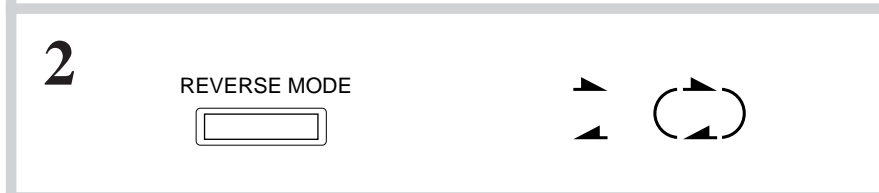
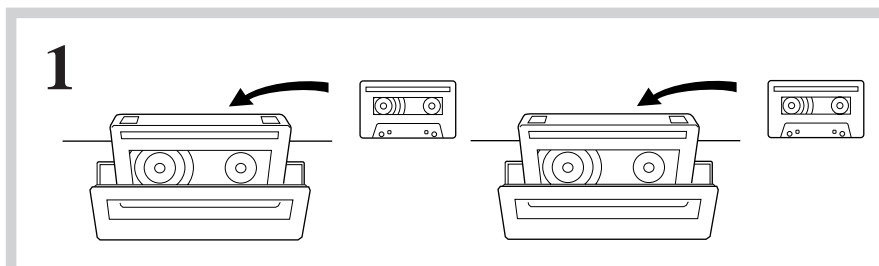
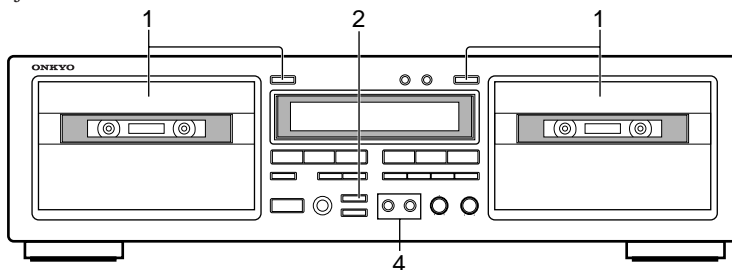

Tape dubbing

- 1. Insert the prerecorded cassette into Deck A, and insert the cassette to be recorded into Deck B.**
- 2. Set the Reverse Mode by pressing the REVERSE MODE button repeatedly until the desired mode is displayed.**
 (▶) one side: Only one side of the tape is copied.
 (↻) repeat: Both sides of the tape are copied.
- 3. Check the Deck A and Deck B direction indicators to ensure that the tape transport will start in the desired direction.**
 - To dub an entire tape, be sure to select the forward (▶) direction on both Decks.
 To change the setting of the direction indicator, press the ◀ or ▶ button, then the ■ button
- 4. Begin dubbing by pressing the NORMAL or HIGH button.**
 [NORMAL] : Normal-speed dubbing will begin.
 [HIGH] : High-speed dubbing about

half the time normally required will begin.

Stopping dubbing

Press the Deck B ■ DUBB.STOP button.

Briefly interrupting dubbing

Press the ●/|| button. (Deck B)
 In this case, you can change the cassette in Deck A or search the desired portion by using the buttons for Deck A. To resume dubbing, press the NORMAL or HIGH button again.

Useful Recording Functions

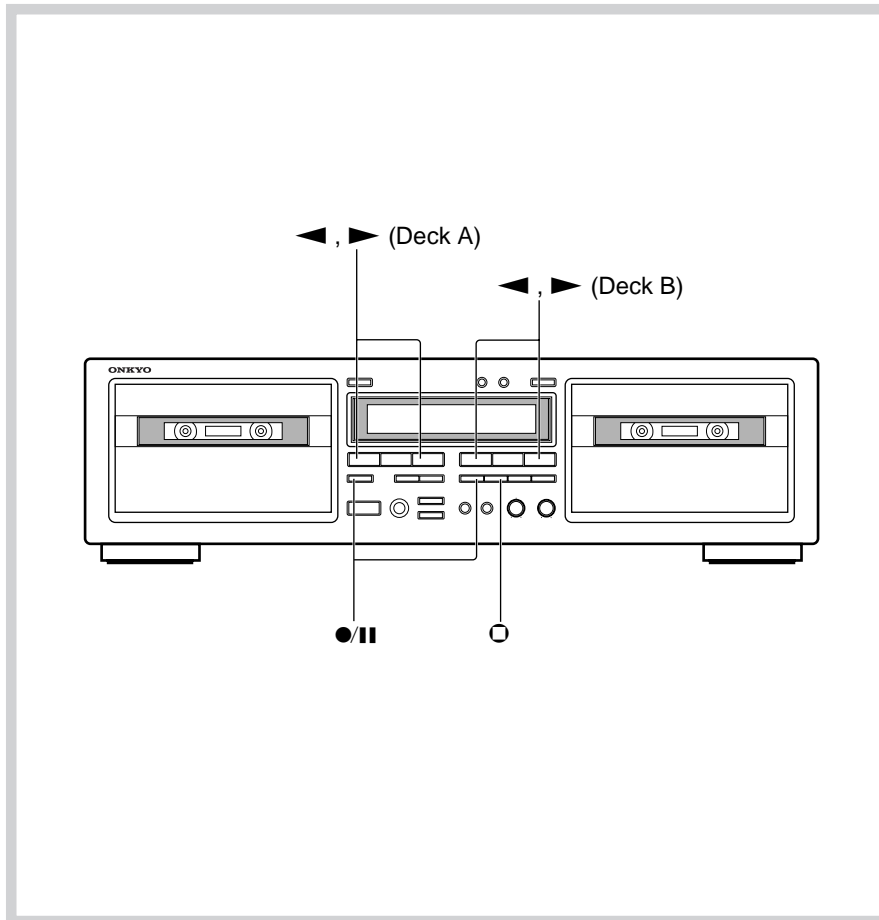

Inserting blank spaces between songs when editing tapes

1. Press the ●/|| button and the ◀ or ▶ button to begin recording.
2. Press ○ button at any point during recording where you want to enter a blank space about five seconds long.
 - The [PLAY] indicator flashes on and off.
 - After the blank space has been inserted, the tape stops automatically and the deck returns to the rec/pause mode.
3. To continue recording, press the ◀ or ▶ button.
 - The ○ button works in both the record and rec/pause modes.

■ To insert a blank space of less than five seconds between songs

Press the ●/|| button to return to the rec/pause mode or press the ◀ or ▶ button before a five-second period has elapsed.

■ To insert a blank space of more than five seconds between songs

Hold the ○ button down for as long as you want the blank space to be. The deck will return to the rec/pause mode immediately when the button is released.

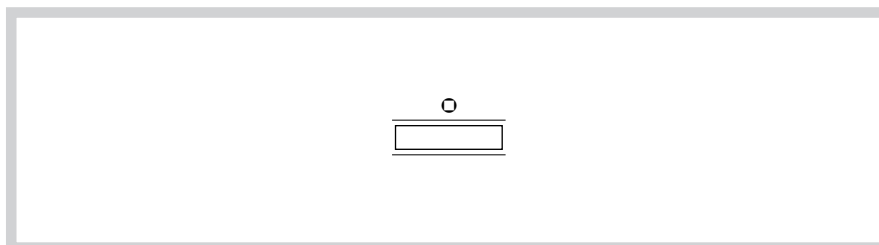

Pressing the ○ button during dubbing

Pressing the ○ button during dubbing causes Deck A to stop while a blank space is inserted on the tape in Deck B. Then Deck B reverts to the dubbing pause mode. To continue dubbing, press the NORMAL or HIGH button.

Making Good Sound Recordings

Dolby Noise Reduction System

Dolby B NR is the system used in most cassette tape decks to reduce the background noise that is inherent in all cassette tapes. This deck also features Dolby C NR, an even more effective noise reduction system, developed by Dolby Laboratories in response to the demand for even better sound from cassette tapes.

The Dolby HX Pro System

Tape sensitivity is constantly changing as recordings are made due to the biasing effect of high frequency audio signals. Dolby HX Pro is a system that compensates for these undesirable fluctuations during recording. It does not operate during playback, so cassettes recorded with Dolby HX Pro can be played back on decks not equipped with the system.

Note:

Dolby HX Pro operates independently of Dolby B and C NR, and only during recording.

Setting the Proper Recording Level

The recording level has an important effect on the sound quality a tape will have when it is played back. A recording level that is too high will cause distortion while one which is too low will lower the signal-to-noise ratio resulting in a tape with excessive "hiss noise." It is particularly important to set the recording level correctly with cassette tapes since they have a much thinner magnetic coating than open reel tapes. The thin coating gives the tape a comparatively low saturation level which can easily be surpassed if the recording level is set too high.

The optimal recording level varies depending on the type of the tape being used. With this tapedeck, adjust the REC LEVEL knob so the PEAK LEVEL indicator occasionally hits the "+6dB" line with "Metal" tapes and "+4dB" line with "Normal" or "High" position tapes, respectively. It should be noted that the peak level may change from one track to another on some recording sources. The recording level indicators feature a peak-hold function for the indicators from -6 dB through +6 dB. This can come in handy when setting the recording level.

Connecting ONKYO Components for RI Operation

If this unit is properly connected to another ONKYO component bearing the **RI** symbol, you will be able to control it using the other component's remote control.

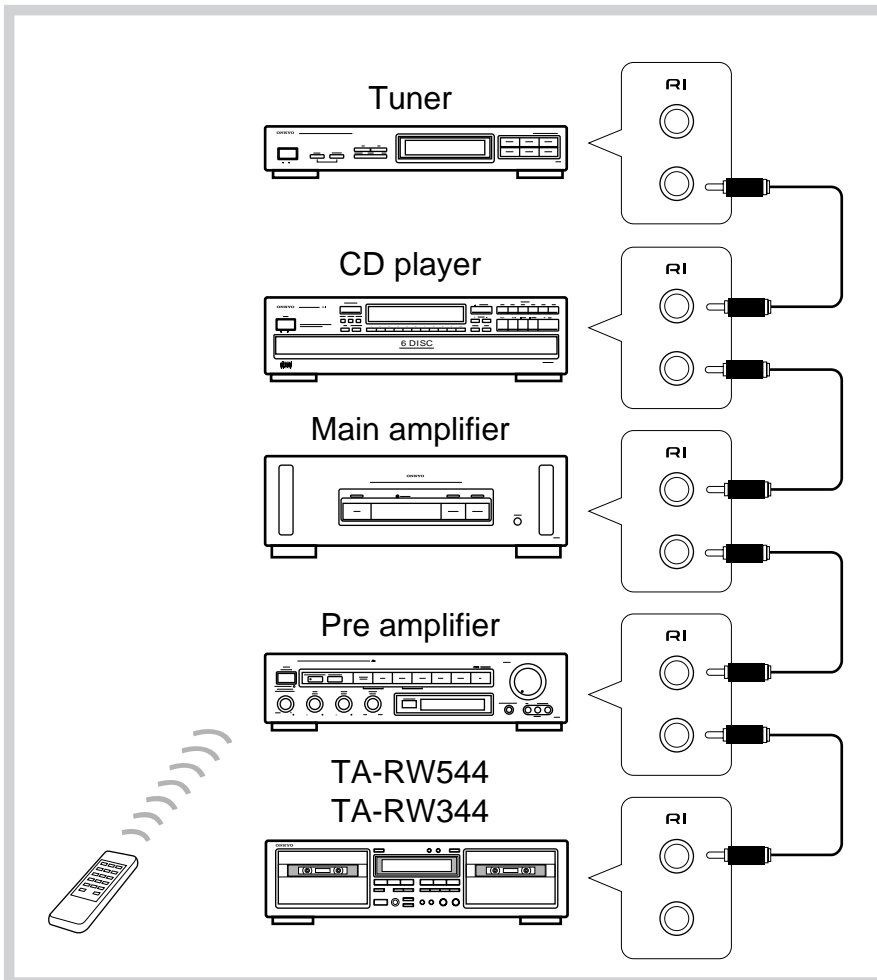

For remote control operation

The upper and lower remote control jacks have the same function.

For remote control operation, connect this jack to any ONKYO amplifier, receiver or CD player that are equipped with a **RI** remote control jack using the remote control cable.

Note:

Do not attempt to connect the **RI** remote control jack to any equipment other than an ONKYO component that are equipped with a **RI** remote control jack. Doing so could cause the unit to malfunction.

The function listed below can be accomplished using the remote control of the master unit.

- ▶▶▶ : Play
- ◀◀◀ : Rewind
- ▶▶▶ : Fast forward
- : Stop
- /|| : Rec/Pause

CD synchro recording system

Once connections are made, as shown left, this function becomes enabled. It automatically starts recording on the cassette deck when the ▶ button of the CD player is pressed. (See below.)

CD Synchro Recording System

Once the TA-RW544/344 is connected to a CD player bearing the **RI** symbol (see above), pressing the ▶ button of the CD player will cause recording to begin automatically on the TA-RW544/344. Three recording methods are possible. (See pages 8 - 11.)

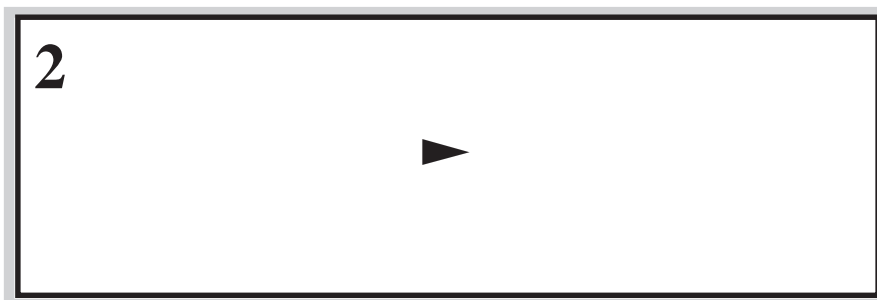

1. Prepare for recording.

(See pages 8 - 11.)

2. Start the CD player.

Recording will begin simultaneously.

Note:

Even if the CD player is stopped during recording, the cassette deck will continue recording. In this case, make sure to press the ■ button on the cassette deck.

Reverse Mode Function

- Recheck the tape travel direction settings (shown by the Deck A and Deck B direction indicators) before beginning playback or recording.
- The following explanation assumes that cassette side A is facing outward.
- There is a silent gap about ten seconds long when the direction of tape travel switches from forward to reverse or from reverse to forward when the end of a tape side is reached.

	Reverse mode	Direction	Playback / Recording sequence	Explanation	
Playback		▶	A	Press the ▶ button. Playback will begin and end on side A (front).	
		◀	B	Press the ◀ button. Playback will begin and end on side B (rear).	
		▶	A → B → A → B ... → A → B	Press the ▶ button. Playback will begin from side A and continue to side B. When the end of side B is reached, the playback begin again from side A. This sequence will repeat eight times.	
		◀	B → A → B → A ... → B → A	Press the ◀ button. Playback will begin from side B and continue to side A. When the end of side A is reached, the playback begin again from side B. This sequence will repeat eight times.	
		▶	A → B → A → B ... → A → B <small>Deck A Deck B Deck B</small> One cycle	If there are tapes in both Deck A and Deck B, playback will begin from side A of the tape in Deck A. When the end of side B is reached, Deck B will begin playback. This sequence will repeat four times.	
		◀	B → A → B → A ... → B → A <small>Deck A Deck B Deck A Deck B Deck A</small> One cycle		
	Recording		▶	A	Press the ●/ button then the ▶ button. Recording will begin from and end on side A (front).
			◀	B	Press the ●/ button then the ◀ button. Recording will begin and end on side B (rear).
			▶	A → B	Press the ●/ button then the ▶ button. Recording will begin from side A and continue to side B. When the end of side B is reached, recording will stop automatically.
			◀	B	If you begin recording in the reverse direction, recording will begin from side B of the tape. When the end of side B is reached, recording will stop automatically.
		▶ Deck A	A → B → A → B <small>Deck A Deck B</small>	Continuous recording Before performing continuous recording, set the direction of the tape in Deck B. Press the Deck A ●/ button then the ▶ (or ◀) button. Recording will begin from side A (B) of the tape in Deck A. As soon as the recording on side B of the tape in Deck A is complete, recording on Deck B will begin.	
		◀ Deck A	B → A → B <small>Deck A Deck B</small>		

* You can simultaneously record on tapes in Deck A and Deck B except during continuous recording.

Handling Cassette Tapes

Examine cassette tapes carefully before using them with the TA-RW411.

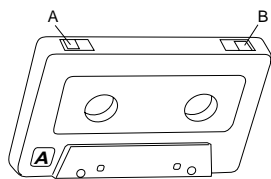

1.

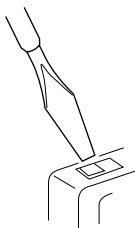

2.

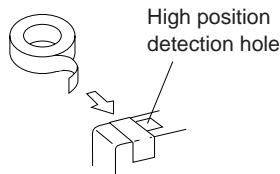

Erasure prevention

Cassette tapes are constructed with erasure prevention tabs to prevent accidental erasure of the tape.

- 1 If you wish to protect a recording from accidental erasure, break off the tab(s) on the appropriate side(s). It will no longer be possible to use the recording button with such a cassette.
- 2 If at some later date you wish to record the cassette, simply cover the hole(s) with small pieces of cellophane tape.
 - Be sure not to cover the holes for detecting high-position tapes.

Loose tape

Loose tape can cause tangling around the pinch roller and capstan and jam the mechanism.

Remove any tape slack with a pencil or similar device as shown in the diagram.

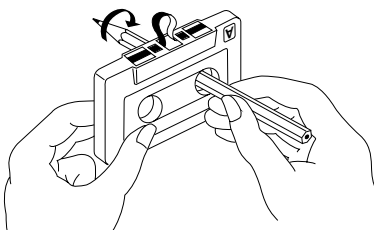

Tapes not recommended

1. C-120 tapes
C-120 tape is thin and therefore easily broken. There is a possibility that tape could get caught on the pinch roller or capstan.
2. Endless tapes
Do not use endless tapes.

Tape storage

- Do not touch the tape surface.
- Do not put thick paper or cardboard labels in the cassette holder.
- Do not put tapes near magnetic sources (speakers, amplifiers, TVs, etc.) Your important recording might be erased or damaged.
- Do not expose cassettes to direct sunlight.

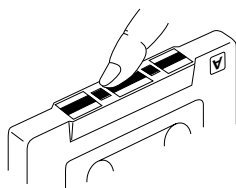

No!

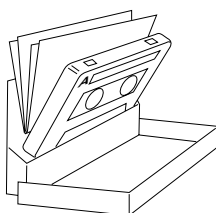

No!

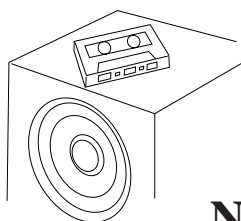

No!

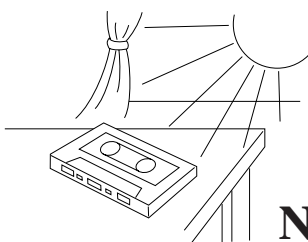

No!

Recommended tapes

Normal position	High position	Metal position
Maxell UDI	Maxell UDII	Maxell XS

Cassette Deck Maintenance

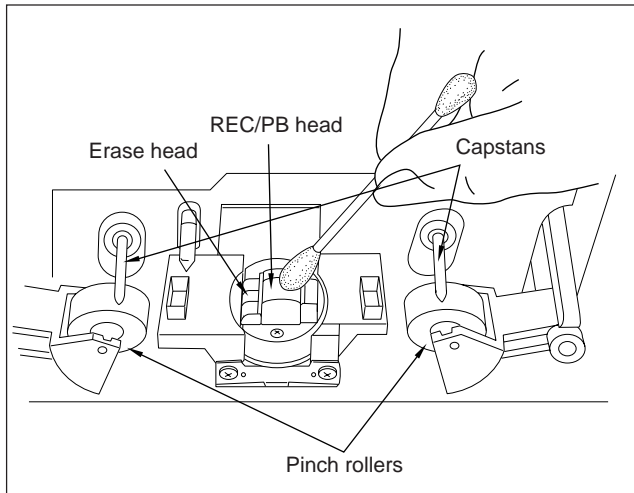

This deck requires no lubrication.

Head, Pinch Roller and Capstan Cleaning

Playback sound quality can be greatly diminished if magnetic particles are allowed to accumulate on the recording/playback head or playback head. Be sure to clean the head periodically, normally 2 - 3 times a month, to maintain your deck's original performance. Dirty heads may cause:

- Poor sound quality (lose of high frequency response)
- Decreased volume
- Skipping
- Incomplete erasure of previous recordings

If the pinch rollers and capstan are dirty, the tape may become tangled and damaged by wrapping around the pinch roller and capstan.

To prevent these problems, clean the heads, pinch rollers and capstans with a cotton swab dipped in cleaning fluid.

Demagnetizing

Residual magnetism builds up in the heads after the cassette deck has been used for an extended period of time. This buildup introduces noise and static into tapes and impairs high frequency response. To prevent this, demagnetize the heads with any commercially available head eraser once every 50 hours of use. Refer to the instruction manual of the head eraser for detailed instructions.

Specifications

TA-RW544

Track Format:	4-track, 2-channels
Erasure System:	AC erase
Tape Speed:	4.8 cm/sec. (1-7/8 i.p.s.) 9.6 cm/sec. (3-3/4 i.p.s.) (high speed dubbing)
Wow and Flutter:	0.07 % (WRMS)
Frequency Response:	20 — 15,000 Hz (Normal) (30 — 14,000 Hz \pm 3 dB) 20 — 16,000 Hz (High) (30 — 15,000 Hz \pm 3 dB) 20 — 17,000 Hz (Metal) (30 — 16,000 Hz \pm 3 dB)
S/N Ratio:	Dolby NR off: 58 dB (metal position tape) A noise reduction of 10 dB above 5 kHz and 5 dB at 1 kHz is possible with Dolby B NR. A noise reduction of 20 dB at 5 kHz is possible with Dolby C NR.
Input Jacks:	Line IN: 2 Input sensitivity: 80 mV Input impedance: 40 kohms
Outputs:	Line OUT: 2 Standard output level: 500 mV (0 dB) Optimum load impedance: over 50 kohm
Headphone jack:	1 Optimum load impedance: 8 to 200 ohms
Motors:	DC servo motor \times 2, DC motor \times 2
Heads:	REC/PB: 2 ERASE: 2
Power Supply:	European and Australian models: AC 230V, 50 Hz U.S.A. and Canadian models: AC 120V, 60 Hz Worldwide model: AC 120V and AC 220-230V, Switchable 50/60 Hz
Power Consumption:	31 watts
Dimensions:	435(W) \times 121(H) \times 305(D) mm (17-1/8" \times 4-3/4" \times 12")
Weight:	5.9 kg. (13.0 lbs.)

TA-RW344

Track Format:	4-track, 2-channels
Erasure System:	AC erase
Tape Speed:	4.8 cm/sec. (1-7/8 i.p.s.) 9.6 cm/sec. (3-3/4 i.p.s.) (high-speed dubbing)
Wow and Flutter:	0.07 % (WRMS)
Frequency Response:	20 — 15,000 Hz (Normal) (30 — 14,000 Hz \pm 3 dB) 20 — 16,000 Hz (High) (30 — 15,000 Hz \pm 3 dB) 20 — 17,000 Hz (Metal) (30 — 16,000 Hz \pm 3 dB)
S/N Ratio:	Dolby NR off: 58 dB (metal position tape) A noise reduction of 10 dB above 5 kHz and 5 dB at 1 kHz is possible with Dolby B NR. A noise reduction of 20 dB at 5 kHz is possible with Dolby C NR.
Input Jacks:	Line IN: 2 Input sensitivity: 80 mV Input impedance: 50 kohms
Outputs:	Line OUT: 2 Standard output level: 500 mV (0 dB) Optimum load impedance: over 50 kohms
Headphone jack:	1 Optimum load impedance: 8 to 200 ohms
Motors:	DC servo motor \times 2, DC motor \times 2
Heads:	REC/PB: 1 PB: 1 ERASE: 1
Power Supply:	European and Australian models: AC 230V, 50 Hz U.S.A. and Canadian models: AC 120V, 60 Hz Worldwide model: AC 120V and AC 220-230V, Switchable 50/60 Hz
Power Consumption:	29 watts
Dimensions:	435(W) \times 121(H) \times 305(D) mm (17-1/8" \times 4-3/4" \times 12")
Weight:	5.9 kg. (13.0 lbs.)

Specifications and external appearance are subject to change without notice because of product improvements.

Troubleshooting Guide

The following guide lists problems which do not require professional servicing. If, however, the problem cannot be remedied using this guide, contact an ONKYO authorized service center for assistance.

- **No power.**

Cause: Power cord plug is loose

Remedy: Insert plug properly into outlet.

- **Playback but no sound.**

Cause: Incorrect connection.

Remedy: Check and connect correctly according to page 5.

Cause: Stereo amplifier input selector switch is set to incorrect position.

Remedy: Change switch position.

- **Tape does not move.**

Cause: Slack tape wound around pinch roller.

Remedy: Take up slack with a pencil (see page 16).

- **●/II button does not engage.**

Cause: No tape in cassette holder.

Remedy: Insert cassette tape.

Cause: Erasure prevention tab(s) removed.

Remedy: Change cassette or cover tab hole with cellophane tape.

- **Hoarse sound, balance unstable.**

Cause: Playback head dirty.

Remedy: Clean head (see page 17).

Cause: Tape is stretched.

Remedy: Replace cassette.

- **Excessive noise and tape hiss.**

Cause: Head has become magnetized.

Remedy: Demagnetize (see page 17).

Cause: Tape with high noise level.

Remedy: Replace cassette.

- **Distorted sound.**

Cause: Distortion in tape.

Remedy: Tape is probably bad but confirm by listening to another.

- **Recordings are distorted.**

Cause: Recording was done at too high a level.

Remedy: Readjust REC LEVEL knob according to the directions on page 9.

- **Tape squeal and skipping.**

Cause: Dirty heads, pinch rollers or capstan shafts.

Remedy: Clean (see page 17).

Cause: Cassette shell is binding tape or tape is stretched.

Remedy: Change cassette or try correcting with fast forward and rewind.

- **Excessive hum during playback.**

Cause: Connecting cables not inserted firmly.

Remedy: Insert plugs firmly.

Cause: External flux leakage from nearby amplifier or TV set.

Remedy: Move deck away from hum source.

- **High frequencies too strong.**

Cause: Dolby NR encoded tape played back with NR off.

Remedy: Select the same noise reduction (Dolby NR B or C) used when the cassette was recorded.

Cause: Incorrect equalization.

Remedy: Confirm that cassette has tape type detection holes.

- **No high frequency sounds.**

Cause: Tape not encoded with Dolby NR played back with Dolby B or C NR on.

Remedy: Select the appropriate NR mode using the DOLBY NR button (OFF).

Cause: Heads have become dirty.

Remedy: Clean (see page 17).

- **The skip function does not operate properly (TA-RW544 only).**

Cause: The silent sections between songs are too short or noisy.

Remedy: Use a cassette with sufficient silent sections of sufficient length between songs.

- **Deck does not operate properly.**

Cause: Tape transport control microcomputer has been exposed to interference from power supply or static electricity.

Remedy: Press the POWER button to turn off the power. Wait approximately 10 seconds and turn it on again.

ONKYO CORPORATION

Sales Planning & Promotion Dept.: 2-1, Nisshin-cho, Neyagawa-shi, OSAKA 572, JAPAN
Tel: 0720-31-8111 Fax: 0720-33-5222

ONKYO U.S.A. CORPORATION

200 Williams Drive, Ramsey, N.J. 07446, U.S.A.
Tel: 201-825-7950 Fax: 201-825-8150 E-mail: onkyo@onkyousa.com

ONKYO EUROPE ELECTRONICS GmbH

Industriestrasse 18-20, 82110 Germering, GERMANY
Tel: 089 84 93 20 Fax: 089 84 93 226

ONKYO FRANCE

Immeuble Le Diamant, Domaine Technologique de Saclay, 4 Rue René Razel,
91892 SACLAY, FRANCE Tel: (1) 69 33 14 00 Fax: (1) 69 41 35 84



SN29342382Y



Free Manuals Download Website

<http://myh66.com>

<http://usermanuals.us>

<http://www.somanuals.com>

<http://www.4manuals.cc>

<http://www.manual-lib.com>

<http://www.404manual.com>

<http://www.luxmanual.com>

<http://aubethermostatmanual.com>

Golf course search by state

<http://golfingnear.com>

Email search by domain

<http://emailbydomain.com>

Auto manuals search

<http://auto.somanuals.com>

TV manuals search

<http://tv.somanuals.com>