

# ONKYO®

## Audio Video Control Receiver

# TX-DS656

## Instruction Manual

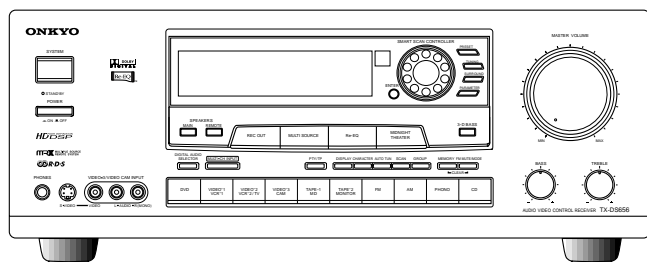

**Thank you** for purchasing the Onkyo Audio Video Control Receiver.

Please read this manual thoroughly before making connections and turning on the power.

Following the instructions in this manual will enable you to obtain optimum performance and listening enjoyment from your new Audio Video Control Receiver.

Please retain this manual for future reference.

## Contents

### Before using

|                              |   |
|------------------------------|---|
| Important Safeguards .....   | 2 |
| Precautions .....            | 3 |
| Features .....               | 4 |
| Supplied accessories .....   | 4 |
| Before using this unit ..... | 5 |

### Preparation

|                            |    |
|----------------------------|----|
| Connection .....           | 6  |
| On-screen setting .....    | 18 |
| Speaker system setup ..... | 21 |

### Operation

|  |    |
|--|----|
| Input source selection and surround<br>setup .....                                       | 25 |
| Listening to FM/AM broadcasts .....  | 32 |
| Receiving RDS broadcasts<br>(European models only) .....                                 | 36 |
| Using the Surround modes .....   | 38 |
| Recording from a source .....  | 42 |
| Using the TAPE-2 MONITOR<br>function .....   | 44 |
| Using the other remote controller functions<br>with the supplied remote controller ..... | 45 |
| Multi-room system connections .....  | 46 |

### A few important notes

|                                   |    |
|-----------------------------------|----|
| Troubleshooting .....             | 50 |
| Specifications .....              | 52 |
| Control positions and names ..... | 53 |

## WARNING

TO REDUCE THE RISK OF FIRE OR ELECTRIC SHOCK, DO NOT EXPOSE THIS APPLIANCE TO RAIN OR MOISTURE.

## CAUTION

TO REDUCE THE RISK OF ELECTRIC SHOCK, DO NOT REMOVE COVER (OR BACK). NO USER-SERVICEABLE PARTS INSIDE. REFER SERVICING TO QUALIFIED SERVICE PERSONNEL.



**WARNING**  
RISK OF ELECTRIC SHOCK  
DO NOT OPEN

**AVIS**  
RISQUE DE CHOC ELECTRIQUE  
NE PAS OUVRIR

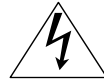

- The lightning flash with arrowhead symbol, within an equilateral triangle, is intended to alert the user to the presence of uninsulated "dangerous voltage" within the product's enclosure that may be of sufficient magnitude to constitute a risk of electric shock to persons.
- The exclamation point within an equilateral triangle is intended to alert the user to the presence of important operating and maintenance (servicing) instructions in the literature accompanying the product.

# Important Safeguards

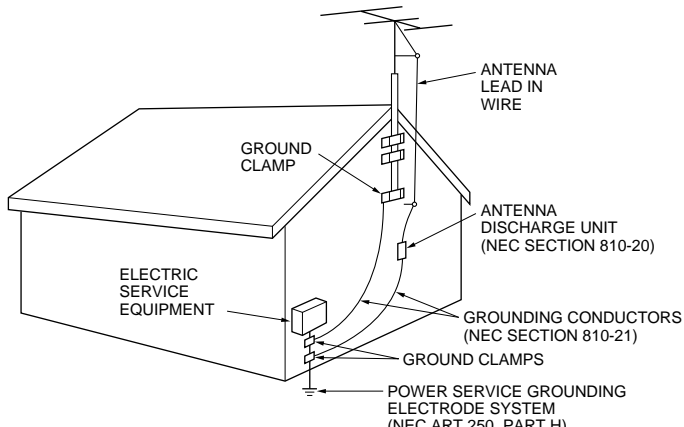
- 1. Read Instructions** – All the safety and operating instructions should be read before the appliance is operated.
- 2. Retain Instructions** – The safety and operating instructions should be retained for future reference.
- 3. Heed Warnings** – All warnings on the appliance and in the operating instructions should be adhered to.
- 4. Follow Instructions** – All operating and use instructions should be followed.
- 5. Water and Moisture** – The appliance should not be used near water - for example, near a bathtub, washbowl, kitchen sink, laundry tub, in a wet basement, or near a swimming pool, and the like.
- 6. Carts and Stands** – The appliance should be used only with a cart or stand that is recommended by the manufacturer.
  - 6A. An appliance and cart combination** should be moved with care. Quick stops, excessive force, and uneven surfaces may cause the appliance and cart combination to overturn.
- 7. Wall or Ceiling Mounting** – The appliance should be mounted to a wall or ceiling only as recommended by the manufacturer.
- 8. Ventilation** – The appliance should be situated so that its location or position does not interfere with its proper ventilation. For example, the appliance should not be situated on a bed, sofa, rug, or similar surface that may block the ventilation openings; or if placed in a built-in installation, such as a bookcase or cabinet that may impede the flow of air through the ventilation openings, there should be free space of at least 20 cm (8 in.) and an opening behind the appliance.
- 9. Heat** – The appliance should be situated away from heat sources such as radiators, heat registers, stoves, or other appliances (including amplifiers) that produce heat.
- 10. Power Sources** – The appliance should be connected to a power supply only of the type described in the operating instructions or as marked on the appliance.
- 11. Polarization** – If the appliance is provided with a polarized plug having one blade wider than the other, please read the following information: The polarization of the plug is a safety feature. The polarized plug will only fit the outlet one way. If the plug does not fit fully into the outlet, try reversing it. If there is still trouble, the user should seek the services of a qualified electrician. Under no circumstances should the user attempt to defeat the polarization of the plug.
- 12. Power-Cord Protection** – Power-supply cords should be routed so that they are not likely to be walked on or pinched by items placed upon or against them, especially near plugs, convenience receptacles, and the point where they exit from the appliance.
- 13. Cleaning** – The appliance should be cleaned only as recommended by the manufacturer.
- 14. Power Lines** – An outdoor antenna should be located away from power lines.
- 15. Nonuse Periods** – The power cord of the appliance should be unplugged from the outlet when left unused for a long period of time.
- 16. Object and Liquid Entry** – Care should be taken so that objects do not fall and liquids are not spilled into the enclosure through openings.
- 17. Damage Requiring Service** – The appliance should be serviced by qualified service personnel when:
  - A. The power-supply cord or the plug has been damaged; or
  - B. Objects have fallen, or liquid has been spilled into the appliance; or
  - C. The appliance has been exposed to rain; or
  - D. The appliance does not appear to operate normally or exhibits a marked change in performance; or
  - E. The appliance has been dropped, or the enclosure damaged.
- 18. Servicing** – The user should not attempt to service the appliance beyond that described in the operating instructions. All other servicing should be referred to qualified service personnel.
- 19. Outdoor Antenna Grounding** - If an outside antenna is connected to the receiver, be sure the antenna system is grounded so as to provide some protection against voltage surges and built up static charges. Article 810 of the National Electrical Code, ANSI/NFPA 70, provides information with regard to proper grounding of the mast and supporting structure, grounding of the lead-in wire to an antenna-discharge unit, size of grounding conductors, location of antenna-discharge unit, connection to grounding electrodes, and requirements for the grounding electrode. See Figure 1.

NEC – NATIONAL ELECTRICAL CODE

# Precautions

## 1. Warranty Claim

You can find the serial number on the rear panel. In case of warranty claim, please report this number.

## 2. Recording Copyright

Recording of copyrighted material for other than personal use is illegal without permission of the copyright holder.

## 3. AC Fuse

The fuse is located inside the chassis and is not user-serviceable. If power does not come on, contact your Onkyo authorized service station.

## 4. Care

From time to time you should wipe off the front and rear panels and the cabinet with a soft cloth. For heavier dirt, dampen a soft cloth in a weak solution of mild detergent and water, wring it out dry, and wipe away the dirt. Following this, dry immediately with a clean cloth. Do not use rough material, thinners, alcohol or other chemical solvents or cloths since these may damage the finish or remove the panel lettering.

## 5. Power

### WARNING

**BEFORE PLUGGING IN THE UNIT FOR THE FIRST TIME, READ THE FOLLOWING SECTION CAREFULLY.**

- The voltage of the available power supply differs according to country or region. Be sure that the power supply voltage of the area where this unit will be used meets the required voltage (e.g., AC230V 50Hz or AC120V 60Hz) written on the rear panel.
- Voltage Selector (Rear Panel)  
Worldwide models are equipped with a voltage selector to conform with local power supplies. Be sure to set this switch to match the power supply in your area before plugging in the unit (see page 5). Models without a voltage selector can only be used in areas where the power supply voltage is the same as that of the unit.

## FOR U.S. MODEL

### Note to CATV System installer:

- This reminder is provided to call the CATV system installer's attention to Section 820-40 of the NEC which provides guidelines for proper grounding and, in particular, specifies that the cable ground shall be connected to the grounding system of the building, as close to the point cable entry as practical.

### FCC Information for User

#### CAUTION:

Changes or modifications not expressly approved by the manufacturer for compliance could void the user's authority to operate the equipment.

#### NOTE:

This equipment has been tested and found to comply with the limits for a Class B digital device, pursuant to Part 15 of the FCC Rules. These limits are designed to provide reasonable protection against harmful interference in a residential installation. This equipment generates, uses, and can radiate radio frequency energy and, if not installed and used in accordance with the instructions, may cause harmful interference to radio communications. However, there is no guarantee that interference will not occur in a particular installation. If this equipment does cause harmful interference to radio or television reception, which can be determined by turning the equipment off and on, the user is encouraged to try to correct the interference by one or more of the following measures:

- Reorient or relocate the receiving antenna.
- Increase the separation between other equipment and the receiver.
- Connect the equipment into an outlet on a circuit different from that to which the receiver is connected.
- Consult the dealer or an experienced radio/TV technician for help.

## FOR CANADIAN MODEL:

### (POUR LE MODELE CANADIEN)

- For models having a power cord with a polarized plug

**CAUTION:** TO PREVENT ELECTRIC SHOCK, MATCH WIDE BLADE OF PLUG TO WIDE SLOT, FULLY INSERT. THIS DIGITAL APPARATUS DOES NOT EXCEED THE CLASS B LIMITS FOR RADIO NOISE EMISSION FROM DIGITAL APPARATUS SET OUT IN THE RADIO INTERFERENCE REGULATIONS OF THE CANADIAN DEPARTMENT OF COMMUNICATIONS.

- Sur les modèles dont la fiche est polarisée.

**ATTENTION:** POUR ÉVITER LES CHOCS ÉLECTRIQUES, INTRODUIRE LA LAME LA PLUS LARGE DE LA FICHE DANS LA BORNE CORRESPONDANTE DE LA PRISE ET POUSSER JUSQ'AU FOND.

L'INTERFÉRENCE RADIO ÉLECTRIQUE GÉNÉRÉE PAR CET APPAREIL NUMÉRIQUE DE TYPE B NE DÉPASSE PAS LES LIMITES ÉNONCÉES DANS LE RÈGLEMENT SUR LES PERTURBATIONS RADIO ÉLECTRIQUES, SECTION APPAREIL NUMÉRIQUE, DU MINISTÈRE DES COMMUNICATIONS.

## ATTENTION FOR BRITISH MODEL

Replacement and mounting of an AC plug on the power supply cord of this unit should be performed only by qualified service personnel.

### IMPORTANT

The wires in the mains lead are coloured in accordance with the following code:

Blue: Neutral

Brown: Live

As the colours of the wires in the mains lead of this appliance may not correspond with the coloured markings identifying the terminals in your plug, proceed as follows:

The wire which is coloured BLUE must be connected to the terminal in the plug which is marked with the letter N or coloured BLACK.

The wire which is coloured BROWN must be connected to the terminal in the plug which is marked with the letter L or coloured RED.

### IMPORTANT

A 5 amp fuse is fitted in this plug. Should the fuse need to be replaced, please ensure that the replacement fuse has a rating of 5 amps and that it is approved by ASTA or BSI to BS1362. Check for the ASTA mark or the BSI mark on the body of the fuse.

IF THE FITTED MOULDED PLUG IS UNSUITABLE FOR THE SOCKET OUTLET IN YOUR HOME, THEN THE FUSE SHOULD BE REMOVED AND THE PLUG CUT OFF AND DISPOSED OF SAFELY. THERE IS A DANGER OF SEVERE ELECTRICAL SHOCK IF THE CUT OFF PLUG IS INSERTED INTO ANY 13 AMP SOCKET.

If in any doubt, please consult a qualified electrician.

## FOR EUROPEAN MODEL

### Declaration of Conformity

We, ONKYO EUROPE  
ELECTRONICS GmbH  
INDUSTRIESTRASSE 20  
82110 GERMERING,  
GERMANY



declare in own responsibility, that the ONKYO product described in this instruction manual is in compliance with the corresponding technical standards such as EN55013, EN55020, EN61000-3-2, -3-3 and EN60065

GERMERING, GERMANY

K.OTSU

ONKYO EUROPE ELECTRONICS GmbH

# Features

## Amplifier Features

- **85 Watts Minimum** of continuous RMS power to each of the five channels into 8Ω from 20 Hz to 20 kHz with no more than 0.08% THD (North American models, FTC rating)  
**European Models:** 115 Watts minimum of continuous RMS power to each of the five channels into 6Ω, 1,000Hz, DIN
- **Asian Models:** 145 Watts minimum of continuous RMS power to each of the five channels into 6Ω, 1 kHz, EIAJ
- **Powerful High-Current, Low-Impedance Drive Amplifiers** for each of the 5 channels, with discrete output stages—no inexpensive ICs—assures that no channel information is compromised, and handles the wide dynamics of 5.1 channel movie soundtracks cleanly and effortlessly
- **Low Negative Feedback, Wideband Circuitry** minimizes noise and distortion
- **High Resolution 20-Bit Delta Sigma D/A and A/D Converters** for greater precision
- **3-D Bass** lets you boost ultra-low frequencies to the front 3 channels, for bass with greater clarity and impact

## Audio/Video Features

- **Dolby<sup>®</sup> Digital<sup>®</sup> Processor Built-In** to decode the 5.1 channel pristine digital audio on DVDs, HDTV and other sources
- **5.1 Channel External Inputs** give you the option of connecting an additional 5.1 channel decoder for DTS, MPEG and upcoming formats
- **Cinema Re-EQ<sup>™\*\*</sup> Circuitry**
- **6 Surround Modes:** Dolby Digital, Dolby Pro Logic, Hall, Live, Arena and Studio, with user-adjustable parameters for each mode, including venue size, effect and reverb levels, and reverb time delay
- **Upgraded Motorola 24-Bit Chip**, the DSP56009, runs at 88 MHz, and can execute 44 million instructions per second (MIPS) for greater processing capacity that translates into better dynamics, more reflections and more reverberations—parameters that define how real everything will sound—also gives you more control over factors exclusive to your home theaters, such as room size, ambiance, equalization and time delay
- **IPM—Intelligent Power Management** for powering up entire system and delivering surround sound whenever TV is turned on (audio triggered)
- **Onscreen Graphical Displays** in 7 colors, with a Superimpose mode to easily see the onscreen display over a TV picture—the display can also be moved to different positions within the screen
- **NTSC/PAL Compatible** (European and Asian models)
- **6 Pre Out Jacks**

## Tuner Features

- **Rotary Smart Scan Controller**
- **RDS (European models only) with PS, PTY, RT, TP**
- **30 FM/AM Random Presets** to store FM and AM stations
- **3 Station-Group Presets**
- **Selectable Character-Display Input** of up to 8 characters to write a descriptive label for each of the 30 preset stations and 3 station-group presets (A, B, C)

## General Features

- **Multiroom/Multisource Capability** with Main/Remote speaker selector and outputs to play two different sources simultaneously without the need of an additional amplifier (North American models are compatible with Xantech<sup>®</sup> products)
- **4-Mode Dimmer** (bright, normal, low, off)
- **Audio Mute** (remote) instantly switches off the sound—convenient for phone calls, and for recording without listening
- **Sleep Timer** (remote) shuts down system after 10 to 90 minutes (10 min. steps)
- **Battery-Free Memory Backup** protects memory's contents during a power outage or if the unit is temporarily unplugged

\* Manufactured under license from Dolby Laboratories. "Dolby", "Pro Logic" and the double-D symbol are trademarks of Dolby Laboratories. Confidential Unpublished Works. ©1992-1997 Dolby Laboratories, Inc. All rights reserved.

\*\* Re-Equalization<sup>™</sup> is a trademark of Lucasfilm Ltd.

# Supplied accessories

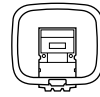

AM loop antenna (1)



T-shaped FM antenna (1)

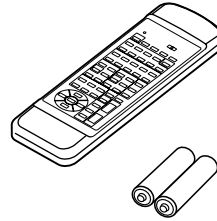

Remote controller (RC-373M) (1)  
Batteries (size AA, R6, or UM-3) (2)

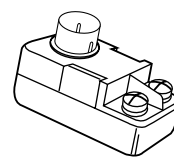

75/300 ohm antenna adapter (1)  
(Except for USA and European models)

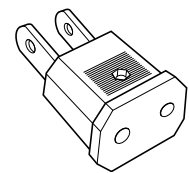

Conversion plug (1)  
(Worldwide model only)

## Multi-Room Remote System (MRX)

By connecting the Multi-Room Remote System equipment, you can operate all components connected to the TX-DS656 from either the main room or the sub-room. (Refer to pages 46 to 48 for more details.) The following equipment (sold separately) is essential for using the Onkyo Multi-Room System:

### U.S. & Canada:

- Onkyo's Multi-Room System kits HKT-600 or HKT-700 (IR Remote Control Extension System) and
- Xantech's Multi-Room System

### Other areas:

- Sensor Unit: Model No. HR-10
- Remote Emitter: Model No. HE-50 (AC)
- Remote Emitter Head: Model No. HE-10

The following secondary remote controller can be used to operate the system from the sub-room:

- Secondary Remote Controller for Multi-Room Remote System: Model No. RC-MR1H

Consult your nearest Onkyo service center when replacing your Onkyo Multi-Room System with a Xantech Multi-Room System.

## Memory Preservation

This unit does not require memory preservation batteries. A built-in memory power back-up system preserves the contents of the memory during power failures and even when the unit is unplugged. The unit must be plugged in order to charge the back-up system. The memory preservation period after the unit has been unplugged varies depending on climate and placement of the unit. On the average, memory contents are protected over a period of a few weeks after the last time the unit has been unplugged. This period is shorter when the unit is exposed to a highly humid climate.

# Before using this unit

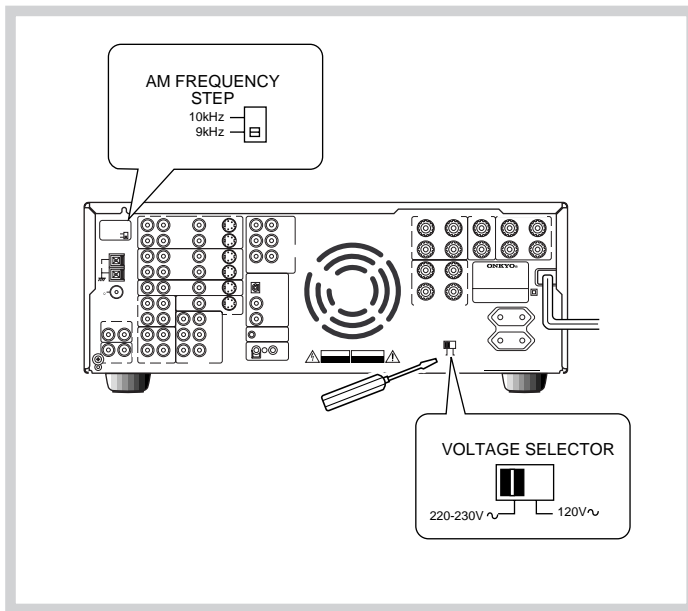

## Setting the AM tuning step frequency (worldwide model only)

Worldwide models are equipped with a switch that controls the AM band tuning steps. Set this switch to match the AM band tuning step frequency in your area.

U.S.A. and Canada : 10kHz  
Other areas : 9kHz

## Setting the voltage selector (worldwide model only)

Worldwide models are equipped with a voltage selector to conform with local power supplies. Be sure to set this switch to match the voltage of the power supply in your area before plugging in the unit.

1. Determine the proper voltage for your area: 220-230V or 120V.
2. If the preset voltage is not correct for your area, insert a screwdriver into the groove in the switch. Slide the switch all the way to the right (120V) or to the left (220-230V), whichever is appropriate.

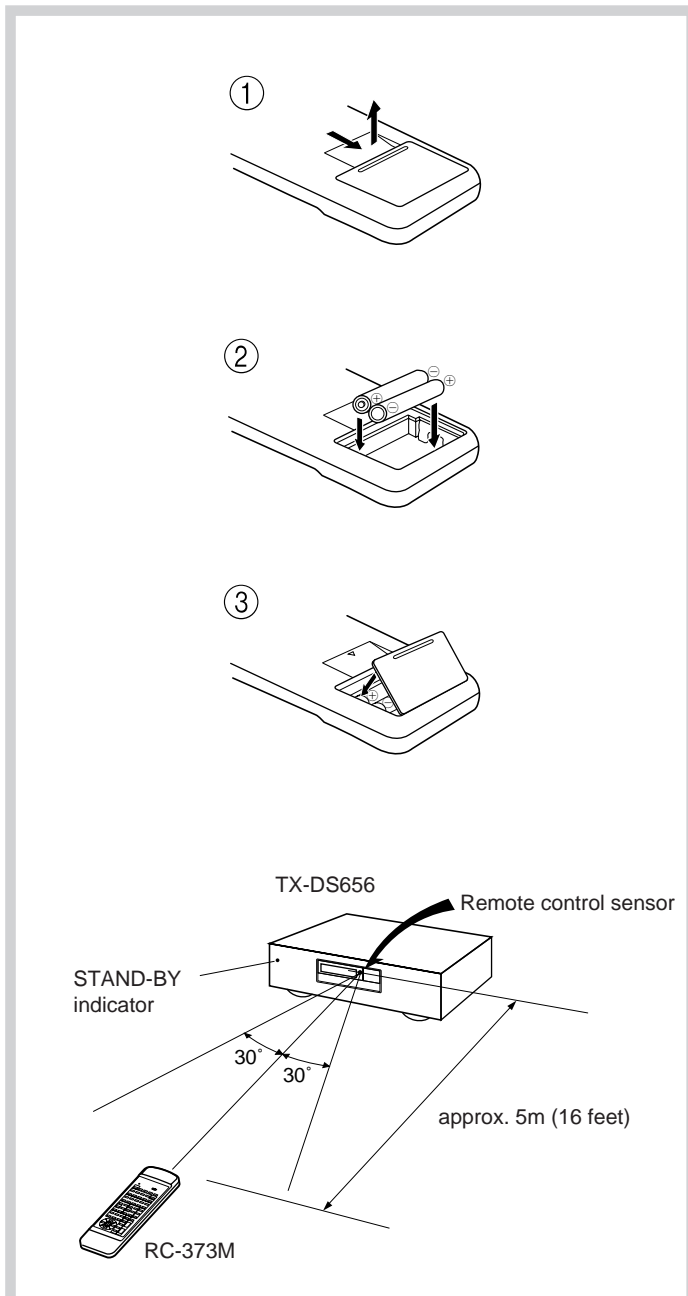

## Installing the batteries

1. Remove the battery compartment cover by pressing and sliding it out.
2. Insert two AA (R6 or UM-3)-size batteries into the battery compartment. Carefully follow the polarity diagram (positive (+) and negative (-) symbols) inside the battery compartment.
3. After batteries are installed and seated correctly, replace the compartment cover.
  - If the battery voltage is low, the indicator on the remote controller does not flash when you press a button on the controller. Remove low-voltage batteries immediately to avoid damage due to corrosion. Never mix old and new batteries.
  - The learned codes are retained, even when the batteries are replaced. They may be lost, however, if battery replacement is not completed within one hour. In this case, the unit must learn the codes again.
  - The manganese batteries supplied with this unit have a service life of approximately six months, depending on the frequency of use.
  - Use spare batteries of the type specified in the table below.

| Type                  | Voltage | Size                        |
|-----------------------|---------|-----------------------------|
| Manganese or Alkaline | 1.5V    | AA, R6 (UM-3) or LR6 (AM-3) |

We recommend that long-life AA (LR6 or AM-3)-size alkaline batteries be used.

## Using the remote controller

The STAND-BY indicator lights up when the unit receives a signal from the remote controller.

The following information will help you get optimal use from the remote controller.

- Place this receiver away from direct bright light, which could prevent proper operation of the remote controller.
- Make sure audio rack doors do not have tinted glass. Placing the receiver behind such a door may prevent proper remote control.
- Using other remote controllers along with this receiver's remote controller in the same room may cause interference.

# Connection

This section describes, step by step, how to connect the TX-DS656 to your home theater components.

- ① Connecting analog audio source equipment      page 8
- ② Connecting digital audio source equipment    page 8
- ③ Connecting video source equipment            page 9
- ④ Connecting a video camera or TV game machine   page 9
- ⑤ Connecting a decoder with 5.1-channel output   page 10
- ⑥ Connecting video recording equipment        page 10
- ⑦ Connecting audio recording equipment        page 11
- ⑧ Connecting the R I remote control cables    page 11
- ⑨ Connecting a TV/monitor                      page 12
- ⑩ Connecting the antennas                        page 13
- ⑪ Connecting speakers                            page 15
- ⑫ Connecting power amplifiers                Page 16
- ⑬ Using the AC outlets                          Page 17
- ⑭ Connecting the power                          Page 17

To connect source or recording equipment, use cables supplied by the equipment manufacturer.

**Note:**

- Do not turn on any component until you have completed all connections.
- Insert the plugs and connectors completely. Remember that improper connection may result in noise or malfunction.
- Do not bind audio connection cables with power cords and speaker cables. Doing so may degrade sound quality.

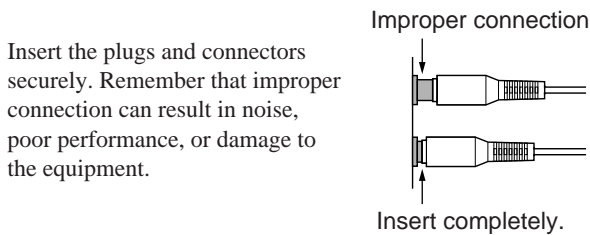

Insert the plugs and connectors securely. Remember that improper connection can result in noise, poor performance, or damage to the equipment.

⑩ Connecting the antennas

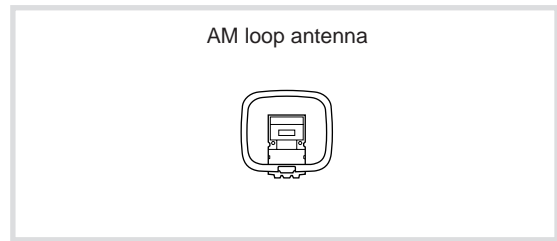

⑩ Connecting the antennas

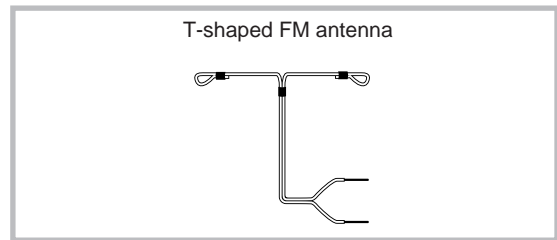

① Connecting analog audio source equipment

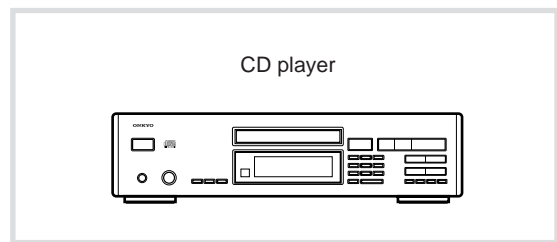

① Connecting analog audio source equipment

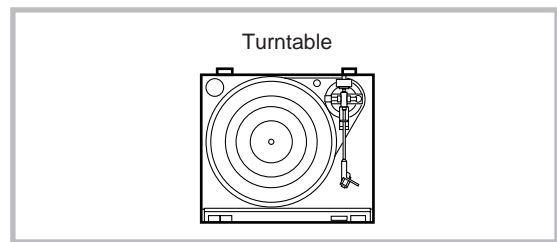

① Connecting analog audio source equipment  
⑦ Connecting audio recording equipment

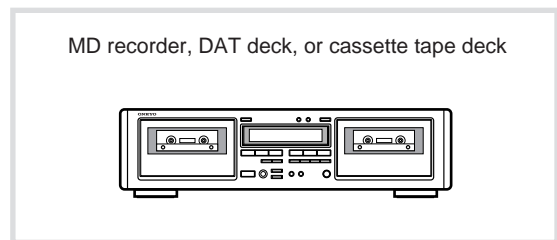

- ③ Connecting video source equipment
- ⑥ Connecting video recording equipment

- ② Connecting digital audio source equipment

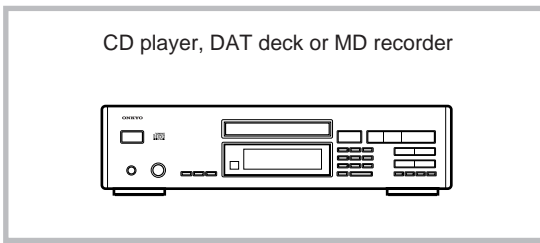
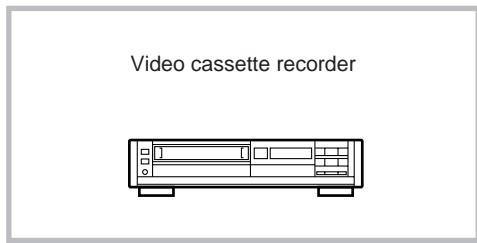

- ③ Connecting video source equipment



- ⑤ Connecting a decoder with 5.1-channel output

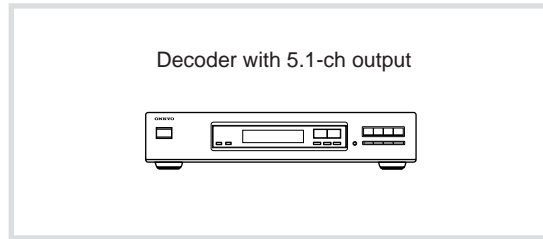

- ⑪ Connecting speakers

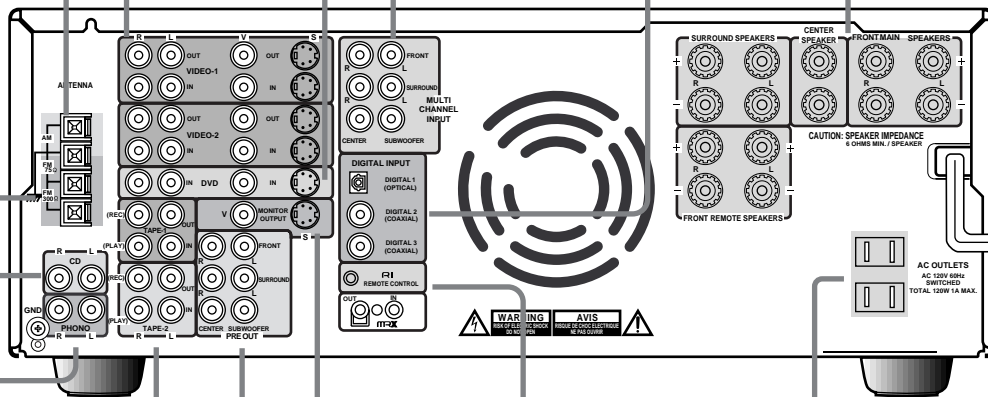

- ⑭ Connecting the Power

- ⑧ Connecting the RI remote control cables
- ⑬ Using the AC outlets

- ⑨ Connecting a TV/monitor

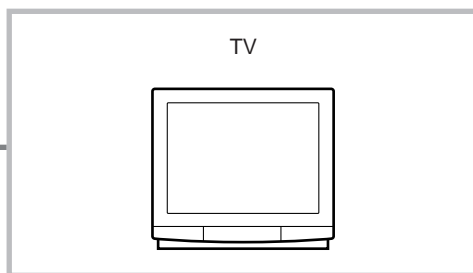

- ④ Connecting a video camera or TV game machine

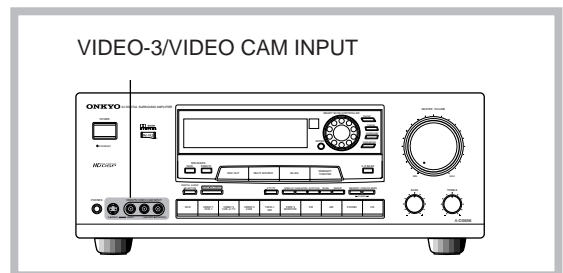

- ⑫ Connecting power amplifiers

# Connection

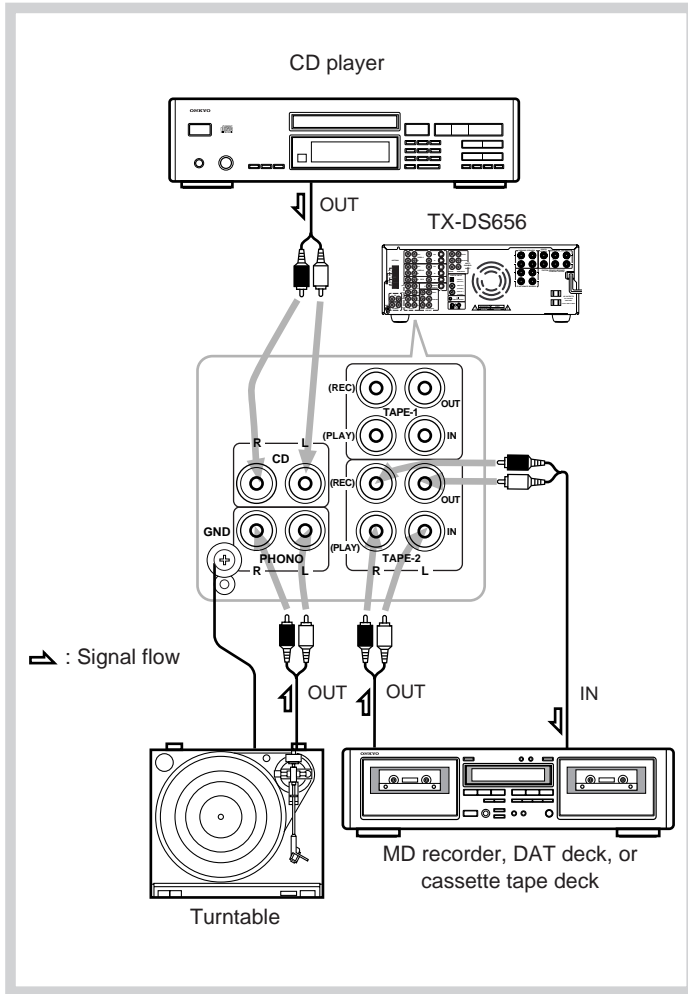

## ① Connecting analog audio source equipment

Connect your audio source equipment, such as a turntable, CD player, MD recorder, DAT deck, or cassette tape deck, as shown below.

### Audio connection cable

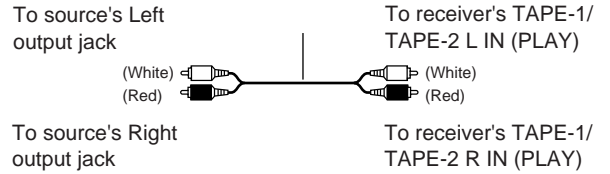

### If you have a 3-head cassette tape deck...

Connect it to the TAPE-2 IN jacks. This allows you to monitor the sound being recorded.

### GND terminals

Connect the grounding wire of your turntable to one of these terminals. Use the other terminal as a spare. Do not leave the grounding wire connected if noise increases after connecting.

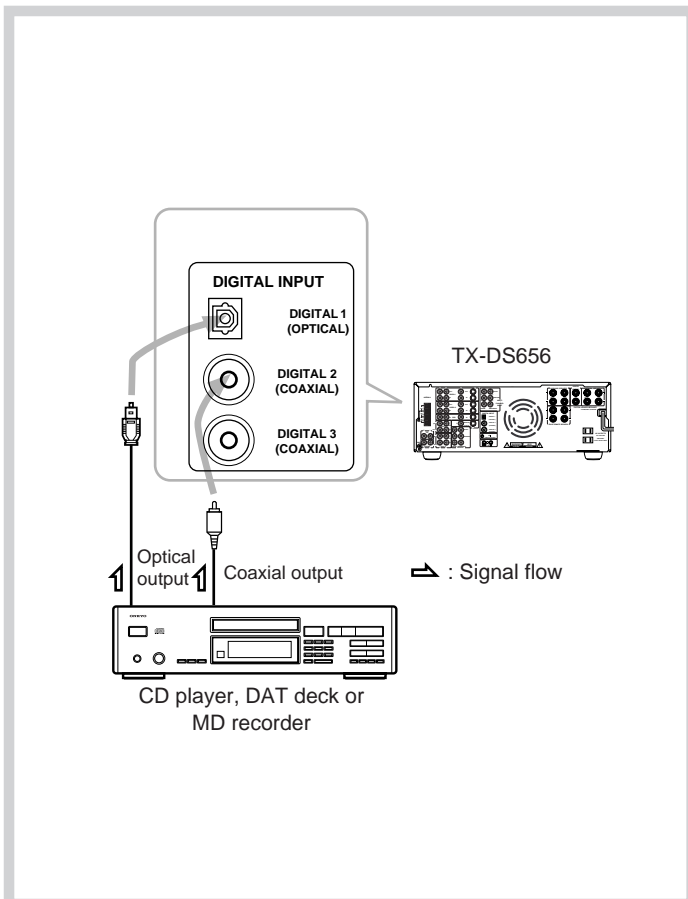

## ② Connecting digital audio source equipment

The TX-DS656 has three digital input terminals. Therefore, you can connect up to three digital audio sources, such as a CD player, MD recorder, or DAT deck, etc., using optical and coaxial cables.

### Note:

Even if the digital source is connected via optical or coaxial cable, it also must be connected via audio connection cables. The TX-DS656 receives analog signals from input source equipment only during recording or when the Multi-source function is enabled.

### • Source with optical digital output

#### Optical cable

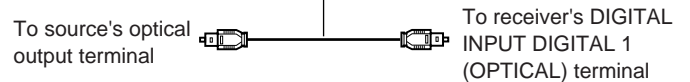

### • Source with coaxial digital output

#### Coaxial cable

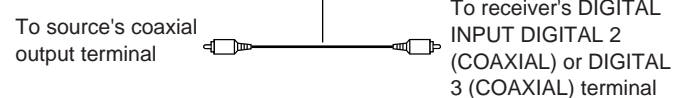

### Note:

- Remove the protective cap covering the DIGITAL-1 (OPTICAL) terminal before trying to make a connection. When this terminal is not in use, replace the protective cap.
- If you have an LD player with AC-3RF output, connect it via an AC-3RF demodulator to one of the TX-DS656's DIGITAL INPUT terminals.



# Connection

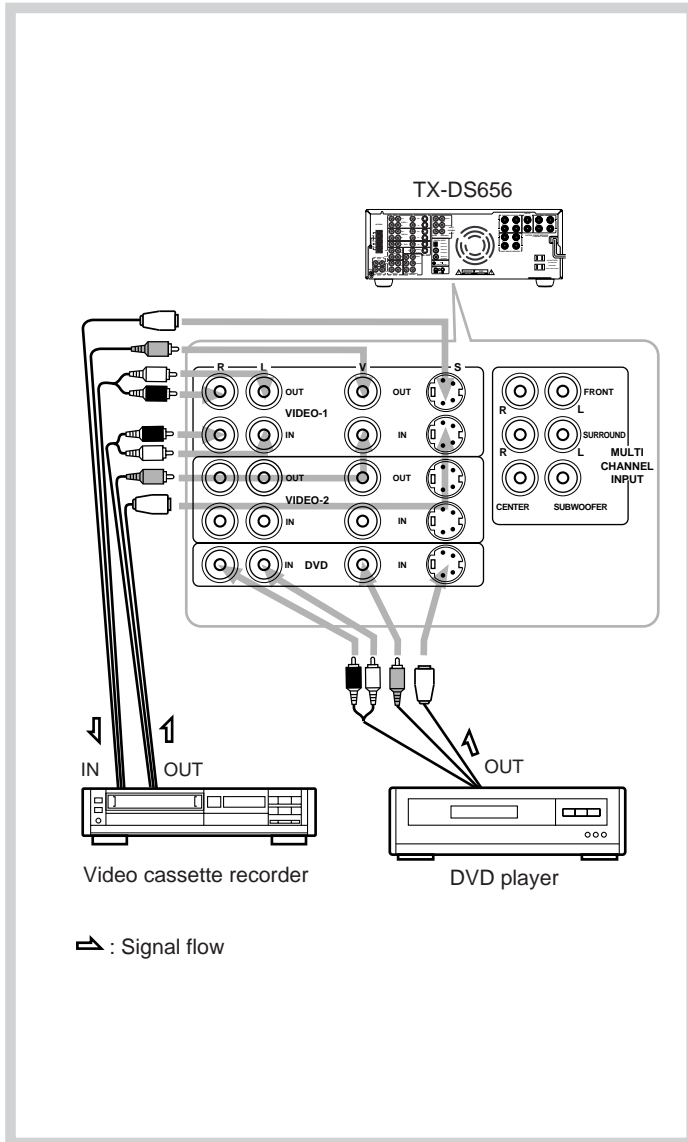

## ③ Connecting video source equipment

- With a DVD player, video disc player, etc., that is equipped with at least one digital audio output terminal, its audio output can be connected to the TX-DS656 via an optical or coaxial cable (see the previous page). In this case, for recording or using the Multi-source function, it is also necessary that you connect the equipment via audio connection cables.
- The VIDEO-1 and VIDEO-2 OUT jacks can be used to connect recording equipment such as a video cassette recorder.
- Video input signals to the TX-DS656 cannot be output back to the same or other equipment. In other words, the VIDEO-1 V OUT jack does not output signals which have been input to the TX-DS656 from its VIDEO-1 V IN jack.

### S-Video connection cable

To source's S-Video output jack

To receiver's VIDEO-1/2/3/DVD S IN jack

### Video connection cable

To source's Video (Yellow) output jack

To receiver's VIDEO-1/2/3/DVD V IN jack

### Audio connection cable

To source's Left audio output jack

To receiver's VIDEO-1/2/3/DVD L IN jack

To source's Right audio output jack

To receiver's VIDEO-1/2/3/DVD R IN jack

## If you have connected a video source with an S-Video output

- The TX-DS656 does not convert S-video input signals into normal video signals. That is, input signals to the VIDEO-1/2/3/DVD S IN jack will be output from the MONITOR OUTPUT S jack and the VIDEO-1/2 S OUT jack only. Similarly, input signals to the VIDEO-1/2/3/DVD V IN jack will be output from the MONITOR OUTPUT V jack and the VIDEO-1/2 V OUT jack only.
- See the owner's manual of your video source equipment to determine whether to connect it via normal video connection cables only or via both normal video and S-video connection cables.

## ④ Connecting a video camera or TV game machine

Connect your video camera or TV game machine to the VIDEO-3/VIDEO CAM INPUT jacks.

If a monaural video camera is used, connect its audio connection cable to "R (MONO)" audio jack.

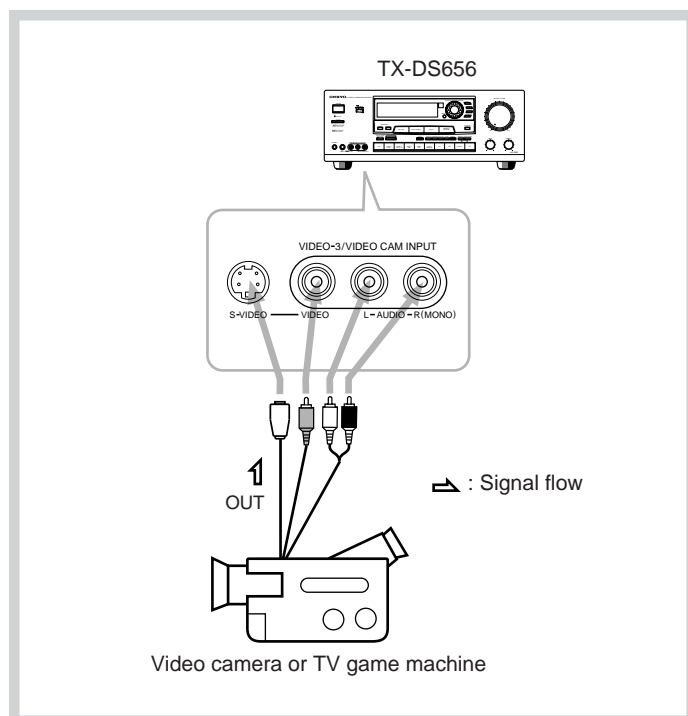

# Connection

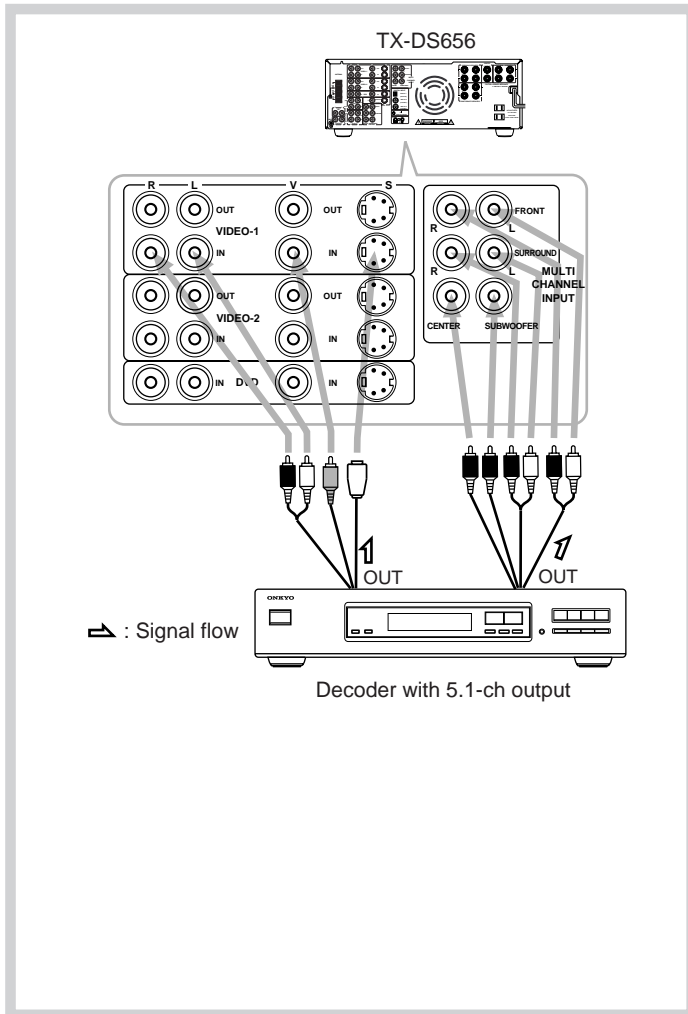

## ⑤ Connecting a decoder with 5.1-channel output

The TX-DS656's MULTI CHANNEL INPUT jacks can be used to connect a decoder equipped with 5.1-ch audio output (dts decoder, MPEG decoder, etc.). If you do so, use the V or S IN jack of the VIDEO-1/2 or DVD connector to connect the video or S-video connection cable.

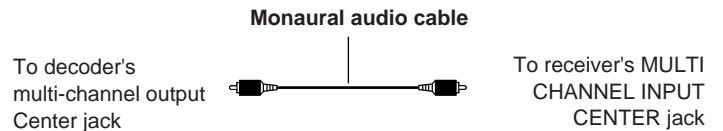
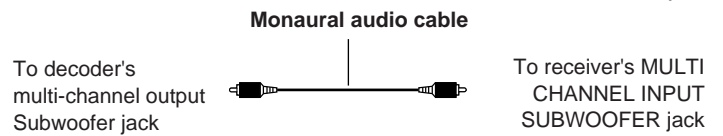
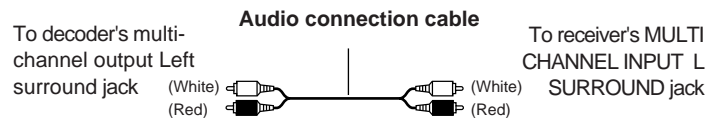
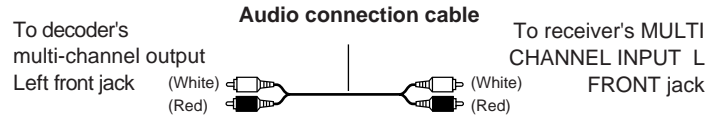

### Note:

The Surround function cannot be used if audio signals are input from the MULTI CHANNEL INPUT connector.

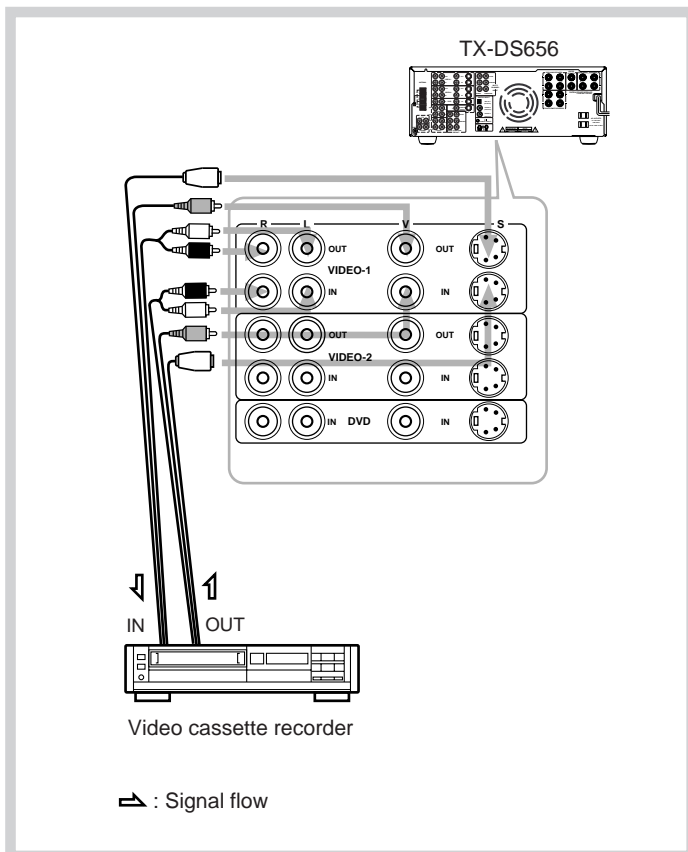

## ⑥ Connecting video recording equipment

Connect your video cassette recorder to the VIDEO-1/VIDEO-2 OUT jacks.

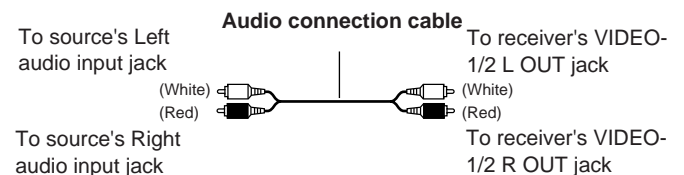
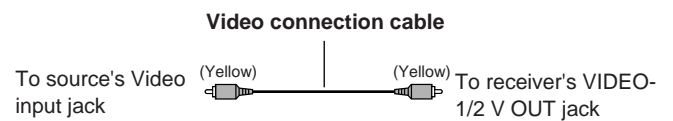
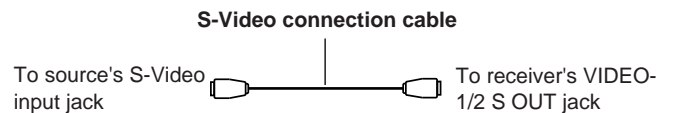

### Note:

When you connect a VCR, etc. to the VIDEO-2 R/L jacks, you must turn the IPM function off. (See page 12.)

# Connection

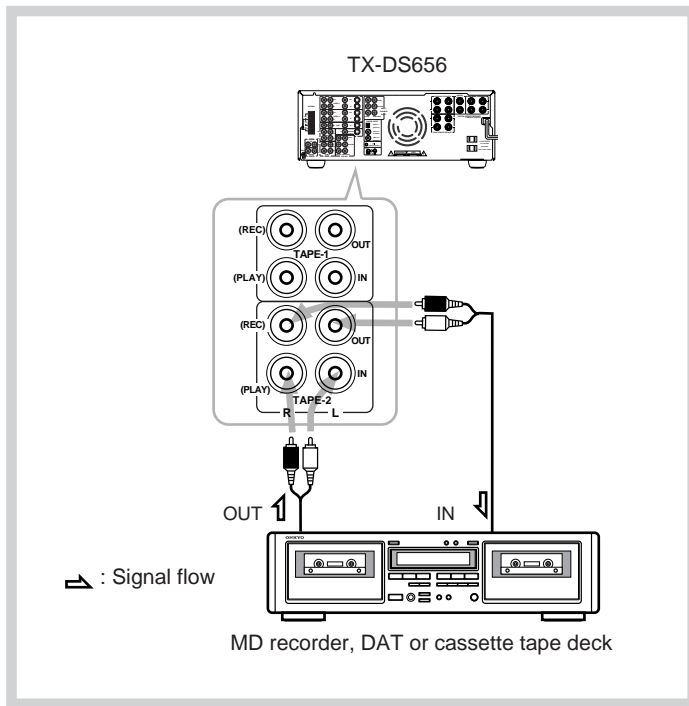

## 7 Connecting audio recording equipment

Connect your audio recording equipment to the TAPE-1/2 OUT (REC) jacks. Digital recording is not possible, even if a DAT deck or MD recorder is connected.

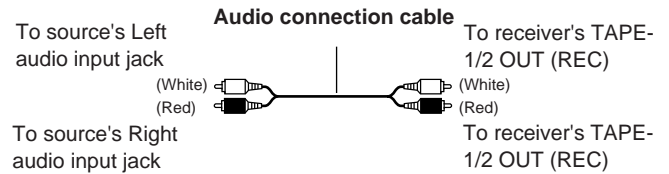

## If you have a 3-head cassette tape deck

Connect it to the TAPE-2 IN jacks. This allows you to monitor the sound being recorded.

## If you have a graphic equalizer

Connect the graphic equalizer to the TAPE-2 IN jacks and the recorder to the equalizer. If you do so, you can use the TAPE-2 Monitor function to monitor the sound processed by the equalizer during recording.

### CAUTION:

Do not select a Surround mode when using the equalizer. This will result in distortion and possible damage to the Surround decoder circuitry.

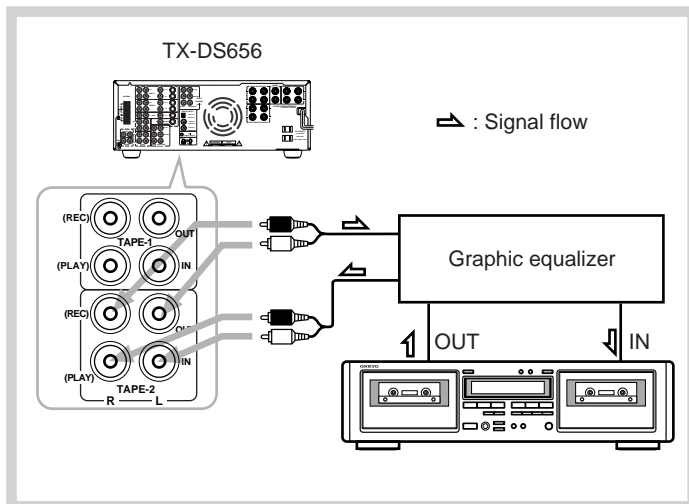

## 8 Connecting the RI remote control cables

An Onkyo cassette tape deck, CD player or DVD player equipped with an RI jack can be connected to the TX-DS656 via the remote control cable supplied with the unit. Once connected, it can be operated by using the receiver's remote controller.

### Note:

- Connect the remote control cable to the black jack with the **RI** mark; **never** connect it to the jack with the **MR** mark.
- For playback and recording, the unit also must be connected via audio connection cables.
- Do not use the **RI REMOTE CONTROL** jack to connect products not bearing **RI** symbol. Doing so may result in the failure of the equipment.
- You cannot operate turntables and MD recorders by remote controller even if they are Onkyo **RI** compatible.

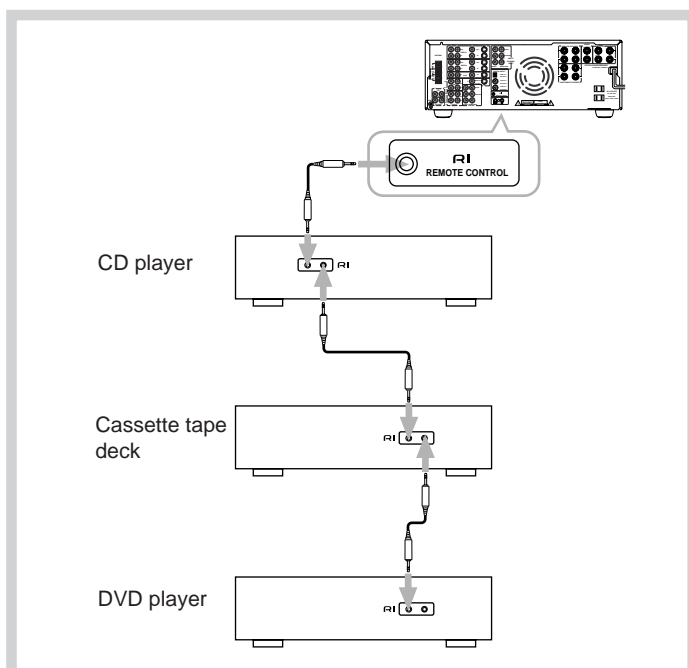

# Connection

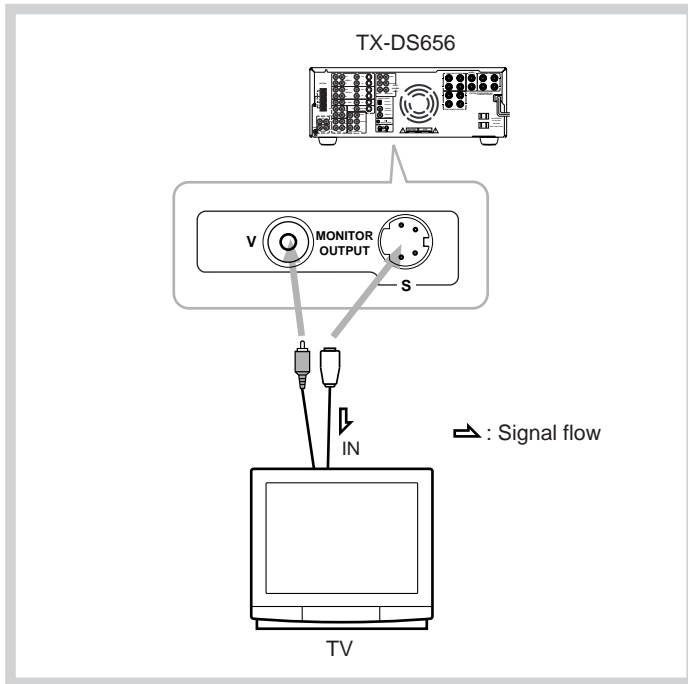

## 9 Connecting a TV/monitor

A TV or monitor equipped with a video input jack can be connected to the TX-DS656.

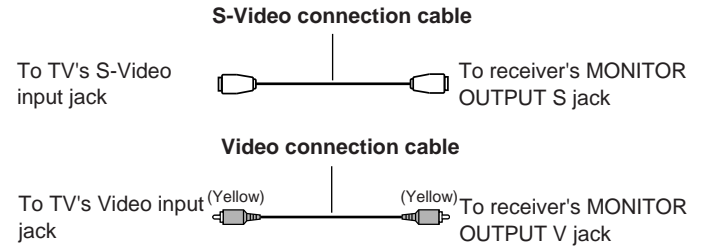

### Note:

If distortion of the TV image occurs or if noise is output from the unit, place the unit and the TV as far apart as possible.

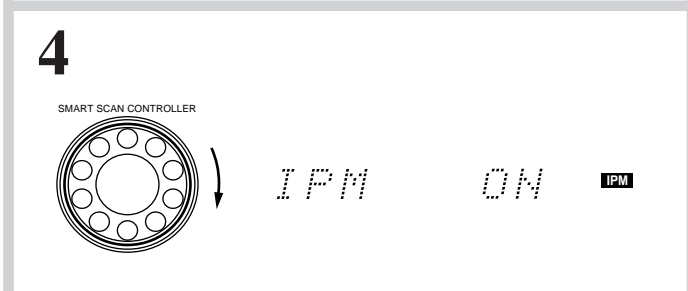
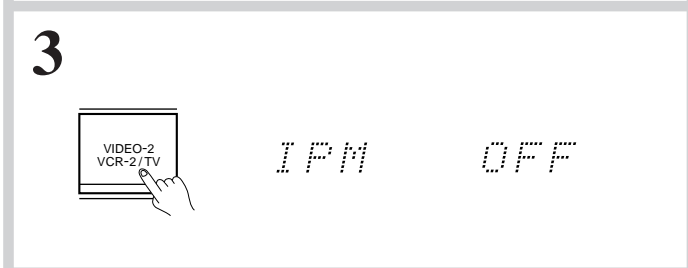
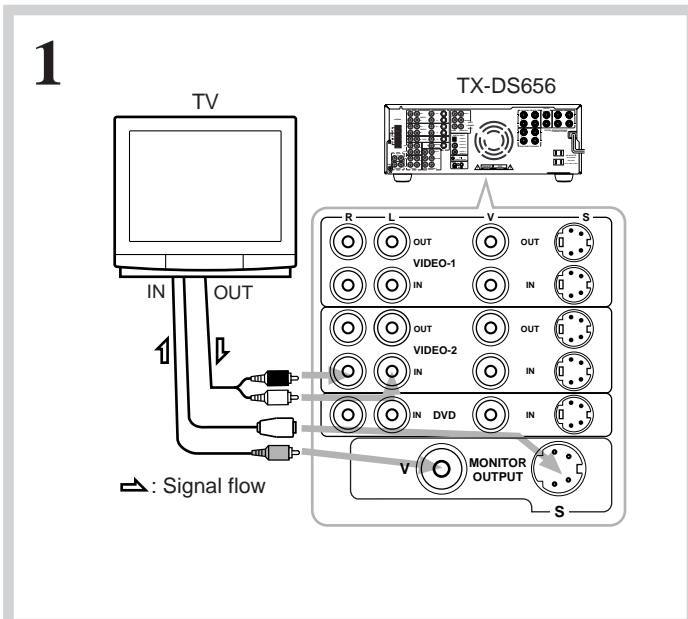

## Turning the unit on/off with the TV's power switch – IPM function

The TX-DS656 is equipped with the IPM (Intelligent Power Management) system.

Just turn on your TV's power switch and, in about 5 seconds, the TX-DS656 turns on automatically. If you turn off the TV's power switch, "." flashes on the display and the TX-DS656 automatically turns off in about 5 minutes.

### To activate the IPM function...

1. **Connect the audio output of your TV to the TX-DS656's VIDEO-2 L and R IN jacks.**  
If a monaural TV is used, connect the TV's audio output to the TX-DS656's VIDEO-2 L IN jack.
2. **Press the VIDEO-2 VCR-2/TV button on the front panel.**  
"VIDEO-2 VCR" or "VIDEO-2 TV" appears on the display.
3. **Press the VIDEO-2 VCR/TV button repeatedly until "IPM OFF (or IPM ON, if the function is already activated)" appears on the display.**
4. **Rotate the SMART SCAN CONTROLLER to select "IPM ON".**
  - The IPM function is activated and, after 3 seconds, the display changes to "VIDEO-2 TV".
  - If you select "IPM OFF", the display will change to "VIDEO-2 VCR" after 3 seconds.

### Note:

- The IPM system may not function properly with some TV sets.
- When the IPM system is activated, the video input signals to the VIDEO-2 V IN jack are not output from the MONITOR OUTPUT V jack.
- Setting a digital input mode for the VIDEO-2 input source automatically turns off the IPM function. You cannot turn on the TX-DS656 automatically.
- The IPM function cannot be used when the MULTI-CH INPUT source is selected.

### CAUTION:

If you have connected the TV's video output and video input to the TX-DS656's VIDEO-2 V IN and MONITOR OUTPUT V jacks, **be sure to turn ON** the IPM function. Otherwise, the signals will loop in the circuit, causing damage to the unit.

# Connection

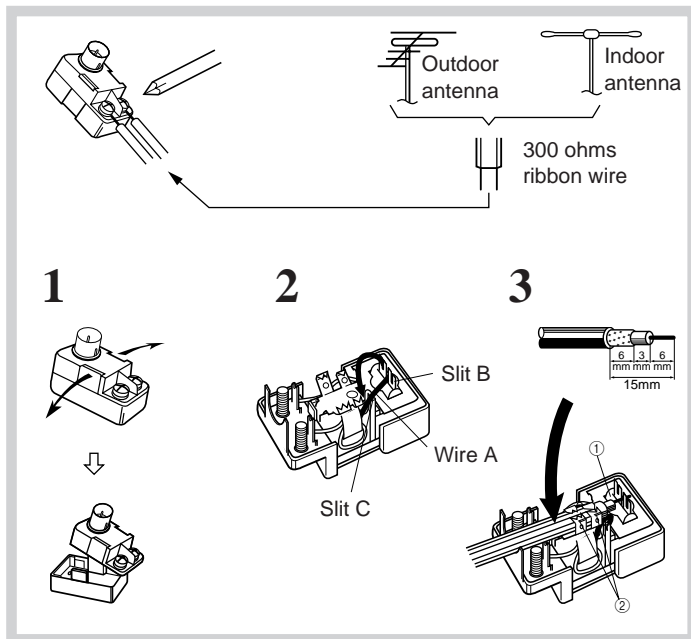

## ⑩ Connecting the antennas

### Connecting the antenna cable to the 75/300 ohm antenna adapter (worldwide models)

**Connecting a 300 ohm ribbon wire to the 75/300 ohm adapter:**  
Loosen the screws and wrap the wire around them. Tighten the screws with a screwdriver.

### Connecting a coaxial :

1. With your fingernail or a small screwdriver, press the stoppers outward and remove the cover.
2. Remove the transformer wire A from slit B and insert it into slit C.
3. Prepare the coaxial cable as shown in the diagram.  
Connect the 75/300 ohm antenna adapter to the coaxial cable.
  - ① Insert the end of the cable.
  - ② Clamp it in place with pliers.
4. Re-install the cover.
  - This adapter is included if your receiver is a worldwide model.

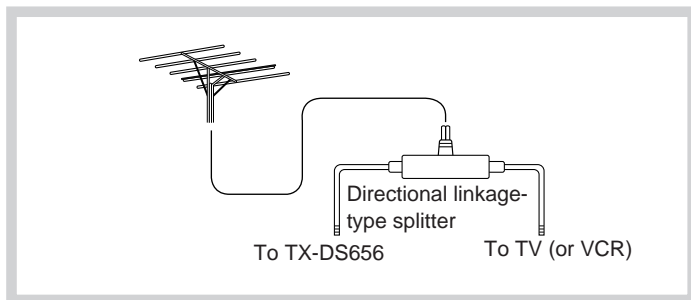

### Directional linkage

Do not use the same antenna for both FM and TV (or VCR) reception since the FM and TV (or VCR) signals can interfere with each other. If you must use a common FM/TV (or VCR) antenna, use a directional linkage-type splitter.

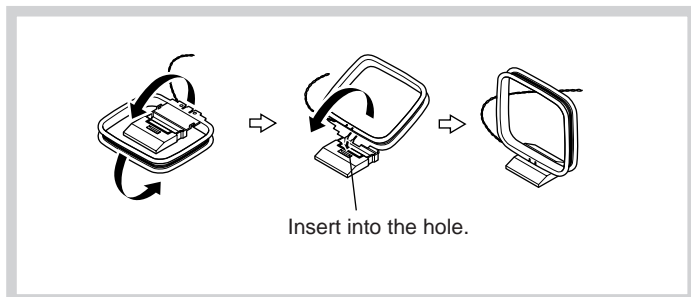

### Assembling the AM loop antenna

Assemble the loop antenna as shown in the illustration.

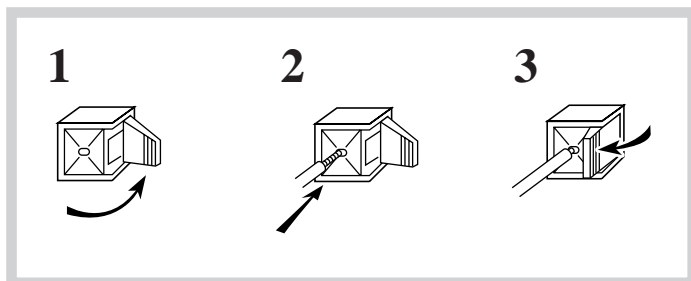

### Connecting the antenna cable

1. Press down on the lever.
2. Insert the wire.
3. Return the lever.

# Connection

## Connecting the included antennas

### Connecting the T-shaped FM antenna:

The T-shaped FM antenna is for indoor use only. Extend the antenna and move it in various directions until the clearest signal is received. Fix it with push pins or similar implements in the position that will cause the least amount of distortion.

If the reception is not very clear with the attached T-shaped FM antenna, the use of an outdoor antenna is recommended.

### Connecting the AM loop antenna:

The AM loop antenna is for indoor use only. Set it in the direction and position where you receive the clearest sound. Put it as far away as possible from the unit, TVs, speaker cables, and power cords.

When reception is not satisfactory with the attached AM loop antenna alone, connection of an outdoor antenna is recommended.

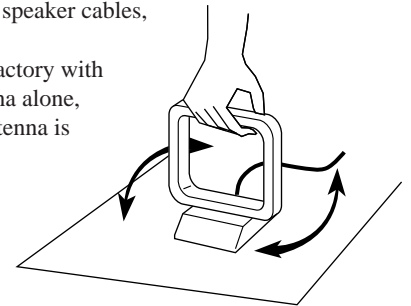

### Connecting an FM outdoor antenna

Please make sure that you follow the considerations below regarding the location.

Keep the antenna away from noise sources (neon signs, busy roads, etc.). It is dangerous to put the antenna close to power lines. Keep it well away from power lines, transformers, etc.

- To avoid the risk of lightning and electrical shock, grounding is necessary. Follow item 19 of the "Important Safeguards" on page 2 when you install the outdoor antenna.

### Connecting an AM outdoor antenna

The outdoor antenna will be more effective if it is stretched horizontally above a window or outside.

- Do not remove the AM loop antenna.
- To avoid the risk of lightning and electrical shock, grounding is necessary. Follow item 19 of the "Important Safeguards" on page 2 when you install the outdoor antenna.

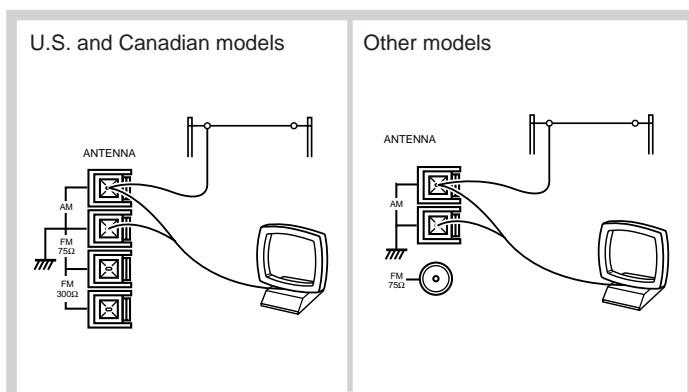
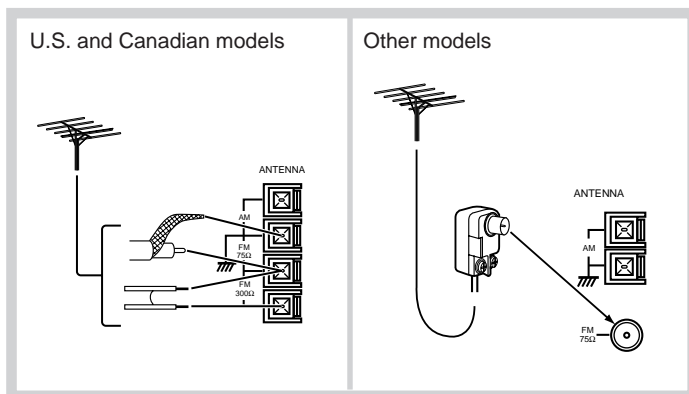
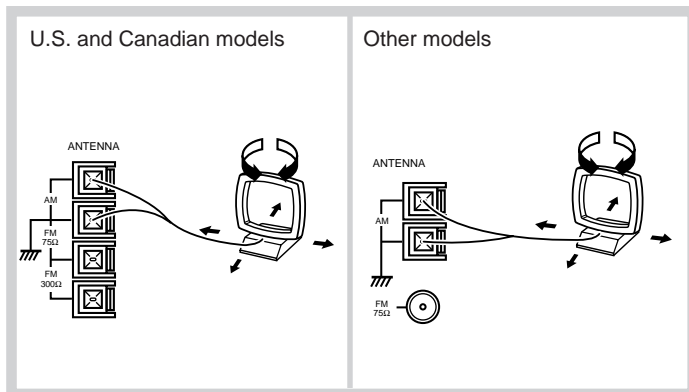
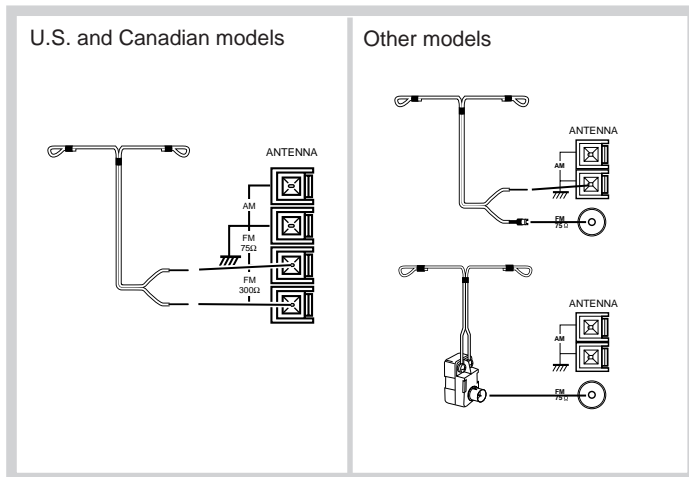

## If bipolar type speakers are connected to the surround channels

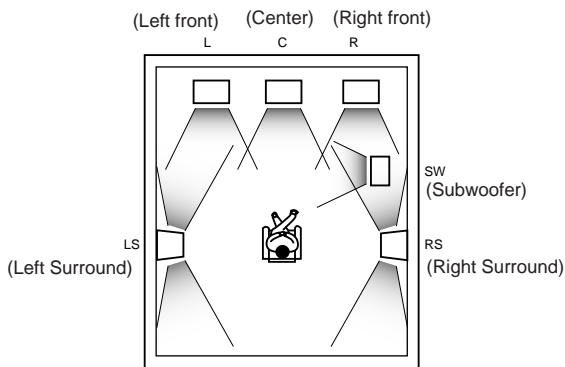

## If other speakers are connected to the surround channels

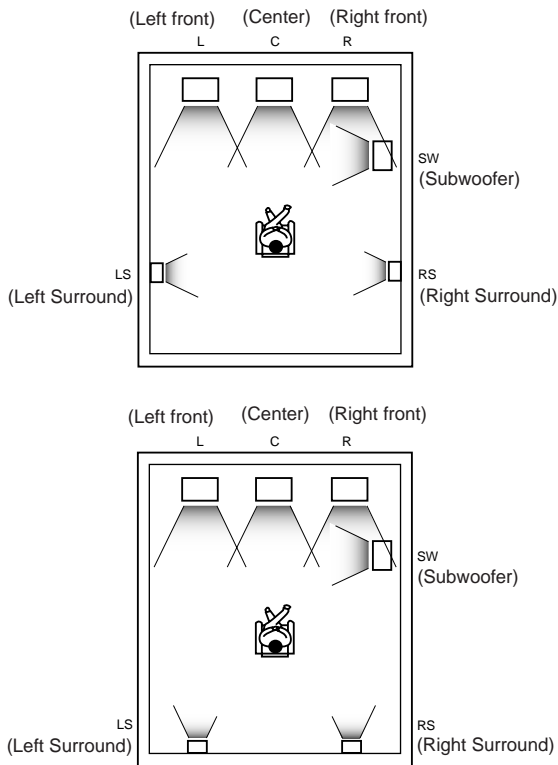

## 11 Connecting speakers

On the rear panel of the TX-DS656, two sets of speaker terminals are provided; one for main-room speakers and the other for sub-room speakers. This section provides information on connecting the main-room speakers.

- For how to connect sub-room speakers, see "Multi-room system connections" on pages 46, 47.
- For how to set speakers, see "Speaker system setup" on pages 21-24.

## Speaker placement

In this section, only typical examples of speaker placement are shown. Note, however, that ideal speaker placement varies depending on the size of the room and the wall coverings used in the room.

To obtain ideal sound field effects, the Left and Right front speakers must be placed at the same distance from the listening position.

### Recommendations

- Left and Right front speakers (L/R) and Center speaker (C)
  - Place these three speakers at the same height from the floor.
  - Place each speaker so that sound is aimed at the audience's ears at the listening position.
- Left and Right Surround speakers (LS/RS)
  - Place these speakers so that their height is 1 meter higher than that of the audience's ears.
- Subwoofer (SW)
  - Place it anywhere in your listening room because the placement of the Subwoofer affects the perceived direction of the sound very little.

### If your speaker system lacks Subwoofer, Center speaker, or Surround speakers

To get the highest-quality surround sound, you need a complete speaker system as shown. Even so, you can enjoy quality surround sound by setting up the speakers (see pages 25-28) so that the sound originally allocated to non-existing speakers is properly distributed to the existing Left and Right front speakers.

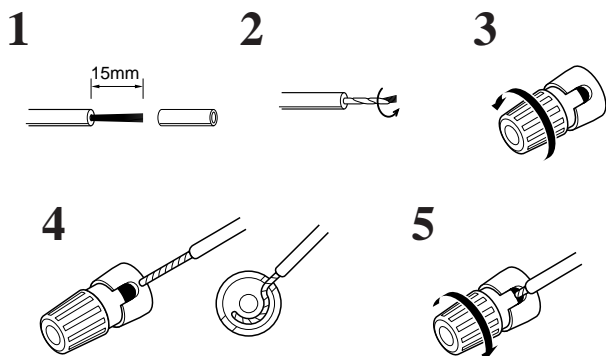

## Connecting the speaker cables

1. Peel the ends of the speaker cable 15 mm. Do not cut core wires.
2. Twist the core wires.
3. Loosen the cap on the speaker binding post by turning it counterclockwise.
4. Insert the core wires into the binding post.
5. Fasten the cap on the binding post by turning it clockwise.

When using banana plugs, be sure to tighten the speaker connector screws firmly before inserting the banana plugs.

- Note that the speaker connectors on the European and some other models are not banana-plug compatible.

# Connection

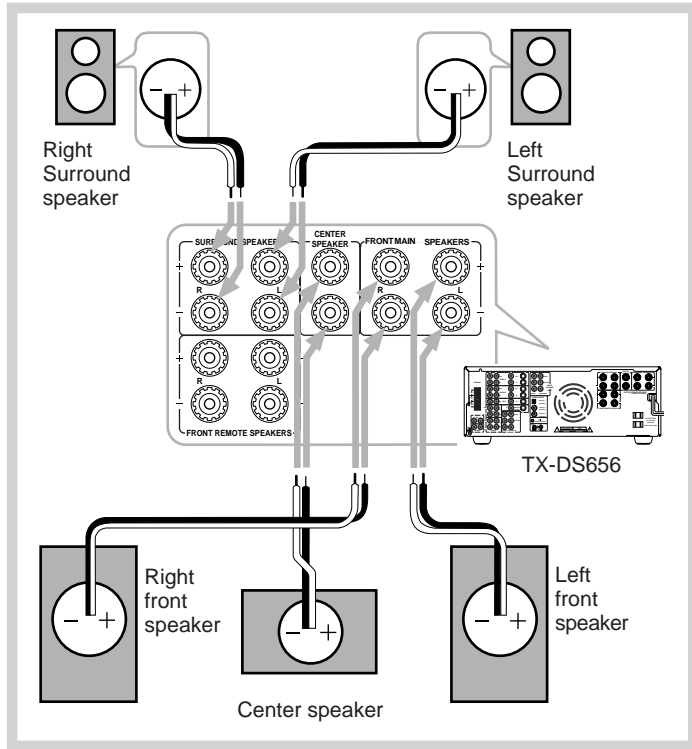

## Connection for Front, Center, and Surround speakers

### Note:

- Be sure to connect the Right and Left speakers to the receiver's corresponding speaker terminals. Also, be sure that you are connecting the speaker's positive (+) and negative (-) binding posts with the receiver's corresponding speaker terminals. Otherwise, inferior sound will result.
- Use speakers whose nominal impedance is  $6\Omega$ . Connecting a speaker whose impedance is less than  $6\Omega$  may cause damage to the receiver.
- Do not connect two or more speaker cables to the same speaker terminal. Doing so may cause damage to the receiver.

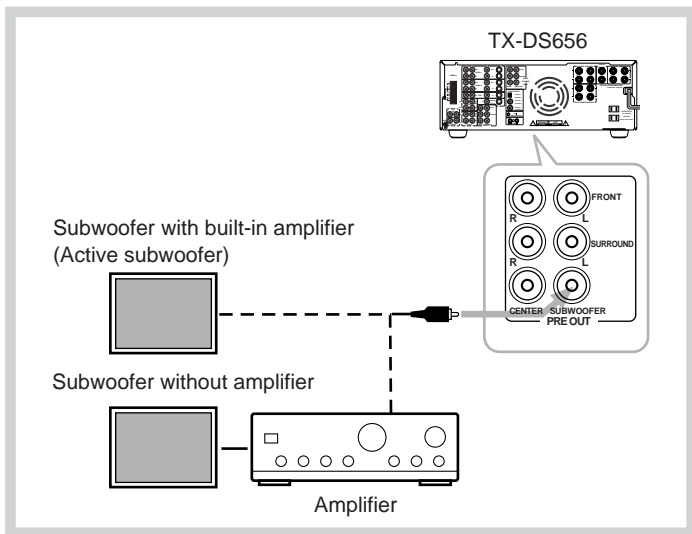
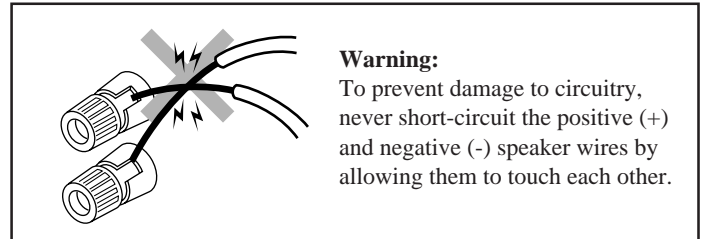

## Connecting a subwoofer

Use the PREOUT SUBWOOFER jack to connect a subwoofer with a built-in power amplifier. If your subwoofer does not have a built-in amplifier, connect an amplifier to the PREOUT SUBWOOFER jack and the subwoofer to the amplifier.

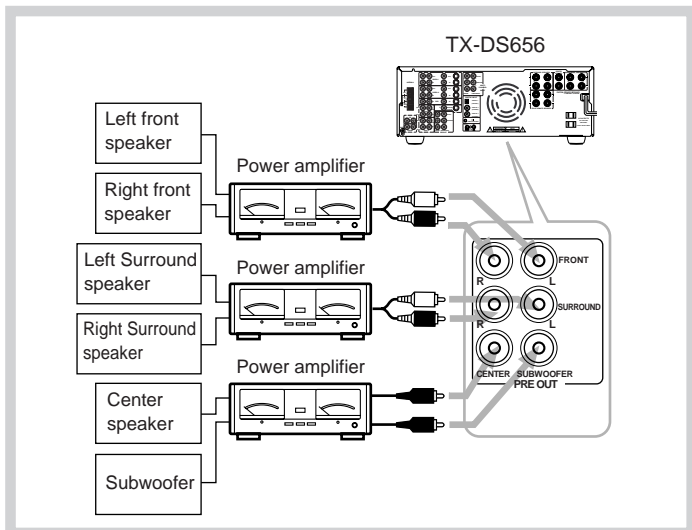

## ⑫ Connecting power amplifiers

Using auxiliary power amplifiers allows you to listen at louder volumes than with the TX-DS656 alone. If power amplifiers are used, connect each speaker to the corresponding power amplifier.



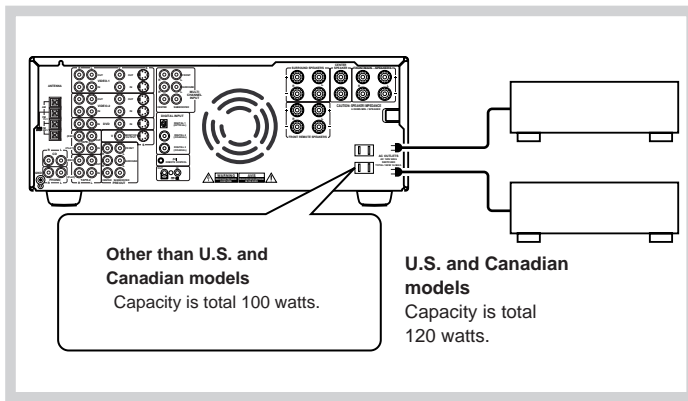

### ⑬ Using the AC outlets

You can connect the power cord from other audio device to the rear of the TX-DS656. Since the AC outlets on the unit are the SWITCHED type, you can use the POWER button (or the SYSTEM button), or the POWER button on the remote controller to turn on/off the power to both the TX-DS656 and the connected audio devices.

**Note:** If your TX-DS656 has a POWER switch, first turn it on.

The shape, number, and total capacity of the AC outlets may differ depending on the area of purchase. Make sure that the total capacity of other components connected to this unit does not exceed the capacity that is printed on the rear panel.

### ⑭ Connecting the power

- Before plugging in the receiver, confirm that all connections have been made properly.
- Before turning on the power, make sure that the MASTER VOLUME control is fully turned counterclockwise.
- Turning on this receiver's power may cause a momentary power surge, which might interfere with other electrical equipment, such as computers. If so, use a wall outlet on a different circuit.

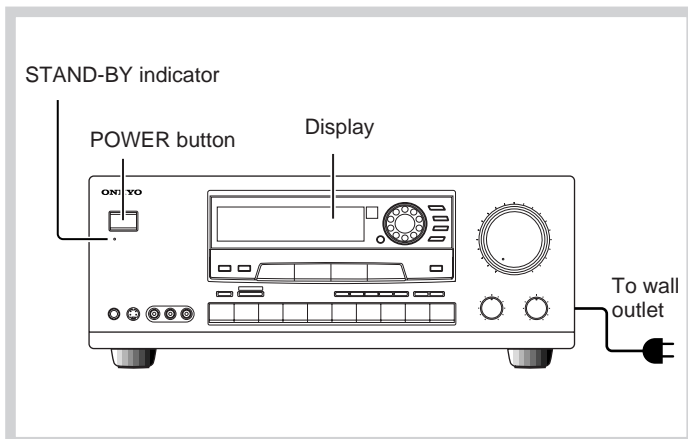

#### U.S. and Canadian models

1. **Plug the power cord into an AC wall outlet.**  
The STAND-BY indicator lights up and the receiver enters stand-by mode, ready for operation.
2. **Press the POWER button to turn on the receiver. The display will light up and the STAND-BY indicator will be turned off.**  
If you press the POWER button again, the receiver returns to stand-by mode.
- The POWER button on the remote controller is used in the same way as the POWER button on the TX-DS656.

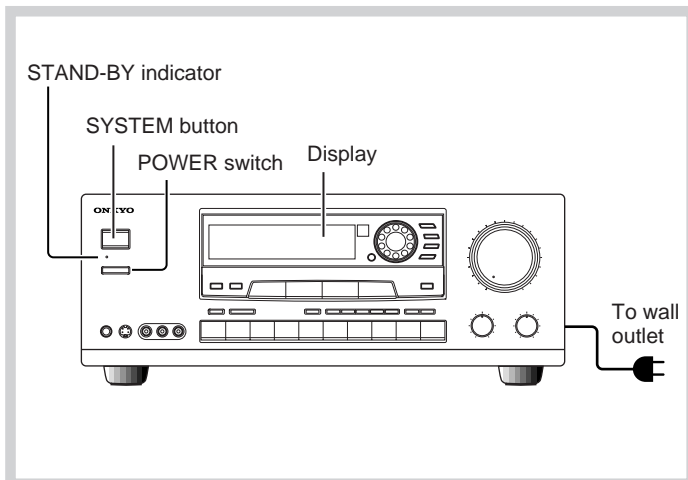

#### Other than U.S. or Canadian models

1. **Plug the power cord into an AC wall outlet.**
2. **Press the POWER switch to set the receiver to stand-by mode.**  
The STAND-BY indicator will light up.
3. **Press the SYSTEM button or POWER button on the remote controller to turn on the receiver. The display will light up and the STAND-BY indicator will be turned off.**  
If you press the SYSTEM button or POWER button on the remote controller again, the receiver turns to stand-by mode.
- You cannot use the remote controller if the POWER switch on the receiver is set to OFF.

# On-screen setting

If your TX-DS656 is connected to a TV set, you can perform various settings on the TV screen. This section shows you the basic operation of on-screen setting, as well as the method of changing the screen setup according to your preference.

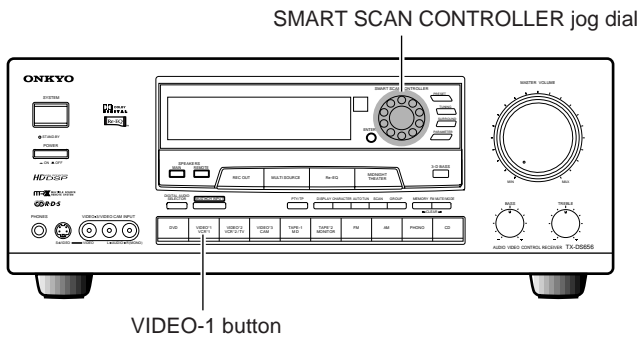

## Selecting the NTSC or PAL system (not available on U.S. and Canadian models)

The on-screen display is not output to any of the S-VIDEO connectors. If the picture on the screen scrolls with the TV signal that is being received, change the system setting.

Press the VIDEO-1 button to display "OSD". Rotate the SMART SCAN CONTROLLER clockwise or counterclockwise until the desired system appears on the display.

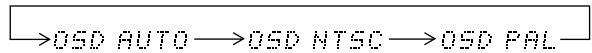

If "OSD AUTO" is selected, the unit automatically selects the system used by the connected TV/monitor or projector.

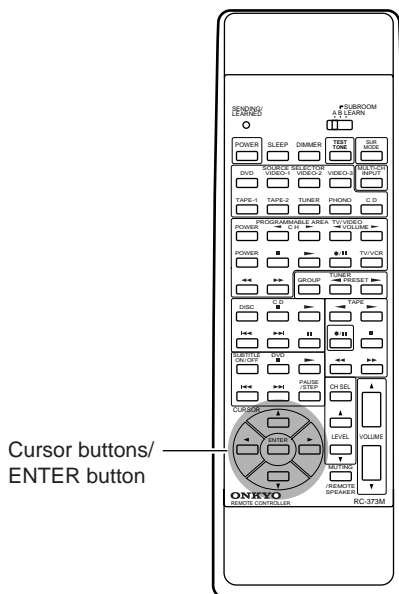

## If remote control operation is inoperative...

If pressing a remote controller button has no effect on the TX-DS656 even though the remote controller's SENDING/LEARNED indicator lights, verify that the A/B-SUBROOM/LEARN switch is set to "A".

## Note:

- On-screen setting is possible only when your TV is connected to the MONITOR OUTPUT V connector. The Menu will not appear if it is connected to the MONITOR OUTPUT S connector.
- The Menu will not be recorded even if it is displayed during recording.
- The Menu will not appear if the input selection on the TV is incorrect. Select the correct input channel that is connected to the MONITOR OUTPUT V connector of the TX-DS656.

# On-screen setting

1

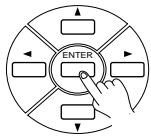

**ONKYO**  
\*\*\* Menu \*\*\*

|                |   |
|----------------|---|
| Input Selector | ▶ |
| Rec Selector   | ▶ |
| Surround Setup | ▶ |
| Screen Setup   | ▶ |
| System Setup   | ▶ |

2

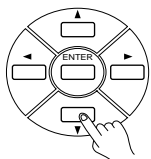

**ONKYO**  
\*\*\* Menu \*\*\*

|                |   |
|----------------|---|
| Input Selector | ▶ |
| Rec Selector   | ▶ |
| Surround Setup | ▶ |
| Screen Setup   | ▶ |
| System Setup   | ▶ |

3

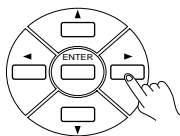

**ONKYO**  
\*\* Screen Setup \*\*

|                    |    |
|--------------------|----|
| Background         |    |
| Color = BLUE-1     | ◀▶ |
| Superimpose        |    |
| Mode = NORMAL      | ◀▶ |
| Immediate          |    |
| Display = ON       | ◀▶ |
| Character Position | ▶  |

4

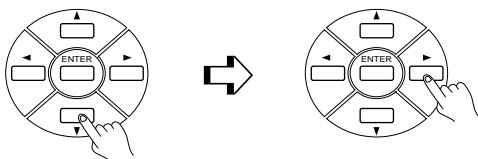

5

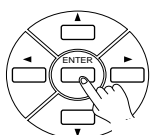

**ONKYO**  
\*\*\* Menu \*\*\*

|                |   |
|----------------|---|
| Input Selector | ▶ |
| Rec Selector   | ▶ |
| Surround Setup | ▶ |
| Screen Setup   | ▶ |
| System Setup   | ▶ |

6

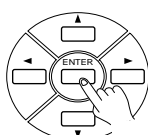

## Selecting a Menu item

The on-screen setting is performed by using the cursor buttons and the ENTER button on the remote controller. This applies to all the setup items.

In the following procedure, use the remote controller unless otherwise specified.

**1. Press the ENTER button.**

The Menu appears on the TV screen.

**2. Select the desired item using the ▲ or ▼ cursor button.**

**You can select the following items:**

"Input Selector" Select the channels from which video and sound signals are input.

"Rec Selector" Select the channels to which audio and/or recording equipment is connected.

"Surround Setup" Select the desired surround mode and make necessary surround setup.

"Screen Setup" Set up the screen according to your preferences.

"System Setup" Make necessary setting for your specific system configuration.

**3. Press the ► cursor button to display the screen for the selected item.**

Ex. Screen Setup screen

**4. Select the desired parameter using the ▲ or ▼ cursor button and change the setting using the ◀ or ▶ cursor button.**

**5. When all of the required parameters have been set, press the ENTER button.**

The Menu disappears from the TV screen.

# On-screen setting

1

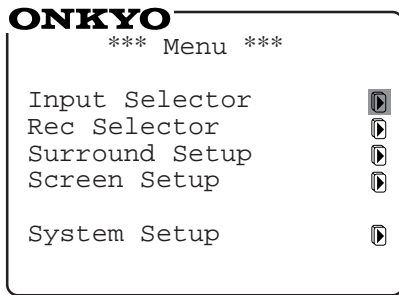
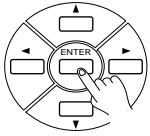

2

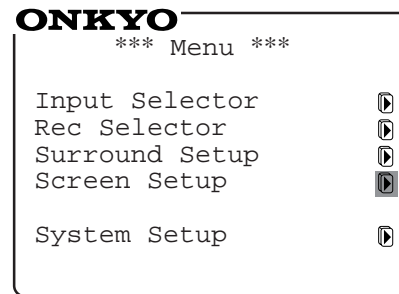
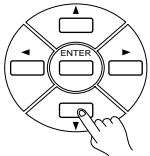

3

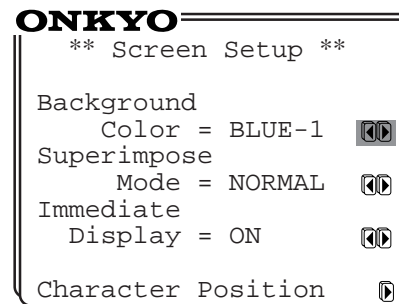
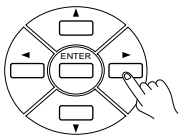

4

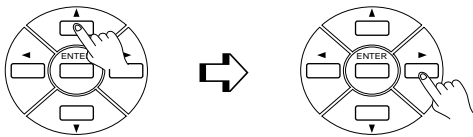

5

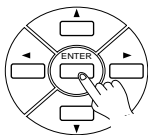

## Setting the background color and superimpose mode (Screen Setup)

In the following procedure, you can set the background color of the Menu and setting screens and how they are superimposed on the TV screen.

In the following procedure, use the remote controller unless otherwise specified.

1. **Press the ENTER button.**  
The Menu appears on the TV screen.
2. **Select "Screen Setup" using the ▲ or ▼ cursor button.**
3. **Press the ► cursor button to display the Screen Setup screen.**
4. **Select the desired parameter using the ▲ or ▼ cursor button and change the setting using the ◀ or ▶ cursor button.**  
Use the ▲ or ▼ cursor button to move among the parameters.

### Background Color

Select one from among BLUE-1, BLUE-2, GREEN-1, GREEN-2, MAGENTA, RED-1, and RED-2.

### Superimpose Mode

Select one of the following:

- OFF The Menu or setting screen is displayed on the selected background color.
- NORMAL The Menu or setting screen is superimposed on video image during playback and on the selected background color when playback is stopped.
- BLACK The Menu or setting screen is displayed on a black background.

### Immediate Display

Select ON or OFF. When ON, information such as the video and audio equipment currently selected appears on the TV screen for 3 seconds each time you operate your TX-DS656.

### Character Position

You can move the on-screen display to the lower left, upper left, upper right or lower right corner of the TV screen.

5. **When all of the required parameters have been set, press the ENTER button.**

# Speaker system setup

- Before performing speaker system setup, make sure that the speakers have been connected properly.
- To get optimized surround effects, you need the correct speaker setting for your speaker system and listening environment.

## What is "System Setup"?

In Speaker Setup, you perform the following three operations. You may use either the on-screen display or front panel switches.

- Speaker Setup
- Speaker Distance
- Level Calibration

### Speaker Setup

Set the frequency range covered by each speaker type. For a typical speaker system with six speakers, set "LARGE/SMALL" or "YES" for all speaker types.

- SW(Subwoofer):** Set this to "YES" if your system includes a subwoofer and to "NO" if you do not have a subwoofer.
- L/R (Left and Right front speakers):** Set this to "LARGE" usually. "LARGE" will be set automatically if your system does not include a subwoofer. Set it to "SMALL" if your L/R front speakers cannot cover the bass range.
- C (Center speaker):** If L/R is set to "LARGE", set this to "LARGE", "SMALL" or "NONE". Select "NONE" if no center speaker is present. If L/R is set to "SMALL", set it to "SMALL" or "NONE".
- LS/RS (Left and Right Surround speakers):** If L/R is set to "LARGE", set this to "LARGE", "SMALL" or "NONE". Select "NONE" if the surround speakers are not present. If L/R is set to "SMALL", set this to "SMALL" or "NONE".

### Available combination of each speaker type setting

| Speaker type     | Possible setting |                  |  |
|------------------|------------------|------------------|--|
|                  | YES              |                  | NO   |
| L/R (Front)      | SMALL            | LARGE            | Sets LARGE automatically and changes to next speaker type. |
| C (Center)       | SMALL/NONE       | LARGE/SMALL/NONE | LARGE/SMALL/NONE   |
| LS/RS (Surround) | SMALL/NONE       | LARGE/SMALL/NONE | LARGE/SMALL/NONE   |

#### Note:

The following is the factory setting for each speaker type:

- SW: YES  
 L/R: SMALL  
 C: SMALL  
 LS/RS: SMALL

### Distance setting

For each speaker type, set the distance from your listening position to where the speaker(s) is (are) located.

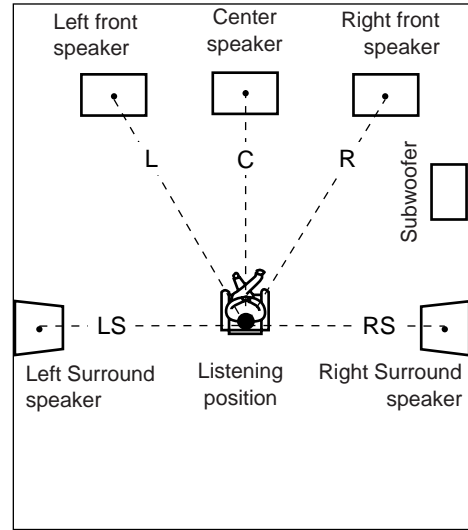

- L/R: Distance from listening position to L/R front speaker position.  
 C: Distance from listening position to Center speaker position.  
 LS/RS: Distance from listening position to L/R Surround speaker position.

### Level calibration (Channel balance setting)

Adjust the output level of each speaker. First set the output level using the test tone. Adjust it so that a test tone of the same volume can be heard from all speakers.

#### If you press the MULTI-CH INPUT button...

"Speaker Setup", "Speaker Distance", and "Level Calibration" are unnecessary. For details, see "Playing the input source connected to the MULTI CHANNEL INPUT connector" on page 29.

# Speaker system setup

**a**

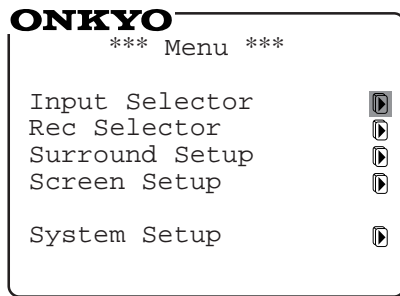

**b**



**c**

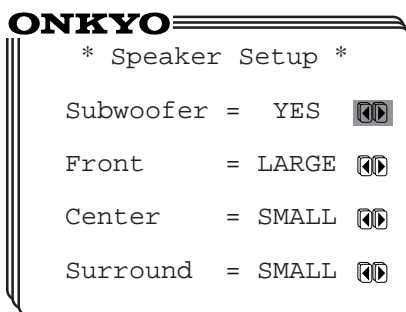

**d**

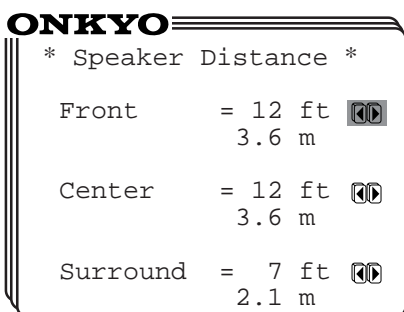

**e**

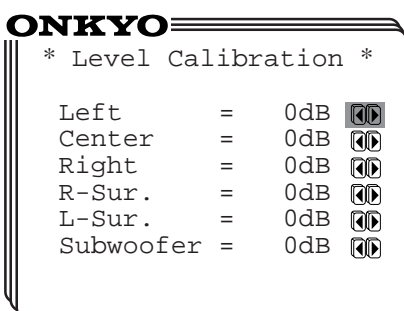

## On-screen speaker system setup

In the following procedure, use the remote controller unless otherwise specified.

1. Press the **POWER** button.
2. Press the **ENTER** button.  
The Menu appears on the TV screen. (a)
3. Select "System Setup" using the **▲** or **▼** cursor button, then press the **▶** cursor button.  
The System Setup screen appears. (b)
4. Select "Speaker Setup" using the **▲** or **▼** cursor button, then press the **▶** cursor button.  
The Speaker Setup screen appears. (c)
5. Select the desired speaker type ("Subwoofer", "Front", "Center", or "Surround") using the **▲** or **▼** cursor button and enter a speaker setting ("YES"/"NO" or "LARGE"/"SMALL"/"NONE") using the **◀** or **▶** cursor button.  
For further information, see "What is System Setup?" on page 21.
6. Press the **ENTER** button.  
You are now back to the System Setup screen.
7. Select "Speaker Distance" using the **▼** cursor button, then press the **▶** cursor button.  
The Speaker Distance screen appears. (d)
8. Select the desired speaker type ("Front", "Center", or "Surround") using the **▲** or **▼** button and set the distance to the selected speaker using the **◀** or **▶** cursor button.

You can enter the speaker distance in units of meters (m) or feet (ft). If "meters" is used, you can enter a distance within the range of 0.3m-9.0m in 0.3m increments. If "feet" is used, a distance within the range of 1 ft.-30 ft. can be entered in 1 foot increments. An unacceptable distance setting will be corrected automatically. In either case, an appropriate delay time\* will be set automatically according to the distance you enter.

\* "Delay time" is set according to the distance from the listening position to the Center and Surround speakers for an optimized surround sound.

### Note:

On the Speaker Distance screen, the speaker whose parameters have been set to "NO" in step 6 is not shown.

9. Press the **ENTER** button.  
You are now back to the System Setup screen again.
10. Select "Level Calibration" using the **▼** cursor button, then press the **▶** cursor button. (e)  
The Level Calibration screen appears and, at the same time, a test tone signal is output to each speaker channel in the following sequence:  
Left front speaker → Center speaker → Right front speaker → Right Surround speaker → Left Surround speaker → Subwoofer (Returns to Left front speaker)  
  
After a few seconds, the test tone automatically travels to the next speaker. You may use the **▲** or **▼** button to immediately move to the next speaker.
11. While the test tone is output, adjust the output level of the speaker.  
The test tone stays at the same speaker while adjustment is in progress.  
The adjustment range is -12dB to +12dB (-30dB to +12dB for Subwoofer).
12. When the output level of all speakers have been adjusted, press the **ENTER** button.  
The test tone signal output stops, and the System Setup screen is displayed.

# Speaker system setup

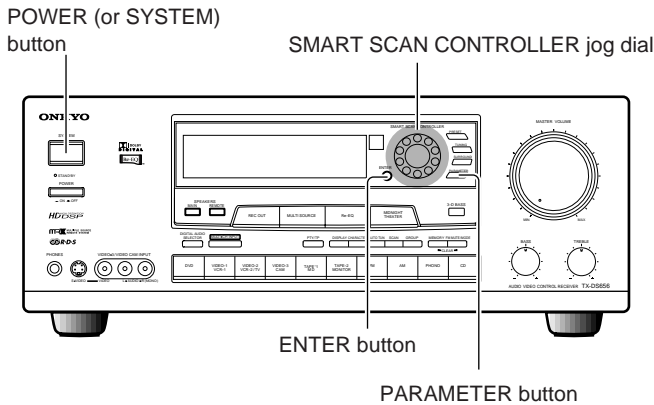

## Speaker system setup using the front panel

1. Press the **POWER (or SYSTEM)** button.
2. Press the **PARAMETER** button.  
"System Setup" scrolls across the display and then "System" appears. (a)
3. Press the **ENTER** button.  
"Sp. Setup" appears on the display.
- 3-1. Press the **ENTER** button again.  
The parameters for setting the presence/absence of a subwoofer are shown.
- 3-2. Select **"YES"** or **"NO"** using the **SMART SCAN CONTROLLER**.

Set the presence or absence of the front speakers (Front), center speaker (Center), and surround speakers (Surround) by repeating 3-1 and 3-2.

For further information, see "What is System Setup?" on page 21.

4. Press the **ENTER** button.  
"Speaker Distance" appears on the display.

4-1. Press the **ENTER** button again.  
The parameters for setting the distance to the front speakers are shown. (b)

- 4-2. Select the distance using the **SMART SCAN CONTROLLER**.

Set the distance to the center speaker (CNT) and surround speakers (SUR) by repeating 4-1 and 4-2.

You can enter the speaker distance in units of meters (m) or feet (ft). If "meters" is used, you can enter a distance within the range of 0.3m-9.0m in 0.3m increments. If "feet" is used, a distance within the range of 1 foot-30 feet can be entered in 1 foot increments. In either case, an appropriate delay time will be set automatically according to the distance you enter.

### Note:

The speaker whose parameters have been set to "NO" in step 3 are not shown.

5. Press the **ENTER** button.  
"Test ON" appears on the display.  
Press the **ENTER** button again. A test tone is output to each speaker in the following sequence:  
Left front speaker → Center speaker → Right front speaker → Right Surround speaker → Left Surround speaker → Subwoofer (Returns to Left front speaker)  
After a few seconds, the test tone automatically travels to the next speaker.
6. While the test tone is output, rotate the **SMART SCAN CONTROLLER** to adjust the output level of the speaker.  
The test tone stays at the same speaker while adjustment is in progress. You may press the **ENTER** button to immediately move to the next speaker.  
The adjustment range is -12dB to +12dB (-30dB to +12dB for Subwoofer).
7. When the output level of all speakers has been adjusted, press the **PARAMETER** button.

The test tone output stops and "System Setup" scrolls again. You are now out of the "Sp. Setup" mode. To cancel the "System Setup" display, press the **PARAMETER** button again or leave the unit for 5 seconds.

a

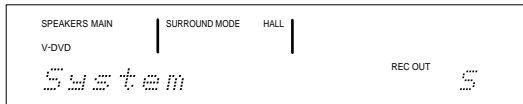

b

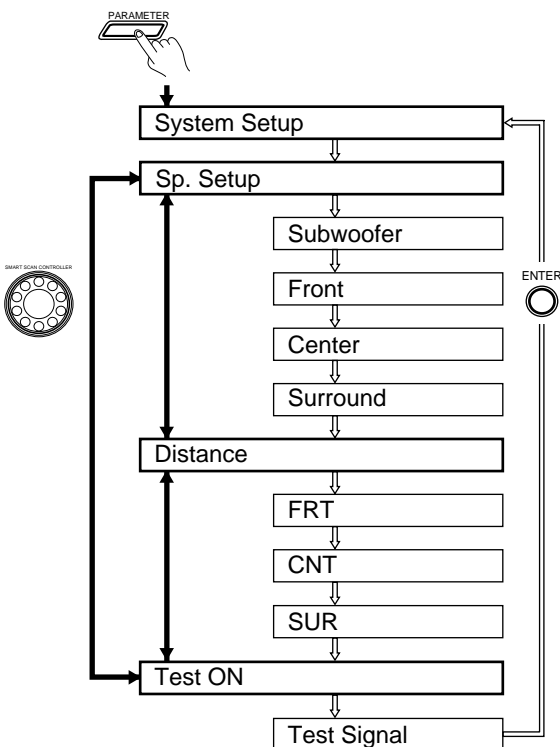
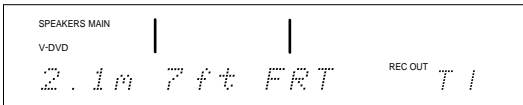

## Level Calibration using remote controller

You can perform level calibration (channel balance setting) independent of the other speaker system settings.

In the following procedure, use the remote controller unless otherwise specified.

**1. Press the POWER button.**

**2. Press the TEST TONE button.**

Press the TEST TONE button again. A test tone is output to each speaker in the following sequence:

Left front speaker → Center speaker → Right front speaker →  
Right Surround speaker → Left Surround speaker → Subwoofer  
(Returns to Left front speaker)

After a few seconds, the test tone automatically travels to the next speaker.

**3. While the test tone is output, adjust the output level of the speaker using the LEVEL ▲ or ▼ button.**

The test signal stays at the same speaker while adjustment is in progress.

You can change the channel to which the test tone is output by pressing the CH SEL button.

**4. Repeat step 3 to adjust the output level of all speakers.**

**5. When the adjustment is complete, press the TEST TONE button.**

The test tone output stops.

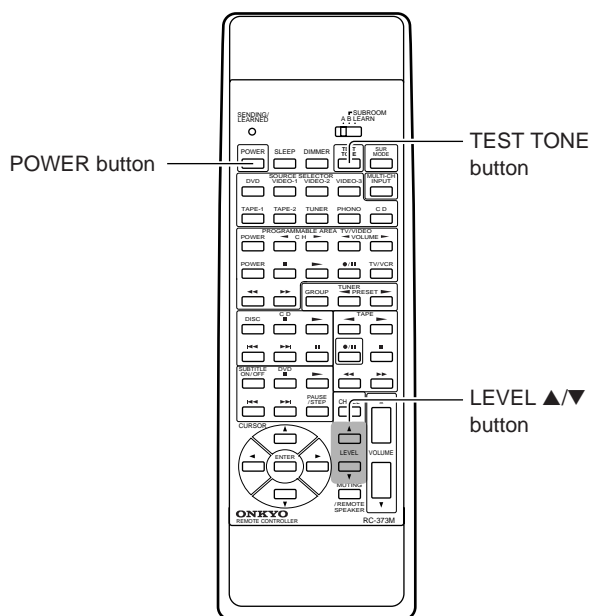



# Input source selection and surround setup

Before you can enjoy music or movies, you must select an input source and perform surround setups. This can be done in one of the following three ways:

- Display the Menu on the TV screen and use the cursor buttons and ENTER button on the remote controller.
- Use the unit's front panel operation buttons.
- Use the remote controller operation buttons

For how to play source equipment connected to the MULTI CHANNEL INPUT connector, see page 29.

For how to use the built-in tuner, see "Listening to FM/AM broadcasts" on page 32.

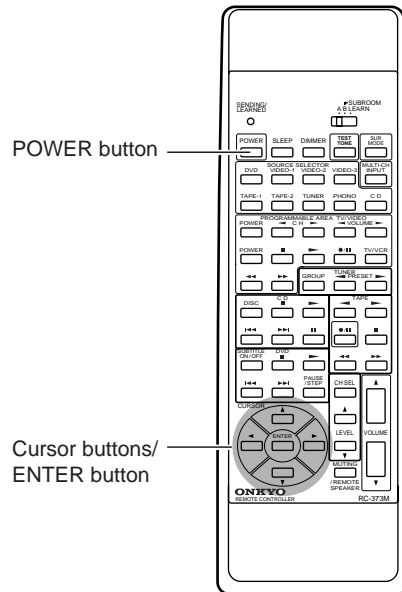

**a**

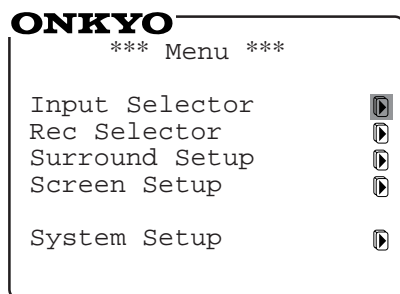

**b**

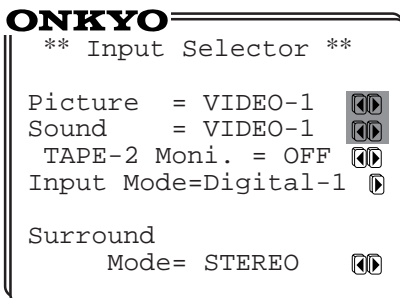

## Using the on-screen Menu

If your TX-DS656 is connected to a TV set, you can perform settings on the TV screen. For further information about using the on-screen Menu, see "Selecting a Menu item" on page 19.

In the following procedure, use the remote controller unless otherwise specified.

1. Press the **POWER** button.

### Note:

If the **SPEAKERS MAIN** indicator is not lit on the display, press the **SPEAKERS MAIN** button on the unit's front panel to make it appear on the display.

2. Press the **ENTER** button.

The Menu appears on the TV screen. (a)

3. Select "Input Selector" using the **▲** or **▼** cursor button, then press the **▶** cursor button.

The Input Selector screen appears. (b)

4. Select the desired item(s) using the **▲** or **▼** button.

The item (or items) you select changes each time you press the **▲** or **▼** button.

"Picture" only

"Picture" and "Sound"

"Sound" only

### To set different input sources for "Picture" and "Sound"...

If you wish to enjoy CD sounds while watching DVD pictures on TV, for example, repeat steps 4 and 5 to set different input sources for the "Picture" and "Sound" items.

## Input source selection and surround setup

5. **Select the input source(s) using the ◀ or ▶ cursor button.**  
The input sources you can select are same as those you can select by using the input selector buttons on the front panel.

| Picture/Sound setting | Selected input source  |
|-----------------------|--|
| DVD                   | DVD player   |
| VIDEO-1               | Video Cassette Recorder  |
| VIDEO-2               | Video Cassette Recorder, TV  |
| VIDEO-3               | Video camera   |
| TAPE-1                | MD recorder, DAT deck, cassette tape deck                                  |
| TUNER                 | Built-in tuner   |
| PHONO                 | Turntable  |
| CD                    | CD player  |
| MULTI-CH              | Multi-channel audio input (Previously selected video source for "Picture") |

### To select "TAPE-2"...

Select "TAPE-2 Moni." using the ▲ or ▼ cursor button and set it to "ON" or "OFF" to enable or disable the TAPE-2 Monitor function. For details, see "Using the TAPE-2 MONITOR function" on page 44.

### If the selected input source is connected to one of the DIGITAL INPUT connectors of the TX-DS656...

Select "Input Mode" using the ▲ or ▼ cursor button and then press the ▶ button to display the Digital Selector screen. For details, "Selecting the digital/analog audio input" on page 30.

6. **Start playing the selected input source.**  
If you have selected "TUNER" in step 5...  
Select the "Group" and "Preset No." items using the ▲ or ▼ cursor button, then set a correct group and preset number using the ◀ or ▶ cursor button. For details, see "Tuning in a broadcasting station" on page 32.  
Note that you cannot select stations which have not been preset.
7. **Adjust the sound volume using the VOLUME ▲ or ▼ button.**

### If no sound is output...

Check if "TAPE-2 MONITOR" is shown on the display. If it is lit, the TAPE-2 function is enabled and sound is not output when an input source other than "TAPE-2" is selected. In this case, press the TAPE-2 button to clear the "TAPE-2 MONITOR" display. For details, see "Using the TAPE-2 MONITOR function" on page 44.

8. **Select "Surround Mode" using the ▼ cursor button, then set the desired surround mode using the ◀ or ▶ cursor button.**

### To have stereo sound output...

Set the Surround Mode item to "STEREO". If you have set the System Setup's Subwoofer parameter to YES, you can still specify whether or not you wish to use the subwoofer when Surround mode is STEREO. Set this parameter to YES if you wish to use the subwoofer in STEREO mode. If you have set the System Setup's Subwoofer parameter to NO, this parameter will not appear.

The surround mode once set will be recalled automatically every time the same input source is selected.  
"Surround Mode" is not shown if you have selected "MULTI-CH" on the Input Selector screen.

9. **Press the ENTER button to set parameters for the selected surround mode.**  
You are now back to the Menu. (c)
10. **Select "Surround Setup" using the ▲ or ▼ cursor button and then press the ▶ cursor button to display the Surround Setup screen. (d)**
11. **Select the desired surround mode parameter using the ▲ or ▼ cursor button and enter the setting using the ◀ or ▶ cursor button.**  
For details, see "Changing the surround mode parameters" on page 40.
12. **Press the ENTER button twice to clear the on-screen display.**  
Pressing the ENTER button once brings you to the Menu. Pressing it again causes the Menu to disappear.

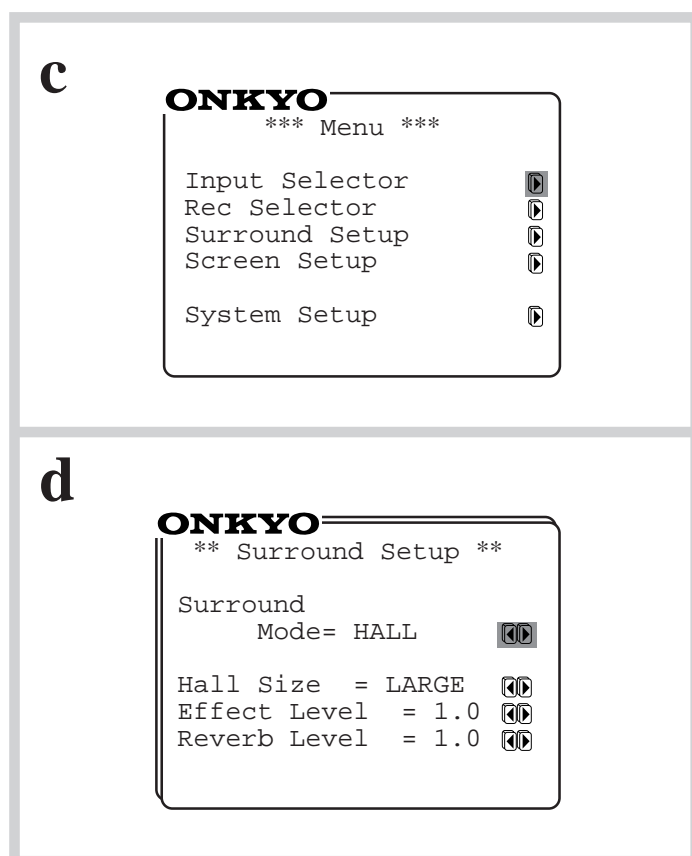

# Input source selection and surround setup

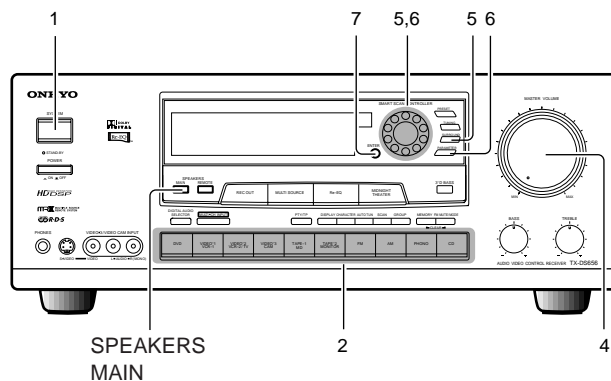

## Using the front panel

### 1. Press the POWER (or SYSTEM) button.

The STAND-BY indicator on the front panel goes out and the display lights up.

#### Note:

If the SPEAKERS MAIN indicator is not lit on the display, press the SPEAKERS MAIN button on the unit's front panel to make it appear on the display.

### 2. Select the desired input source using the input selector buttons.

| Input selector button | Selected input source                     |
|-----------------------|---|
| DVD                   | DVD player                                |
| VIDEO-1 VCR-1         | Video Cassette Recorder                   |
| VIDEO-2 VCR-2/TV      | Video Cassette Recorder, TV               |
| VIDEO-3 CAM           | Video camera                              |
| TAPE-1 MD             | MD recorder, DAT deck, cassette tape deck |
| TAPE-2 MONITOR        | Cassette tape deck                        |
| FM                    | Built-in tuner                            |
| AM                    | Built-in tuner                            |
| PHONO                 | Turntable                                 |
| CD                    | CD player                                 |

### If the selected input source is connected to one of the DIGITAL INPUT connectors of the TX-DS656...

Press the DIGITAL AUDIO SELECTOR button. Rotate the SMART SCAN CONTROLLER to select the DIGITAL INPUT connector to which the input source is connected, then press the ENTER button. For details, "Selecting the digital/analog audio input" on page 30.

### 3. Start playing the selected input source.

#### If you have selected "FM" or "AM" in 2...

Select the desired broadcasting station using the SMART SCAN CONTROLLER. For details, see "Tuning in a broadcasting station" on page 32.

### 4. Adjust the sound volume using the MASTER VOLUME control knob.

Turn the knob clockwise to increase the sound volume; turn it counterclockwise to decrease the sound volume.

Turning the MASTER VOLUME control knob adjusts the volume of the front, center, and surround speakers and the PRE OUT outputs simultaneously.

#### If no sound is output...

Check if "TAPE-2 MONITOR" is shown on the display. If it is lit, the TAPE-2 function is enabled and sound is not output when an input source other than "TAPE-2" is selected. In this case, press the TAPE-2 MONITOR button to clear the "TAPE-2 MONITOR" display. For details, see "Using the TAPE-2 MONITOR function" on page 44.

### 5. Press the SURROUND button and then rotate the SMART SCAN CONTROLLER to select the desired surround mode.

#### To have stereo sound output...

Set the Surround Mode item to "STEREO". If you have set the System Setup's Subwoofer parameter to YES, you can still specify whether or not you wish to use the subwoofer when Surround mode is STEREO. Set this parameter to YES if you wish to use the subwoofer in STEREO mode. If you have set the System Setup's Subwoofer parameter to NO, this parameter will not appear.

The surround mode once set will be recalled automatically every time the same input source is selected. (The previously set surround parameters will also be recalled.)

For details, see "Selecting a surround mode" on page 39.

### 6. Press the PARAMETER button and then rotate the SMART SCAN CONTROLLER to display "Surround Setup".

SMART SCAN CONTROLLER

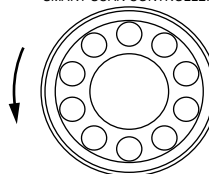

#### Note:

"Surround Setup" will not appear if the Dolby Pro Logic mode is set.

### 7. Press the ENTER button to select the desired surround mode parameter and then enter the setting using the SMART SCAN CONTROLLER.

For details, see "Changing the surround mode parameters" on page 40.

# Input source selection and surround setup

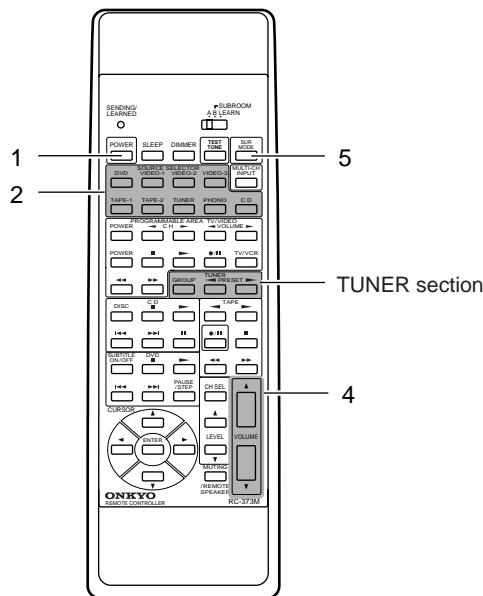

## Using the remote controller

You can use the remote controller to select an input source and set up the surround mode for playback.

### 1. Press the POWER button.

The STAND-BY indicator on the front panel goes out and the display lights up.

#### Note:

If the SPEAKER MAIN indicator is not lit on the display, press the SPEAKERS MAIN button on the unit's front panel to make it appear on the display.

### 2. Select the desired input source using the SOURCE SELECTOR buttons.

| SOURCE SELECTOR button | Selected input source                     |
|------------------------|---|
| DVD                    | DVD player                                |
| VIDEO-1                | Video Cassette Recorder                   |
| VIDEO-2                | Video Cassette Recorder, TV               |
| VIDEO-3                | Video camera                              |
| TAPE-1                 | MD recorder, DAT deck, cassette tape deck |
| TAPE-2                 | Cassette tape deck                        |
| TUNER                  | Built-in tuner                            |
| PHONO                  | Turntable                                 |
| CD                     | CD player                                 |

### If the selected input source is connected to one of the DIGITAL INPUT connectors of the TX-DS656...

For details, "Selecting the digital/analog audio input" on page 30.

### 3. Start playing the selected input source.

#### If you have selected "TUNER" in step 2...

Select the group and preset No. using the GROUP and PRESET ◀/▶ buttons in the TUNER area of the remote controller, respectively. For details, see "Tuning in a broadcasting station" on page 32.

Note that you cannot select stations which have not been preset.

### 4. Adjust the sound volume using the VOLUME ▲ or ▼ button.

The current sound volume is shown on the front panel display while adjustment is in progress.

#### If no sound is output...

Check if "TAPE-2 MONITOR" is shown on the display. If it is lit, the TAPE-2 function is enabled and sound is not output when an input source other than "TAPE-2" is selected. In this case, press the TAPE-2 button to clear the "TAPE-2 MONITOR" display. For details, see "Using the TAPE-2 MONITOR function" on page 44.

### 5. Press the SUR MODE button repeatedly to select the desired surround mode.

To have stereo sound output, set the Surround Mode item to "STEREO".

The surround mode once set will be recalled automatically every time the same input source is selected. (The previously set surround parameters will also be recalled.) For details, see "Selecting a surround mode" on page 39.

# Input source selection and surround setup

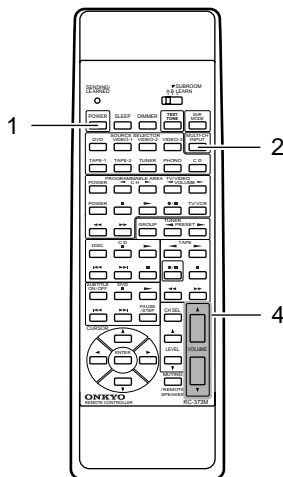
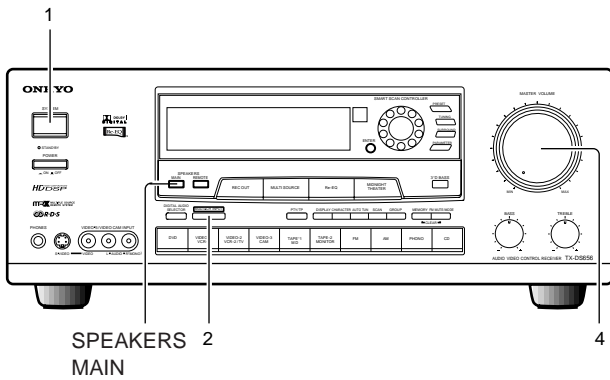

## Playing the input source connected to the MULTI CHANNEL INPUT connector

### Using the front panel or the remote controller:

1. Press the **POWER (or SYSTEM)** button.  
The **STAND-BY** indicator on the front panel goes out and the display lights up.  
**Note:**  
If the **SPEAKERS MAIN** indicator is not lit on the display, press the **SPEAKERS MAIN** button on the unit's front panel to make it appear on the display.
2. Press the **MULTI-CH INPUT** button.  
The video input source you selected most recently is automatically selected.
3. Start playing the input source connected to the **MULTI CHANNEL INPUT** connector.
4. Adjust the sound volume using the **MASTER VOLUME** control knob on the front panel.  
Turn the knob clockwise to increase the sound volume; turn it counterclockwise to decrease the sound volume.  
You can adjust the sound volume using the **VOLUME ▲** or **▼** button on the remote controller.

### If you press the **TAPE-2 MONITOR** button...

The video source currently set is automatically selected.

**a**

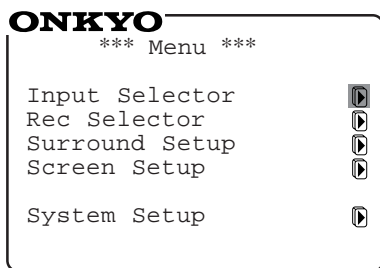

**b**

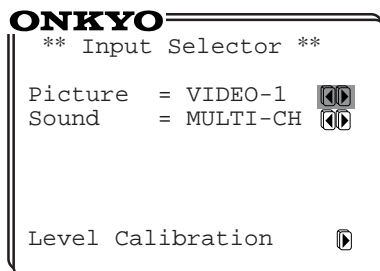

**c**

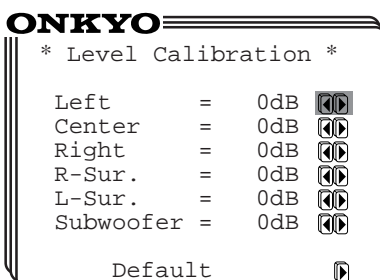

### Using the on-screen Menu:

1. Press the **ENTER** button.  
The Menu appears on the TV screen. (a)
2. Select "**Input Selector**" using the **▲** or **▼** cursor button and then press the **▶** cursor button to display the **Input Selector** screen.
3. Select the input source(s) using the **▲** or **▼** and **◀** or **▶** cursor buttons. (b)  
The input sources you can select are same as those you can select by using the input selector buttons on the front panel.  
"Picture" Select from DVD, VIDEO-1, VIDEO-2, and VIDEO-3.  
"Sound" Select MULTI-CH.
4. Start playing the selected input source.
5. Select "**Level Calibration**" using the **▼** cursor button and then press the **▶** cursor button to display the **Level Calibration** screen.
6. While monitoring the sound, select the speaker type using the **▲** or **▼** cursor button and then adjust the output level using the **◀** or **▶** cursor button. (c)  
The adjustment range is -12 dB to +12 dB (-30 dB to +12 dB for Subwoofer).
7. To adjust the output levels of all speaker types simultaneously, use the **VOLUME ▲** or **▼** button.

### To reset the default output level for all speakers...

First, display the screen used in step 6 of "Using the on-screen Menu" above.

1. Select "**Default**" using the **▼** cursor button and then press the **▶** cursor button. On the screen displayed **YES** (Y) **NO**, select "**YES**" (Reset) or "**NO**" (NOT reset).
2. Press the **◀** cursor button to reset the speaker levels.  
The levels of all the speakers have been reset to 0 dB.
3. Press the **ENTER** button.

# Input source selection and surround setup

## Selecting the digital/analog audio input

You can select the DIGITAL INPUT connector to which the digital audio input source is connected using the on-screen display or the front panel switches. The setting will be recalled automatically every time the same digital audio input source is selected.

### Example of digital audio input connector (DIGITAL INPUT) setting

If your input source components have been connected to the three digital audio input connectors as shown below, for example, select the digital audio input connector by the connector number.

| Connected input source (Ex.) | DIGITAL INPUT connector used | Setting |
|------------------------------|------------------------------|---------|
| DVD player                   | DIGITAL-1 (OPTICAL)          | 1       |
| CD player                    | DIGITAL-2 (COAXIAL)          | 2       |
| Video disc player            | DIGITAL-3 (COAXIAL)          | 3       |
| Analog input source          |                              | ANALOG  |

#### Note:

- Before performing the following procedure, carefully check the DIGITAL INPUT connector to which the input source is connected. An improper setting causes no sound or sound output from a wrong input source.
- Pressing the DIGITAL AUDIO SELECTOR button to select a digital audio input channel when no digital audio input source is connected may cause the DOLBY DIGITAL indicator to appear on the display. This occurs when the TX-DS656's built-in microprocessor cannot set the correct surround mode after investigating the connected digital input source and is not a failure.

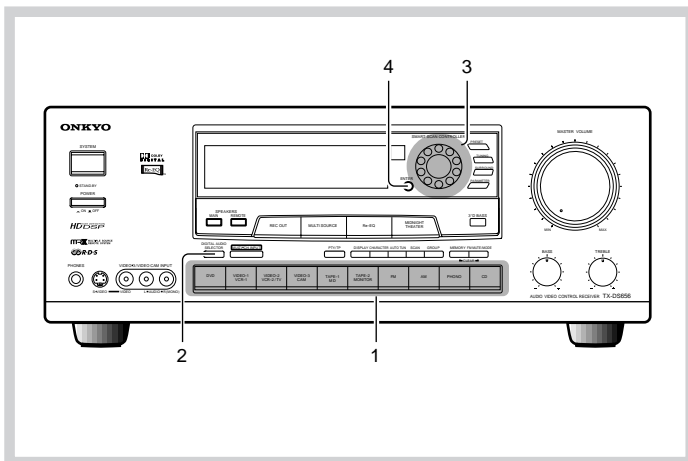

### Using the front panel

1. **Select the digital audio input source using the input selector buttons.**  
The selected digital audio input source is shown on the display.

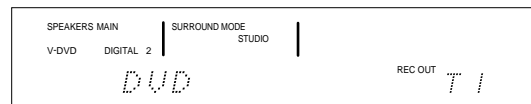

#### Note:

Do not select the FM, AM VIDEO-3 CAM, PHONO, MULTI-CH INPUT or TAPE-2 input source. Otherwise, you cannot perform the following setting.

2. **Press the DIGITAL AUDIO SELECTOR button.**  
The currently selected digital audio input channel is shown.
3. **Select the digital audio input channel using the SMART SCAN CONTROLLER.**  
The digital audio input channel shown on the display changes in the following sequence:  
ANALOG → Digital 1 OPT → Digital 2 CXL → Digital 3 CXL → (Returns to ANALOG)
4. **Press the ENTER button to confirm the setting.**  
You are taken out of the digital audio setting mode if a button or control other than the ENTER button has been operated or a certain time has elapsed. If so, repeat the entire procedure starting from step 1.

### Using the on-screen Menu

In the following procedure, use the remote controller unless otherwise specified.

1. **Press the ENTER button.**  
The Menu appears on the TV screen.
2. **Select "Input Selector" using the ▲ or ▼ cursor button, then press the ► cursor button.**  
The Input Selector screen appears. (a)
3. **Select "Input Mode" using the ▲ or ▼ cursor button and then press the ► cursor button to display the Digital Selector screen. (b)**
4. **Select the desired digital audio input channel using the ▲ or ▼ button, then press the ► cursor button to confirm the setting.**
5. **Press the ENTER button.**

#### Note:

- If the input source for which you have conducted the above digital audio input setting is not connected to the correct DIGITAL INPUT connector, sound from the input source will not be output.
- If you set a digital audio input mode for an input source which is also connected to the VIDEO-2 input connector, the IPM feature (power interlocking with TV) is automatically disabled.

a

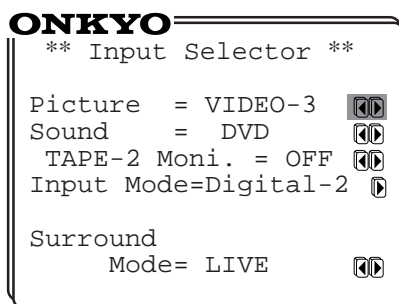

b

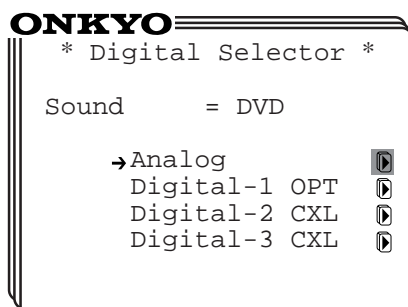

# Input source selection and surround setup

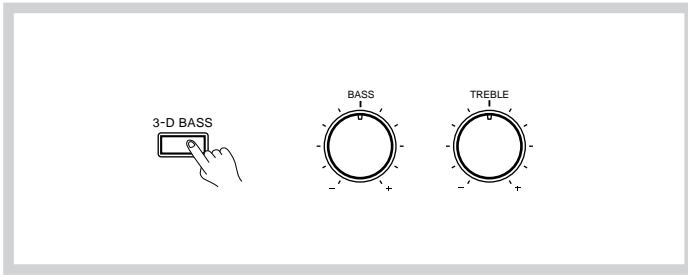

## Useful functions for playback

### Adjusting the tone

The BASS and TREBLE controls only affect the Left and Right front speakers; the 3-D BASS control affects the Left/Right front speakers plus the Center speaker.

**BASS:** Adjust to strengthen or weaken bass response.

**TREBLE:** Adjust to strengthen or weaken treble response.

**3-D BASS:** Use to enhance reproduction of ultra-low frequencies. When this button is pressed, the "3-DB" indicator lights up in the display.

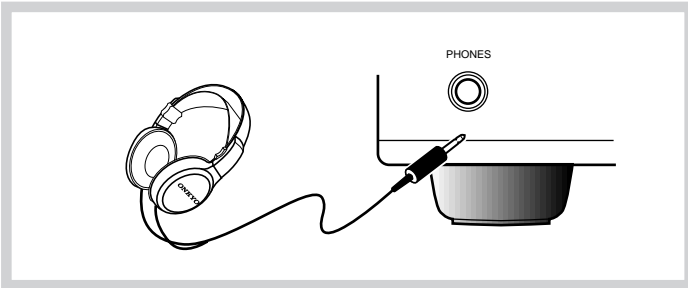

### Using headphones

Headphones with a standard stereo plug can be inserted into the PHONES jack.

Inserting headphones causes the following:

- No sound output from the speakers connected to the FRONT MAIN speaker terminals.
- Automatically sets the "STEREO" mode.
- Sound from only the Left and Right front channels can be heard in the multi-channel input mode.

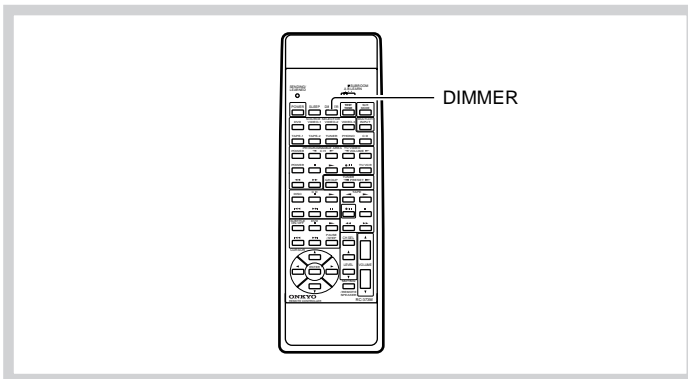

### Changing the brightness of the display

You can make the display dimmer when watching a movie in a darkened room and make it brighter when operating the unit.

**Press the DIMMER button.**

Each time you press this button, the brightness changes in four steps: bright, normal, low, and off.

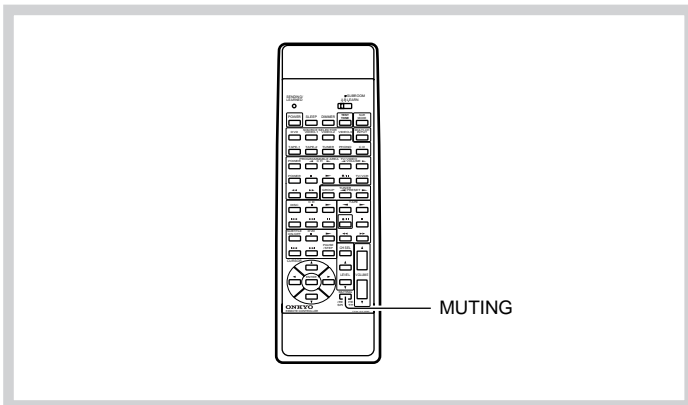

### Using the Muting function

When you receive a phone call, you can disable the audio output to all channels temporarily.

**Press the MUTING button.**

"MUTING" appears on the display and the audio output to the FRONT MAIN, PRE OUT and PHONES channels stop.

To enable the audio output, press the MUTING button again.

**Note:**

- Audio output to the FRONT REMOTE SPEAKERS channel will not be stopped.
- The Muting function will be canceled automatically if the unit's power switch is turned off.

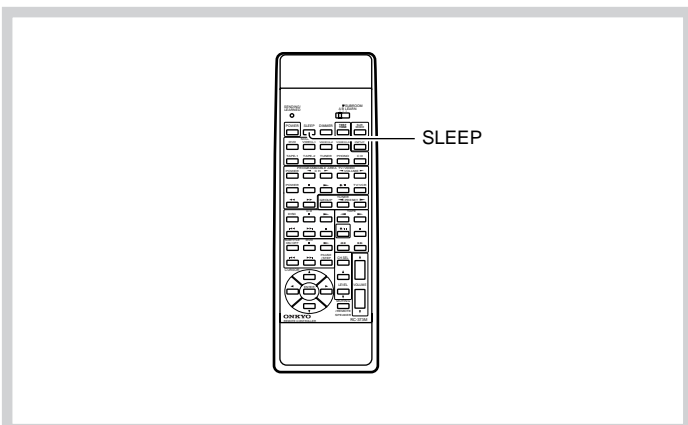

### Falling asleep with music (Sleep function)

You can turn off the power supplied to the TX-DS656 automatically at a specified time.

**Press the SLEEP button.**

The time at which the unit turns off appears on the display.

Each time you press this button, the time decreases by 10 minutes, from the initial time of 90 minutes to 0 (OFF). When the set time has elapsed, the unit automatically turns off.

**To check how much time is left before the unit turns off...**

Press the SLEEP button when the Sleep function is enabled.

Pressing the button repeatedly, however, changes the set time.

**Note:**

Pressing the SLEEP button when the Sleep time display is 10 minutes or less cancels the Sleep function.

# Listening to FM/AM broadcasts

## Tuning in a broadcasting station

You can use one of the following two methods to listen to FM/AM broadcasts with the TX-DS656's built-in tuner.

- Tune in a broadcasting station
  - Tune in an FM/AM station by specifying the frequency (Manual tuning)
  - Automatically tune in an FM station (Auto tuning)
- Recall a preset broadcasting station  
You can name preset stations so that you can easily find the desired station.

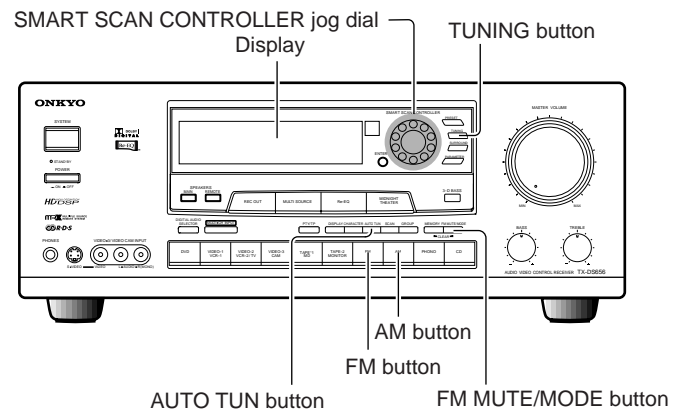

3

SMART SCAN CONTROLLER

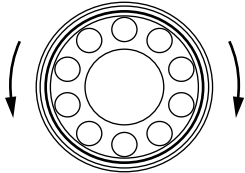

FM 88.1 MHz

AM 1260 kHz

4

SMART SCAN CONTROLLER

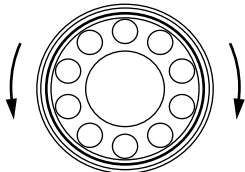

## Tuning in an FM/AM station by specifying the frequency (Manual tuning)

In the following procedure, use the front panel buttons.

1. Press the FM or AM button.
2. Press the TUNING button.  
"Tuning" appears on the display.
3. Rotate the SMART SCAN CONTROLLER clockwise or counterclockwise to select the frequency of your desired station. The selected frequency is shown on the display. The TUNED indicator lights up on the display when the station is properly tuned in.
  - The frequency is changed in 100 kHz steps in FM and 9 kHz steps in AM.

## Automatically tuning in an FM station (Auto tuning)

In the following procedure, use the front panel buttons.

1. Press the FM button.
2. Press the AUTO TUN button.  
The AUTO indicator lights up on the display.
3. Press the TUNING button.  
"Tuning" is displayed.
4. Rotate the SMART SCAN CONTROLLER clockwise or counterclockwise.  
The selected frequency is shown on the display. Rotating the SMART SCAN CONTROLLER clockwise (or counterclockwise) causes scanning of stations toward the higher (or lower) frequencies. When a broadcast is tuned in, scanning stops and the TUNED indicator lights up. Follow the same procedure to tune in the next station.

## If auto tuning of an FM station is not possible

When you tune in a stereo FM station, the STEREO indicator lights up if the signal is sufficiently strong. If the signal is weak, your desired station may not tune in. In this case, try the following to receive the signal in the mono mode:

**First, press the FM MUTE/MODE button.**

The broadcast is heard in mono.

Next, tune in the station you want to listen to.

The station is now tuned in with reduced interference noise and fewer sound dropouts.

### Note:

If you turn off the FM MUTE indicator, interference noise will be heard when you switch from one station to another.

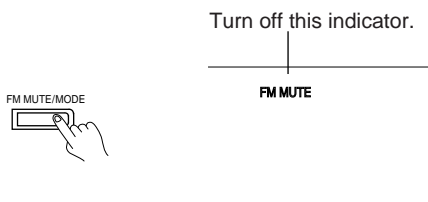



# Listening to FM/AM broadcasts

## Recalling a preset broadcasting station

If you preset favorite broadcasting stations, you will be able to select them by using the on-screen Menu and/or the remote controller. You can preset a total of 30 FM and AM stations in three groups. Each of the groups (A, B, and C) can store up to 10 stations.

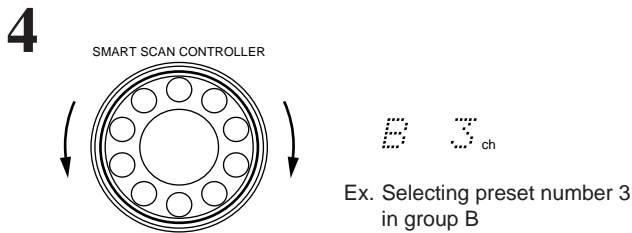
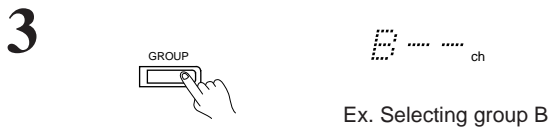
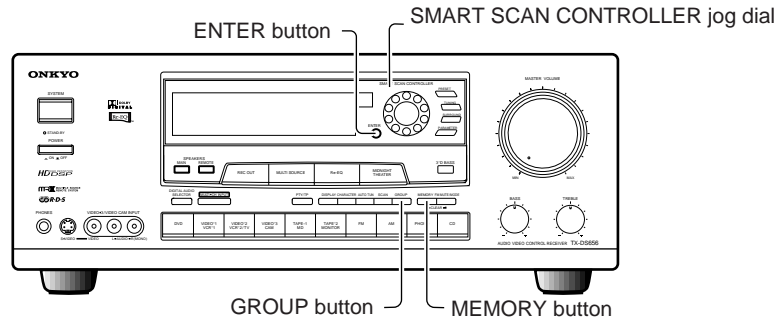

## Presetting a station

1. **Tune in a desired broadcasting station.**  
(See "Tuning in a broadcasting station" on page 32.)
2. **Press the MEMORY button.**  
The MEMORY indicator lights up on the display for 8 seconds.
3. **While the MEMORY indicator is lit, press the GROUP button repeatedly until the desired group is selected.**  
Each time the button is pressed, the group name on the display changes in the following order:  
A → B → C → A
- Note:**  
You will be taken out of the presetting mode if you do not select a group while the MEMORY indicator is lit (for 8 seconds).
4. **Rotate the SMART SCAN CONTROLLER to select the desired preset number.**  
Select a desired preset number between 1 and 10.
5. **Press the ENTER button.**  
The tuned-in station has been preset in the selected group with the selected preset number.

## Canceling a preset station

1. **Select the station you want to cancel.**  
Refer to "Recalling a preset station" on page 34.
2. **While holding down the MEMORY button, press the FM MUTE/MODE button.**

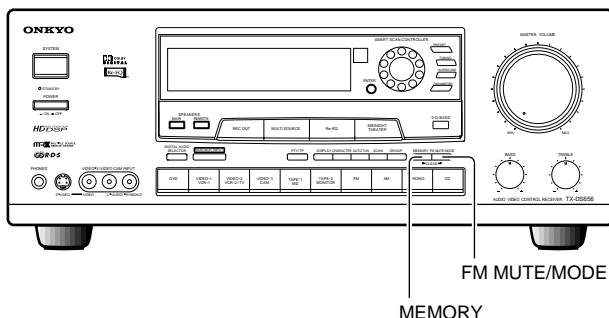
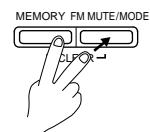

# Listening to FM/AM broadcasts

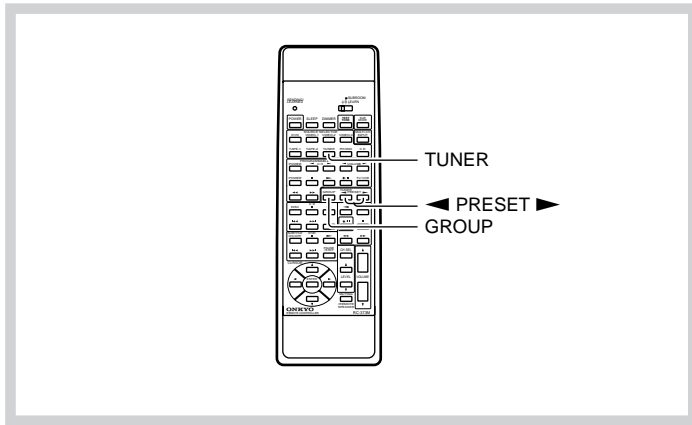

## Recalling a preset station

Using the remote controller:

1. Press the **TUNER** button in the **SOURCE SELECTOR** area.
2. Press the **TUNER GROUP** button repeatedly until the desired group is displayed.
3. Press the **PRESET** ◀ or ▶ button.

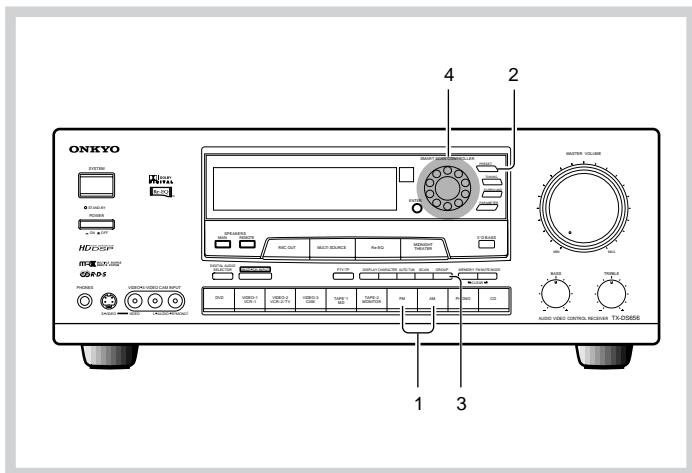

Using the receiver:

1. Press the **FM** or **AM** button.
2. Press the **PRESET** button.  
"Preset" is displayed.
3. Press the **GROUP** button repeatedly until the desired group is displayed.
4. Select the desired preset number using the **SMART SCAN CONTROLLER**.

Selecting a preset number with the **SCAN** button...

By pressing the **SCAN** button, each station in the group selected in step 3 is displayed for about 5 seconds.

When the desired station is displayed, press the **SCAN** button again.

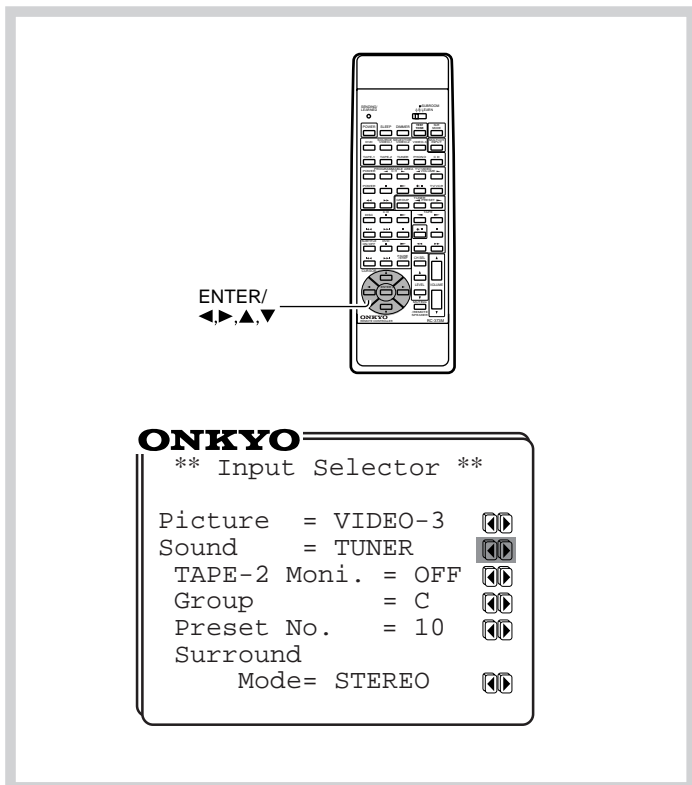

Using the on-screen Menu:

1. Press the **ENTER** button.  
The Menu appears on the TV screen.
2. Select "**Input Selector**" using the ▲ or ▼ cursor button, then press the ▶ cursor button.  
The Input Selector screen appears.
3. Select "**Sound**" using the ▼ button and then select "**TUNER**" using the ◀ or ▶ cursor button.
4. Select "**Group**" using the ▼ button and then select the desired group using the ◀ or ▶ cursor button.
5. Select "**Preset No.**" using the ▼ button and then select the desired preset station using the ◀ or ▶ cursor button.
  - You cannot select any group and preset number if no broadcasting station is preset in memory.

# Listening to FM/AM broadcasts

## Entering a station name

Characters which can be entered:

A B C D E F G H I J K L M N O P Q R S T U  
 V W X Y Z " & , ( ) \* + , - . / = ? [ \ ] | 0 1 2  
 3 4 5 6 7 8 9 \_

**Note:** \_ indicates a space.

### Note for European models:

If you attempt to enter characters for an FM station broadcasting RDS information, "RDS...PS" is displayed and characters cannot be entered.

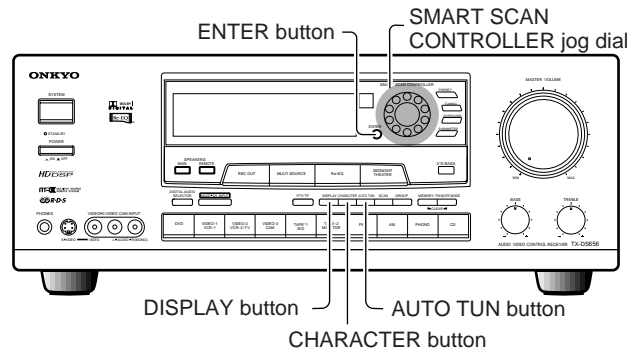

For each preset station, you can enter a name consisting of up to eight alphanumeric characters. This is useful because you can easily note which station you are listening to by the station name on the display. If a preset station is not given a name, it will be indicated by its tuned-in frequency.

### Entering characters

- Recall a desired preset station.**  
Refer to "Recalling a preset station" on page 34.
  - Press the CHARACTER button.**  
The frequency indication disappears and the cursor ( \_ ) flashes.
- Note:**  
You will be taken out of the mode (the frequency indication will reappear) if you do not rotate the SMART SCAN CONTROLLER within 16 seconds.
- Rotate the SMART SCAN CONTROLLER clockwise or counterclockwise until the first character of the name you wish to enter appears on the display.**
  - Press the ENTER button to enter the first character.**  
The cursor moves to the next position.
- To cancel the last character entered...**  
Press the AUTO TUN button. The character at the cursor position, or to the left of the cursor (if no character is shown at the cursor position), is erased. You can erase the characters continuously by pressing the AUTO TUN button repeatedly.
- Repeat steps 3 and 4 for the second and later characters.**
  - Press the CHARACTER button once again to store the entered characters.**

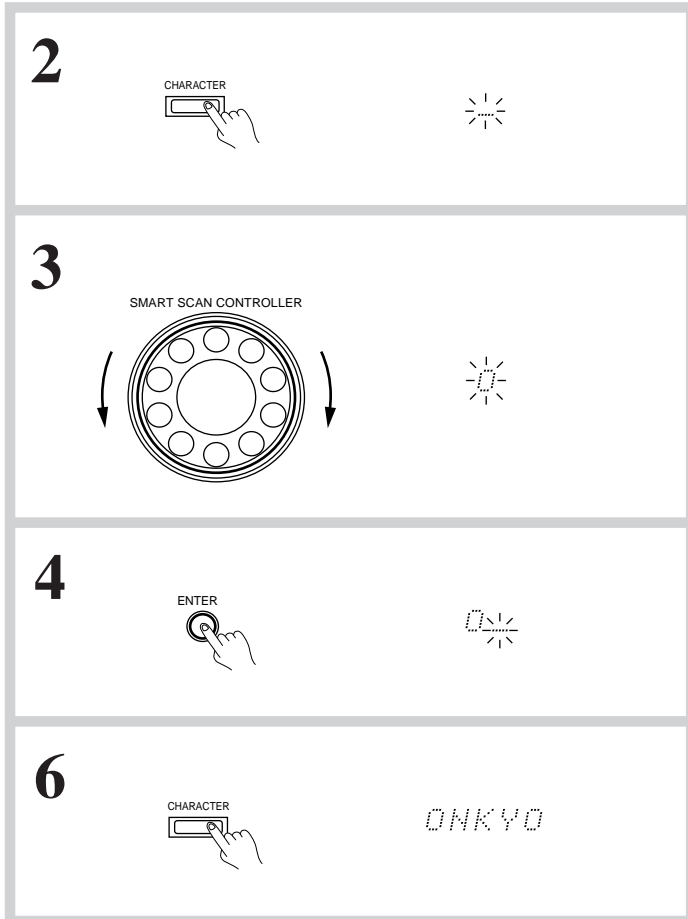

### Switching between the frequency and name indication

Press the DISPLAY button.

Each time you press this button, the frequency and the name appear alternately.

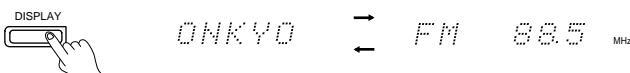

**Note:**

If the station has no name, the frequency will reappear 0.5 second after your attempt to switch to the name indication.

- While holding down the MEMORY button, press the FM MUTE/MODE button to erase the station name.**  
The station name disappears and in 16 seconds the frequency indication appears.

**To switch to the frequency indication immediately...**

Press the CHARACTER button.

### Changing an entered station name

### Erasing a station name

- Recall the station whose name you wish to erase.**  
Refer to the "Recalling a preset station" on page 34.
- Press the CHARACTER button.**  
The frequency indication disappears and the cursor ( \_ ) flashes.

- Tune in the station whose name you wish to change.**  
Refer to "Recalling a preset station" on page 34.
- Press the CHARACTER button.**
- Press the AUTO TUN button to erase the characters that you want to change.**
- Follow steps 3 and 4 of "Entering a station name" to enter new characters.**
- Press the CHARACTER button to store the changes.**

# Receiving RDS broadcasts (European models only)

RDS reception is available only on the European model, and only in areas where RDS broadcasts are available.

## What is RDS?

Many FM radio stations now transmit RDS signals which give additional information. RDS provides you with various services so that, for example, you can choose a station broadcasting your favorite categories of music or other information. (Refer to the right column for information details.)

## PS: Program Service Name

When an RDS station broadcasting PS information is selected, the station's name is displayed instead of the frequency.

## PTY: Program Type

When an RDS station broadcasting PTY information is selected, the station type (classification) is displayed.

## TP: Traffic Program

When an RDS station broadcasting TP information is selected, the traffic information is displayed.

## RT: Radio Text

When an RDS station broadcasting RT information is selected, the information received from the station is displayed.

## NOTE:

In some cases, the characters displayed on the TX-DS656's display may not be exactly the same as the ones broadcast by the radio station.

Unusual characters may appear on the display if the TX-DS656 receives characters that cannot be displayed correctly. This is not a malfunction.

## PTY Classifications in Europe

|          |                          |  |
|----------|--------------------------|--|
| NONE     | None                     | No program type  |
| NEWS     | News reports             | Reports on current events and happenings   |
| AFFAIRS  | Current affairs          | Topical reporting of current affairs, often with a wider range of topics than news reports           |
| INFO     | Information              | General information such as weather forecasts, consumer affairs, medical help etc.                   |
| SPORT    | Sport                    | Live sports action, sports news, and interviews  |
| EDUCATE  | Education                | Formal educational programs  |
| DRAMA    | Drama                    | Radio plays and serials  |
| CULTURE  | Culture                  | Cultural programs (including religious affairs)  |
| SCIENCE  | Science and technology   | Programs about the natural sciences and technology   |
| VARIED   | Varied                   | Speech-based programs not covered by the above categories (e.g., quizzes, panel games, comedy, etc.) |
| POP M    | Pop music                | Popular commercial music, usually from past or present sales charts (e.g., Top 40)                   |
| ROCK M   | Rock music               | Popular music with an alternative appeal, often not appearing on sales charts.                       |
| M.O.R. M | Middle of the road music | Easy listening music (as opposed to Pop, Rock or Classical)  |
| LIGHT M  | Light classics           | Classical music for general rather than specialist appreciation                                      |
| CLASSICS | Serious classics         | Performances of major orchestral works, symphonies, chamber music etc., including Grand Opera        |
| OTHER M  | Other music              | Music styles not covered by the above categories, e.g. Jazz (Rhythm & Blues, Folk, Country, Reggae)  |
| ALARM    | Alarm                    | When an RDS station is making an emergency broadcast, this PTY classification flashes on the display |

# Receiving RDS broadcasts (European models only)

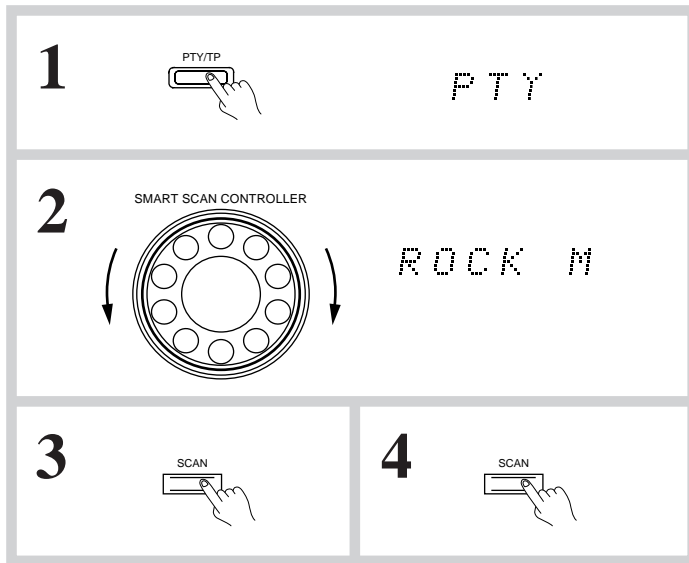
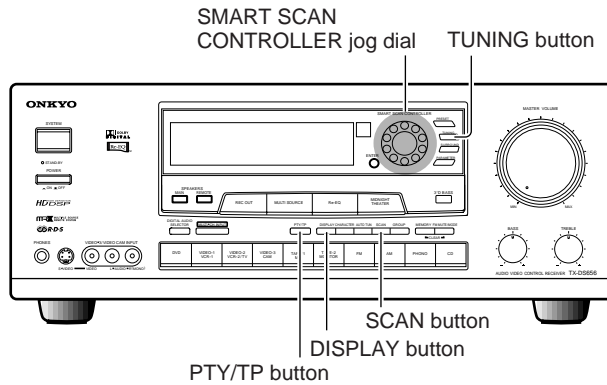

## Searching for a station of your favorite program type (PTY scan)

1. Press the PTY/TP button repeatedly until "PTY" appears on the display.
2. Rotate the SMART SCAN CONTROLLER clockwise or counterclockwise to select the program type (PTY), for example "ROCK M".  
Refer to the explanation on PTY on the previous page.
3. Press the SCAN button to start searching for stations of the desired program type.  
When a station of the desired program type is received, scanning stops for approximately 5 seconds, then resumes.
4. When the desired station is found, press the SCAN button again to stop scanning.

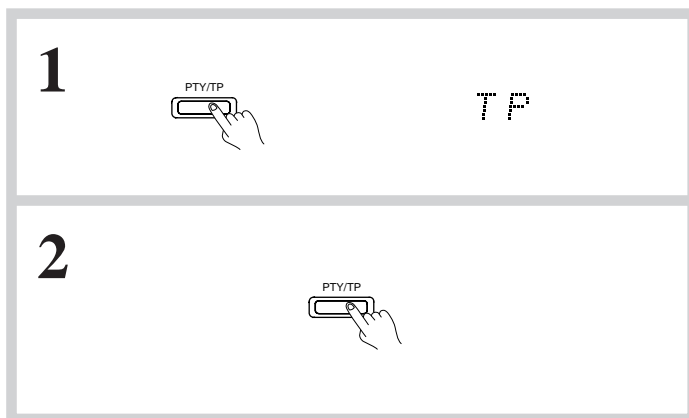

## Searching for traffic information (TP scan)

1. Press the PTY/TP button repeatedly until "TP" appears on the display.
2. Press the SCAN button to start searching for other TP stations.  
When a station broadcasting traffic information is found, scanning stops. If "Not find" appears on the display, a TP station cannot be found.

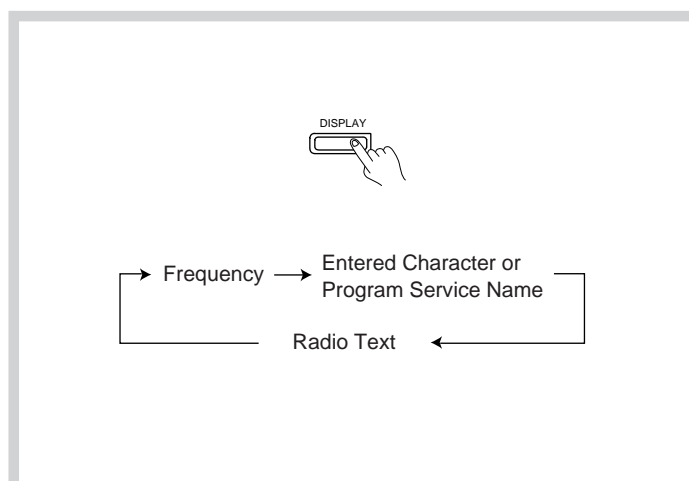

## Displaying Radio Text (RT)

If the selected station is not broadcasting RDS signals, this function cannot be used.

Each time you press the DISPLAY button, the displayed RDS information changes as shown on the left.

- If the current station you are listening to is not an RDS station, only the frequency or the entered characters appear. If no characters have been entered, only the frequency is displayed. (Refer to "Entering characters" on page 35 for more details.)
- When RT signals are received, it takes about 15 seconds for the Radio Text to appear on the display.
- If "WAIT" appears on the display, more time is required to receive the RT information. When the information is received, the characters scroll across the display.
- If "NO TEXT" appears on the display for 3 seconds, RT information is not available.

# Using the Surround modes

The TX-DS656 provides a variety of surround effects, enabling you to enjoy the feeling of a movie theater, concert hall or studio in your room.

To get optimized surround sounds, your speaker system plays an important role. For how to connect and setup speakers, see "Connecting speakers" (on page 15) and "Speaker system setup" (on page 21).

## DSP (Digital Signal Processor)

The DSP converts the musical signal into digital form and produces reflected sound from the digital signal. This is applied to the musical signal to yield an effect approaching that of a live performance.

Note:

The concert hall effect is produced from the reflections and reverberations contained in the original recording. These are converted into reflected sound that is reproduced from four directions. Thus, in some cases an unnatural impression can be conveyed if there are too few reflections in the recording or if the effects in the original recording were produced artificially.

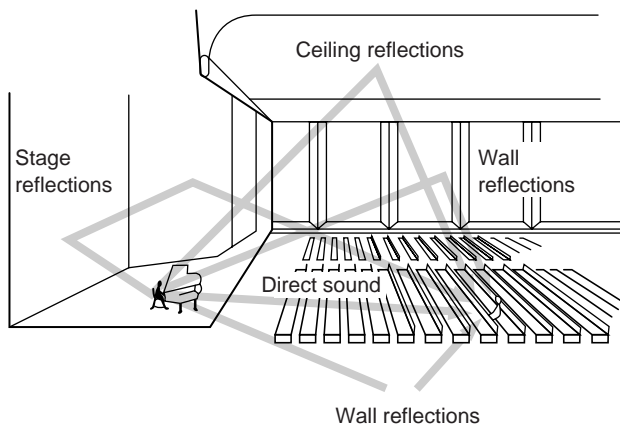

## Surround modes

The TX-DS656 features the following Surround modes:

### DOLBY DIGITAL

Use this mode to playback sources bearing  logo, such as DVD software.

To enjoy Dolby Digital playback, you need to connect your source equipment to the one of the DIGITAL INPUT connectors or the MULTI CHANNEL INPUT connector of the TX-DS656. If connection is made properly, the Dolby Digital surround mode will be set automatically.

Dolby Digital is a new-generation digital audio format for multi-channel surround audio.

Adding to conventional five full range channels, Dolby Digital supports one LFE (Low Frequency Effects) channel, which is used solely for correcting the bass range by using an independent subwoofer. Dolby Digital is sometimes referred to as 5.1-channel format since this LFE channel is calculated as 0.1.

During Dolby Digital playback, the following functions are available:

- **Cinema Re-Equalization (Cinema Re-EQ) function**   
Re-Equalization takes the edginess or "brightness" out of your home cinema sound, compensating for the fact that sound mixed for theaters will sound too bright when played back through speakers in the home environment.
- **Midnight Theater function**  
This function is useful for playing at midnight. In the Midnight Theater mode, the dynamic range of sound is narrowed to reproduce natural sounds at low sound volumes.
- **LFE (Low Frequency Effects) function**  
In the LFE mode, the low-frequency range is attenuated by 10 dB to reduce overemphasized bass sound.

### DOLBY PRO LOGIC

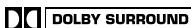
Use this mode to playback sources bearing  logo, such as stereo VHS, VHS-Hi-Fi, laser discs, and DVD video software.

Dolby Pro Logic Surround provides four channels of surround sound (Left/Right front, Center, and monaural Surround channels), with importance placed on the Center speaker.

During Dolby Pro Logic playback, the Cinema Re-Equalization function is available.

### Other surround modes

The TX-DS656 also features other surround modes that Onkyo has designed for playback of sources other than Dolby Surround. These surround modes can be adjusted by setting the proper parameters to create your favorite sound field.

- **HALL Surround**  
This mode is especially suitable for media already having a substantial amount of reverberation such as classical music. The atmosphere of a concert hall can be simulated.
- **LIVE Surround**  
This mode reproduces the feeling of a live performance.
- **ARENA Surround**  
This mode recreates the feel of listening to a pop concert in a domed stadium.
- **STUDIO Surround**  
This mode is perfect for studio recordings that may have few reverberations such as pop or jazz music.

**For speaker systems with a Left/Right front and Center speakers**

- **DOLBY 3 STEREO**  
In this mode, you can hear sound recorded for surround channels from the Left and Right speakers.
- **STEREO**  
You can turn off the Surround function by selecting this mode to enjoy ordinary stereo sound.

# Using the Surround modes

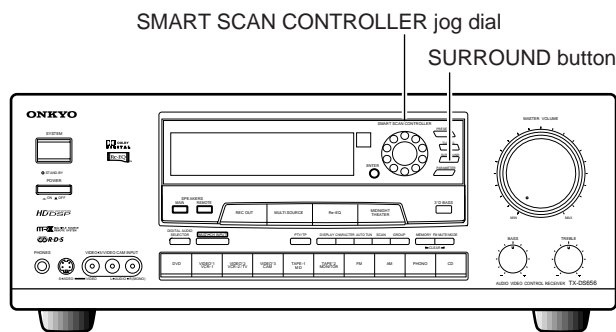
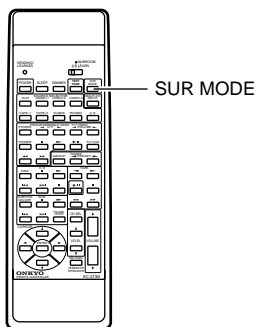
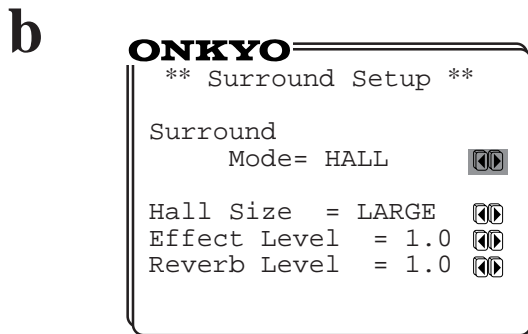
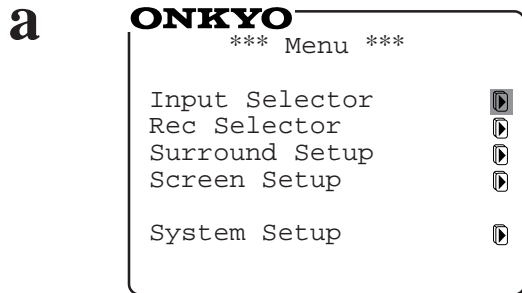

## Selecting a Surround mode

### Using the on-screen Menu

For how to use the on-screen Menu, see "Selecting a Menu item" on page 19.

1. **Press the ENTER button.**  
The Menu appears on the TV screen. (a)
2. **Select "Surround Setup" using the ▲ or ▼ cursor button and then press the ► cursor button to display the Surround Setup screen. (b)**
3. **Select the desired surround mode parameter using the ▲ or ▼ cursor button and enter the setting using the ◀ or ▶ cursor button.**

Use the ▲ or ▼ cursor button to move among the parameters.

### "Surround Mode" setting

Select one of the following: DOLBY DIGITAL, DOLBY PRO LOGIC, HALL, LIVE, ARENA, STUDIO, DOLBY 3 STEREO, STEREO.

### Setting the surround mode parameters

The parameters available for the selected surround mode are shown. Set each parameter by following the same procedure as that for the surround mode setting. For details of surround mode parameters, see "Changing the surround mode parameters" on page 40.

4. **Press the ENTER button.**

### Using the remote controller

Press the SUR MODE button repeatedly to select the desired surround mode. The indicator on the display changes each time you press this button.

- In modes other than DOLBY DIGITAL  
DOLBY PRO LOGIC → HALL → LIVE → ARENA → STUDIO → STEREO → (DOLBY PRO LOGIC)
- In DOLBY DIGITAL mode  
DOLBY DIGITAL ↔ DOLBY DIGITAL STEREO

### Note:

- Even if "STEREO" mode is set, the DOLBY DIGITAL indicator appears as soon as a Dolby Digital encoded signal is input.
- If no surround speakers are connected, the display will show DOLBY 3 STEREO and STEREO every time the SUR MODE button is pressed.

### Using the front panel

Press the SURROUND button and then rotate the SMART SCAN CONTROLLER clockwise or counterclockwise to select the desired surround mode.

The current surround mode is shown on the display.

- \* An indication such as "3/2 ch" appears in the main unit's multi-function display to indicate which of the three front channels and two surround channels are available for sound output.

# Using the Surround modes

## Changing the surround mode parameters

Each surround mode is made up of a number of parameters. These parameters can be changed to optimize the reproduced surround sound according to your room size, listening environment, playback source type, taste, etc. Once parameters are set, they will be recalled automatically every time the same surround mode is selected. The parameters available in each surround mode vary depending on the surround mode.

### Note:

In the STEREO mode, you cannot perform parameter setting.

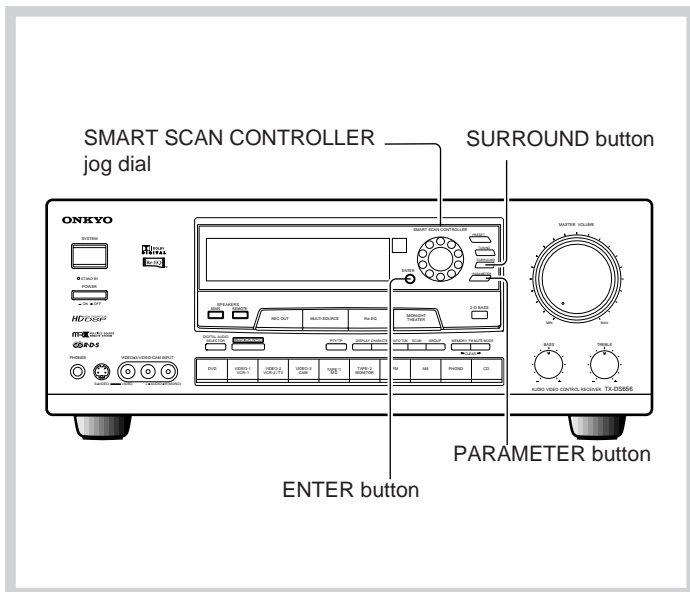
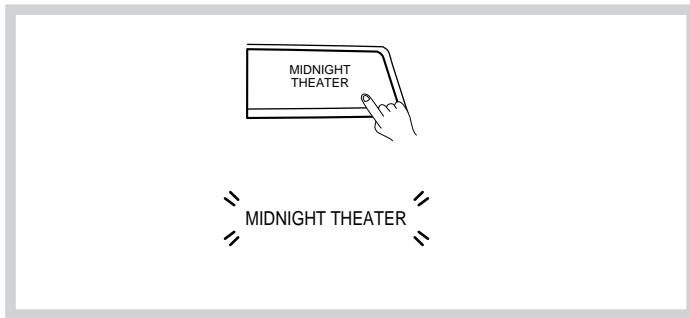
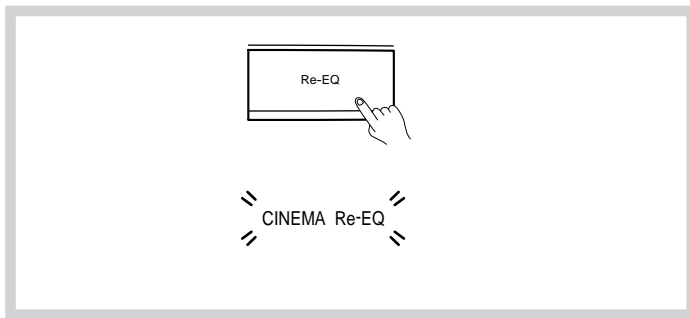
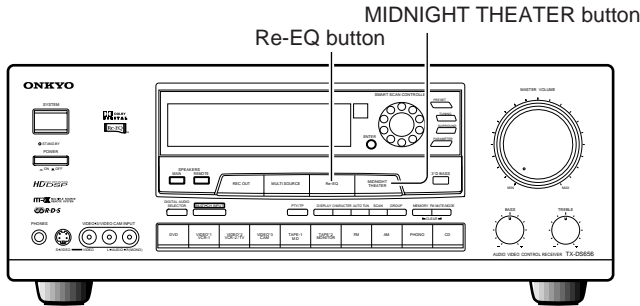

## Surround modes for movies

| Parameter             | DOLBY DIGITAL | DOLBY PRO LOGIC | DOLBY 3 STEREO | MULTI-CH INPUT |
|-----------------------|---------------|-----------------|----------------|----------------|
| Cinema Re-EQ          | ○             | ○               | ○              | ○              |
| Midnight Theater      | ○             | —               | —              | —              |
| LFE LEVEL Attenuation | ○             | —               | —              | —              |

\* The Cinema Re-EQ function is not available in the DOLBY DIGITAL STEREO mode.

## Using the Cinema Re-Equalization (Cinema Re-EQ) function

Re-Equalization takes the edginess or "brightness" out of your home cinema sound, compensating for the fact that sound mixed for theaters will sound too bright when played back through speakers in the home environment.

**Press the Re-EQ button on the unit's front panel.**

The CINEMA Re-EQ indicator appears on the display.

**To cancel the Cinema Re-EQ function...**

Press the Re-EQ button again.

**To use the on-screen Menu...**

See "Using the on-screen Menu" on page 39.

## Using the Midnight Theater function

This function is useful for playing at midnight. In the Midnight Theater mode, the dynamic range of sound is narrowed to reproduce comfortable sounds at low sound volumes (DOLBY DIGITAL mode only).

**Press the MIDNIGHT THEATER button on the unit's front panel.**

The MIDNIGHT THEATER indicator appears on the display.

**To cancel the Midnight Theater function...**

Press the MIDNIGHT THEATER button again.

**To use the on-screen Menu...**

See "Using the on-screen Menu" on page 39.

## Using the LFE (Low Frequency Effects) function

In the LFE mode, the low-frequency range is attenuated by 10 dB to reduce overemphasized bass sound (DOLBY DIGITAL mode only).

In the following procedure, use the front panel buttons.

1. Press the SURROUND button and then rotate the SMART SCAN CONTROLLER to select "DOLBY DIGITAL".
2. Press the PARAMETER button and then rotate the SMART SCAN CONTROLLER counterclockwise to display "Surround Setup".
3. Press the ENTER button to display "LFE Att.".

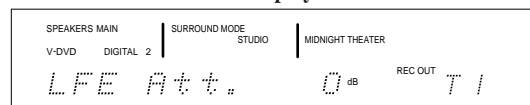

4. Rotate the SMART SCAN CONTROLLER clockwise or counterclockwise to select "-10 dB".

To restore the initial value, select "0 dB".

**To use the on-screen Menu...**

See "Using the on-screen Menu" on page 39.



# Using the Surround modes

## Surround modes for music and sports

| Parameter    | HALL | LIVE | ARENA | STUDIO |
|--------------|------|------|-------|--------|
| Hall Size    | ○    | ○    | ○     | ○      |
| Effect Level | ○    | ○    | ○     | ○      |
| Reverb Level | ○    | ○    | ○     | ○      |

### Selecting the Hall size

In the HALL, LIVE, ARENA, and STUDIO surround modes, you can choose the size of the virtual concert hall or studio from the following three levels: LARGE, MIDDLE, or SMALL (the default setting is MIDDLE). In the following procedure, use the front panel buttons.

1. Press the **SURROUND** button and then rotate the **SMART SCAN CONTROLLER** to select the **HALL, LIVE, ARENA, or STUDIO** surround mode.
2. Press the **PARAMETER** button and then rotate the **SMART SCAN CONTROLLER** counterclockwise to display "Surround Setup".

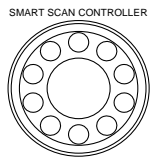

3. Press the **ENTER** button repeatedly to display "Hall Size".

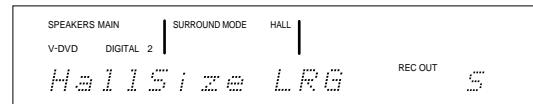

4. Rotate the **SMART SCAN CONTROLLER** clockwise or counter clockwise to select "LRG (large)", "MID (middle)", or "SML (small)".

To use the on-screen Menu...

See "Using the on-screen Menu" on page 39.

### Adjusting the Effect and Reverb levels

In the HALL, LIVE, ARENA, and STUDIO surround modes, you can adjust the levels of reproduced sound reflection and reverberation according to the playback software or listening environment.

In the following procedure, use the front panel buttons.

1. Press the **SURROUND** button and then rotate the **SMART SCAN CONTROLLER** to select the **HALL, LIVE, ARENA, or STUDIO** surround mode.
2. Press the **PARAMETER** button and then rotate the **SMART SCAN CONTROLLER** counterclockwise to display "Surround Setup".

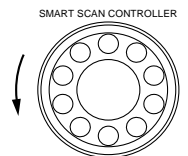

3. Press the **ENTER** button repeatedly to display "Effect" or "Reverb".

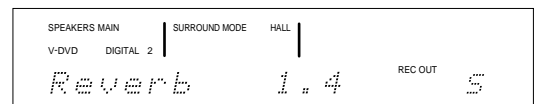

4. Rotate the **SMART SCAN CONTROLLER** clockwise or counter clockwise to adjust the **Effect or Reverb level**. Increase or decrease the value to adjust the Effect or Reverb level (initial value: 1.0).
  - The Effect level can be adjusted within the range of 0.4-1.6 in 0.2 increments.
  - The Reverb level can be adjusted within the range of 0.6-1.4 in 0.4 increments.

To use the on-screen Menu...

See "Using the on-screen Menu" on page 39.

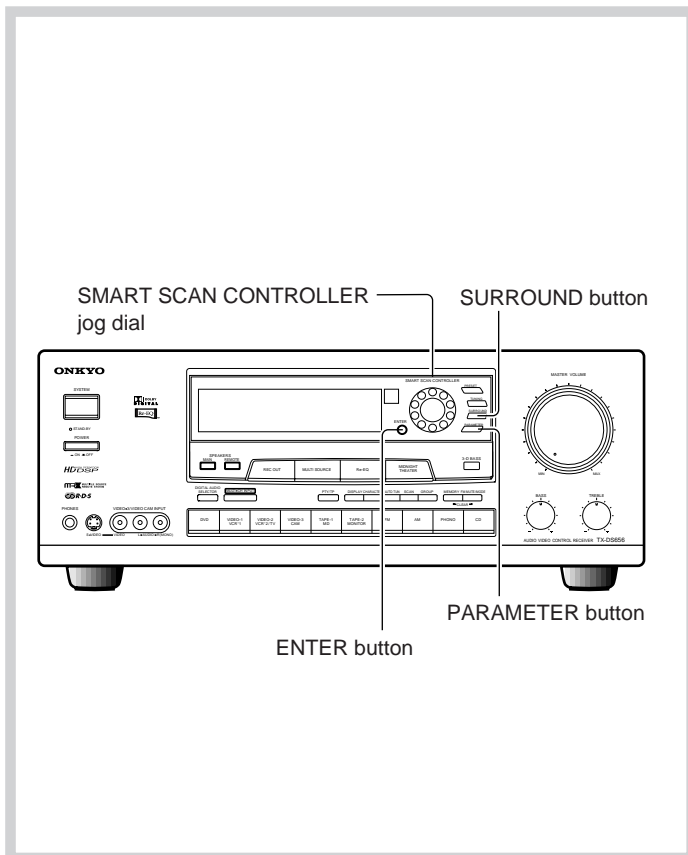
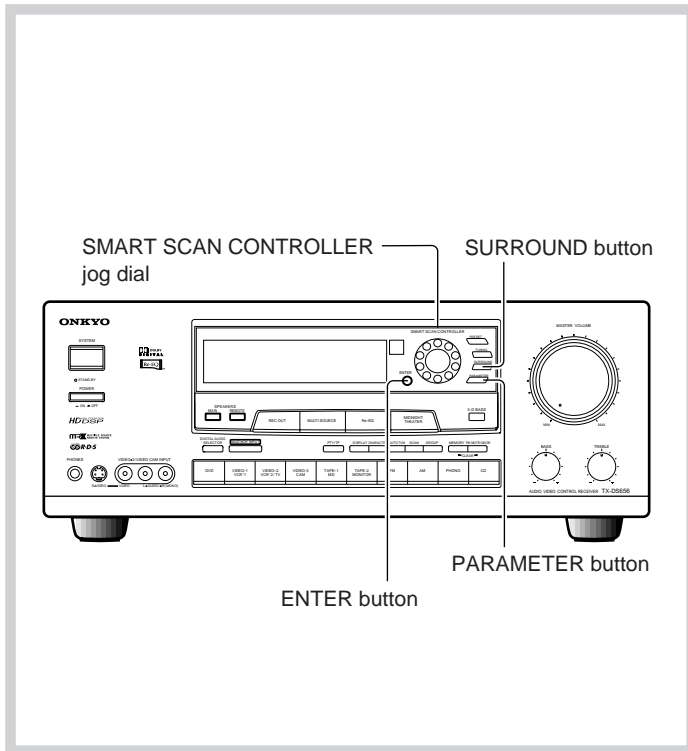

# Recording from a source

- From the TX-DS656's output jacks, playback signals of the selected recording source equipment are continuously output during recording.
- Use the on-screen display or the front panel to select the recording source and recording equipment.
- The recording source, once set, will not change even if you change the input source by using the source selector buttons. Therefore, you can playback from one audio or video source while recording from another recording source.

## Output jacks and connectable recording equipment

| Output jack                | Audio | Video | S-Video               | Recording equipment                       |
|----------------------------|-------|-------|-----------------------|---|
| TAPE-1 (REC)               | L/R   | -     | -                     | MD recorder, DAT deck, cassette tape deck |
| TAPE-2 (REC)* <sup>1</sup> | L/R   | -     | -                     | Cassette tape deck* <sup>2</sup>          |
| VIDEO-1 OUT                | L/R   | Video | S-Video* <sup>3</sup> | Video cassette deck                       |
| VIDEO-2 OUT                | L/R   | Video | S-Video* <sup>3</sup> | Video cassette deck                       |

- \*<sup>1</sup> From the TAPE-2 (REC) jacks, playback signals of the source you selected using the source selector buttons are continuously output during recording. Therefore, you cannot playback different audio or video sources while recording a source using these jacks.
- \*<sup>2</sup> If you have a 3-head cassette tape deck, connect it to the TAPE-2 (REC) jacks. This allows you to monitor the sound being recorded (TAPE2 Monitor function).
- \*<sup>3</sup> The TX-DS656 will not output S-video signals if its S-video IN connector is not connected to the S-video output of the source equipment, even if its S-video OUT connector is connected to the S-video input of the source.

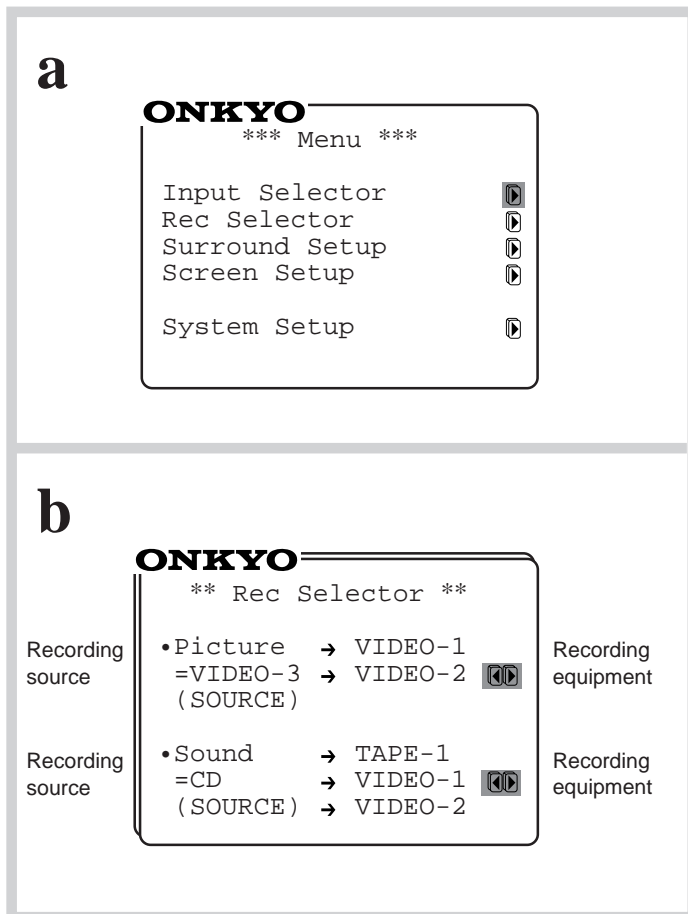

## Recording from an audio/video source

### Using the on-screen Menu

If your TX-DS656 is connected to a TV set, you can perform settings on the TV screen. For further information about using the on-screen Menu, see "Selecting a Menu item" on page 19.

In the following procedure, use the remote controller unless otherwise specified.

- 1. Press the ENTER button.**  
The Menu appears on the TV screen. **(a)**
- 2. Select "Rec Selector" using the ▲ or ▼ cursor button, then press the ► cursor button.**  
The Rec Selector screen appears. **(b)**
- 3. Select the desired item(s) using the ▲ or ▼ button.**  
The item (or items) you select changes each time you press the ▲ or ▼ button.  
"Picture" only (for recording only pictures)  
"Picture" and "Sound" (for recording both pictures and sound)  
"Sound" only (for recording sound only)
- 4. Select the recording source(s) using the ◀ or ▶ cursor button.**
- 5. Press the ENTER button.**
- 6. Start recording on the recording equipment, then start playing the selected recording source.**

### To set the source selected using the source selector buttons as the recording source...

Select the equipment under which "(SOURCE)" is shown for "Picture" and/or "Sound".

# Recording from a source

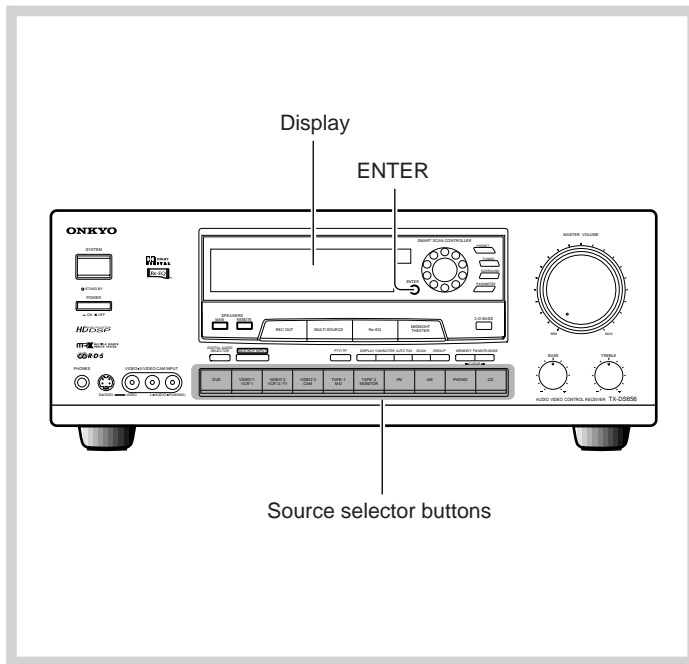

## Using the front panel

1. Press the REC OUT button.

The REC OUT indicator flashes for 8 seconds.

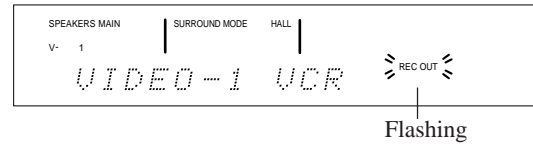

2. While the REC OUT indicator is flashing, select the recording source using the source selector buttons.

The REC OUT indicator and the selected recording source name flash.

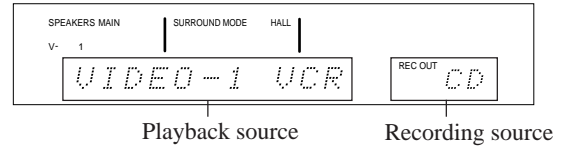

| Indication | Video recording source | Indication | Audio recording source |
|------------|------------------------|------------|------------------------|
| D          | DVD                    | CD         | CD                     |
| V1         | VIDEO-1                | T1         | TAPE-1                 |
| V2         | VIDEO-2                | T2         | TAPE-2                 |
| V3         | VIDEO-3                | TU         | FM or AM               |
|            |                        | PH         | PHONO                  |

3. Start recording on the recording equipment, then start playing the selected source.

Now the recording source will not change even if you change the input source by using the source selector buttons.

## To set the source selected as the recording source using the source selector buttons...

In step 1, press the REC OUT button again while the REC OUT indicator is flashing.

### Adding sound to video camera images

You can add music from CDs or other source to video images from a video camera. The following explanation assumes that you are adding sound from a CD player to images from a video camera connected to the VIDEO-3/VIDEO CAM INPUT connectors.

In the following procedure, use the remote controller unless otherwise specified.

1. Connect a video camera to the VIDEO 3/VIDEO CAM INPUT connector.
2. Press the ENTER button.  
The Menu appears on the TV screen.
3. Select "Input Selector" using the ▲ or ▼ cursor button, then press the ► cursor button.  
The Input Selector screen appears.
4. Select "Picture" using the ▲ or ▼ button and then select "VIDEO-3" using the ◀ or ▶ cursor button.
5. Select "Sound" using the ▲ or ▼ button and then select "CD" using the ◀ or ▶ cursor button. (a)
6. Press the ENTER button.
7. Start recording on the video cassette recorder, then start playback on the CD player and the video camera.

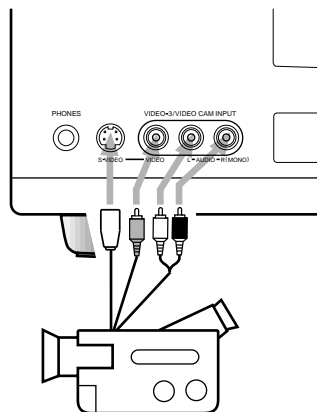

Video camera/TV game machine

a

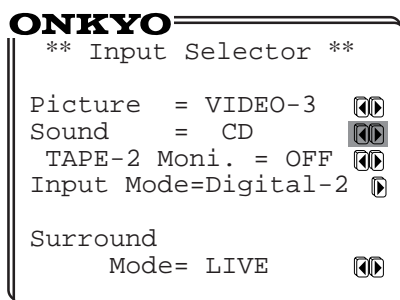

# Using the TAPE-2 MONITOR function

## Playing equipment connected to the TAPE-2 jacks

Playing equipment connected to the TAPE-2 jacks does not differ from playing equipment connected in other ways. See "Input source selection and surround setup" on page 25.

## How does the TAPE-2 MONITOR button differ from other source selector buttons?

In addition to selecting the TAPE-2 source, the TAPE-2 MONITOR button has a special feature for recording with a 3-head cassette tape deck. Press the TAPE MONITOR button and the TAPE-2 MONITOR function is activated and the TAPE-2 MONITOR indicator appears. In this mode, sound from sources other than the TAPE-2 source cannot be heard from the speakers even if selected. To deactivate the TAPE-2 MONITOR function, press the TAPE-2 MONITOR button again.

2

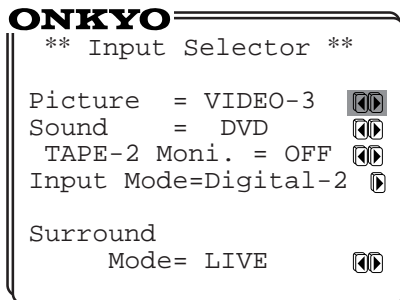

## Activating the TAPE-2 MONITOR function

### Using the on-screen Menu

In the following procedure, use the remote controller unless otherwise specified.

1. **Press the ENTER button.**  
The Menu appears on the TV screen.
2. **Select "Input Selector" using the ▲ or ▼ cursor button, then press the ► cursor button.**  
The Input Selector screen appears.
3. **Select "TAPE-2 Moni." using the ▲ or ▼ button and then set it to ON or OFF using the ◀ or ▶ cursor button.**  
The TAPE-2 MONITOR indicator lights up on the display. If you start recording, the sound being recorded will be heard from the speakers.  
For details, see the owner's manual of your cassette tape deck.
4. **Press the ENTER button.**

### Using the front panel

1. **Follow the procedure described in "Recording from an audio/video source" on page 43.**  
Record with a 3-head cassette tape deck connected to the TAPE-2 jacks of the TX-DS656.
2. **Press the TAPE-2 MONITOR button on the front panel.**  
The TAPE-2 MONITOR indicator lights up on the display. If you start recording, the sound being recorded will be heard from the speakers.

### Note:

- Once the TAPE-2 Monitor function is activated, sound from only the source connected to the TAPE-2 jacks can be heard from the speakers unless you press the TAPE-2 button to clear the "TAPE-2 MONITOR" display.
- The TAPE-2 Monitor function cannot be used if other than a 3-head cassette tape deck is connected.

### Using a graphic equalizer

Connect the graphic equalizer to the TAPE-2 IN jacks (see page 11) to monitor the sound processed by the equalizer. You may record the processed sound on recording equipment connected to the graphic equalizer.

### CAUTION:

Do not select a Surround mode when using the equalizer. This will result in distortion and possible damage to the Surround decoder circuitry.

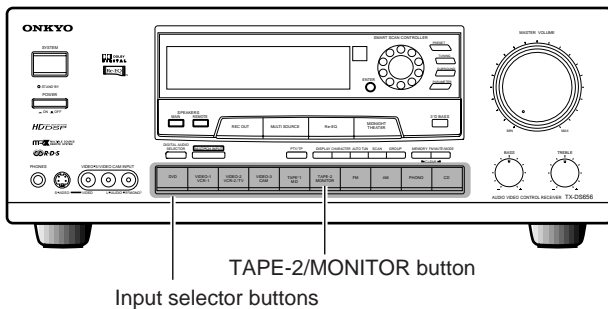

# Using the other remote controller functions with the supplied remote controller

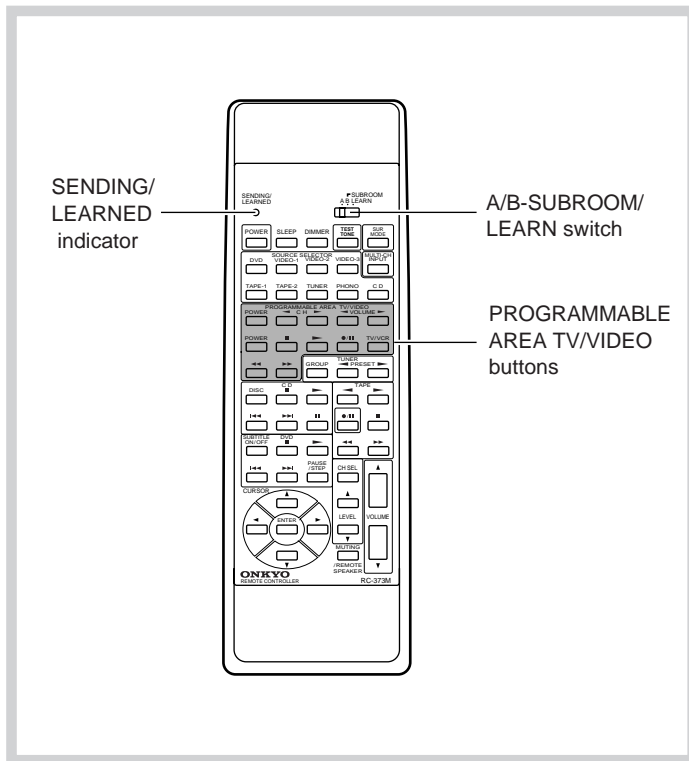

The remote controller supplied with the TX-DS656 can learn functions available with other component's remote controllers.

The control codes for Onkyo cassette tape decks and CD players are already available with the supplied remote controller.

## SENDING/LEARNED indicator

This indicator lights when the remote controller is transmitting a control command or learning other controller's functions. If the indicator does not light, replace the batteries.

## A/B-SUBROOM/LEARN switch

**A:** Select this position to use the remote controller in the main room.

**B-SUBROOM:** Select this position to use the remote controller in the sub-room.

**LEARN:** Select this position to have the supplied remote controller learn another remote controller's functions.

## PROGRAMMABLE AREA TV/VIDEO buttons

Use these buttons to have the supplied remote controller learn another remote controller's function.

**For TV:** Power ON/OFF (POWER) and Channel selection (◀CH▶).

**For VDP:** Power ON/OFF (POWER), Playback (▶), and Stop (■)

**For VCR:** Playback (▶), Stop (■), Rewind (◀◀), and Fast Forward (▶▶)

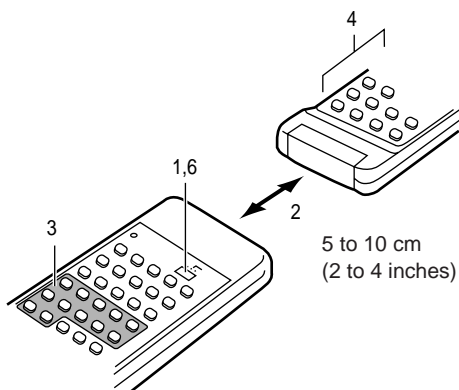

## Learning new control codes

1. Set the A/B-SUBROOM/LEARN selector switch to LEARN.
2. Place the head of your existing remote controller 2-4 inches (5-10 cm) from the head of this remote controller, laying both units on a table or another flat surface.
3. Press a button in the PROGRAMMABLE AREA of this remote controller to which you want to transfer the code. The SENDING/LEARNED indicator lights.
4. Hold down the button for the function you want to transfer on the other remote controller until the SENDING/LEARNED indicator turns off.
5. Repeat steps 3 and 4 until all the required function are transferred to the supplied remote controller.
6. Set the A/B-SUB ROOM/LEARN selector switch back to A.

## Note:

- Some remote controllers use a single button to change codes, with the code changing each time the button is pressed. If you are using this type of controller, perform "learn" operations for each function individually, one function to one button on this remote controller.
- This remote controller transmits codes using infrared rays and can memorize the codes of other remote controllers that also use an infrared system; however, depending on the system, there may be some rare occasions when memorization is not possible.

## Changing the learned commands

Perform the whole procedure described in "Learning new control codes". The existing commands on the supplied remote controller are replaced with the newly learned commands.

## To erase all the learned commands

1. Set the A/B-SUB ROOM/LEARN selector switch to LEARN.
2. While pressing the POWER button, hold down the VOLUME ▼ button until the SENDING/LEARNED indicator turns off. All the commands stored in programmable area have been erased.

1

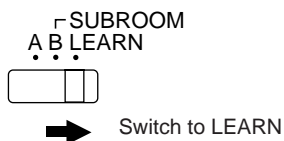

1

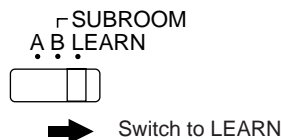

2

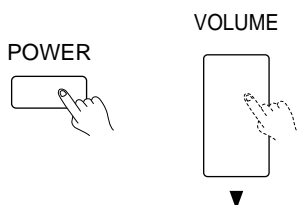

# Multi-room system connections

## U.S.A. and Canadian models (Xantech Multi-Room Systems)

Do not plug in the power cord until all connections have been made.

When making connections ① through ⑤, be sure to connect the units as shown in the diagram below. Do not make a mistake when connecting the units.

### A. Operating components displaying Onkyo's $\mathcal{R}I$ mark from the sub-room

Components mounted in a rack should be connected as shown below to enable remote control operation.

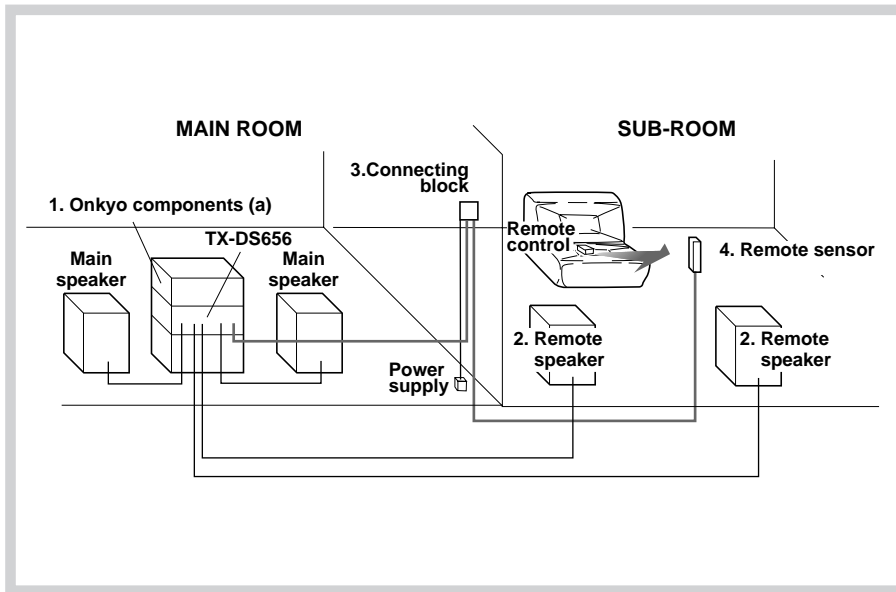

1. Set up the components (a) displaying Onkyo's  $\mathcal{R}I$  mark.
2. Connect the sub-room speaker cables to the FRONT REMOTE SPEAKERS connectors on the TX-DS656. (①)
3. Install Connecting Block in the main room, then connect it to the TX-DS656. (②)
4. Install the Remote Sensor in the sub-room, then connect it to the Connecting Block in the main room. (③)

### B. Using a remote controller to operate components not displaying Onkyo's $\mathcal{R}I$ mark from the sub-room

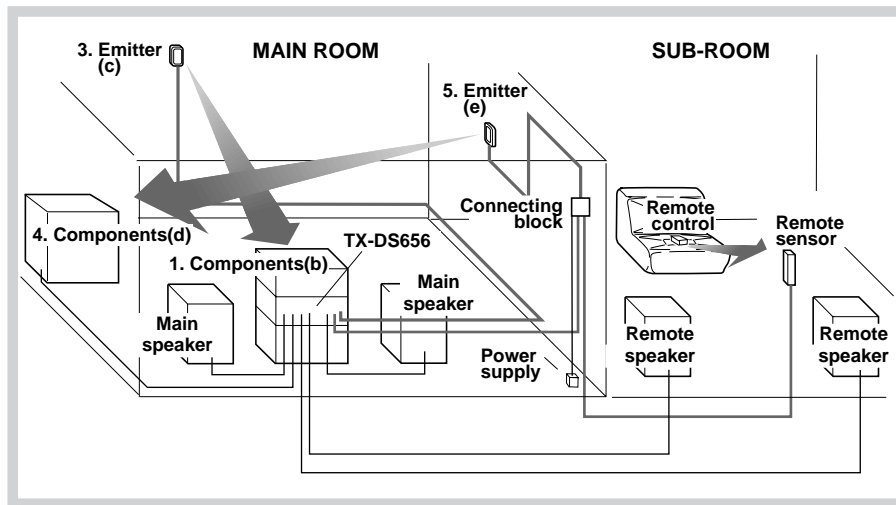

1. Connect the components (b) to the TX-DS656.
2. Make the connections described above in steps 2 through 4 of section A.
3. Install Emitter (c) so that its sensor is directed toward these components, then connect it to the TX-DS656. (④)
- Operating components which are positioned out of the range of the emitter installed as described above
4. Connect the components (d) to the TX-DS656.
5. Install another Emitter (e) so that its sensor is directed toward these components, then connect it to the Connecting Block. (⑤)

### Connection diagram

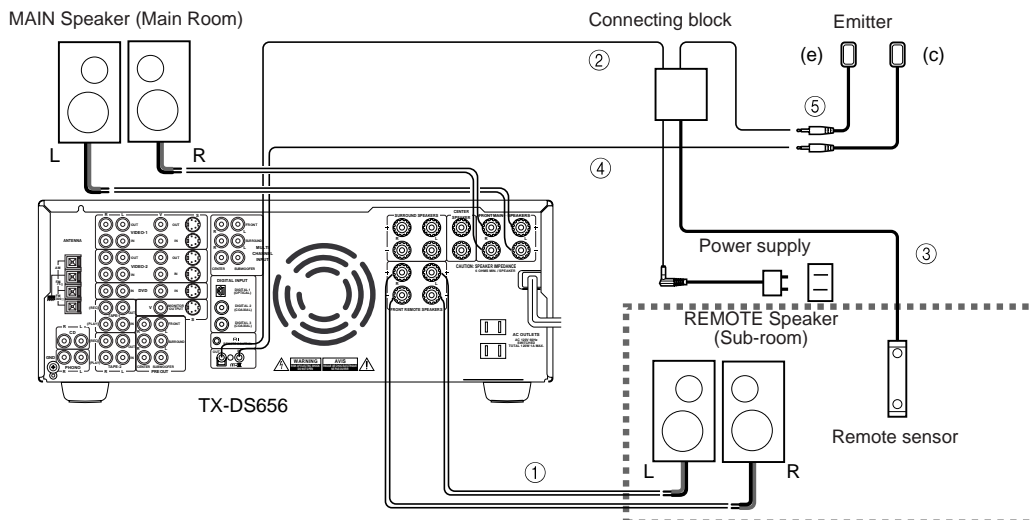

# Multi-room system connections

## Models other than U.S.A. and Canadian models (Onkyo Multi-Room Systems)

Do not plug in the power cord until all connections have been made.

When making connections ① through ④, be sure to connect the units as shown in the connection diagram below. Do not make a mistake when connecting the units.

### A. Operating components displaying Onkyo's $\mathcal{R}$ I mark from the sub-room

Components mounted in a rack should be connected as shown below to enable remote control operation.

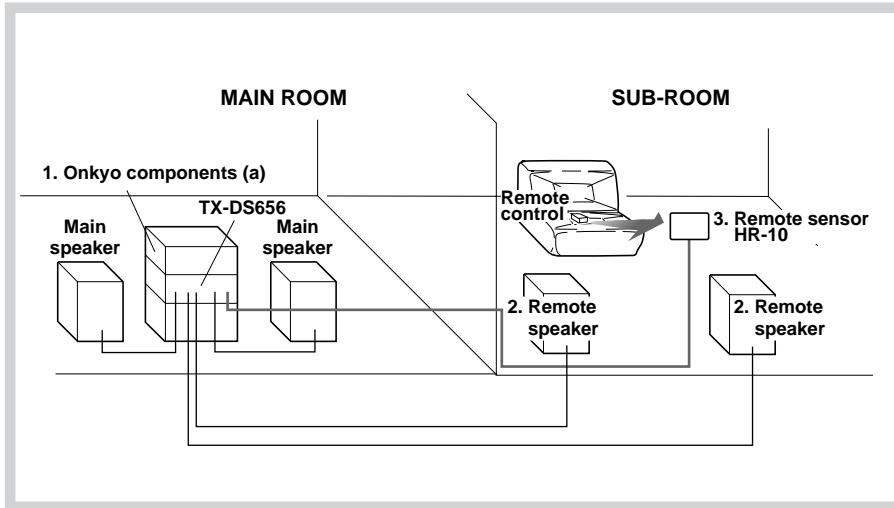

1. Set up the components (a) displaying Onkyo's  $\mathcal{R}$ I mark.
2. Connect the sub-room speaker cables to the FRONT REMOTE SPEAKERS connectors on the TX-DS656. (①)
3. Install Remote Sensor HR-10 in the sub-room, then connect it to the TX-DS656. (②)

### B. Using a remote controller to operate components not displaying Onkyo's $\mathcal{R}$ I mark from the sub-room

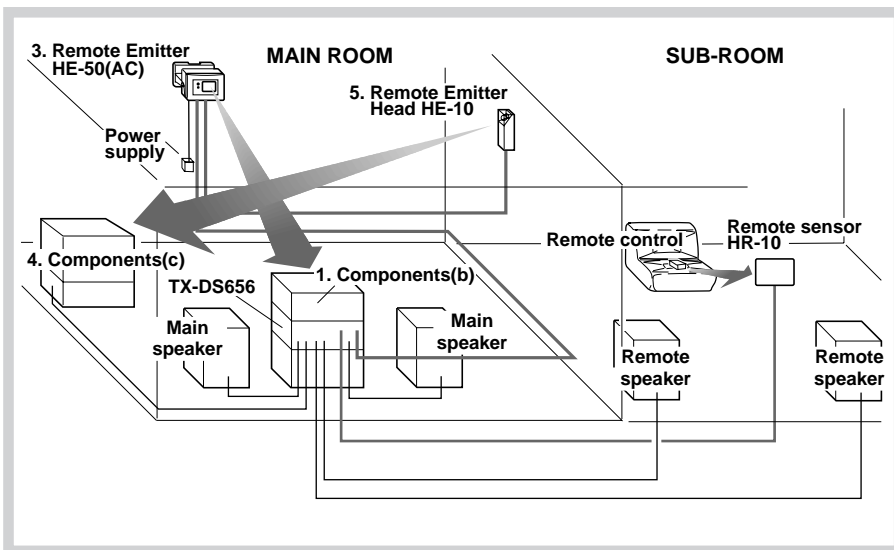

1. Connect the components (b) to the TX-DS656.
2. Make the connections described above in steps 2 through 3 of section A.
3. Install Remote Emitter HE-50 (AC) so that its sensor is directed toward these components, then connect it to the TX-DS656. (③) (Connect the AC adapter to the Remote Emitter.)
- Operating components which are positioned out of the range of the emitter installed as described above.
4. Connect the components (c) to the TX-DS656.
5. Install Remote Emitter Head HE-10 so that its sensor is directed toward these components, then connect it to the HE-50 (AC). (④)

## Connection diagram

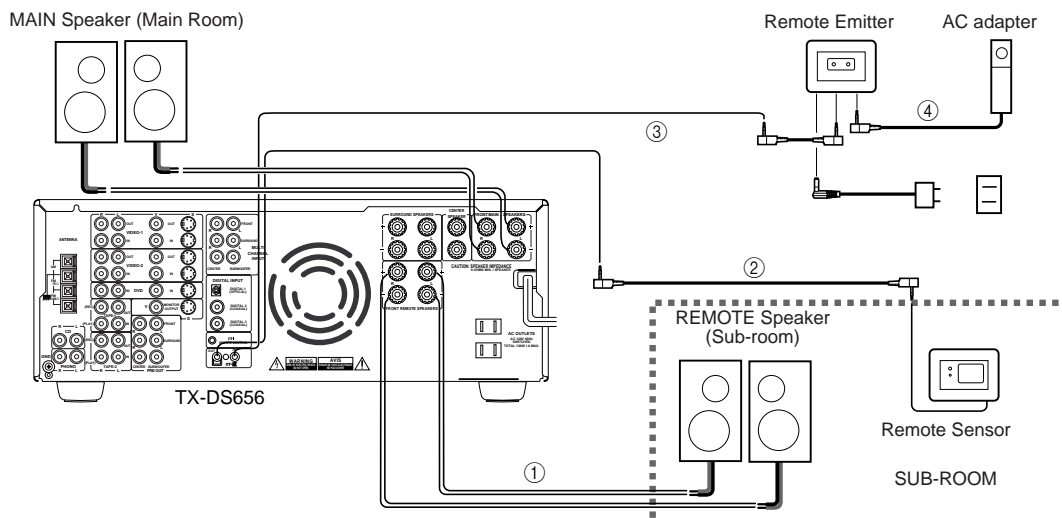

# Multi-room system connections

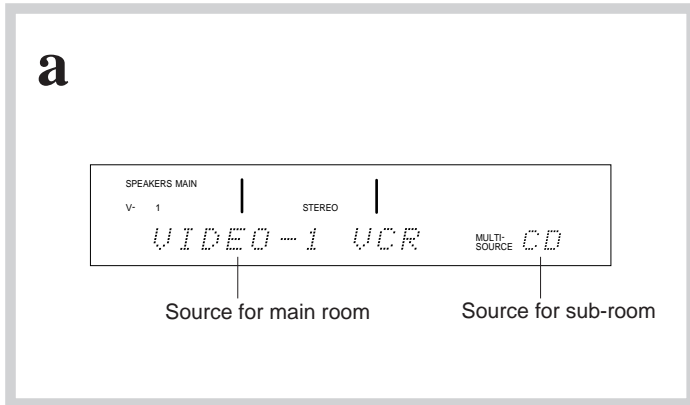
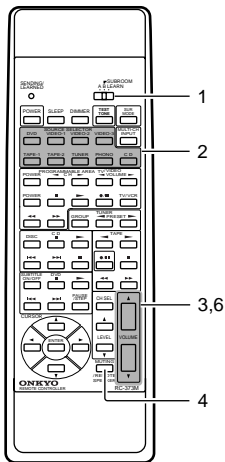
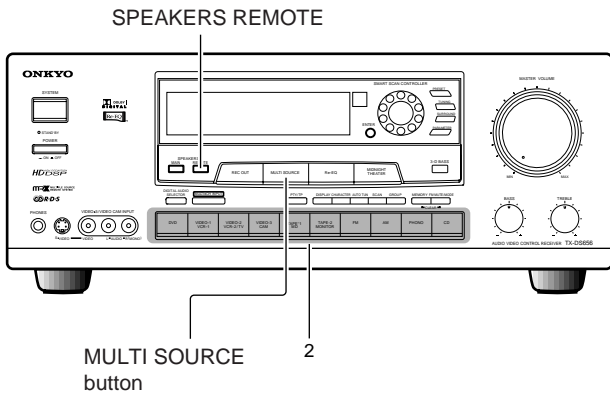

## Playing a source in the sub-room

### In the main room...

You can operate the receiver using the front panel and the remote controller. (Adjusting the sound volume is possible through the remote controller only.)

### In the sub-room...

You can operate the receiver using the remote controller. Be sure to direct the remote controller to the remote sensor (HR-10).

In the following procedure, use the remote controller unless specified otherwise.

1. **Set the A/B-SUBROOM/LEARN switch to "B-SUBROOM".**
2. **Select the source equipment using the SOURCE SELECTOR buttons. (a)**

You cannot select the MULTI-CH INPUT source.

### To use the front panel...

- (1) Press the MULTI-SOURCE button.
- (2) While the MULTI-SOURCE indicator is flashing (for 8 seconds), press the desired source selector button.

### Note:

Pressing a source selector button when the MULTI-SOURCE indicator is not flashing changes the input source for the main room.

3. **Turn the sound volume down to the minimum ( $-\infty$  to  $-81$  dB) using the VOLUME ▼ button.**  
Do not skip this step. It is required to protect the sub-room speakers.
4. **Press the MUTING/REMOTE SPEAKER button.**  
The REMOTE indicator lights up on the display and the sound is output from the sub-room speakers.

### To use the front panel..

Press the SPEAKERS REMOTE button.

5. **Start playing the selected input source.**
6. **Adjust the sound volume using the VOLUME ▲ or ▼ button.**  
It is recommended that you adjust the sound volume while listening to the sound from the sub-room speakers.

### Note:

- If you use the MULTI-CH INPUT or Surround function, no sound will be output from the sub-room speakers. The Multi-room system cannot be used with these functions.
- To enjoy sound in only the sub-room, press the SPEAKER MAIN button to turn off the output to the main speakers.  
When you have finished listening in the sub-room, turn down the sound volume to the minimum for the next opportunity (see step 3 above).
- Activating the multi-room system cancels the surround mode for the main room and sets the STEREO mode automatically.



# Memo

---

# Troubleshooting

## Note:

If a problem occurs while you are using the remote controller, first operate the unit using the front panel controls to confirm that it is not due to a malfunction (or worn out batteries) of the remote controller.

| Trouble  | Cause  | Remedy   |
|--|--|--|
| Power shut off immediately after power on.                         | <ul style="list-style-type: none"> <li>Amplifier protection circuitry has been activated.</li> </ul>   | <ul style="list-style-type: none"> <li>Remove the AC plug from the outlet immediately. Then contact your Onkyo service center.</li> </ul>  |
| No power   | <ul style="list-style-type: none"> <li>Power cord is disconnected.</li> <li>There is external noise in the computer circuits of the TX-DS656.</li> <li>AC fuse is blown.</li> </ul>  | <ul style="list-style-type: none"> <li>Connect the power cord.</li> <li>Remove the AC plug from the outlet, leave the unit for 5 seconds or more, and then plug it again.</li> <li>Contact your Onkyo service center.</li> </ul>   |
| Power but no sound   | <ul style="list-style-type: none"> <li>TAPE-2 MONITOR indicator is on.</li> <li>MUTING indicator is on.</li> <li>Bad connection</li> </ul>   | <ul style="list-style-type: none"> <li>Press the TAPE-2 MONITOR button to turn it off.</li> <li>Turn it off using the remote controller MUTING button.</li> <li>Check the connection again. Insert the plugs and connectors completely.</li> </ul>   |
| No sound or quiet sound from Center speaker                        | <ul style="list-style-type: none"> <li>Surround mode is set to HALL, LIVE, ARENA, STUDIO, or STEREO.</li> <li>Center speaker is set to NONE.</li> <li>Center speaker output level setting is improper.</li> </ul>  | <ul style="list-style-type: none"> <li>In the HALL, LIVE, ARENA, and STUDIO surround modes, the center speaker reproduces sound effects only. This causes little output from the Center speaker, in comparison with the DOLBY PRO LOGIC mode. In the STEREO mode, no sound is output from the Center speaker.</li> <li>For the Center speaker, you must set the speaker mode to SMALL, or LARGE.</li> <li>Check the output level of the Center speaker.</li> </ul> |
| Hum, low-frequency noise   | <ul style="list-style-type: none"> <li>Poor phono grounding (GND) connection.</li> <li>Poor positioning of the audio connection cables.</li> </ul>   | <ul style="list-style-type: none"> <li>Remove the grounding wire if hum is reduced.</li> <li>Position the audio connection cables to obtain the least hum.</li> </ul>  |
| Howling when the volume is turned up                               | <ul style="list-style-type: none"> <li>Turntable and speakers are too close together.</li> </ul>   | <ul style="list-style-type: none"> <li>Move them farther apart.</li> </ul>   |
| Rough or scratchy sound/High range is not clear.                   | <ul style="list-style-type: none"> <li>Check possible causes on connected components, such as a worn pick-up stylus on the turntable.</li> <li>Treble control is too high.</li> </ul>  | <ul style="list-style-type: none"> <li>Check possible causes according to the other components' owner's manual.</li> <li>Turn the treble control down.</li> </ul>  |
| No sound or quiet sound from subwoofer                             | <ul style="list-style-type: none"> <li>Subwoofer is set to NO.</li> <li>Subwoofer speakers output level setting is improper.</li> </ul>  | <ul style="list-style-type: none"> <li>Check the speaker setting.</li> <li>Check the output level of the Subwoofer using the test tone.</li> </ul>   |
| No sound in sub-room   | <ul style="list-style-type: none"> <li>SPEAKERS REMOTE indicator is not lit.</li> <li>Sound volume for the sub-room is set to <math>-\infty</math> dB.</li> </ul>  | <ul style="list-style-type: none"> <li>Press the SPEAKERS REMOTE button on the remote controller or front panel.</li> <li>Increase the sound volume using the VOLUME ▲ button on the remote controller.</li> </ul>   |
| The Multi-Room Remote System cannot be operated from the sub-room. | <ul style="list-style-type: none"> <li>The remote controller is not directed toward the remote sensor.</li> <li>There is an obstacle between the remote controller and the sensor.</li> <li>There is a malfunction of either the receiver or remote controller.</li> <li>Bad connection</li> </ul> | <ul style="list-style-type: none"> <li>Direct the remote controller to the sub-room remote sensor.</li> <li>Remove the obstacle.</li> <li>Check the receiver and then the remote controller in the main room to find out which is malfunctioning.</li> <li>Check the connections again. Insert the plugs and cables completely.</li> </ul>   |

# Troubleshooting

| Trouble   | Cause   | Remedy   |
|---|---|--|
| AM stations cannot be received.   | <ul style="list-style-type: none"> <li>AM loop antenna is not attached.</li> </ul>  | <ul style="list-style-type: none"> <li>Connect the included AM loop antenna to the AM antenna connectors.</li> </ul>   |
| Buzzing noise on AM (particularly conspicuous at night or with weak stations)             | <ul style="list-style-type: none"> <li>Noise from electrical apparatus such as fluorescent lamp</li> </ul>  | <ul style="list-style-type: none"> <li>Move AM loop antenna to a different position.</li> <li>Set up outdoor AM antenna.</li> </ul>  |
| High-pitched noise or buzzing noise on AM   | <ul style="list-style-type: none"> <li>Noise from TV set</li> </ul>   | <ul style="list-style-type: none"> <li>Place the AM loop antenna as far as possible from the TV.</li> <li>Move the unit away from the TV.</li> </ul>   |
| Crackling noise on AM or FM   | <ul style="list-style-type: none"> <li>Noise caused by turning fluorescent lamp on and off</li> <li>Noise from automobile ignition</li> </ul>                     | <ul style="list-style-type: none"> <li>Move antenna as far as possible from the fluorescent lamp.</li> <li>Install the FM outdoor antenna as far as possible from the road.</li> <li>Change the position or direction of the outdoor antenna.</li> </ul> |
| FM TUNED and STEREO indicators light but sound is distorted and stereo separation is bad. | <ul style="list-style-type: none"> <li>Station is too strong.</li> <li>Multiple reflection of the radio waves because of tall buildings or mountains.</li> </ul>  | <ul style="list-style-type: none"> <li>Change to T-shaped antenna.</li> <li>Use antenna which has better directivity and select a point where the distortion is least.</li> </ul>  |
| FM TUNED and STEREO indicators flicker and a hiss is heard on FM.                         | <ul style="list-style-type: none"> <li>Station is too weak.</li> <li>Stereo FM broadcasts cover only about half the distance of an ordinary broadcast.</li> </ul> | <ul style="list-style-type: none"> <li>Install an outdoor FM antenna.</li> <li>Change the position or direction of the outdoor antenna.</li> </ul>   |
| No station is recalled when a preset button is pressed.                                   | <ul style="list-style-type: none"> <li>The power cord has been unplugged for a long time.</li> </ul>  | <ul style="list-style-type: none"> <li>The memory contents are lost. Store all stations again.</li> </ul>  |
| Image does not appear when VIDEO-2 or MULTI-CH INPUT button is pressed.                   | <ul style="list-style-type: none"> <li>Bad connection</li> <li>IPM function is activated.</li> </ul>  | <ul style="list-style-type: none"> <li>Check the connection again. Insert the plugs and connectors completely.</li> <li>Deactivate the IPM function.</li> </ul>  |
| Receiver's front panel is operational, but remote control is unusable.                    | <ul style="list-style-type: none"> <li>No batteries in the remote controller.</li> <li>Batteries are used up.</li> </ul>  | <ul style="list-style-type: none"> <li>Insert batteries in the remote controller.</li> <li>Replace the batteries.</li> </ul>   |
| Midnight Theater function cannot be used.   | <ul style="list-style-type: none"> <li>Playback source is not Dolby Digital encoded.</li> </ul>   | <ul style="list-style-type: none"> <li>Check that the DOLBY DIGITAL indicator lights up on the display.</li> </ul>   |
| LFE LEVEL function cannot be used.  | <ul style="list-style-type: none"> <li>Playback source is not Dolby Digital encoded.</li> </ul>   | <ul style="list-style-type: none"> <li>Check that the DOLBY DIGITAL indicator lights up on the display.</li> </ul>   |
| Cinema Re-EQ function cannot be used.   | <ul style="list-style-type: none"> <li>Playback source is not encoded for Dolby Digital, Dolby Pro Logic, Dolby 3 Stereo, or Multi-ch Input.</li> </ul>           | <ul style="list-style-type: none"> <li>Check the playback source.</li> </ul>   |

This device employs a microcomputer to perform various functions and operations. Interference generated by an external power supply, radio waves, or other electrical sources will cause the specified operations and functions to operate abnormally. To reset the unit, please follow the procedure below.

1. While holding down the CD button, press the POWER button.
2. After "clear" is displayed, the preset memory and each mode stored in the memory, such as Surround, are initialized and will return to the factory settings.

# Specifications

## AMPLIFIER SECTION

Continuous Average Power output (FTC)

Front Main L/R channels:

**85 watts per channel min. RMS at 8 ohms, both channels driven from 20Hz to 20kHz with no more than 0.08% total harmonic distortion.**

Center channel:

**85 watts min. RMS at 8 ohms, driven from 20Hz to 20kHz with no more than 0.08% total harmonic distortion.**

Surround L/R channels:

**85 watts per channel min. RMS at 8 ohms, both channels driven from 20Hz to 20kHz with no more than 0.08% total harmonic distortion.**

Front Remote L/R channels:

**85 watts per channel min. RMS at 8 ohms, both channels driven from 20Hz to 20kHz with no more than 0.08% total harmonic distortion.**

Continuous Power output (DIN)

Front Main L/R channels: 115W × 2 at 6 ohms

Center channel: 115W at 6 ohms

Surround L/R channels: 115W × 2 at 6 ohms

Front Remote L/R channels: 115W × 2 at 6 ohms

Maximum Power output (EIAJ)

Front Main L/R channels: 145W × 2 at 6 ohms

Center channel: 145W at 6 ohms

Surround L/R channels: 145W × 2 at 6 ohms

Front Remote L/R channels: 145W × 2 at 6 ohms

IM Distortion: 0.08% at rated power (FRONT)

Damping Factor: 60 at 8 ohms (FRONT)

Input Sensitivity/Impedance

PHONO : 2.5 μV, 50 kohms

LINE (CD, TAPE-1, 2, DVD, VIDEO-1, 2, 3) : 200 μV, 50 kohms

DIGITAL-2, 3 (COAXIAL) : 0.5 Vp-p, 75 ohms

Output Level and Impedance

Rec out (TAPE-1, 2, VIDEO-1, 2) : 200 μV, 2.2 kohms

Pre out (FRONT L/R, CENTER, SURROUND L/R) : 1 V, 560 ohms

(SUBWOOFER) : 1 V, 2.2 kohms

Phono Overload: 120 μV RMS at 1,000 Hz, 0.5% THD.

Frequency Response: 20 to 30,000 Hz, +/-1 dB (STEREO)

RIAA Deviation: 20 to 20,000 Hz, +/-0.8 dB

Tone Control: BASS: +/-10 dB at 50 Hz

TREBLE: +/-10 dB at 10,000 Hz

Signal to Noise Ratio: PHONO: 80 dB (IHF A, 5 μV input)

CD/TAPE: 100 dB (IHF A)

## VIDEO SECTION

Television Format: NTSC (U.S. and Canadian models)

NTSC/PAL (Other models)

Input Sensitivity/Impedance

DVD, VIDEO-1,2,3 (Composite):

1 Vp-p/75 ohms

S-VIDEO (Y signal):

1 Vp-p/75 ohms

S-VIDEO (C signal):

0.28 Vp-p/75 ohms

Output Level/Impedance

VIDEO (VIDEO-1,2,MONI) (Composite):

1 Vp-p/75 ohms

S-VIDEO (Y signal):

1 Vp-p/75 ohms

S-VIDEO (C signal):

0.28 Vp-p/75 ohms

## TUNER SECTION

FM:

Tuning Range: 87.5 MHz to 108.0 MHz (50 kHz steps)

Usable Sensitivity: Mono: 11.2 dBf, 1.0 μV (75 ohms)  
0.9 μV / 75 ohm DIN

Stereo: 17.2 dBf, 2.0 μV (75 ohms)  
23 μV / 75 ohm DIN

50dB Quieting Sensitivity: Mono: 17.2 dBf, 2.0 μV (75 ohms)

Stereo: 37.2 dBf, 20 μV (75 ohms)

Capture Ratio: 1.5 dB

Image Rejection Ratio: U.S. & Canadian models: 40 dB  
Other area models: 85 dB

IF Rejection Ratio: 90 dB

Signal-to-Noise Ratio: Mono: 76 dB

Stereo: 70 dB

Alternate Channel Attenuation: 55 dB, 50 dB (DIN)

AM Suppression Ratio: 50 dB

Total Harmonic Distortion: Mono: 0.15%

Stereo: 0.25%

Frequency Response: 30 – 15,000 Hz +/-1.0 dB

Stereo Separation: 45 dB at 1 kHz/30 dB at 100 – 10,000 Hz

Muting Level: 17.2 dBf, 2.0 μV (75 ohms)

AM:

Tuning Range: European models

522 kHz – 1611 kHz (9 kHz steps)

U.S. & Canadian models

530 kHz – 1710 kHz (10 kHz steps)

Worldwide model

531 kHz – 1602 kHz (9 kHz steps)

530 kHz – 1710 kHz (10 kHz steps)

Usable Sensitivity: 30 μV

Image Rejection Ratio: 40 dB

IF Rejection Ratio: 40 dB

Signal-to-Noise Ratio: 40 dB

Total Harmonic Distortion: 0.7%

## GENERAL

Power Supply: AC 120 V, 60 Hz

AC 230 V, 50 Hz

AC 120 and 220-230 V switchable, 50/60 Hz

Power Consumption: US and Canadian models: 4.8 A

Other area models: 460 W

Dimensions (W × H × D): 435 × 175 × 390 mm

17-1/8" × 6-7/8" × 15-3/8"

Weight: 12.0 kg (26.5 lbs) (AC 120 V, 60 Hz model)

12.9 kg (28.4 lbs) (Other models)

Specifications and features are subject to change without notice.

# Control positions and names

## Rear panel

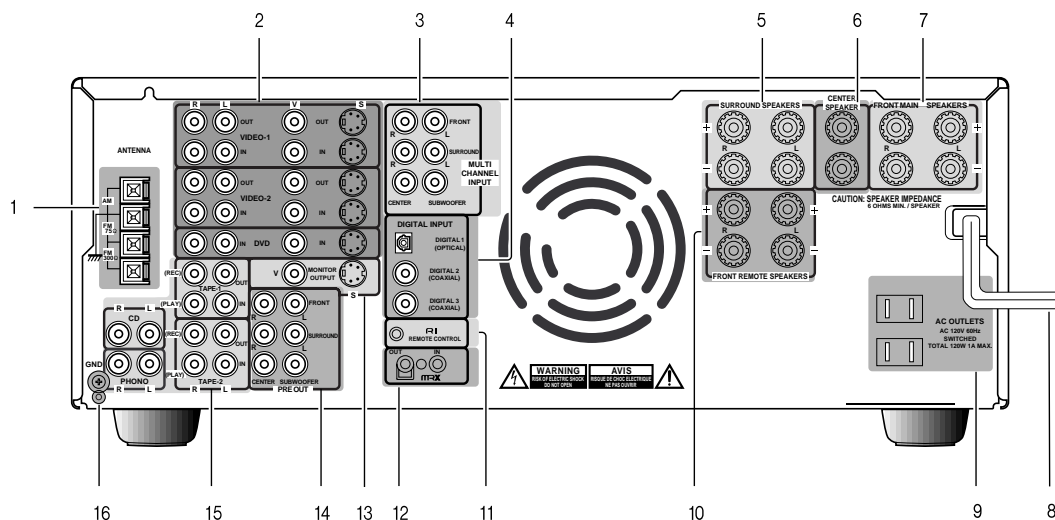

US and Canadian models

## Rear panel

For more information about buttons or controls, refer to the pages listed in brackets ( [ ] ) below.

1. FM/AM ANTENNA connector [13, 14]
2. VIDEO-1, VIDEO-2, and DVD connectors [9, 10, 12]
3. MULTI CHANNEL INPUT connector [10]
4. DIGITAL INPUT connector [8]
5. SURROUND SPEAKERS terminals [16]
6. CENTER SPEAKER terminals [16]
7. FRONT MAIN SPEAKERS terminals [16]
8. Power cord [17]
9. AC OUTLETS [17]
10. FRONT REMOTE SPEAKERS terminals [46, 47]
11. **RI** connector [11]
12. **MRX** connector [46, 47]
13. MONITOR OUTPUT connector [12]
14. PRE OUT connector [16]
15. TAPE-1, TAPE-2, CD, and PHONO connector [8, 11]
16. GND terminals [8]

## Control positions and names

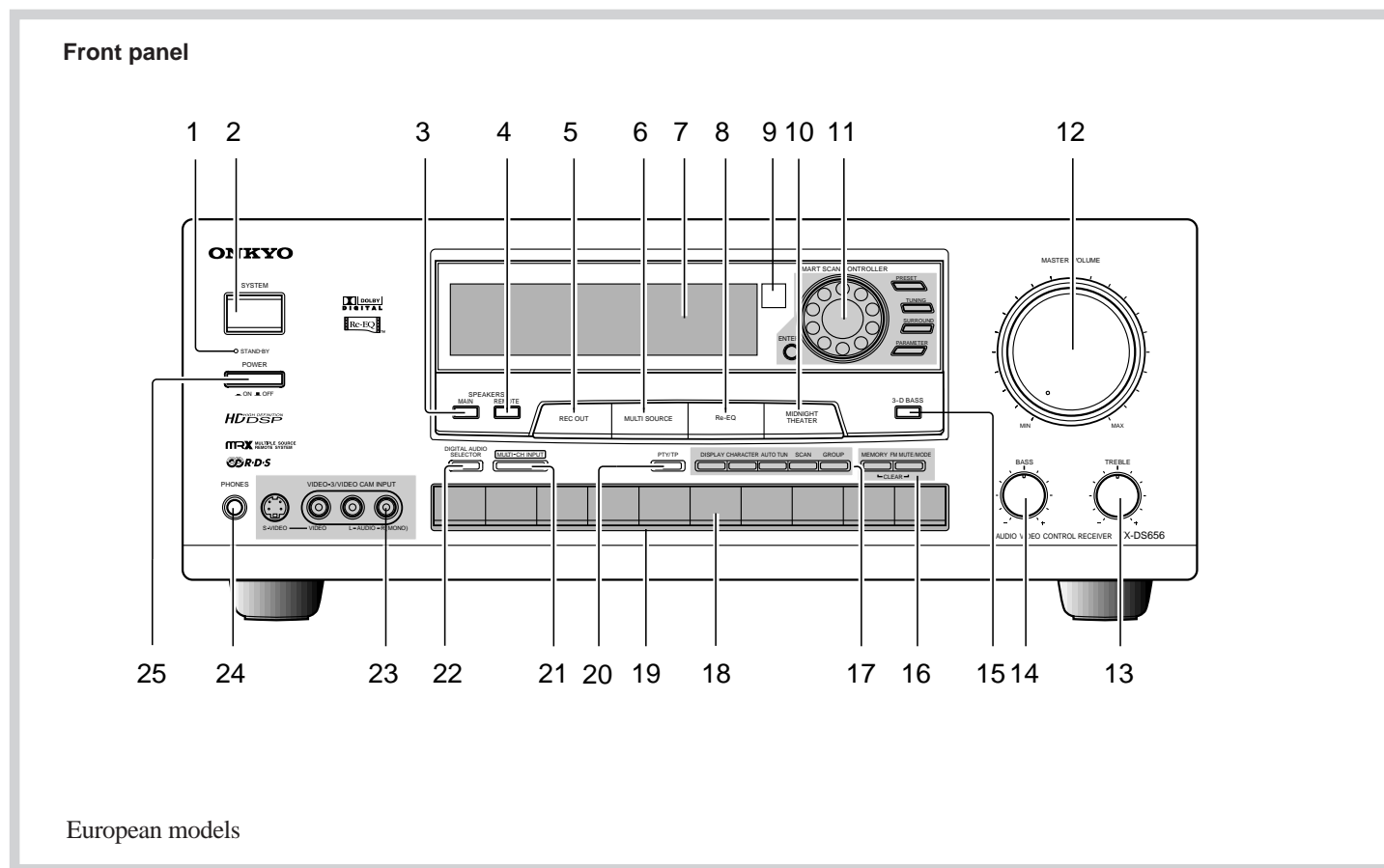

### Front panel

For more information about buttons or controls, refer to the pages listed in brackets ( [ ] ) below.

1. **STAND-BY indicator** [17]
2. **POWER (or SYSTEM) button** [17]
3. **SPEAKERS MAIN button** [27, 29]
4. **SPEAKERS REMOTE button** [48]
5. **REC OUT button** [43]
6. **MULTI SOURCE button** [48]
7. **Display**
8. **Re-EQ button** [40]
9. **Remote Sensor** [5]
10. **MIDNIGHT THEATER button** [40]
11. **Controls for tuning and Surround mode/parameter adjustment**  
**ENTER button** [18, 30, 33, 35, 40, 41]  
**Jog dial (SMART SCAN CONTROLLER)** [18, 23, 27, 30, 32-35, 37, 39-41]  
**PRESET button** [34]  
**TUNING button** [32]  
**SURROUND button** [27, 39-41]  
**PARAMETER button** [23, 27, 40]
12. **MASTER VOLUME control knob** [27, 29]
13. **TREBLE control knob** [31]
14. **BASS control knob** [31]
15. **3-D BASS button** [31]
16. **Controls for frequency presetting**  
**MEMORY button** [33, 35]  
**FM MUTE/MODE button** [32, 33, 35]
17. **Controls for display and tuning**  
**DISPLAY button** [35, 37]  
**CHARACTER button** [35]  
**AUTO TUN button** [32, 35]  
**SCAN button** [34, 37]  
**GROUP button** [33, 34]
18. **TAPE-2 MONITOR button** [44]
19. **Input selector buttons** [27, 30]
20. **PTY/TP button (European model only)** [37]
21. **MULTI-CH INPUT button** [29]
22. **DIGITAL AUDIO SELECTOR button** [30]
23. **VIDEO-3 input jacks** [9, 43]
24. **PHONES jack** [31]
25. **Power on/off switch (Other than US and Canadian models)** [17]

# Control positions and names

## Display

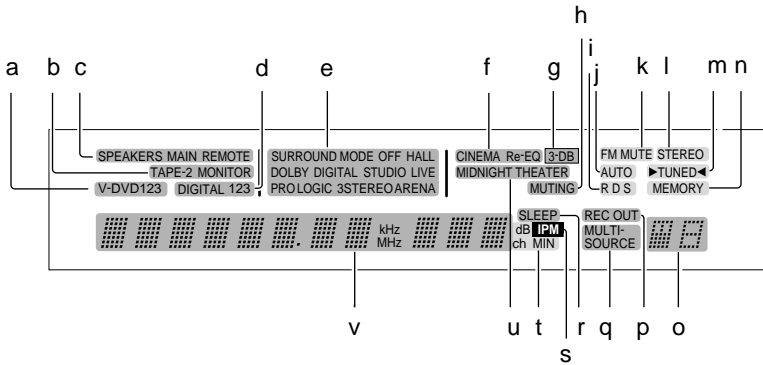

## Display

If a protective film on the surface of the display makes it difficult to read the display, remove the protective film.

- VIDEO-1/2/3 source indicator
- TAPE-2 MONITOR indicator
- SPEAKERS MAIN/REMOTE indicator
- DIGITAL 1/2/3 indicator
- SURROUND MODE indicators
- CINEMA Re-EQ (Cinema Re-Equalizer) indicator
- 3-DB (3-D bass) indicator
- MUTING indicator
- RDS indicator (European model only)
- AUTO (auto-tuning) indicator
- FM MUTE indicator
- STEREO indicator
- TUNED indicator
- MEMORY indicator
- Source display (for recording source/Sub-room components)
- REC OUT (Recording Out) indicator
- MULTI-SOURCE indicator
- SLEEP indicator
- IPM (Intelligent Power Management) indicator
- Unit indicator
- MIDNIGHT THEATER indicator
- Multi-function display

## Remote controller

This remote controller can be used to operate Onkyo CD players, DVD players and (double) cassette tape decks connected via the **RI** remote control cables. The buttons in the PROGRAMMABLE AREA TV/VIDEO section can be used to store functions available with the remote controller of your TV and video equipment.

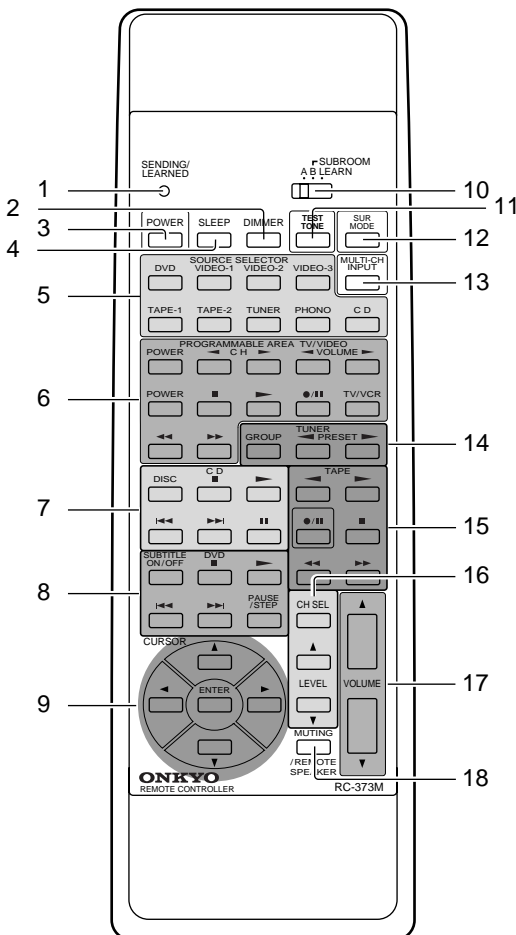

- SENDING/LEARNED indicator [45]
- DIMMER button [31]
- POWER button [17, 45]
- SLEEP button [31]
- SOURCE SELECTOR buttons [28, 34, 48]
- PROGRAMMABLE AREA TV/VIDEO buttons [45]
- CD player operation buttons  
These buttons are used to operate an ONKYO CD player that bears the **RI** terminal. (Refer to page 11 for **RI** connection.)
- DVD player operation buttons  
These buttons are used to operate an ONKYO DVD player that bears the **RI** terminal. (Refer to page 11 for **RI** connection.)
- CURSOR buttons and ENTER button [19, 20, 25, 29, 30, 34, 39, 42-44]
- A/B-SUBROOM/LEARN selector switch [45, 48]
- TEST TONE button [24]
- SUR MODE (Surround mode) button [28, 39]
- MULTI-CH INPUT (multi-channel input) button [29]
- TUNER operation buttons [28, 34]
- TAPE deck operation buttons  
These buttons are used to operate an ONKYO cassette tape deck player that bears the **RI** terminal. (Refer to page 11 for **RI** connection.)
- CH-SEL and LEVEL ▲/▼ buttons [24]
- VOLUME ▲/▼ buttons [26, 28, 29, 45, 48]
- MUTING/REMOTE SPEAKER button [31, 48]

## **ONKYO CORPORATION**

Sales & Product Planning Div.: 2-1, Nisshin-cho, Neyagawa-shi, OSAKA 572-8540, JAPAN  
Tel: 0720-31-8111 Fax: 0720-33-5222

### **ONKYO U.S.A. CORPORATION**

200 Williams Drive, Ramsey, N.J. 07446, U.S.A.  
Tel: 201-825-7950 Fax: 201-825-8150 E-mail: onkyo@onkyousa.com

### **ONKYO EUROPE ELECTRONICS GmbH**

Industriestrasse 20, 82110 Germering, GERMANY  
Tel: 089 84 93 20 Fax: 089 84 93 226 E-mail: info@onkyo.de

### **ONKYO EUROPE FRANCE BRANCH**

Domaine Technologique de Saclay 4, Rue René Razel, SACLAY-91892  
ORSAY CEDEX, FRANCE Tel: (1) 69 33 14 00 Fax: (1) 69 41 35 84

### **ONKYO CHINA LIMITED**

Units 1111-1112 Metroplaza Tower II, 223 Hing Fong Road Kwai Chung,  
N.T., HONG KONG Tel: 852 2429 3118 Fax: 852 2428 9039





## Free Manuals Download Website

<http://myh66.com>

<http://usermanuals.us>

<http://www.somanuals.com>

<http://www.4manuals.cc>

<http://www.manual-lib.com>

<http://www.404manual.com>

<http://www.luxmanual.com>

<http://aubethermostatmanual.com>

Golf course search by state

<http://golfingnear.com>

Email search by domain

<http://emailbydomain.com>

Auto manuals search

<http://auto.somanuals.com>

TV manuals search

<http://tv.somanuals.com>