

ONKYO®

AV Receiver

TX-DS989

Instruction Manual

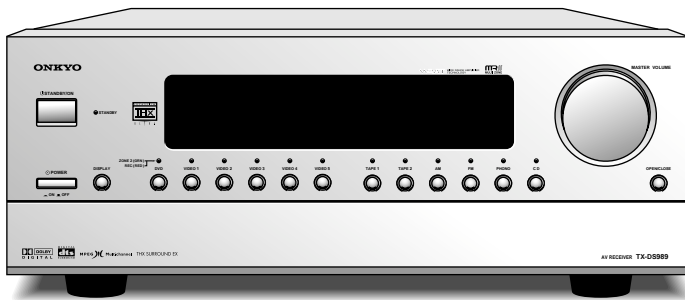

Thank you for purchasing the Onkyo AV Receiver. Please read this manual thoroughly before making connections and plugging in the unit. Following the instructions in this manual will enable you to obtain optimum performance and listening enjoyment from your new AV Receiver. Please retain this manual for future reference.

Contents

Before using

Important Safeguards	2
Precautions	3
Contents	4
Supplied accessories	5
Features	6
Before using remote controller	7

Facilities and connections

Front panel facilities	8
Remote controller	11
Rear panel facilities	12
Example of how to connect your equipment	16
Connecting speakers	20
Connecting antennas	22
Connecting to the IR IN ZONE 2 input	24
Connecting to the IR IN MAIN input	25
Connecting a graphic equalizer and power amplifiers	26
Connecting the power	27

Setting OSD menu

The On-Screen Display (OSD) menu	28
Speaker Setup	30
Input Setup	34
Listening Mode Setup	42
Preference	46
Zone2 OSD Setup	48
About	48

Enjoying music or videos

Enjoying music or videos in the remote zone ...	49
Listening to Radio Broadcasts	50
Enjoying music or videos with the TX-DS989	52
Recording a source	54

Remote controller

Using remote controller	56
Programming the commands of remote controllers for other devices into the remote controller	61
Using a Macro function	64

Appendix

Troubleshooting guide	68
The default settings	71
Your system setting	72
Specifications	76

WARNING:

TO REDUCE THE RISK OF FIRE OR ELECTRIC SHOCK, DO NOT EXPOSE THIS APPLIANCE TO RAIN OR MOISTURE.

CAUTION:

TO REDUCE THE RISK OF ELECTRIC SHOCK, DO NOT REMOVE COVER (OR BACK). NO USER-SERVICEABLE PARTS INSIDE. REFER SERVICING TO QUALIFIED SERVICE PERSONNEL.



The lightning flash with arrowhead symbol, within an equilateral triangle, is intended to alert the user to the presence of uninsulated "dangerous voltage" within the product's enclosure that may be of sufficient magnitude to constitute a risk of electric shock to persons.



The exclamation point within an equilateral triangle is intended to alert the user to the presence of important operating and maintenance (servicing) instructions in the literature accompanying the appliance.

Important Safeguards

- 1. Read Instructions** – All the safety and operating instructions should be read before the appliance is operated.
- 2. Retain Instructions** – The safety and operating instructions should be retained for future reference.
- 3. Heed Warnings** – All warnings on the appliance and in the operating instructions should be adhered to.
- 4. Follow Instructions** – All operating and use instructions should be followed.
- 5. Cleaning** – Unplug the appliance from the wall outlet before cleaning. The appliance should be cleaned only as recommended by the manufacturer.
- 6. Attachments** – Do not use attachments not recommended by the appliance manufacturer as they may cause hazards.
- 7. Water and Moisture** – Do not use the appliance near water – for example, near a bath tub, wash bowl, kitchen sink, or laundry tub; in a wet basement; or near a swimming pool; and the like.
- 8. Accessories** – Do not place the appliance on an unstable cart, stand, tripod, bracket, or table. The appliance may fall, causing serious injury to a child or adult, and serious damage to the appliance. Use only with a cart, stand, tripod, bracket, or table recommended by the manufacturer, or sold with the appliance. Any mounting of the appliance should follow the manufacturer's instructions, and should use a mounting accessory recommended by the manufacturer.
- 9. An appliance and cart combination** should be moved with care. Quick stops, excessive force, and uneven surfaces may cause the appliance and cart combination to overturn.
- 10. Ventilation** – Slots and openings in the cabinet are provided for ventilation and to ensure reliable operation of the appliance and to protect it from overheating, and these openings must not be blocked or covered. The openings should never be blocked by placing the appliance on a bed, sofa, rug, or other similar surface. The appliance should not be placed in a built-in installation such as a bookcase or rack unless proper ventilation is provided. There should be free space of at least 20 cm (8 in.) and an opening behind the appliance.
- 11. Power Sources** – The appliance should be operated only from the type of power source indicated on the marking label. If you are not sure of the type of power supply to your home, consult your appliance dealer or local power company.
- 12. Grounding or Polarization** – The appliance may be equipped with a polarized alternating current line plug (a plug having one blade wider than the other). This plug will fit into the power outlet only one way. This is a safety feature. If you are unable to insert the plug fully into the outlet, try reversing the plug. If the plug should still fail to fit, contact your electrician to replace your obsolete outlet. Do not defeat the safety purpose of the polarized plug.
- 13. Power-Cord Protection** – Power-supply cords should be routed so that they are not likely to be walked on or pinched by items placed upon or against them, paying particular attention to cords at plugs, convenience receptacles, and the point where they exit from the appliance.
- 14. Outdoor Antenna Grounding** – If an outside antenna or cable system is connected to the appliance, be sure the antenna or cable system is grounded so as to provide some protection against voltage surges and built-up static charges. Article 810 of the National Electrical Code, ANSI/NFPA 70, provides information with regard to proper grounding of the mast and supporting structure, grounding of the lead-in wire to an antenna-discharge unit, size of grounding conductors, location of antenna-discharge unit, connection to grounding electrodes, and requirements for the grounding electrode. See Figure 1.
- 15. Lightning** – For added protection for the appliance during a lightning storm, or when it is left unattended and unused for long periods of time, unplug it from the wall outlet and disconnect the antenna or cable system. This will prevent damage to the appliance due to lightning and power-line surges.
- 16. Power Lines** – An outside antenna system should not be located in the vicinity of overhead power lines or other electric light or power circuits, or where it can fall into such power lines or circuits. When installing an outside antenna system, extreme care should be taken to keep from touching such power lines or circuits as contact with them might be fatal.
- 17. Overloading** – Do not overload wall outlets, extension cords, or integral convenience receptacles as this can result in a risk of fire or electric shock.
- 18. Object and Liquid Entry** – Never push objects of any kind into the appliance through openings as they may touch dangerous voltage points or short-out parts that could result in a fire or electric shock. Never spill liquid of any kind on the appliance.
- 19. Servicing** – Do not attempt to service the appliance yourself as opening or removing covers may expose you to dangerous voltage or other hazards. Refer all servicing to qualified service personnel.
- 20. Damage Requiring Service** – Unplug the appliance from the wall outlet and refer servicing to qualified service personnel under the following conditions:
 - When the power-supply cord or plug is damaged,
 - If liquid has been spilled, or objects have fallen into the appliance,
 - If the appliance has been exposed to rain or water,
 - If the appliance does not operate normally by following the operating instructions. Adjust only those controls that are covered by the operating instructions as an improper adjustment of other controls may result in damage and will often require extensive work by a qualified technician to restore the appliance to its normal operation,
 - If the appliance has been dropped or damaged in any way, and
 - When the appliance exhibits a distinct change in performance – this indicates a need for service.

PORTABLE CART WARNING



S3125A

21. **Replacement Parts**—When replacement parts are required, be sure the service technician has used replacement parts specified by the manufacturer or have the same characteristics as the original part. Unauthorized substitutions may result in fire, electric shock, or other hazards.
22. **Safety Check** – Upon completion of any service or repairs to the appliance, ask the service technician to perform safety checks to determine that the appliance is in proper operation condition.
23. **Wall or Ceiling Mounting** – The appliance should be mounted to a wall or ceiling only as recommended by the manufacturer.
24. **Heat** – The appliance should be situated away from heat sources such as radiators, heat registers, stoves, or other appliances (including amplifiers) that produce heat.

Precautions

1. Warranty Claim

You can find the serial number on the rear panel of this unit. In case of warranty claim, please report this number.

2. Recording Copyright

Recording of copyrighted material for other than personal use is illegal without permission of the copyright holder.

3. AC Fuse

The fuse is located inside the chassis and is not user-serviceable. If power does not come on, contact your Onkyo authorized service station.

4. Care

From time to time you should wipe the front and rear panels and the cabinet with a soft cloth. For heavier dirt, dampen a soft cloth in a weak solution of mild detergent and water, wring it out dry, and wipe off the dirt. Following this, dry immediately with a clean cloth. Do not use rough material, thinners, alcohol or other chemical solvents or cloths since these could damage the finish or remove the panel lettering.

5. Power

WARNING

BEFORE PLUGGING IN THE UNIT FOR THE FIRST TIME, READ THE FOLLOWING SECTION CAREFULLY.

The voltage of the available power supply differs according to country or region. Be sure that the power supply voltage of the area where this unit will be used meets the required voltage (e.g., AC 230 V, 50 Hz or AC 120 V, 60 Hz) written on the rear panel.

Precautions during unpacking

- The unit is extremely heavy, so be careful when lifting it so as not to cause an injury. Do not lift or move the unit by holding it at the door on the front panel. Doing so may damage the front door.
- When packaged, the door on the front panel is taped to the unit. Before use, be sure to remove this tape.

Taped

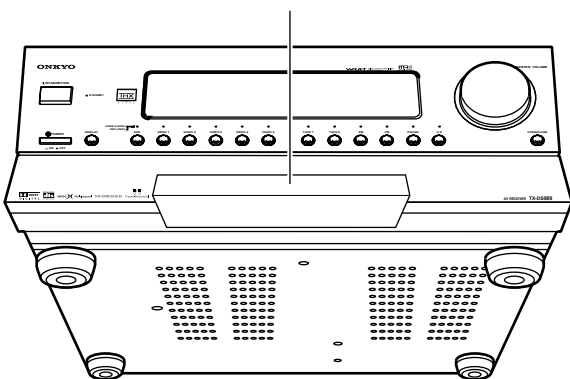

- The taping for packaging may be different for your product.

FIGURE 1:
EXAMPLE OF ANTENNA GROUNDING AS PER NATIONAL
ELECTRICAL CODE, ANSI/NFPA 70

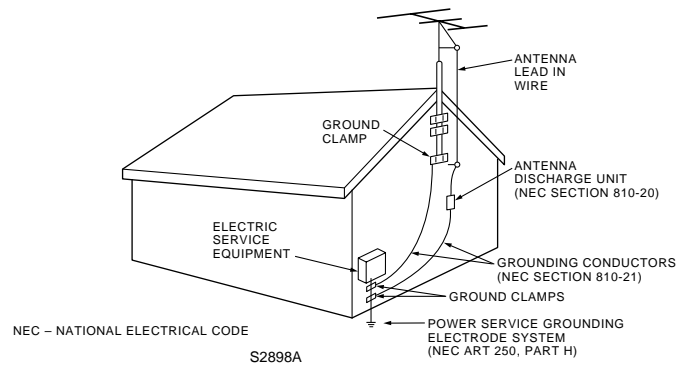

For U.S. model

Note to CATV system installer:

This reminder is provided to call the CATV system installer's attention to Article 820-40 of the NEC, ANSI/NFPA 70, which provides guidelines for proper grounding and, in particular, specifies that the cable ground shall be connected to the grounding system of the building, as close to the point of cable entry as practical.

FCC Information for User

CAUTION:

The user changes or modifications not expressly approved by the party responsible for compliance could void the user's authority to operate the equipment.

NOTE:

This equipment has been tested and found to comply with the limits for a Class B digital device, pursuant to Part 15 of the FCC Rules. These limits are designed to provide reasonable protection against harmful interference in a residential installation. This equipment generates, uses and can radiate radio frequency energy and, if not installed and used in accordance with the instructions, may cause harmful interference to radio communications. However, there is no guarantee that interference will not occur in a particular installation. If this equipment does cause harmful interference to radio or television reception, which can be determined by turning the equipment off and on, the user is encouraged to try to correct the interference by one or more of the following measures:

- Reorient or relocate the receiving antenna.
- Increase the separation between the equipment and receiver.
- Connect the equipment into an outlet on a circuit different from that to which the receiver is connected.
- Consult the dealer or an experienced radio/TV technician for help.

For Canadian model

CAUTION: THIS DIGITAL APPARATUS DOES NOT EXCEED THE CLASS B LIMITS FOR RADIO NOISE EMISSION FROM DIGITAL APPARATUS SET OUT IN THE RADIO INTERFERENCE REGULATIONS OF THE CANADIAN DEPARTMENT OF COMMUNICATIONS.

For models having a power cord with a polarized plug:

CAUTION: TO PREVENT ELECTRIC SHOCK, MATCH WIDE BLADE OF PLUG TO WIDE SLOT, FULLY INSERT.

Modele pour les Canadien

ATTENTION: L'INTERFÉRENCE RADIO ÉLECTRIQUE GÉNÉRÉE PAR CET APPAREIL NUMÉRIQUE DE TYPE B NE DÉPASSE PAS LES LIMITES ÉNONCÉES DANS LE RÈGLEMENT SUR LES PERTURBATIONS RADIO ÉLECTRIQUES, SECTION APPAREIL NUMÉRIQUE, DU MINISTÈRE DES COMMUNICATIONS.

Sur les modèles dont la fiche est polarisée:

ATTENTION: POUR ÉVITER LES CHOCs ÉLECTRIQUES, INTRODUIRE LA LAME LA PLUS LARGE DE LA FICHE DANS LA BORNE CORRESPONDANTE DE LA PRISE ET POUSSER JUSQU'AU FOND.

Contents

Before using		Setting OSD menu	
Important Safeguards	2	The On-Screen Display (OSD) menu	28
Precautions	3	Navigating through the OSD menu	29
Contents	4	Speaker Setup	30
Supplied accessories	5	1. Speaker Setup menu	30
Features	6	1-1. Speaker Config sub-menu	30
Before using remote controller	7	1-2. Speaker Distance sub-menu	31
Installing the remote controller batteries	7	1-3. Level Calibration sub-menu	32
Using the remote controller	7	1-4. Bass Peak Level sub-menu	33
Facilities and connections		1-5. LFE Level Setup sub-menu	33
Front panel facilities	8	Input Setup	34
Front panel	9	2. Input Setup menu	34
Lower buttons in the front door	9	2-1. Digital Setup sub-menu	34
Front panel display	10	2-2. Multichannel Setup sub-menu	36
Remote controller	11	2-3. Video Setup sub-menu	36
Rear panel facilities	12	2-4. Listening Mode Preset sub-menu	37
Example of how to connect your equipment	16	Input source signals	38
Standard connections	17	Listening Modes	38
Connecting your audio components	18	2-5. Delay sub-menu	40
Connecting your video components	18	2-6. Sound Effect sub-menu	40
Connecting speakers	20	2-7. Character Input sub-menu	41
Ideal speaker configuration	20	2-8. Miscellaneous Setup	41
Minimum speaker configuration for		Listening Mode Setup	42
surround sound playback	20	3. Listening Mode Setup menu	42
Speaker placement	20	Description listening mode parameters	44
Connecting speakers	21	Preference	46
Connecting the speaker cable	21	4. Preference menu	46
Connecting a subwoofer	21	4-1. Volume Setup sub-menu	46
Connecting antennas	22	4-2. OSD Setup sub-menu	47
Connecting the included antennas	22	4-3. OSD Tweak	47
Assembling the AM loop antenna	22	Zone2 OSD Setup	48
Connecting the AM antenna cable	22	5. Zone2 OSD Setup menu	48
Connecting an FM outdoor antenna	23	About	48
Connecting an AM outdoor antenna	23	6. About menu	48
Directional linkage	23	6-1. Lock Setup sub-menu	48
Connecting the antenna cable to		6-2. Version	48
the 75/300 Ω antenna adapter (not included)	23	Enjoying music or videos	
Connecting to the IR IN ZONE 2 input	24	Enjoying music or videos in the remote zone ..	49
Outline	24	Controlling the TX-DS989 from the remote zone	49
Connecting the main and remote zones	24	Controlling the TX-DS989 without the remote controller ..	49
Connecting to the IR IN MAIN input	25	Listening to Radio Broadcasts	50
Outline	25	Listening to FM/AM Radio Stations	50
Connecting a graphic equalizer and power		Tuning into a radio station	50
amplifiers	26	Presetting a radio station	51
Connecting a graphic equalizer	26	Selecting a preset radio station	51
Connecting power amplifiers	26	Erasing a preset radio station	51
Connecting the power	27	Enjoying music or videos with the TX-DS989 ...	52
Connecting the power	27	Selecting an input source	52
		Adjusting the volume	52
		Changing the listening mode	52
		Listening with headphones	52
		Using the many features of the TX-DS989	52
		If one of the messages shown below appears	53
		Enjoying the multichannel output	53

Contents

Recording a source	54
To record the input source signal you are currently watching or listening to	54
To record an input source signal different from that you are currently watching or listening to	55
Recording the video from one source and the audio from another	55

Remote controller

Using remote controller	56
Overview	56
Using the remote controller to control each device	56
Controlling the TX-DS989	56
Controlling an Onkyo CD player	58
Controlling an Onkyo MD recorder	58
Controlling an Onkyo cassette tape deck	59
Calling up a preset radio station	59
Controlling an Onkyo DVD player	60
SAT, CABLE, VCR, and TV MODE buttons	60
Programming the commands of remote controllers for other devices into the remote controller	61
Programming procedure	61
Erasing the programmed command from one button	63
Erasing all the commands programmed under a MODE button	63

Using a Macro function	64
What is a Macro function?	64
Programming a Macro function	64
Running a Macro function	64
Programming the Direct Macro function	65
Running a Direct Macro function	65
Erasing a macro from the MODE MACRO button	66
Erasing a direct macro from the DIRECT MACRO button	66
Erasing all commands and macros that have been programmed	67

Appendix

Troubleshooting guide	68
POWER	68
SPEAKERS	68
FM/AM TUNER	69
VIDEO and AUDIO	69
REMOTE CONTROLLER	69
OTHER	70
The default settings	71
Your system setting	72
Inputs	72
Speakers	74
OSD Setup	74
ZONE2	74
About	74
Remote controller	75
(Macro mode programming memo	67)
Specifications	76

Supplied accessories

Check that the following accessories are supplied with the TX-DS989.

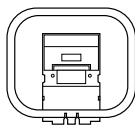

AM loop antenna × 1

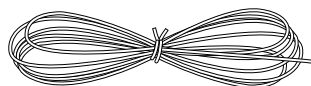

T-shaped FM antenna × 1

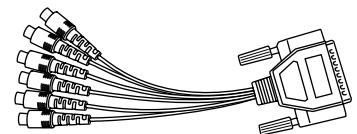

DB-25 ↔ RCA 6ch cable × 1

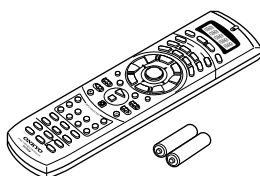

Remote controller × 1
Batteries (AA, R6, or UM-3) × 2

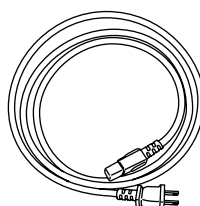

Power cord × 1

Features

■ AMPLIFIER FEATURES

130 WATTS MINIMUM OF CONTINUOUS RMS POWER to each of the 7 channels into 8 Ω , from 20 Hz to 20 kHz with no more than 0.05% THD (FTC rating)—clean high-current amplification provides incredible dynamic range for seamless reproduction of even the most demanding cinema soundtracks, as well as animatedly rich music at any volume level.

7.1-CHANNEL AMPLIFIER—the first receiver to achieve this feat in one chassis—the TX-DS989 provides unparalleled power and clarity to all 7.1-channels for a room-filling sound experience seconds to none.

LUCASFILM THX® ULTRA CERTIFIED—in addition to the amazing ability to drive 7.1 channels, the TX-DS989 also boasts the distinction of carrying the exclusive THX Ultra badge of approval—assurance that this receiver passed (and often exceeds) THX's numerous requirements in such areas as frequency response, distortion, power output, and stability.

192kHz/24-BIT D/A CONVERTERS FOR ALL CHANNELS—the first receiver in the industry to utilize these powerful converters for all seven channels—the TX-DS989's DACs not only boast a dynamic range of 120dB, they also process more information faster and are virtually resistant to clock jitter, to ensure the best performance possible from DVD-Audio and other upcoming formats, while also producing cleaner, clearer sound from DVDs and CDs.

■ WIDE RANGE AMPLIFIER TECHNOLOGY (WRAT)

WRAT virtually eliminates the adverse effects of counter-electromotive force by: 1) applying an uncommonly low amount of NFB (negative feedback), 2) using carefully selected, high-tolerance, wide range parts in all critical sections, and 3) incorporating innovative circuit topology based upon decades of high-end amplifier-design experience—the final result is a flat response beyond 100kHz, making the TX-DS989 ideal for such high-resolution formats as DVD-Audio and Super Audio CD, and other upcoming digital formats.

■ FLEXIBILITY FEATURES

FUTURE-PROOF INTERFACE ARCHITECTURE—a versatile RS232 port allows the TX-DS989's powerful 4Mbit Flash Memory to be directly computer accessed for installing such future upgrades as new DSP algorithms, new surround formats/parameters, and other types of processing updates.

ZONE 2 MULTIROOM/MULTISOURCE CAPABILITY—a full set of line outs for audio, composite video, and S-video, allows for set-up of an additional system in another room—connect an optional infrared eye in Zone 2, and complete second-room control can be achieved with such A/V distribution control systems as Xantech®, Niles®, to name but a few.

■ AUDIO/VIDEO FEATURES

THX SURROUND EX® BUILT IN to decode the additional two back surround channels from THX Surround EX-encoded DVDs and laserdiscs, for incredibly real 360° surround sound effects and precise sound location.

DTS® DECODER BUILT IN to decode the impeccable 5.1-channel digital audio from DTS-encoded DVD-Video discs, DVD-Audio discs, CDs and laserdiscs.

DOLBY® DIGITAL DECODER BUILT IN to decode the 5.1-channel crystal-clear digital audio of DVDs, Digital TV, HDTV, satellite broadcasts and other sources.

■ DOLBY® PRO LOGIC™ DECODER

MPEG DECODEING for full compatibility with MPEG-encoded software and broadcasts.

DIGITAL UPSAMPLING MODE—the first receiver to have 192kHz/24-bit DACs for all channels enables the TX-DS989 to take a 48kHz digital signal and double its sampling frequency to 96kHz—twice as much signal information, for greater detail and clarity.

■ THEATER-DIMENSIONAL™ VIRTUAL SURROUND MODE

A/V SYNC DELAY

LUCASFILM THX® ULTRA FULL-ENHANCEMENT PACKAGE—includes such sophisticated DSP enhancements as Cinema Re-EQ™, Timbre Matching™, Adaptive Decorrelation™, and Bass Management™ to ensure accurate reproduction of the movie-theater experience in the home.

■ 7.1-CHANNEL EXTERNAL INPUTS

■ COMPONENT VIDEO OUTPUTS

■ OTHER FEATURES

40 FM/AM RANDOM PRESETS

INTELLIVOLUME

ABSOLUTE/RELATIVE SWITCHABLE VOLUME DISPLAY

* Manufactured under license from Dolby Laboratories. "Dolby", "Pro Logic" and the double-D symbol  are trademarks of Dolby Laboratories. Confidential Unpublished Works. ©1992-1997 Dolby Laboratories, Inc. All rights reserved.

• Theater-Dimensional and the symbol  are trademarks of ONKYO CORPORATION.

• Lucasfilm, THX, THX Ultra and THX Surround EX are registered trademarks of Lucasfilm LTD.

• Re-Equalization and the "Re-EQ" logo are trademarks of Lucasfilm Ltd. Manufactured under license of Lucasfilm Ltd.

• Manufactured under license from Digital Theater Systems, Inc. US Pat. No.5,451,942 and other worldwide patents issues and pending. "DTS" and "DTS Digital Surround" are trademarks of Digital Theater Systems, Inc. © 1996 Digital Theater Systems, Inc. All rights reserved.

• Xantech is a registered trademark of Xantech Corporation.

• Niles is a registered trademark of Niles Audio Corporation.

THX Ultra

Before any home theatre component can be THX Ultra certified, it must pass a rigorous series of quality and performance tests. Only then can a product feature the THX Ultra logo, which is your guarantee that the Home Theatre products you purchase will give you superb performance for many years to come. THX Ultra requirements define hundreds of parameters, including power amplifier performance, and pre-amplifier performance and operation for both digital and analog domains. THX Ultra receivers also features proprietary THX technologies (e.g. THX Mode, see page 38) which accurately translate film soundtracks for home theater playback.

Before using remote controller

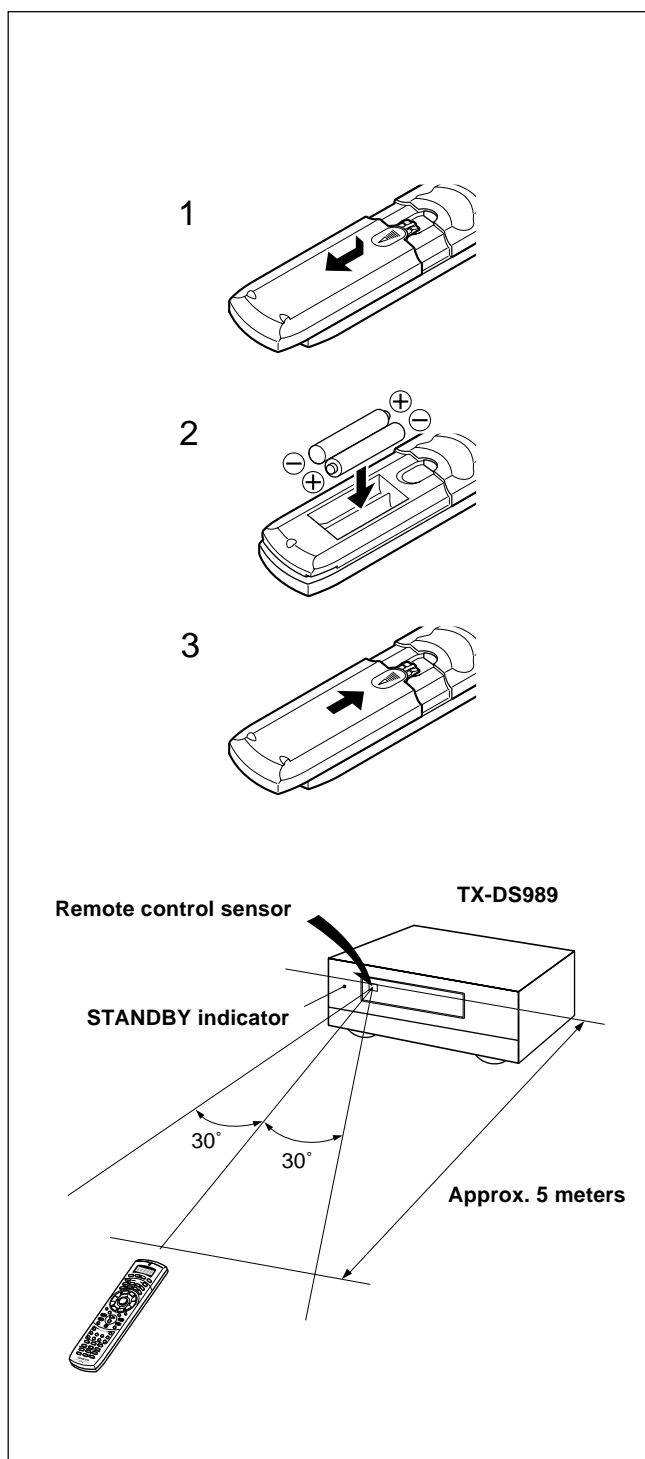

Installing the remote controller batteries

1. Remove the battery compartment cover by pressing the tab and sliding the cover.
2. Insert two AA (R6 or UM-3) batteries into the battery compartment. Carefully follow the polarity diagram (positive (+) and negative (-) symbols) inside the battery compartment.
3. After batteries are installed and seated correctly, replace the compartment cover.

Notes:

- Do not mix new batteries with old batteries or different kinds of batteries.
- To avoid corrosion, remove the batteries if the remote controller is not to be used for a long time.
- Remove dead batteries immediately to avoid damage from corrosion. If the remote controller does not operate smoothly, replace both the batteries at the same time.
- The life of the batteries supplied is about six months but this will vary depending on usage.

Using the remote controller

Point the remote controller toward the remote control sensor. The STANDBY indicator lights up when the unit receives a signal from the remote controller.

Notes:

- Place the unit away from strong light such as direct sunlight or inverted fluorescent light which can prevent proper operation of the remote controller.
- Using another remote controller of the same type in the same room or using the unit near equipment which uses infrared rays may cause operational interference.
- Do not put objects on the remote controller. The buttons of the remote controller may be pressed by mistake and drain the batteries.
- Make sure the audio rack doors do not have colored glass. Placing the unit behind such doors may prevent proper remote controller operation.
- If there is any obstacle between the remote controller and the remote control sensor, the remote controller will not operate.

Memory preservation

This unit does not require memory preservation batteries. A built-in memory power backup system preserves the contents of the memory during power failures and even when the POWER switch is set to off. The POWER switch must be set to on in order to charge the backup system.

The memory preservation period after the unit has been turned off varies depending on climate and placement of the unit. On the average, memory contents are protected over a period of a few weeks after the last time the unit has been turned off. This period is shorter when the unit is exposed to a highly humid climate.

Front panel facilities

Here is an explanation of the controls and displays on the front panel of the TX-DS989.

Front panel

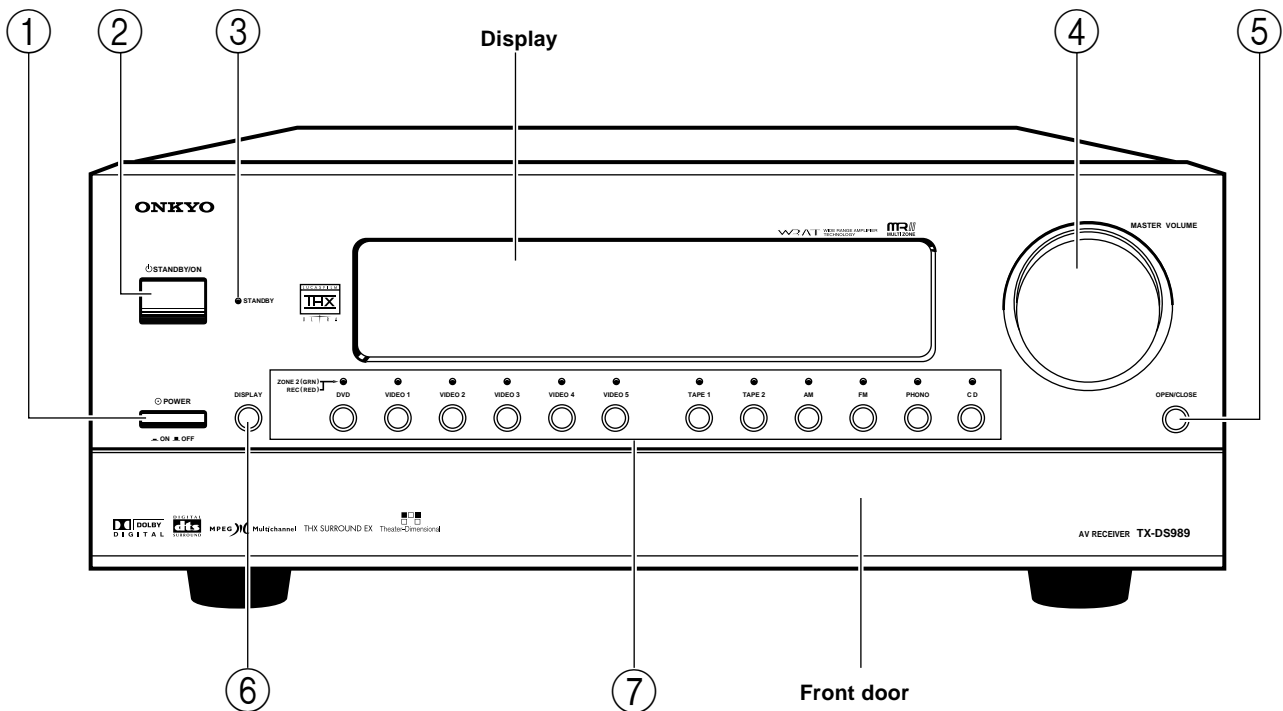

Lower buttons in the front door

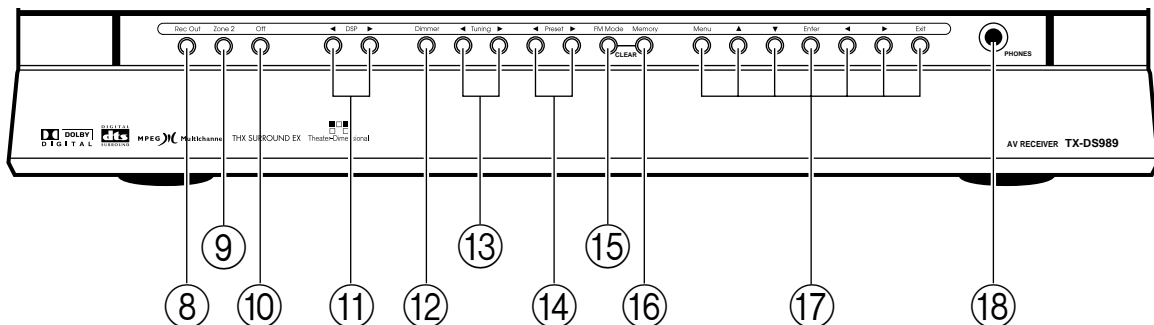

Front panel display

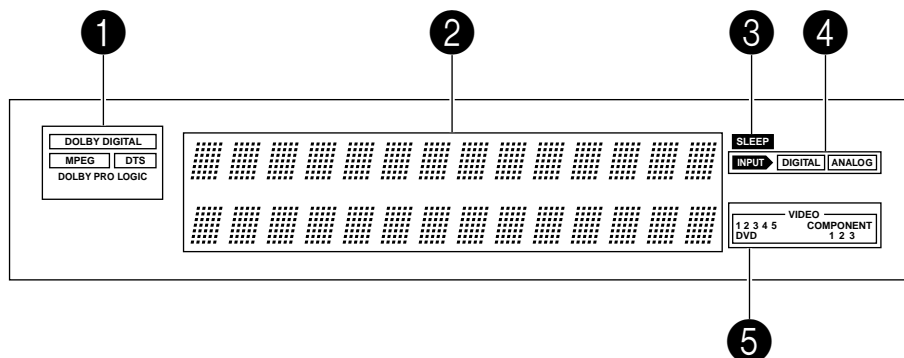

Front panel facilities

Front panel

1 POWER

After plugging in the power cord into the rear panel and wall outlet, pressing this button connects the TX-DS989 to the AC mains and turns it on.

- Before turning on the power, make sure all cables are properly connected.
- Turning on the TX-DS989 may cause a momentary power surge that might interfere with other electrical equipment on the same circuit. If this is a problem, plug the TX-DS989 into a different electrical circuit.

2 STANDBY/ON

Pressing this button while the main power is turned on the STANDBY indicator lights up and the front display turns off. Pressing it again returns it to the standby state. This state turns off the display, disables control functions, and turns off all outputs to the main zone (those for the remote zone remain available).

3 STANDBY indicator

4 MASTER VOLUME

The MASTER VOLUME knob is used to control the volume for the main zone. The volume for the remote zone (Zone 2) is independent.

5 OPEN/CLOSE

Press this button to open and close the front door that covers the lower buttons.

6 DISPLAY

The DISPLAY button is used to display information about the current input source signal. Each time you press the display button, the screen changes to show you different information concerning the input signal. The screen changes as follows:

Program format → Sampling frequency → Digital input → Digital format → Bass level → Treble level.

If the input source signal does not have any information for a particular screen, then that screen will be skipped.

- **Displaying the data of the current input source**
Each display is explained below.

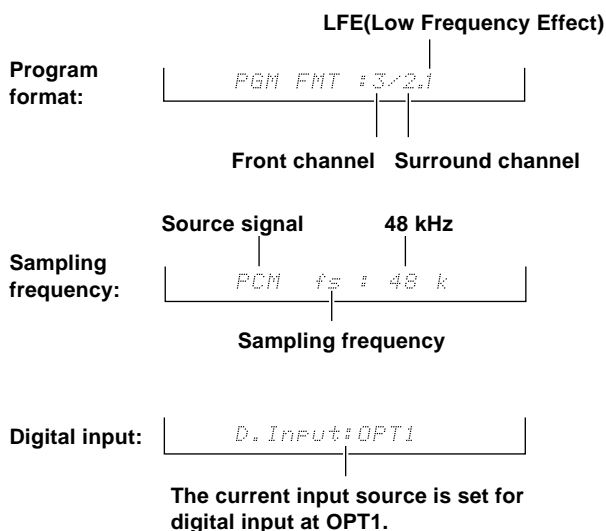

Digital format: D. FMT : Auto

The current input source is set for a digital format of "Auto."

Bass level: Bass : +2

The current bass level is +2.

Treble level: Treble : -2

The current treble level is -2.

7 Input Source Buttons (DVD, VIDEO 1-5, TAPE 1-2, AM, FM, PHONO, and CD)

These buttons are used to select the input source for the main zone. When an input source is selected, the indicator will light in orange. To select the input source for the remote zone (Zone 2) or recording out (Rec Out), first press the Zone 2 or Rec Out button, and then the desired input source button.

Lower buttons in the front door

Caution:

The front door of the receiver is motorized. Use the open/close button to open or close the door. Manually opening or closing the door, or moving the receiver while holding the door, will cause the door to malfunction or break.

8 Rec Out

Press the Rec Out button to output to a recording component for recording purposes. After pressing the Rec Out button, press one of the input source selector buttons within 8 seconds to select the component to record to. When one is selected, the indicator above that button will light in red. To record from the same input source that you are using (that is selected for the main zone), press the Rec Out button twice in succession.

Note:

The Rec Out and Zone 2 buttons use the same circuit and therefore cannot be used at the same time.

When Rec Out is selected, nothing is output from Zone 2.

9 Zone 2

The TX-DS989 includes a second signal path separate from the main one that can be used for a remote zone (Zone 2) or for making recordings. By connecting an additional amplifier or other video equipment to the Zone 2 outputs, you can output to a separate room an input source that is different from that being used in the main room. This allows you to watch one program in one room while somebody else is watching a different program in another.

Press the Zone 2 button to enable output to the ZONE 2 outputs. After pressing the Zone 2 button, press one of the input source selector buttons within 8 seconds to select the input source for the remote zone. When one is selected, the indicator above that button will light in green. To use the same input source for the both the main and remote zones, press the Zone 2 button twice in succession.

Note:

The Rec Out and Zone 2 buttons use the same circuit and therefore cannot be used at the same time.

When Zone 2 is selected, the currently selected input source is output from the recording terminal.

Front panel facilities

⑩ Off

When not using either Rec Out or Zone 2, press that button and then press the Off button to turn off the signal. If the Rec Out or Zone 2 signal is turned on and the connected component is not turned on, the electric signal will still be sent through the circuitry and the excess load may cause deterioration of the audio signal.

⑪ ◀ DSP ▶

Press these buttons to scroll through the listening modes and set a new one for the input source you are currently listening to. For each different input signal, different listening modes are possible. See page 38 for a detailed explanation of the different listening modes.

⑫ Dimmer

Press to set the brightness of the front display. There are 4 settings available: normal, dark, very dark, and off.

- The dimmer control for the front display can be performed at the remote controller.

⑬ ◀ Tuning ▶

Use these buttons to change the tuner frequency. The tuner frequency is displayed in the front display and it can be changed in 50 kHz increments for FM and 10 kHz increments for AM. When a station is tuned into, "> <" or "▶ ◀" will appear in the front display.

When FM is selected, you can hold down one of the tuning buttons and then release it to activate the auto-search feature. It will search for a station in the direction of the button you pressed and stop when it tunes into one.

⑭ ◀ Preset ▶

When AM or FM is selected as the input source, press one of these buttons to jump to a radio station that you preset using the MEMORY button. Pressing the right button moves from the most recently preset station to older ones, and pressing the left button moves in the reverse order.

⑮ FM Mode

If you are listening to an FM radio station in stereo and the sound cuts out or there is a great deal of noise, then press this button. The "MONO" display will appear and the output will change to mono. Though you will not hear the audio in stereo, this may stop the sound from cutting out and reduce excess noise.

⑯ Memory

This button only operates when FM or AM is selected as the input source. This button allows you to preset frequencies for stations when using the FM/AM tuner. You can preset up to 40 stations (or frequencies) to be used with the PRESET buttons.

⑰ Menu, ▲, , Enter, ◀, ▶, Exit

These buttons are used with the On Screen Display (OSD) menu. They also perform the same functions as the OSD MENU, ▲ (upper edge of ENTER button), ▼ (lower edge of ENTER button), ◀ (left edge of ENTER button), ▶ (right edge of ENTER button), ENTER, and EXIT RETURN buttons on the remote controller.

Menu: Press to bring up the OSD menu.

Exit: Press to exit the OSD menu when at the Menu Screen, or move to one screen previous to the one that is displayed if at any other screen.

▲ and ▼: When selecting items in the OSD Menu, press these buttons to move the on-screen cursor (or the highlighted portion) upward and downward.

◀ and ▶: When setting parameters in the OSD menu, press these buttons to select parameter values or modes.

Enter: Press to display the screen for the selected item in the OSD Menu.

⑱ PHONES

This is a standard stereo jack for connecting stereo headphones. The audio for the front right and left speakers are sent to the headphone speakers. When the headphones are plugged in, the listening mode automatically changes to stereo and output to the speakers is stopped.

Front panel display

- ① Listening mode or digital input format indicators
- ② Multi function display
- ③ Sleep indicator
- ④ Input source format indicator
- ⑤ Video display

Remote controller

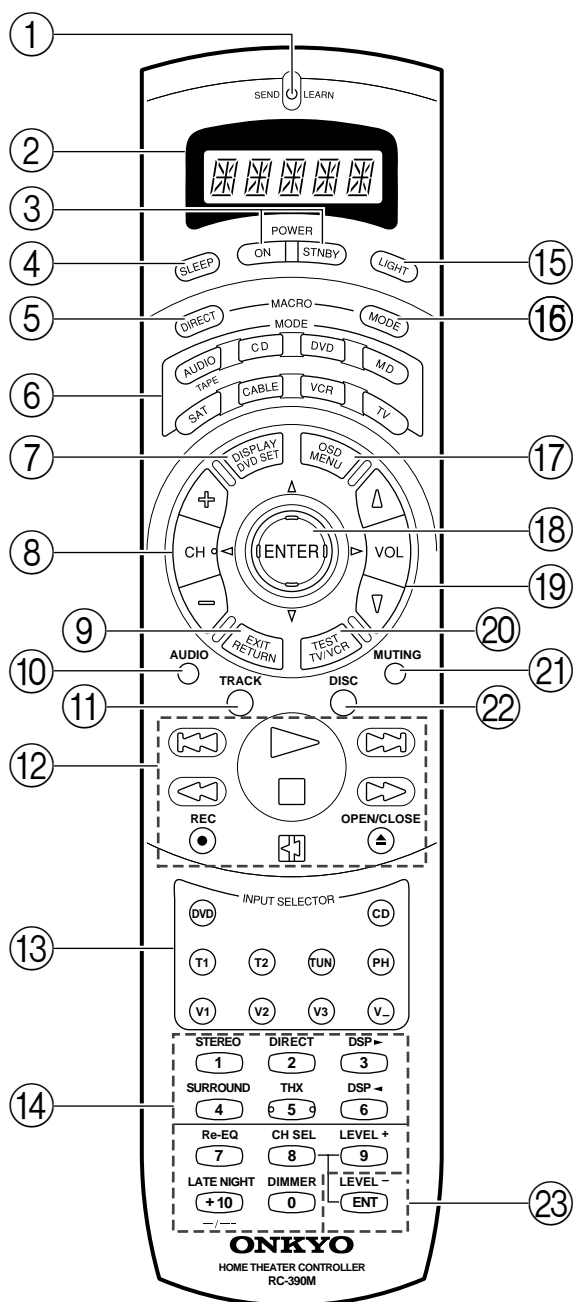

For a more detailed explanation of how to use the remote controller, refer to pages 56 through 67.

- ① **SEND/LEARN indicator**
- ② **LCD display**
- ③ **POWER ON/STNBY button**
Be aware that pressing the STNBY button only places the TX-DS989 in standby and does not turn the power completely off.
- ④ **SLEEP button**
- ⑤ **DIRECT MACRO button**
- ⑥ **MODE buttons**
- ⑦ **DISPLAY/DVD SET button**
- ⑧ **CH +/- buttons**
- ⑨ **EXIT/RETURN button**
- ⑩ **AUDIO button**
- ⑪ **TRACK button**
- ⑫ **CD/TAPE/DVD/MD operation buttons**
- ⑬ **Input Selector buttons**
- ⑭ **Numeric key/STEREO/DIRECT/THX/DSP </>/SURROUND/Re-EQ/LATE NIGHT/CH SEL/LEVEL+,-/DIMMER buttons**
- ⑮ **LIGHT button**
- ⑯ **MODE MACRO button**
- ⑰ **OSD/MENU button**
- ⑱ **ENTER/cursor buttons**
- ⑲ **VOL Δ/∇ button**
- ⑳ **TEST/TV/VCR button**
- ㉑ **MUTING button**
- ㉒ **DISC button**
- ㉓ **ENT button**

Rear panel facilities

Here is an explanation of the terminals found on the rear of the TX-DS989 and how they are used. Before connecting your audio and video components, be sure to read this section carefully and then proceed to the explanations on how to connect each individual component (see pages 16).

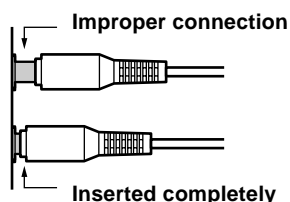

- Be sure to always refer to the instructions that came with the component that you are connecting.
- Do not plug in the power cord until all connections have been made.
- For input jacks, red connectors (marked R) are used for the right channel, white connectors (marked L) are used for the left channel, and yellow connectors (marked V) are used for video connection.
- Insert all plugs and connectors securely. Improper connections can result in noise, poor performance, or damage to the equipment.
- Do not bind audio/video connection cables with power cords and speaker cables. Doing so may adversely affect the picture and sound quality.

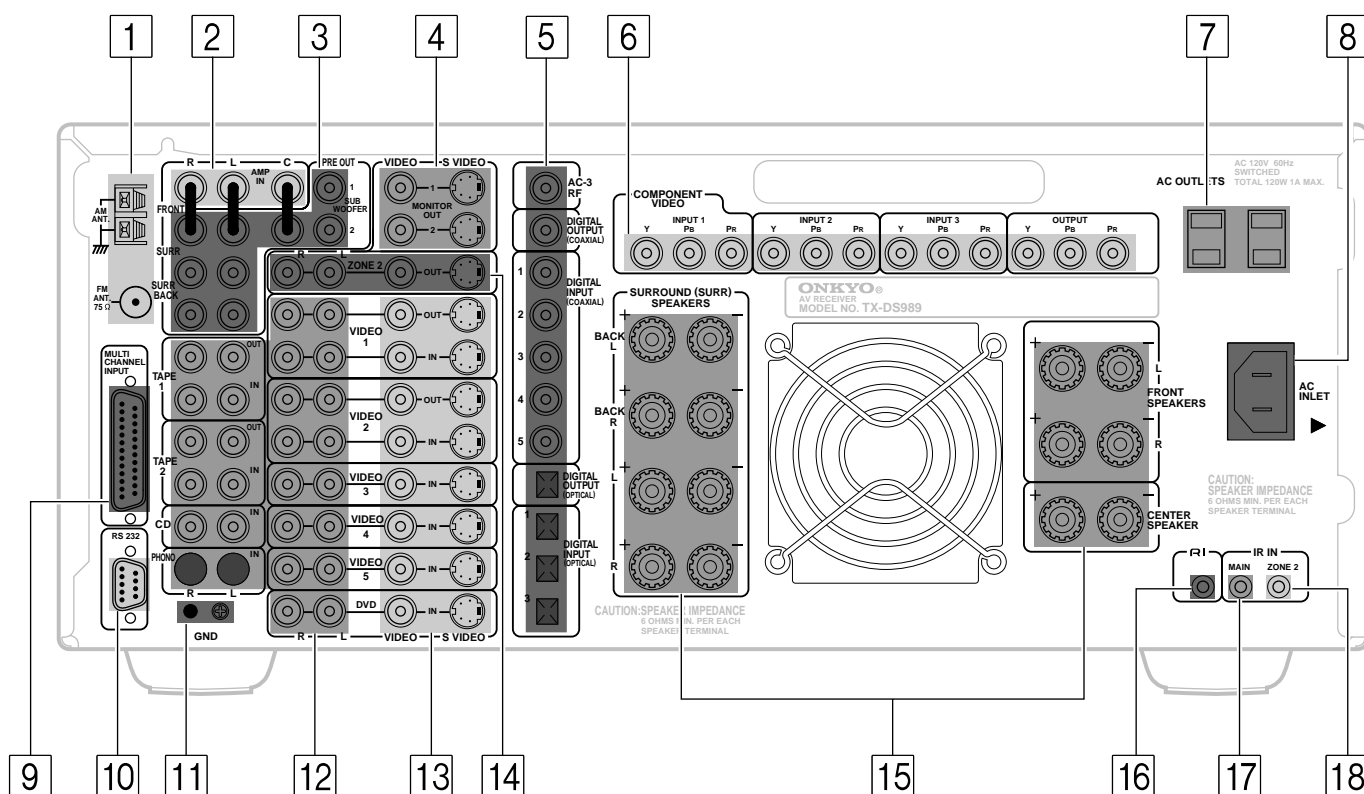

Rear panel facilities

1 ANTENNA

These jacks are for connecting the FM indoor antenna and AM loop antenna that are supplied with the TX-DS989.

2 AMP IN

These jacks are for connecting a graphic equalizer for further control of the audio output.

- When connecting a graphic equalizer, remove the attached jumper plugs and store them carefully so as not to lose them.
- Only remove the jumper plugs when required. After you finish using an AMP IN jack, replace the jumper plug.

3 PRE OUT

These jacks are for connecting auxiliary power amplifiers.

- When connecting auxiliary power amplifiers, remove the attached jumper plugs and store them carefully so as not to lose them.
- Only remove the jumper plugs when required. After you finish using a PRE OUT jack, replace the jumper plug.

4 MONITOR OUT

There are 2 monitor outputs and each one includes both composite video and S-video configurations. When connecting two video monitors or televisions, be aware that the OSD interface can only be used with MONITOR OUT 1 (OSD will not be displayed on the video monitor connected to MONITOR OUT 2).

5 DIGITAL INPUT/OUTPUT (coaxial, optical, and input-only AC-3RF)

These are the digital audio inputs and outputs. There are 5 digital inputs with coaxial jacks, 3 with optical jacks, and 1 AC-3RF input. The inputs accept digital audio signals from a compact disc, LD, DVD, or other digital source component. For digital output, there is 1 coaxial output and 1 optical output. The digital outputs can be connected to MD recorders, CD recorders, DAT decks, or other similar components.

COAXIAL Coaxial cable

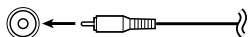

AC-3RF Coaxial cable

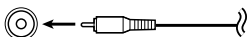

OPTICAL Optical fiber cable

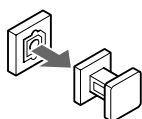

Optical digital input terminal

An optical digital input terminal is equipped with a protection cap. When connecting, remove this cap. When not using, put the cap back on the terminal.

- When using the digital inputs and outputs, make sure to also connect the analog connections whenever possible.
- When using one of the optical input or output jacks, remove the protective cap and keep it safely. When the jack is not used, replace the protective cap.
- When using an optical input or output jack, always use an optical fiber cable.

6 COMPONENT VIDEO INPUT/OUTPUT

If your DVD player or other device has component video connectors, be sure to connect them to these component video connectors on the TX-DS989. The TX-DS989 has three component video input connectors to obtain the color information (Y, Pb, Pr) directly from the recorded DVD signal or other video component and one component video output connector to output it directly into the matrix decoder of the display device. By sending the pure DVD component video signal directly, the DVD signal forgoes the extra processing that normally would degrade the image. The result is vastly increased image quality, with incredibly lifelike colors and crisp detail.

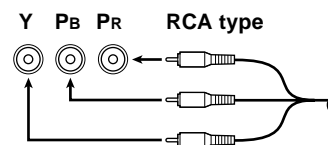

7 AC OUTLETS

The TX-DS989 is supplied with two AC mains outlets for connecting the power cords from other devices so that their power is supplied through the TX-DS989. By doing this, you can use the STANDBY/ON button on the TX-DS989 to turn on and off the connected devices as well.

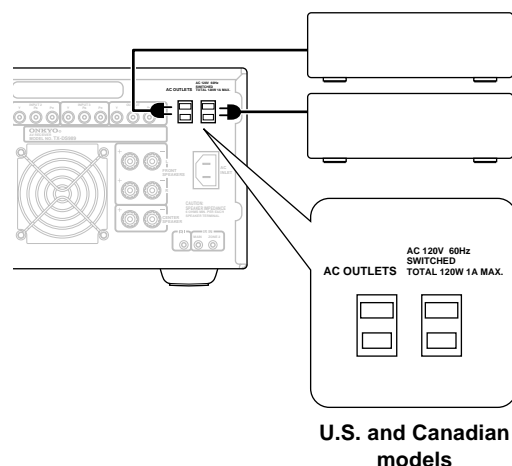

Caution

Make sure that the total capacity of the other components connected to this unit does not exceed the capacity that is printed on the rear panel. For the North American model, the capacity is 120 watts.

Rear panel facilities

8 AC INLET

Plug the supplied power cord into this AC INLET and then into the power outlet on the wall.

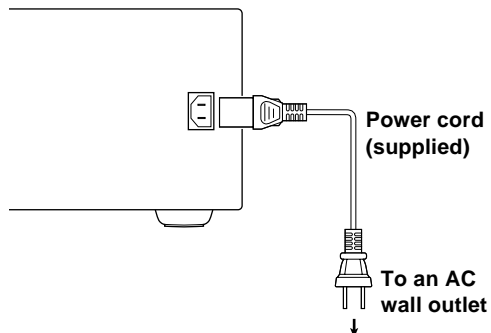

- Do not use a power cord other than the one supplied with the TX-DS989. The power cord supplied is designed for use with the TX-DS989 and should not be used with any other device.
- Never have the power cord disconnected from the TX-DS989 while the other end is plugged into the wall outlet. Doing so may cause an electric shock. Always connect by plugging into the wall outlet last and disconnect by unplugging from the wall outlet first.

9 MULTI CHANNEL INPUT

By connecting a DVD player, MPEG decoder, or other component that has a multi channel port, you can playback the audio with 5.1 channel or 7.1 channel output. So, be sure to prepare a cable that can properly connect the TX-DS989 to the peripheral device.

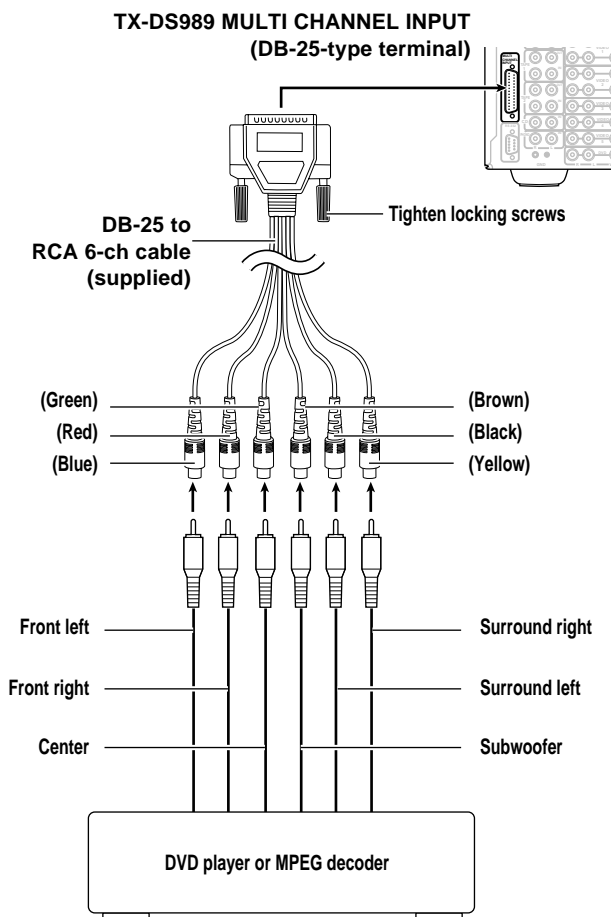

The MULTI CHANNEL INPUT is a DB-25 port and the TX-DS989 is equipped provided with a DB-25-to-RCA 6-channel cable. When making a multi-channel connection to a DVD player or MPEG decoder, connect the DB-25 end of the cable to the MULTI CHANNEL INPUT port on the TX-DS989 and RCA-type ends to the ends of the cables connected to the other component. The channel colors are shown below.

Front left (Blue)
 Front right (Red)
 Center (Green)
 Surround left (Black)
 Surround right (Yellow)
 Subwoofer (Brown)

If the DVD player or MPEG decoder that you are connecting to is provided with DB-25-to-DB-25 cable, then connect that directly to the TX-DS989 and do not use the cable supplied with the TX-DS989. When connecting the cable, be sure to secure the locking screws on the DB-25 connectors.

10 RS 232

The RS 232 port is to be used in conjunction with an external controller to control the operation of the TX-DS989 by using an external device. The RS 232 port may also be used in the future to update the operating software of the TX-DS989 so that it will be able to support new digital audio formats and the like as they are introduced.

11 GND

Use this GND terminal for connecting the ground (or earth) wire if a turntable is connected. Refer to "Connecting a turntable" on page 18.

12 AUDIO IN/OUT

These are the analog audio inputs and outputs. There are 10 audio inputs (6 of which are linked to video inputs) and 4 audio outputs (2 of which are linked to video outputs). The audio jacks are nominally labeled for cassette tape decks, compact disc players, turntables, and DVD players. To the audio jacks for VIDEO 1 to 5, connect the audio output from VCRs, LD players, and other video components. The audio inputs and outputs require RCA-type connectors.

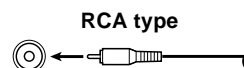

- When using the PHONO jacks, remove the caps that cover them and store them safely where they will not be lost. Whenever the PHONO jacks are not in use, replace the caps on them.
- When connecting a VCR or other video component, make sure you connect the audio and video leads together (i.e., both to VIDEO 3).
- With LD players that have an AC-3RF terminal, connect the audio source to the audio inputs of VIDEO 4 because only it supports the AC-3RF settings during digital setup.
- The TX-DS989 is designed for use with turntables that use moving magnet cartridges.

Rear panel facilities

13 VIDEO IN/OUT

These are the video inputs and outputs. There are 6 video inputs and 2 video outputs and each one includes both composite video and S-video configurations. Connect VCRs, LD players, DVD players, and other video components to the video inputs. S-video sources can be viewed via the S-video or composite outputs, while composite sources can only be viewed through the composite output.

The 2 video output channels can be used to be connected to video tape recorders for making recordings.

Composite video jack



S video jack



- When connecting a VCR or other video component, make sure you connect the audio and video leads together (i.e., both to VIDEO 3).
- With LD players that have an AC-3RF terminal, connect the video source to the video inputs of VIDEO 4 because only it supports the AC-3RF settings during digital setup.

14 ZONE 2

These are the audio and video output jacks for the remote zone (Zone 2). Use these outputs to connect the remote zone. For the connection procedure, refer to "Setting up the remote zone" on page 24. These outputs are activated by the Zone 2 button on the front panel.

15 SPEAKERS

Seven terminals are provided for the front left, front right, front center, surround left, surround right, surround back left, and surround back right speakers. In addition to being able to reproduce the conventional 5.1-channel source input, outputs for surround back left and surround back right speakers have been added for support of the state-of-the-art THX Surround EX.

Speaker outputs are compatible with banana plug connectors .

16 RI (RI)

By connecting the **RI** connector as shown in the diagram below, you can use the RC-390M remote controller to operate Onkyo cassette tape decks and compact disc players that also have Onkyo's **RI** connectors. Simply connect a remote control cable from this connector to the **RI** connector of the cassette tape deck or compact disc player. An **RI** remote control cable with a 3.5-mm (1/8-inch) miniature two-conductor plug comes with every cassette tape deck and compact disc player that has an **RI** connector.

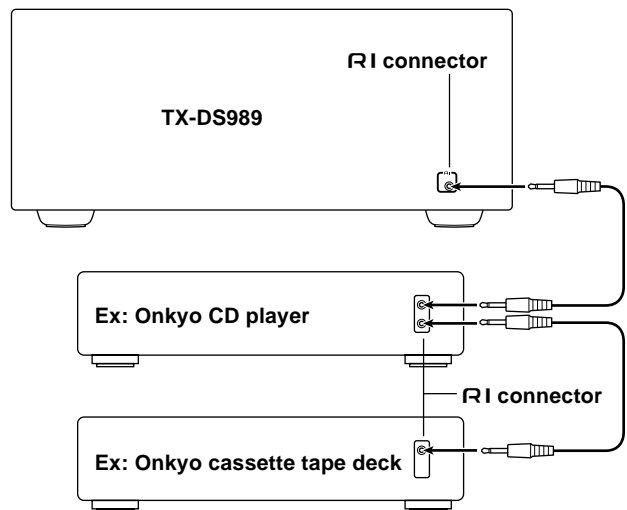

- For remote control operation, the audio connection cables must also be connected.
- The RC-390M remote controller does not support turntables.
- If the connected component has two RI connectors, you can use either one to connect to the TX-DS989. The other one can be used to daisy chain with another component.
- For Onkyo DVD or MD players, you can control them by simply pointing the RC-390M controller directly at the component.

17 IR IN MAIN

If the TX-DS989 is located inside a rack or cabinet that will not allow infrared beams to reach the IR sensor, you will need to connect a remote sensor* to this input to be able to use the remote controller. Then install the remote sensor in an unblocked location where you can easily point the remote controller.

* An optional remote sensor kit is required.

18 IR IN ZONE 2

This jack allows you to connect a multiroom system kit so that you can use the remote controller while you are in the remote zone (Zone 2), which may be far separated from the TX-DS989.

* **To be able to use the remote controller in the remote zone (Zone 2), you must connect one of the following (sold separately):**

- Onkyo's Multi-Room System Kit (IR Remote Controller Extension System).
- A multiroom A/V distribution and control system from Niles®, Xantech®, or the like

Example of how to connect your equipment

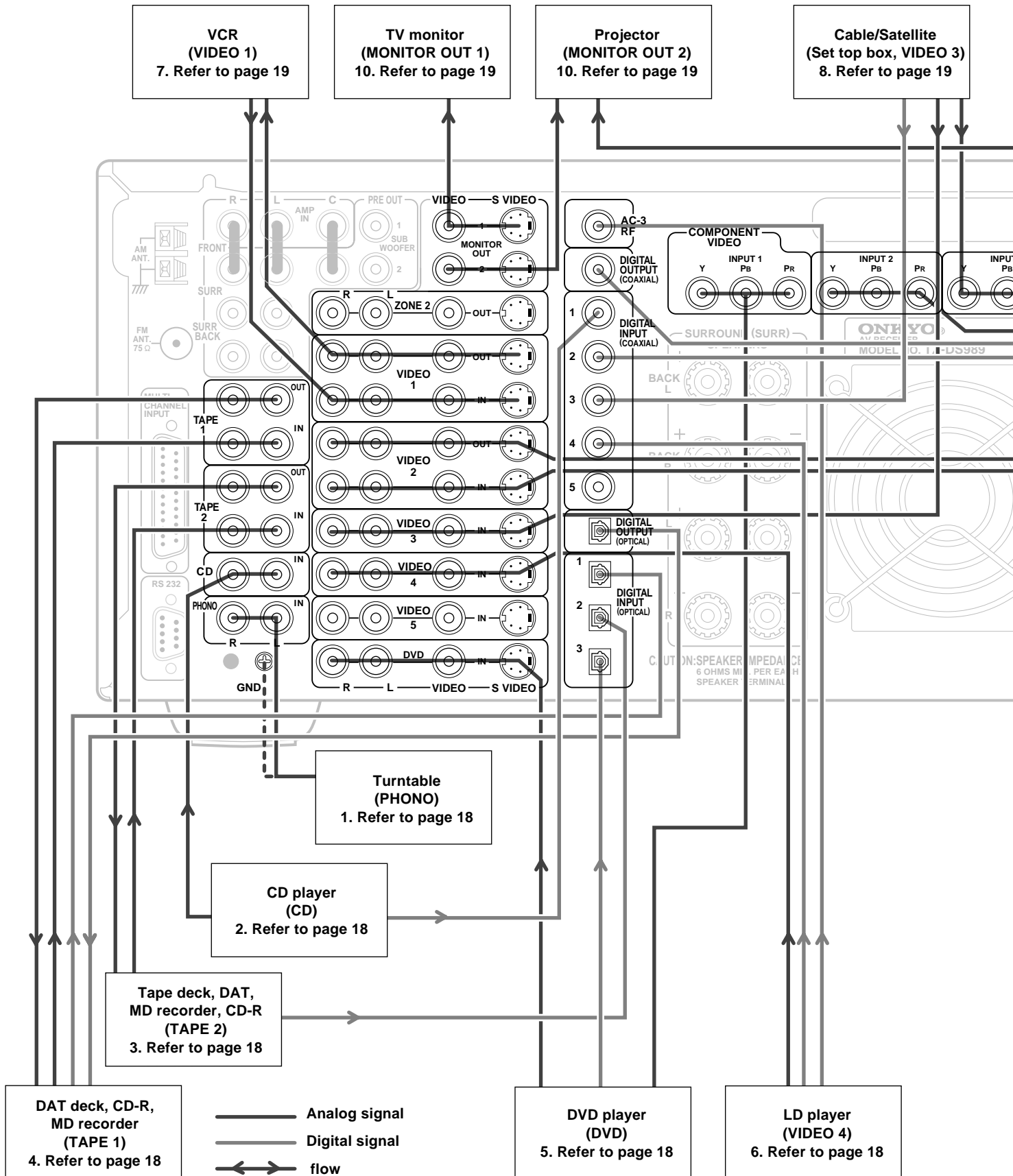

Example of how to connect your equipment

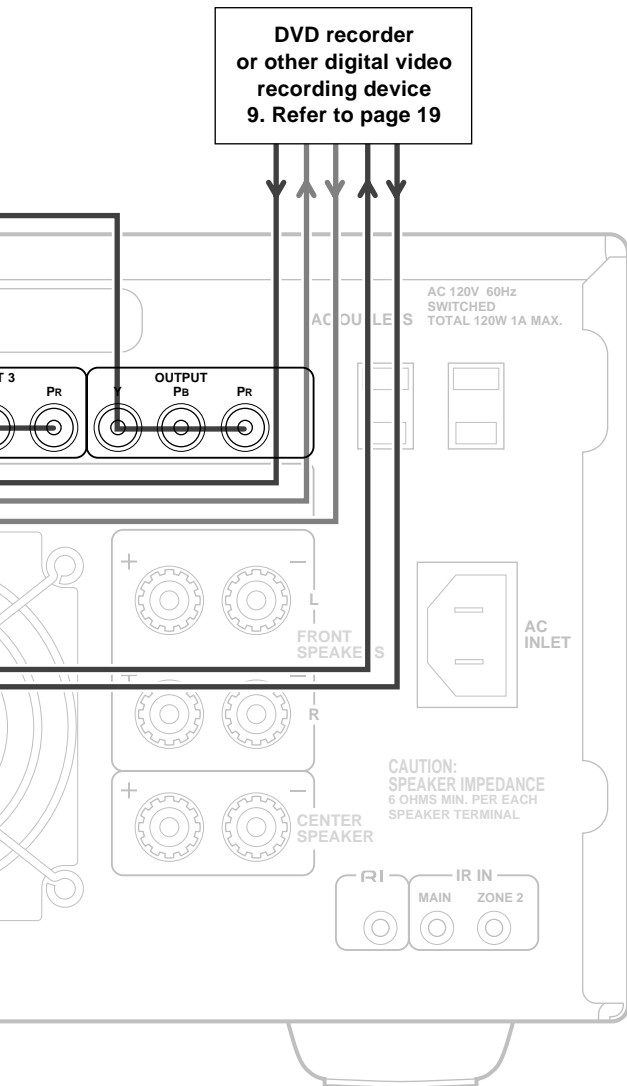

Standard connections

Here is explanation of how to connect the main components to the TX-DS989 in the standard manner. There are many ways that any one component can be connected, and it is up to you to decide which method best fits your situation. The directions given here are only one option and should only be thought of as such. It is best to fully understand the nature of each connector and terminal as well as each of your components and their features to ascertain which method of connection is best.

- Be sure to always refer to the instruction manual that came with the component that you are connecting.
- Do not plug in the power cord until all connections have been made.
- For input jacks, red connectors (marked R) are used for the right channel, white connectors (marked L) are used for the left channel, and yellow connectors (marked V) are used for video connection.
- Insert all plugs and connectors securely. Improper connections can result in noise, poor performance, or damage to the equipment.
- Do not bind audio connection cables with power cords and speaker cables. Doing so may adversely affect the sound quality.

For a detailed explanation of how to connect the devices given below, refer to the pages listed.

Speakers: See page 20

Radio antenna: See page 22

Enjoying the TX-DS989 from a remote room (Zone 2):

See page 24

Graphic equalizer: See page 26

Power amplifier: See page 26

Default setting

Input source	Digital input	Component video
CD	COAXIAL 1	
PHONO		
FM		
AM		
TAPE 1	OPTICAL 1	
TAPE 2	OPTICAL 2	
DVD	OPTICAL 3	COMPONENT VIDEO 1
VIDEO 1	----	----
VIDEO 2	COAXIAL 2	COMPONENT VIDEO 2
VIDEO 3	COAXIAL 3	COMPONENT VIDEO 3
VIDEO 4	COAXIAL 4	----
VIDEO 5	COAXIAL 5	----

---- : No setting

 : No applicable

Example of how to connect your equipment

Connecting your audio components

Below is an example of how you can connect your audio components to the TX-DS989. Refer to the diagram on pages 16 and 17 for the following connection examples.

1. Connecting a turntable

Using an RCA-type audio connection cable, connect the output terminal on the turntable to the PHONO IN jacks on the TX-DS989. Make sure that you properly connect the left channel to the L jack and the right channel to the R jack.

Note:

The TX-DS989 is designed for use with moving magnet cartridges. For proper operation, connect a ground (or earth) wire to the GND terminal. For some turntables, however, connecting the ground wire may cause increased noise, and in such a case, a ground wire is not necessary and should not be connected.

2. Connecting a compact disc player

Using an RCA-type audio connection cable, connect the output terminal on the compact disc player to the CD IN jacks on the TX-DS989. Make sure that you properly connect the left channel to the L jack and the right channel to the R jack.

If the compact disc player has a digital output jack as well, be sure to also connect it to either a DIGITAL INPUT (COAXIAL) or DIGITAL INPUT (OPTICAL) jack on the TX-DS989 depending on the type of connector on the compact disc player.

With the initial settings of the TX-DS989, the CD input source is set for digital input at the COAXIAL 1 jack. If the digital connection is made at a different jack, this must be changed at the OSD Menu: Input Setup → Digital Setup → Digital Input (see page 34).

3. Connecting a cassette tape deck, MD recorder, DAT deck, or CD recorder

Using an RCA-type audio connection cable, connect the output terminals (PLAY) of the device to the TAPE 2 IN jacks on the TX-DS989 and the input terminals (REC) to the TAPE 2 OUT jacks. Make sure that you properly connect the left channel to the L jack and the right channel to the R jack.

If the device has a digital output jack as well, be sure to also connect it to either a DIGITAL INPUT (COAXIAL) or DIGITAL INPUT (OPTICAL) jack on the TX-DS989 depending on the type of connector on the device.

With the initial settings of the TX-DS989, the TAPE 2 input source is set for digital input at the OPTICAL 2 jack. If the digital connection is made at a different jack, this must be changed at the OSD Menu: Input Setup → Digital Setup → Digital Input (see page 34).

If the device also has a digital input jack, it can be connected to the DIGITAL OUTPUT (COAXIAL) or DIGITAL OUTPUT (OPTICAL) jack on the TX-DS989 for recording of the signal from the input source selected at the TX-DS989.

4. Connecting an MD recorder, DAT deck, or CD recorder

Using an RCA-type audio connection cable, connect the output terminals (PLAY) of the device to the TAPE 1 IN jacks on the TX-DS989 and the input terminals (REC) to the TAPE 1 OUT jacks. Make sure that you properly connect the left channel to the L jack and the right channel to the R jack.

If the device has a digital output jack as well, be sure to also connect it to either a DIGITAL INPUT (COAXIAL) or DIGITAL INPUT (OPTICAL) jack on the TX-DS989 depending on the type of connector on the device.

With the initial settings of the TX-DS989, the TAPE 1 input source is set for digital input at the OPTICAL 1 jack. If the digital connection is made at a different jack, this must be changed at the OSD Menu: Input Setup → Digital Setup → Digital Input (see page 34).

If the device also has a digital input jack, it can be connected to the DIGITAL OUTPUT (COAXIAL) or DIGITAL OUTPUT (OPTICAL) jack on the TX-DS989 for recording of the signal from the input source selected at the TX-DS989.

Connecting your video components

Below is an example of how you can connect your video components to the TX-DS989. Refer to the diagram on pages 16 and 17 for the following connection examples.

The flow of the video signals is as follows: the signal that comes in from VIDEO IN is sent to VIDEO OUT, the signal that comes in from S-VIDEO IN is sent to S-VIDEO OUT and VIDEO OUT, and the signal that comes in from COMPONENT VIDEO IN is sent to COMPONENT VIDEO OUT.

If only the video connection for the MONITOR OUT is made, even if the input from each source component is through a component video connection, the picture will not appear. If only the S-video connection for the MONITOR OUT is made, the picture will not appear.

5. Connecting a DVD player

Using an RCA-type video connection cable, connect the video output terminal (composite) on the DVD player to the DVD VIDEO IN jack on the TX-DS989. If there is an S-video output terminal on the DVD player, connect it to the DVD S VIDEO IN jack using an S-video cable. If the DVD player has component video outputs, connect them to one of the COMPONENT VIDEO INPUT jacks.

Using an RCA-type audio connection cable, connect the audio output terminal on the DVD player to the audio DVD IN jacks on the TX-DS989. Make sure that you properly connect the left channel to the L jack and the right channel to the R jack.

If the DVD player has a digital output jack as well, be sure to also connect it to either a DIGITAL INPUT (COAXIAL) or DIGITAL INPUT (OPTICAL) jack on the TX-DS989 depending on the type of connector on the DVD player.

With the initial settings of the TX-DS989, the DVD input source is set for digital input at the OPTICAL 3 jack. If the digital connection is made at a different jack, this must be changed at the OSD Menu: Input Setup → Digital Setup → Digital Input (see page 34).

Example of how to connect your equipment

6. Connecting a LD player

Using an RCA-type video connection cable, connect the video output terminal (composite) on the LD player to the VIDEO 4 IN jack on the TX-DS989. If there is an S-video output terminal on the LD player, connect it to the S VIDEO 4 IN jack using an S-video cable.

If the LD player has an AC-3RF output, connect it to the AC-3RF jack on the TX-DS989. If this connection is made, "AC-3RF" must be set in the OSD Menu: Input Setup → Digital Setup → Digital Format (see page 34).

Using an RCA-type audio connection cable, connect the audio output terminal on the LD player to the audio VIDEO 4 IN jacks on the TX-DS989. Make sure that you properly connect the left channel to the L jack and the right channel to the R jack.

If the LD player has a digital output jack as well, be sure to also connect it to either a DIGITAL INPUT (COAXIAL) or DIGITAL INPUT (OPTICAL) jack on the TX-DS989 depending on the type of connector on the LD player.

With the initial settings of the TX-DS989, the VIDEO 4 input source is set for digital input at the COAXIAL 4 jack. If the digital connection is made at a different jack, this must be changed at the OSD Menu: Input Setup → Digital Setup → Digital Input (see page 34).

7. Connecting a video cassette recorder

Using an RCA-type video connection cable, connect the video output terminal (composite) on the video cassette recorder to the VIDEO 1 IN jacks on the TX-DS989 and video input terminal to the VIDEO 1 OUT jacks. If there is an S-video input/output terminal on the video cassette recorder, connect it to the S VIDEO 1 IN/OUT jack using an S-video cable. If the video cassette recorder has component video outputs, connect them to one of the COMPONENT VIDEO INPUT jacks.

Using an RCA-type audio connection cable, connect the audio output terminal on the video cassette recorder to the same VIDEO 1 IN audio jacks on the TX-DS989 and audio input terminal to the VIDEO 1 OUT audio jacks. Make sure that you properly connect the left channel to the L jack and the right channel to the R jack.

8. Connecting a satellite tuner or television

Using an RCA-type video connection cable, connect the video output terminal (composite) on the satellite tuner or television to the VIDEO 3 IN jacks on the TX-DS989. If there is an S-video output terminal on the satellite tuner or television, connect it to the S VIDEO 3 IN jack using an S-video cable. If the satellite tuner or television has component video outputs, connect them to one of the COMPONENT VIDEO INPUT jacks.

Using an RCA-type audio connection cable, connect the audio output terminal on the satellite tuner or television to the same VIDEO 3 IN audio jacks on the TX-DS989. Make sure that you properly connect the left channel to the L jack and the right channel to the R jack.

If the satellite tuner or television has a digital output jack as well, be sure to also connect it to either a DIGITAL INPUT (COAXIAL) or DIGITAL INPUT (OPTICAL) jack on the TX-DS989 depending on the type of connector on the set top box or television.

With the initial settings of the TX-DS989, the VIDEO 3 input source is set for digital input at the COAXIAL 3 jack. If the digital connection is made at a jack different from the initial settings, this must be changed at the OSD Menu: Input Setup → Digital Setup → Digital Input (see page 34).

9. Connecting a DVD recorder or other digital video recording device

Using an RCA-type video connection cable, connect the video output terminal (composite) on the device to the VIDEO 2 IN jacks on the TX-DS989 and video input terminal to the VIDEO 1 OUT jacks. If there is an S-video input/output terminal on the device, connect it to the S VIDEO 2 IN/OUT jack using an S-video cable. If the device has component video outputs, connect them to one of the COMPONENT VIDEO INPUT jacks.

Using an RCA-type audio connection cable, connect the audio output terminal on the device to the same VIDEO 2 IN audio jacks on the TX-DS989 and audio input terminal to the VIDEO 1 OUT audio jacks. Make sure that you properly connect the left channel to the L jack and the right channel to the R jack.

If the device has a digital output jack as well, be sure to also connect it to either a DIGITAL INPUT (COAXIAL) or DIGITAL INPUT (OPTICAL) jack on the TX-DS989 depending on the type of connector on the device.

With the initial settings of the TX-DS989, the VIDEO 2 input source is set for digital input at the COAXIAL 2 jack. If the digital connection is made at a jack different from the initial settings, this must be changed at the OSD Menu: Input Setup → Digital Setup → Digital Input (see page 34).

If the device also has a digital input jack, it can be connected to the DIGITAL OUTPUT (COAXIAL) or DIGITAL OUTPUT (OPTICAL) jack on the TX-DS989 for recording of the signal from the input source selected at the TX-DS989.

10. Connecting a television monitor or projector

Using an RCA-type video connection cable, connect the video input terminal (composite) on the monitor to one of the MONITOR OUT jacks on the TX-DS989. If there is an S-video input terminal on the monitor, connect it to the S VIDEO MONITOR OUT jack using an S-video cable. If the device has component video inputs, connect them to the COMPONENT VIDEO OUTPUT jacks.

Note that the OSD Menu will not be displayed on the monitor connected to MONITOR OUT 2. This allows you to connect large screens or projectors to MONITOR OUT 2 and use a smaller television connected to MONITOR OUT 1 just to make settings in the OSD Menu.

Connecting speakers

Before connecting the speakers, place them correctly by consulting the instruction manuals that came with them.

For surround playback, the configuration and placement of your speakers are very important.

For THX surround EX playback, we recommend that you use a THX speaker system that is certified by Lucasfilm Ltd.

Ideal speaker configuration

- **Front right and left speakers**
- **Center speaker**

Produces a rich sound image by serving as a sound source for the front right and left speakers and enhancing the sonic movement.

- **Surround right and left speakers**

Adds three-dimensional sonic movement and produces environmental sound associated with the background and effect sound for each scene.

- **Surround back right and left speakers**

Required for enjoying THX Surround EX audio.

- **Subwoofer**

Produces powerful and heavy bass.

Minimum speaker configuration for surround sound playback

- **Front right and left speakers**
- **Surround right and left speakers**

The sound recorded for the center speaker and the subwoofer will be properly distributed to the front right and left speakers and the surround right and left speakers for optimized surround playback.

Speaker placement

Ideal speaker placement varies depending on the size of your room and the wall coverings. Here, only typical example of speaker placement and recommendations are shown.

Important points regarding speaker placement

Front left and right speakers and center speaker

- Place these three speakers at the same height from the floor.
- Place each speaker so that sound is aimed at the location of the listener's ears when at the listening position.

Surround left and right speakers

- Place these speakers so that their height is 1 meter higher than that of the listener's ears.

Surround back left and right speakers

- These speakers are required for enjoying THX Surround EX audio.
- Place these speakers behind the listener so that the angle between each speaker and the listener is approximately 30 degrees.
- Place these speakers so that their height is 1 meter higher than that of the listener's ears.

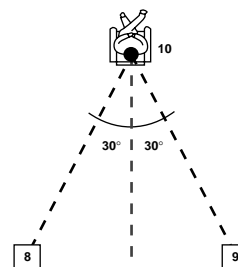

Subwoofer

A subwoofer is recommended for the highest bass effect.

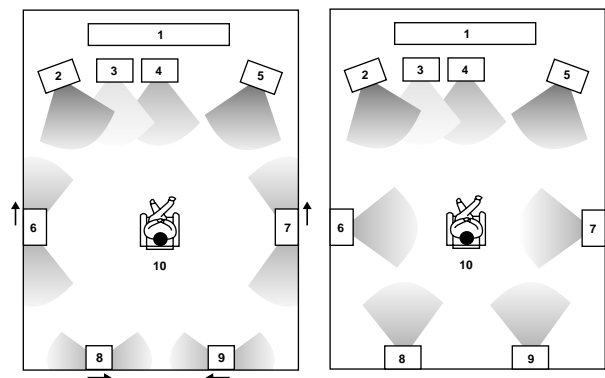

- | | |
|-----------------------|-------------------------------|
| 1 TV or screen | 6 Surround left speaker |
| 2 Front left speaker | 7 Surround right speaker |
| 3 Subwoofer | 8 Surround back left speaker |
| 4 Center speaker | 9 Surround back right speaker |
| 5 Front right speaker | 10 Listening position |

Most dipoles have an arrow on them to indicate their orientation towards the screen. So for the side dipoles, the arrows point forward. For the back dipoles, the arrows should point towards each other to achieve the correct acoustical phasing in the room.

Connecting speakers

Connecting speakers

Notes:

- The TX-DS989 is designed to produce optimum sound quality when speakers with impedances within the specified ranges are connected. Check the following information and choose speakers with appropriate impedances for the connections.

CAUTION:

SPEAKER IMPEDANCE

6 Ω min. per each speaker terminal.

- When you are using only one speaker or when you wish to listen to monaural (mono) sound, a single speaker should never be connected in parallel to both the right and left-channel terminals simultaneously.

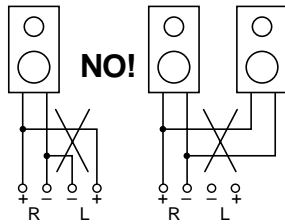

- To prevent damage to circuitry, never short-circuit the positive (+) and negative (-) speaker wire.



Connecting the speaker cable

- Strip away 5/8" of wire insulation.
- Twist wire ends very tight.
- Unscrew
- Insert wire
- Screw

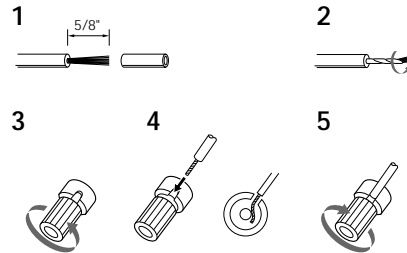

Connecting a subwoofer

Use the PRE OUT SUBWOOFER jack to connect a subwoofer with a built-in power amplifier. If your subwoofer does not have a built-in amplifier, connect an amplifier to the PRE OUT SUBWOOFER jack and the subwoofer to the amplifier. The output to PRE OUT SUBWOOFER 1 and PRE OUT SUBWOOFER 2 is the same.

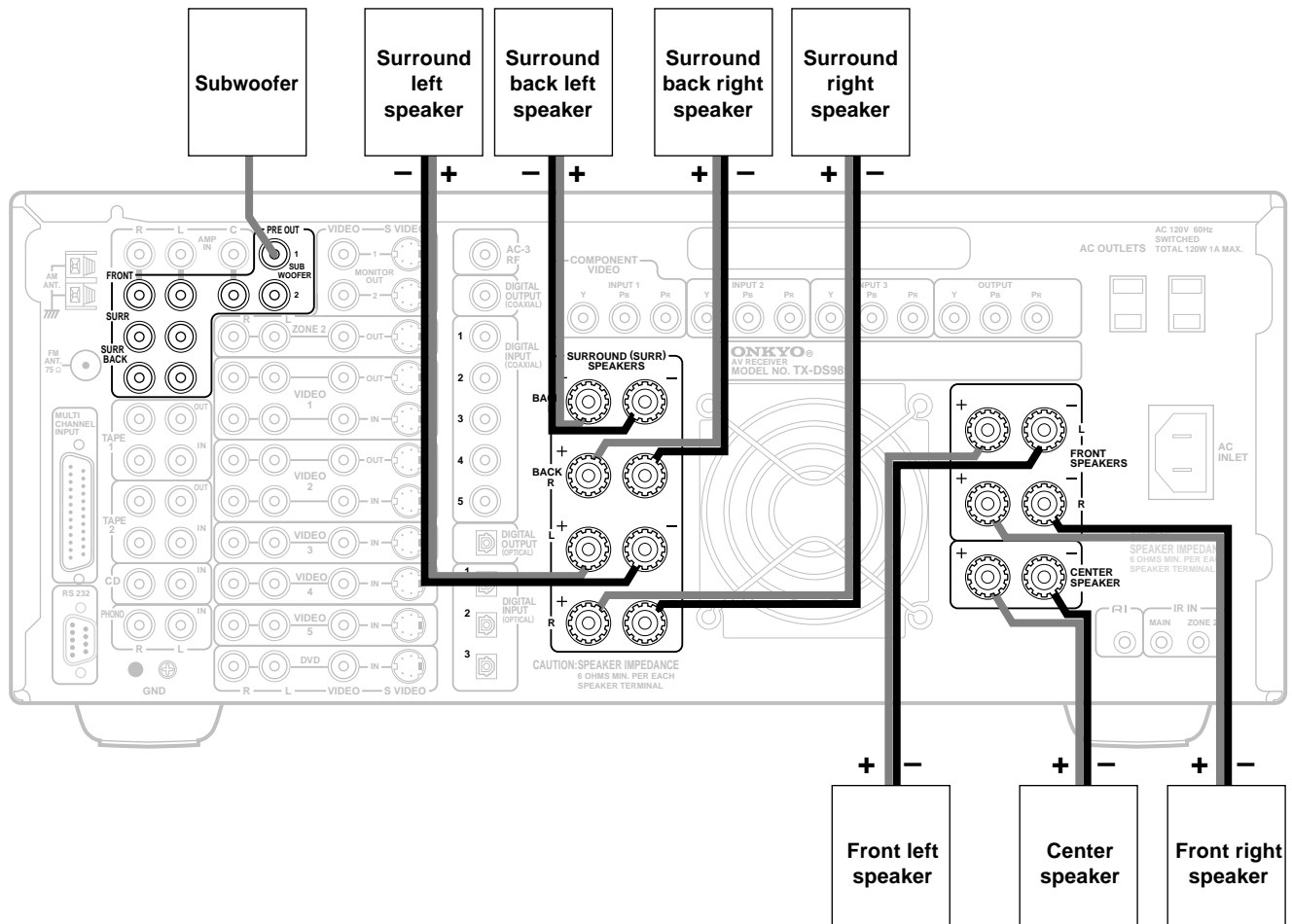

Connecting antennas

Connecting the included antennas

Connecting the FM indoor antenna:

The FM indoor antenna is for indoor use only. During use, extend the antenna and move it in various directions until the clearest signal is received. Fix it with push pins or similar implements in the position that will cause the least amount of distortion.

If the reception is not very clear with the attached FM indoor antenna, the use of an outdoor antenna is recommended.

Connecting the AM loop antenna:

The AM loop antenna is for indoor use only. Set it in the direction and position where you receive the clearest sound. Put it as far away as possible from the TX-DS989, televisions, speaker cables, and power cords.

When reception is not satisfactory with the attached AM loop antenna alone, connection of an outdoor antenna is recommended.

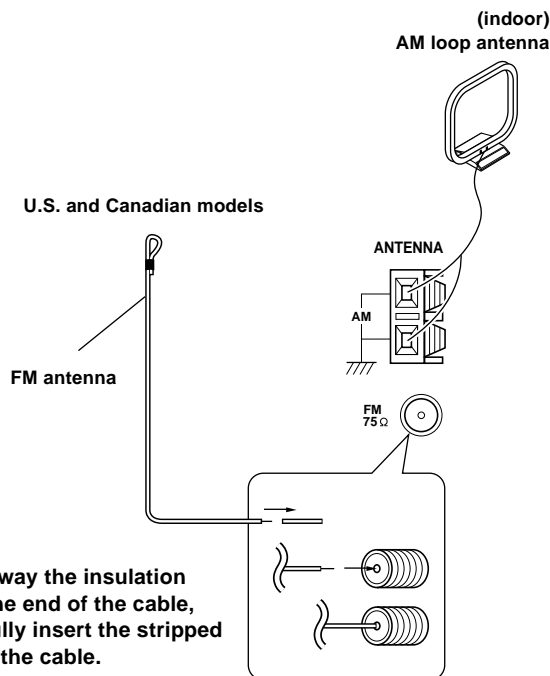

Assembling the AM loop antenna

Assemble the loop antenna as shown in the illustration.

- Refer to the next page for details on connecting the AM loop antenna.

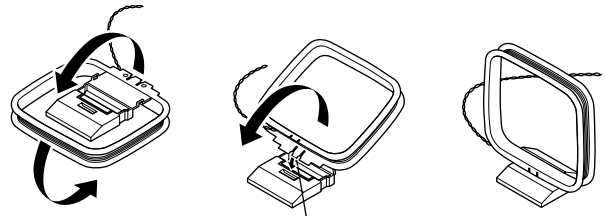

Insert into the hole.

Connecting the AM antenna cable

1. Press down the lever.
2. Insert the wire into the hole.
3. Release the lever.

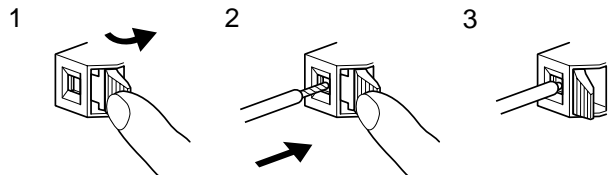

Connecting antennas

Connecting an FM outdoor antenna

Please make sure that you follow the considerations:

- Keep the antenna away from noise sources (neon signs, busy roads, etc.).
- It is dangerous to put the antenna close to power lines. Keep it well away from power lines, transformers, etc.
- To avoid the risk of lightning and electrical shock, grounding is necessary. Follow item 14 of the “Important Safeguards” on page 2 when you install the outdoor antenna.

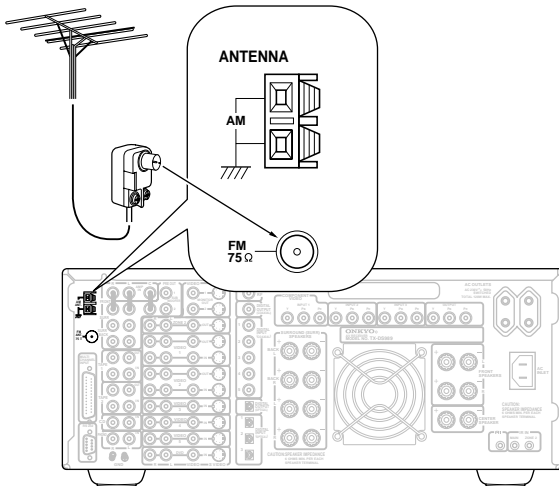

Connecting an AM outdoor antenna

An outdoor antenna will be more effective if it is stretched horizontally above a window or outside.

- Do not remove the AM loop antenna.
- To avoid the risk of lightning and electrical shock, grounding is necessary. Follow item 14 of the “Important Safeguards” on page 2 when you install the outdoor antenna.

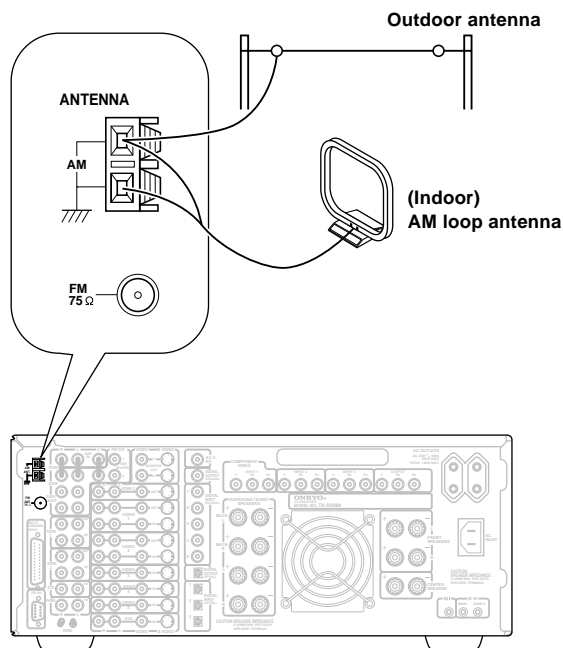

Directional linkage

Do not use the same antenna for both FM and TV (or VCR) reception since the FM and TV (or VCR) signals can interfere with each other. If you must use a common FM/TV (or VCR) antenna, use a directional linkage type splitter.

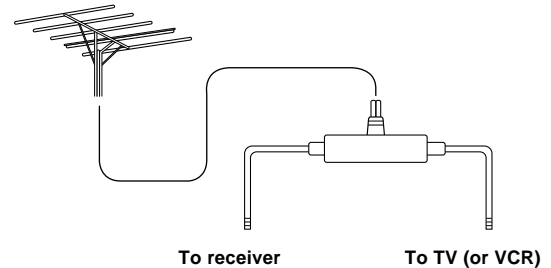

Connecting the antenna cable to the 75/300 Ω antenna adapter (not included)

Connecting the 300 Ω ribbon wire:

Loosen the screws and wrap the wire around these screws. Then tighten the screws with a screwdriver.



Connecting the coaxial cable:

1. With your fingernail, or a small screwdriver, press the stoppers of the 75/300 Ω antenna adapter outward and remove the cover.
2. Remove the transformer wire A from slit B and insert it into slit C.
3. Prepare the coaxial cable as shown in the diagram.
4. Connect the 75/300 Ω antenna adapter to the coaxial cable.
 - 1 Insert the end of the cable.
 - 2 Clamp it in place with pliers.
5. Reinstall the cover.

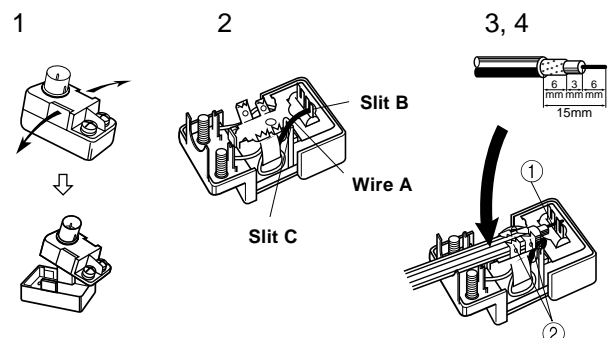

Connecting to the IR IN ZONE 2 input

Outline

The IR IN ZONE 2 input allows you to control the TX-DS989 from the remote zone (Zone 2) with the remote controller even though the remote zone is physically separated. The diagram below shows how to make the proper connections for the remote zone.

The following equipment (sold separately) is essential for operation from the remote zone:

- Onkyo's Multi-Room System kits (IR Remote Controller Extension System), or
- Multiroom A/V distribution and control systems from Niles® and Xantech® to name a few

Make connection as shown below. Do not plug the equipment into the power source until the connection is complete.

Connecting the main and remote zones

The ZONE 2 terminal is a constant output. Connect to the LINE input of the amplifier (CD, tape, etc.). Adjust the volume with the amplifier connected to the ZONE 2 terminal.

1. Connect the TX-DS989 to the amplifier for the remote zone.
2. Connect the remote zone speaker cables to the speaker terminals on the amplifier.
3. Connect the TX-DS989 to the monitor for the remote zone.
4. Install the connecting block in the main zone and connect it to the IR IN ZONE 2 input at the TX-DS989.
5. Install the remote sensor in the remote zone and connect it to the connecting block in the main zone.

Connection example for Onkyo's Multi-room System kit

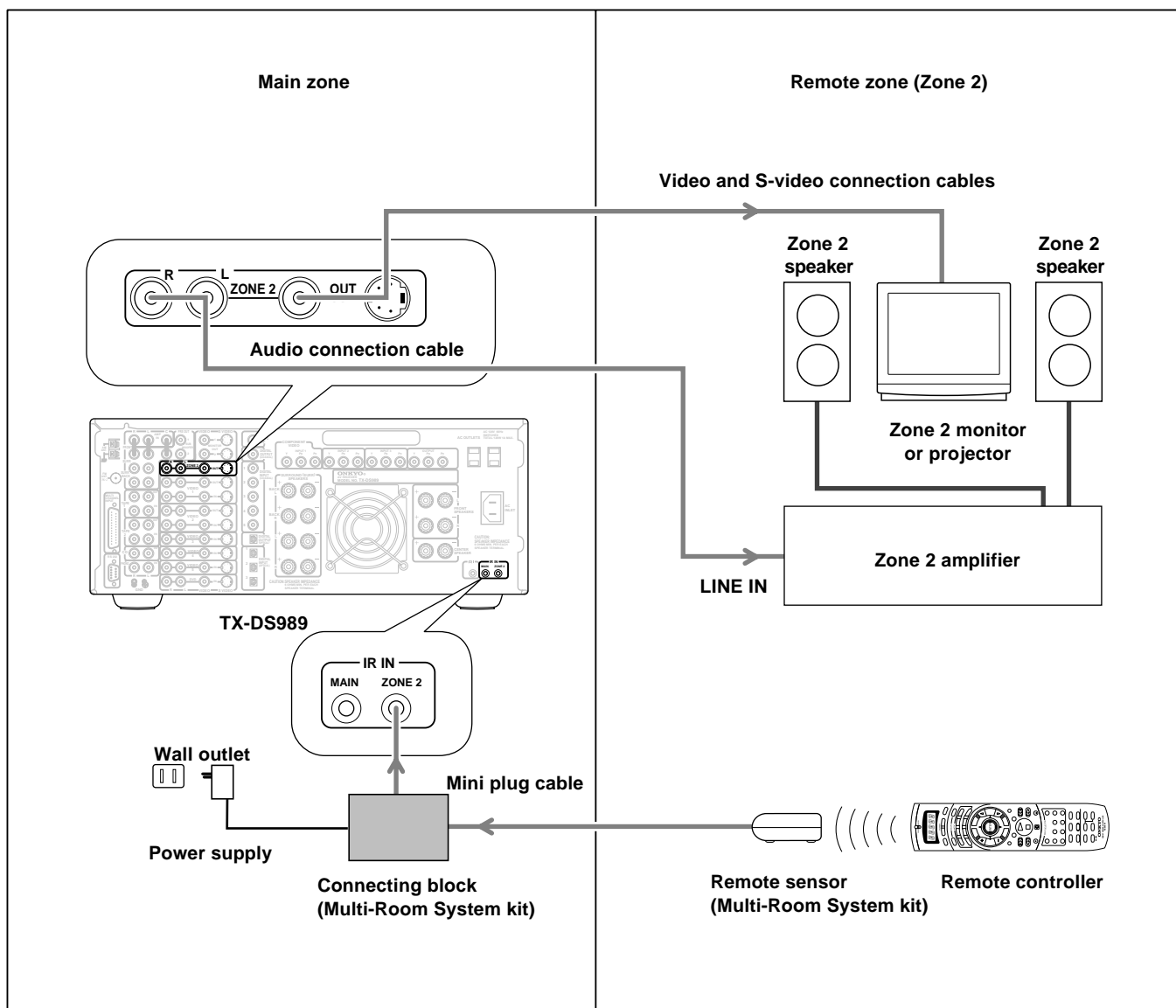

Connecting to the IR IN MAIN input

Outline

If the TX-DS989 is located inside a cabinet or other enclosure where the infrared beams from the remote controller cannot enter, then operation with the remote controller will not be possible. In such a case, it will be necessary to install a remote sensor at a location outside of the cabinet for the infrared beams from the controller to reach.

1. Connect the connecting block to the IR IN MAIN input at the TX-DS989.
2. Install the remote sensor at a location where it can detect the infrared beams from the remote controller.
3. Connect the remote sensor to the connecting block.

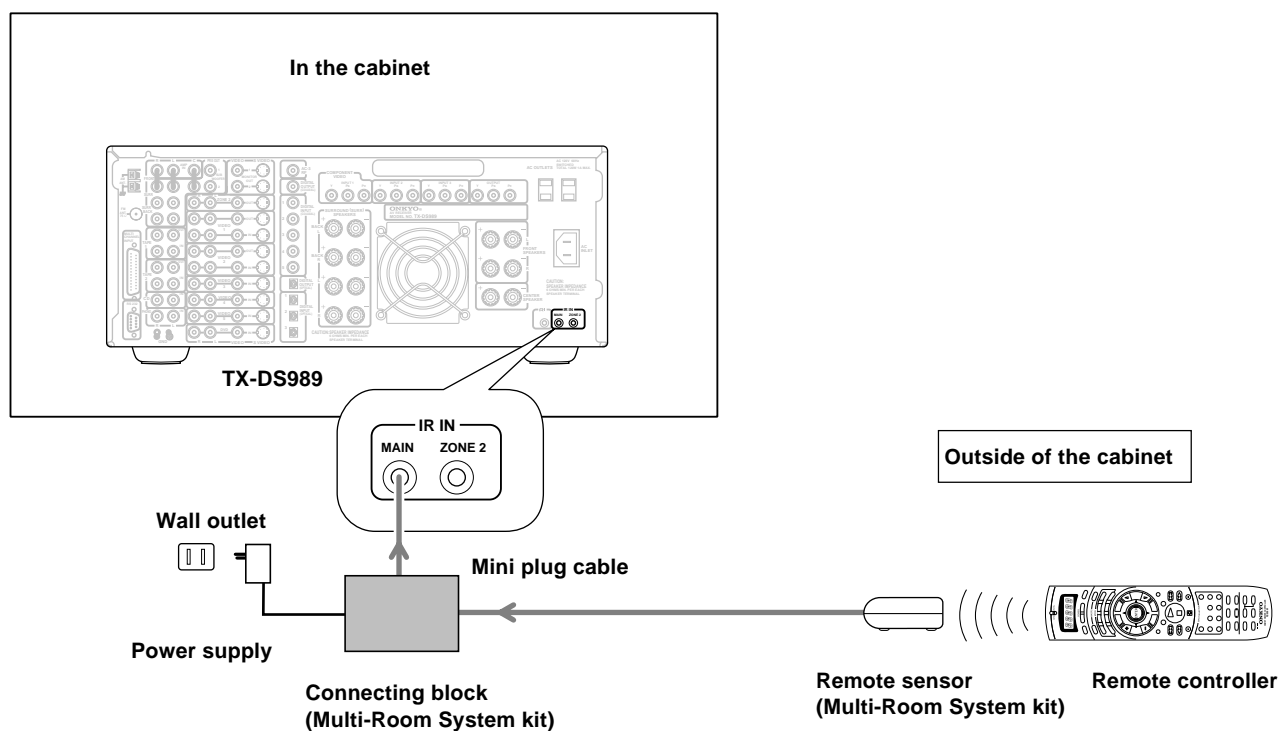

Connecting a graphic equalizer and power amplifiers

Connecting a graphic equalizer

The AMP IN and the PREOUT connectors are attached with jumper plugs. When connecting a graphic equalizer, remove these jumper plugs before connecting the audio connection cables.

1. Remove the jumper plugs.

2. Connect a graphic equalizer.

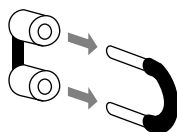

Notes:

- Keep the jumper plugs so that you will not lose them.
- When the connectors are not in use, replace the jumper plugs.

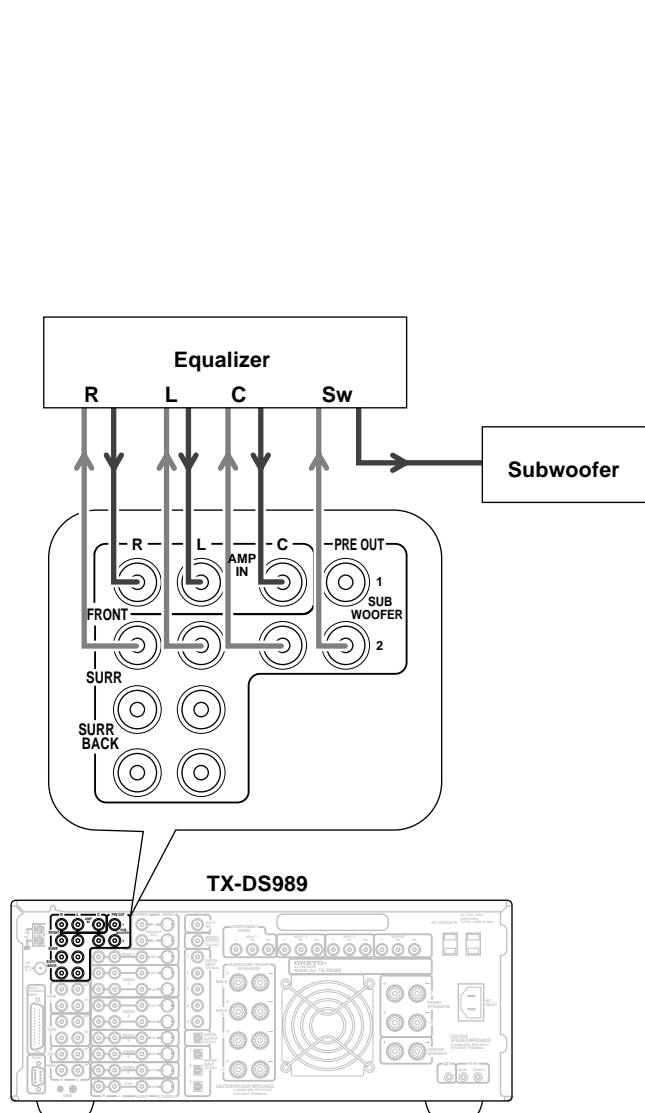

Connecting power amplifiers

Using auxiliary power amplifiers allows you to listen at louder volumes than with the TX-DS989 alone. If power amplifiers are used, connect each speaker to the corresponding power amplifier.

1. Remove the jumper plugs.

2. Connect the power amplifiers.

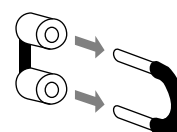

Notes:

- Keep the jumper plugs so that you will not lose them.
- When the connectors are not in use, replace the jumper plugs.

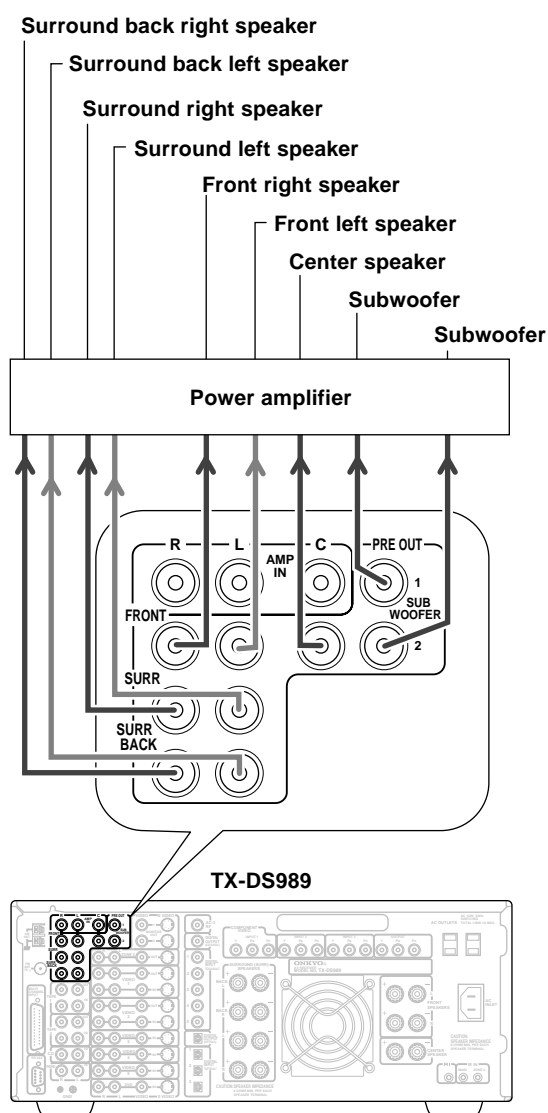

Connecting the power

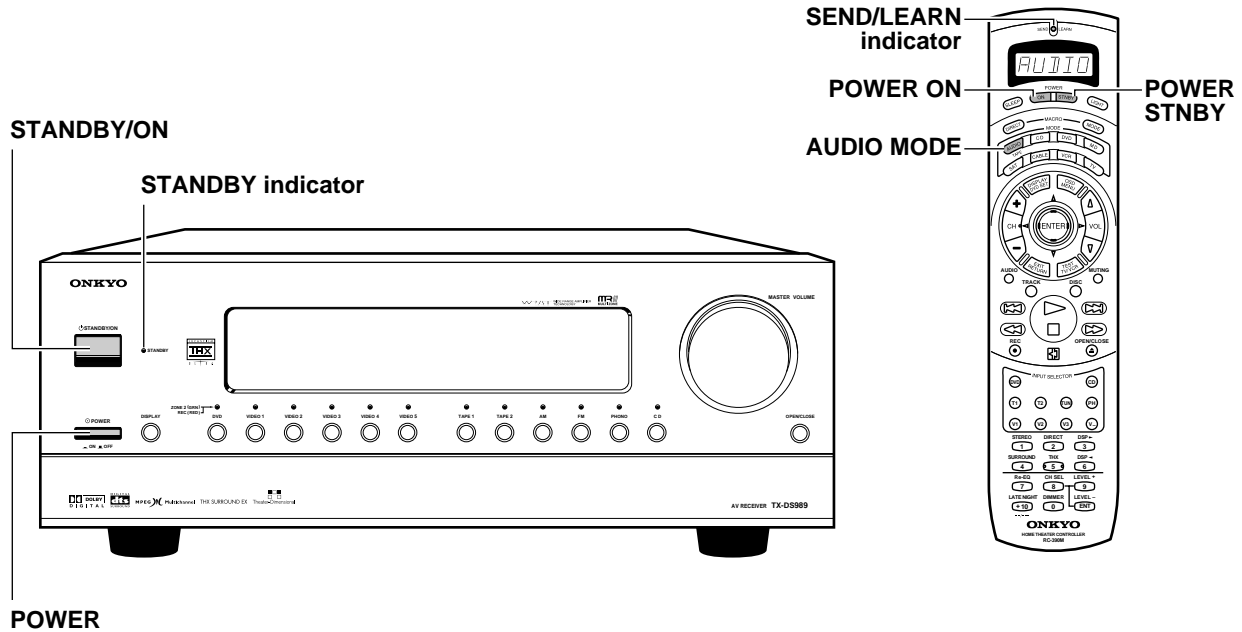

Connecting the power

- The TX-DS989 is shipped with the main power (POWER) switch in the on position (ON). When the power cord is plugged in for the first time, the TX-DS989 will automatically enter the standby state and the STANDBY indicator will light (same condition after step 2 below).
- Before you plug in the TX-DS989, confirm that all connections have been made properly.
- Turning on the power may cause a momentary power surge, which might interfere with other electrical equipment on the same circuit, such as computers. If this happens, use a wall outlet on a different circuit.

1. Plug the power cord into an AC wall outlet.

2. Press the POWER switch to set the TX-DS989 to standby state.

The STANDBY indicator will light up.

3. Press the STANDBY/ON button to turn on the TX-DS989. The display will light up and the STANDBY indicator will turn off.

Display



If you press the STANDBY/ON button again, the receiver returns to Standby mode.

Turning the power on from the remote controller:

Before you can use the remote controller, you must perform steps 1 and 2 above and place the TX-DS989 in the standby state.

1. Press the AUDIO MODE button.

2. Press the POWER ON button to turn on the TX-DS989 (take it out of the standby state).

- To return the TX-DS989 to the standby state, press the POWER STNBY button.

The On-Screen Display (OSD) menu

The OSD menu is a settings menu that is displayed on your TV monitor and allows you to perform your speaker settings, setup your input sources, set the listening modes, and much more. In most situations, you will only need to set this once during the installation and layout of your home theater, and it rarely needs to be changed later.

The OSD menu consists of a main screen that is divided up into six menus: Speaker Setup, Input Setup, Listening Mode Setup, Preference, Zone2 OSD Setup, and About. These menus are then divided up into various sub-menus, and these contain settings for you to optimize your home theater as you wish.

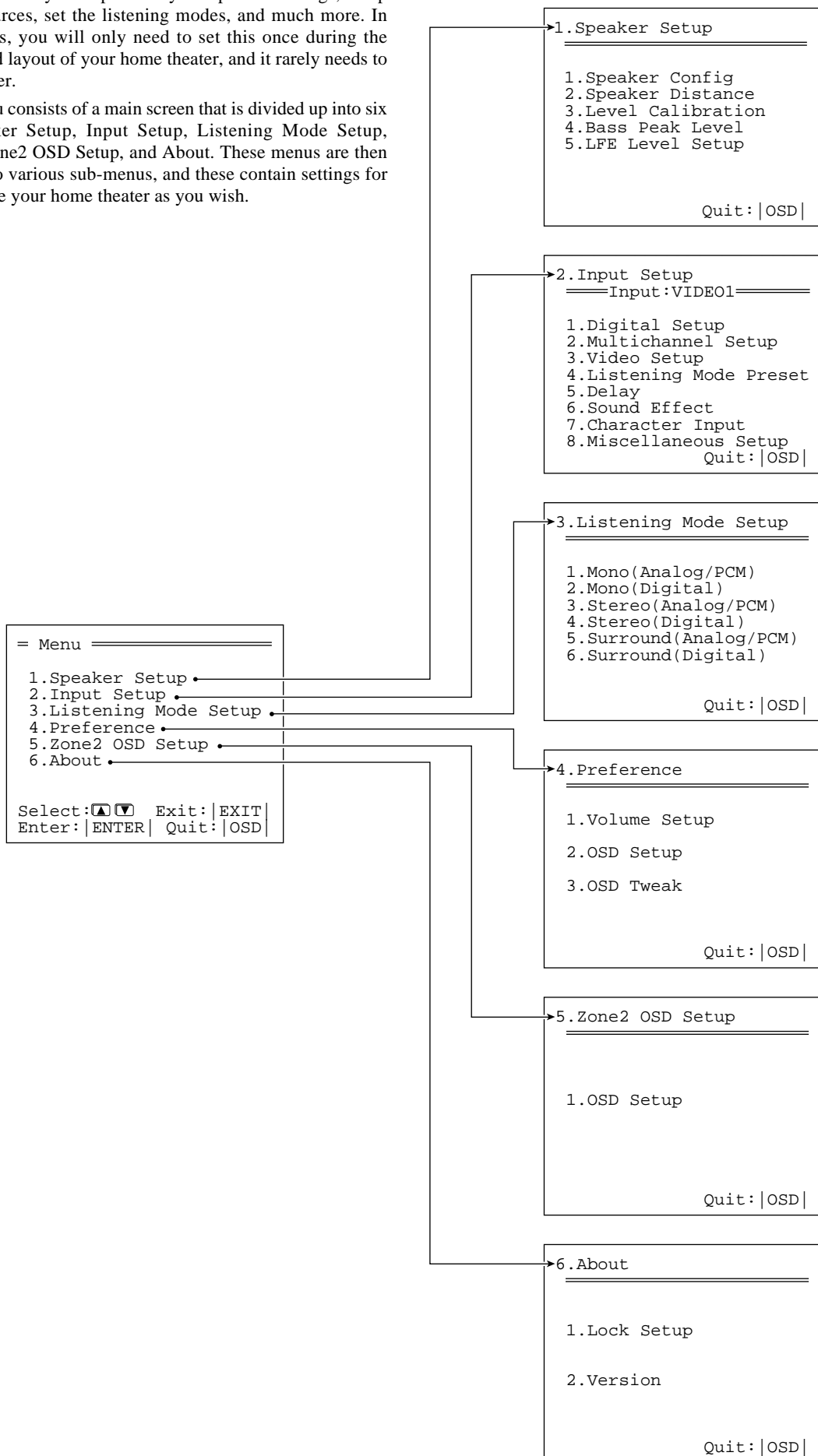

The On-Screen Display (OSD) menu

OSD

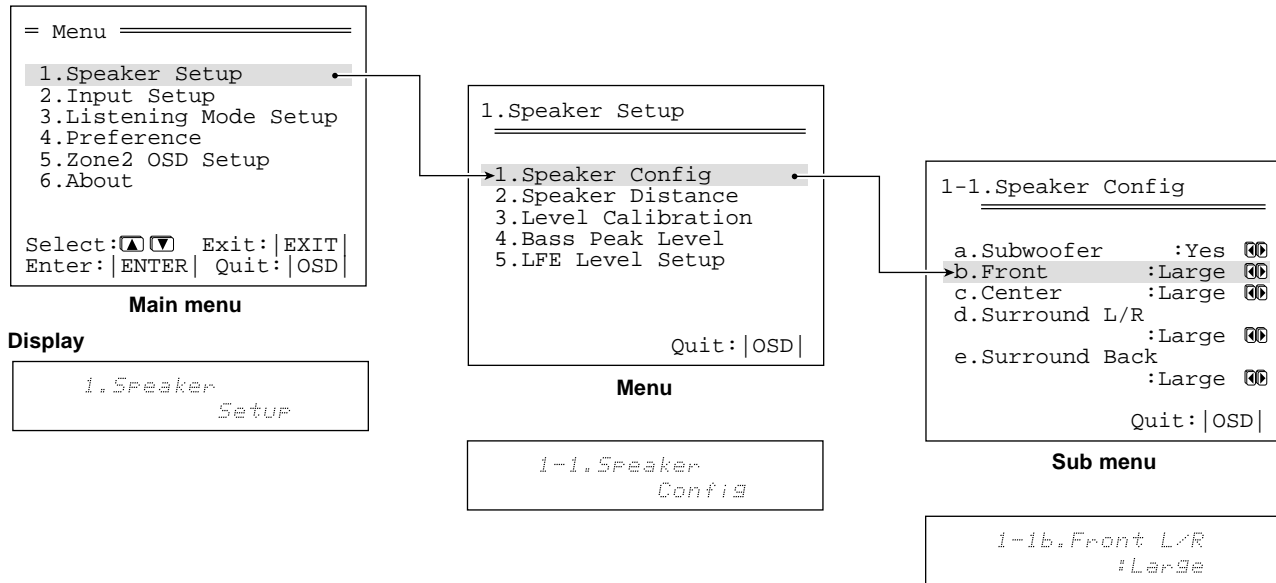

Navigating through the OSD menu

The explanations here assume you are using the buttons on the TX-DS989 when entering the OSD menu. However, you can use the buttons on the remote controller as well.

The buttons on the remote controller correspond to those on the TX-DS989 as shown below.

Button on remote controller	Button on TX-DS989 (under cover)
OSD MENU	MENU
(upper edge of ENTER button)	UP
(lower edge of ENTER button)	DOWN
(left edge of ENTER button)	LEFT
(right edge of ENTER button)	RIGHT
ENTER	ENTER
EXIT RETURN	EXIT

1. Press the MENU button.

The main menu screen of the OSD menu appears on your TV monitor.

2. Using the ▲ and ▼ cursor buttons, select the menu that you want to enter.

3. Press the ENTER button to enter the selected menu.

The screen for that menu appears.

4. Using the ▲ and ▼ cursor buttons, select the sub-menu that you want to enter, and press the ENTER button.

Each sub-menu has different settings that can be changed as desired, and they are all explained below. To change a setting, first select it using the ▲ and ▼ cursor buttons, and then change the setting using the ◀ and ▶ cursor buttons.

5. Press the EXIT button to set the new settings and return to the previous menu screen, and again to return to the main screen.

Note:

Press the MENU button to exit the OSD menu immediately.

Speaker Setup

1. Speaker Setup menu

After you have installed the TX-DS989, connected all the components, and determined the speaker layout, it is now time to perform the settings in the Speaker Setup menu for the optimum sound acoustics for your environment and speaker layout.

Before you perform the following settings, it is important that you first determine the following characteristics:

- The types and sizes of the speakers that are connected.
- The distance from each speaker to your normal listening position.

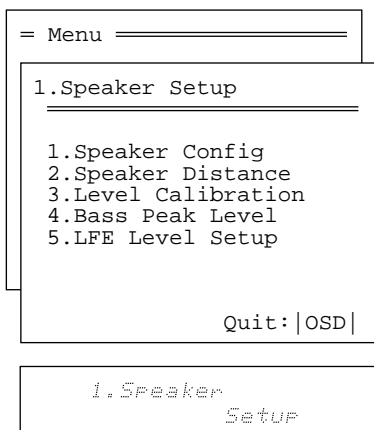

1-1. Speaker Config sub-menu

Here you will enter which speakers are connected and the size of each speaker.

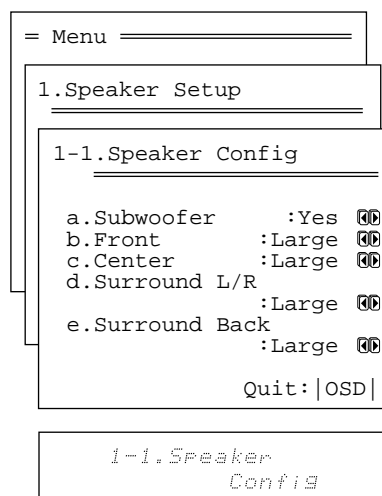

Memo:

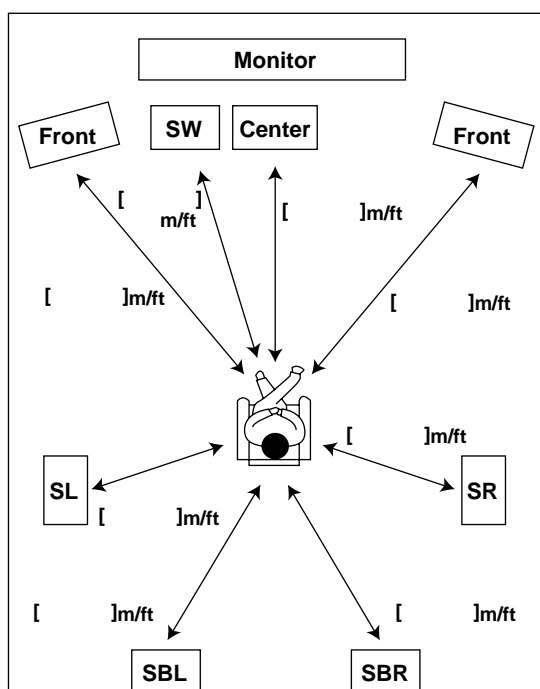

Tip:

When setting the speaker size in the Speaker Config sub-menu, use the guidelines given below.

Large: The complete frequency range for the channel you are setting will be output from the speaker.

Small: Frequencies of the channel you are setting lower than 80 Hz will be output from the subwoofer. If the front speakers are set to “Large,” then the sound may be output from both the left and right speakers. (All THX speakers are small.)

a. Subwoofer

Yes: Select when a subwoofer is connected.

No: Select when a subwoofer is not connected.

b. Front

Large: Select if the front speakers are large sized.

Small: Select if the front speakers are small sized.

- If “No” is selected for the Subwoofer setting, then this setting is fixed to “Large.”

c. Center

None: Select if no center speaker is connected.

Large: Select if the center speaker is large sized.

Small: Select if the center speaker is small sized.

- If “Small” is selected for the Front setting, then “Large” cannot be selected for this setting.

d. Surround L/R

None: Select if no surround left and right speakers are connected.

Large: Select if the surround left and right speakers are large sized.

Small: Select if the surround left and right speakers are small sized.

- If “Small” is selected for the Front setting, then “Large” cannot be selected for this setting.

e. Surround Back

None: Select if no surround back left and right speakers are connected.

Large: Select if the surround back left and right speakers are large sized.

Small: Select if the surround back left and right speakers are small sized.

- If “None” is selected for the Surround L/R setting, then this setting is fixed to “None.”
- If “Small” is selected for the Surround L/R setting, then “Large” cannot be selected for this setting.

Speaker Setup

1-2. Speaker Distance sub-menu

Here you will enter the distance from each speaker to your normal listening position (Loudspeaker Position Time Synchronization*). This is important for the timing of the acoustics to create the proper sound space that the TX-DS989 and today's sound systems are able to produce. Note that the speakers that you selected "No" or "None" for in the Speaker Config sub-menu will not appear here.

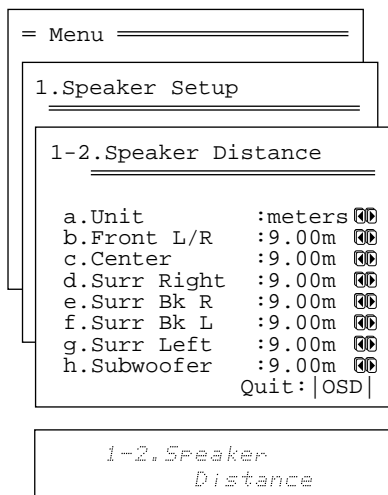

a. Unit

feet: Select if you will enter the distances in feet.

meters: Select if you will enter the distances in meters.

b. Front L/R

Set the distance from the front left and right speakers to your normal listening position between 1 and 30 feet in 0.5-foot intervals (0.3 to 9 meters in 0.15-meter intervals).

Position the front left and right speakers so that they are the same distance from the listener. If they are not, you may lose the center position for stereo sound.

c. Center

Set the distance from the center speaker to your normal listening position between 1 and 30 feet in 0.5-foot intervals (0.3 to 9 meters in 0.15-meter intervals).

- If "None" was selected for the Center setting in the Speaker Config sub-menu, then this setting will not appear.

d. Surr Right

Set the distance from the surround right speaker to your normal listening position between 1 and 30 feet in 0.5-foot intervals (0.3 to 9 meters in 0.15-meter intervals).

- If "None" was selected for the Surround L/R setting in the Speaker Config sub-menu, then this setting will not appear.

e. Surr Bk R

Set the distance from the surround back right speaker to your normal listening position between 1 and 30 feet in 0.5-foot intervals (0.3 to 9 meters in 0.15-meter intervals).

- If "None" was selected for the Surround Back setting in the Speaker Config sub-menu, then this setting will not appear.

f. Surr Bk L

Set the distance from the surround back left speaker to your normal listening position between 1 and 30 feet in 0.5-foot intervals (0.3 to 9 meters in 0.15-meter intervals).

- If "None" was selected for the Surround Back setting in the Speaker Config sub-menu, then this setting will not appear.

g. Surr Left

Set the distance from the surround left speaker to your normal listening position between 1 and 30 feet in 0.5-foot intervals (0.3 to 9 meters in 0.15-meter intervals).

- If "None" was selected for the Surround L/R setting in the Speaker Config sub-menu, then this setting will not appear.

h. Subwoofer

Set the distance from the subwoofer to your normal listening position between 1 and 30 feet in 0.5-foot intervals (0.3 to 9 meters in 0.15-meter intervals).

- If "No" was selected for the Subwoofer setting in the Speaker Config sub-menu, then this setting will not appear.

* Loudspeaker Position Time Synchronization is a registered trademark of Lucasfilm Ltd.

Speaker Setup

1-3. Level Calibration sub-menu

Here you will set the volume for each speaker so that they are all heard by the listener at the same level. This is especially important for speaker layouts where the left and right speakers are at different distances or in asymmetrical positions due to room designs and configurations. These settings and the distance settings performed above are vital to create the proper acoustics required for the optimum sound space and dynamics.

Note:

The speaker level settings here are not effective for multi-channel input sources. To adjust the speaker levels for multi-channel input sources, you will need to use the CH SEL, LEVEL+, and LEVEL- buttons on the RC-390M remote controller. See page 53.

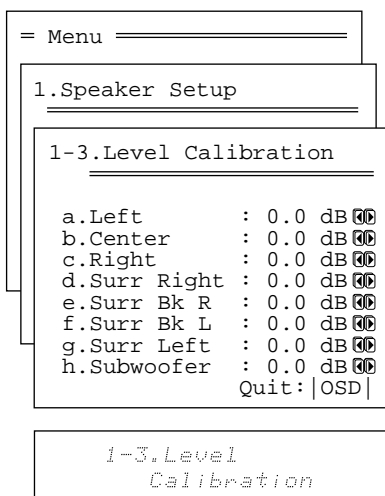

Calibrating the speaker levels

- (1) When this sub-menu is entered, the TX-DS989 will emit a pink noise from the front left speaker. At this time, the master volume automatically increases to the reference level (0dB). Remember the level of this noise and then press the DOWN cursor button. (Note that this can be adjusted to any level between -12 and 12 decibels in 0.5-decibel intervals.) The TX-DS989 will now emit the pink noise from the center speaker.
- (2) Using the ◀ and ▶ cursor buttons, adjust the volume level of the noise from the center speaker so that it is the same level as the front left speaker. You can jog back and forth between the speakers to help you compare the volume levels.
- (3) Press the ▼ cursor button again. The TX-DS989 will now emit the pink noise from the front right speaker.
- (4) Repeat steps (2) and (3) above for the front right and other speakers until all speakers are adjusted to the same volume level.

Notes:

- Speakers that you selected “No” or “None” for in the Speaker Config sub-menu will not appear.
- To accurately set the output levels, it is recommended to use a handheld sound pressure level (SPL) meter. Set the meter to C-weighting and slow averaging. A Radio Shack® SPL meter or equivalent is recommended. Using the internal channel noise generators, set each channel so that you read a 75 decibel sound pressure level.

a. Left

Sound comes from the front left speaker. Adjust the sound level between -12 and 12 decibels in 0.5-decibel intervals.

b. Center

Sound comes from the center speaker. Adjust the sound level between -12 and 12 decibels in 0.5-decibel intervals.

- If “None” was selected for the Center setting in the Speaker Config sub-menu, then this setting will not appear.

c. Right

Sound comes from the front right speaker. Adjust the sound level between -12 and 12 decibels in 0.5-decibel intervals.

d. Surr Right

Sound comes from the surround right speaker. Adjust the sound level between -12 and 12 decibels in 0.5-decibel intervals.

- If “None” was selected for the Surround L/R setting in the Speaker Config sub-menu, then this setting will not appear.

e. Surr Bk R

Sound comes from the surround back right speaker. Adjust the sound level between -12 and 12 decibels in 0.5-decibel intervals.

- If “None” was selected for the Surround Back setting in the Speaker Config sub-menu, then this setting will not appear.

f. Surr Bk L

Sound comes from the surround back left speaker. Adjust the sound level between -12 and 12 decibels in 0.5-decibel intervals.

- If “None” was selected for the Surround Back setting in the Speaker Config sub-menu, then this setting will not appear.

g. Surr Left

Sound comes from the surround left speaker. Adjust the sound level between -12 and 12 decibels in 0.5-decibel intervals.

- If “None” was selected for the Surround L/R setting in the Speaker Config sub-menu, then this setting will not appear.

h. Subwoofer

Sound comes from the subwoofer. Adjust the sound level between -15 and 12 decibels in 0.5-decibel intervals.

- If “No” was selected for the Subwoofer setting in the Speaker Config sub-menu, then this setting will not appear.

Speaker Setup

1-4. Bass Peak Level (Bass Peak Level Manager*) sub-menu

Setting the bass peak level is important to keep your subwoofer from being damaged by preventing it from outputting over a set volume. If your subwoofer has a built-in limiter, set this setting to "Off."

Note:

If your system does not include a subwoofer, this setting will set the bass peak level for your front speakers.

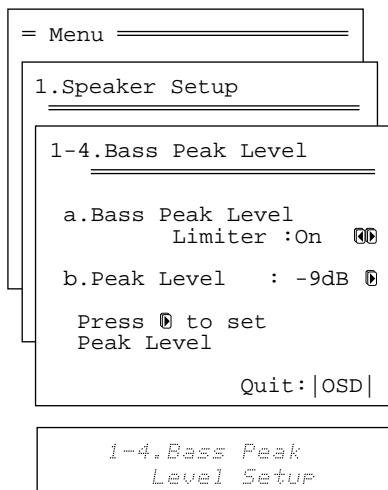

a. Bass Peak Level Limiter

On: Select to set the bass peak level. When "On" is selected, the Peak Level setting appears below.

Off: Select to turn off the bass peak level limiting function.

b. Peak Level

The current bass peak level is displayed. To change the setting, press the ► cursor button. When pressed, a test output tone is emitted from the subwoofer. Then, using the ► cursor button or master volume dial, slowly raise the volume to the point where the sound becomes distorted and then back it off until it returns to normal. This is the proper setting for the bass peak level.

After setting the Peak Level at the Bass Peak Level sub-menu, press the EXIT button. The values are set and the previous screen appears.

Notes:

- The volume can be adjusted to either $-\infty$ or between -81 to $+18$ decibels in 1-decibel increments.
- Do not allow the distorted sound to be output from the subwoofer for a long time for it may damage the subwoofer.

* Bass Peak Level Manager is a registered trademark of Lucasfilm Ltd.

1-5. LFE Level Setup sub-menu

This sub-menu is for setting the LFE (Low Frequency Effect) levels included in Dolby Digital, DTS, and MPEG software. The default setting is 0 decibels.

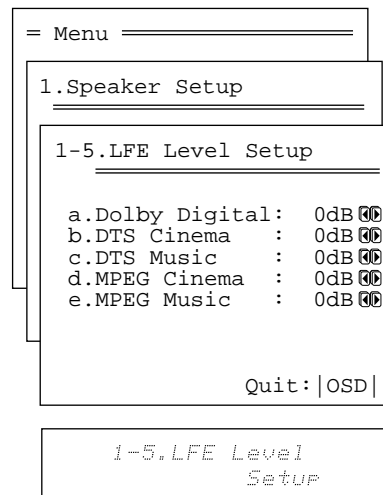

a. Dolby Digital

The level can be adjusted to either $-\infty$ or between -10 to 0 decibels in 1-decibel increments. For Dolby Digital input source signals, the LFE level becomes that set here. A setting of 0 decibels is recommended for optimum performance; however, if the low frequency range is too strong, lower this setting as necessary.

b. DTS Cinema

The level can be adjusted to either $-\infty$ or between -10 to 0 decibels in 1-decibel increments. For DTS input source signals set to a listening mode of DTS Film, THX, Theater-Dimensional, Mono Movie, Action, or Musical, the LFE level becomes that set here. A setting of 0 decibels is recommended for optimum performance; however, if the low frequency range is too strong, lower this setting as necessary.

c. DTS Music

The level can be adjusted to either $-\infty$ or between -10 to $+10$ decibels in 1-decibel increments. For DTS input source signals set to a listening mode of DTS, Enhanced 7, Orchestra, Unplugged, Studio-Mix, TV Logic, or All Ch Stereo the LFE level becomes that set here. A setting of 0 decibels is recommended for optimum performance; however, if the low frequency range is too weak, higher this setting as necessary.

d. MPEG Cinema

The level can be adjusted to either $-\infty$ or between -10 to 0 decibels in 1-decibel increments. For MPEG input source signals set to a listening mode of MPEG Film, THX, Theater-Dimensional, Mono Movie, Action, or Musical, the LFE level becomes that set here. A setting of 0 decibels is recommended for optimum performance; however, if the low frequency range is too strong, lower this setting as necessary.

e. MPEG Music

The level can be adjusted to either $-\infty$ or between -10 to $+10$ decibels in 1-decibel increments. For MPEG input source signals set to a listening mode of MPEG, Enhanced 7, Orchestra, Unplugged, Studio-Mix, TV Logic, or All Ch Stereo the LFE level becomes that set here. A setting of 0 decibels is recommended for optimum performance; however, if the low frequency range is too weak, higher this setting as necessary.

Input Setup

2. Input Setup menu

This menu allows you to setup the various input sources available with the TX-DS989. Each input source may have a great number of settings that are difficult to keep track of, so we recommend making a chart to record what you have set and for which component to prevent confusion later.

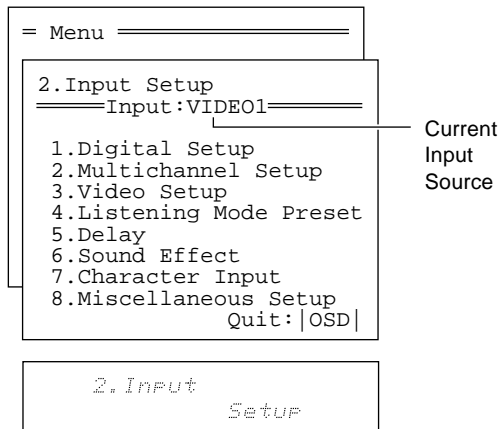

2-1. Digital Setup sub-menu

The settings made in this sub-menu are valid for the input source that is currently selected with the input source buttons at the front panel and, therefore, these settings are made separately for each digital input source. This sub-menu will not appear if the Multichannel setting in the Multichannel Setup sub-menu is set to "On" for the selected input source, or if the selected input source button is AM, FM, or PHONO. If this setting is incorrectly made, the digital audio signals may not be properly output, or not heard at all.

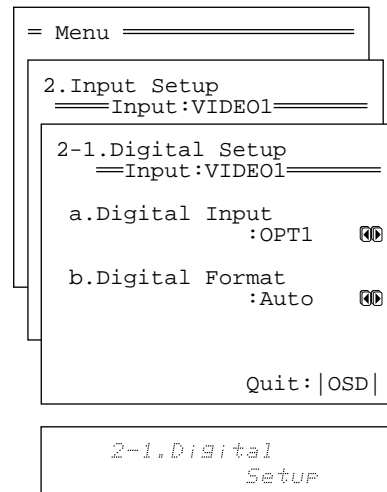

a. Digital Input

This setting tells the TX-DS989 which input source button on the front panel is connected with which digital input jack on the rear panel. To perform this setting, you must first select a digital input source at the front panel and then set the name of the digital input jack it is connected to here.

For example, if the input source selected at the front panel is CD and the compact disc player is connected to OPTICAL IN 1, then select "OPT1" here. If the input source selected is not connected to a digital input, then select "----."

- OPT1:** Select if connected to DIGITAL INPUT (OPTICAL) 1.
- OPT2:** Select if connected to DIGITAL INPUT (OPTICAL) 2.
- OPT3:** Select if connected to the DIGITAL INPUT (OPTICAL) 3.
- COAX1:** Select if connected to DIGITAL INPUT (COAXIAL) 1.
- COAX2:** Select if connected to DIGITAL INPUT (COAXIAL) 2.
- COAX3:** Select if connected to DIGITAL INPUT (COAXIAL) 3.
- COAX4:** Select if connected to DIGITAL INPUT (COAXIAL) 4.
- COAX5:** Select if connected to DIGITAL INPUT (COAXIAL) 5.
- :** Select if the input source is not from a digital input jack.

b. Digital Format

The default setting is "Auto." If "----" is selected for this input source at the Digital Input setting, then this setting will not appear. Although you can use this default setting as is, you may change it as desired depending on the input signal format (e.g., if you know that you will always be listening to a certain input signal format from a particular input source).

Input Setup

Auto: Select for automatic detection of the input signal format. The input signal format (Dolby Digital, DTS, MPEG, PCM or Analog) used by the selected input source is detected automatically to execute the required decoding process. If no digital signal is input, the input signals to the analog input jacks will be played.

AC-3RF: Select if a LD player with an AC-3RF terminal is connected to the AC-3RF input on the TX-DS989. AC-3RF can only be selected if VIDEO 4 is selected as the input source.

Digital: Select for automatic detection of a digital input signal format. The input digital signal format (Dolby Digital, DTS, MPEG, or PCM) used by the selected digital input source is detected automatically to execute the necessary decoding process.

DTS: Select for DTS signal processing. The decoding process is executed only when DTS signals are input.

PCM: Select for PCM signal processing. The decoding process is executed only when PCM signals are input.

Analog: Regardless of whether the component is also digitally connected, the audio signals input from the component through the analog input jacks are played.

Notes:

- If “Auto” or “Digital” is selected and a compact disc or LD is fast-forwarded during playback, decoded PCM signals may produce a skipping sound. In such cases, change the setting to “PCM.”
- If a compact disc or LD encoded in the DTS format is played back with “PCM” selected, only noise will be produced. Always select “Auto,” “Digital,” or “DTS” when playing back DTS-encoded sources.

Notes on DTS:

- If you play a CD or LD that supports DTS when the “PCM” setting is selected on the TX-DS989, the DTS encoded signal will not be decoded and noise will be output. This noise could damage the amplifier and speakers. Therefore, be sure to selected “Auto,” “Digital,” or “DTS” and use the digital input jacks (OPTICAL or COAXIAL) to connect the DTS source.
- If you play a CD or LD that supports DTS when the “Auto” or “Digital” setting is selected, you may hear a noise for a short while until the DTS decoder recognizes the DTS-encoded signal and starts operating. This is not a malfunction.
- If you press the PAUSE or SKIP button on the player while playing a DTS source, a short noise may be heard. This is not a malfunction. In such cases, try playing the source in the “DTS” selected.
- The DTS indicator on the TX-DS989 lights while a DTS source is played. When playback finishes and the DTS signal transmission stops, the TX-DS989 remains in DTS mode and the DTS indicator remains lit. This prevents noise when you operate the PAUSE or SKIP button on the player. Therefore, if the source is immediately switched from DTS to PCM, the PCM signal may not be played. In this case, stop the playback of the source on the player for about three seconds and then resume playback.

- You may not be able to play some DTS source signals from certain CD players and LD players even if you connect the player to the TX-DS989 digitally. This is because the digital signal has been processed (such as the output level, sampling frequency, or frequency response) and the TX-DS989 cannot recognize the signal as DTS data. Therefore you may hear noise when you play a DTS source while processing the signal.
- The outputs for the VIDEO 1 OUT, VIDEO 2 OUT, TAPE 1 OUT, and TAPE 2 OUT output analog audio signals. Do not record from CDs or LDs that support DTS using these outputs. If you do, the DTS-encoded signal will be recorded as noise.

Input Setup

2-2. Multichannel Setup sub-menu

This sub-menu will not appear if AM, FM, or PHONO is selected at the front panel for the input source. This setting is normally set to “No,” and only needs to be changed to “Yes” if a DVD player, MPEG decoder, or other component that has a multi channel port is connected to the MULTI CHANNEL INPUT port for 5.1-channel or 7.1-channel audio. For example, if a DVD player is connected to the MULTI CHANNEL INPUT port, then select DVD at the front panel as the input source, bring up this sub-menu, and select “Yes” for the Multichannel setting. When “Yes” is selected, the audio from the MULTI CHANNEL INPUT is given preference.

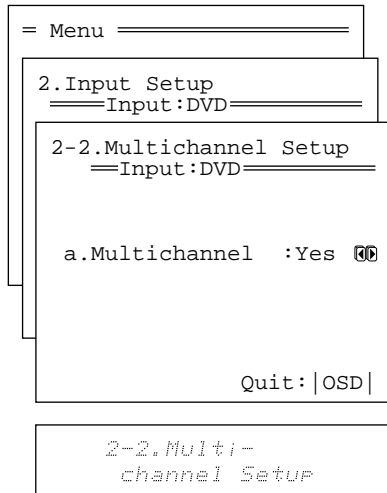

2-3. Video Setup sub-menu

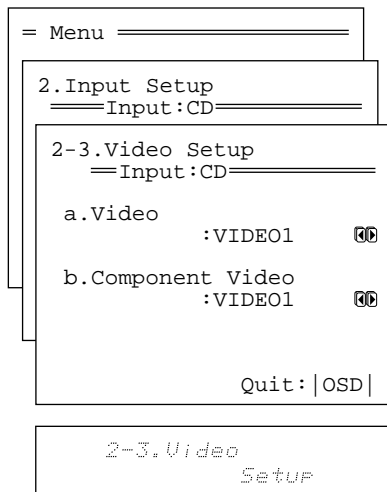

a. Video

This setting allows you to match the audio from one component with the video from another. Therefore, you can set a video source to be displayed while the audio from another input source is heard. For example, this allows you to play the music from a compact disc, while displaying the picture from a video cassette player or other video source. Since the settings in this sub-menu are also linked to the input source that is currently selected at the front panel, a different setting can be made for each digital input source.

The default settings are given below.

Input source selected	Video
CD	Last valid
PHONO	Last valid
FM	Last valid
AM	Last valid
TAPE1	Last valid
TAPE2	Last valid
DVD	DVD
VIDEO1	VIDEO1
VIDEO2	VIDEO2
VIDEO3	VIDEO3
VIDEO4	VIDEO4
VIDEO5	VIDEO5

Last valid: When you change to an input source set to “Last valid,” the video of the input source that you changed from is continued. For example, if the selected input source is VIDEO 1, and you then change to CD (set to “Last valid”), then the audio from the CD input is played while the video from VIDEO 1 continues.

b. Component

If a component is connected to the one of the COMPONENT VIDEO inputs (1, 2, or 3), then that input must be set here. This setting will not appear if AM, FM, PHONO, CD, TAPE1, or TAPE2 is selected as the input source.

The default settings are given below.

Input source selected	Setting
DVD	COMPONENT VIDEO 1
VIDEO1	----
VIDEO2	COMPONENT VIDEO 2
VIDEO3	COMPONENT VIDEO 3
VIDEO4	----
VIDEO5	----

Input Setup

2-4. Listening Mode Preset sub-menu

With the TX-DS989, you can set a different listening mode for each different signal type that comes from each input source and also set the parameters for the listening mode itself. For example, if your DVD player also plays compact discs and the DVD video signal is DTS and the compact disc signal is PCM, then you can set a different listening mode for each.

This is especially convenient if you frequently play the same types of movies or music.

Note that some listening modes cannot be set for some input sources. In addition, if "Yes" is set for multi channel for the input source selected, then the listening mode cannot be set. Also, if the "----" is set for the Digital Input setting in the Digital Setup sub-menu, then you can only select "Analog/PCM."

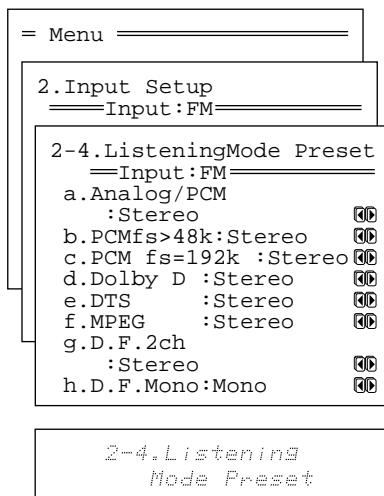

* The 5.1-channel digital surround format has a variety of versions including Dolby Digital, DTS, and MPEG. The 5.1-channel digital surround format enables you to individually record and play five full-range (20Hz-20kHz) channels (left and right front, center, two surround channels) plus an LFE channel (Low Frequency Effect) for the low-range effect sound. It will create a realistic sound that could be heard in the theaters and concert halls.

Relationship between input source and listening mode

Input source signal (display) Type of software	Analog/PCM Tape, CD, Record, Tuner	PCM fs>48k Audio DVD, Video DVD	PCM fs=192k Audio DVD	Dolby D Video DVD, LD, Digital satellite broadcast	DTS CD, LD, Video DVD	MPEG Video DVD	D.F.2ch* Video DVD, LD	D.F.Mono* Video DVD, LD
Listening mode								
Mono	●						●	●
Direct	●	●	●					
Stereo	●	●	●	●	●	●	●	
T-D (Theater-Dimensional)	●			●	●	●	●	
Dolby D (Dolby Digital)				●				
DTS					●			
DTS Film					●			
MPEG (MPEG Multichannel)						●		
MPEG Film						●		
THX Cinema				●	●	●		
Action				●	●	●		
Musical				●	●	●		
(Dolby) Pro Logic (3 Stereo)*	●	●					●	
(Dolby Pro Logic) THX Cinema	●						●	
(Dolby Pro Logic) Action	●						●	
(Dolby Pro Logic) Musical	●						●	
Mono Movie	●						●	●
Enhance7	●			●	●	●	●	
Orchestra Unplugged Studio-Mix TV Logic	●			●	●	●	●	
All Ch Stereo	●						●	

The listening modes that can be set are different for each input source format.

* If Dolby Pro Logic is set for the listening mode and there are no surround speakers, then the listening mode becomes 3 Stereo.

Input Setup

Input source signals

a. Analog/PCM

Analog sources consist of LP records, AM and FM broadcasts, cassette tapes, and the such. PCM (Pulse Code Modulation) is one form of digital audio signals and is recorded directly onto compact discs and DVDs without compression.

b. PCM fs > 48 k

Digital PCM sources that are recorded at a sampling rate of greater than 48 kilohertz. This includes compact discs and DVDs that are recorded with high quality audio.

c. PCM fs = 192 k

Digital PCM sources that are recorded at a sampling rate of greater than 192 kilohertz. This includes compact discs and DVDs that are recorded with extremely high quality audio.

d. Dolby D (Dolby Digital)

Digital data with AC-3 compression and a maximum of 5.1-channel surround sound. This source signal comes from DVDs and LDs that have the  mark and therefore recorded for 5.1-channel output. This source also comes from digital satellite broadcasts that support Dolby Digital.

Dial norm

Dialogue Normalization (Dial Norm) is feature of Dolby Digital. When playing back software that has been encoded in Dolby Digital, sometimes you may see a brief message in the front panel display that read Dial Norm xdB ("x" being a numeric value). Dialogue Normalization serves to let you know if the source material has been recorded at a higher or lower level than usual. For example, if you see the message "Dial Norm: +4" in the front panel display, to keep the overall output level constant just turn down the volume control by 4dB. In other words, the source material that you are listening to has been recorded 4dB louder than usual. If you do not see a message, then no adjustment of the volume control is necessary.

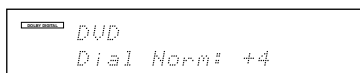

e. DTS

DTS (Digital Theater System) is compressed digital data with a maximum 5.1-channel surround output that allows for an extremely high-quality sound. This source signal requires a DVD player that supports DTS output and comes from compact discs, DVDs, and LDs that have the  mark.

f. MPEG

Digital data with a maximum of 5.1-channel surround audio with MPEG compression. This source signal comes from DVDs that have the  mark.

g. D.F. 2 ch

This corresponds to 2-channel digital format sources. This signal source comes from LDs, DVDs, and other digital sources that are recorded with 2-channel audio.

h. D.F. Mono

This corresponds to monaural digital format sources. This signal source comes from LDs, DVDs, and other digital sources that are recorded with monaural audio.

Listening Modes

Mono

This mode is for listening to the left and right channels separately. This mode also allows you to listen to the multiplexed soundtracks on DVDs, and other media that have them.

Stereo

This mode has all input sound is output from the left and right front speakers.

Direct

This mode delivers pure sound with minimum sound quality adjustment and filtration. The sound recorded for the right and left front channels is output to the right and left front speakers only and not output to the subwoofer.

Dolby D (Dolby Digital)

This mode is for listening to sources encoded with Dolby Digital in their plain format.

DTS

This mode is for listening to music DTS sources in their plain format.

DTS Film

This mode is for listening to cinema DTS sources in their plain format.

MPEG

This mode is for listening to music MPEG sources in their plain format.

MPEG Film

This mode is for listening to cinema MPEG sources in their plain format.

THX (THX Cinema)

Movies that have been encoded in Dolby Digital, DTS, MPEG, and Dolby Pro Logic can all benefit by activating the THX mode. THX should be activated only when watching movies that were mixed for playback in large movie theater environments. THX need not be activated for music, for movies that were made especially for television, or for shows such as sports programming, talk shows, and the like. This is because they were mixed in a small room environment.

For best results, use a THX certified speaker system.

• How to enjoy THX Surround EX

When the THX listening mode is selected, you can press the THX button on the remote controller to cycle through the settings "Auto," "On," and "Off."

When "Auto" is selected, if a Surround EX encoded source is input, it is automatically played in the THX Surround EX mode. When "On" is selected, all surround EX encoded sources and THX Surround EX playable sources (i.e., DTS-ES encoded sources) are played in the THX Surround EX mode. If the sound does not feel correct, set this to "Off."

If "On" is selected and a source that cannot be played in the THX Surround EX mode, "THXCinema" appears in the front display. If "Off" is selected, the listening mode becomes THX Cinema.

Note:

THX Surround EX can only be selected if the surround back speakers are connected.

THX Surround EX

“THX Surround EX - Dolby Digital Surround EX” is a joint development of Dolby Laboratories and the THX division of Lucasfilm Ltd.

In a movie theater, film soundtracks that have been encoded with Dolby Digital Surround EX technology are able to reproduce an extra channel which has been added during the mixing of the program. This channel, called Surround Back, places sounds behind the listener in addition to the currently available front left, front center, front right, surround right, surround left, and subwoofer channels.

This additional channel provides the opportunity for more detailed imaging behind the listener and brings more depth, spacious ambience and sound localization than ever before.

When released to the home consumer market, movies that were created using the Dolby Digital Surround EX technology, may have a note to that effect on the packaging. A list of movies created using this technology can be found on the Dolby web site at <http://www.dolby.com> <<http://www.dolby.com>> .

Only receiver and controller products bearing the THX Surround EX logo, when in the THX Surround EX mode, faithfully reproduce this new technology in the home.

This product may also engage the “THX Surround EX” mode during the playback of 5.1 channel material that is *not* Dolby Digital Surround EX encoded. In such case the information delivered to the Surround Back channel will be program dependent and may or may not be very pleasing depending on the particular soundtrack and the tastes of the individual listener.

Action

This mode is designed for movie soundtracks that stress special effect sounds and surround effects. In addition to strengthening the low frequency ranges for the front left, front right, and surround speakers, it also increases the surround levels. Resonance is also cut for a movie-theater feeling and increased enjoyment.

Musical

This mode is designed for watching musicals and movie soundtracks where importance is placed on the music. By slightly increasing the mid to high frequency ranges from the center speaker, the vocals from the screen seem highlighted for added listening pleasure. This mode is optimum for playing software that stresses music, environmental sounds, and the front image.

Pro Logic/3 Stereo (Dolby Pro Logic/3 Stereo)

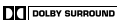
This mode is for listening to recordings with Dolby surround, which consists of four channels (left, right, center, and monaural surround) and emphasizes the center channel. Dolby Pro Logic is very effective for panning music, conversation, and three-dimensional sound movement output from the three front channels. It also simulates the atmosphere and surround effects of the sound reflected from the side and rear walls of the theater. Select this listening mode when you play a VHS, VHS hi-fi, LD, or DVD video that has the  mark.

If no surround speakers are connected, then the surround sound is divided and output from the front left and right channels.(3 Stereo)

Pro Logic THX (Dolby Pro Logic THX)

This mode is the same as the Dolby Pro Logic listening mode with the THX effects added as well. Select this mode when listening to movies that were encoded using Dolby Pro Logic.

Pro Logic Action (Dolby Pro Logic Action)

When listening to movies using the Dolby Pro Logic, this mode allows you to further enhance the cinematic quality by adding processing that emphasizes the sounds of the action special effects.

Pro Logic Musical (Dolby Pro Logic Musical)

When listening to music using the Dolby Pro Logic, this mode allows you to further enhance the sound quality by adding processing that emphasizes the musical effects.

Mono Movie

This mode is suitable for playing back monaural recording such as old movie soundtracks. The center channel delivers the unprocessed original sound, whereas the other channels deliver the center-channel sound processed with the appropriate reverberation. This allows you to enjoy monaural sound with the atmosphere of a movie theater.

T-D (Theater-Dimensional)

For the best enjoyment of your home theater, it is recommended that you have at least front left and right speakers, a center speaker, and surround left and right speakers. However, if you do only have front left and right speakers, you can enjoy multichannel audio by using this mode.

This mode controls the characteristics of the sound that reaches each ear to reproduce a multi-speaker setup. To receive the full effect, there is an optimum listening position (sweet spot). Refer to the explanation of the listening angle. In addition, if the reflective sound components are large, it may be difficult to achieve the desired result, so be sure to set up your system and listening position to minimize reflective sound.

Enhanced 7

Enhanced 7 intends to reproduce a natural surround environment by using 7-channel speakers. The sound effects moving smoothly toward the surround back. This mode is good for music and TV sports programs.

Orchestra

This mode is appropriate for classical and opera music. The center channel is cut and the surround channels are emphasized to widen the stereo image. It will simulate the natural reverberation that is created in large halls.

TV Logic

This mode gives realistic acoustics to TV programs that are aired from TV studios. It enhances the entire surround sound and clarity of the conversation.

Unplugged

This mode is suitable for acoustical instrumental sounds, vocals, and jazz music. By emphasizing the front stereo image, it will simulate the acoustics that you would experience in front of the stage.

Studio-Mix

This mode is for rock and popular music. The lively sounds are enhanced for a powerful acoustic image that simulates the feeling of being in a club or rock concert.

All Ch Stereo

This mode is designed for playing background music. The front, surround, and surround back channels create a stereo image that encompasses the entire area.

Input Setup

2-5. Delay sub-menu

This sub-menu gives you various ways to adjust the timing of the audio output from the speakers to give certain soundfield effects or to adjust for unwanted asynchronous video and audio tracks.

This sub-menu does not appear if "Direct" is selected as the listening mode.

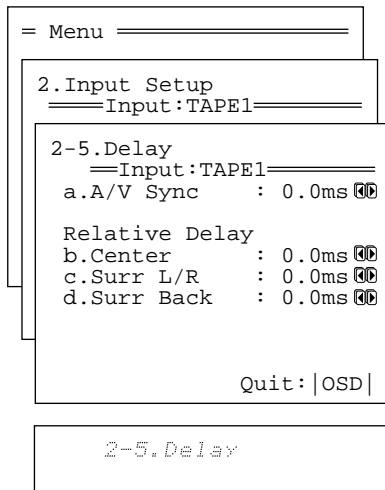

a. A/V Sync

If a digital signal processor is connected, there may be times when the audio and video from a DVD or LD player is not output in perfect sync. The result is where the sound and picture do not match and the sound is heard too early. In such a case, use this setting to properly synchronize the audio and video. This setting can be set between 0 to 30 ms in 0.5-ms increments. Under normal circumstances, this can be left at 0 ms. For input sources using the multi channel port, this setting will not appear.

b. Relative Delay

Besides level and delay adjustments, the TX-DS989 provides the ability to change or adjust the relative speaker position to fine tune the soundfield for the listener. This is accomplished using Onkyo's unique Enhanced Spatial Positioning Algorithm. This adjustment provides 10 milliseconds of delay for the speakers, which is equivalent to moving the speaker 10 feet away. This adjustment is set up to provide -4 or +6 milliseconds (-4 or +6 feet) of adjustment to the listener's position.

Once the coarse adjustments--speaker level and distance adjustments--are made, the system is set up to provide a typical or broad surround environment. By adjusting the relative position of the speakers, we are able to alter the soundfield to be more spread out (deeper) or focused (shallower).

2-6. Sound Effect sub-menu

This sub-menu allows you to increase or decrease only the low (bass) or high (treble) frequency sounds or adjust the volume for a particular input source. This sub-menu does not appear if "Direct" or "THX Mode" are selected as the listening mode.

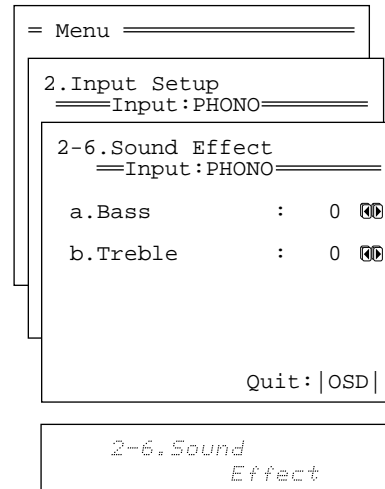

a. Bass

Press the ◀ cursor button to decrease the bass sounds and press the ▶ cursor button to increase the bass sounds. The bass can be adjusted between -12 and +12 decibels in two steps.

b. Treble

Press the ◀ cursor button to decrease the treble sounds and press the ▶ cursor button to increase the treble sounds. The treble can be adjusted between -12 and +12 decibels in two steps.

Input Setup

2-7. Character Input sub-menu

This sub-menu allows you to give names to the stations you have preset for the AM/FM tuner, and to the input sources you have connected (excluding the tuner itself). Up to 10 characters can be entered for each name. For example, if you have a DVD connected to the VIDEO5 input jack, then you can give it the name "DVD2." Or, if you have multiple VCRs connected, you can enter the model names or manufacturer names for each one so that you do not have to remember which is connected to which input source.

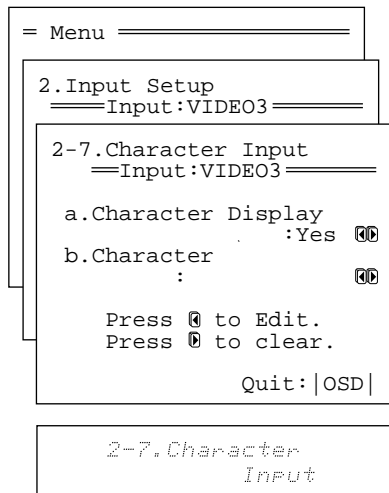

a. Character Display

Yes: Select to display the name you enter when the input source is selected.

No: Select to display the default name.

b. Character

If you have selected "Yes" for the Character Display above, then here you can enter the name that you want to display. Press ◀ cursor button to clear the current entry. Press ▶ cursor button to bring up the Character Input screen.

At the Character Entry screen, press the cursor buttons to move the cursor to the desired character and then press the ENTER button. That character will now appear in the 10-character space field above. Continue until the name is finished or until you have reached 10 characters.

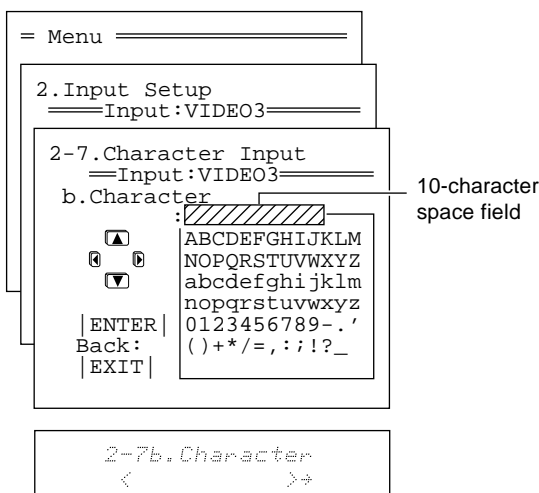

Using the cursor buttons, select the desired character and press the ENTER button. To change a character, move the cursor backward with the EXIT button or forward with the ENTER button to the location of mistaken character and enter the desired character. To erase a character, enter a blank space in its place. After completing the name, to exit, repeatedly press the ENTER button. Continue until the name is finished or until you have reached 10 characters.

2-8. Miscellaneous Setup

This sub-menu allows you to set some of the special features offered by the TX-DS989.

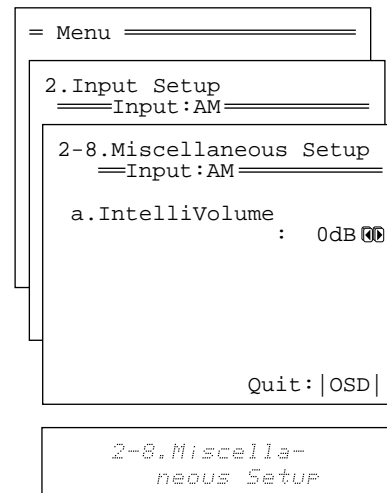

a. IntelliVolume

When switching input sources, you may find that the output level for different components or input sources connected to the TX-DS989 is different even though the main volume setting is the same. Under normal circumstances, you would then have to change the volume setting each time you change the input source. This IntelliVolume setting allows you to preset a volume level for each input source separately so that when you do switch from one input source to another, the TX-DS989 adjusts the volume accordingly so that the resulting volume stays the same. To set the IntelliVolume, simply select an input source at the front panel, and if that source is quieter than other sources, increase its decibel level with the ▶ cursor button, or if it is louder than other sources, decrease its decibel level with the ◀ cursor button.

The IntelliVolume can be adjusted between -12 and +12 decibels.

Listening Mode Setup

3. Listening Mode Setup menu

This menu allows you to make fine adjustments to the listening modes you have set for each input source with the Listening Mode Preset sub-menu. These adjustments are in the form of parameters and each one is explained below. Note that some parameters cannot be set for some listening modes and that no sub-menu will have all parameters. Also, for some input signal formats, changes in the listening mode parameters may actually result in no change to the resulting output signal.

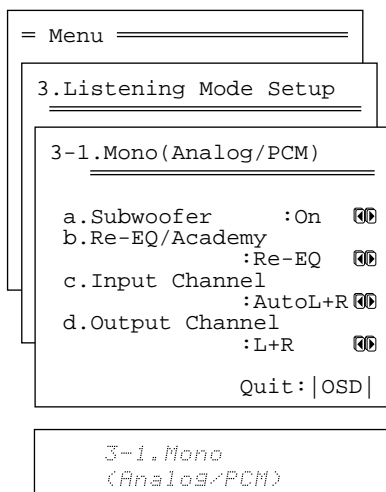
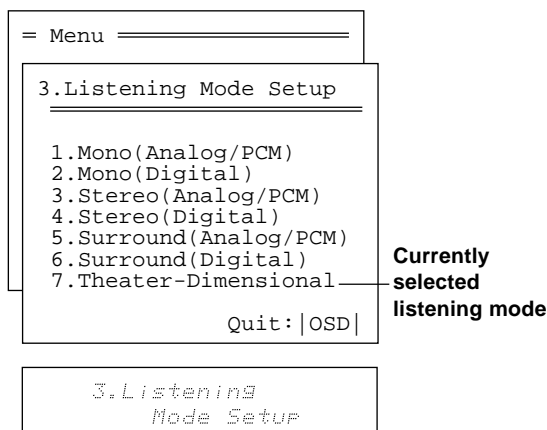

3-1. Mono (Analog/PCM) Setup

Select this to modify the Mono listening mode when the current source is analog or PCM. The parameters that can be set are shown in the table below.

	Parameter	Setting Initial value
a	Subwoofer	Off, On
b	Re-EQ/Academy	Off, Re-EQ, Academy
c	Input Channel	Auto L+R, Left, Right
d	Output Channel	L+R, Center

3-2. Mono (Digital) Setup

Select this to modify the Mono listening mode when the current source is digital. The parameters that can be set are shown in the table below.

	Parameter	Setting Initial value
a	Subwoofer	Off, On
b	Re-EQ/Academy	Off, Re-EQ, Academy
c	Input Channel	Auto L+R, Left, Right
d	Output Channel	L+R, Center

3-3. Stereo (Analog/PCM) Setup

Select this to modify the Stereo listening mode when the current source is analog or PCM. The parameters that can be set are shown in the table below.

	Parameter	Setting Initial value
a	Subwoofer	Off, On
b	Re-EQ/Academy	Off, Re-EQ, Academy
c	Digital Upsampling	Off, On

The c. Digital Upsampling can only be set for PCM input sources and cannot be set for analog ones.

3-4. Stereo (Digital) Setup

Select this to modify the Stereo listening mode when the current source is digital. The parameters that can be set are shown in the table below.

	Parameter	Setting Initial value
a	Subwoofer	Off, On
b	Re-EQ/Academy	Off, Re-EQ, Academy

3-5. Surround (Analog/PCM) Setup

Select this to modify the Pro Logic Surround listening mode when the current source is analog or PCM. The parameters that can be set are shown in the table below.

	Parameter	Setting Initial value
a	Subwoofer	Off, On
b	Re-EQ	On, Off
c	Surround Speakers	Surround L/R, Surround Back, Surround L/R+Back
d	Digital Upsampling	Off, On

The d. Digital Upsampling can only be set for PCM input sources. Furthermore, if this is set to On, c. Surround Speaker is fixed to "Surround L/R."

Listening Mode Setup

3-6. Surround (Digital) Setup

Select this to modify the plain Dolby Digital, DTS, MPEG, and Pro Logic Surround listening modes when the current source is digital. The parameters that can be set are shown in the table below.

	Parameter	Setting Initial value
a Subwoofer	Off, On	On
b Re-EQ	Off, On	Off
c Surround Speakers	Surround L/R, Surround Back, Surround L/R+Back	Surround L/R

3-7. THX Setup

Select this to modify the THX Cinema or Pro Logic THX listening modes; the one that is currently set is the one that is modified. The parameters that can be set are shown in the table below.

	Parameter	Setting Initial value
a Subwoofer	Off, On	On
b Re-EQ	Off, On	On
c Surround Speakers	Surround L/R, Surround Back, Surround L/R+Back	Surround L/R

3-7. DTS Film Setup, MPEG Film Setup

Select this to modify the DTS Film or MPEG Film listening modes; the one that is currently set is the one that is modified. The parameters that can be set are shown in the table below.

	Parameter	Setting Initial value
a Subwoofer	Off, On	On
b Re-EQ	Off, On	Off
c Surround Speakers	Surround L/R, Surround Back, Surround L/R+Back	Surround L/R

3-7. +Action Setup, +Musical Setup

Select this to modify the Action, Musical, Dolby Pro Logic Action, or Dolby Pro Logic Musical listening modes; the one that is currently set is the one that is modified. The parameters that can be set are shown in the table below.

	Parameter	Setting Initial value
a Subwoofer	Off, On	On
b Re-EQ	Off, On	Off
c Surround Speakers	Surround L/R, Surround Back, Surround L/R+Back	Surround L/R
d Front Effect	Off, On	On
e Reflect Level	-5dB to +5dB	0dB
f Reverb Level	-5dB to +5dB	0dB
g Room Size	Small, Mid-small, Middle, Mid-large, Large	Middle

3-7. Theater-Dimensional Setup

Select this to modify the Theater-Dimensional (T-D) listening modes. The parameters that can be set are shown in the table below.

	Parameter	Setting Initial value
a Subwoofer	Off, On	On
b Listening Angle	20deg, 40deg	20deg
c Center	Off, On	Off
d Front Expander	Off, On	On
e Virtual Surr Level	-3dB to +3dB	0dB
f Dialog Enhance	Off, On	Off

3-7. Enhanced 7 Setup

Select this to modify the Enhanced 7 listening mode. The parameters that can be set are shown in the table below.

	Parameter	Setting Initial value
a Subwoofer	Off, On	On
b Re-EQ	Off, On	Off
c Front Effect	Off, On	On
d Reflect Level	-5dB to +5dB	0dB
e Reverb Level	-5dB to +5dB	0dB
f Room Size	Small, Mid-small, Middle, Mid-large, Large	Middle

3-7. Orchestra Setup, Unplugged Setup, Studio-Mix Setup, TV Logic Setup

Select this to modify the Orchestra, Unplugged, Studio-Mix, and TV Logic listening modes; the one that is currently set is the one that is modified. The parameters that can be set are shown in the table below.

	Parameter	Setting Initial value
a Subwoofer	Off, On	On
b Re-EQ	Off, On	Off
c Surround Speakers	Surround L/R, Surround Back, Surround L/R+Back	Surround L/R
d Front Effect	Off, On	On
e Reflect Level	-5dB to +5dB	0dB
f Reverb Level	-5dB to +5dB	0dB
g Room Size	Small, Mid-small, Middle, Mid-large, Large	Middle

3-7. All Ch Stereo Setup

Select this to modify the All Ch Stereo listening mode. The parameters that can be set are shown in the table below.

	Parameter	Setting Initial value
a Subwoofer	Off, On	On
b Re-EQ	Off, On	Off

3-7. Mono Movie Setup

Select this to modify the Mono Movie listening mode. The parameters that can be set are shown in the table below.

	Parameter	Setting Initial value
a Subwoofer	Off, On	On
b Re-EQ/Academy	Off, Re-EQ, Academy	Off
c Surround Speakers	Surround L/R, Surround Back, Surround L/R+Back	Surround L/R
d Front Effect	Off, On	On
e Reflect Level	-5dB to +5dB	0dB
f Reverb Level	-5dB to +5dB	0dB
g Room Size	Small, Mid-small, Middle, Mid-large, Large	Middle

Listening Mode Setup

Description listening mode parameters

Subwoofer

Set this to "Off" if you are not using a subwoofer (even if one is connected). If "No" is selected for the Subwoofer setting in the Speaker Config sub-menu, then this setting will not appear.

Re-EQ/Academy

Depending on the listening mode, you can either turn Re-EQ on or off, or you can select "Re-EQ," "Academy," or "Off."

Re-EQ: Re-EQ (re-equalization) takes the edginess or "brightness" out of your home cinema sound to compensate for the fact that sound mixed for theaters may sound too bright when played back through speakers in the home environment.

Academy: Older monaural film mixes relied on high-frequency rolloff in presentation to sound properly balanced, so that excessive hiss from the grain structure of the film would not be heard. The high-frequency loss was typically due to a combination of optical slit loss, electrical filters, loudspeaker response, and screen loss. Some films have been transferred to video without such a high-frequency rolloff, and thus sound overly bright and hissy. The TX-DS989 includes this "Academy filter," which is based on contemporary playback practices for such films over wide-range systems.

On: Select to turn on the Re-EQ.

Off: Select to turn off both the re-equalization and Academy filters.

Input Channel

This allows you to set which input channel to use for monaural sound.

Auto L+R: Select this under normal circumstances for output from both the left and right speakers.

Left/Right: You will need to select either left or right when playing a video source that contains bilingual data. In such a case, the left and right channels will contain different language. Select the channel with the language you desire.

Output Channel

This allows you to set which output channel to use for monaural sound. If "None" is selected for the Center Speaker setting in the Speaker Config sub-menu, then this setting will not appear.

L+R: The monaural sound is split between the left and right channels.

Center: The monaural sound is output from the front center channel.

Digital Upsampling

Digital upsampling processes the input digital signal and converts its digital sampling frequency to twice the current frequency for an even further detailed sound reproduction. This can be set to either "On" or "Off."

Surround Speakers

This setting allows you to decide through which speakers to output the sound meant for the surround speakers during 5.1-channel output when seven speakers are connected to the TX-DS989.

Surround L/R: This outputs the sound to the surround left and right speakers as normal and outputs nothing to the surround back left and right speakers.

Surround Back: This outputs the sound to the surround back left and right speakers and outputs nothing to the surround left and right speakers.

Sur L/R+Back: This outputs the sound to both the surround left and right speakers and the surround back left and right speakers.

Front Effect

Some live recordings contain acoustic reverberation. When you play these sources, more reverberation will be applied by the DSP, creating too much reverb effects and the sound loses frame or presence. In this case, set this setting to "Off." No reverberation from the DSP will be applied to the sound output from the three front channels, so the sound source is played as it is without any further reverberation.

Reflect Lvl

This parameter allows you to adjust the strength of direct sound reflections to match the playback source material, the acoustics of your room, and such other factors. This can be set between -5 and +5 decibels in 1-decibel increments.

Reverb Lvl

This parameter allows you to adjust the depth of acoustic reverberation to match the playback source material, the acoustics of your room, and such other factors. This can be set between -5 and +5 decibels in 1-decibel increments.

Room Size

This parameter allows you set virtual hall size to simulate for each surround mode. You can choose from "Large," "Mid-Large," "Middle," "Mid-Small", or "Small."

Listening angle

The listening angle is the angle subtended by the front left and right speakers as seen from the listener. The setting of 20 and 40 degrees are only for nominal purposes, so select the setting that is closest to your actual listening angle.

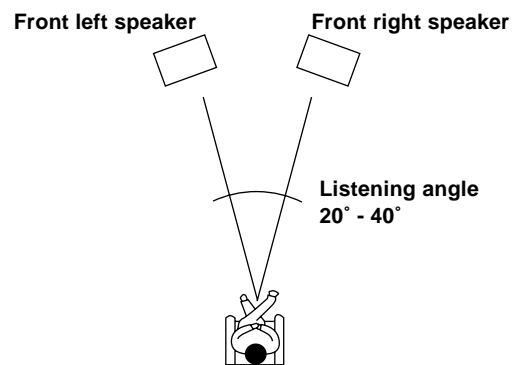

Listening Mode Setup

Center

For systems that have a center speaker, the center channel signal can be output from the center speaker. For instance, in systems where the front left and right speakers are small, use of the center speaker may provide a better sound space. (If your system uses a center speaker, be sure to perform the level calibration with the left and right speakers in the Speaker Setup menu beforehand.)

On: The center channel signal is output to the center speaker.

Off: The center channel signal is output from the front left and right speakers (Phantom Center).

Front Expander

The front expander function spreads out the sound from the front speakers for the feeling of a wide sound space.

On: Select to turn on the front expander function to simulate a wider sound space.

Off: Select to turn off the front expander function for a normal sound space.

Virtual Surr Level

This parameter adjusts the virtual surround level. This can be set from -3 to +3 decibels.

Dialog Enhance

This parameter allows you to adjust the dialog sound level from the center speaker if it is difficult to hear.

On: Enhances the vocal ranges for the center channel signal.

Off: Outputs the center channel signal at the regular level and frequency characteristics.

Relationship between listening mode and parameter

Listening mode Parameter	Direct	Mono (Analog/PCM)	Mono (Digital)	Stereo (Analog/PCM)	Stereo (Digital)	Surround* (Analog/PCM)	Surround* (Digital)	THX Cinema
Subwoofer		●	●	●	●	●	●	●
Re-EQ (/Academy)		●	●	●	●	●	●	●
Input Channel		●	●					
Output Channel		●	●					
Surround Speakers						●	●	●
Digital Upsampling				●		●		
Front Effect								
Reflect Level								
Reverb Level								
Room Size								
Listening Angle								
Center								
Front Expander								
Virtual Surr Level								
Dialog Enhance								

Listening mode Parameter	DTS Film	MPEG Film	+Action**/ +Musical	Theater Dimensional (T-D)	Enhance7	Orchestra/ Unplugged/ Studio-Mix/ TV Logic/ Mono Movie	All Ch Stereo
Subwoofer	●	●	●	●	●	●	●
Re-EQ (/Academy)	●	●	●		●	●	●
Input Channel							
Output Channel							
Surround Speakers	●	●	●			●	
Digital Upsampling							
Front Effect			●		●	●	
Reflect Level			●		●	●	
Reverb Level			●		●	●	
Room Size			●		●	●	
Listening Angle				●			
Center				●			
Front Expander				●			
Virtual Surr Level				●			
Dialog Enhance				●			

The parameters that can be set are different for each listening mode.

* The surround given here refers to basic surround modes and consists of Dolby Pro Logic, Dolby Digital, DTS, MPEG, etc.

** +Action and +Musical refers to Dolby Digital Action, Dolby Digital Musical, DTS Action, DTS Musical, MPEG Action, MPEG Musical, Dolby Pro Logic Action, and Dolby Pro Logic Musical.

Preference

4. Preference menu

This menu provides settings for you to customize certain functions of the TX-DS989 as you wish.

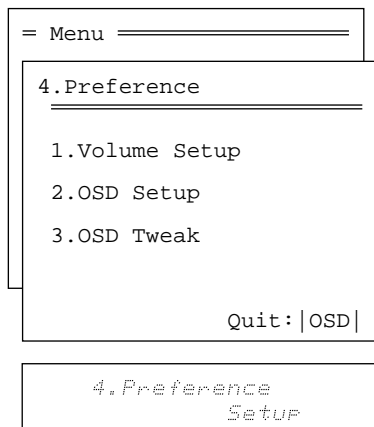

4-1. Volume Setup sub-menu

This sub-menu allows you to make various settings concerning the volume control of the TX-DS989.

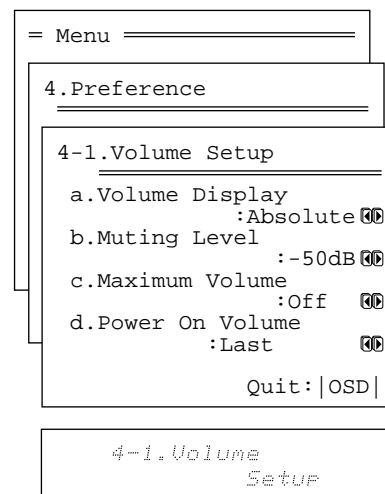

a. Volume Display

You can choose from two ways of displaying the volume setting on screen.

Absolute: This displays the volume with a minimum of min (0) for no sound and a maximum of max (100). As a reference, the volume setting of Ref (82) is used as the 0 -decibel for the relative display method.

Relative: This displays the volume as a decibel value on a scale with a designated reference point that is displayed as 0, which equals the volume setting of 82 for the absolute display method. With this display method, the minimum value is $-\infty$, the next highest is -81, and the maximum value is +18.

b. Muting Level

This sets the attenuation level during playback when the Muting button is pressed on the remote controller. This can be set between $-\infty$, -50 and -10 decibels in 10-decibel increments.

c. Maximum Volume

This sets a maximum limit for the master volume to reduce the chance of any components becoming damaged from accidental increases to the volume. For the absolute volume display method, this can be set between 50 and 90. For the relative volume display method, this can be set between -32 and +17 decibels.

d. Power On Volume

This sets a designated volume setting for the TX-DS989 to be set every time that the power is turned on. This prevents the TX-DS989 from being turned on while it is set to an extremely high volume and suddenly output very loud sounds. For the absolute volume display method, this can be set between 0 and 99. For the relative volume display method, this can be set between $-\infty$ and +18 decibels. If you do not mind having the TX-DS989 turned on with its current volume setting, set this to "Last Valid."

Preference

4-2. OSD Setup sub-menu

This sub-menu allows you to customize the OSD menu to display in the manner you desire.

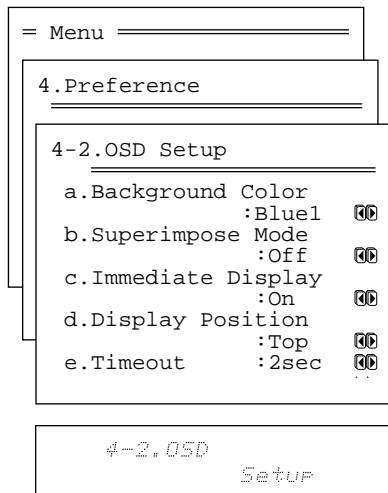

a. Background Color

Select either Blue1, Blue2, Green1, Green2, Magenta, Red1, or Red2 as the background color while the OSD menu is displayed.

b. Superimpose

Off: Select to have the OSD menu displayed on the selected background color.

Normal: Select to have the OSD menu superimposed over the current video if one is displayed or on the selected background color if there is no video signal.

Black: Select to have the OSD menu displayed on a black background at all times.

c. Immediate Display

On: Select this to have the screen immediately display certain operations as you perform them and maintain the display for a set amount of time after you are finished. For example, if you change the volume, the volume level will appear on the screen as it is changed.

Off: Select this to turn off the immediate display of operations.



Note:

The name that you input at the Character Input sub-menu (page 41) will not be reflected by the immediate display displayed when the input source is changed. For example, if your second DVD player is connected to VIDEO 5 and you change its name to "DVD-2," when it is selected as the input source, the immediate display still reads "VIDEO 5."

d. Display Position

Use this setting to select the position of the immediate display that appears when certain operations are performed. You can position the immediate display at any of ten different levels ranging from the top all the way to the bottom.

e. Timeout

Use this setting to select the amount of time the immediate display remains after the operation is completed. You can have the immediate display remain for 2, 3, 4, or 5 seconds.

4-3. OSD Tweak

This setting allows you to adjust the position of the OSD menu as it is displayed on your screen. Depending on the monitor used, there may be cases where the OSD menu is not displayed in the center and parts of the menus are cut off. To adjust the position of the OSD menu, simply press the cursor buttons to inch the menu to position you desire.

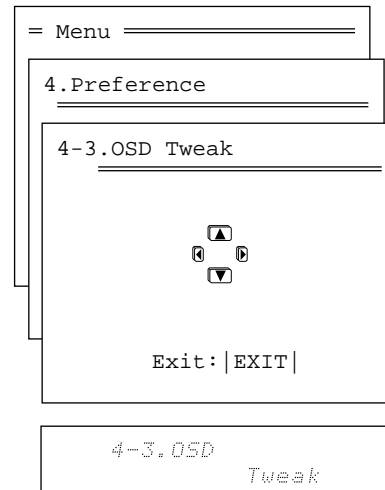

Zone2 OSD Setup

5. Zone2 OSD Setup menu

The settings for this menu are the same as those for the OSD Setup sub-menu of the Preference menu. Refer to the OSD Setup sub-menu for an explanation of the settings in this menu.

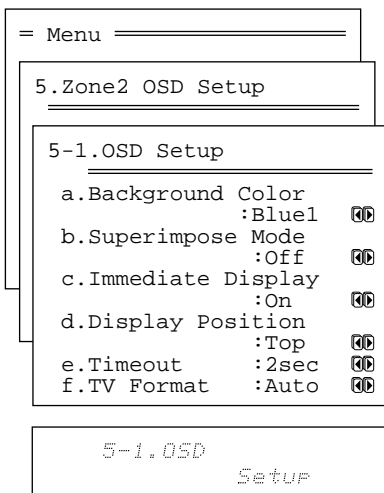
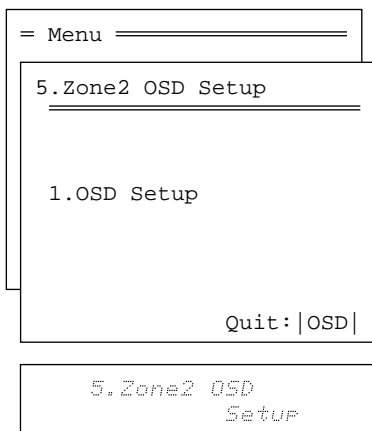

Note:

The relationship between the OSD menu for the main zone and remote zone (Zone 2)

The TX-DS989 cannot output the OSD menu for both the main and remote zones simultaneously. For example, if an input source with no image is selected at the main zone (only the background color is displayed on the television screen) and the Zone 2 input source is changed, then the display at the main zone changes from the background color to a display with no image and the display at Zone 2 changes to the OSD menu (Immediate Display). This is not a malfunction. To prevent this, change the c. Immediate Display setting for the 5-1. OSD Setup sub-menu to "OFF."

The default setting for the c. Immediate Display setting of the 5-1. OSD Setup sub-menu is "OFF."

About

6. About menu

This menu consists of sub-menus that allow you to lock the controls of the TX-DS989 and display its software version.

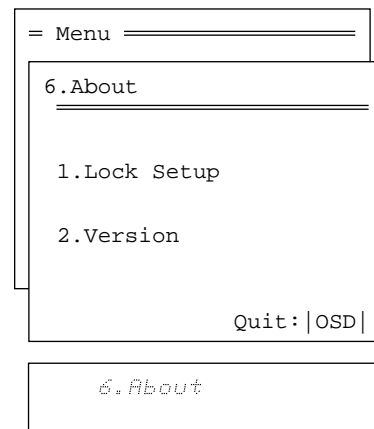

6-1. Lock Setup sub-menu

When "Locked" is selected for this setting, it prevents all settings in the OSD menu from being changed. This makes sure that the time-consuming settings that have been set are not changed by mistake. The default setting is "Unlocked."

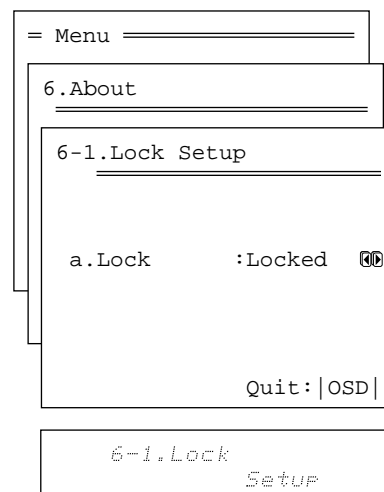

6-2. Version

This displays the version number of the microcomputer currently installed in your TX-DS989.

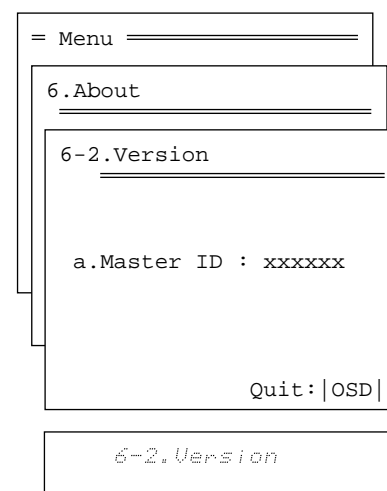

Enjoying music or videos in the remote zone

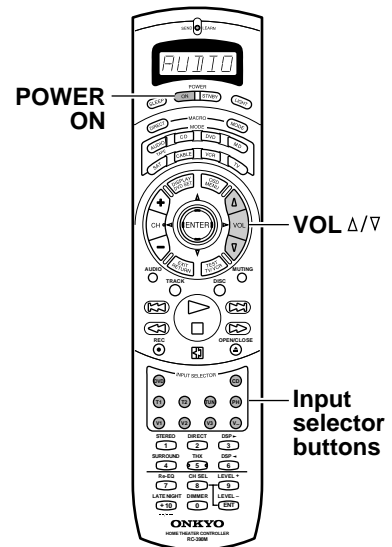
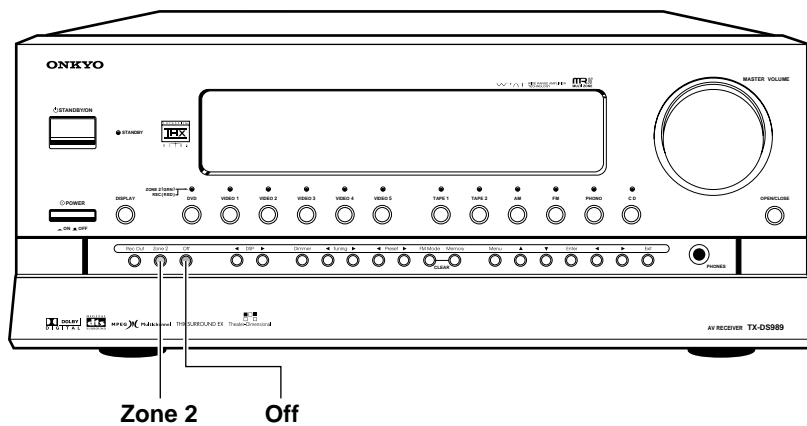

Controlling the TX-DS989 from the remote zone

1. Aiming at the remote sensor, press the **POWER ON** button on the remote controller.

Note:

Be aware that if you start using the system in the remote zone (Zone 2) while a recording is going on in the main zone, the recording is aborted.

2. Press the appropriate input selector button on the remote controller to select the desired source.
3. Adjust the volume on the power amplifier to the desired level.

Controlling the TX-DS989 without the remote controller

1. Press the **Zone 2** button on the TX-DS989.

2. **Select a source.**

After pressing the Zone 2 button, you must press an input source button within 8 seconds. To select the same source as that selected for the main zone, press the Zone 2 button twice in succession. The indicator above the selected input source will light green. Adjust the volume in the remote zone as desired.

Ex.: When the Zone 2 button is pressed twice

```
Zone2 Selector
:SOURCE
```

Ex.: When the Zone 2 button and then VIDEO 4 button are pressed

```
Zone2 Selector
:VIDEO4
```

Notes:

- If the Zone 2 button was pressed twice so that the same source is being played in the main and remote zones, then changing the input source in the main zone also changes the input source for the remote zone.
- In the remote zone, you can only play the source in the 2-channel mode. You cannot play the source in the remote zone in the surround mode.
- If the Rec Out button is pressed in the main room while someone is using the system in the remote zone, the Zone 2 function will be deactivated and the source will turn off in the remote zone.
- The Zone 2 terminal is an analog output. Digital signals are not output. If no sound is heard from the selected input source, check if the component is connected to the analog inputs.
- Please note that some third-party multi-room system components may not be fully compatible with the Onkyo multi-room system components.
- **If you are not using the system in the remote zone, always press the Zone 2 button and then the Off button to turn the Zone 2 function off.**

Listening to Radio Broadcasts

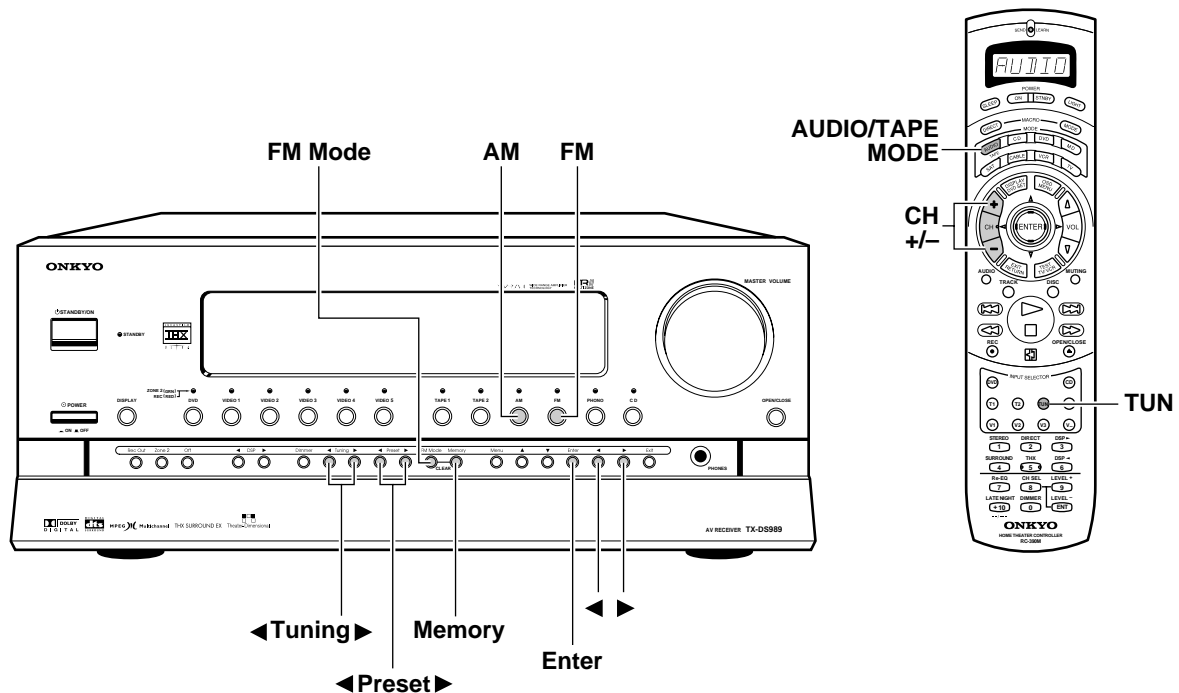

Listening to FM/AM Radio Stations

One of the features of the TX-DS989 that is most frequently used is its ability to play FM and AM broadcast radio stations. The TX-DS989 provides a number of listening modes perfect for listening to the radio and getting the most out of your audio system. Also, by presetting radio stations that you listen to frequently, you can use the PRESET buttons on the front panel to go to them automatically.

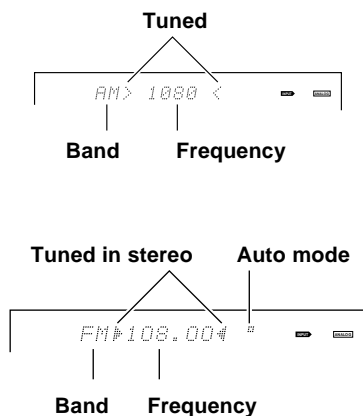

Tuning into a radio station

1. Press either the AM or FM input source button.
2. Using the ◀ and ▶ Tuning buttons on the front panel, tune into the station you desire.

When you tune into a radio station, > < surrounds the displayed frequency. If you tune into an FM station in stereo, then ▶ ◀ surrounds the displayed frequency. If the signal is weak, it may be impossible to tune into the station in stereo. In such a case, press the FM Mode button under the cover on the front panel. "Mono" appears for a few seconds under the frequency in the front display. To return to stereo, press the FM Mode button again. "Auto" appears for a few seconds and then "∴" appears to the right of the frequency. Some inter-station noise may be heard, but the sound will not cut in and out as it would if stereo was selected.

- The tuner frequency changes in 50 kHz increments for FM and 10 kHz increments for AM.
- When FM is selected, you can use the auto-search feature by pressing and holding down one of the TUNING buttons. The tuner frequency will search in the direction of the button pressed for the next station that can be tuned into in stereo.

Listening to Radio Broadcasts

Presetting a radio station

1. Tune into the radio station you desire (see "Tuning into a radio station" above).

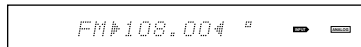

2. Press the Memory button on the front panel.

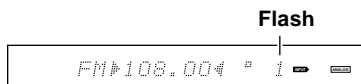

3. Using the ◀ or ▶ cursor buttons, select a preset number (from 1 to 40) to assign the station to be preset.

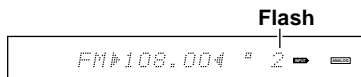

4. Press the Enter button again to finalize the procedure.

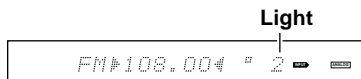

This programs the radio station as a preset radio station.

- Up to 40 stations can be stored in memory as preset radio stations.
- Using the OSD Menu, you can enter names to each preset radio station (see page 41).

Selecting a preset radio station

1. Press either the AM or FM input source button. (or press the TUN button on the remote controller when in AUDIO mode)
2. Press the ◀ and ▶ Preset buttons on the front panel (or the CH+ or CH- buttons on the remote controller) to scroll through the preset radio stations until you reach the one you want.

Erasing a preset radio station

1. Using the ◀ and ▶ Preset buttons, select the preset radio station that you want erase (see above).
2. Press and hold down the Memory button while you press the FM Mode button.

This erases the selected preset station.

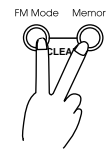

Enjoying music or videos with the TX-DS989

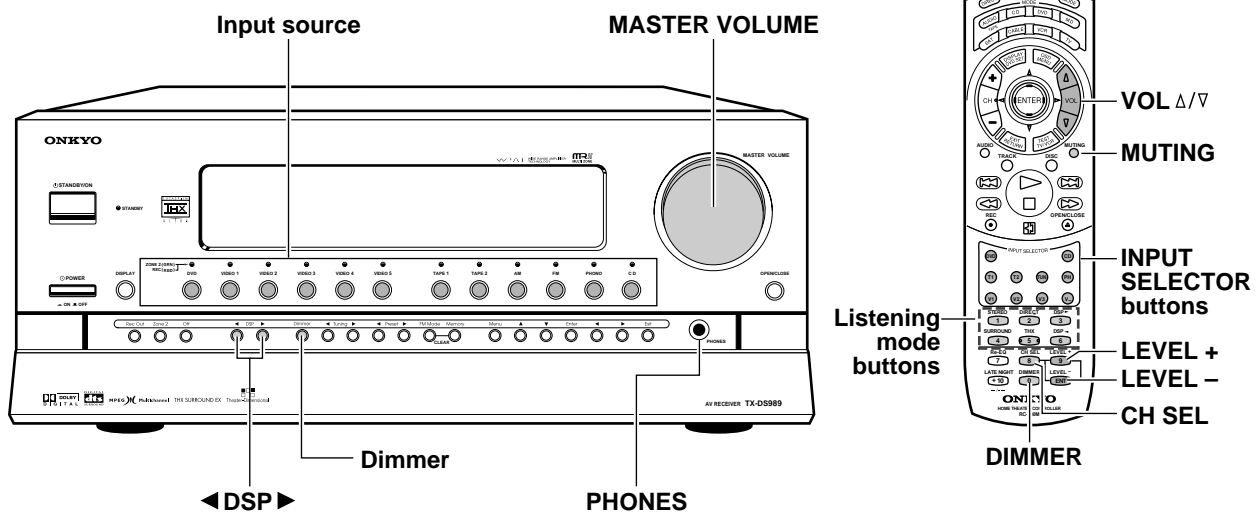

Though the TX-DS989 is often used to listen to the radio, it does not show you its true ability until it is used to play music or watch videos, LDs, DVDs, and the like. The TX-DS989 has the latest in state-of-the-art features to play back today's acoustic technologies with the utmost in fidelity and power. From a two-speaker system to a seven-speaker system, you are assured a sound space that you can always enjoy.

Selecting an input source

Before you can listen to any input media, you must first select the input source at the TX-DS989. This tells it which input source to output to the speakers and monitor.

To select an input source, simply press the button on the front panel (or on the remote controller) that corresponds to the input source you want.

After you have selected the input source, simply turn on the corresponding component and play the media.

Adjusting the volume

Adjusting the main volume adjusts the volume level output from all the speakers connected to the TX-DS989 together. If headphones are connected, this also adjusts the volume heard from the headphone. To adjust the volume, either press the VOL Δ/∇ buttons on the remote controller or turn the MASTER VOLUME dial. To increase the volume, turn the dial to the right; to decrease the volume, turn the dial to the left.

Changing the listening mode

To change the listening mode during playback, press the \blacktriangleleft and \blacktriangleright DSP buttons on the front panel or the listening mode buttons on the remote controller (see page 57).

Listening with headphones

To listen with headphones, plug a pair of headphones with a standard stereo plug into the PHONES jack on the TX-DS989 front panel. When you connect headphones, the unit will enter STEREO mode automatically and no sound will be heard from the speakers.

Using the many features of the TX-DS989

Outputting from different input source:

You can have the TX-DS989 output the audio of one input source through the speakers while the video of another input source is output to the monitor (see "2-3. Video Setup sub-menu" on page 36).

Assigning names to input sources:

You can enter a name for each input source so that when the source is selected the name of that source is displayed in the front display of the TX-DS989 (see "2-7. Character Input sub-menu" on page 41).

Temporarily changing the speaker output levels:

To change the individual speaker volumes temporarily, use the remote controller and follow the procedure given below. Note that the calibration settings will return to the original settings when the TX-DS989 is put in standby.

1. Press the CH SEL button and select the desired speaker.
2. Press the LEVEL + or - button to adjust the volume level.

Enjoying music or videos with the TX-DS989

Using the sleep time:

To set the sleep timer, press the SLEEP button on the remote controller and then set the time that you want the TX-DS989 to enter the standby state (see page 57).

Temporarily turning off the sound:

To turn off the sound momentarily, such as when interrupted by a phone call, press the MUTING button on the remote controller (see page 57).

Adjusting the bass and treble:

You can adjust the bass and treble levels at the Sound Effect sub-menu of the OSD menu: Input Setup → Sound Effect (see page 40).

Adjusting the brightness of the front display:

You can adjust the brightness of the front display of the TX-DS989 with DIMMER button on the remote controller or on the TX-DS989 front panel (see page 57).

If one of the messages shown below appears

If one of the messages shown below appears in the front display, it is telling you that the operation you are trying to perform is not possible for the reason given in the message.

Not available
with HP in

The operation is not allowed because headphones are plugged into the TX-DS989.

Not available
in Multi Ch

The operation is not allowed because the selected input source is set for multichannel input.

Not available
in this Sp.Cfg

The operation is not allowed by the current speaker configuration.

Not available
other than DD

No setting other than Dolby Digital can be set.

Enjoying the multichannel output

Before you can use a component with multichannel output, you must first select "Yes" for the Multichannel setting in the OSD menu for that input source: Input Setup → Multichannel Setup (see page 36).

1. Press the input source button for the component with multichannel output connected to the MULTI CHANNEL INPUT on the rear of the TX-DS989.
2. Turn on the connected component and start playing the desired media.
3. If necessary, press the CH SEL button on the remote controller to select an individual speaker. Then press the LEVEL + or – button to adjust the output level as desired.

Adjust the speaker output levels so that you can hear the same sound level from each speaker at the listening position. For the front right, front left, center, surround right, surround left, surround back right and surround back left speakers, the output levels can be adjusted between –12 to +12 decibels. The subwoofer can be adjusted between –30 and +10 decibels.

4. Adjust the volume with the MASTER VOLUME dial or the VOL Δ/∇ buttons on the remote controller.

Recording a source

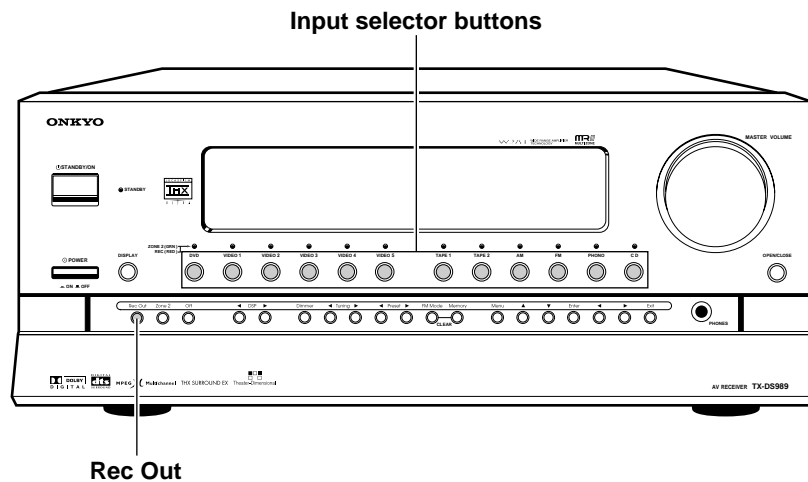

Of course the TX-DS989 can also be used to record an input source media. This allows you to make copies of the music or videos you like, copy them from one type of media to another, or even record what is being broadcast on television or radio. Be aware that the Rec Out and Zone 2 buttons use the same circuit so that you cannot make recording and output to the remote zone (Zone 2) at the same time.

To record the input source signal you are currently watching or listening to

This method outputs to the audio and video outputs the currently selected input source signal. This method allows you to a signal while you are actually listening to or watching it.

1. Select the input source to record by pressing the corresponding input selector button.

The input source is now selected and you may watch or listen to it as desired.

2. Press the Rec Out button twice within 8 seconds.

Pressing the Rec Out button twice outputs the currently selected input source signal to the TAPE 1 OUT, TAPE 2 OUT, VIDEO 1 OUT, and VIDEO 2 OUT outputs for recording. The indicator above the selected input source lights red.

3. Start recording at the recording component as desired.

To confirm the settings, press the Rec Out button. The current settings will appear for 8 seconds in the front display.

```
Rec Selector  
:SOURCE OPT3
```

Notes:

- If you change the input source during recording, you will record the signals from the newly selected input source.
- You cannot record the surround effects.
- Digital signals input to the DIGITAL INPUT (COAXIAL) and DIGITAL INPUT (OPTICAL) inputs will be output to the DIGITAL OUTPUT (COAXIAL) and DIGITAL OUTPUT (OPTICAL) outputs.
- Digital input signals are only output to the digital outputs and analog input signals are only output from the analog outputs. There is no conversion from digital to analog or vice versa. When connecting CD players and other digital components, do not connect only the digital terminals, but the analog ones as well.
- There are some restrictions on recording digital signals. When making digital recordings, consult the instruction manual that came with your digital recording equipment (e.g., MD recorder or DAT deck) to know what restrictions are imposed.
- You cannot record the source connected to the MULTI CHANNEL INPUT connector.

Recording a source

To record an input source signal different from that you are currently watching or listening to

This method outputs to the audio and video outputs the signal from the input source that you select here. This allows you to record an input source signal different from that that you are listening to or watching at the time of recording.

1. Press the Rec Out button.
2. Within 8 seconds, press the input source selector button of the input source signal that you wish to record.

The indicator above the selected input source will light red. The signal from the selected input source will now be output to the TAPE 1 OUT, TAPE 2 OUT, VIDEO 1 OUT, and VIDEO 2 OUT outputs for recording.

3. Start recording at the recording component as desired.

To confirm the settings, press the Rec Out button. The current settings will appear for 8 seconds in the front display.

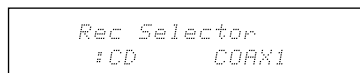

Notes:

- Be aware that the remote (Zone 2) and recording (Rec Out) outputs use the same circuit and therefore can be used at the same time.
- You cannot record the surround effects.
- Digital signals input to the DIGITAL INPUT (COAXIAL) and DIGITAL INPUT (OPTICAL) inputs will be output to the DIGITAL OUTPUT (COAXIAL) and DIGITAL OUTPUT (OPTICAL) outputs.
- There are some restrictions on recording digital signals. When making digital recordings, consult the instruction manual that came with your digital recording equipment (e.g., MD recorder or DAT deck) to know what restrictions are imposed.
- You cannot record the source connected to the MULTI CHANNEL INPUT connector.

Recording the video from one source and the audio from another

You can add the sound from one source to the video of another source to make your own video recordings.

Below is an example of recording the sound from a compact disc player connected to CD IN and the video from a video camera connected to VIDEO 5 IN to video cassette tape in a video cassette recorder connected to the VIDEO 1 OUT jack.

1. Press the CD input source button.
2. Set "VIDEO 5" for the Video setting in the Video Setup sub-menu of the OSD menu: Input Setup → Video Setup → Video.
3. Insert a CD in the CD player and insert a tape in the video camera connected to the VIDEO 5 IN.
4. Insert a video tape for recording in the video cassette recorder connected to VIDEO 1 OUT.
5. Press the Rec Out button twice within 8 seconds.

The indicator above the CD input source button lights red. Now "CD" has been selected as the audio input source and "VIDEO 5" as the video input source.



6. Start recording on the video cassette recorder and start playing at the CD player and video camera as desired.

Notes:

- If you change the input source during recording, you will record the audio signals from the newly selected input source and the video signals assigned to that input source.
- You cannot record the surround effects.

Using remote controller

Overview

The RC-390M remote controller is a useful tool to help you operate the components of your home theater. To do so, first press the MODE button that corresponds to the device you wish to control. At this time, the display on the remote controller will change to show the component that is selected. Then simply press the desired operation button and the component will operate accordingly. For example, if you wish to select the CD input source at the TX-DS989 with the remote controller, first press the AUDIO/TAPE MODE button to select the TX-DS989 ("AUDIO" will appear on the display) and then press the CD (INPUT SELECTOR) button.

Using the remote controller to control each device

In order to use the remote controller, you must first turn on the POWER switch at the TX-DS989 so that it enters standby mode.

1. Press the AUDIO/TAPE MODE button.

"AUDIO" appears in the remote controller display.

2. Press the POWER ON button to turn on the TX-DS989 and press the POWER STNBY button to put it back in the standby mode.

When you press the POWER STNBY button on the remote controller, it puts the TX-DS989 in the standby state but does not turn it completely off.

SEND/LEARN indicator

This indicator acts as a guide when commands are programmed into or sent by the remote controller. It also warns the user when an error is made or battery power is low.

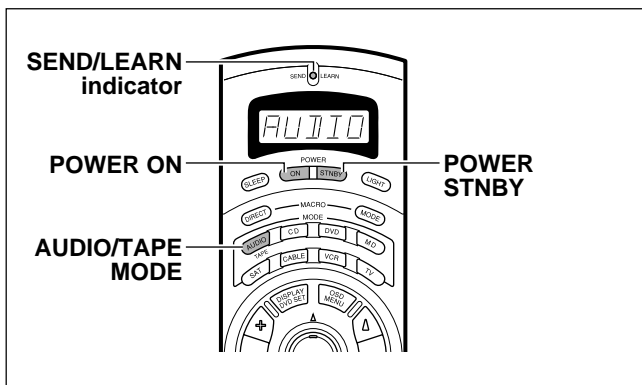

Controlling the TX-DS989

If "AUDIO" is already appears in the display, proceed to step 2.

1. Press the AUDIO/TAPE MODE button.

"AUDIO" appears in the remote controller display.

2. Press the desired operation button. The buttons shaded in the figure to the left are the operation buttons that can used to control the TX-DS989.

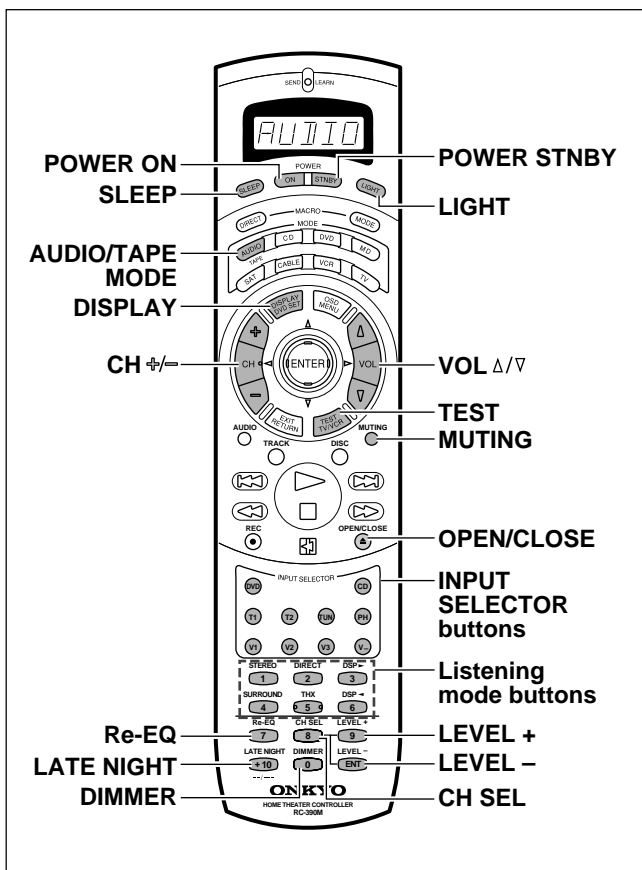

Using remote controller

LIGHT: Illuminates the buttons

SLEEP: Sets the sleep function

- The SLEEP buttons enables you to set the TX-DS989 to turn off automatically after a specified time period. If you press it once, the TX-DS989 will turn off after 90 minutes. Each time it is pressed thereafter, the remaining time until the TX-DS989 turns off decreases by 10 minutes. While, the sleep function is enabled, you can press the SLEEP button to see how much time is left. To cancel the sleep function, press the SLEEP button when the time displayed is less than 10 minutes.

POWER ON/STNBY: Turns on the TX-DS989 or puts it in standby

DISPLAY: Changes the display

- Same as the DISPLAY button on front panel of the TX-DS989.

VOL Δ/∇ : Adjusts the volume

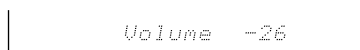

CH \neq : Selects the tuner preset stations

TEST: Outputs a test tone for setting speaker levels

- Use this button in conjunction with the LEVEL +/- and CH SEL buttons to calibrate the speakers levels without entering the OSD Menu. When TEST button is pressed, the test noise (pink noise) is output. Use the LEVEL +/- buttons to increase or decrease the sound level. Use the CH SEL button to change from speaker to speaker. For a more detailed explanation of how to calibrate the speaker levels, see page 32.

MUTING: Activates the mute function

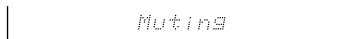

- This button turns down the playback sound immediately. This can be useful, for example, when you receive a telephone call while listening to music or another source. When pressed, "Muting" is displayed on the TX-DS989. Press the MUTING button again to turn the sound back on.
- The TX-DS989 allows you to set the volume when the MUTING button is pressed. This can be done at the OSD menu: Preference → Volume Setup → b. Muting Level (See page 46)

OPEN/CLOSE: Open and close the front door that covers the lower buttons.

INPUT SELECTOR: Selects an input source

- Same as the input selector buttons on front panel of the TX-DS989.

Re-EQ: Depending on the listening mode, you can either turn the cinema re-equalization function on or off, or you can select "Re-EQ," "Academy," or "Off"

- The re-equalization function takes the edginess or "brightness" out of your home cinema sound to compensate for the fact that sound mixed for theaters may sound too bright when played back through speakers in the home environment.

LATE NIGHT: Sets "High," "Low," or "Off" for the late night function

- Cinema sound has a vast dynamic range; therefore, to hear the quieter sounds such as human conversations, they must

be played back at larger volumes. When this parameter is set to "High" or "Low," the dynamic range of the sound is narrowed down to allow you to easily hear minute sounds at low volumes. This function is especially useful if you wish to play a movie at low volumes during the nighttime.

Notes:

- The depth of the Late Night effect is determined by Dolby Digital software. Some sounds may produce no or little effect.
- The Late Night function is effective only on Dolby Digital encoded software.

CH SEL: Selects a speaker for changing the speaker output level

- See TEST button above.

DIMMER: Adjusts the display brightness

- There are four settings available: normal, dark, very dark, and off.

LEVEL +: Increases the speaker level

- See TEST button above.

LEVEL -: Decreases the speaker level

- See TEST button above.

Listening mode buttons

STEREO: Changes the listening mode directly to stereo

- This button automatically changes the listening mode of the current input source signal to the stereo listening mode. The setting in the OSD Menu will also change accordingly.

SURROUND: Changes the listening mode directly to a plain surround mode.

- This button automatically changes the listening mode of the current input source signal to its corresponding surround mode (e.g., Dolby Pro Logic, Dolby Digital, DTS, and MPEG). The setting in the OSD Menu will also change accordingly.

DIRECT: Changes the listening mode directly to direct

- This button automatically changes the listening mode of the current input source signal to the direct listening mode. The setting in the OSD Menu will also change accordingly.

THX: Changes the listening mode directly to the THX Cinema mode

- If the THX mode was already selected, then this buttons changes the THX Surround EX setting as follows:

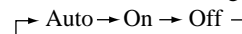

Auto: For THX Surround EX encoded sources, the listening mode is automatically set to THX Surround EX, and for other input sources, the listening mode is set to THX Cinema.

On: Regardless of the input source signal, the listening mode is set to THX Surround EX.

Off: Regardless if the input source signal is THX Surround EX, the listening mode is set to THX Cinema.

For more information on THX Surround EX, refer to pages 38-39.

DSP $\blacktriangleleft/\blacktriangleright$: Sets a new listening mode for the current input source signal

- Same as the DSP buttons on front panel of the TX-DS989.

Using remote controller

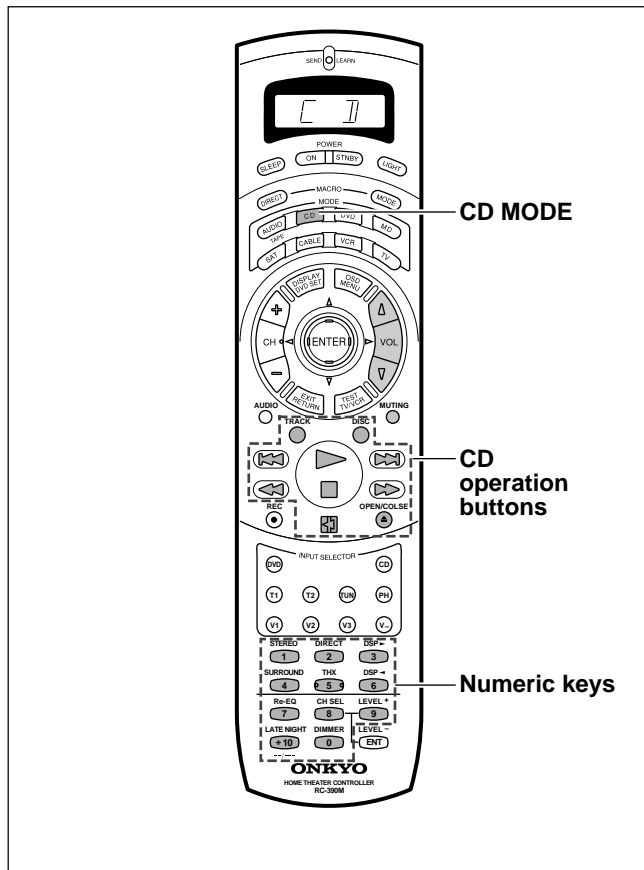

Controlling an Onkyo CD player

The RI connector of the Onkyo compact disc player must be connected to the TX-DS989 (see page 15).

1. **Press the CD MODE button.**
“CD” appears in the remote controller display.
2. **Press the desired operation button. The buttons shaded in the figure to the left are the operation buttons that can be used to control an Onkyo compact disc player.**

TRACK: Selects a track

DISC: Selects a disk in the CD changer

⏮: Track Down

⏭: Track Up

▶: Play

□: Stop

⏪: Fast Reverse

⏩: Fast forward

⏸: Pause

OPEN/CLOSE ⏏: Open/close the disc tray

0, 1 to 9, +10: Numeric keys

You may also use the following buttons:

VOL Δ/∇: Adjusts the volume at the TX-DS989

MUTING: Activates the muting function at the TX-DS989

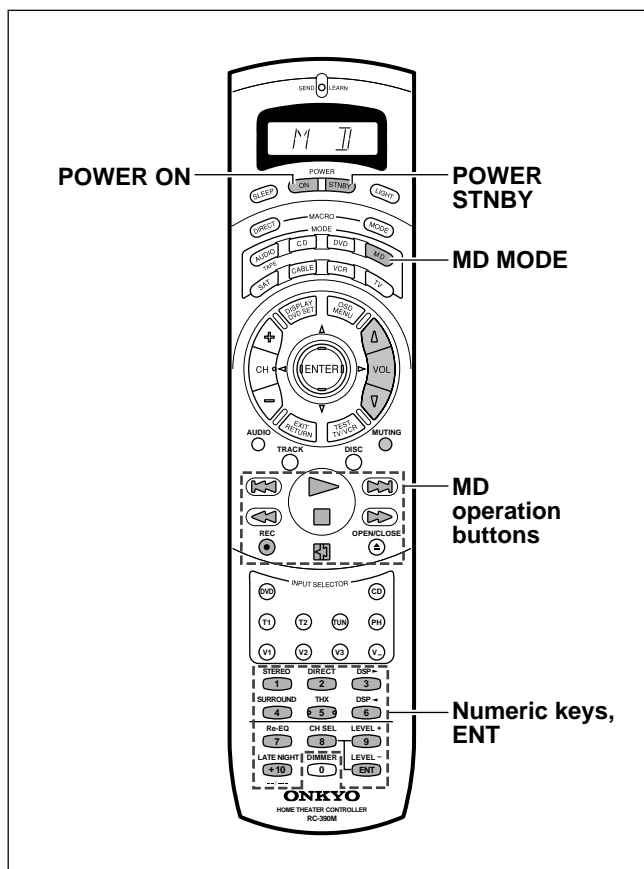

Controlling an Onkyo MD recorder

Make sure that you point the remote controller toward the sensor on the Onkyo MD recorder.

1. **Press the MD MODE button.**
“MD” appears in the remote controller display.
2. **Press the desired operation button. The buttons shaded in the figure to the left are the operation buttons that can be used to control an Onkyo mini disc player.**

POWER ON/STNBY: Turns the mini disc player on and off

⏮: Track Down

⏭: Track Up

▶: Play

□: Stop

⏪: Fast Reverse

⏩: Fast forward

REC ●: Record

⏸: Pause

⏏: Eject the disc

1 to 9, +10: Numeric keys

ENT: Enters the settings

You may also use the following buttons:

VOL Δ/∇: Adjusts the volume at the TX-DS989

MUTING: Activates the muting function at the TX-DS989

Using remote controller

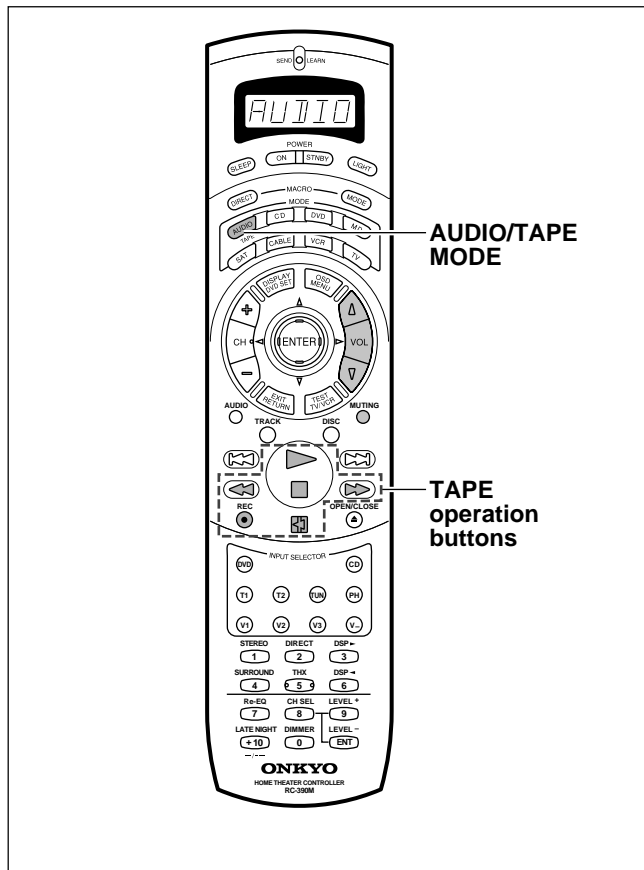

Controlling an Onkyo cassette tape deck

The **RI** connector of the Onkyo cassette tape deck must be connected to the TX-DS989 (see page 15).

1. Press the AUDIO/TAPE MODE button.

“AUDIO” appears in the remote controller display.

2. Press the desired operation button. The buttons shaded in the figure to the left are the operation buttons that can be used to control an Onkyo cassette tape player.

- ▷: Play
- ◻: Stop
- ◀◀: Fast Rewind
- ▶▶: Fast forward
- REC ●: Record
- ◻◻: Reverse playback

You may also use the following buttons:

VOL Δ/∇ : Adjusts the volume at the TX-DS989

MUTING: Activates the muting function at the TX-DS989

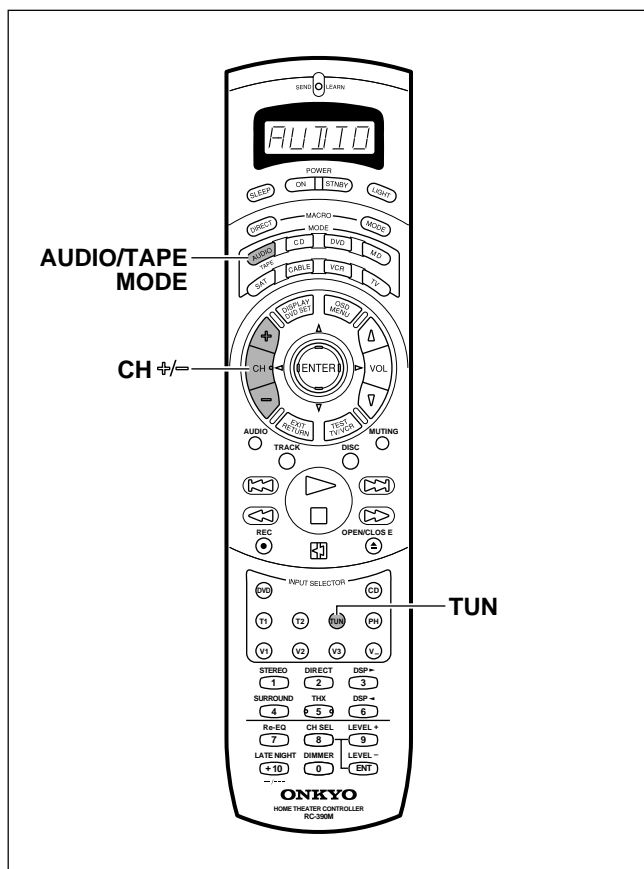

Calling up a preset radio station

1. Press the AUDIO/TAPE MODE button.

“AUDIO” appears in the remote controller display.

2. Press the TUN input selector button.

“(TUN)” appears in the remote controller display and momentarily and then “AUDIO” reappears.

3. Press the CH + or – button to select the desired the preset station number.

Using remote controller

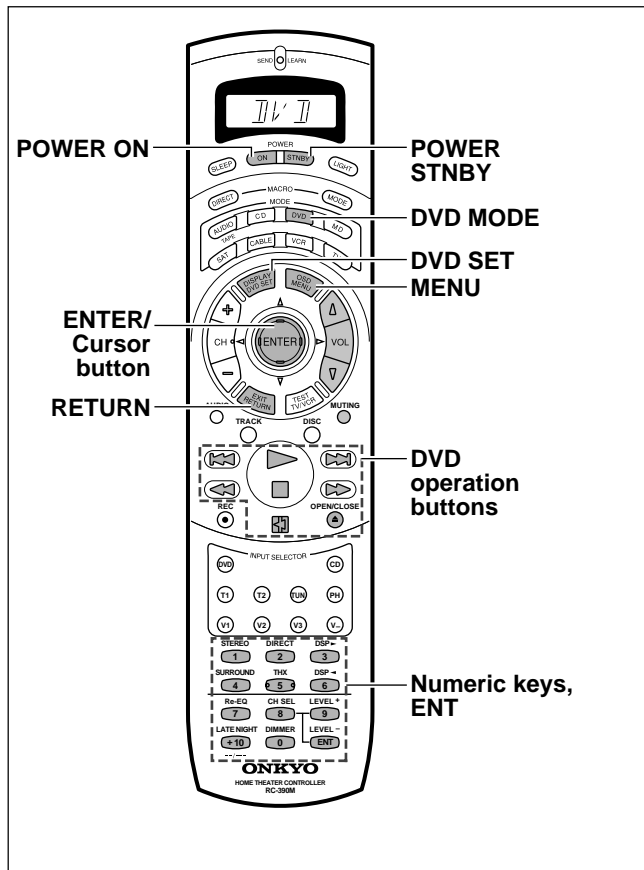

Controlling an Onkyo DVD player

Make sure that you point the remote controller toward the sensor on the Onkyo DVD player.

1. Press the **DVD MODE** button.
“DVD” appears in the remote controller display.
2. Press the desired operation button. The buttons shaded in the figure to the left are the operation buttons that can be used to control an Onkyo DVD player.

POWER ON/STNBY: Turns the DVD player on and off

DVD SET: Enters the DVD setup menu

DVD player on-screen buttons

MENU: Displays the menu

$\Delta/\nabla/\leftarrow/\rightarrow$: Moves the cursor

ENTER: Confirms the selection

RETURN: Return buttons

DVD player buttons

\leftarrow : Chapter/Track Down

\rightarrow : Chapter/Track Up

\triangleright : Play

\square : Stop

\leftarrow : Fast Reverse

\rightarrow : Fast forward

\boxtimes : Pause

OPEN/CLOSE \blacktriangle : Open/close the disc tray

0, 1 to 9, +10: Numeric keys

ENT: Confirm

You may also use the following buttons:

VOL Δ/∇ : Adjusts the volume at the TX-DS989

MUTING: Activates the muting function at the TX-DS989

Note:

The ENT button on the bottom right of the numeric keys has the same function as “ENTER” of the ENTER/cursor button.

SAT, CABLE, VCR, and TV MODE buttons

No preset codes are programmed into the SAT, CABLE, VCR, and TV MODE buttons. You can use these buttons to program the remote controller signals of other devices (see page 61).

You may use the following buttons:

VOL Δ/∇ : Adjusts the volume at the TX-DS989

MUTING: Activates the muting function at the TX-DS989

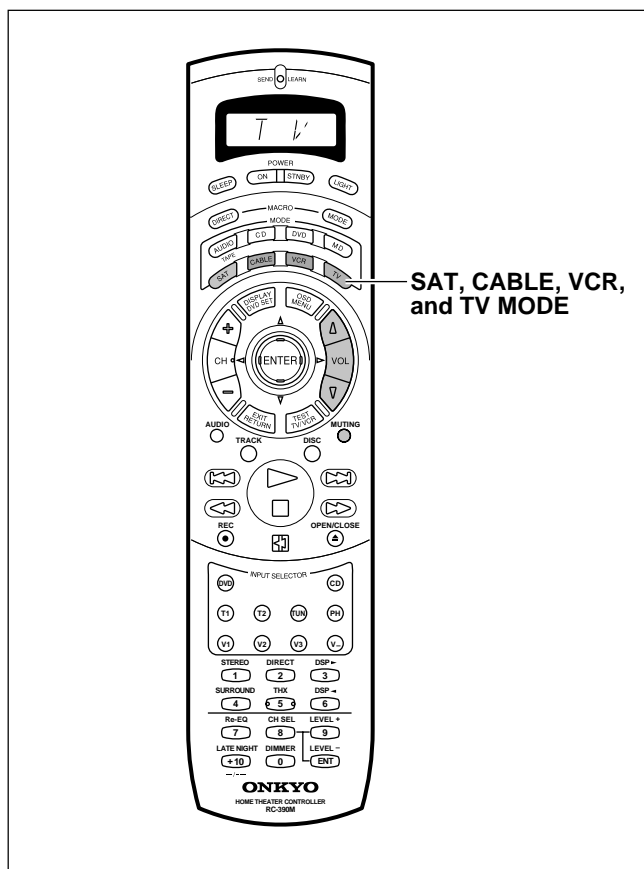

Programming the commands of remote controllers for other devices into the remote controller

The remote controller has two learning functions. One is a normal learning function that enables the remote controller to learn the codes from other remote controllers. The other is a macro learning function that enables you to program a series of operations into the remote controller so that they can all be performed at once by pressing one button.

Programming procedure

When programming the commands of another remote controller to the RC-390M remote controller, you must first decide under which MODE button you want the commands to be linked. In general, you will select the MODE button that corresponds to the component you are programming. For example, if you are programming the functions from a remote controller for a compact disc player, you would choose the CD MODE button. Then, by pressing the CD MODE button, the buttons on the RC-390M remote controller will change to the commands you program here to operate the compact disc player.

After programming which MODE button to use, you will then transfer the separate commands from the other remote controller one at a time. Each command is then programmed to a different button on the RC-390M remote controller. Any button is programmable for this step except for the eight MODE buttons (AUDIO, CD, DVD, MD, SAT, CABLE, VCR, and TV), the two MACRO buttons (DIRECT and MODE), and the LIGHT button.

Even after the commands have been memorized, keep your old remote controller in a safe place. If for some reason the commands are lost (e.g., when the batteries run down), it will be necessary to memorize them once again.

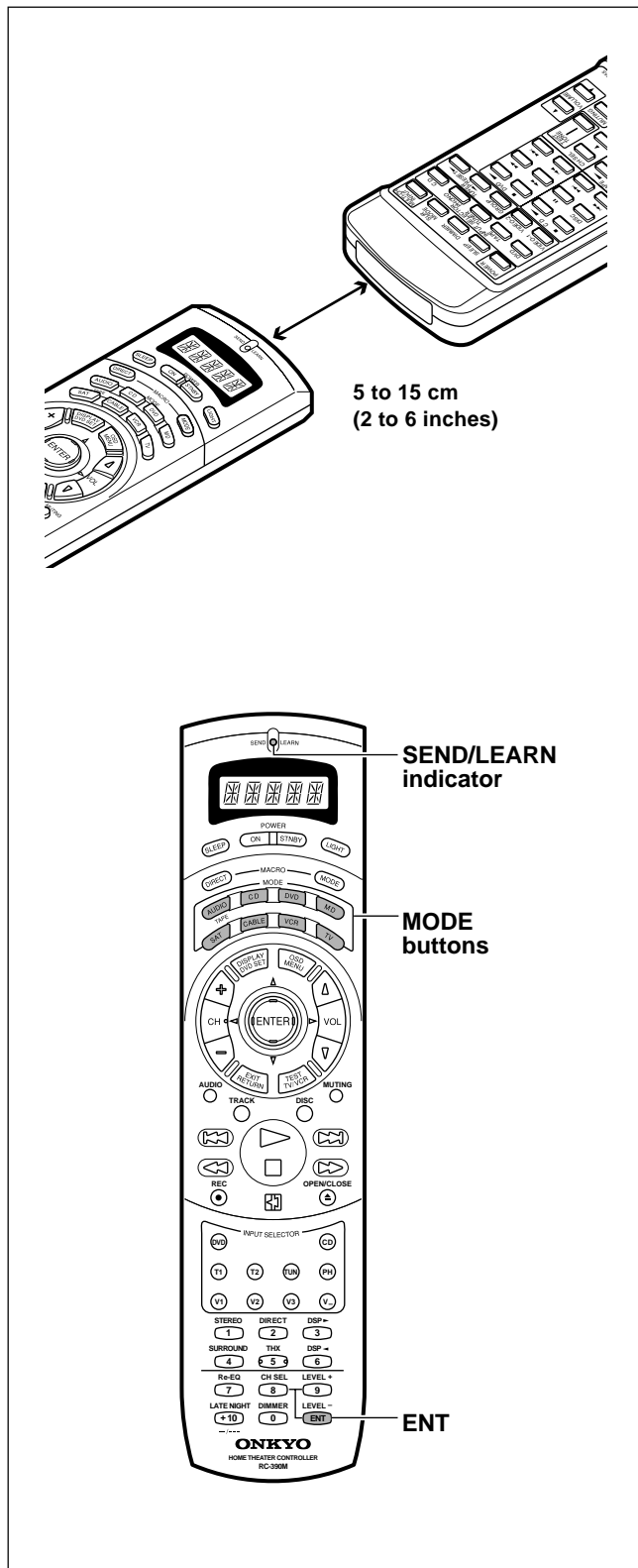

1. Place the remote controller and the remote controller for the other device facing each other at a distance of 5 to 15 cm (2 to 6 inches) apart.

2. While pressing and holding down the desired MODE button on the remote controller, press the ENT button and then release both buttons.

When you press and hold down the MODE button, the SEND/LEARN indicator lights. When you press the ENT button, the lamp turns off. When you release the buttons, the lamp lights again and "LEARN" appears in the display.

3. Press and release the button on the remote controller to which you want to transfer the next command.

You may select any button but the eleven ones indicated in the figure below. When you press the button, "RCV" appears in the display and the SEND/LEARN indicator turns off. When you release the button, the indicator lights again.

If you press the wrong button by mistake, press that same button again. The SEND/LEARN indicator flashes twice, "CLEAR" appears in the display, and the remote controller exits the programming mode.

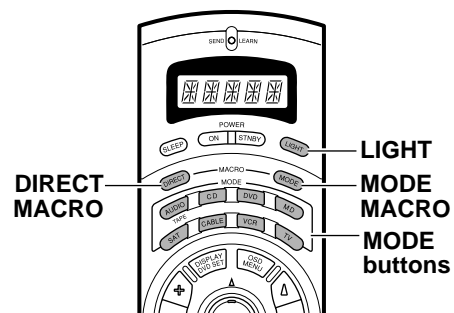

■ : Buttons that cannot be programmed.

Programming the commands of remote controllers for other devices into the remote controller

- 4. Press and hold down the button (that corresponds to the command you are programming) on the remote controller of the other device until the SEND/LEARN lamp on the remote controller flashes twice and "SAVED" appears in the display.**

After flashing twice, the SEND/LEARN indicator will light again and "LEARN" appears in the display.

- 5. Repeat Steps 3 and 4 to transfer all the commands you desire from the other remote controller and program them to buttons on the remote controller under the same MODE.**

Repeat Steps 2 through 4 to program commands to a different MODE (e.g., when programming from a different remote controller).

- 6. Press the MODE button that you pressed in step 2 to complete the programming.**

- 7. Operate the newly programmed buttons to make sure the learning function was performed properly.**

Notes:

- The remote controller codes for Onkyo compact disc players, cassette tape decks, DVD players, and mini disc recorder have already been programmed into buttons on the remote controller. You may, however, use these buttons to program the codes for other remote controllers. If you wish to restore the Onkyo preset codes after you program new codes, you must first erase the new codes (see page 63).
- The remote controller has 408 memory slots (8 modes x 51 buttons). Some remote controllers may have more commands that can be remembered by the remote controller. In such cases, it will be necessary for you to determine which commands are more important than others.
- If no button is pressed for more than 30 seconds during the programming, or if you perform an invalid operation during programming, the SEND/LEARN indicator flashes three times quickly, "ERROR" appears in the display, and the remote controller exits the programming mode. Resume from Step 2.
- If a failure occurs during programming, the SEND/LEARN indicator flashes three times quickly, "NG" appears in the display, and the remote controller exits the programming mode. Resume from Step 3.
- If a failure occurs five times in row during programming, "ERROR" appears in the display, and the remote controller exits the programming mode. Resume from Step 3.
- If you try to program beyond the learning capacity of the remote controller, the SEND/LEARN indicator flashes six times quickly, "FULL" appears in the display, and the remote controller exits the programming mode. Try programming under a different MODE button.
- When you want to program a command to a button to which you have already programmed a command, simply follow the same procedure given and programming for that button will be overwritten.
- The remote controller uses infrared rays to send its commands, as do most other remote controllers. Though most remote controller codes can be memorized by the remote controller, be aware that some remote controllers use a system that is quite different from the remote controller and therefore may not be able to be programmed.
- Some remote controllers have a single button that performs multiple functions (for example, the function may change each time the button is pressed). If this is the case, each function must be programmed to a separate button on the remote controller.
- Once you have transferred the commands from the other remote controller, refer to the instruction manual that came with that product for instructions on how to operate that product.
- Make sure both the remote controller and the other remote controller have new batteries. If either of them has batteries that are low, you may not be able to program the commands of the other remote controller properly into the remote controller.

See page 63 for how to erase the memorized commands from all buttons.

Programming the commands of remote controllers for other devices into the remote controller

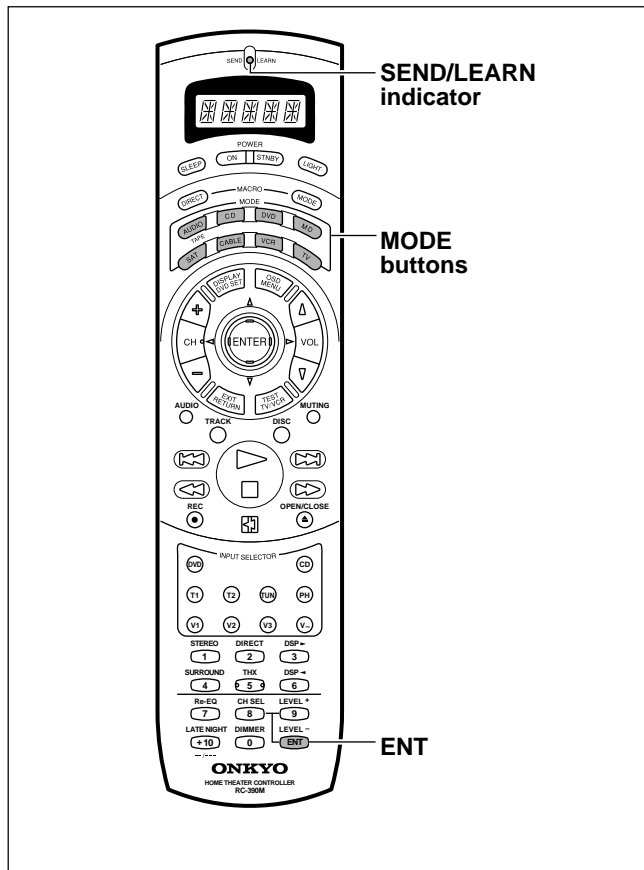

Erasing the programmed command from one button

You can only erase memorized commands and not preset ones.

1. **Press and hold down the desired MODE button for the command, press the ENT button, and then release both buttons.**

When you press the MODE button, the SEND/LEARN indicator lights and that mode appears in the display. When you press the ENT button, the lamp turns off. When you release the buttons, the lamp lights again and "LEARN" appears in the display.

2. **Press and release the button for the command you wish to erase.**

When you press the button, the SEND/LEARN indicator turns off and "RCV" appears in the display. When you release the button, the lamp lights again.

3. **Press and release the same button again.**

The SEND/LEARN lamp flashes twice slowly and "CLEAR" appears in the display. The memorized command is erased.

Note:

- If no button is pressed for more than 30 seconds during the programming, the SEND/LEARN indicator flashes three times quickly, "ERROR" appears in the display, and the remote controller exits the programming mode. Resume from Step 1.

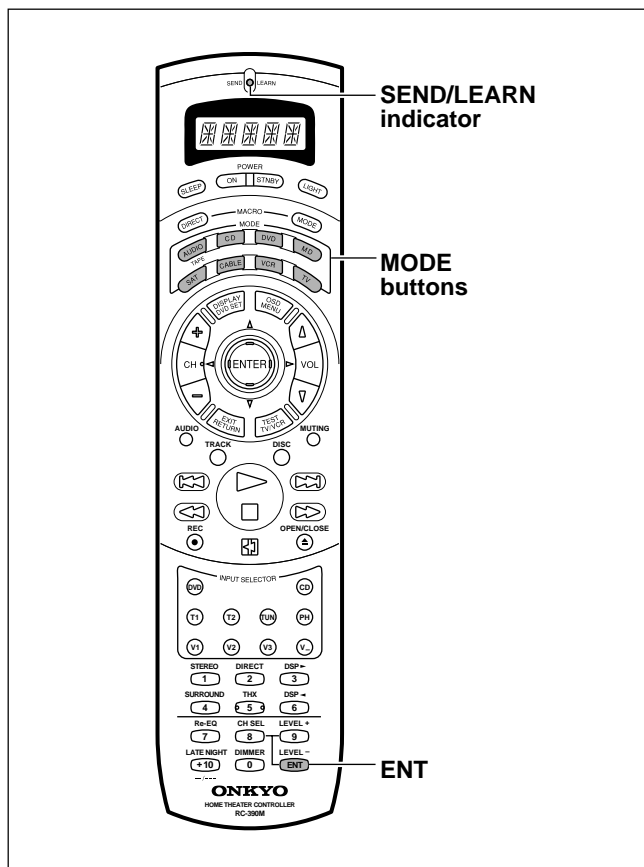

Erasing all the commands programmed under a MODE button

1. **Press and hold down the desired MODE button, press the ENT button twice, and then release both buttons.**

When you press the MODE button, the SEND/LEARN indicator lights and that mode appears in the display. When you press the ENT button, the lamp turns off. When you release the buttons, the lamp flashes twice slowly and then lights again.

2. **Press and release the same MODE button again.**

When you release the button, the SEND/LEARN indicator flashes twice slowly. This erases all the commands memorized to the MODE button.

Notes:

- If no button is pressed for more than 30 seconds during the programming, the SEND/LEARN indicator flashes three times quickly and the remote controller exits the programming mode. Resume from Step 1.
- If you perform an invalid operation during programming, the SEND/LEARN indicator flashes three times quickly, "ERROR" appears in the display, and the remote controller exits the programming mode. Resume from Step 1.
- If many commands have been programmed to the MODE button, then the SEND/LEARN indicator may remain lit for some time during Step 2. This is not a malfunction.

Using a Macro function

What is a Macro function?

A Macro function enables you to program a series of button operations (up to 16) on the remote controller into a single button. For example, to play a compact disc player connected to the TX-DS989 normally, you must perform the following steps:

1. Press the **AUDIO/TAPE MODE** button.
2. Press the **POWER ON** button.
3. Press the **CD (INPUT SELECTOR)** button.
4. Press the **CD MODE** button.
5. Press the **playback** button.

By using the macro function, you can perform the above five operations by **only pressing two buttons**.

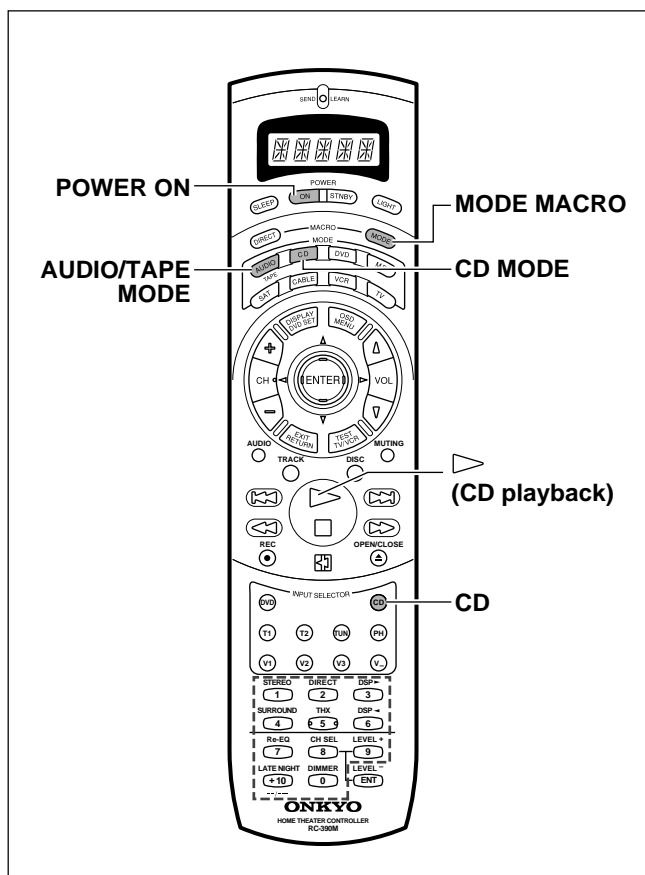

Tips:

- If you erase or change the command of a button programmed in a macro, that operation of that button will no longer work in the macro. In this case, it will be necessary for you to reprogram the macro in order to avoid incorrect operation.
- The codes programmed into a macro will be transmitted at an interval of 0.5 seconds. However, some devices may not be able to complete one operation in 0.5 seconds and may miss the next code. In this case, after pressing one operation button, you can press the same MODE button again before pressing the next operation button to add another 0.5 seconds between the two operations.

Programming a Macro function

You can program a different macro into the MODE MACRO button for each of the eight MODE buttons. The macro is then executed by pressing the appropriate MODE button and then pressing the MODE MACRO button. For example, to program the macro described above into the CD MODE button, perform the steps given below.

1. Press and hold down the desired **MODE button (in this case, the CD MODE button)**, press the **MODE MACRO button**, and then release both buttons.

When you press the MODE CD button, the SEND/LEARN indicator lights and "CD" appears in the display. When you press the MODE MACRO button, the indicator turns off. When you release the buttons, the indicator flashes and lights again and "M 01" appears in the display.

2. Press the operation buttons you wish to program in order (in this case, press **AUDIO/TAPE MODE** → **POWER ON** → **CD (INPUT SELECTOR)** → **CD MODE** → **playback button**).

When you press each button, the SEND/LEARN indicator turns off and the display changes from "M 01" → "M 02" → "M 03" → etc. When you release the button, the indicator lights.

3. Press the **MODE MACRO button** to complete the programming.

The SEND/LEARN indicator flashes twice slowly and "SAVED" appears in the display.

4. Run the macro to check to see if the macro has been properly programmed.

Notes:

- You may program up to 16 button operations into each macro function. If you try to program a 17th operation, it will be ignored, "SAVED" appears in the display, and programming is stopped.
- If no button is pressed for more than 30 seconds during the programming, the SEND/LEARN indicator flashes three times quickly, "ERROR" appears in the display, and the remote controller exits the programming mode. Resume from Step 1.
- If you perform an invalid operation during programming, the SEND/LEARN indicator flashes three times quickly, "ERROR" appears in the display, and the remote controller exits the programming mode. Resume from Step 1.

Running a Macro function

Perform the procedure below to run a macro function that you have programmed into the remote controller. After programming a macro, you should always run it at least once to make sure that it has been programmed properly.

1. Point the remote controller at the TX-DS989 and press the **CD MODE button**.
2. Press the **MODE MACRO**, and verify that the devices operate properly.

It may take a while for the macro to finish transmitting, so be sure to continue pointing the remote controller at the device until the SEND/LEARN indicator turns off.

Using a Macro function

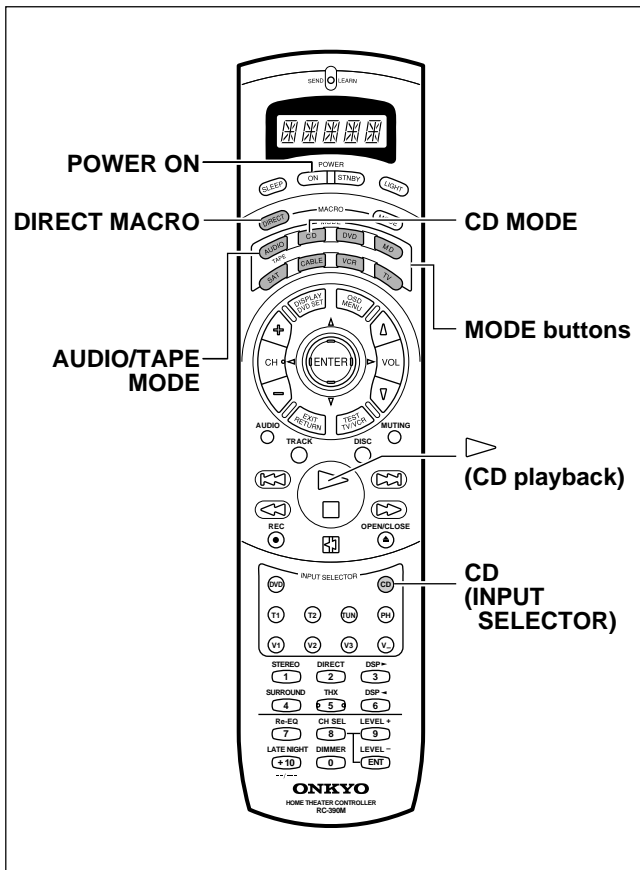

Tips:

- If you erase or change the command of a button programmed in the direct macro, that operation of that button will no longer work in the macro. In this case, it will be necessary for you to reprogram the direct macro in order to avoid incorrect operation.
- The codes programmed into a direct macro will be transmitted at an interval of 0.5 seconds. However, some devices may not be able to complete one operation in 0.5 seconds and may miss the next code. In this case, after pressing one operation button, you can press the same MODE button again before pressing the next operation button to add another 0.5 seconds between the two operations.

Programming the Direct Macro function

With the direct macro function, you can program a series of button operations as a macro into the DIRECT MACRO button so the macro can be executed with just one touch. Note that for the direct macro function, only one macro can be programmed. For example, to program the macro described on the previous page for the DIRECT MACRO button, perform the steps given below.

1. Press and hold down any one of the eight MODE buttons, press the DIRECT MACRO button, and then release both buttons.

When you press the MODE button, the SEND/LEARN indicator lights and that mode appears in the display. When you press the DIRECT MACRO button, the indicator turns off. When you release the buttons, the indicator flashes briefly and then lights again and "M 01" appears in the display.

2. Press the operation buttons you wish to program in order (in this case, press

AUDIO/TAPE MODE → POWER ON → CD (INPUT SELECTOR) → CD MODE → playback button).

When you press each button, the SEND/LEARN indicator turns off and the display changes from "M 01" → "M 02" → "M 03" → etc. When you release the button, the indicator lights.

3. Press the DIRECT MACRO button to complete the procedure.

The SEND/LEARN indicator flashes twice slowly and "SAVED" appears in the display.

4. Check to see if the macro has been properly programmed.

Notes:

- You may program up to 16 button operations into each macro function. If you try to program a 17th operation, it will be ignored, "SAVED" appears in the display, and programming is stopped.
- If no button is pressed for more than 30 seconds during the programming, the SEND/LEARN indicator flashes three times quickly, "ERROR" appears in the display, and the remote controller exits the programming mode. Resume from Step 1.
- If you perform an invalid operation during programming, the SEND/LEARN indicator flashes three times quickly, "ERROR" appears in the display, and the remote controller exits the programming mode. Resume from Step 1.

Running a Direct Macro function

Perform the procedure below to run a direct macro function that you have programmed into the remote controller. After programming a direct macro, you should always run it at least once to make sure that it has been programmed properly.

1. Point the remote controller at the TX-DS989 and press the DIRECT MACRO button.

It may take a while for the macro to finish transmitting, so be sure to continue pointing the remote controller at the device until the SEND/LEARN indicator turns off.

Using a Macro function

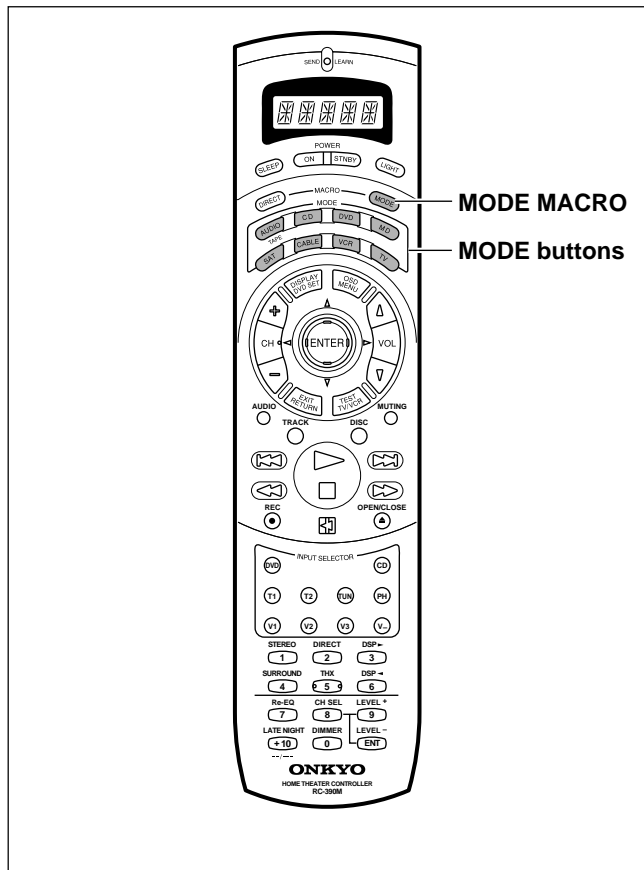

Erasing a macro from the MODE MACRO button

1. Press and hold down the desired **MODE** button, press the **MODE MACRO** button, and then release both buttons.

When you press the MODE button, the SEND/LEARN indicator lights and that mode appears in the display. When you press the MODE MACRO button, the indicator turns off. When you release the buttons, the indicator flashes once and "M 01" appears in the display.

2. Press the **MODE MACRO** button again.

The SEND/LEARN indicator flashes twice slowly and "CLEAR" appears in the display. The macro programmed to the MODE button pressed in Step 1 above is erased.

Notes:

- If no button is pressed for more than 30 seconds during the programming, the SEND/LEARN indicator flashes three times quickly, "ERROR" appears in the display, and the remote controller exits the programming mode. Resume from Step 1.
- Be aware that if you press a button other than MODE MACRO button in Step 2, then you will in effect be overwriting the previous macro with a new macro.

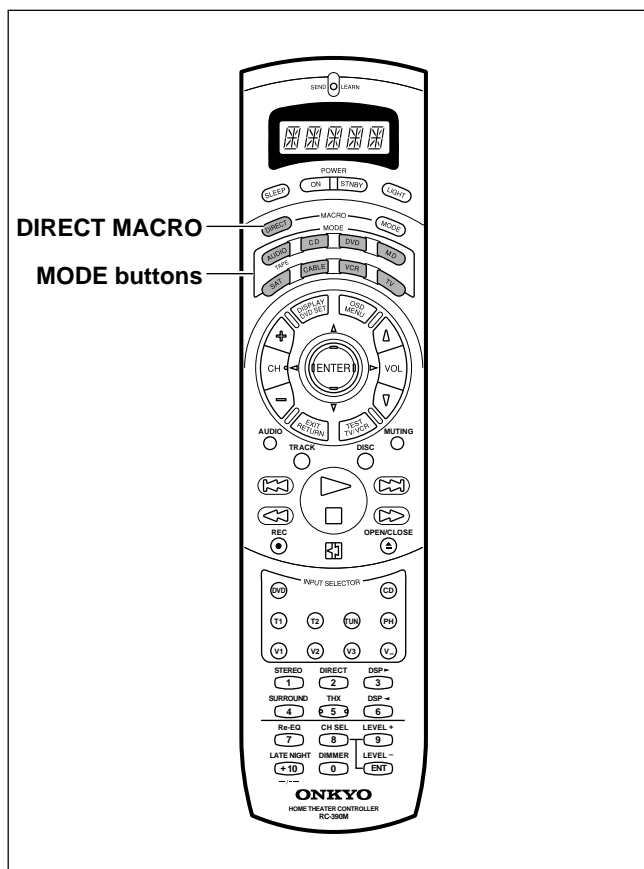

Erasing a direct macro from the DIRECT MACRO button

1. Press and hold down any one of the eight **MODE** buttons, press the **DIRECT MACRO** button, and then release both buttons.

When you press the MODE button, the SEND/LEARN indicator lights and that mode appears in the display. When you press the DIRECT MACRO button, the indicator turns off. When you release the buttons, the indicator flashes once and "M 01" appears in the display.

2. Press the **DIRECT MACRO** button again.

The SEND/LEARN indicator flashes twice slowly and "CLEAR" appears in the display. The macro programmed to the DIRECT MACRO button is erased.

Notes:

- If no button is pressed for more than 30 seconds during the programming, the SEND/LEARN indicator flashes three times quickly, "ERROR" appears in the display, and the remote controller exits the programming mode. Resume from Step 1.
- Be aware that if you press a button other than DIRECT MACRO button in Step 2, then you will in effect be overwriting the previous direct macro with a new direct macro.

Using a Macro function

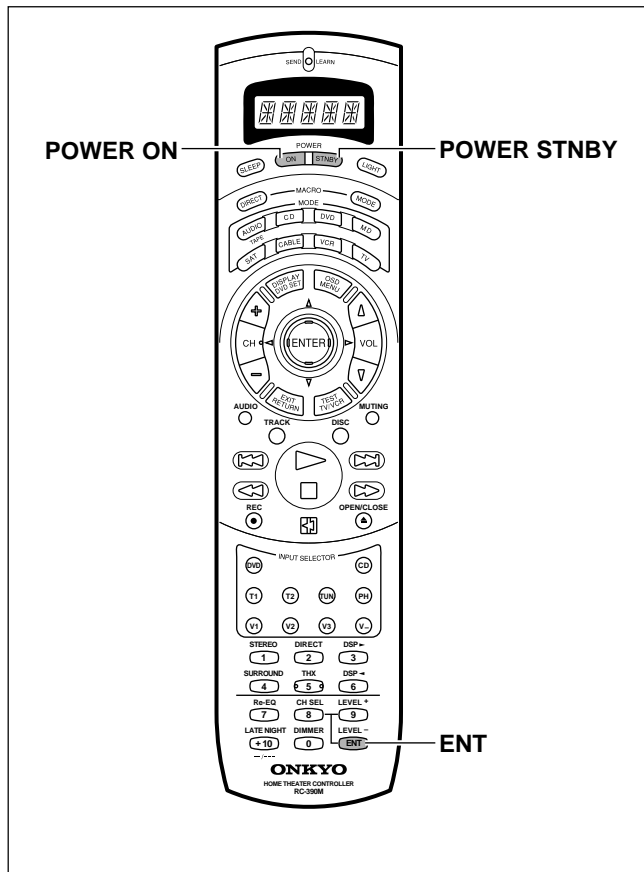

Erasing all commands and macros that have been programmed

This procedure will erase all the commands and macros that you have programmed into the remote controller and return it to its default settings. This operation will not affect the preset settings of the remote controller.

1. **Open the battery cover and remove the batteries from the remote controller.**
2. **While pressing and holding down the POWER ON and POWER STNBY buttons, re-insert the batteries in their correct orientation, and then release both buttons.**
The SEND/LEARN indicator flashes slowly and "CLEAR" appears in the display.

3. **Press the ENT button.**
The SEND/LEARN indicator lights up for about ten seconds and then turns off and "AUDIO" appears in the display.

All programmed commands and macros are erased and the remote controller returns to its factory presets.

- Notes:**
- Proceed to Step 3 immediately after Step 2; otherwise, the batteries will be consumed quickly.
 - If you press any button other than the ENT button in Step 3, nothing will be erased. In this case, resume from Step 1.

Macro mode programming memo:

MACRO	MODE MACRO ↓ AUDIO	MODE MACRO ↓ CD	MODE MACRO ↓ DVD	MODE MACRO ↓ MD	MODE MACRO ↓ SAT	MODE MACRO ↓ CABLE	MODE MACRO ↓ VCR	MODE MACRO ↓ TV	DIRECT MACRO
Operation 1									
Operation 2									
Operation 3									
Operation 4									
Operation 5									
Operation 6									
Operation 7									
Operation 8									
Operation 9									
Operation 10									
Operation 11									
Operation 12									
Operation 13									
Operation 14									
Operation 15									
Operation 16									

Troubleshooting guide

If a problem occurs while you are using the remote controller, first try to operate the controls on the front panel of the TX-DS989 to make sure that it is not due to a malfunction (or worn out batteries) in the remote controller.

POWER

Power shuts off immediately after power on.

- Amplifier protection circuitry has been activated.
 - Remove the power cord from outlet immediately. Contact your Onkyo service center.

No power.

- Power cord is disconnected.
 - Connect power cord.
- External noise is affecting the internal microcomputer.
 - Turn the power button off and then on again or remove the power cord from the outlet and then plug it in again.
- Internal fuse is blown.
 - Contact your Onkyo Service Center.

Power turns on but no sound.

- “Muting” is displayed.
 - Press the MUTING button on the remote controller to turn it off.
- Bad connections or wiring.
 - Check connections, speaker cables, etc.
- Amplifier protection circuitry has been activated.
 - Contact your Onkyo Service Center.

The sound of the playback source is not heard.

- Input selector is not set properly.
 - Set to correct input source.
- Headphones are connected.
 - Lower volume and then disconnect headphones.

SPEAKERS

No sound from the center speaker, or at very low volume.

- Speaker cable is not connected.
 - Check the connection between the amplifier and the speaker.
- Listening mode is set to Stereo or Direct.
 - Set the Listening mode to any mode other than Stereo or Direct. The output to the center speaker may differ depending on the listening mode.
- CENTER level is set to minimum.
 - Set the CENTER level to the appropriate volume.
- CENTER SPEAKER is set to “None.”
 - Set CENTER SPEAKER to “Large” or “Small.”

No sound or very low volume from subwoofer

- Subwoofer is set to “No.”
 - Check the speaker setting.
- Subwoofer speakers output level setting is improper.
 - Check the output level of the Subwoofer using the test tone.

Low frequency humming is heard

- Not properly grounded.
 - Check outer conductor of input plugs.
- Turntable motor is not properly grounded.
 - Check for proper ground connection.
- Audio connection cables on the rear panel are connected incorrectly.
 - Adjust the placement of the cable to reduce hum.

Howling is heard when the volume is turned up.

- Turntable and speakers are located too close together.
 - Move them farther apart.

Rough or scratchy sound is heard. High range is not clear.

- The needles of turntable is dirty or worn, or a problem exists with a connected component.
 - Refer to the instruction of the connected components and check for problem.
- Treble control too high.
 - Turn treble down.

Troubleshooting guide

FM/AM TUNER

AM stations cannot be received.

- AM loop antenna is not connected.
 - Connect the included AM loop antenna to the AM antenna terminals.

Buzzing noise on AM stations (particularly noticeable at night or with weak stations).

- Noise from electrical apparatus such as fluorescent lamp.
 - Move the AM loop antenna to different position.
 - Set up an outdoor AM antenna.

Noise is heard at high-pitched sounds on AM stations.

- Noise from TV set.
 - Place the AM loop antenna as far as possible from the TV.
 - Move unit away from TV set.

Crackling noise on both AM and FM stations

- Noise caused by fluorescent lamp being turned on and off.
 - Move antenna as far as possible from the fluorescent lamp.
- Noise from automobile ignition.
 - Install an FM outdoor antenna as far as possible from the road.
 - Change the position or direction of the outdoor antenna.

The indicators light for stereo reception, but sound is distorted and stereo separation is bad.

- Station is too strong.
 - Change to FM indoor antenna.
- Multiple reflection of the radio waves because of tall buildings or mountains.
 - Use antenna that has better directivity and select a point where distortion is least.

Indicators for stereo reception flicker and hiss is heard on FM stations.

- Station is too weak.
 - Install an outdoor FM antenna.
- Stereo FM broadcasts cover only about half the distance of an ordinary broadcast.
 - Change the position or direction of the outdoor antenna.

No preset station is recalled.

- Power cord has been unplugged or the POWER switch has been turned off for a long time.
 - The memory contents are lost. Store all stations again.

VIDEO and AUDIO

Desired picture does not appear.

- Improper connection.
 - Check the connection again. Insert the plugs and connectors completely.
- Video Setup sub-menu of Input Setup menu settings are incorrect.
 - Check Settings.

No on-screen display.

- Improper connection.
 - Check connections.
- OSD Menu is only display to monitor connected to MONITOR 1.
 - If connected to MONITOR 2, reconnect to MONITOR 1.

Picture and sound do not match.

- Improper connection.
 - Check connections.
- Video Setup sub-menu of Input Setup menu settings are incorrect.
 - Check settings.

No sound, or sound of the selected source is not heard.

- Digital Setup sub-menu of Input Setup menu settings are incorrect.
 - Check settings.

No picture appears on the TV screen (or monitor).

- TV (or monitor) is not set to receive the output signals from the receiver.
 - Set the TV (or monitor) to the receiver input.
- Video cable is not connected securely.
 - Check connections.
- S VIDEO IN signal is output at VIDEO OUT and S-VIDEO OUT, but VIDEO IN signal is only output at VIDEO OUT. Also, COMPONENT VIDEO IN signal is only output at COMPONENT VIDEO OUT.
 - Check the input and output signals.

REMOTE CONTROLLER

Front panel controls function but remote controller controls do not.

- No batteries in remote controller.
 - Insert batteries.
- Batteries have worn out.
 - Replace batteries.

Troubleshooting guide

- Remote controller is not pointed at the remote sensor of the TX-DS989.
 - Point the remote controller at the remote sensor of the TX-DS989.
- Remote controller is too far from the TX-DS989.
 - Operate the remote controller within 16 feet (5 meters).
- Remote controller is functioning in a different mode
 - Press the AUDIO MODE button.

OTHER

LATE NIGHT function cannot be used.

- Playback source is not Dolby Digital encoded.
 - Check that the DOLBY DIGITAL indicator lights up on the display.

LFE LEVEL function cannot be used.

- Playback source is not Dolby Digital, DTS, or MPEG encoded.
 - Check that the DOLBY DIGITAL, DTS, or MPEG indicator lights up on the display.

Cinema Re-EQ function cannot be used.

- Listening mode is set to “Theater-Dimensional” or “Direct.”
 - See table on page 45.

Parameter cannot be set for Front Effect, Reflect Level, Reverb Level, Room Size, etc.

- Parameter may not be able to be set depending on the listening mode.
 - See table on page 45.

Multichannel audio is not output.

- To listen to multichannel audio, “Yes” must be selected in the Multichannel sub-menu in the Input Setup menu.
 - Check that the component is connected to the MULTI CHANNEL INPUT port and check the OSD Menu settings.

Cannot change OSD Menu settings.

- OSD Menu is locked so that it cannot be changed.
 - Set “Unlocked” at the Lock Setup sub-menu in the About menu.

Components in remote zone (Zone 2) do not operate properly.

- Components are incorrectly connected.
 - Check connections.
- Objects are interfering with remote controller signals.
 - Move interfering objects away from path of remote controller signals.

For digital sources, sound is sometimes not output depending on media type.

- Format of digital input source is fixed. Other digital formats will not be output.
 - Set Digital Format to “Auto” in the Digital Setup sub-menu of the Input Setup menu.

For DTS and MPEG sources, noises or incorrect starts occur when the digital source is played.

- Digital Format settings is incorrect.
 - Try setting Digital Format to the same as the input source in the Digital Setup sub-menu of the Input Setup menu.

Operation of fan is heard.

- TX-DS989 is equipped with internal ventilation fan to prevent overheating. This is not a malfunction.

OSD menu settings cannot be changed.

- The settings are locked.
 - Unlock the settings in the OSD menu: About → Lock Setup → Unlocked.

Components do not operate from the remote zone (Zone 2)

- Improper connection.
 - Check connections.
- Something is blocking the remote sensor.
 - Move the obstacle.

Sound for a digital source turns on and off depending on the media being played.

- Digital input format is fixed, so other formats are not played.
 - Set “Auto” in the OSD menu: Input Setup → Digital Setup → Digital Format → Auto.

When playing digital sources such as DTS and MPEG sources, noise is heard or the beginning is cut off.

- Set the format type in the OSD menu: Input Setup → Digital Setup → Digital Format.

Also refer to the respective instruction manuals of the compact disc player, DVD player, video cassette recorder, TV monitor, etc., that compose your entertainment system.

Since the unit contains a microcomputer to provide advanced functions, it may malfunction due to external noise or static electricity. If this happens, press the POWER switch on the unit and then press it in again after about five seconds.

The default settings

The following table shows the factory-set default parameter values. Use it as a reference when you change these parameter values as needed, although they are usable in many cases.

To return to the factory-set default parameters, press and hold down the VIDEO 1 button, and then press the STANDBY/ON button. "Clear" appears in the display and then the TX-DS989 returns to the standby state.

1. Speaker Setup

1-1. Speaker Config

- a. Subwoofer: Yes
- b. Front: Small
- c. Center: Small
- d. Surround L/R: Small
- e. Surround Back: Small

1-2. Speaker Distance

- a. Unit: feet
- b. Front L/R: 3.6m/12ft
- c. Center: 3.6m/12ft
- d. Surr Right: 2.1m/7ft
- e. Surr Bk R: 2.1m/7ft
- f. Surr Bk L: 2.1m/7ft
- g. Surr Left: 2.1m/7ft
- h. Subwoofer: 3.6m/12ft

1-3. Level Calibration

- a. Left: 0.0dB
- b. Center: 0.0dB
- c. right: 0.0dB
- d. Surr Right: 0.0dB
- e. Surr Bk R: 0.0dB
- f. Surr Bk L: 0.0dB
- g. Surr Left: 0.0dB
- h. Subwoofer: 0.0dB

1-4. Bass Peak Level

- a. Bass Peak Level Limiter: Off
- b. Peak Level: +18dB

1-5. LFE Level Setup

- a. Dolby Digital: 0dB
- b. DTS Cinema: 0dB
- c. DTS Music: 0dB
- d. MPEG Cinema: 0dB
- e. MPEG Music: 0dB

2. Input Setup

2-1. Digital Setup

- a. Digital Input: CD: COAX1
TAPE1: OPT1
TAPE2: OPT2
DVD: OPT3
VIDEO1: ----
VIDEO2: COAX2
VIDEO3: COAX3
VIDEO4: COAX4
VIDEO5: COAX5
- b. Digital Format: Auto

2-2. Multichannel Setup

- a. Multichannel: CD: No
TAPE1: No
TAPE2: No
DVD: No
VIDEO1: No
VIDEO2: No
VIDEO3: No
VIDEO4: No
VIDEO5: No

2-3. Video Setup

- a. Video: CD: Last valid
PHONO: Last valid
FM: Last valid
AM: Last valid
TAPE1: Last valid
TAPE2: Last valid
DVD: DVD

VIDEO1: VIDEO1
VIDEO2: VIDEO2
VIDEO3: VIDEO3
VIDEO4: VIDEO4
VIDEO5: VIDEO5

- b. Component Video: DVD: Component Video1
VIDEO1: ----
VIDEO2: Component Video2
VIDEO3: Component Video3
VIDEO4: ----
VIDEO5: ----

2-4. Listening Mode Setup

- a. Analog/PCM: Stereo
- b. PCM fs>48k: Stereo
- c. PCM fs=192k: Stereo
- d. Dolby D: Dolby D
- e. DTS: DTS
- f. MPEG: MPEG Multi
- g. D.F.2ch: Pro Logic
- h. D.F.Mono: Mono

2-5. Delay

- a. A/V Sync: 0.0ms
- b. Relative Delay Center: 0.0ms
- c. Relative Delay Surr L/R: 0.0ms
- d. Relative Delay Surr Back: 0.0ms

2-6. Sound Effect

- a. Bass: 0
- b. Treble: 0

2-7. Character Input

- a. Character Display: No
- b. Character: None

2-8. Miscellaneous Setup

- a. IntelliVolume: 0dB

4. Preference

4-1. Volume Setup

- a. Volume Display: Absolute
- b. Muting Level: -∞dB
- c. Maximum Volume: Off
- d. Power On Volume: Last valid

4-2. OSD Setup

- a. Background Color: Blue1
- b. Superimpose Mode: Normal
- c. Immediate Display: On
- d. Display Position: Bottom
- e. Timeout: 3sec
- f. TV Format: Auto

4-3. OSD Tweak

- a. ← / → / ↑ / ↓: 0.0

5. Zone2 OSD Setup

5-1. OSD Setup

- a. Background Color: Blue1
- b. Superimpose Mode: Normal
- c. Immediate Display: Off
- d. Display Position: Bottom
- e. Timeout: 3sec
- f. TV Format: Auto

6. About

6-1. Lock Setup

- a. Lock: Unlocked

6-2. Version

- b. Master ID: _____

Your system setting

This page is for you to record the settings you have made for the components connected to the TX-DS989. If a system installer will install your system for you, then ask him to fill in this page for you.

Example: If you connected a Onkyo DV-S525 to the DVD input, then enter "ONKYO DV-S525" for the name, circle items corresponding to the connections and settings that you have made, and fill in the items where blanks are given.

Inputs

DVD

Name: _____

Digital Input connection: OPT1, OPT2, OPT3, COAX1, COAX2, COAX3, COAX4, COAX5, not connected

Multichannel Setup: Yes, No

Video Input

Video: DVD, VIDEO1, VIDEO2, VIDEO3, VIDEO4, VIDEO5, not connected

Component Video: INPUT1, INPUT2, INPUT3, not connected

Video Output: VIDEO1, VIDEO2, COMPONENT, not connected

Video Setup: DVD, VIDEO1, VIDEO2, VIDEO3, VIDEO4, VIDEO5, ----

Intelli Volume: _____ dB

Character Input: Yes (name: _____), No

Listening Mode Preset

1. Input source signal: _____

Listening Mode: _____

2. Input source signal: _____

Listening Mode: _____

3. Input source signal: _____

Listening Mode: _____

VIDEO 1

Name: _____

Digital Input: OPT1, OPT2, OPT3, COAX1, COAX2, COAX3, COAX4, COAX5, not connected

Multichannel Setup: Yes, No

Video Input

Video: DVD, VIDEO1, VIDEO2, VIDEO3, VIDEO4, VIDEO5, not connected

Component Video: INPUT1, INPUT2, INPUT3, not connected

Video Output: VIDEO1, VIDEO2, COMPONENT, not connected

Video Setup: DVD, VIDEO1, VIDEO2, VIDEO3, VIDEO4, VIDEO5, ----

Intelli Volume: _____ dB

Character Input: Yes (name: _____), No

Listening Mode Preset

1. Input source signal: _____

Listening Mode: _____

2. Input source signal: _____

Listening Mode: _____

3. Input source signal: _____

Listening Mode: _____

VIDEO 2

Name: _____

Digital Input: OPT1, OPT2, OPT3, COAX1, COAX2, COAX3, COAX4, COAX5, not connected

Multichannel Setup: Yes, No

Video Input

Video: DVD, VIDEO1, VIDEO2, VIDEO3, VIDEO4, VIDEO5, not connected

Component Video: INPUT1, INPUT2, INPUT3, not connected

Video Output: VIDEO1, VIDEO2, COMPONENT, not connected

Video Setup: DVD, VIDEO1, VIDEO2, VIDEO3, VIDEO4, VIDEO5, ----

Intelli Volume: _____ dB

Character Input: Yes (name: _____), No

Listening Mode Preset

1. Input source signal: _____

Listening Mode: _____

2. Input source signal: _____

Listening Mode: _____

3. Input source signal: _____

Listening Mode: _____

VIDEO 3

Name: _____

Digital Input: OPT1, OPT2, OPT3, COAX1, COAX2, COAX3, COAX4, COAX5, not connected

Multichannel Setup: Yes, No

Video Input

Video: DVD, VIDEO1, VIDEO2, VIDEO3, VIDEO4, VIDEO5, not connected

Component Video: INPUT1, INPUT2, INPUT3, not connected

Video Output: VIDEO1, VIDEO2, COMPONENT, not connected

Video Setup: DVD, VIDEO1, VIDEO2, VIDEO3, VIDEO4, VIDEO5, ----

Intelli Volume: _____ dB

Character Input: Yes (name: _____), No

Listening Mode Preset

1. Input source signal: _____

Listening Mode: _____

2. Input source signal: _____

Listening Mode: _____

3. Input source signal: _____

Listening Mode: _____

Your system setting

VIDEO 4

Name: _____

Digital Input: OPT1, OPT2, OPT3, COAX1, COAX2, COAX3, COAX4, COAX5, not connected

Multichannel Setup: Yes, No

Video Input

Video: DVD, VIDEO1, VIDEO2, VIDEO3, VIDEO4, VIDEO5, not connected

Component Video: INPUT1, INPUT2, INPUT3, not connected

Video Output: VIDEO1, VIDEO2, COMPONENT, not connected

Video Setup: DVD, VIDEO1, VIDEO2, VIDEO3, VIDEO4, VIDEO5, ----

Intelli Volume: _____dB

Character Input: Yes (name: _____), No

Listening Mode Preset

1. Input source signal: _____

Listening Mode: _____

2. Input source signal: _____

Listening Mode: _____

3. Input source signal: _____

Listening Mode: _____

VIDEO 5

Name: _____

Digital Input: OPT1, OPT2, OPT3, COAX1, COAX2, COAX3, COAX4, COAX5, not connected

Multichannel Setup: Yes, No

Video Input

Video: DVD, VIDEO1, VIDEO2, VIDEO3, VIDEO4, VIDEO5, not connected

Component Video: INPUT1, INPUT2, INPUT3, not connected

Video Output: VIDEO1, VIDEO2, COMPONENT, not connected

Video Setup: DVD, VIDEO1, VIDEO2, VIDEO3, VIDEO4, VIDEO5, ----

Intelli Volume: _____dB

Character Input: Yes (name: _____), No

Listening Mode Preset

1. Input source signal: _____

Listening Mode: _____

2. Input source signal: _____

Listening Mode: _____

3. Input source signal: _____

Listening Mode: _____

TAPE 1

Name: _____

Digital Input: OPT1, OPT2, OPT3, COAX1, COAX2, COAX3, COAX4, COAX5, not connected

Multichannel Setup: Yes, No

Video Setup: DVD, VIDEO1, VIDEO2, VIDEO3, VIDEO4, VIDEO5, ----

Intelli Volume: _____dB

Character Input: Yes (name: _____), No

Listening Mode Preset

1. Input source signal: _____

Listening Mode: _____

2. Input source signal: _____

Listening Mode: _____

TAPE 2

Name: _____

Digital Input: OPT1, OPT2, OPT3, COAX1, COAX2, COAX3, COAX4, COAX5, not connected

Multichannel Setup: Yes, No

Video Setup: DVD, VIDEO1, VIDEO2, VIDEO3, VIDEO4, VIDEO5, ----

Intelli Volume: _____dB

Character Input: Yes (name: _____), No

Listening Mode Preset

1. Input source signal: _____

Listening Mode: _____

2. Input source signal: _____

Listening Mode: _____

AM

Video Setup: DVD, VIDEO1, VIDEO2, VIDEO3, VIDEO4, VIDEO5, ----

Intelli Volume: _____dB

Character Input: Yes (name: _____), No

Listening Mode Preset

a. Analog/PCM: _____

FM

Video Setup: DVD, VIDEO1, VIDEO2, VIDEO3, VIDEO4, VIDEO5, ----

Intelli Volume: _____dB

Character Input: Yes (name: _____), No

Listening Mode Preset

a. Analog/PCM: _____

PHONO

Video Setup: DVD, VIDEO1, VIDEO2, VIDEO3, VIDEO4, VIDEO5, ----

Intelli Volume: _____dB

Character Input: Yes (name: _____), No

Listening Mode Preset

a. Analog/PCM: _____

Your system setting

CD

Name: _____

Digital Input: OPT1, OPT2, OPT3, COAX1, COAX2, COAX3, COAX4, COAX5, not connected

Multichannel Setup: Yes, No

Video Setup: DVD, VIDEO1, VIDEO2, VIDEO3, VIDEO4, VIDEO5, ----

Intelli Volume: _____dB

Character Input: Yes (name: _____) , No

Listening Mode Preset

1. Input source signal: _____

Listening Mode: _____

2. Input source signal: _____

Listening Mode: _____

Speakers

Speaker configuration

Subwoofer Yes, No

Name: _____

Distance: _____m/ft

Level: _____dB

Front Yes, No

Name: _____

Distance: L: _____m/ft R: _____m/ft

Level: L: _____dB R: _____dB

Center None, Large, Small

Name: _____

Distance : _____m/ft

Level: _____dB

Surround None, Large, Small

Name: _____

Distance : L: _____m/ft R: _____m/ft

Level: L: _____dB R: _____dB

Surround Back None, Large, Small

Name: _____

Distance : L: _____m/ft R: _____m/ft

Level: L: _____dB R: _____dB

Bass Peak Level

Bass peak level Limiter: On, Off

Peak Level: _____dB

LFE Level Setup

Dolby Digital: _____dB

DTS Cinema: _____dB

DTS Music: _____dB

MPEG Cinema: _____dB

MPEG Music: _____dB

Volume Setup

Volume Display: Absolute, Relative

Muting Level: Absolute _____dB, Relative _____

Maximum Volume: Absolute _____dB, Relative _____

Power On Volume: Absolute _____dB, Relative _____

OSD Setup

Background Color: Blue1, Blue2, Green1, Green2, Magenta, Red1, Red2

Superimpose: Off, Normal, Black

Immediate Display: On, Off

Display Position: Bottom, _____, Top

Timeout: _____sec

TV Format: Auto, NTSC, PAL

ZONE2

Speaker: _____

Monitor: _____

Power Amplifier: _____

Zone2 OSD Setup

Background Color: Blue1, Blue2, Green1, Green2, Magenta, Red1, Red2

Superimpose: Off, Normal, Black

Immediate Display: On, Off

Display Position: Bottom, _____, Top

Timeout: _____sec

TV Format: Auto, NTSC, PAL

About

Lock Setup

Parameter Lock: Unlocked, Locked

Version

Master ID: _____

Your system setting

Remote controller

It is recommended to write down the settings of the remote controller in case they are lost accidentally. In the blank spaces for each setting, place a checkmark for the settings you have made.

Below are figures for you to write down how you have programmed the functions of other remote controllers to the RC-390M remote controller. Write down the mode above the figure and the functions for each key at the location of the key in the figure. If you have created more than three modes (by programming more than three different remote controllers, etc.), then you can copy this page as necessary.

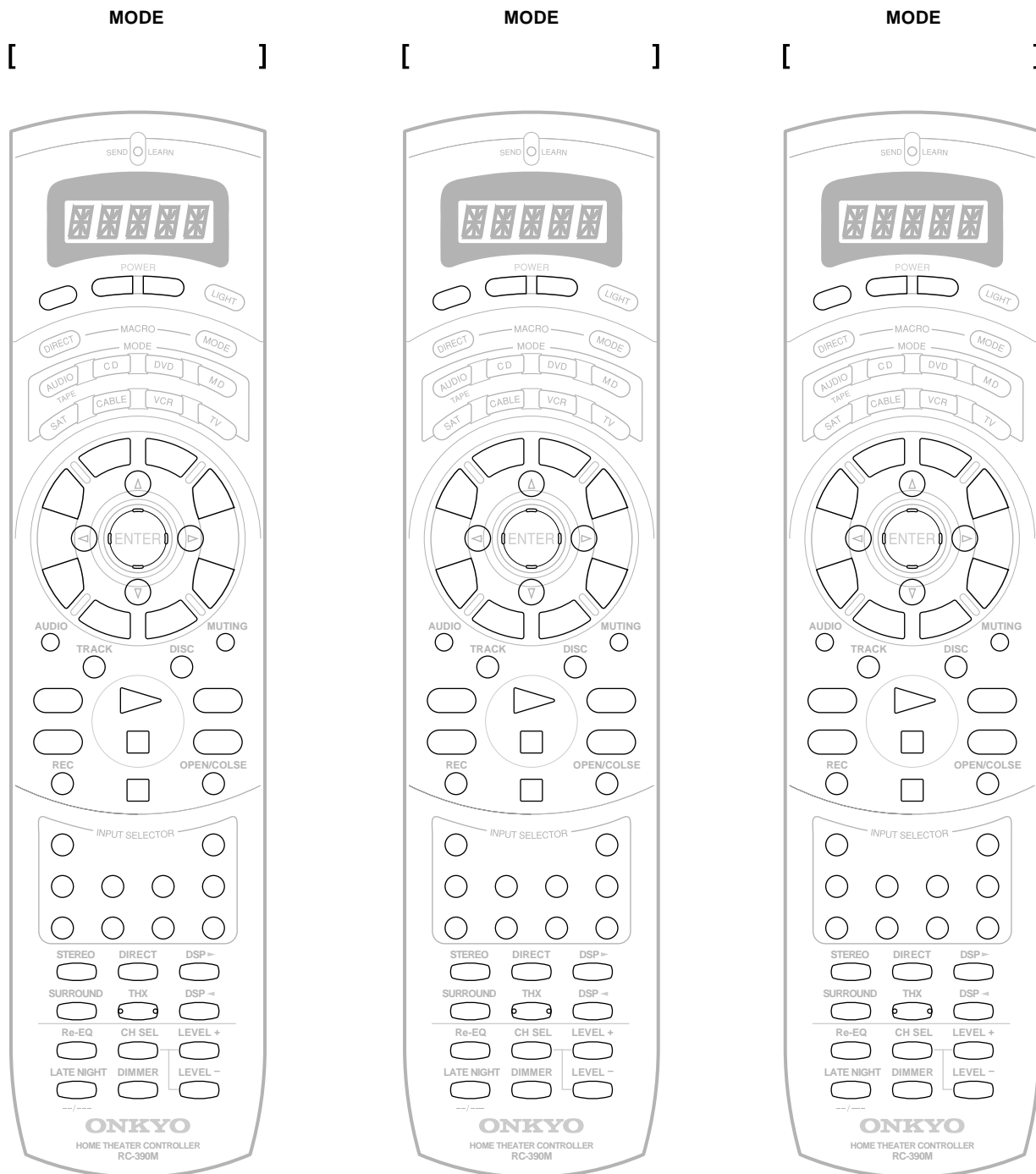

Specifications

AMPLIFIER SECTION

Continuous Average Power output (FTC)

All channels: **130 watts per channel min. RMS at 8 ohms, 2 channels driven from 20 Hz to 20 kHz with no more than 0.05% total harmonic distortion. 170 watts min. RMS at 6 ohms, 2 channels driven from 1 kHz with no more than 0.1% total harmonic distortion.**

Continuous Power output (DIN) 160 watts at 6 ohms

Maximum Power output (EIAJ) 200 watts at 6 ohms

Dynamic Power Output (Stereo) 2 × 300 watts at 3 ohms

2 × 230 watts at 4 ohms

2 × 150 watts at 8 ohms

Total Harmonic Distortion: 0.05% at rated power

0.05% at 1 Watt output

IM Distortion: 0.05% at rated power

0.05% at 1 Watt output

Damping Factor: 60 at 8 ohms

Input Sensitivity and Impedance

PHONO: 2.5 mV, 50 kohms

LINE (CD, TAPE 1-2, DVD,

VIDEO 1-5): 200 mV, 50 kohms

MULTICHANNEL INPUT

(FRONT L/C/R, SURROUND

L/R, SURROUND BACK L/R): 200 mV, 50 kohms

(SUBWOOFER): 36 mV, 50 kohms

AMP IN (FRONT L/C/R) : 1 V, 50 kohms

COAXIAL 1-5 (DIGITAL): 0.5 Vp-p, 75 ohms

DVD, VIDEO1-5: 1 Vp-p, 75 ohms

1 Vp-p, 75 ohms (Y)

0.28 Vp-p, 75 ohms (C)

COMPONENT VIDEO 1-3: 1 Vp-p, 75 ohms (Y)

0.5 Vp-p, 75 ohms (Pb, Pr)

Output Level and Impedance

Rec out (TAPE 1-2, VIDEO 1-2):

200 mV, 2.2 kohms

Pre out: 1 V, 470 ohms

ZONE 2 OUT: 100mV, 470 ohms

VIDEO (VIDEO 1-2, MONITOR

OUT, ZONE 2 OUT): 1 Vp-p, 75 ohms

1 Vp-p, 75 ohms (Y)

0.28 p-p, 75 ohms (C)

COMPONENT VIDEO OUT: 1 Vp-p, 75 ohms (Y)

0.5 Vp-p, 75 ohms (Pb, Pr)

Phono Overload: 110 mV RMS at 1 kHz, 0.5% T.H.D.

Frequency Response: 20 Hz to 30 kHz : ±1dB

(CD in Direct mode)

5 Hz to 100 kHz : +1dB,-3dB

(CD in Direct mode)

RIAA Deviation: 20 to 20 kHz : ±0.8 dB

Tone Control

Bass: ±10 dB at 100 Hz

Treble: ±10 dB at 10 kHz

Signal-to-Noise Ratio (Stereo)

Phono: 80 dB (IHF A, 5 mV input)

CD/Tape: 100 dB (IHF A, 0.5 V input)

TUNER SECTION

FM

Tuning Range: 87.5 — 108.0 MHz (50 kHz steps)

Usable Sensitivity

Mono: 11.2 dBf, 1.0 μV (75 ohms IHF)

0.9 μV (75 ohms DIN)

Stereo: 17.2 dBf, 2.0 μV (75 ohms IHF)

23 μV (75 ohms DIN)

50 dB Quieting Sensitivity

Mono: 17.2 dBf, 2.0 μV (75 ohms)

Stereo: 37.2 dBf, 20 μV (75 ohms)

Capture Ratio: 2.0 dB

Image Rejection Ratio 40 dB

IF Rejection Ratio: 90 dB

Signal-to-Noise Ratio

Mono: 76 dB

Stereo: 70 dB

Alternate Channel Attenuation: 55 dB

Selectivity: 50 dB (DIN)

AM Suppression Ratio: 50 dB

Total Harmonic Distortion

Mono: 0.2%

Stereo: 0.3%

Frequency Response: 30 Hz — 15 kHz, ±1.0 dB

Stereo Separation: 45 dB at 1 kHz

30 dB at 100 Hz — 10 kHz

AM

Tuning Range: 530—1,710 kHz (10 kHz steps)

Usable Sensitivity: 30 μV

Image Rejection Ratio: 40 dB

IF Rejection Ratio: 40 dB

Signal-to-Noise Ratio: 40 dB

Total Harmonic Distortion: 0.7%

GENERAL

Power Supply: AC 120 V, 60 Hz

Power Consumption: 11 A

Dimensions (W × H × D): 17-1/8" × 7-11/16" × 17-3/4"

Weight: 48.5 lbs.

REMOTE CONTROLLER

Transmitter: Infrared

Signal range: Approx. 5 meters, 16 ft.

Power supply: Two "AA" batteries (1.5 V × 2)

Specifications and features are subject to change without notice.

ONKYO CORPORATION

Sales & Product Planning Div. : 2-1, Nisshin-cho, Neyagawa-shi, OSAKA 572-8540, JAPAN

Tel: 072-831-8111 Fax: 072-833-5222 <http://www.onkyo-intl.com>

ONKYO U.S.A. CORPORATION

18 Park Way, Upper Saddle River, N.J. 07458, U.S.A.

Tel: 201-785-2600 Fax: 201-785-2650 <http://www.onkyousa.com>

ONKYO EUROPE ELECTRONICS GmbH

Liegnitzerstrasse 6, 82194, Groebenzell, GERMANY

Tel: +49-8142-4401-0 Fax: +49-8142-4401-555 <http://www.onkyo.net>

ONKYO CHINA LIMITED

Units 2102-2107, Metroplaza Tower I, 223 Hing Fong Road, Kwai Chung,

N.T., HONG KONG Tel: 852-2429-3118 Fax: 852-2428-9039 <http://www.onkyochina.com>



Free Manuals Download Website

<http://myh66.com>

<http://usermanuals.us>

<http://www.somanuals.com>

<http://www.4manuals.cc>

<http://www.manual-lib.com>

<http://www.404manual.com>

<http://www.luxmanual.com>

<http://aubethermostatmanual.com>

Golf course search by state

<http://golfingnear.com>

Email search by domain

<http://emailbydomain.com>

Auto manuals search

<http://auto.somanuals.com>

TV manuals search

<http://tv.somanuals.com>