

Cat. No. 12-2114

OWNER'S MANUAL

Please read before using this equipment.

In-Dash AM/FM Stereo Cassette with Auto-Reverse



OPTIMUS®

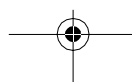
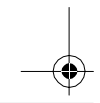

FEATURES

Your Optimus In-Dash AM/FM Stereo Cassette with Auto-Reverse has many practical, easy-to-use features, and you can install it in almost any vehicle. The stereo's anti-theft faceplate is easy to remove, making the stereo inoperative. The tuner's digital synthesized circuitry gives you precise tuning and drift-free reception.

The auto-reverse cassette deck, memory tuning, and seek tuning all make your stereo's operation simple and quick to help you drive safely.

Caution: Use common sense. Do not change your stereo's settings in heavy traffic or during hazardous driving conditions.

This stereo's features include:

Anti-Theft Faceplate — lets you quickly remove and store the stereo's faceplate in the supplied carry case. This discourages theft because the stereo cannot operate without the faceplate.

Auto-Reverse — allows continuous tape play.

Locking Fast-Forward and Rewind — let you quickly move the tape forward and backward.

Advanced FM Tuning Adjustment — automatically changes FM reception on weak stations from stereo to mono, to improve reception of those stations.

FM Signal Enhancer — automatically adjusts the tuner's stereo separation and high-frequency response to give you the best possible sound, regardless of the signal level.

Easy-to-See Liquid Crystal Display with Clock — lets you easily see the clock/radio/cassette deck's current functions.

Band Button — lets you easily select one of the stereo's AM or FM bands.

Seek Tuning — searches forward or backward to the next strong station in the selected band. This makes finding a station quick and easy.

Memory Tuning — lets you quickly store and tune up to 30 of your favorite stations (12 AM and 18 FM).

Memory Scan Tuning — scans all stations stored in a selected memory group, playing each for 5 seconds.

© 1998 Tandy Corporation.
All Rights Reserved.

Optimus and RadioShack are registered trademarks used by Tandy Corporation.

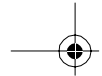

Tone and Balance Controls — let you adjust high and low sounds and the balance between the left and right speakers, so you can tailor the sound to suit your preferences.

Digital Synthesized Circuitry — gives you precise tuning and drift-free reception.

We recommend you record your stereo's serial number here. The number is on the top cover of the stereo.

Serial Number: _____

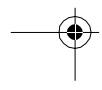
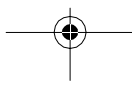
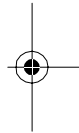
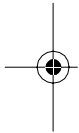



CONTENTS

Installation	5
Before You Begin the Installation	5
Preparing the Mounting Area	5
Routing Speaker Wires	5
Making the Connections	5
Using an Adapter Harness	7
Connecting Ground, Power, and Optional Components	7
Connecting Speakers	8
Connecting the Antenna	8
Completing the Connections	8
Testing the Connections	9
Mounting the Stereo	9
Removing the Stereo from the Dash	11
Using the Faceplate	12
Installing the Faceplate	12
Removing the Faceplate	12
Basic Operation	13
Turning the Stereo On and Off	13
Setting the Clock	13
Adjusting the Sound/Tuning	13
Radio Operation	15
Playing the Radio	15
Memory Tuning	15
Automatically Storing Stations	16
Manually Storing Stations	16
Selecting a Stored Station	17
Scanning Stored Stations	17
Cassette Player Operation	18
Playing a Cassette	18
Fast-Forward and Rewind	19
Care and Maintenance	20
The FCC Wants You to Know	20
Cleaning the Tape-Handling Parts	21
Restoring Tape Tension and Sound Quality	21
Replacing a Fuse	21
Specifications	23

INSTALLATION

BEFORE YOU BEGIN THE INSTALLATION

Before you install your stereo, read all the instructions in this owner's manual. You should be able to answer all of these questions about your vehicle's electrical and sound systems:

- Which terminal in my vehicle's fuse box supplies power even when the ignition is turned off?
- Which terminal in my vehicle's fuse box is for accessories?
- How do I connect a wire to the fuse box?

Also, be aware that installation in your vehicle might require cutting or modifying your vehicle.

Place the stereo as close as possible to the selected mounting location. We recommend that you install the stereo by temporarily connecting it to ground and power, optional components, and your speakers. Then test the connections, disconnect the stereo, mount it in your vehicle, and reconnect it. The instructions in this manual are arranged in this order.

Preparing the Mounting Area

Before you mount the stereo, make sure you have all the necessary materials. Then confirm that the stereo

fits your vehicle's mounting area. This autosound stereo system is a DIN-E size unit that requires a 2¹/₁₆-inch high by 7³/₁₆-inch wide by 6¹¹/₁₆-inch deep (52 ¥ 182 ¥ 170 mm) mounting area.

Note: If the mounting area is too large, you might be able to mount the stereo with an in-dash installation kit, available at your local RadioShack store. Follow the installation kit's instructions to mount the stereo.

Caution: Be sure to avoid obstructions behind the mounting surface.

Routing Speaker Wires

If you install speakers, avoid routing the speaker wires near moving parts or sharp edges. You can usually route them along the wiring channel beneath the vehicle's door facings by carefully removing the molding that holds the carpet in place. After you route the speaker wires, replace the molding.

MAKING THE CONNECTIONS

The supplied harness with the 14-pin connector includes all the lead wires you need to connect the stereo to ground, power, some optional components, and speakers.

Important: Do not cut these wires. If you cut any wire, you cannot obtain a refund or exchange on this product. However, your local RadioShack store *will* provide warranty service if you cut a wire and find the product is defective.

You might need additional wire, depending on your individual auto-sound system, to complete the connections. Your local RadioShack store carries a full line of wire and wire management accessories.

Cautions:

- For added safety and to protect your stereo, disconnect the cable from your vehicle's negative (-) battery terminal before you begin.

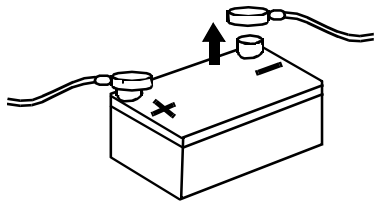

- Be sure your speakers can handle 8 watts of power (4 watts per channel). Each speaker must have an impedance of at least 4 ohms. Your local RadioShack store carries a full line of speakers.
- You must connect the **GROUND (-)**, **POWER LEAD (B+)**, and **CLOCK MEMORY** wires first, then make all other connections as

described in the following sections before you plug the harness with the 14-pin connector into the stereo. If you do not make connections in the order shown, damage to the stereo is possible if any wire connections are made incorrectly.

- You must connect a separate wire to each speaker terminal as described in the following procedure. Do not use a common wire or chassis ground for any speaker connection.

Note: The wires in the wiring harness have the following colors and labels.

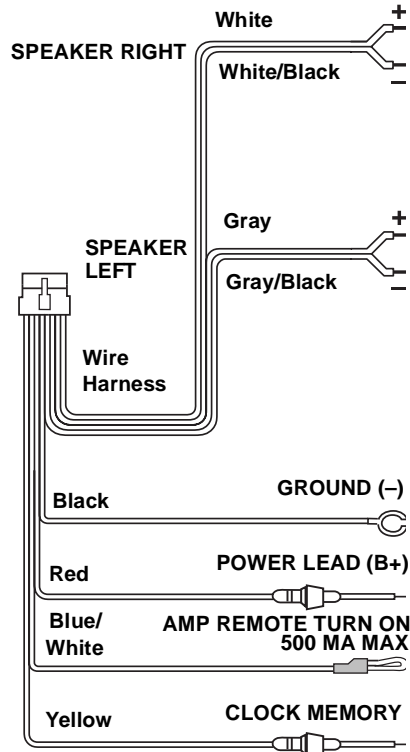

Using an Adapter Harness

If you are replacing an existing stereo, or if your vehicle has been factory-wired for autosound components, you might be able to use an adapter harness to connect the power and speakers. RadioShack stores sell adapter harnesses for most vehicles.

Follow the directions that come with the adapter harness to temporarily connect the ground, power, optional components, and speakers. Then go to "Connecting the Antenna" on Page 9.

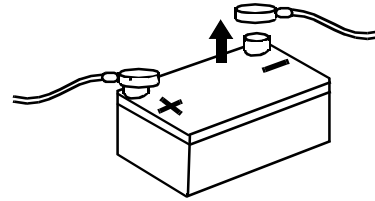

2. Connect the black **GROUND (-)** wire to a chassis ground, such as a metal screw attached to a metal part of the vehicle's frame. Be sure that the screw is not insulated from the chassis by a plastic part.
3. Connect the red **POWER LEAD (B+)** wire (with in-line filter and fuse holder) to a point in your vehicle's fuse block that has power only when you turn the vehicle's key to either the accessory (ACC) or START position.

This connection turns on the stereo when you turn on the ignition or turn the key to ACC, and turns off the stereo when you turn off the ignition. This prevents your vehicle's battery from being drained if you leave the stereo on when you turn off the ignition.

Connecting Ground, Power, and Optional Components

Follow these steps to connect the supplied harness with the 14-pin connector to ground, primary and memory backup power, and optional components.

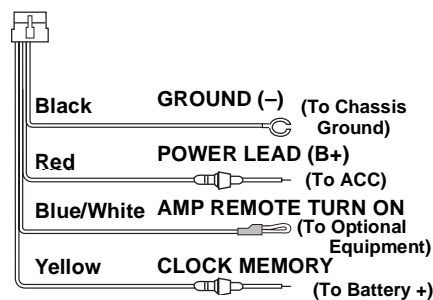

1. Disconnect the cable from your vehicle's negative (-) battery terminal.

4. Connect the yellow **CLOCK MEMORY** wire (with in-line fuse holder) to your vehicle battery's positive (+) terminal or to a point in your vehicle's fuse block that provides a continuous source of 12 volts.

This connection provides continuous power for the stereo's

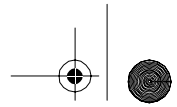

memory and clock display when the ignition is turned off.

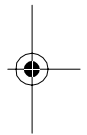
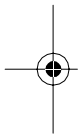

8

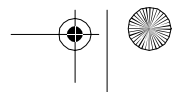
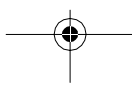

- Cut the loop at the end of the blue/white **AMP REMOTE TURN ON** wire, strip about $\frac{1}{2}$ inch of insulation from its end, then connect it to any optional equipment, designed to run from a switched source, that you want the stereo to turn on and off (such as a booster or a power antenna).

This wire does not provide power to the components. It simply turns them on or off. If you do not use this wire, secure it with a wire tie and do not let its bare wire ends touch metal.

Connecting Speakers

- Connect the gray wire to the right speaker's positive terminal. This terminal is usually marked with a plus (+) sign or red mark.
- Connect the gray/black wire to the right speaker's negative terminal. This terminal might be marked with a minus (-) sign or it might not be marked at all.
- Connect the white wire to the left speaker's positive terminal.
- Connect the white/black wire to the left speaker's negative terminal.

Connecting the Antenna

Connect the vehicle's antenna cable to the antenna jack on the back of the stereo.

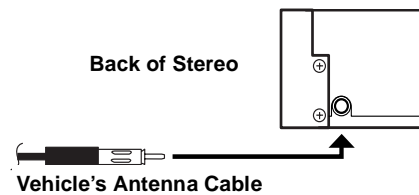

Completing the Connections

Make sure you have securely made all other connections, then plug the harness' connector into the stereo's 14-pin wiring socket. Reconnect the cable to the vehicle's negative (-) battery terminal.

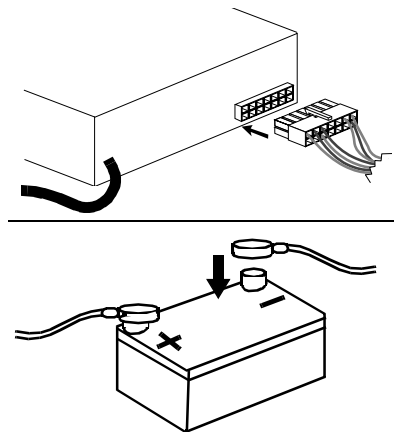

TESTING THE CONNECTIONS

Turn on your vehicle's ignition and install your stereo's faceplate (see "Installing the Faceplate" on Page 13). The stereo's display lights and the last station you tuned appears after about 5 seconds.

If the stereo does not work, **immediately disconnect the cable from your vehicle's negative (-) battery terminal.** Then recheck your connections.

After you verify that the display lights and the clock appears, follow the instructions in "Mounting the Stereo."

MOUNTING THE STEREO

Be sure you verify that the stereo is connected properly (see "Testing the Connections" on Page 10). Then follow these steps to mount the stereo.

1. Make sure the ignition is turned off, then disconnect the cable from your vehicle's negative (-) battery terminal.

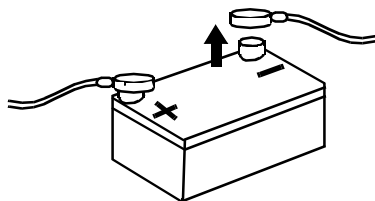

2. Disconnect the wire harness and the antenna.

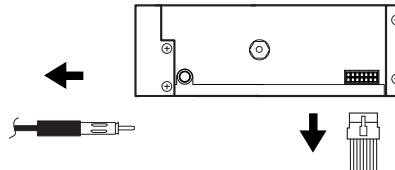

3. Press **REL** (release) on the left side of the faceplate to remove the faceplate, then snap the plastic collar off of the front of the stereo.

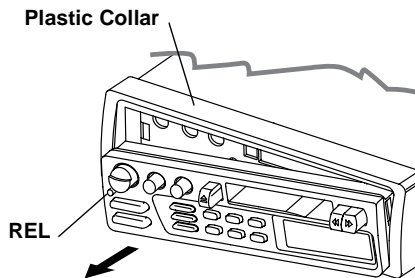

4. Insert both of the supplied keys into the slots at the middle left and right sides of the sleeve until they lock into place, and slide the sleeve off of the stereo.

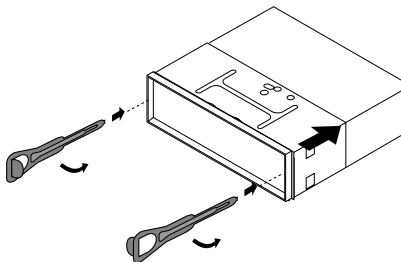

5. Insert the sleeve into the dash and bend out all the side tabs with a screwdriver to secure the sleeve.

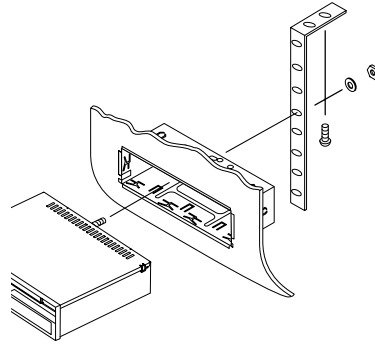
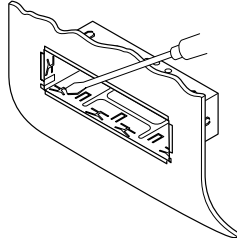

6. Reconnect the wire harness and the antenna.
7. Slide the stereo into the sleeve until it locks into place.

If you are securing the stereo to an existing mounting hole in the dash, push the mounting bolt (covered by the mounting grommet) through the existing mounting hole and make sure it is secure. If the mounting bolt is too short, attach the supplied mounting bolt extension to it.

8. Otherwise, you can use the supplied hardware to attach one end of the supplied metal strap to the bolt on the back of the stereo. If necessary, bend the metal strap to fit your vehicle's mounting area. Then attach the other end of the strap to a solid metal part of the vehicle. This strap also helps ensure proper electrical grounding of the stereo.

9. Snap the plastic collar onto the front of the stereo.
10. Reconnect the cable to the vehicle's negative (-) battery terminal. Then install the stereo's faceplate (see "Installing the Faceplate" on Page 13).

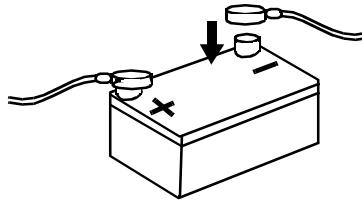

REMOVING THE STEREO FROM THE DASH

If you ever want to remove the stereo from the dash, follow these steps.

1. Disconnect the cable from your vehicle's negative (-) battery terminal.

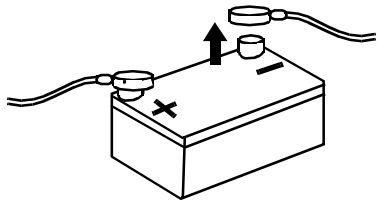

2. If you secured the stereo to an existing mounting hole under the dash, slide out the stereo to free the mounting bolt from the mounting hole.

Or, remove the bolt holding the metal strap to the back of the stereo.

3. Press **REL** to remove the stereo's faceplate.
4. Snap the plastic collar off of the front of the stereo.

5. Insert both of the supplied keys into the slots at the middle left and right sides of the sleeve, press the keys inward until they lock into place, then slide the stereo out of the dash.

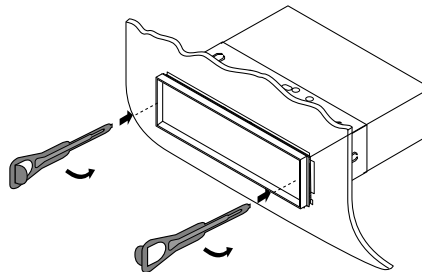

6. Disconnect the wire harness and the antenna.

7. Reconnect the cable to the vehicle's negative (-) battery terminal.

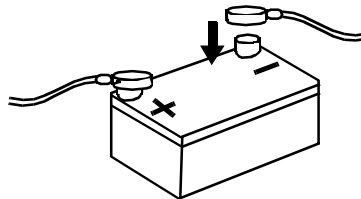

USING THE FACEPLATE

The stereo's faceplate must be in place for the stereo to operate. When you remove it, the display turns off and the stereo cannot be used. This is a simple but effective security measure.

Any stored stations remain in memory when the faceplate is removed.

INSTALLING THE FACEPLATE

Caution: Avoid pushing on the display or pressing any buttons while installing the faceplate.

1. Insert the right edge of the faceplate into the right edge of the recess. The slot in the faceplate interlocks with the tab in the recess.

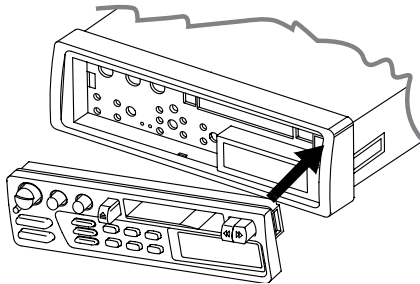

2. Gently push the left edge of the faceplate into the recess until you hear a click.

REMOVING THE FACEPLATE

1. Press **REL**. You hear a click and the faceplate swings out.

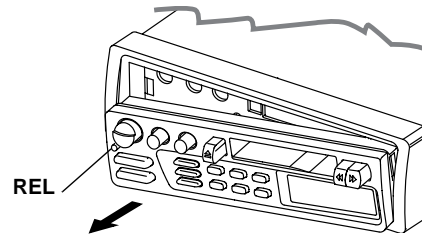

2. Remove the faceplate, then store it in the supplied carry case.

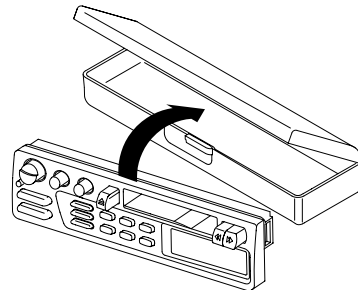

Caution: To keep the metal connecting pins clean, do not touch the connecting pins in the recess or on the back of the faceplate.

BASIC OPERATION

TURNING THE STEREO ON AND OFF

To turn on the stereo, turn **PWR./VOL.** clockwise until it clicks. To turn off the stereo, turn **PWR./VOL.** counterclockwise until it clicks.

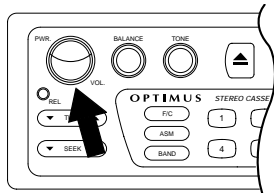

- While holding down **F/C**, repeatedly press **TUNE s** until the stereo displays the correct minute. (To quickly advance the minute, hold down **TUNE s**.)

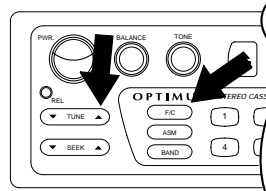

- When the display shows the correct hour and minute, release **F/C**.

SETTING THE CLOCK

Note: You can set the clock only when the vehicle's ignition is turned on or set to ACC.

- If the stereo is off, turn **PWR./VOL.** clockwise to turn it on.

Note: The display normally shows the clock. If necessary, hold down **F/C** (frequency/clock) until the clock display appears.

- While holding down **F/C**, repeatedly press **TUNE t** until the stereo displays the correct hour. (To quickly advance the hour, hold down **TUNE t**.)

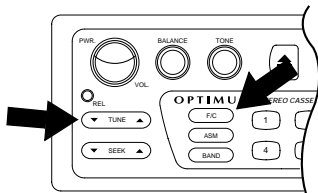

ADJUSTING THE SOUND/TUNING

When you listen to your stereo, adjust these controls to suit your listening preferences and tune the stereo.

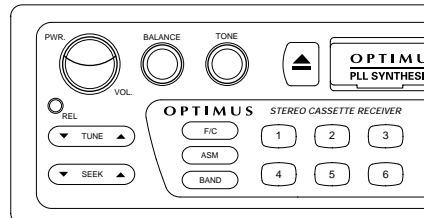

PWR./VOL. — turn clockwise to increase or counterclockwise to decrease the volume.

Warning: To protect your hearing, do not listen at high volume levels. Slowly increase the volume to a comfortable listening level.



BALANCE — rotate to adjust the balance between the right and left speakers.

TONE — rotate to increase or decrease high sounds.

BAND — press to select the desired band and memory group.

ASM — hold down to automatically scan and store the next six strong stations in the selected band, or press to scan all stations stored in a selected memory group (see “Memory Tuning” on Page 16).

F/C — press to display the current frequency or the clock.

TUNE t or **TUNE s** — repeatedly press to tune down or up to the next station in the selected band (see “Playing the Radio” on Page 16).

SEEK s or **SEEK t** — press to automatically tune to the next lower or higher station with a strong signal (see “Playing the Radio” on Page 16).

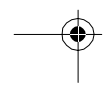
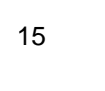
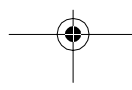
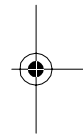
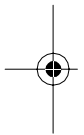

RADIO OPERATION

PLAYING THE RADIO

1. If the stereo is off, turn **PWR./VOL.** clockwise until it clicks to turn it on. The radio automatically tunes to the last station selected.

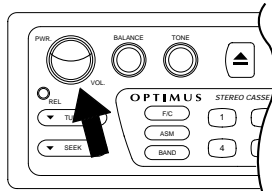

2. Press **BAND** to select the desired band. **AM 1** or **AM 2** appears when an AM band is selected. **FM 1**, **FM 2**, or **FM 3** appears when an FM band is selected.

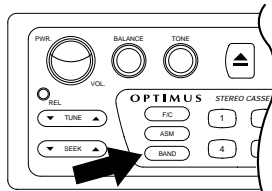

3. Tune to the desired station in one of the following ways.

Manual Tuning: Repeatedly press **TUNE t** or **TUNE s** to tune down or up to the desired station.

Seek Tuning: Hold down **SEEK s** or **SEEK t** for about 1 second to automatically tune to the next higher or lower station with a strong signal.

4. Adjust **PWR./VOL.**, **BALANCE** and **TONE** as desired.

Notes:

- **ST** appears when an FM signal is received in stereo.
- Each time you press **BAND**, the radio tunes to the last station selected in the band.
- To temporarily display the frequency, press **F/C** (frequency/clock). The display shows the frequency for 5 seconds, then returns to the clock display.

MEMORY TUNING

You can manually store up to 12 AM and 18 FM stations in memory groups. Each memory group (AM 1, AM 2, FM 1, FM 2, and FM 3) holds up to six stations. Or, you can automatically store the first 6 strong stations in a band into a memory group for that band.

Automatically Storing Stations

1. Repeatedly press **BAND** until the stereo displays the band and memory group where you want to store a group of stations. For example, to store the first group of AM stations into AM 1, press **BAND** until **AM 1** appears.
2. Tune to the station just before the first station you want to store.
3. Hold down **ASM** (automatic memory scan) for about 3 seconds. The stereo displays **LOC**, scans the selected band, and automatically stores the first 6 strong stations it finds, starting with the desired station.

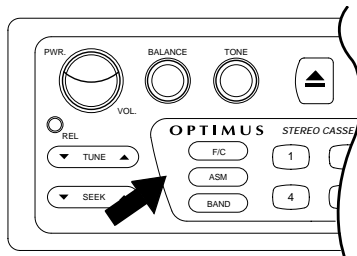

The band number, frequency, and memory location number appear on the display when the station is stored. After all 6 stations are stored, the stereo tunes to the first station and begins to play.

Note: If the stereo could not find 6 stations, it scans again, searching for weaker stations, and **LOC** disappears.

4. To stop searching for stations before all stations are stored, press **ASM** again.

Manually Storing Stations

1. Repeatedly press **BAND** until the stereo displays the band and memory group where you want to store a station. For example, to store FM stations into FM 2, press **BAND** until **FM2** appears.
2. Tune to the station you want to store.
3. Hold down the desired memory location button until the band number, the frequency, and the memory location number appear on the display for about 5 seconds. The volume briefly mutes then returns to normal. The station is stored.

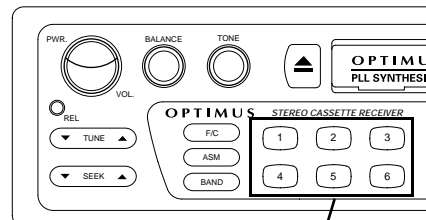

Memory Location Buttons



Selecting a Stored Station

To select a station, repeatedly press **BAND** to select the desired memory group, then press the desired memory location button.

Note: Do not hold down the memory location button. This stores the currently tuned station into that location.

Scanning Stored Stations

The radio can scan all stored stations in the selected memory group, pausing for about 5 seconds at each station. The radio can also scan all stored stations in all memory groups.

To start scanning stations, repeatedly press **BAND** to select the desired memory group. The radio scans all stored stations in all memory groups. Then, when you press **ASM**, the radio scans all stored stations in the selected memory group.

Important: Do not hold down **ASM**. This causes the stereo to automatically seek and store stations into the selected memory group.

As the stereo scans each memory location in the selected memory group, the current memory location number flashes.

To stop scanning when the radio pauses at a station you want to listen to, press **ASM** again.

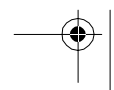
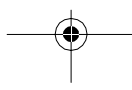

CASSETTE PLAYER OPERATION

PLAYING A CASSETTE

Caution: Avoid using C-120 cassette tapes. They are very thin and can easily become tangled in the tape-handling parts.

Follow these steps to play a cassette tape.

1. Take up any slack by turning the cassette's hub with your finger or a pencil. (Avoid touching the tape.)

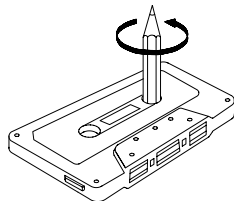

2. If the stereo is off, turn **PWR./VOL.** clockwise until it clicks to turn it on.
3. Insert the tape into the cassette compartment with its open edge to the right and the side you want to hear facing up. The tape begins to play, and the direction indicator appears on the display.

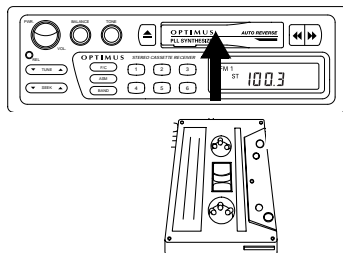

4. Adjust **VOLUME, BALANCE** and **TONE** as desired.

5. Press **▲** all the way in to stop the tape and eject it. The radio plays.

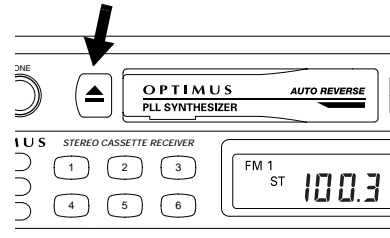

Caution: We recommend you press **▲** as soon as you finish playing a tape or before you leave your vehicle, to release it from the tape-handling parts. This reduces the possibility of a tape being inadvertently tangled or damaged.

Notes:

- When the tape reaches the end, the cassette player automatically changes the tape's direction and plays the other side of the tape. Play continues until you press **▲**.
- During play, you can switch to the other side of the cassette by pressing **◀▶** at the same time so the arrow on the display changes direction.

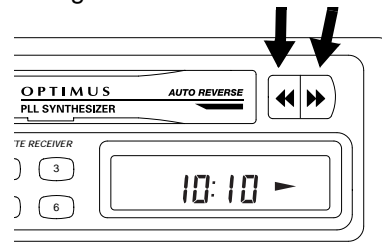

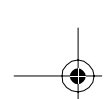

Fast-Forward and Rewind

To fast-forward or rewind the current side, press **▶▶** or **◀◀** depending on which side of the tape is playing. The tape quickly winds. Play resumes when the end of the tape side is reached or when you briefly press **▶**.

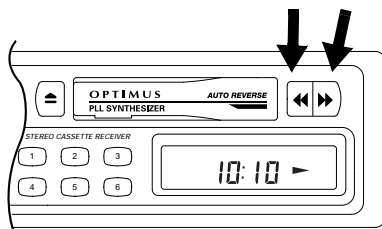

To stop fast forward or rewind before the end of the tape, gently press and release the opposite button (**◀◀** or **▶▶**) or **▶**. Play continues.

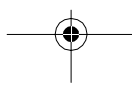
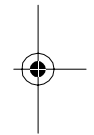
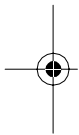

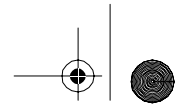

CARE AND MAINTENANCE

Your Optimus In-Dash AM/FM Stereo Cassette with Auto-Reverse is an example of superior design and craftsmanship. The following suggestions will help you care for your stereo so you can enjoy it for years.



Keep the stereo and faceplate dry. If either gets wet, wipe it dry immediately. Liquids might contain minerals that can corrode the electronic circuits.



Keep the stereo and faceplate away from dust and dirt, which can cause premature wear of parts.



Handle the stereo and faceplate gently and carefully. Dropping either can damage circuit boards and cases and can cause the stereo to work improperly.



Wipe the stereo with a damp cloth occasionally to keep it looking new. Do not use harsh chemicals, cleaning solvents, or strong detergents to clean the stereo.

Modifying or tampering with the stereo's internal components can cause a malfunction, invalidate your stereo's warranty and void your FCC authorization to operate it. If your stereo is not performing as it should, take it to your local RadioShack store for assistance.

THE FCC WANTS YOU TO KNOW

Your stereo might cause TV or radio interference even when it is operating properly. To determine whether your stereo is causing the interference, turn off your stereo. If the interference goes away, your stereo is causing it. Try to eliminate the interference by:

- Moving your receiver away from the stereo
- Contacting your local RadioShack store for help

If you cannot eliminate the interference, the FCC requires that you stop using your stereo.

CLEANING THE TAPE-HANDLING PARTS

Clean the tape head after about every 20 hours of playing time. Insert a special head-cleaning cassette (such as Cat. No. 44-1202), and follow the cassette's directions to clean the tape head.

RESTORING TAPE TENSION AND SOUND QUALITY

After you play a cassette tape a few times, the tape might become tightly wound on the reels. This can cause playback sound quality to deteriorate.

To restore the sound quality, fast-forward the tape from the beginning to the end of one side, then rewind it. Then loosen the tape reels by gently tapping each side of the cassette's outer shell on a flat surface.

Caution: Be careful not to damage the cassette when tapping it. Do not touch the exposed tape or allow any sharp objects near the cassette.

REPLACING A FUSE

If the stereo does not operate, you might need to replace the **POWER LEAD (B+)** wire's 3-amp 1¹/₄-inch fuse with the supplied spare fuse (Cat. No. 270-1009). If the clock resets or stored stations are lost when the ignition is off, you might need to replace the **CLOCK MEMORY** wire's 0.5-amp 1¹/₄-inch fuse with the supplied spare fuse (Cat. No. 270-1003).

Caution: Do not use a fuse with ratings other than those specified here. Doing so might damage your stereo.

Follow these steps to replace either of your stereo's fuses.

1. Disconnect the cable from your vehicle's negative (-) battery terminal.

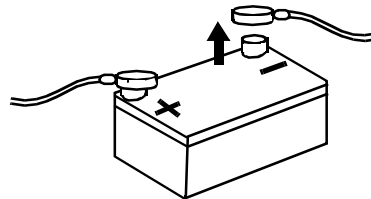

2. To open the fuse holder, push together then twist the fuse holder's parts until they spring apart. Then remove the fuse.

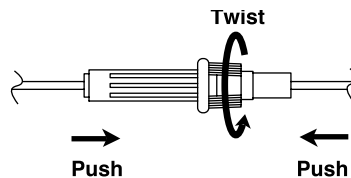

3. If the fuse is blown, replace it. Use only standard 1¹/₄-inch fuses with the proper rating. The **POWER LEAD (B+)** wire's fuse must be 3 amps. The **CLOCK MEMORY** wire's fuse must be 0.5 amps.
4. Reassemble the fuse holder by inserting the fuse and pushing together and twisting the two parts until they latch.

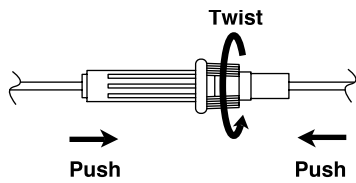

5. Reconnect the cable to the vehicle's negative (-) battery terminal.

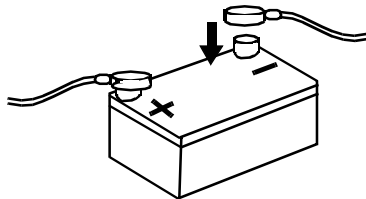

6. Reset your stereo's clock and memory settings as well as other vehicle accessories.

SPECIFICATIONS

RADIO

	FM (Nominal)	AM (Nominal)
Frequency Range	88–108 MHz	530–1710 kHz
IF Rejection	75 dB	50 dB
Image Rejection	44 dB	55 dB
Selectivity	60 dB	35 dB
Signal-to-Noise (S/N) Ratio	65 dB	48 dB
Stereo Separation	36 dB	—
Usable Sensitivity	3.0 mV (3% THD)	10 mV (20 dB S/N)

CASSETTE PLAYER

Cassette Mechanism	Auto Reverse
Wow and Flutter	Less than 0.15% WRMS
Signal-to-Noise Ratio	48 dB
Separation	35 dB
Frequency Response (–3 dB)	125–8,000 Hz

GENERAL

Power Source	12V DC Negative Ground
Speaker Output Impedance	4 Ohms or 8 Ohms
Maximum Power	7 Watts/Channel
Power Output (10% THD @ 1 kHz)	4 Watts RMS/Channel
Chassis Size (HWD)	1 ¹⁵ / ₁₆ ¥ 7 ¥ 5 ¹⁵ / ₁₆ Inches (50 ¥ 178 ¥ 151 mm)
Weight	3 lbs (1.3 kg)

Specifications are typical; individual units might vary. Specifications are subject to change and improvement without notice.



Limited One-Year Warranty

This product is warranted by RadioShack against manufacturing defects in material and workmanship under normal use for one (1) year from the date of purchase from RadioShack company-owned stores and authorized RadioShack franchisees and dealers. EXCEPT AS PROVIDED HEREIN, RadioShack MAKES NO EXPRESS WARRANTIES AND ANY IMPLIED WARRANTIES, INCLUDING THOSE OF MERCHANTABILITY AND FITNESS FOR A PARTICULAR PURPOSE, ARE LIMITED IN DURATION TO THE DURATION OF THE WRITTEN LIMITED WARRANTIES CONTAINED HEREIN. EXCEPT AS PROVIDED HEREIN, RadioShack SHALL HAVE NO LIABILITY OR RESPONSIBILITY TO CUSTOMER OR ANY OTHER PERSON OR ENTITY WITH RESPECT TO ANY LIABILITY, LOSS OR DAMAGE CAUSED DIRECTLY OR INDIRECTLY BY USE OR PERFORMANCE OF THE PRODUCT OR ARISING OUT OF ANY BREACH OF THIS WARRANTY, INCLUDING, BUT NOT LIMITED TO, ANY DAMAGES RESULTING FROM INCONVENIENCE, LOSS OF TIME, DATA, PROPERTY, REVENUE, OR PROFIT OR ANY INDIRECT, SPECIAL, INCIDENTAL, OR CONSEQUENTIAL DAMAGES, EVEN IF RadioShack HAS BEEN ADVISED OF THE POSSIBILITY OF SUCH DAMAGES.

Some states do not allow the limitations on how long an implied warranty lasts or the exclusion of incidental or consequential damages, so the above limitations or exclusions may not apply to you.

In the event of a product defect during the warranty period, take the product and the RadioShack sales receipt as proof of purchase date to any RadioShack store. RadioShack will, at its option, unless otherwise provided by law: (a) correct the defect by product repair without charge for parts and labor; (b) replace the product with one of the same or similar design; or (c) refund the purchase price. All replaced parts and products, and products on which a refund is made, become the property of RadioShack. New or reconditioned parts and products may be used in the performance of warranty service. Repaired or replaced parts and products are warranted for the remainder of the original warranty period. You will be charged for repair or replacement of the product made after the expiration of the warranty period.

This warranty does not cover: (a) damage or failure caused by or attributable to acts of God, abuse, accident, misuse, improper or abnormal usage, failure to follow instructions, improper installation or maintenance, alteration, lightning or other incidence of excess voltage or current; (b) any repairs other than those provided by a RadioShack Authorized Service Facility; (c) consumables such as fuses or batteries; (d) cosmetic damage; (e) transportation, shipping or insurance costs; or (f) costs of product removal, installation, set-up service adjustment or reinstallation.

This warranty gives you specific legal rights, and you may also have other rights which vary from state to state.

RadioShack Customer Relations, Dept. W, 100 Throckmorton St., Suite 600, Fort Worth, TX 76102

We Service What We Sell

3/97



RadioShack
A Division of Tandy Corporation
Fort Worth, Texas 76102

5A8

P/N: 4301-3838-0
Printed in China

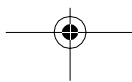

Free Manuals Download Website

<http://myh66.com>

<http://usermanuals.us>

<http://www.somanuals.com>

<http://www.4manuals.cc>

<http://www.manual-lib.com>

<http://www.404manual.com>

<http://www.luxmanual.com>

<http://aubethermostatmanual.com>

Golf course search by state

<http://golfingnear.com>

Email search by domain

<http://emailbydomain.com>

Auto manuals search

<http://auto.somanuals.com>

TV manuals search

<http://tv.somanuals.com>