

OptomaTV

OptomaTV

Optoma Technology Inc.  
Customer Services / Service Support  
715 Sycamore Drive  
Milpitas, CA 95035  
Phone: 888-289-6786

# RD50/RD65

## Owner's Manual

Please keep Owner's Manual for future reference

[www.OptomaTV.com](http://www.OptomaTV.com)

[www.OptomaTV.com](http://www.OptomaTV.com)



**WARNING**  
**RISK OF ELECTRIC SHOCK**  
**DO NOT OPEN**



**WARNING :** To reduce the risk of electric shock, **DO NOT** remove cover or back. No user-serviceable parts inside. Refer servicing to qualified service personnel.



This symbol is intended to alert the user to the presence of uninsulated "dangerous voltage" within the product's enclosure that may be of sufficient magnitude to constitute a risk of electric shock to persons.



This symbol is intended to alert the user to the presence of important operating and maintenance (servicing) instructions in the literature accompanying the appliance.

**Note:**

This equipment has been tested and found to comply with the limits for a Class B digital device, pursuant to part 15 of the FCC Rules. These limits are designed to provide reasonable protection against harmful interference in a residential installation. This equipment generates, uses and can radiate radio frequency energy and, if not installed and used in accordance with the instructions, may cause harmful interference to radio communications. However, there is no guarantee that interference will not occur in a particular installation. If this equipment does cause harmful interference to radio or television reception, which can be determined by turning the equipment off and on, the user is encouraged to try correct the interference by one or more of the following measures:

- Reorient or relocate the receiving antenna.
- Increase the separation between the equipment and the receiver.
- Connect the equipment into an outlet on a circuit different from that to which the receiver is connected.
- Consult the dealer or an experienced radio/TV technician for help.

# Table of Contents

---

IMPORTANT SAFETY INSTRUCTIONS .....	2
ACCESSORIES .....	4
REMOTE CONTROL BATTERY INSTALLATION .....	5
DESCRIPTION OF THE REMOTE CONTROL UNIT .....	6
DISCRETE IR CODE GENERATION.....	7
CONTROLS/TERMINALS	
Front Panel.....	8
Rear Panel.....	10
INSTALLATION	
Connecting Cable TV / Antenna .....	12
Connecting To A Computer/ Notebook.....	13
Connecting Video Game Units .....	14
Connecting To High-Definition Picture Sources .....	15
Connecting VCR .....	16
Connecting A DVD Player .....	17
HOW TO POWER ON AND OFF RD50/65 .....	18
ONSCREEN DISPLAY MENUS	
Getting Started: Automatic Channel Programming.....	20
Channel Add and Erase .....	21
Selecting The Language .....	22
Setting The Clock .....	23
Setting The Sleep Timer .....	24
Setting Your Favorite Channels .....	25
Adjusting The Picture .....	26
Displaying Different Picture Formats.....	28
PIP.....	30
POP.....	32
Channel Surfing in POP mode/POP Size Ratio .....	33
Advanced Picture Adjustments .....	34
Viewing Closed Captions.....	36
Program Block.....	37
Adjusting The Audio Settings .....	40
Lamp Change Instructions - RD50 .....	41
Lamp Change Instructions - RD65 .....	42
TROUBLESHOOTING .....	43
RD50/65 SPECIFICATIONS CHART	

### Important Safety Instructions For Your Display

1. Read and apply the operating instructions provided with your display.
2. Read all of the instructions given here and retain them for later use.
3. Follow all warning and instructions marked on the display.
4. **WARNING:** To reduce the risk of fire or electric shock, do not expose this appliance to rain or moisture.
5. **WARNING:** Because the temperature of the lamp is high immediately after use, direct contact with the lamp may cause burns. Do not replace the lamp module until it is cooled down
6. **Caution:** To prevent electric shock do not use this (polarized) plug with a receptacle or other outlet unless the blades can be fully inserted to prevent blade exposure.
7. Unplug this display from the wall outlet before cleaning. Do not use liquid or aerosol cleaners. Use a dry cloth for cleaning.
8. Do not use attachments/accessories not recommended by the manufacturer as they may cause hazards.
9. Do not use this display near water. For example: avoid placing it in or near a bathtub, kitchen sink, laundry tub, wet basement, swimming pool, etc.
10. Do not place this display on an unstable cart, stand or table. The display may fall, causing serious injury to a child or adult, and serious damage to the appliance. Use only with a cart or stand recommended by the manufacturer, or sold with the display.
11.  An appliance and cart combination shall be moved with care. Quick stops, excessive force, and uneven surfaces may cause the appliance and cart combination to topple.
12. Slots and openings in the cabinet and the back or bottom are provided for ventilation, to insure reliable operation of the display and to protect it from overheating. These openings must not be blocked or covered. There should be at least 2-inches of clearance from these openings. Never block the openings by placing the display on bed, sofa, rug or other similar surface. Never place this display near or over a radiator, or heat registers, stoves or other apparatus (including amplifiers) that produce heat.
13. Operate only from the type of power source indicated on the marking label. If you are not sure of the type of power supplied, contact your television dealer or local power company.
14. This display is equipped with a polarized alternating-current line plug (a plug having one blade wider than the other). This plug will fit into the power outlet only one way. This is a safety feature. If you are unable to insert the plug fully into the outlet, try reversing the plug. If the plug still doesn't fit, contact your electrician to replace your obsolete outlet. Do not defeat the safety purpose of the polarized plug.
15. Do not allow anything to rest on or pinch the power cord. Do not locate this display where the cord could be stepped on.
16. Do not overload wall outlets and extension cords as this can result in fire or electric shock.
17. Never push objects of any kind into this display through cabinet openings. This could result in a fire or electric shock. Never spill liquid of any kind on the display.



18. If an outside antenna is connected to the television equipment, be sure the antenna system is grounded so as to provide some protection against voltage surges and built up static charges. In the U.S., Section 810 of the National Electrical Code provides information with respect to proper grounding of the mast and supporting structure, grounding of the lead-in wire to an antenna discharge unit, size of grounding conductors, location of antenna-discharge unit, connection to grounding electrodes, and requirements for the grounding electrodes.
19. For additional safety during a lightning storm, or when it is left unattended and unused for long periods of time, unplug it from the wall outlet and disconnect the antenna. This will prevent damage to the receiver due to lightning and power-line surges.
20. An outside antenna system should not be located in the vicinity of overhead power lines or other electric light or power circuits, or where it can fall into such power lines or circuits. When installing an outside antenna system extreme care should be taken to avoid touching any power lines or circuits as contact with them could cause fatal injuries.
21. Unplug this display from the wall outlet and refer servicing to qualified service personnel under the following conditions:
  - a. When the power cord or plug is damaged or frayed.
  - b. If liquid has been spilled into the display.
  - c. If the display has been exposed to rain or water.
  - d. If the display does not operate normally by follow the operating instructions. Adjust only those controls that are covered by the operating instructions as improper adjustment of other controls may result in damage and will often require extensive work by a qualified technician to restore the display to normal operation.
  - e. When the display exhibits a distinct change in performance, have it serviced by an authorized service provider.
22. Do not attempt to service this display yourself as opening or removing covers may expose you to dangerous voltage or other hazards. Refer all servicing to qualified service personnel.
23. When replacement parts are required, be sure the service technician uses replacement parts specified by the manufacturer that have the same characteristics as the origin part. Unauthorized substitutions may result in fire, electric shock, or other hazards.
24. Upon completion of any service or repairs to this display, ask the service technician to perform routine safety checks to determine that the display is in safe operating condition.

**NOTE:** This equipment is designed to operate in the U.S.A..

Please review the following list of items to ensure you have received everything included:

- Power cord
- Remote control unit
- AV cable
- RF cord
- RF splitter
- Warranty card
- User's manual
- Two AAA batteries

### Battery Installation

1. Place the remote control face down and remove the battery cover.

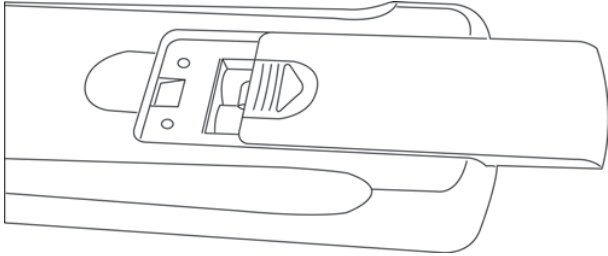

2. Insert two "AAA" size batteries, matching the + and - signs on each battery cell with the corresponding signs in the battery compartment.

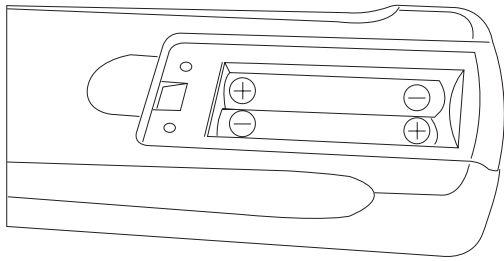

3. Slide the battery cover shut until the lock clicks.

## Description of the Remote Control Unit

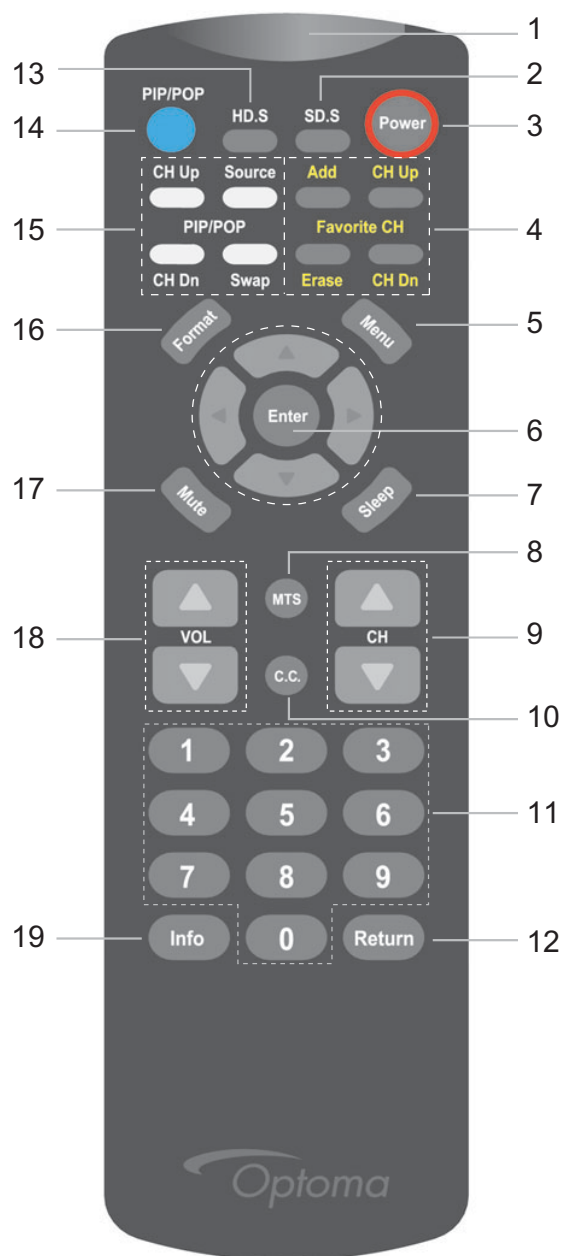

1. IR Filter
2. SD Selector
  - Selects SD sources AV1, AV2, AV3, SD1, ANT-1, ANT-2
3. Power
  - Power on / off
4. Favorite CH Shortcut Keys
5. Menu
  - Enter/Exit OSD function
6. Enter
7. Set Sleep Timer
8. MTS
  - Activate bilingual program functions
9. Change Channels
10. Closed Captions
11. Channel Selection Keypad
12. Return
  - Return to the previous channel
13. HD Selector
  - Select HD sources HD1, HD2, PC1, PC2
14. PIP/POP
  - Simultaneously view two programs on the same screen
15. PIP/POP Shortcut Keys
16. Format
17. Mute
18. Volume
19. Info

This remote control is capable of generating discrete IR codes. Discrete IR codes allow you to control a specific function by sending a direct command from the remote control, instead of having to use multiple onscreen menus to achieve the same result. This enhances control over frequently used functions that do not have specific key commands on the remote control. This is especially useful if you want to program these IR codes of this remote control to a "learning" universal remote control.

To generate discrete IR codes, simultaneously press the "Info" button with the right button.

Press simultaneously with the "Info" button'	IR Command generated
"0"	Power on
"Return"	Power off
"1"	Display source = AV1
"2"	Display source = AV2
"3"	Display source = AV3
"4"	Display source = SD
"5"	Display source = PC1
"6"	Display source = PC2
"7"	Display source = HD1
"8"	Display source = HD2
"9"	Turn off info of time or favorite channel
"CH up"	Display source = ANT1
"CH down"	Display source = ANT2
"VOL up"	Display time and source info
"VOL down"	Display favorite channel info
"C.C."	Turn on closed captioning CC1
"MTS"	Turn off closed captioning
"HD.S"	Display in Full mode
"SD.S"	Display in Full-L mode
"Source"	Display in 4:3 mode
"Format"	Display in Stretch mode
"Swap"	Displays in Wide 1 mode
Favorite CH "CH Up"	Display in Wide 2 mode
Favorite CH "CH Dn"	Display in Wide 3 mode
"Menu"	Display in Subtitle mode
"Mute"	Display in Native mode
"PIP/POP"	Turn on POP mode
PIP "CH Up"	Turn on PIP mode
PIP "CH Dn"	Turn off PIP or POP mode
up arrow	Select display setting USER1
left arrow	Select display setting USER2
right arrow	Select display setting USER3
down arrow	Select display setting Normal
"Enter"	Select display setting Cinema

**Front**

On the front of your RD50/65, you will find the control panel and indicator lights as illustrated below.

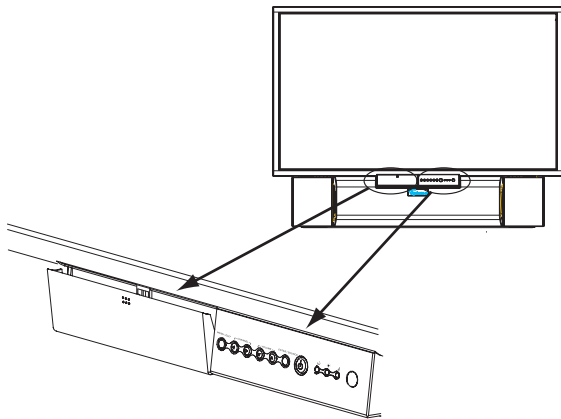

Front Terminals

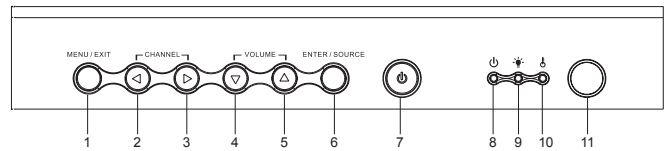
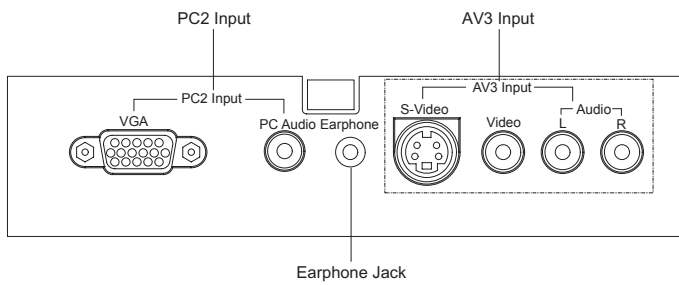

**Operating the Buttons**

1. Enter or Exit onscreen menu
2. Channel Down
3. Channel Up
4. Volume Down
5. Volume Up
6. Enter / Source
  - When the onscreen menu is on, this key is used to select the onscreen menu items.
  - Under normal use, this key switches sequentially from one signal source to another.
7. Power

**LED**

8. Power Indicator
9. Lamp Indicator
10. Temperature Indicator
11. Remote Control Sensor

Rear Panel

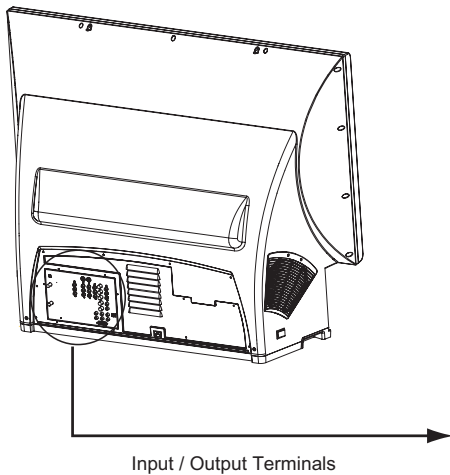

Input / Output Terminals

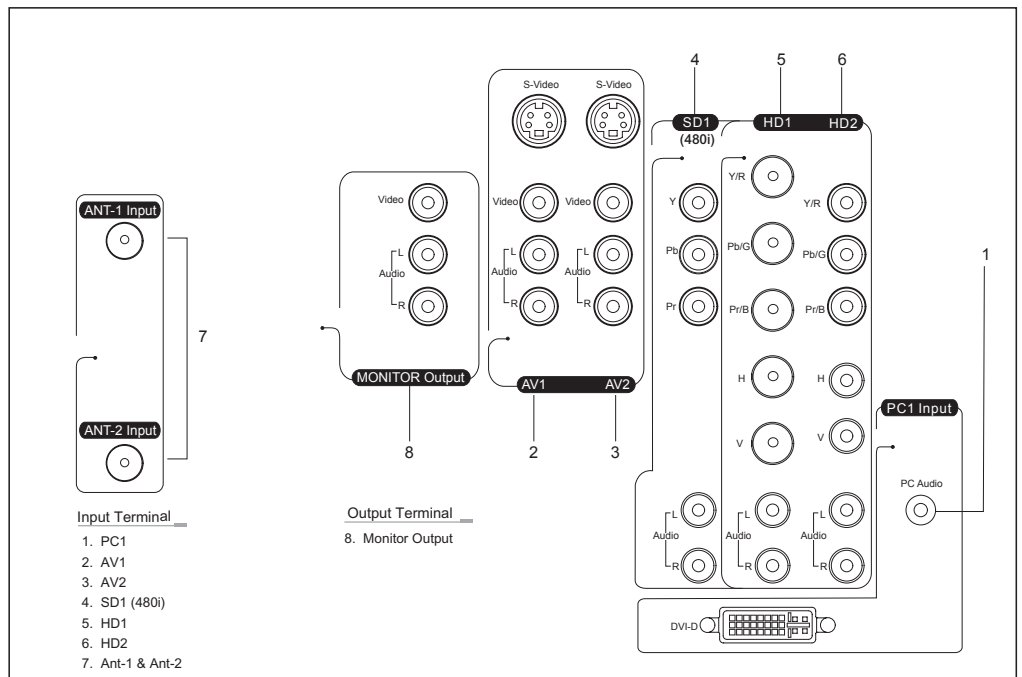

Note

- When composite video and S-Video sources are both connected to the same AV source, for example AV1, S-Video has higher priority over composite video source. We recommend that you do not connect S-Video and composite video sources to the AV connectors at the same time.
- The "Monitor Output" only outputs composite video for the composite video source selected



Your display is designed to accept and display a wide range of video programs and signal sources, including VHS, DVD, HDTV, video game consoles, and regular TV broadcasts. It is important to ensure that your external devices are properly connected to your display to ensure an optimum viewing experience.

## ■ Connecting Cable TV / Antenna

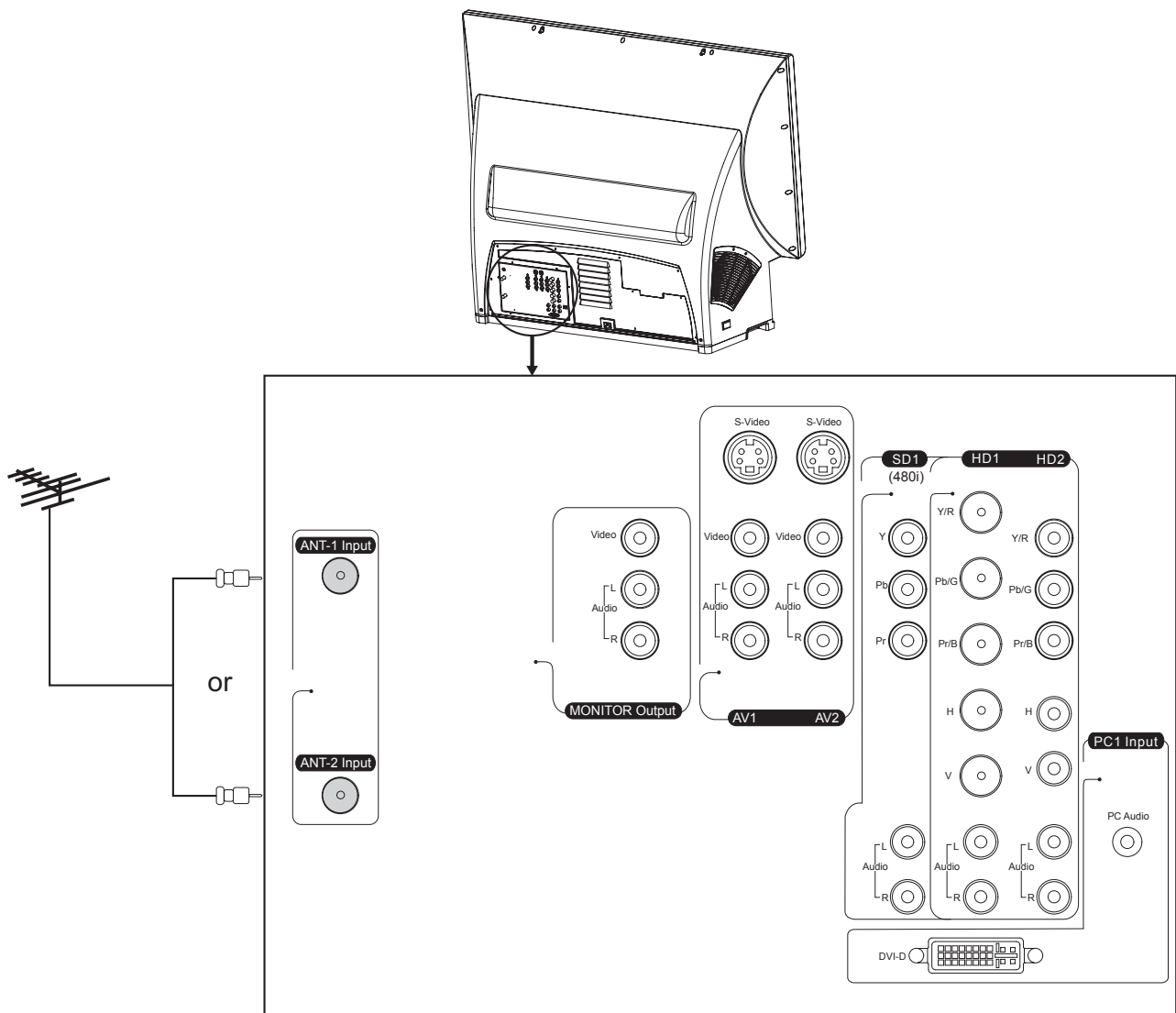
Connect your cable TV cable or antenna cable to either of the ANT inputs (ANT-1 Input, ANT-2 Input)



### Note

-  Indicates a connectable jack  Indicates a non-connectable jack
- For your convenience, this TV is bundled with a RF splitter and short RF cable, so that you can connect both your TV and VCR so that you can connect additional devices to one RF source.



## ■ Connecting to a Computer/Notebook

If you would like to connect the unit to a computer, you can choose to connect as following:

1. If your computer has a DVI-D output, connect it to the PC1 input
2. If you have a notebook computer, it is probably more convenient to connect it using the PC2 input on the front
3. If your computer has a RGB output, it can be connected to HD1 or HD2 or PC2. A VGA to RGBHV BNC cable is needed for HD1. A VGA to RGBHV RCA cable is needed for HD2. Or it can be connected directly using a VGA cable to PC2 input in the front

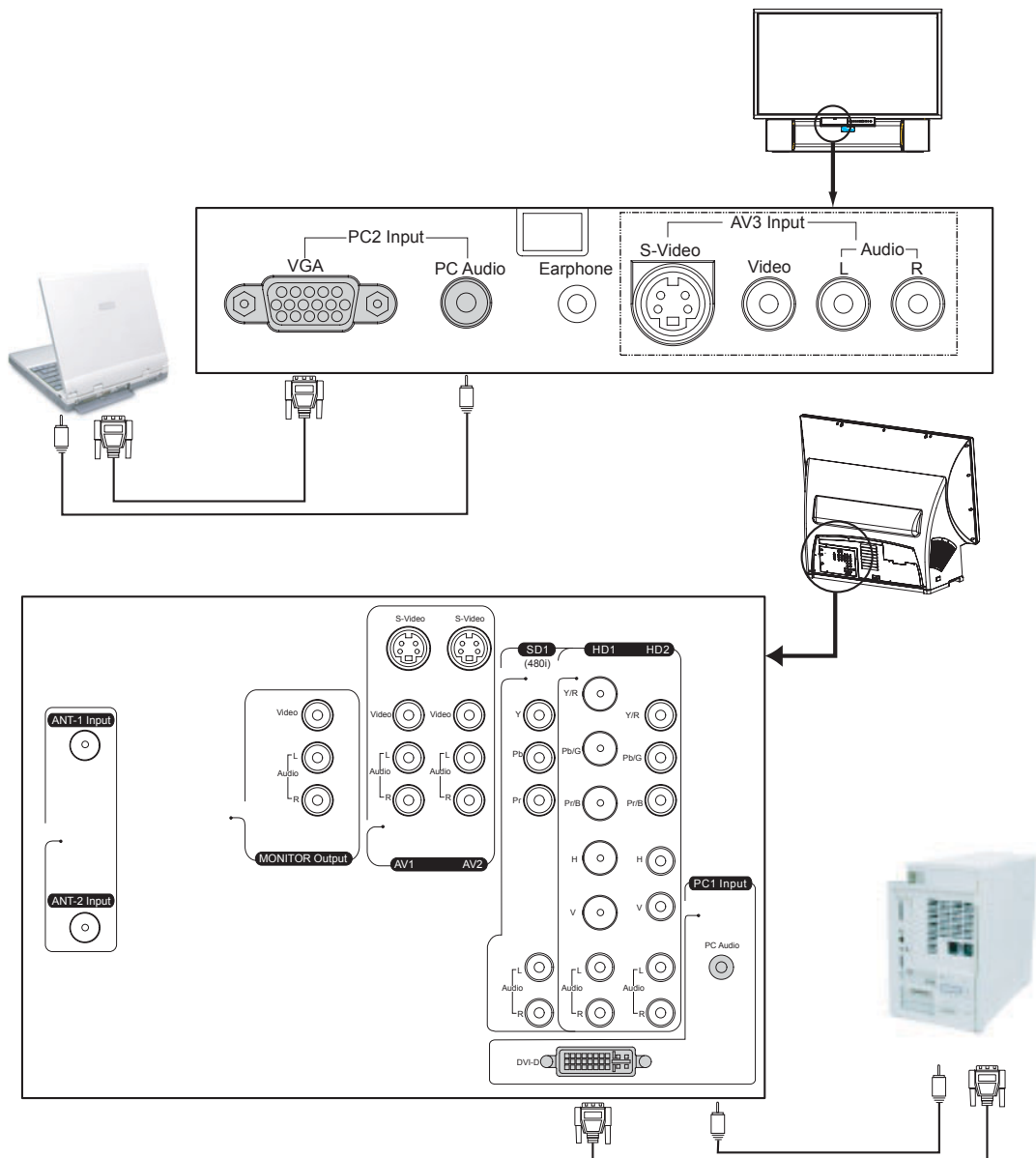

### Note

- Please carefully review all sections of the accompanying manual pertaining to the connection of external devices.
- Before attempting to connect the unit to any external device, be sure to power down any secondary power sources.

## Connecting Video Game Units

To connect a video game console to the display, you can either connect it to the AV1 or AV2 connector on the rear connector panel, or you can use the AV3 connectors located on the front connector panel.

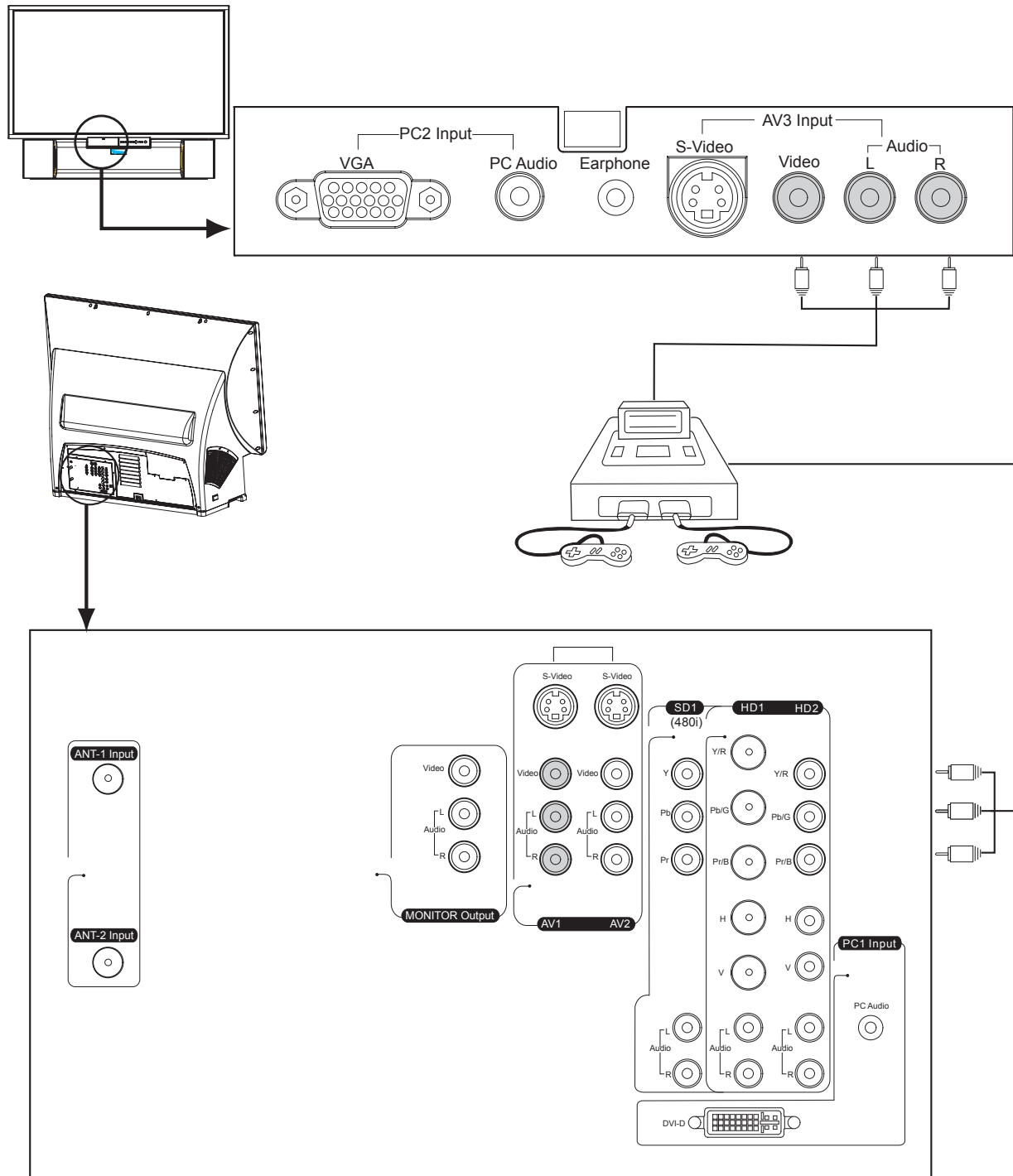

### Note

- If your video game console has an S-video output, we recommend connecting to the display instead, as this will provide superior picture quality.
- If your video game console has an YPbPr option, connect it to HD1 or HD2 for even better picture quality.

## Connecting to High-definition Picture Sources

If you have a D-VHS unit or a digital receiver, connect it to the display using the HD1 or HD2 connector jacks on the rear of the display.

If your digital receiver has a DVI output, you can connect it to PC1.

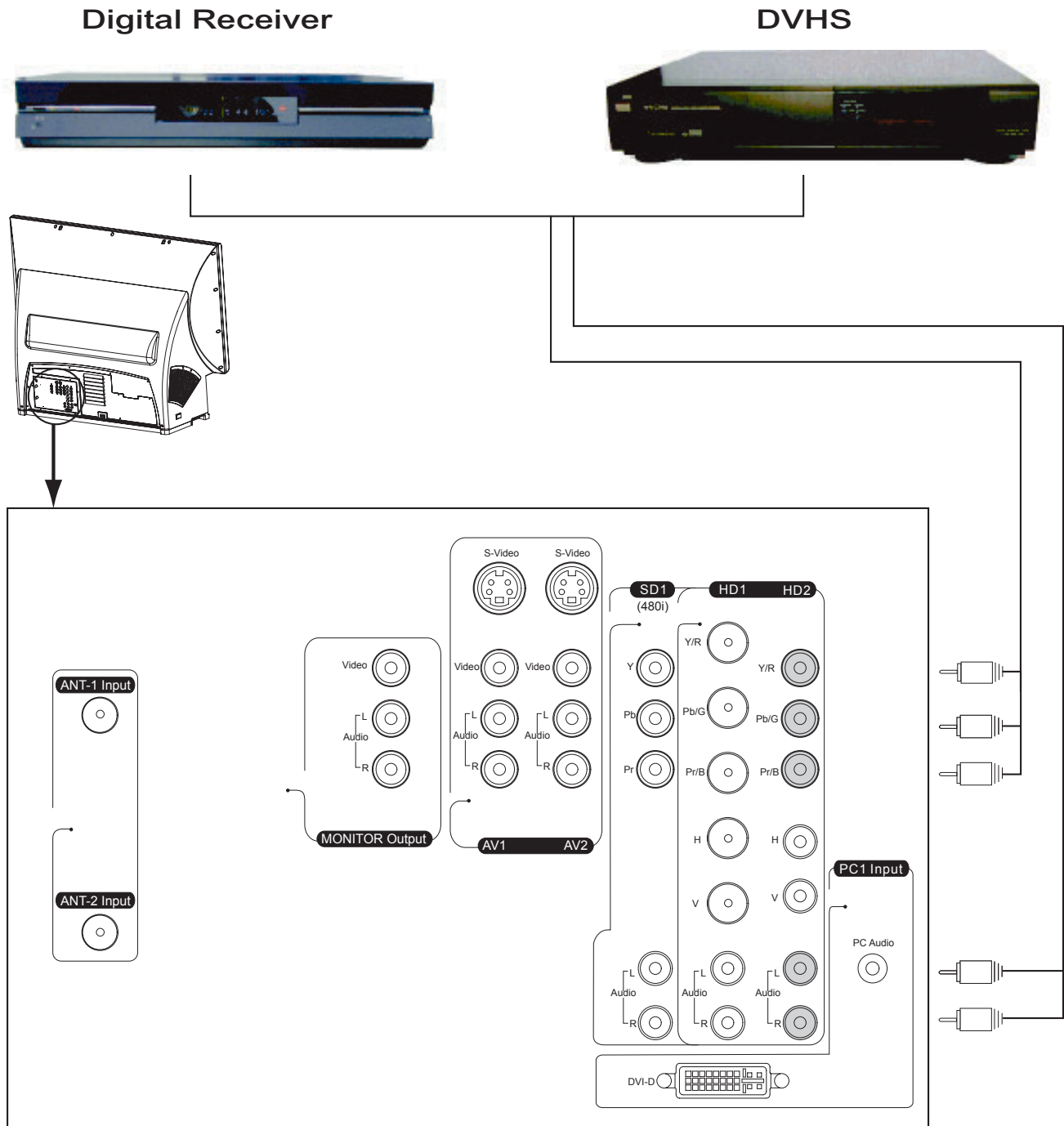

## Connecting VCR

Your VCR may have different kinds of outputs like RF, composite video and S-Video. Normally S-Video delivers the best video quality, RF output delivers lower quality video.

If S-Video is available, connect the S-Video output of your VCR to AV1, AV2 or AV3. If S-Video is not available, connect the composite video output on your VCR to AV1, AV2 or AV3. Connect the RF output of your VCR to ANT-2 of the TV if this is the only output available or if the VCR is located very far away from the TV.

If your VCR has a composite video input and you want to record the TV station you are currently watching, you can optionally connect the AV output of this TV to the video input and audio input of your VCR.

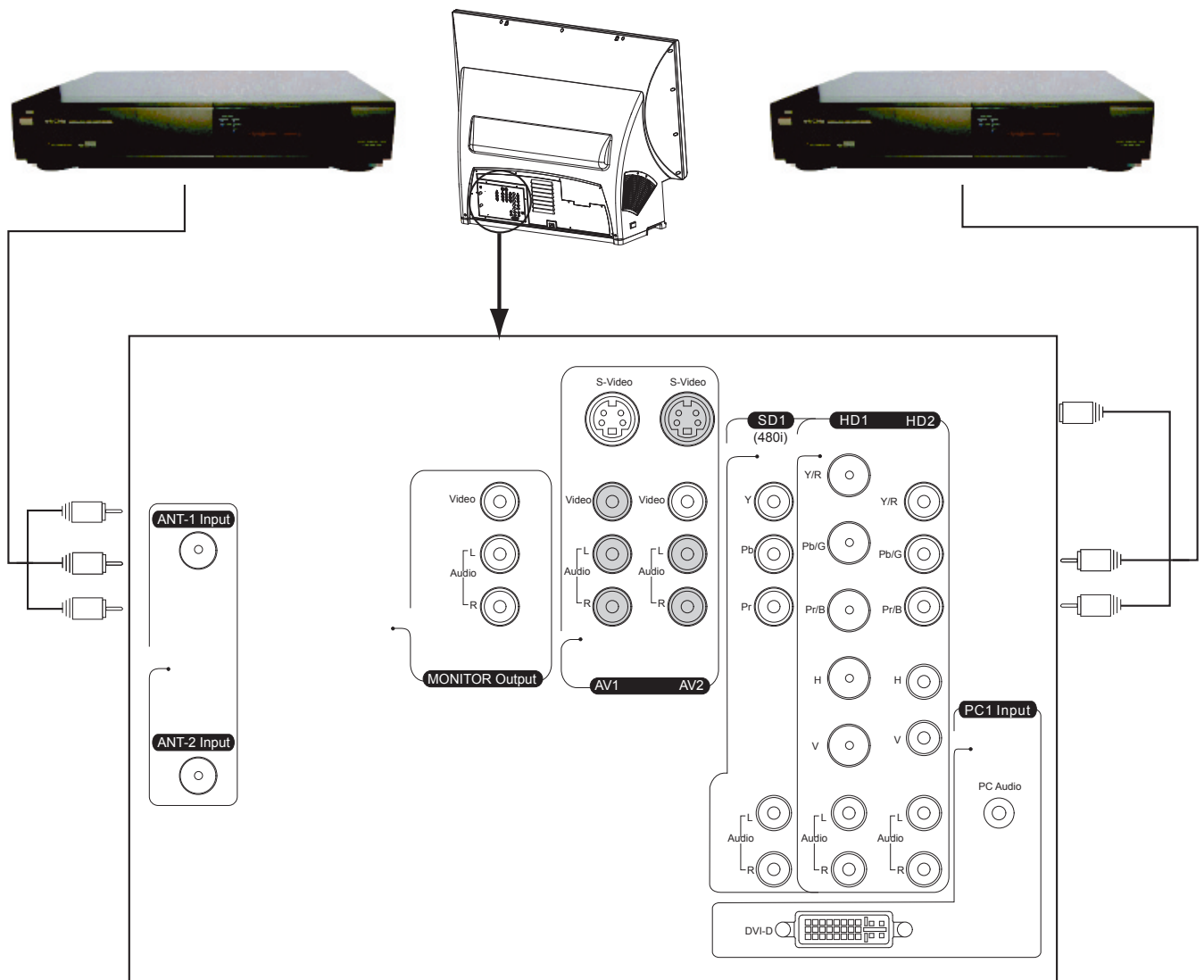

### Note

Your VCR can only record video if the main TV source is ANT-1 or ANT-2. If the main TV source is AV1, AV2 or AV3, only composite video is connected, and the video is not copy protected, then your VCR can also record it. Other higher quality video sources cannot output signals to this composite output for recording even if they are selected.

## Connecting a DVD Player

The RD 50/65 is equipped with state-of-the-art deinterlacing circuitry that is superior to the technology provided in most DVD players. The recommended input for DVD players is the SD input with DVD player output mode set to 480i.

Furthermore, please make sure the TV-type or TV aspect ratio is selected as widescreen (16:9) on the DVD player. The TV will work fine even if the TV's aspect ratio is set to the DVD player's default 4:3 ratio. However, the DVD player itself will output video at 33% lower resolution in 4:3 mode when playing back a 16:9 enhanced movie.

If you have a good progressive scan DVD player, you can connect the component video to either HD1 or HD2.

If your DVD player only has an S-Video or composite video output, connect it to the AV1, AV2 or AV3 of the TV. For better quality, only use composite video when the other options are not available.

Connect the DVD player's analog audio output (left and right channel) to the TV's audio input for the video source intended for DVD player.

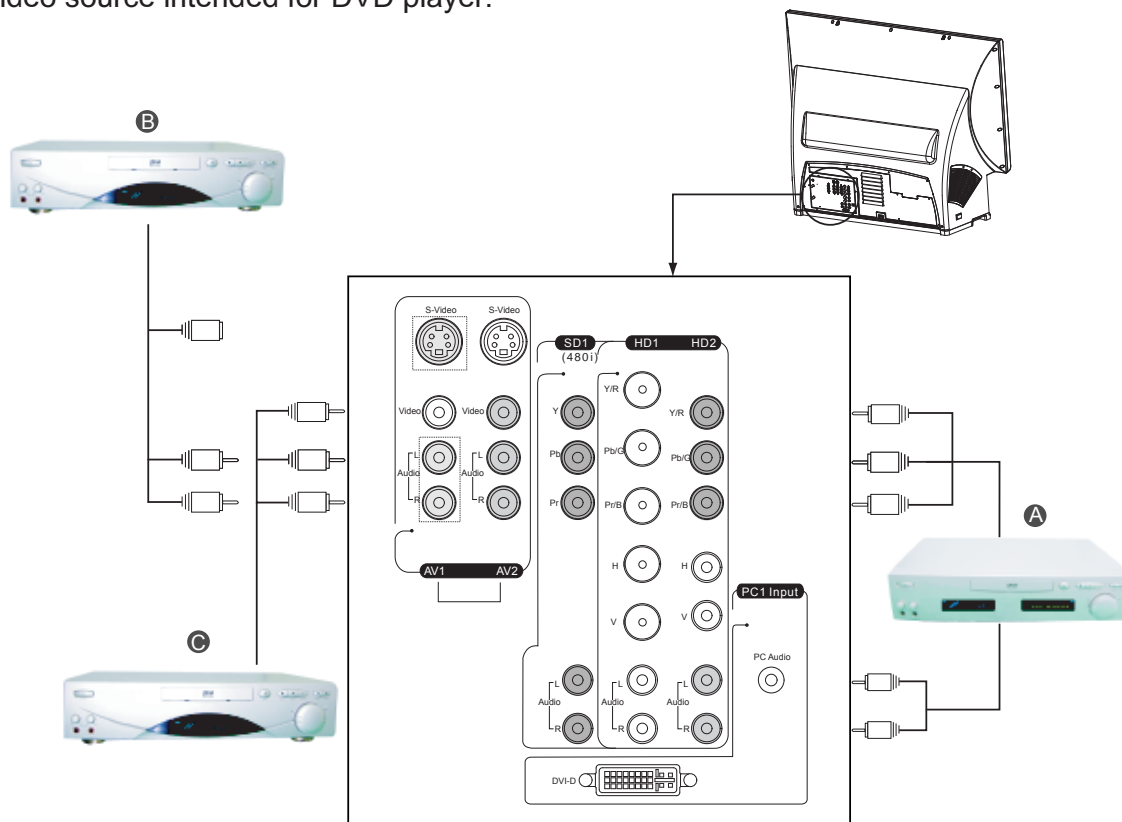

### Note

- If your DVD player has 5.1 channel output and you want to use the TV speakers as central speakers, you can connect only the central speaker output to either the left or right channel of the TV and then select mono mode on the onscreen display menu for audio. Refer to the "Adjust the Audio" section for more details.
- Once the DVD player has been properly connected and you are ready to begin viewing your DVD program, remember to use the remote control to select the video source connected.

# How to Power On and Off RD50/65

## RD50

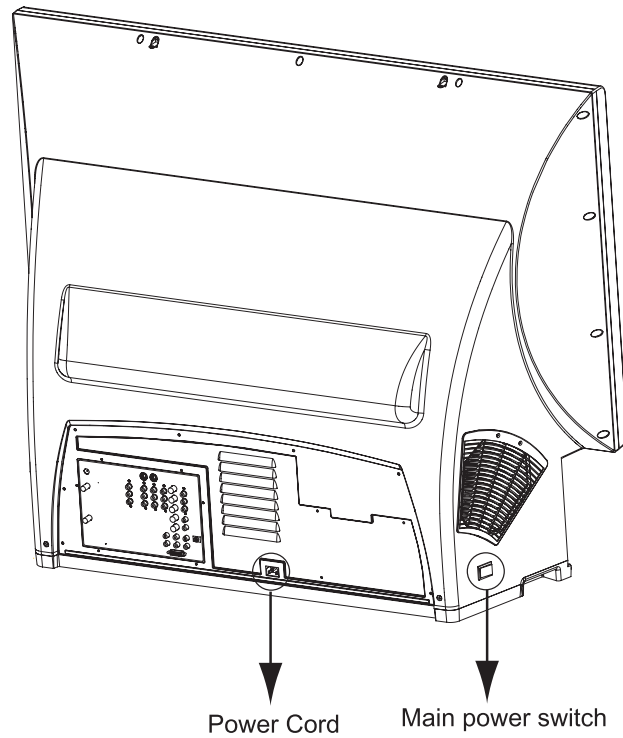

## RD65

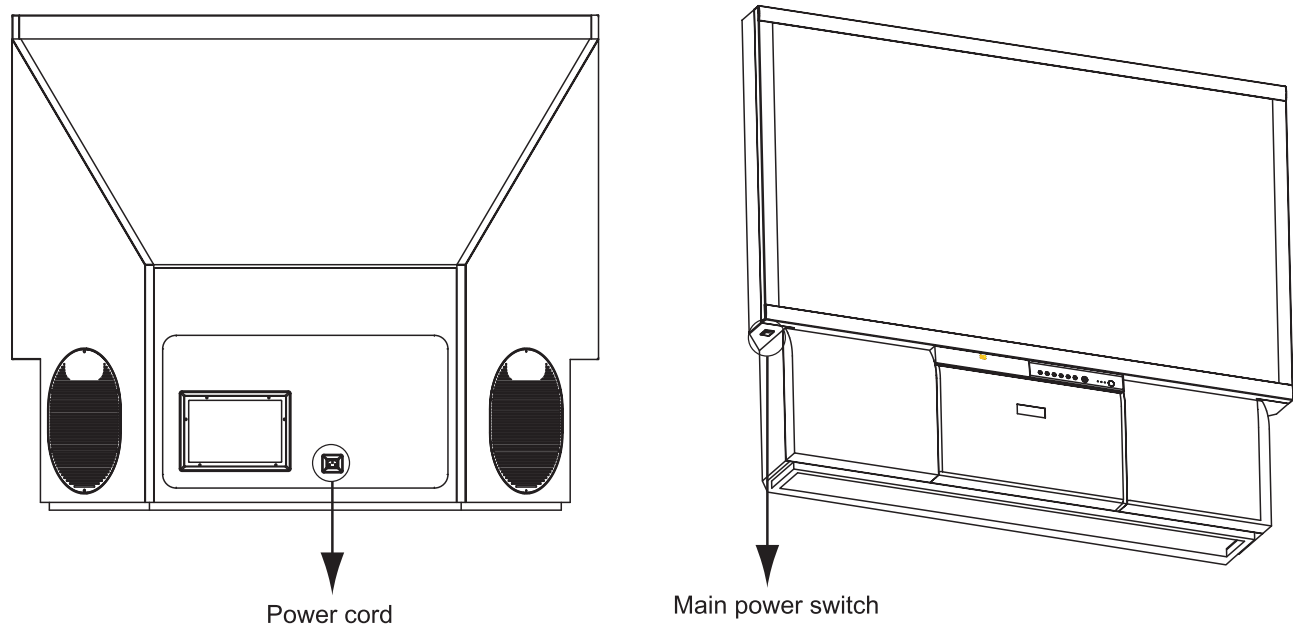

### Power On

#### Step 1

**Attach** the power cord to the RD50/65.

#### Step 2

**Switch** on the main power switch located at the left side of the display.

#### Step 3

Press the power button on the front panel or remote control to turn on the display. The display will turn on after warm up in about 30 seconds.

### Power Off

Press the power button on the front panel or remote control once to turn off the display. The screen will go blank immediately but it will take about 2 minute to cool down and then shutdown the whole system

Unless the display is not going to be used for an extended period of time, the main power switch can be left in the ON position without consuming a lot of power.

Except in case of emergency, it is not recommended to use the main power switch to power off the system. The lamp life may be severely reduced if the system is not allowed to cooled down properly by abruptly shutting down the system using the main power switch.

The power button toggles between power on and power off. Please refer to the Discrete IR code section for user who need the separate IR power on and power off IR code.

---

#### Note

- During the final phase of the cool down period the system will not respond to any power on or off commands. Wait until the LED stops blinking to power up the display again.

## Getting Started: Automatic Channel Programming

Before you can begin watching regular television programs, you will need to run automatic channel programming. Channel programs cannot be performed when the main picture is not receiving a TV broadcast. The whole process may take a few minutes but normally only needs to be done once on initial set up.



The diagram illustrates the process of automatic channel programming. On the left, a remote control is shown with arrows pointing to the SD.S, MENU, Enter, and Power buttons. On the right, the onscreen display menu is shown, with the 'Set Up' option highlighted. The 'Set Up' menu includes options like Language, CH Program, Sleep Timer, Clock, Favorite Ch, C.C., Program Block, PW Change, and Reset. The 'CH Program' option is further expanded to show 'CATV', 'TV', 'CH Add', and 'CH Erase'.

Picture	Format	PIP/POP	Audio	Set Up	Data
				Language	CATV
				CH Program	TV
				Sleep Timer	CH Add
				Clock	CH Erase
				Favorite Ch	
				C.C.	
				Program Block	
				PW Change	
				Reset	

**Step 1**  
Press SD.S until ANT-1 is selected.

**Step 2**  
Press MENU to launch the onscreen display.

**Step 3**  
Select SET UP using the ◀▶ buttons, then press ENTER.

**Step 4**  
Select CH PROGRAM using the ▲▼ buttons, then press ENTER. Then, use the ▲▼ buttons to select the type of program that you would like to scan for, either TV or CATV. The display will then begin automatically scanning through all available channels one-by-one, and will record a list of all channels that are broadcasting programs.

**Step 5**  
If ANT-2 is also connected, press SD.S until ANT-2 is selected and then repeat Steps 2, 3 and 4.

### Note

- Press any key on the remote control unit (except for POWER) to stop the automated channel testing cycle.
- The whole process may take a few minutes but normally only needs to be done once.



## Channel Add and Erase

Your RD50/65 allows you to manually add or remove channels from the lineup. When you press "CH up" or "CH down", it advances to the next channel broadcasting a signal. You can skip a channel, such as one you never watch, using the Erase feature. You can add a channel, such as one that wasn't initially detected or was previously erased, using the Add feature.

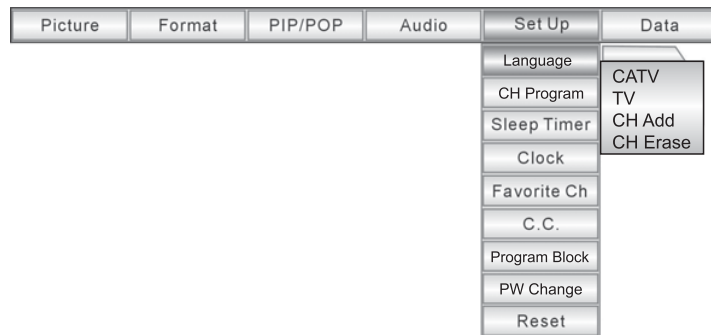
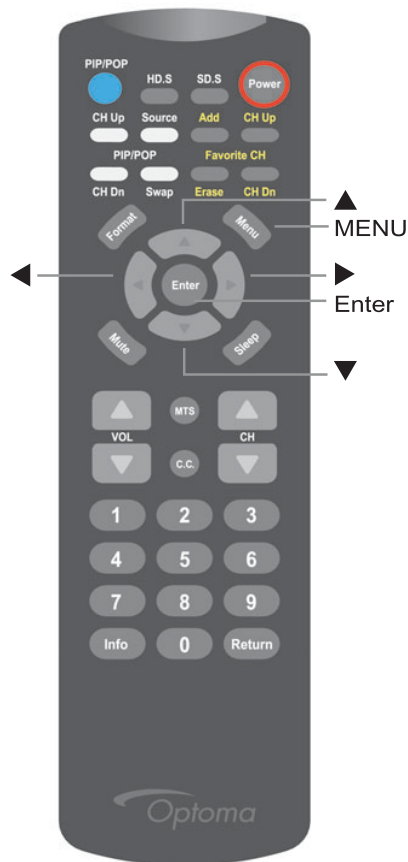

To manually add or erase a channel:

**Step 1**

Select the channel you want to add or **delete** by entering the channel number using the numeric **keypad** of your remote control.

**Step 2**

Press MENU to launch the onscreen display.

**Step 3**

Select SET UP using the ◀▶ buttons, then press ENTER.

**Step 4**

Select CH Program using the ▲▼ buttons, then press ENTER.

**Step 5**

Select CH Add or CH Erase using the ▲▼ buttons, then press ENTER.

**Step 6**

Press menu to exit. Your channel has now been added/erased into the channel lineup.

# Onscreen Display Menus

## Selecting the Language

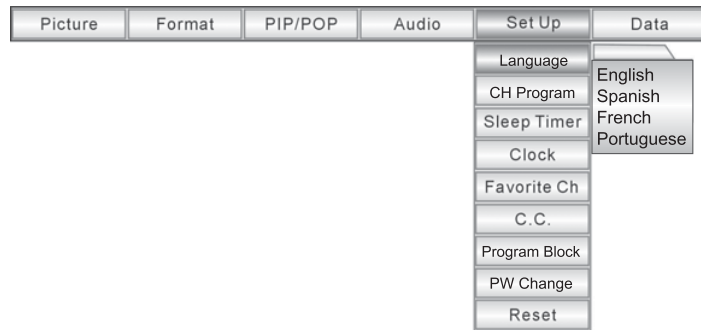
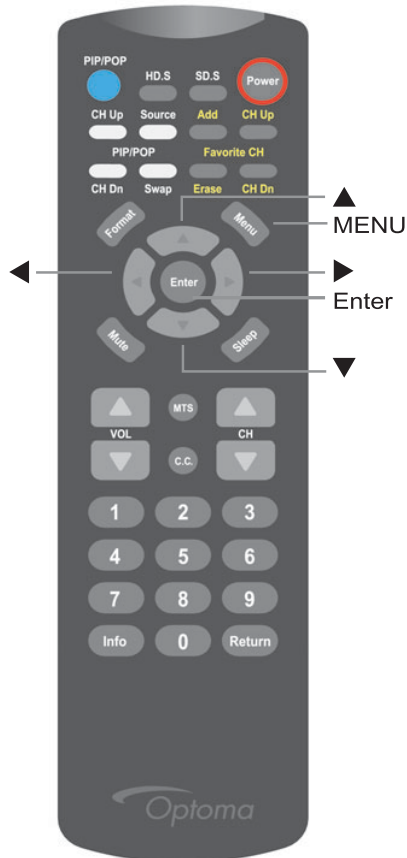

### Step 1

Press MENU to launch the onscreen display.

### Step 2

Select SET UP using the ◀▶ buttons, then press ENTER.

### Step 3

Using the ▲▼ buttons, select the desired language (English, Spanish, French or Portuguese), then press ENTER.

## Setting the Clock

The internal clock must be manually set by the user. (The internal clock must be reset whenever the display's main power source has been turned off or when the power cord has been disconnected from the power outlet.)

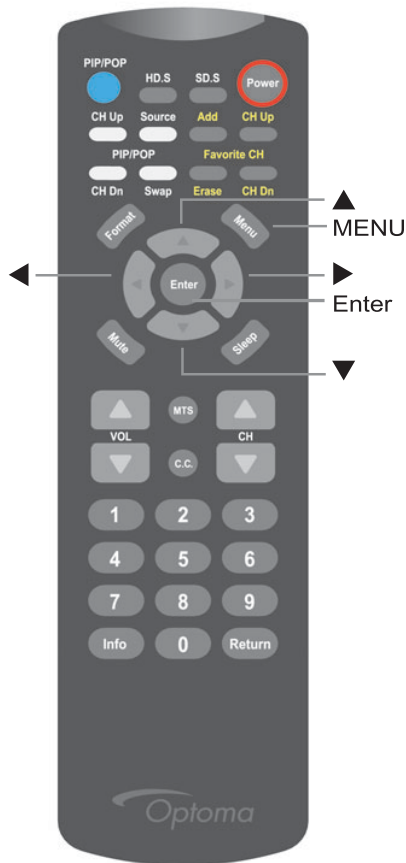

### Step 1

Press MENU to launch the onscreen display

### Step 2

Select SET UP using the ◀▶ buttons, then press ENTER.

### Step 3

Select CLOCK using the ▲▼ buttons, then press ENTER.

### Step 4

Use the ◀▶ buttons to select the Minute or Hour setting, then use the ▲▼ buttons to make adjustments. Press MENU to exit; the new time will be automatically applied.

# Onscreen Display Menus

## Setting the Sleep Timer

The sleep timer is used when you would like to have the display automatically turn itself off after a set period of time.

Set the sleep timer with the SLEEP button on your remote control. Press SLEEP until the desired length of time is displayed. You can select 10, , , or 120 minute sleep sessions. The TV will turn off automatically after the preset time.

If you want to disable SLEEP before the TV turns itself off, press SLEEP until the Off message is displayed on the screen.



Alternatively, the sleep timer can also be set using the OSD:

### Step 1

Press MENU to launch the onscreen display

### Step 2

Select SET UP using the ◀▶ buttons, then press ENTER.

### Step 3

Select SLEEP TIMER using the ▲▼ buttons, then press ENTER.

### Step 4

Select the length of time before the display turns off (Off, 10 min, 30 min, 60 min, 90 min, 120 min) using the ▲▼ buttons, then press ENTER button to start the timer clock.

If at any time you wish to know how much time remains on the sleep timer, press INFO and VOL ▲ on the remote control **simultaneously** and the amount of time remaining will be displayed on the screen.

## Setting Your Favorite Channels

If you routinely view the same set of channels, you can choose to save those channels in a list of favorite channels. You can then view these channels or scan through the programs on these channels directly by accessing the FAVORITE CH list. A total of 20 favorite channels can be selected.

To do so, simply use CH Up or CH Down to tune to your favorite channel, then press Favorite CH Add on your remote control.

Similarly you can delete channels you no longer watch frequently by pressing Favorite CH Erase.

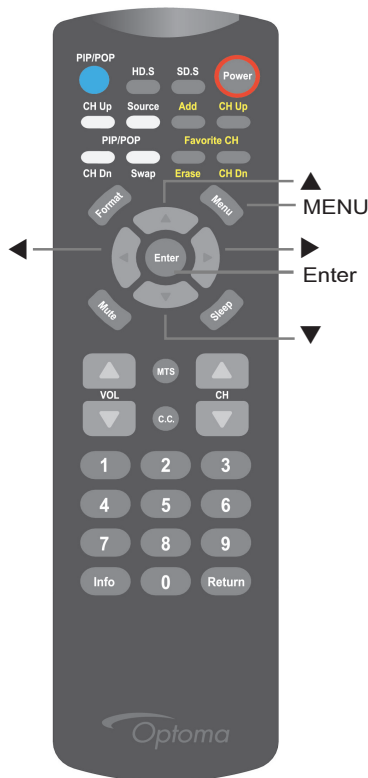

Picture	Format	PIP/POP	Audio	Set Up	Data
				Language	
				CH Program	
				Sleep Timer	
				Clock	
				Favorite Ch	ADD
				C.C.	ERASE
				Program Block	
				PW Change	
				Reset	

Alternatively, Favorite Channels can be added or deleted using the OSD:

### Step 1

While viewing the channel you wish to add to the FAVORITE CH list, press MENU to launch the onscreen display.

### Step 2

Select SET UP using the ◀▶ buttons, then press ENTER.

### Step 3

Select FAVORITE CH using the ▲▼ buttons, then press ENTER.

### Step 4

Select ADD/ERASE using the ▲▼ buttons, then press ENTER. The channel being viewed is then automatically added to or erased from the FAVORITE CH list.

### Notes:

- Up to 20 Favorite Channels can be stored; ten in ANT 1 and ten in ANT 2.
- If both ANT 1 and ANT 2 are connected to the same RF source, you can have 20 Favorite Channels in two groups.
- To see the list of current Favorite Channels, press INFO and VOL ▼ on the remote control simultaneously. If you attempt to add an 11th Favorite Channel to a list that already contains 10 Favorite Channels, the first channel in the list will be automatically replaced with the new favorite channel added.
- Once a channel has been successfully added to the Favorite Channels list, the message "Ch Added OK" will be displayed on the screen. Similarly, when a channel has been successfully deleted from the Favorite Channels list, the message "Ch Erased OK" will be displayed on the screen.

# Onscreen Display Menus

## Adjusting the Picture

You can adjust the picture to match different video sources you are watching. There are two preset options, Cinema and Normal. Select Cinema mode to optimize picture settings for a theater-like experience. Select Normal mode for everyday viewing.

You can also choose to manually define the picture settings to suit your personal preferences and then save those settings for future use under the setting names User1, User 2, or User3.

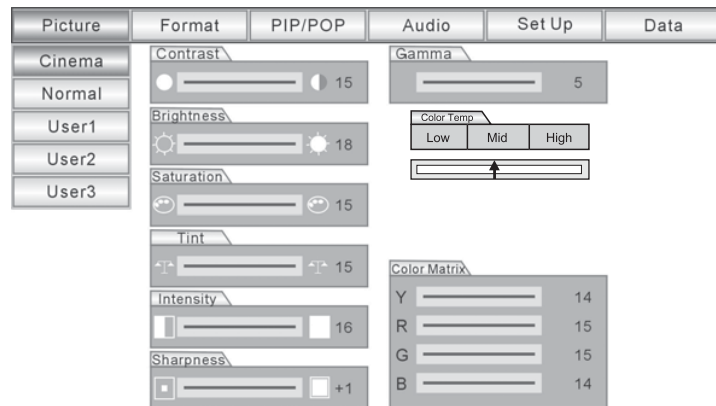
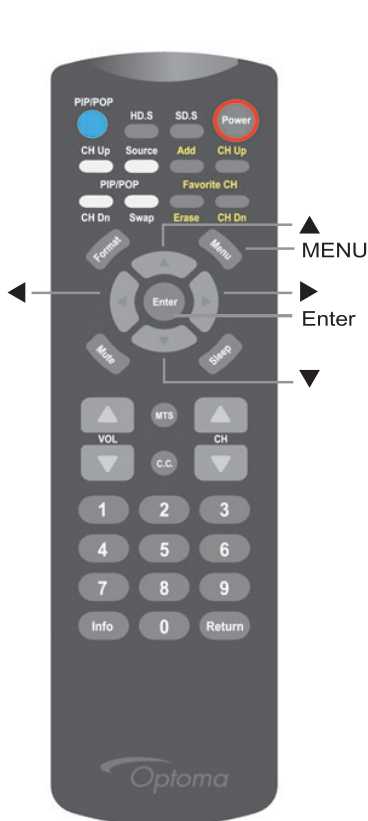

### Step 1

Press MENU to launch the onscreen display. Select PICTURE using the ▲▼ buttons, then press ENTER.

### Step 2

Using the ▲▼ buttons, select Cinema, Normal, User1, User2, or User3, then press ENTER.

### Step 3

(See Table 2 below for an explanation of each of the main picture components) Use the ▲▼ buttons to select various picture components, then use the ◀▶ buttons to adjust the value of a given component. Any adjustments you make will take immediate effect on the screen so that you can gauge how the onscreen image will look. When you have achieved the desired picture quality, simply press MENU to close the menu and to begin watching your program. All adjustments made will be automatically saved when you exit.

## Note

- User-defined adjustments can only be made to the User1, User2, and User3. You can view the picture settings for Cinema and Normal but cannot alter them.
- We recommend that the user save a picture quality setting that suits each type of program the user normally views. For example, define the User1 settings for DVD programs, the User2 settings for HDTV programs, and so on.

**Table 2: Picture Quality Components**

Component	Explanation	Adjustments		Value Range	
		◀	▶		
Contrast	Modifies the ratio between extremely bright and extremely dark images	Lower	Higher	0	+30
Brightness	Modifies the total brightness of all colors	Darker	Lighter	0	+30
Saturation	Modifies the color intensity	Weaker	Stronger	0	+30
Tint	Modifies the balance between red and green	Lower	Higher	0	+30
Intensity	Modifies the color level, contrast, and brightness all at once	Weaker	Stronger	0	+50
Sharpness	Modifies the sharpness of the edges of images	Softer	Sharper	0	+20
Gamma	Modifies the overall brightness and color ratio of an image	Lower	Higher	0	+10
Color Temperature	Modifies the color warmth of the picture	Lower	Higher	Low, Mid, High	
Color Matrix	Modifies Yellow, Red, Green, Blue colors individually	Lower	Higher	0	+30

## Displaying Different Picture Formats

Your display supports nine different picture formats. You can choose the picture format that is most suitable for the type of image you are viewing .

For example, if you are viewing a program that contains subtitles, you may wish to select the SUBTITLES picture format. Or, if you are watching a 2.35:1 feature film, you may wish to choose one of the WIDE formats if the source is non-anamorphic. If the source is anamorphically enhanced, you can choose Full or Full-L instead.

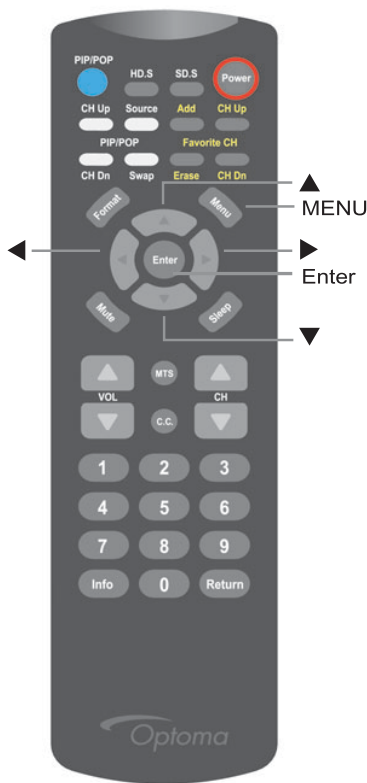

Picture	Format	PIP/POP	Audio	Set Up	Data
	4X3				
	Full				
	Full-L				
	Stretch				
	Subtitle				
	Wide1				
	Wide2				
	Wide3				
	Native				

### Step 1

Press the MENU button to launch the onscreen display

### Step 2

Select FORMAT using the ◀▶ buttons , then press ENTER.

### Step 3

Use the ▲▼ keys to select 4x3, Full, Full-L, Stretch, Subtitle, Wide1, Wide2, **Wide3**, or **Native**, then press ENTER. (See Table 3 below for description of each picture format). Any adjustments you make will take immediate effect Press MENU to close the menu and begin watching your **program**.

### Note

- You can also use FORMAT on the remote control to choose available picture formats.



Table 3: Description of Format Options

Format	Description
4x3	Enlarges NTSC and PAL picture signals to 960 x 720 and displays images in the center of the screen. Unused portions of the screen are masked.
Full	Enlarges picture to the size of the entire screen area (1280 x 720) Suitable for HDTV programs and 16x9 enhanced DVD programs. Digitally overscanning by 6% masks any non-displaying signals.
Full-L	Enlarges the picture 15% beyond the FULL format of 1280 x 720. Enlarges 2.35:1 (16x9 anamorphically enhanced DVDs) or HDTV signals to the larger 2.0:1 format.
Stretch	Stretches the sides of a normal 4 x 3 picture signal to the full width of the screen. Unaffected areas are masked.
Subtitle	Enlarges NTSC and PAL picture formats to the size of the entire screen area (1280 x 720), but nudges the picture slightly upwards to accommodate the subtitles display area.
Wide1	Converts the 1.66:1 format often used in Europe to full screen height. Suitable for non-16x9 sources compressed to 1.66:1 letterbox format.
Wide2	Converts the 1.85:1 format often used in North America to full screen height. Suitable for all sources except 16x9 enhanced DVDs.
Wide3	Displays feature films with a normal screen ratio of 2.35:1.
Native	Displays the picture at the TV's native resolution (1280 x 720) without digitally overscanning.

**Note:**

- When viewing HD1, HD2, PC1 and PC2, signals, only Native, 4x3, Full, and Full-L picture formats are available.
- Native mode displays video image without any digital overscan. This mode can display the more video details. However, occasionally some non-displaying signals may appear near the edges of the image as white lines or green lines. To avoid seeing these unwanted lines user can either use the Full mode or refer to Advanced Picture Adjustments on page 32 to move the image position and hence the unwanted lines off the screen.

## Onscreen Display Menus

It is possible to view two programs simultaneously using either the Picture-In-Picture function or Picture-Outside-Picture function.

### PIP

PIP allows the viewer to watch one program on the full screen, and another program on a smaller pop-up window, which can be placed in either of the four corners of the screen.

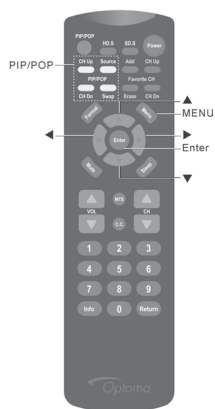

#### Starting PIP (Picture-In-Picture)

##### Step 1

Press MENU to launch the onscreen display

##### Step 2

Select PIP/POP using the ◀▶ buttons, then press ENTER.

##### Step 3

Select PIP using the ▲▼ buttons, then press ENTER.

##### Step 4

Select PIP POSITION using the ▲▼ buttons to choose the corner of the screen that you would like the smaller pop-up window to appear (UL=Upper Left, UR=Upper Right, LL=Lower Left, LR=Lower Right). (Refer to Table 4 below for more information.)

## Onscreen Display Menus

Table 4: PIP Illustration



UL (Upper Left)



UR (Upper Right)



LL (Lower Left)



LR (Lower Right)

#### Note

- Use Source on the remote control to select the source for the PIP windows.
- Press SWAP on the remote to switch the program in the small window to the main screen, and the program on the main screen to the small window.
- SWAP only switches the PIP main and sub screens It does not exchange left and right screens in POP mode.
- The PIP/POP functions are not available when viewing programs signals from HD1, HD2, PC1, or PC2.

## POP

The POP function divides the viewing area into two halves, allowing the simultaneous viewing of two programs in side-by-side windows.

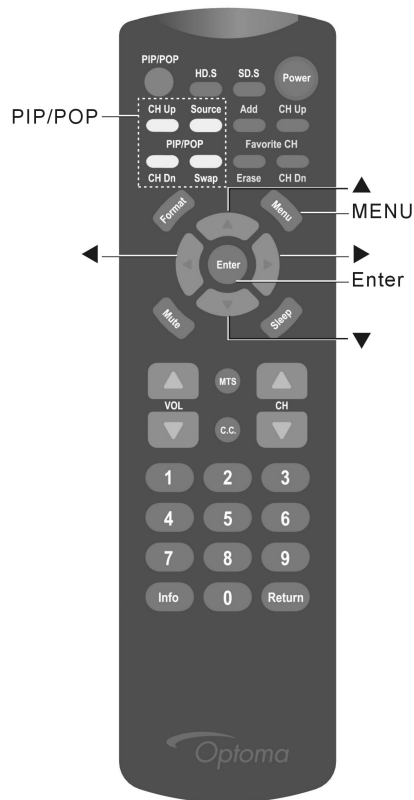

Picture	Format	PIP/POP	Audio	Set Up	Data	
		None	Size Ratio	Ch. Surf	Speaker	Earphone
		PIP	1	Off	L. Screen	L. Screen
		POP	2	On	R. Screen	R. Screen
			3			
			4			
			5			

### Step 1

Press MENU to launch the onscreen display

### Step 2

Select PIP/POP using the ◀▶ buttons, then press ENTER.

### Step 3

Select POP using the ▲▼ buttons, then press ENTER.

### Step 4

Select SIZE RATIO using the ◀▶ buttons, then use the ▲▼ buttons to choose the desired size of the new pop-up window. (See the Table 5 below for more information.)

### Step 5

Select SPEAKER/EARPHONE using the ◀▶ buttons, then use the ▲▼ buttons to choose which audio program to play on the speakers, and which to play on the earphones.

### Note:

- If the program block function is enabled, the source that is blocked will not have audio, video, or captions.

## Channel Surfing in POP Mode

You can automatically channel surf when viewing a program from ANT-1 or ANT-2 in POP mode. Select the CH Surf function on the OSD to on will display consecutive channels for three seconds each. To stop the surfing and continue viewing a channel, press either PIP/POP CH Up or PIP/POP CH Down.

Table 5: POP Size Ratio



### Note

- The main program window is on the right side of the screen. The sub window is on the left side of the screen.
- Press PIP/POP Source on the remote control to change the program source for the pop-up window.
- Press PIP/POP on the remote control to activate or deactivate the PIP/POP function.

## Advanced Picture Adjustments

The DATA menu features advanced picture adjustments that allow users to manually adjust the position of the image on the screen or to improve the quality of the program signal being viewed. (Such adjustments only apply to HD1, HD2, PC1, and PC2 programs)

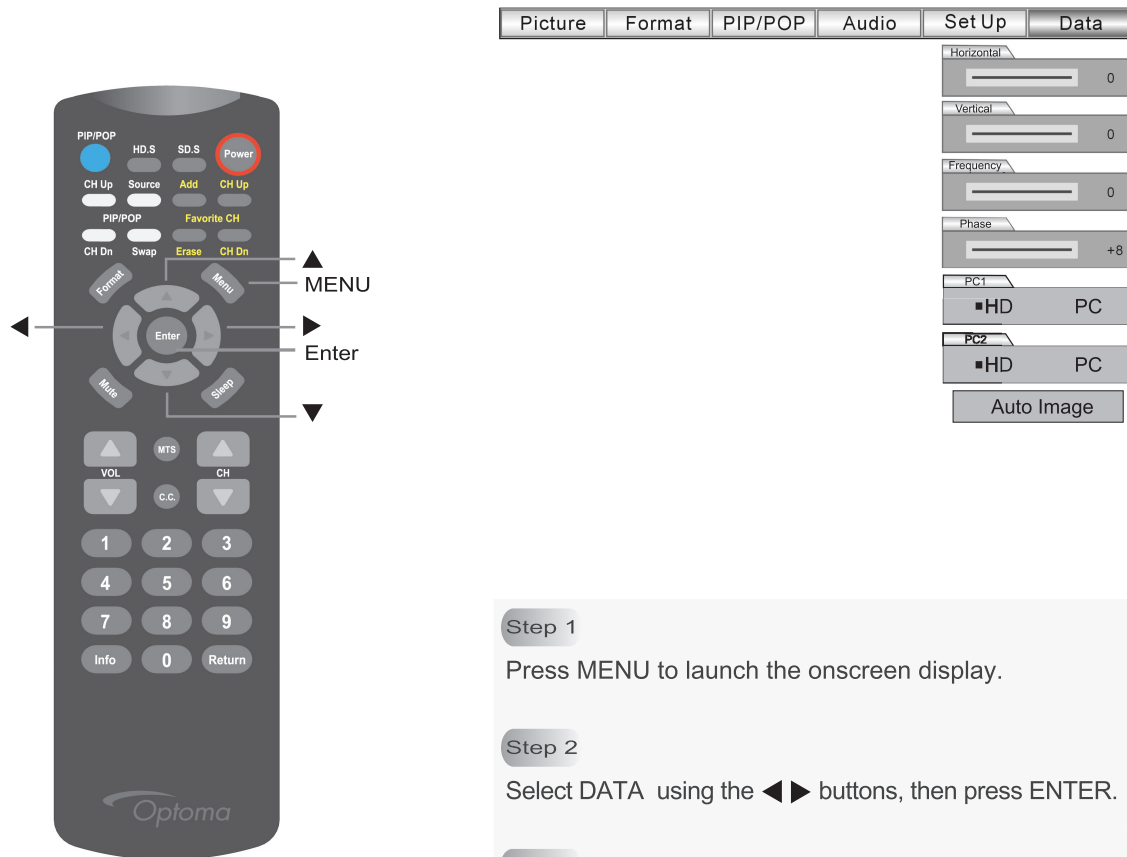

### Step 1

Press MENU to launch the onscreen display.

### Step 2

Select DATA using the ◀▶ buttons, then press ENTER.

### Step 3

**Select** the setting you wish to adjust using the ▲▼ buttons, then press ENTER.

### Step 4

**Adjust** the value of the item you **have** selected using the ◀▶ buttons. (See Table 6 for a **description** of advanced picture adjustment options).

### Step 5

Press MENU to exit and to begin watching your program.

### Note:

- These adjustments only apply to HD1, HD2, PC1, and PC2 programs.

Table 6: Description of Advanced Picture Adjustment Options

DATA Menu Option	Explanation	Adjustments	
		◀	▶
Horizontal	Moves the image position horizontally	Left	Right
Vertical	Moves the image position vertically	Up	Down
Frequency	Fine-tunes the horizontal frequency of the input signal	Lower	Higher
Phase	Fine-tunes the sampling phase of the input signal	Lower	Higher
Auto Image	Automatically re-adjusts the image on the screen		

## Viewing Closed Captions

Closed captions are data hidden within video signals that allow text information to be displayed on the screen for hearing impaired individuals and other reasons. RD50/65 can decode four standard closed captions and four text closed captions. Standard closed captions display text translations of the dialogue. Text closed captions displays scrolling text that is usually not related to the program.

To enable closed captions, press C.C. on your remote control, then select the mode you want.

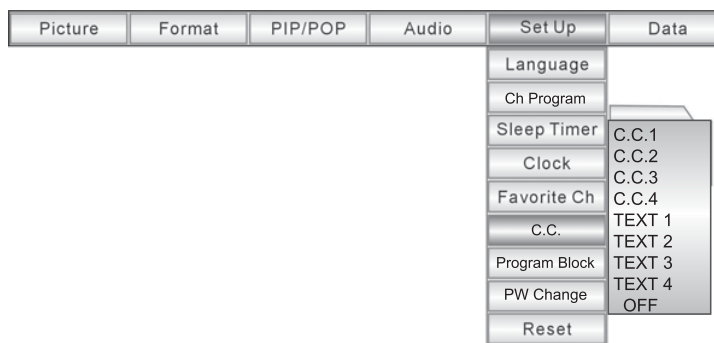
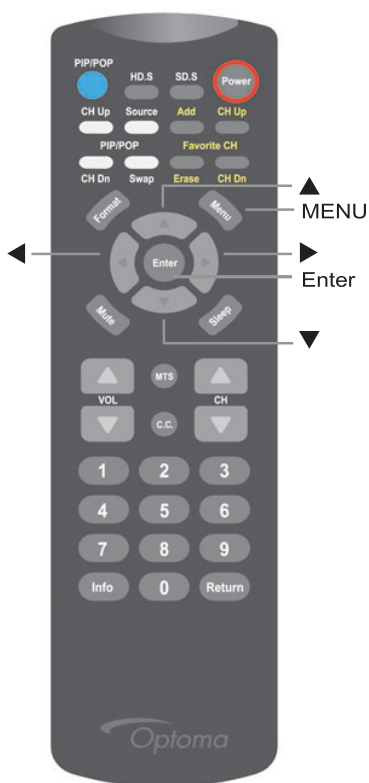

Alternatively, the closed captioning can be selected from the OSD:

### Step 1

Press MENU to launch the onscreen display.

### Step 2

Select SET UP using the ◀▶ buttons, then press ENTER.

### Step 3

**Select** C.C. using the ▲▼ buttons, then press ENTER.

### Step 4

To enable closed captions:

Use the ▲▼ buttons to select the desired the closed captioning format C.C.1, C.C.2, C.C.3, C.C.4, TEXT1, TEXT2, TEXT3, TEXT4, or OFF, then press ENTER .

To deactivate closed **captions**:

Use the ▲▼ buttons to **select** OFF, then press ENTER.

## Program Block

If you are concerned about children having access to coarse languages, violence or sexually explicit programs, you can block certain programs or channels from being viewed. You can accept or block programs with certain ratings, which are determined by the level of violent and/or sexual content. You only need to select the ratings you are willing to accept, and all programs will then be automatically filtered out according to the rating level you have selected. (Note: Please see Table 7 for a description of the various ratings)

Before selecting the Program Block function you need to setup a password first.

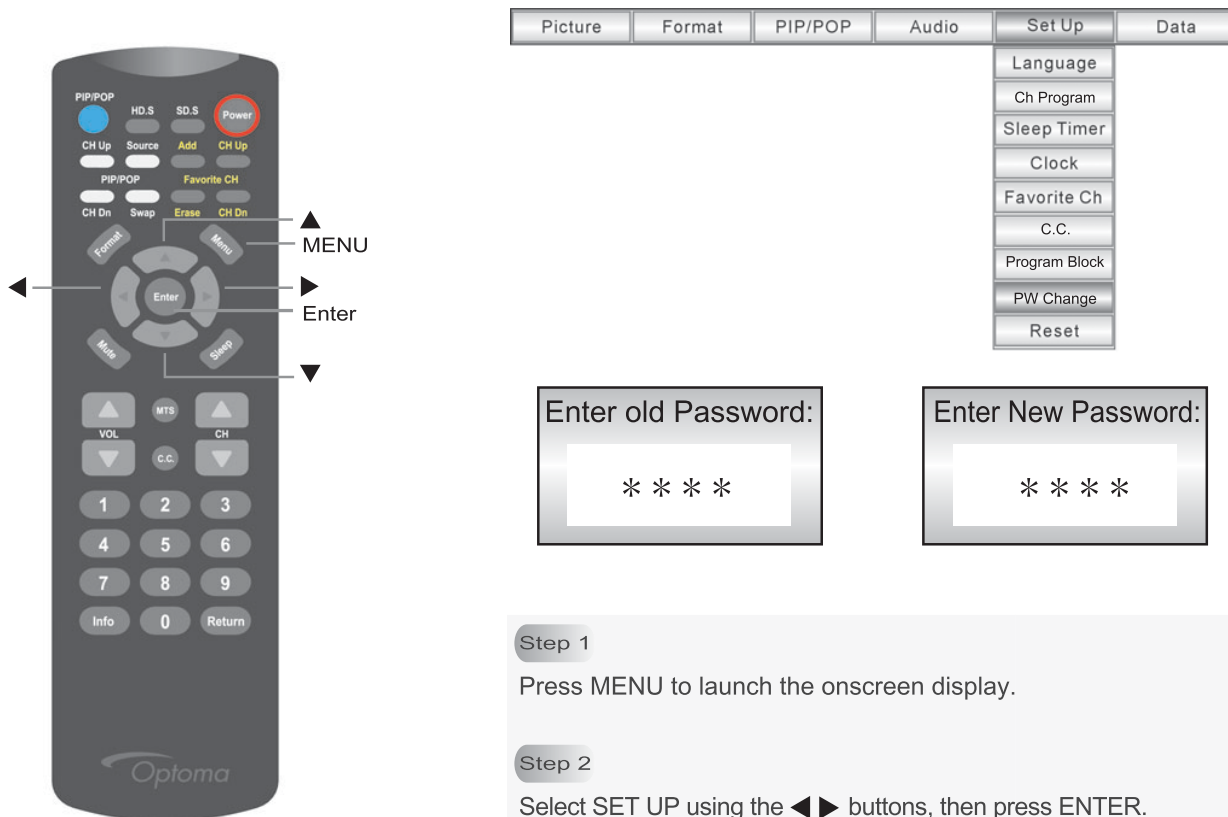

### Step 1

Press MENU to launch the onscreen display.

### Step 2

Select SET UP using the ◀▶ buttons, then press ENTER.

### Step 3

**Select** PW Change using the ▲▼ buttons, then press ENTER.

### Step 4

Enter a 4 digits numeric number as your password inside the Enter New Password window.

### Step 5

Press MENU to exit.



# Onscreen Display Menus

## To Select the Program Block Function

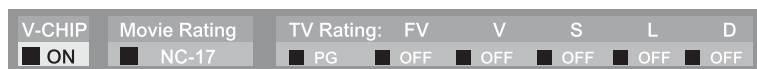
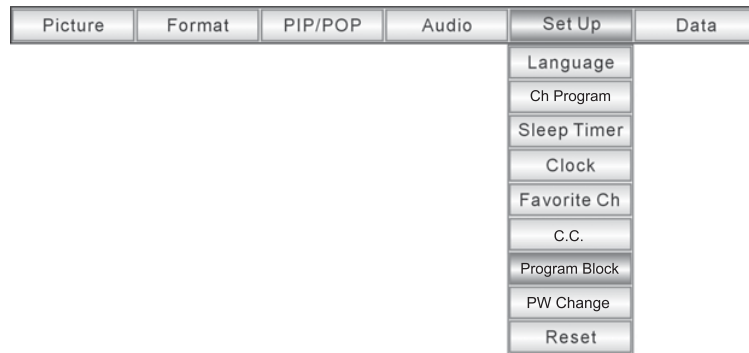
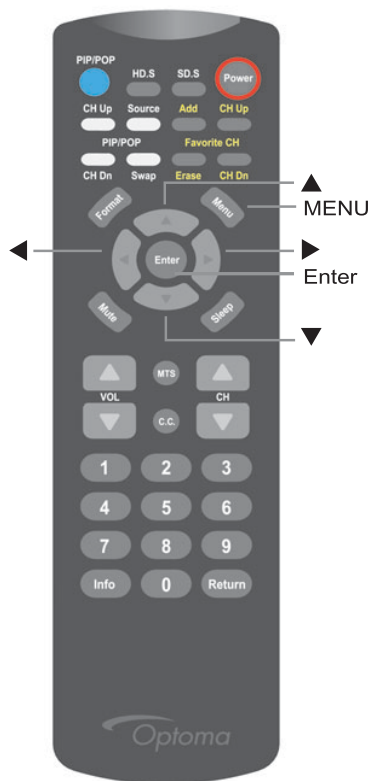

### Step 1

Press MENU to launch the onscreen display.

### Step 2

Select SET UP using the ◀▶ buttons, then press ENTER.

### Step 3

Select Program BLOCK using the ▲▼ buttons, then press ENTER. A window will pop up prompting you to enter your password. Enter the 4 digits numeric password you set previously to enter the Program BLOCK menu

### Step 4

Use the ▲▼ button to enable or disable this function  
Use the ◀▶ buttons to navigate to different rating and sub-rating option.  
Use the ▲▼ buttons to select MPAA Rating List, TV Rating List or any sub-rating available for that particular TV rating you wish to accept.

### Step 5

Press MENU to exit.

**Table 7: Description of Ratings Classifications**

**Note:** MPAA ratings apply to feature films, while TV ratings apply to television programs (except news and sports) and edited movies. Please note that TV Y and TV Y7 is a special rating for young children. You should set all three ratings MPAA, TV and TV-Y ratings according to your need.

MPAA Rating	Description	TV Rating	Description
G	General Audiences - All ages admitted	Y	All Children - This program is designed to be appropriate for all children
PG	Parental Guidance Suggested - Some material may not be suitable for children	Y7	Directed to Older Children - This program is designed for children age 7 and above
PG-13	Parents Strongly Cautioned - Some material may be inappropriate for children under 13	G	General Audience - Most parents would find this program suitable for all ages
R	Restricted - Under 17 requires accompanying parent or adult guardian	PG	Parental Guidance Suggested - This program contains material that parents may find unsuitable for younger children
NC-17	No one 17 and under admitted	TV-14	Parents Strongly Cautioned - This program contains some material that many parents would find unsuitable for children under 14 years of age
X	Restricted to adults only	MA	Mature Audience Only - This program is specifically designed to be viewed by adults and therefore may be unsuitable for children under 17

TV Parental Guides may have one or more letters added to the basic rating to let parents know when a show contains high levels of violence, sex, adult language or suggestive dialogue.

- V : Violence
- S : Sexual situations
- L : Coarse or crude indecent language
- D : Suggestive dialogue (sex related)
- FV : Fantasy violence

Source: MPAA (Motion Picture Association of America); TV Parental Guidelines

## Adjusting the Audio Settings

You can adjust the audio settings to suit the particular program being viewed. You can choose to listen to the audio program in stereo, in mono, in surround sound, or with the sound muted. The bass, treble, and audio balance can also be individually adjusted to your preference.

Similarly, the headphone volume can also be adjusted independently. The speaker volume setting has no effect on headphone volume setting.

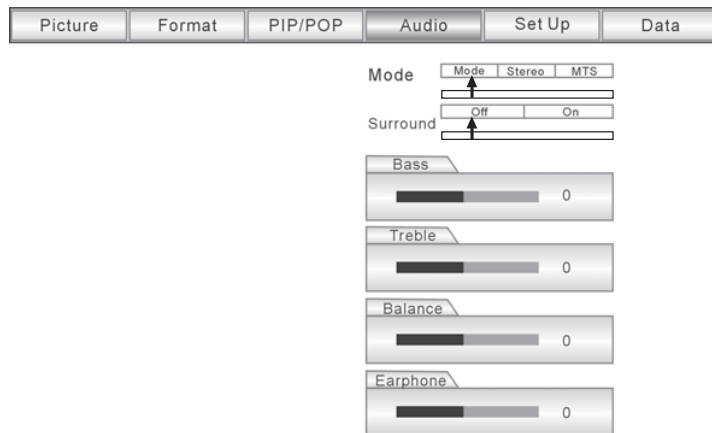
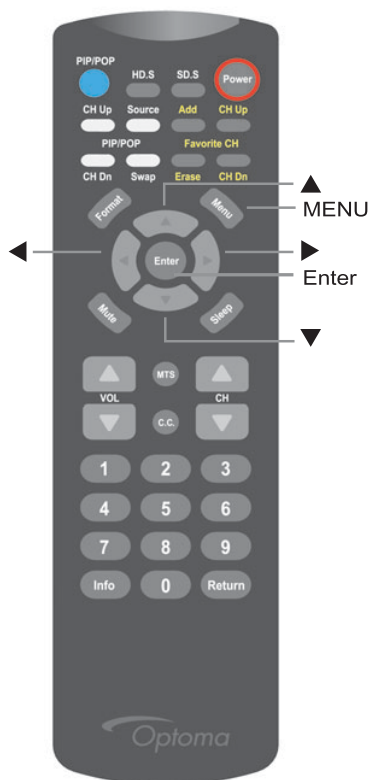

### Step 1

Press MENU to launch the onscreen display

### Step 2

Select AUDIO using the ◀▶ buttons, then press ENTER.

### Step 3

Using the ▲▼ buttons, select the audio component you wish to modify, then press ENTER. Use the ◀▶ buttons to make adjustments to the selected audio component. Any adjustments you make will take immediate effect so that you can hear the adjusted audio. To exit, press MENU. (NOTE: See Table 1 for more information on audio settings)

Table 1: Audio Settings Descriptions

Mono	Mono audio mode
Bass	Low-frequency sound adjustments
Stereo	Stereo audio mode
Treble	High-frequency sound adjustments
MTS	Multi Channel TV sound or SAP (Secondary Audio Program) selection.
Balance	Modifies the sound balance between the left and right speakers.
Surround	Surround Sound audio mode
Earphone	Adjusts the headphone volume.

## Warnings for replacing the internal lamp

1. Warning: Turn off the unit and unplug it before replacing the lamp.
2. Warning: Do not attempt to replace the lamp immediately after the display is turned off. The high temperature of the lamp could cause serious burns. Allow the lamp to cool down at least two hours after turning off the display before changing the lamp.
3. Warning: Do not remove the lamp except to replace it. Careless treatment can cause injury or fire.
4. Warning: When replacing the lamp, make sure that no screws or other foreign metal objects fall into the display's interior as such items may cause fire or electrical shock.
5. Warning: Do not touch the lamp element as it may break and cause serious burns or injuries.

## Lamp Change Instructions - RD50

For owners of the RD50, please follow the instructions below when replacing the internal lamp.

 For owners of the RD50, please follow the instructions below when replacing the internal lamp.

**1** Remove the front decorative cover

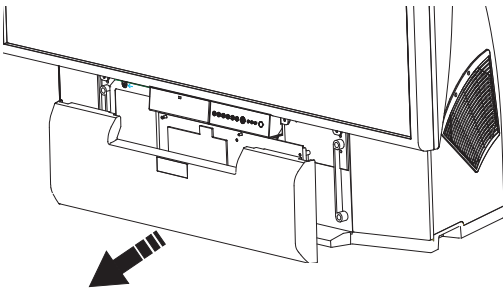

**2** Unscrew and remove the lamp module's protective cover.

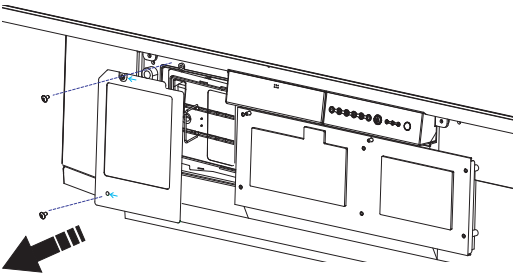

**3** Loosen the three screws on the lamp unit and pull the lamp module out. (Note: These screws may be loosened but cannot be removed from the unit.)

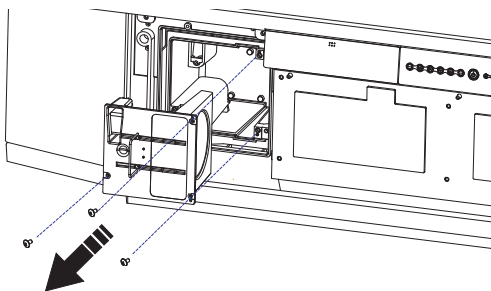

Loosen the three screws on the lamp unit and pull the lamp module out. (Note: These screws may be loosened but cannot be removed from the unit.)

**4**

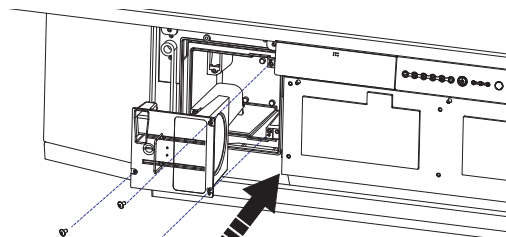

Replace the protective cover and tighten the screws.

**5**

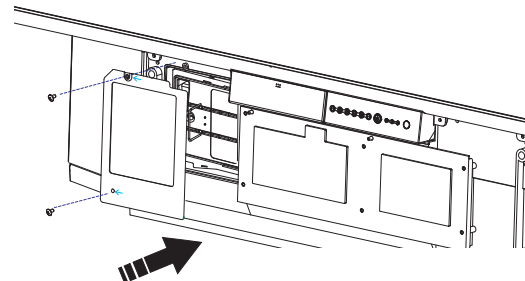

Replace the front decorative cover.

**6**

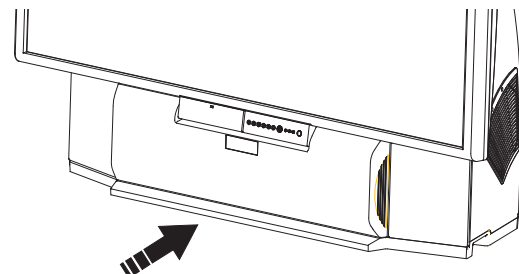

# Lamp Change Instructions - RD65

For owners of the RD65, please follow the instructions below when replacing the internal lamp.

 Please make sure that the power is properly turned off before continuing.

**1** Remove the speaker covers.

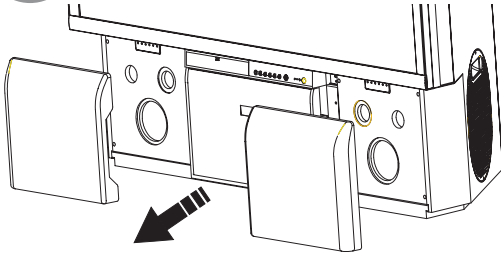

Place the new lamp into the original lamp slot. Once it is secure, tighten the three lamp unit screws.

**5**

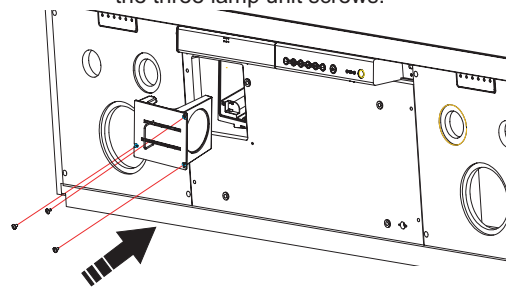

**2** Remove the decorative cover as indicated in the diagram.

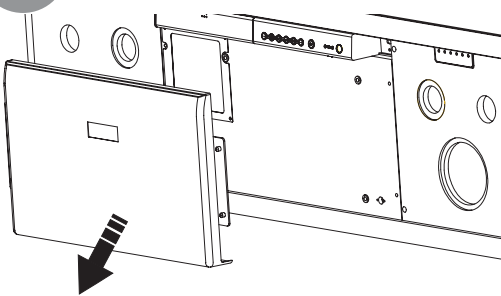

Replace the protective cover and tighten the four outer screws.

**6**

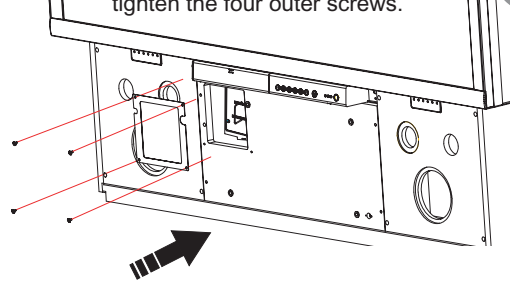

**3** Loosen and remove the four screws on the lamp module's protective cover.

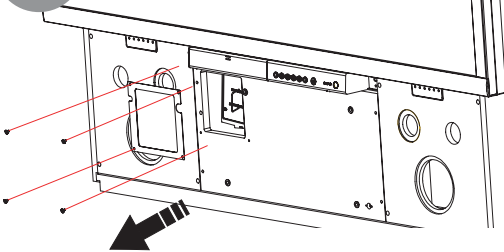

Replace the decorative cover.

**7**

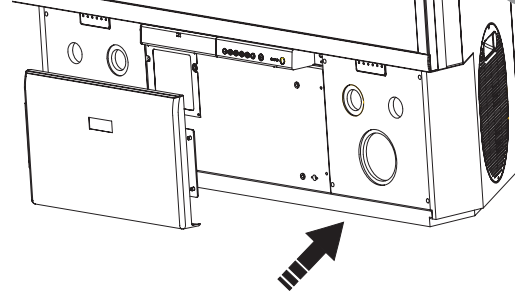

**4** Loosen the three screws on the lamp unit and pull the lamp unit out. (Note: These three screws may be loosened but cannot be removed from the unit.)

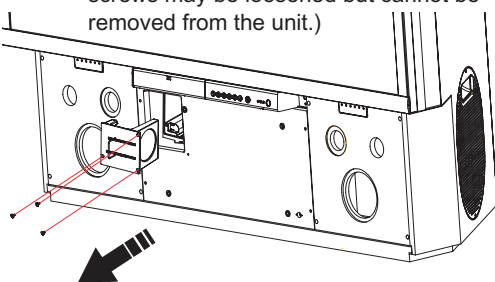

Replace the speaker covers.

**8**

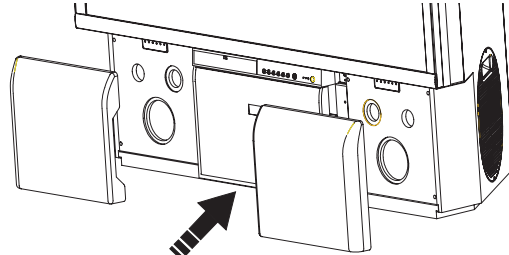

## Troubleshooting

Problem	Item to Check
No Power	<ul style="list-style-type: none"> <li>• Check that the power cord is properly connected.</li> <li>• Check that the main Power switch is in the on position</li> </ul>
Remote Control Not Working	<ul style="list-style-type: none"> <li>• Replace the batteries.</li> <li>• Check that the batteries are inserted correctly.</li> <li>• Check that the remote control is close enough to the display and that the angle at which the remote control is pointed at the display is sufficient for a signal to be detected by the display.</li> </ul>
Fuzzy Picture	<ul style="list-style-type: none"> <li>• Check that the device generating the picture signal is operating properly.</li> <li>• Check that you have set the display to receive the proper signal source.</li> </ul>
No Sound	<ul style="list-style-type: none"> <li>• Check to see if the Mute function is activated.</li> <li>• Check the Volume level.</li> <li>• Check that the device generating the audio signal is properly connected to the display.</li> </ul>
Picture is unstable and swaying	<ul style="list-style-type: none"> <li>• Check that your video card is set within the allowable range.</li> </ul>

The lights on the front of the Display provide another way to understand the status of the display.

LED	Light Status	Display Status
POWER	Stable red light	The display is standby.
	Flashing green light	The display is warming up.
	Stable green light	The display is operating normally.
	Flashing alternating red and green lights	Press the Power button on the remote control unit or on the display's front control panel to return to normal operating mode.
	Flashing red light	The display is cooling down.
	No lights	Power is off.
LAMP	Stable red light	There may be a problem with the internal lamp. Please contact the vendor where you purchased your display.
	Flashing red light	There may be an internal problem. Please contact the vendor where you purchased your display.

## RD50/65 Specifications Chart

Model Number		RD50	RD65
Item			
Display Technology		Single-panel 0.8-inch HD-2 Digital Light Processing technology from Texas Instruments	
Resolution		1280 x 720	
Support HD resolution		480p,1080i,720p	
Power		AC 100~240V 50/60Hz,4.5A	
Dimensions (W x H x D)		46 x 35.5 x 14.8 inches (117 x 90 x 38 cm)	59.5 x 51.7 x 22 inches (151 x 131 x 56 cm)
Weight		99.2 pounds (45 kg)	224.7 pounds (102 kg)
Video System		NTSC	NTSC
Input / Output Connectors	Back panel	Input: S-Video/Video + Audio L/R (x2) 480i YPbPr + Audio L/R (x1) YPbPr/RGBHV (BNC type) (x1) YPbPr/RGBHV (RCA type) (x1) DVI + PC Audio (x1) ANT (UHF/VHF/Cable TV) (x2) Output: Video + Audio L/R (x1)	
	Front panel	Input: S-video/Video + Audio L/R (x1) VGA + PC audio (x1) Output: Earphone (RCA jack) (x1)	
Audio System		One pair of internal 15-watt stereo speakers.	One pair of internal 15-watt stereo speakers.

## Free Manuals Download Website

<http://myh66.com>

<http://usermanuals.us>

<http://www.somanuals.com>

<http://www.4manuals.cc>

<http://www.manual-lib.com>

<http://www.404manual.com>

<http://www.luxmanual.com>

<http://aubethermostatmanual.com>

Golf course search by state

<http://golfingnear.com>

Email search by domain

<http://emailbydomain.com>

Auto manuals search

<http://auto.somanuals.com>

TV manuals search

<http://tv.somanuals.com>